

## FCC Test Report

**Report No.:** RF150414C33-1

**FCC ID:** TVE-23155011

**Test Model:** FAP-S321CR, FAP-S323CR

**Series Model:** FortiAP-S321CRxxxxxx, FAP-S321CRxxxxxx, FORTIAP-S321CRxxxxxx, FortiAP-S323CRxxxxxx, FAP-S323CRxxxxxx, FORTIAP-S323CRxxxxxx (where "x" can be used as "A-Z", or "0-9", or "-", or blank for software changes or marketing purposes only)

**Received Date:** Apr. 29, 2015

**Test Date:** Apr. 29 ~ May 30, 2015

**Issued Date:** Jun. 11, 2015

**Applicant:** Fortinet Inc.

**Address:** 899 Kifer Road Sunnyvale, CA 94086 USA

**Issued By:** Bureau Veritas Consumer Products Services (H.K.) Ltd., Taoyuan Branch

**Lab Address:** No. 47-2, 14th Ling, Chia Pau Vil., Lin Kou Dist., New Taipei City, Taiwan

**Test Location:** No. 19, Hwa Ya 2nd Rd., Wen Hwa Vil., Kwei Shan Dist., Taoyuan City 33383, TAIWAN (R.O.C.)



This report is for your exclusive use. Any copying or replication of this report to or for any other person or entity, or use of our name or trademark, is permitted only with our prior written permission. This report sets forth our findings solely with respect to the test samples identified herein. The results set forth in this report are not indicative or representative of the quality or characteristics of the lot from which a test sample was taken or any similar or identical product unless specifically and expressly noted. Our report includes all of the tests requested by you and the results thereof based upon the information that you provided to us. You have 60 days from date of issuance of this report to notify us of any material error or omission caused by our negligence, provided, however, that such notice shall be in writing and shall specifically address the issue you wish to raise. A failure to raise such issue within the prescribed time shall constitute your unqualified acceptance of the completeness of this report, the tests conducted and the correctness of the report contents. Unless specific mention, the uncertainty of measurement has been explicitly taken into account to declare the compliance or non-compliance to the specification. The report must not be used by the client to claim product certification, approval, or endorsement by TAF or any government agencies.

## Table of Contents

<b>Release Control Record</b> .....	<b>4</b>
<b>1 Certificate of Conformity</b> .....	<b>5</b>
<b>2 Summary of Test Results</b> .....	<b>6</b>
2.1 Measurement Uncertainty .....	6
2.2 Modification Record .....	6
<b>3 General Information</b> .....	<b>7</b>
3.1 General Description of EUT .....	7
3.2 Description of Test Modes .....	9
3.2.1 Test Mode Applicability and Tested Channel Detail.....	10
3.3 Duty Cycle of Test Signal .....	12
3.4 Description of Support Units .....	13
3.4.1 Configuration of System under Test .....	14
3.5 General Description of Applied Standard.....	15
<b>4 Test Types and Results</b> .....	<b>16</b>
4.1 Radiated Emission and Bandedge Measurement.....	16
4.1.1 Limits of Radiated Emission and Bandedge Measurement .....	16
4.1.2 Test Instruments .....	17
4.1.3 Test Procedure .....	18
4.1.4 Deviation from Test Standard .....	18
4.1.5 Test Setup.....	19
4.1.6 EUT Operating Conditions.....	19
4.1.7 Test Results .....	20
4.2 Conducted Emission Measurement .....	60
4.2.1 Limits of Conducted Emission Measurement .....	60
4.2.2 Test Instruments .....	60
4.2.3 Test Procedure .....	61
4.2.4 Deviation from Test Standard .....	61
4.2.5 Test Setup.....	61
4.2.6 EUT Operating Conditions.....	61
4.2.7 Test Results .....	62
4.3 Transmit Power Measurement .....	70
4.3.1 Limits of Transmit Power Measurement .....	70
4.3.2 Test Setup.....	70
4.3.3 Test Instruments .....	70
4.3.4 Test Procedure .....	71
4.3.5 Deviation from Test Standard .....	71
4.3.6 EUT Operating Conditions.....	71
4.3.7 Test Result.....	72
4.4 Peak Power Spectral Density Measurement .....	78
4.4.1 Limits of Peak Power Spectral Density Measurement .....	78
4.4.2 Test Setup.....	78
4.4.3 Test Instruments .....	78
4.4.4 Test Procedure .....	78
4.4.5 Deviation from Test Standard .....	79
4.4.6 EUT Operating Condition .....	79
4.4.7 Test Results .....	80
4.5 Frequency Stability.....	86
4.5.1 Limits of Frequency Stability Measurement .....	86
4.5.2 Test Setup.....	86
4.5.3 Test Instruments .....	86
4.5.4 Test Procedure .....	86
4.5.5 Deviation from Test Standard .....	86
4.5.6 EUT Operating Condition .....	86



4.5.7 Test Results .....	87
4.6 6dB Bandwidth Measurement.....	88
4.6.1 Limits of 6dB Bandwidth Measurement.....	88
4.6.2 Test Setup.....	88
4.6.3 Test Instruments .....	88
4.6.4 Test Procedure .....	88
4.6.5 Deviation from Test Standard .....	88
4.6.6 EUT Operating Condition .....	88
4.6.7 Test Results .....	89
<b>5 Pictures of Test Arrangements.....</b>	<b>91</b>
<b>Appendix – Information on the Testing Laboratories .....</b>	<b>92</b>



A D T

### Release Control Record

Issue No.	Description	Date Issued
RF150414C33-1	Original release.	Jun. 11, 2015

## 1 Certificate of Conformity

**Product:** Secured Wireless Access Point

**Brand:** Fortinet Inc.

**Test Model:** FAP-S321CR, FAP-S323CR

**Series Model:** FortiAP-S321CRxxxxxx, FAP-S321CRxxxxxx, FORTIAP-S321CRxxxxxx, FortiAP-S323CRxxxxxx, FAP-S323CRxxxxxx, FORTIAP-S323CRxxxxxx (where "x" can be used as "A-Z", or "0-9", or "-", or blank for software changes or marketing purposes only)

**Sample Status:** Engineering sample

**Applicant:** Fortinet Inc.

**Test Date:** Apr. 29 ~ May 30, 2015

**Standard:** 47 CFR FCC Part 15, Subpart E (Section 15.407)  
ANSI C63.10:2009

The above equipment has been tested by **Bureau Veritas Consumer Products Services (H.K.) Ltd., Taoyuan Branch**, and found compliance with the requirement of the above standards. The test record, data evaluation & Equipment Under Test (EUT) configurations represented herein are true and accurate accounts of the measurements of the sample's EMC characteristics under the Conditions specified in this report.

**Prepared by :**  , **Date:** Jun. 11, 2015  
Pettie Chen / Senior Specialist

**Approved by :**  , **Date:** Jun. 11, 2015  
Ken Liu / Senior Manager

## 2 Summary of Test Results

47 CFR FCC Part 15, Subpart E (SECTION 15.407)			
FCC Clause	Test Item	Result	Remarks
15.407(b)(6)	AC Power Conducted Emissions	PASS	Meet the requirement of limit. Minimum passing margin is -3.91dB at 0.15000MHz.
15.407(b) (1/2/3/4/6)	Radiated Emissions & Band Edge Measurement	PASS	Meet the requirement of limit. Minimum passing margin is -1.0dB at 5150.00, 5714.00, 11650.00MHz.
15.407(a)(1/2 /3)	Max Average Transmit Power	PASS	Meet the requirement of limit.
15.407(a)(1/2 /3)	Peak Power Spectral Density	PASS	Meet the requirement of limit.
15.407(e)	6dB bandwidth	PASS	Meet the requirement of limit. (U-NII-3 Band only)
15.407(g)	Frequency Stability	PASS	Meet the requirement of limit.
15.203	Antenna Requirement	PASS	Printed Antenna: Antenna connector is I-PEX not a standard connector. Dipole Antenna: Antenna connector is SMA jack RP not a standard connector.

### 2.1 Measurement Uncertainty

Where relevant, the following measurement uncertainty levels have been estimated for tests performed on the EUT as specified in CISPR 16-4-2:

Measurement	Frequency	Expanded Uncertainty (k=2) (±)
Conducted Emissions at mains ports	150kHz ~ 30MHz	2.44 dB
Radiated Emissions up to 1 GHz	30MHz ~ 200MHz	3.86 dB
	200MHz ~ 1000MHz	3.87 dB
Radiated Emissions above 1 GHz	1GHz ~ 18GHz	2.29 dB
	18GHz ~ 40GHz	2.29 dB

### 2.2 Modification Record

There were no modifications required for compliance.

### 3 General Information

#### 3.1 General Description of EUT

Product	Secured Wireless Access Point
Brand	Fortinet Inc.
Test Model	FAP-S321CR, FAP-S323CR
Series Model	FortiAP-S321CRxxxxxx, FAP-S321CRxxxxxx, FORTIAP-S321CRxxxxxx, FortiAP-S323CRxxxxxx, FAP-S323CRxxxxxx, FORTIAP-S323CRxxxxxx (where "x" can be used as "A-Z", or "0-9", or "-", or blank for software changes or marketing purposes only)
Status of EUT	Engineering sample
Power Supply Rating	12Vdc from adapter 48Vdc from PoE
Modulation Type	256QAM, 64QAM, 16QAM, QPSK, BPSK
Modulation Technology	OFDM
Transfer Rate	802.11a: 54.0/ 48.0/ 36.0/ 24.0/ 18.0/ 12.0/ 9.0/ 6.0Mbps 802.11n: up to 450.0Mbps 802.11ac: up to 1300Mbps
Operating Frequency	5180 ~ 5240MHz & 5745 ~ 5825MHz
Number of Channel	5180 ~ 5240MHz: 4 for 802.11a, 802.11n (HT20), 802.11ac (VHT20) 2 for 802.11n (HT40), 802.11ac (VHT40) 1 for 802.11ac (VHT80) 5745 ~ 5825MHz: 5 for 802.11a, 802.11n (HT20), 802.11ac (VHT20) 2 for 802.11n (HT40), 802.11ac (VHT40) 1 for 802.11ac (VHT80)
Output Power	5180 ~ 5240MHz: 386.958mW 5745 ~ 5825MHz: 398.106mW
Antenna Type	Refer to Note
Antenna Connector	Refer to Note
Accessory Device	NA
Data Cable Supplied	NA

**Note:**

1. All models are listed as below. All models are hardware, software, electrically identical, different model names are for different antennas.

Brand	Model	Difference	
Fortinet Inc.	FortiAP-S321CRxxxxxx	"x" can be used as "A-Z", or "0-9", or "-", or blank for software changes or marketing purposes only	With Internal Antenna
	FAP-S321CRxxxxxx (Main test model: FAP-S321CR)		
	FORTIAP-S321CRxxxxxx		
	FortiAP-S323CRxxxxxx	With External Antenna	
	FAP-S323CRxxxxxx (Main test model: FAP-S323CR)		
	FORTIAP-S323CRxxxxxx		

2. The EUT incorporates a MIMO function. Physically, the EUT provides 3 completed transmitters and 3 receivers.

Modulation Mode	TX Function
802.11a	3TX
802.11n (HT20)	3TX
802.11n (HT40)	3TX
802.11ac (VHT20)	3TX
802.11ac (VHT40)	3TX
802.11ac (VHT80)	3TX

\* The EUT doesn't support diversity function.

\* The modulation and bandwidth are similar between 802.11n mode for HT20 / HT40 and 802.11ac mode for VHT20 / VHT40, and therefore investigated worst case to representative mode in test report. (Final test mode refer section 3.2.1)

3. The EUT consumes power from the following adapter and PoE (provided as support units only).

Adapter	
Brand	Powertron Electronics Corp.
Model	PA1024-2HUB PA1024-2HU PA1024-120HUB200
Input Power	100-240Vac, 50-60Hz, 0.6A
Output Power	12Vdc, 2.0A, 24W Max
Power Line	DC 1.5m power cable with 1 core attached on adapter

PoE	
Brand	EnGenius
Model	EPE-48GR
Rating	48Vdc, 0.8A

Adapter of PoE	
Brand	Powertron Electronics Corp.
Model	PA1040-480IB080
Input Power	100-240Vac, 50-60Hz 1.5A
Output Power	48Vdc, 0.8A, 38.4W Max
Power Line	DC 1.55m power cable with 1 core attached on adapter



4. The following antennas were provided to the EUT.

No.	Type	Gain(dBi)		Connector
		2.4GHz Band	5GHz Band	
1	Printed	Ant. 1: 3.51dBi	Ant. 4: 6.48dBi	IPEX
		Ant. 2: 2.99dBi	Ant. 5: 5.20dBi	
		Ant. 3: 3.21dBi	Ant. 6: 5.66dBi	
2	Dipole	4dBi	6dBi	SMA jack RP

5. The above EUT information is declared by manufacturer and for more detailed features description, please refer to the manufacturer's specifications or user's manual.

### 3.2 Description of Test Modes

#### FOR 5180 ~ 5240MHz

4 channels are provided for 802.11a, 802.11n (HT20), 802.11ac (VHT20):

Channel	Frequency	Channel	Frequency
36	5180 MHz	44	5220 MHz
40	5200 MHz	48	5240 MHz

2 channels are provided for 802.11n (HT40), 802.11ac (40MHz):

Channel	Frequency	Channel	Frequency
38	5190 MHz	46	5230 MHz

1 channel is provided for 802.11ac (VHT80):

Channel	Frequency
42	5210MHz

#### FOR 5745 ~ 5825MHz:

5 channels are provided for 802.11a, 802.11n (HT20), 802.11ac (VHT20):

Channel	Frequency	Channel	Frequency
149	5745MHz	161	5805MHz
153	5765MHz	165	5825MHz
157	5785MHz		

2 channels are provided for 802.11n (HT40), 802.11ac (VHT40):

Channel	Frequency	Channel	Frequency
151	5755MHz	159	5795MHz

1 channel is provided for 802.11ac (VHT80):

Channel	Frequency
155	5775MHz

### 3.2.1 Test Mode Applicability and Tested Channel Detail

EUT CONFIGURE MODE	APPLICABLE TO				DESCRIPTION	
	RE $\geq$ 1G	RE $<$ 1G	PLC	APCM	EUT Antenna	Power Supply
A	√	√	√	√	Internal antenna	Power form PoE
B	-	√	√	-		Power from adapter
C	√	√	√	-	External antenna	Power form PoE
D	-	√	√	-		Power from adapter

Where **RE $\geq$ 1G**: Radiated Emission above 1GHz      **RE $<$ 1G**: Radiated Emission below 1GHz  
**PLC**: Power Line Conducted Emission      **APCM**: Antenna Port Conducted Measurement

Note: 1. The EUT had been pre-tested on the positioned of each 3 axis. The worst case was found when positioned on **Y-plane** for mode A & B while on **X-plane** for mode C & D.  
2. "-" means no effect.

#### **Radiated Emission Test (Above 1GHz):**

- Pre-Scan has been conducted to determine the worst-case mode from all possible combinations between available modulations, data rates and antenna ports (if EUT with antenna diversity architecture).
- Following channel(s) was (were) selected for the final test as listed below.

EUT CONFIGURE MODE	MODE	FREQ. BAND (MHz)	AVAILABLE CHANNEL	TESTED CHANNEL	MODULATION TECHNOLOGY	MODULATION TYPE	DATA RATE (Mbps)
A, C	802.11a	5180-5240	36 to 48	36, 40, 48	OFDM	BPSK	6.0
A, C	802.11n (HT20)		36 to 48	36, 40, 48	OFDM	BPSK	6.5
A, C	802.11n (HT40)		38 to 46	38, 46	OFDM	BPSK	15.0
A, C	802.11ac (VHT80)		42	42	OFDM	BPSK	97.5
A, C	802.11a	5745-5825	149 to 165	149, 157, 165	OFDM	BPSK	6.0
A, C	802.11n (HT20)		149 to 165	149, 157, 165	OFDM	BPSK	6.5
A, C	802.11n (HT40)		151 to 159	151, 159	OFDM	BPSK	15.0
A, C	802.11ac (VHT80)		155	155	OFDM	BPSK	97.5

#### **Radiated Emission Test (Below 1GHz):**

- Pre-Scan has been conducted to determine the worst-case mode from all possible combinations between available modulations, data rates and antenna ports (if EUT with antenna diversity architecture).
- Following channel(s) was (were) selected for the final test as listed below.

EUT CONFIGURE MODE	MODE	FREQ. BAND (MHz)	AVAILABLE CHANNEL	TESTED CHANNEL	MODULATION TECHNOLOGY	MODULATION TYPE	DATA RATE (Mbps)
A, B, C, D	802.11a	5180-5320 5745-5825	36 to 64 149 to 165	157	OFDM	BPSK	6.0

**Power Line Conducted Emission Test:**

- Pre-Scan has been conducted to determine the worst-case mode from all possible combinations between available modulations, data rates and antenna ports (if EUT with antenna diversity architecture).
- Following channel(s) was (were) selected for the final test as listed below.

EUT CONFIGURE MODE	MODE	FREQ. BAND (MHz)	AVAILABLE CHANNEL	TESTED CHANNEL	MODULATION TECHNOLOGY	MODULATION TYPE	DATA RATE (Mbps)
A, B, C, D	802.11a	5180-5320 5745-5825	36 to 64 149 to 165	157	OFDM	BPSK	6.0

**Antenna Port Conducted Measurement:**

- This item includes all test value of each mode, but only includes spectrum plot of worst value of each mode.
- Pre-Scan has been conducted to determine the worst-case mode from all possible combinations between available modulations, data rates and antenna ports (if EUT with antenna diversity architecture).
- Following channel(s) was (were) selected for the final test as listed below.

EUT CONFIGURE MODE	MODE	FREQ. BAND (MHz)	AVAILABLE CHANNEL	TESTED CHANNEL	MODULATION TECHNOLOGY	MODULATION TYPE	DATA RATE (Mbps)
A	802.11a	5180-5240	36 to 48	36, 40, 48	OFDM	BPSK	6.0
A	802.11n (HT20)		36 to 48	36, 40, 48	OFDM	BPSK	6.5
A	802.11n (HT40)		38 to 46	38, 46	OFDM	BPSK	15.0
A	802.11ac (VHT80)		42	42	OFDM	BPSK	97.5
A	802.11a	5745-5825	149 to 165	149, 157, 165	OFDM	BPSK	6.0
A	802.11n (HT20)		149 to 165	149, 157, 165	OFDM	BPSK	6.5
A	802.11n (HT40)		151 to 159	151, 159	OFDM	BPSK	15.0
A	802.11ac (VHT80)		155	155	OFDM	BPSK	97.5

**Test Condition:**

APPLICABLE TO	ENVIRONMENTAL CONDITIONS	INPUT POWER	TESTED BY
RE $\geq$ 1G	18deg. C, 70%RH	48Vdc	Nick Hsu
RE $<$ 1G	20deg. C, 70%RH 19deg. C, 68%RH	48Vdc 120Vac, 60Hz	Jones Chang
PLC	20deg. C, 70%RH 19deg. C, 68%RH	48Vdc 120Vac, 60Hz	Jones Chang
APCM	25deg. C, 60%RH	48Vdc	Nick Chen

### 3.3 Duty Cycle of Test Signal

Duty cycle of test signal is < 98%, duty factor shall be considered.

**802.11a:** Duty cycle =  $2.02/2.105 = 0.96$ , Duty factor =  $10 * \log(1/0.96) = 0.18$

**802.11n (HT20):** Duty cycle =  $1.867/2.057 = 0.908$ , Duty factor =  $10 * \log(1/0.908) = 0.42$

**802.11n (HT40):** Duty cycle =  $0.915/0.99 = 0.924$ , Duty factor =  $10 * \log(1/0.924) = 0.34$

**802.11ac (VHT80):** Duty cycle =  $0.45/0.54 = 0.833$ , Duty factor =  $10 * \log(1/0.833) = 0.79$

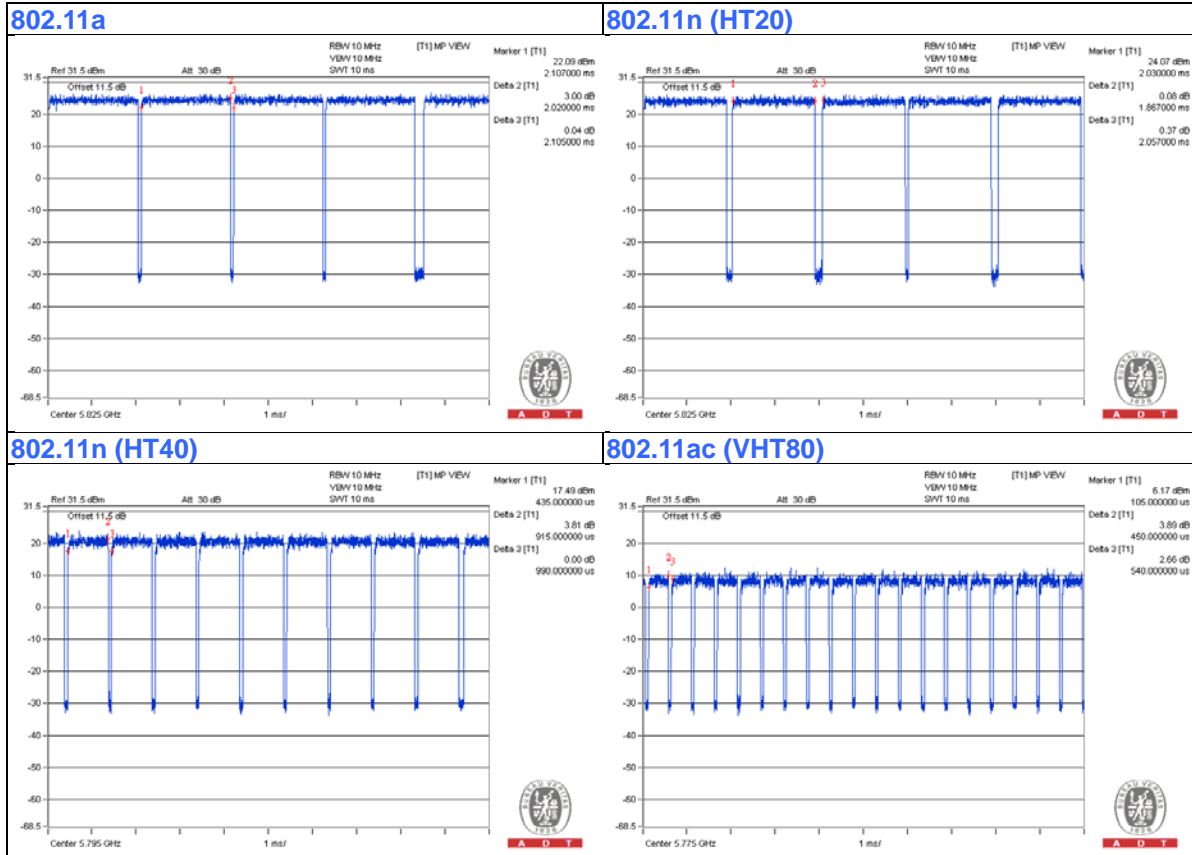

### 3.4 Description of Support Units

The EUT has been tested as an independent unit together with other necessary accessories or support units. The following support units or accessories were used to form a representative test configuration during the tests.

ID	Product	Brand	Model No.	Serial No.	FCC ID	Remarks
A.	Notebook	DELL	E5410	1HC2XM1	FCC DoC Approved	-
B.	Flash Drive	Transcend	V85	538455 4489		
C.	Load	NA	NA	NA	NA	-
D.	PoE	EnGenius	EPE-48GR	NA	NA	Supplied by the manufacturer
E.	Adapter of PoE	Powertron Electronics Corp.	PA1040-480IB080	NA	NA	Supplied by the manufacturer
F.	Adapter	Powertron Electronics Corp.	PA1024-2HUB PA1024-2HU PA1024-120HUB200	NA	NA	Supplied by the manufacturer

Note:

1. All power cords of the above support units are non-shielded (1.8m).
2. Item A acted as communication partners to transfer data.

ID	Descriptions	Qty.	Length (m)	Shielding (Yes/No)	Cores (Qty.)	Remarks
1.	LAN cable	1	3	N	0	Cat5e
2.	LAN cable	1	1.8	N	0	Cat5e
3.	Console cable	1	1.5	N	0	-
4.	LAN cable	1	1.8	N	0	Cat5e
5.	DC cable	1	1.55	N	1	Attached on adapter
6.	DC cable	1	1.5	N	1	Attached on adapter

Note: The core(s) is(are) originally attached to the cable(s).

### 3.4.1 Configuration of System under Test

<PoE Mode>

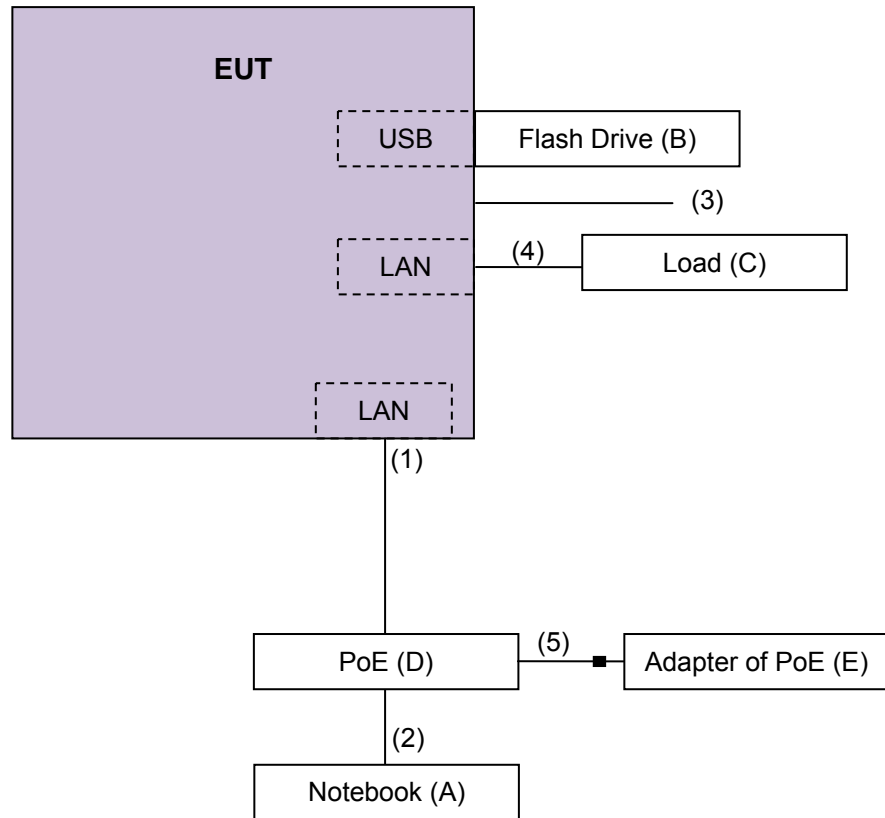

<Adapter Mode>

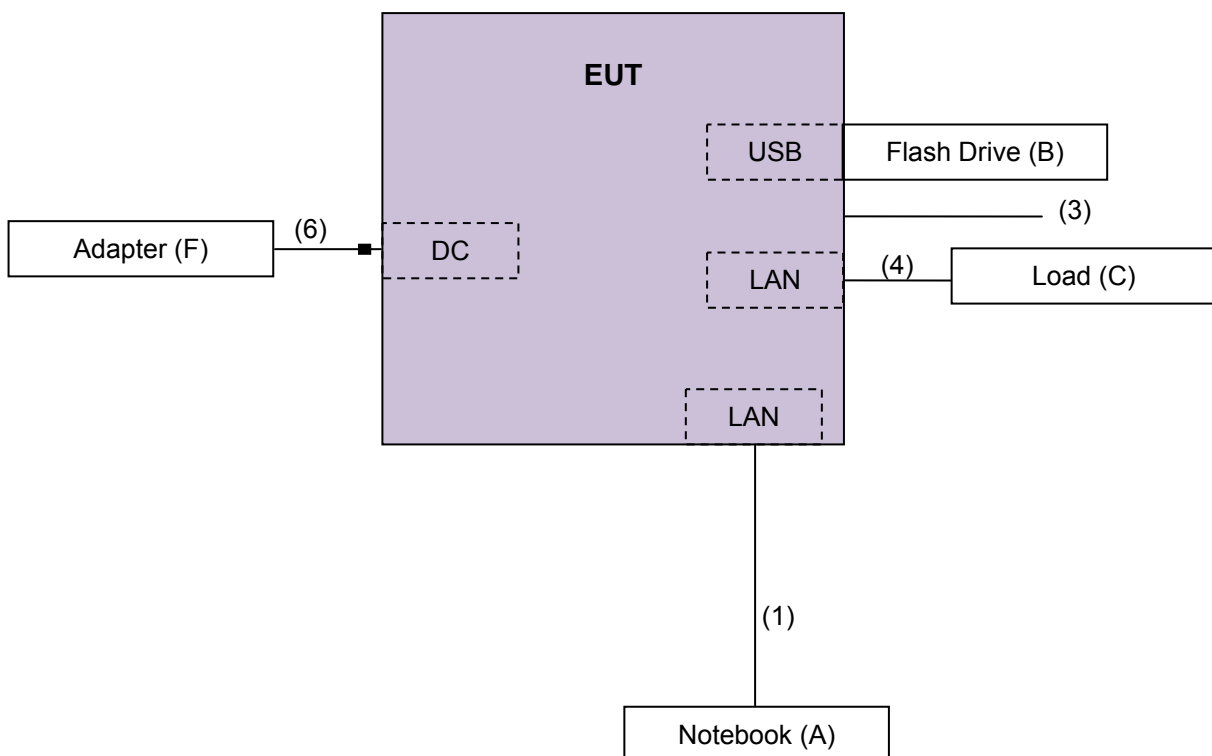

### 3.5 General Description of Applied Standard

The EUT is a RF Product. According to the specifications of the manufacturer, it must comply with the requirements of the following standards:

**FCC Part 15, Subpart E (15.407)**  
**789033 D02 General UNII Test Procedure New Rules v01**  
**662911 D01 Multiple Transmitter Output v02r01**  
ANSI C63.10-2009

All test items have been performed and recorded as per the above standards.

**NOTE:** The EUT has been verified to comply with the requirements of FCC Part 15, Subpart B, Class B (DoC). The test report has been issued separately.

## 4 Test Types and Results

### 4.1 Radiated Emission and Bandedge Measurement

#### 4.1.1 Limits of Radiated Emission and Bandedge Measurement

Radiated emissions which fall in the restricted bands must comply with the radiated emission limits specified as below table.

Frequencies (MHz)	Field Strength (microvolts/meter)	Measurement Distance (meters)
0.009 ~ 0.490	2400/F(kHz)	300
0.490 ~ 1.705	24000/F(kHz)	30
1.705 ~ 30.0	30	30
30 ~ 88	100	3
88 ~ 216	150	3
216 ~ 960	200	3
Above 960	500	3

#### NOTE:

1. The lower limit shall apply at the transition frequencies.
2. Emission level (dBuV/m) = 20 log Emission level (uV/m).
3. For frequencies above 1000MHz, the field strength limits are based on average detector, however, the peak field strength of any emission shall not exceed the maximum permitted average limits, specified above by more than 20dB under any Condition of modulation.

#### LIMITS OF UNWANTED EMISSION OUT OF THE RESTRICTED BANDS

APPLICABLE TO	LIMIT	
789033 D02 General UNII Test Procedure New Rules v01	FIELD STRENGTH AT 3m	
	PK:74 (dBuV/m)	AV:54 (dBuV/m)
APPLICABLE TO	EIRP LIMIT	EQUIVALENT FIELD STRENGTH AT 3m
15.407(b)(1)	PK:-27 (dBm/MHz)	PK:68.2(dBuV/m)
15.407(b)(2)		
15.407(b)(3)		
15.407(b)(4)	PK:-27 (dBm/MHz) <sup>*1</sup> PK:-17 (dBm/MHz) <sup>*2</sup>	PK: 68.2(dBuV/m) <sup>*1</sup> PK:78.2 (dBuV/m) <sup>*2</sup>

**NOTE:** <sup>\*1</sup> beyond 10MHz of the band edge <sup>\*2</sup> within 10 MHz of band edge

The following formula is used to convert the equipment isotropic radiated power (eirp) to field strength:

$$E = \frac{1000000\sqrt{30P}}{3} \mu\text{V/m, where P is the eirp (Watts).}$$



#### 4.1.2 Test Instruments

Description & Manufacturer	Model No.	Serial No.	Cal. Date	Cal. Due
Test Receiver ROHDE & SCHWARZ	ESIB7	100187	Apr. 10, 2015	Apr. 09, 2016
Spectrum Analyzer ROHDE & SCHWARZ	FSP40	100041	Aug. 29, 2014	Aug. 28, 2015
BILOG Antenna SCHWARZBECK	VULB9168	9168-160	Feb. 05, 2015	Feb. 04, 2016
HORN Antenna SCHWARZBECK	9120D	209	Feb. 09, 2015	Feb. 08, 2016
HORN Antenna SCHWARZBECK	BBHA 9170	BBHA9170241	Feb. 09, 2015	Feb. 08, 2016
Preamplifier Agilent	8447D	2944A10738	Oct.18, 2014	Oct. 17, 2015
Preamplifier Agilent	8449B	3008A01964	Aug. 22, 2014	Aug. 21, 2015
RF signal cable HUBER+SUHNNER	SUCOFLEX 104	214378/4	Aug. 22, 2014	Aug. 21, 2015
RF signal cable HUBER+SUHNNER	SUCOFLEX 106	12738/6 +309224/4	Aug. 22, 2014	Aug. 21, 2015
Software BV ADT	ADT_Radiated_ V7.6.15.9.4	NA	NA	NA
Antenna Tower inn-co GmbH	MA 4000	013303	NA	NA
Antenna Tower Controller BV ADT	AT100	AT93021702	NA	NA
Turn Table BV ADT	TT100	TT93021702	NA	NA
Turn Table Controller BV ADT	SC100	SC93021702	NA	NA
High Speed Peak Power Meter	ML2495A	0824011	Jul. 26, 2014	Jul. 25, 2015
Power Sensor	MA2411B	0738171	Jul. 26, 2014	Jul. 25, 2015
26GHz ~ 40GHz Amplifier	EM26400	815221	Oct. 18, 2014	Oct. 17, 2015
WIT Standard Temperature And Humidity Chamber	TH-4S-C	W981030	Jun. 09, 2014	Jun. 08, 2015

NOTE: 1. The calibration interval of the above test instruments is 12 months and the calibrations are traceable to NML/ROC and NIST/USA.

2. The test was performed in HwaYa Chamber 3.

3. The horn antenna and HP preamplifier (model: 8449B) are used only for the measurement of emission frequency above 1GHz if tested.

4. The FCC Site Registration No. is 988962.

5. The IC Site Registration No. is IC 7450F-3.

#### 4.1.3 Test Procedure

- a. The EUT was placed on the top of a rotating table 0.8 meters above the ground at 3 meter chamber room for test. The table was rotated 360 degrees to determine the position of the highest radiation.
- b. The EUT was set 3 meters away from the interference-receiving antenna, which was mounted on the top of a variable-height antenna tower.
- c. The height of antenna is varied from one meter to four meters above the ground to determine the maximum value of the field strength. Both horizontal and vertical polarizations of the antenna are set to make the measurement.
- d. For each suspected emission, the EUT was arranged to its worst case and then the antenna was tuned to heights from 1 meter to 4 meters and the rotatable table was turned from 0 degrees to 360 degrees to find the maximum reading.
- e. The test-receiver system was set to quasi-peak detect function and specified bandwidth with maximum hold mode when the test frequency is below 1 GHz.
- f. The test-receiver system was set to peak and average detect function and specified bandwidth with maximum hold mode when the test frequency is above 1 GHz. If the peak reading value also meets average limit, measurement with the average detector is unnecessary.

**Note:**

1. For emission measurements above 1 GHz, the EUT shall be placed at a height of 1.5 m above the ground at 3 meter chamber room for test
2. The resolution bandwidth and video bandwidth of test receiver/spectrum analyzer is 120kHz for Quasi-peak detection (QP) at frequency below 1GHz.
3. The resolution bandwidth of test receiver/spectrum analyzer is 1 MHz and the video bandwidth is 3 MHz for Peak detection (PK) at frequency above 1GHz.
4. The resolution bandwidth of test receiver/spectrum analyzer is 1MHz and the video bandwidth is 3MHz for RMS Average (Duty cycle < 98%) for Average detection (AV) at frequency above 1GHz, then the measurement results was added to a correction factor ( $10 \log(1/\text{duty cycle})$ ).
5. The resolution bandwidth of test receiver/spectrum analyzer is 1MHz and the video bandwidth is 10Hz (Duty cycle  $\geq 98\%$ ) for Average detection (AV) at frequency above 1GHz.
6. All modes of operation were investigated and the worst-case emissions are reported.

#### 4.1.4 Deviation from Test Standard

No deviation.

#### 4.1.5 Test Setup

##### <Frequency Range below 1GHz>

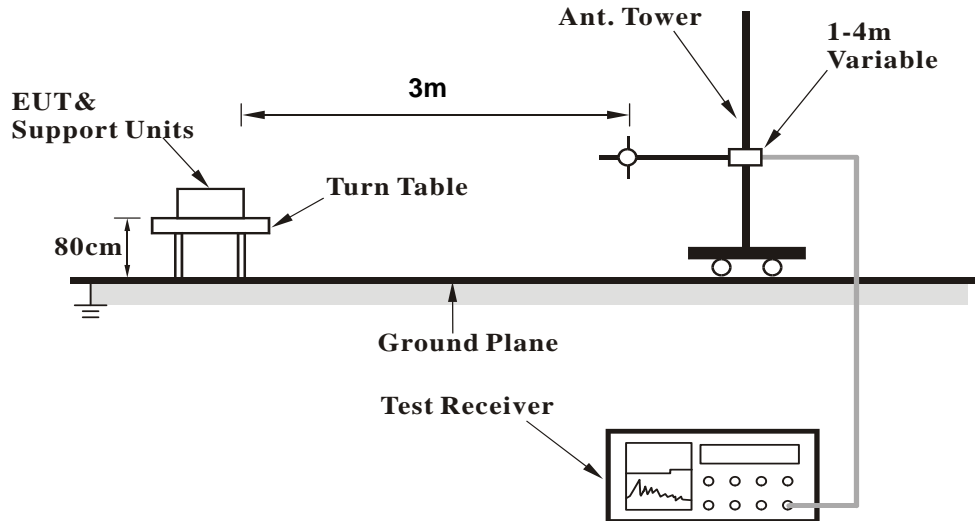

##### <Frequency Range above 1GHz>

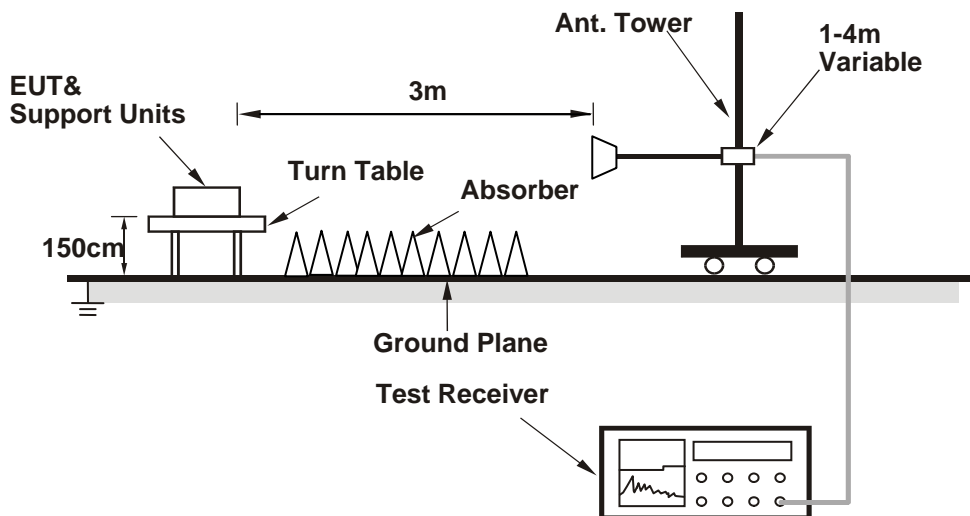

For the actual test configuration, please refer to the attached file (Test Setup Photo).

#### 4.1.6 EUT Operating Conditions

- Placed the EUT on the testing table.
- Prepared notebook to act as communication partner and placed it outside of testing area.
- The communication partner connected with EUT via a RJ45 cable and ran a test program (provided by manufacturer) to enable EUT under transmission condition continuously at specific channel frequency.
- The communication partner sent data to EUT by command "PING".
- The necessary accessories enable the system in full functions.

4.1.7 Test Results

**ABOVE 1GHz DATA :**

**Test Mode A**

**802.11a**

<b>CHANNEL</b>	TX Channel 36	<b>DETECTOR FUNCTION</b>	Peak (PK)
<b>FREQUENCY RANGE</b>	1GHz ~ 40GHz		Average (AV)

**ANTENNA POLARITY & TEST DISTANCE: HORIZONTAL AT 3 M**

NO.	FREQ. (MHz)	EMISSION LEVEL (dBuV/m)	LIMIT (dBuV/m)	MARGIN (dB)	ANTENNA HEIGHT (m)	TABLE ANGLE (Degree)	RAW VALUE (dBuV)	CORRECTION FACTOR (dB/m)
1	5150.00	68.5 PK	74.0	-5.5	1.15 H	48	62.50	6.00
2	5150.00	52.7 AV	54.0	-1.3	1.15 H	48	46.70	6.00
3	*5180.00	117.8 PK			1.00 H	39	78.30	39.50
4	*5180.00	107.7 AV			1.00 H	39	68.20	39.50
5	#6906.00	58.3 PK	68.2	-9.9	1.33 H	62	46.80	11.50
6	#10360.00	60.6 PK	74.0	-13.4	1.33 H	339	42.20	18.40
7	#10360.00	47.8 AV	54.0	-6.2	1.33 H	339	29.40	18.40

**ANTENNA POLARITY & TEST DISTANCE: VERTICAL AT 3 M**

NO.	FREQ. (MHz)	EMISSION LEVEL (dBuV/m)	LIMIT (dBuV/m)	MARGIN (dB)	ANTENNA HEIGHT (m)	TABLE ANGLE (Degree)	RAW VALUE (dBuV)	CORRECTION FACTOR (dB/m)
1	5150.00	61.2 PK	74.0	-12.8	1.14 V	310	55.20	6.00
2	5150.00	47.3 AV	54.0	-6.7	1.14 V	310	41.30	6.00
3	*5180.00	114.3 PK			1.07 V	312	74.80	39.50
4	*5180.00	103.6 AV			1.07 V	312	64.10	39.50
5	#6906.00	56.4 PK	68.2	-11.8	1.32 V	308	44.90	11.50
6	#10360.00	60.4 PK	74.0	-13.6	1.37 V	81	42.00	18.40
7	#10360.00	47.5 AV	54.0	-6.5	1.37 V	81	29.10	18.40

**REMARKS:**

1. Emission Level(dBuV/m) = Raw Value(dBuV) + Correction Factor(dB/m)
2. Correction Factor(dB/m) = Antenna Factor(dB/m) + Cable Factor(dB)
3. The other emission levels were very low against the limit.
4. Margin value = Emission Level – Limit value
5. " \* ": Fundamental frequency.
6. " # ": The radiated frequency is out of the restricted band.

<b>CHANNEL</b>	TX Channel 40	<b>DETECTOR FUNCTION</b>	Peak (PK)
<b>FREQUENCY RANGE</b>	1GHz ~ 40GHz		Average (AV)

**ANTENNA POLARITY & TEST DISTANCE: HORIZONTAL AT 3 M**

NO.	FREQ. (MHz)	EMISSION LEVEL (dBuV/m)	LIMIT (dBuV/m)	MARGIN (dB)	ANTENNA HEIGHT (m)	TABLE ANGLE (Degree)	RAW VALUE (dBuV)	CORRECTION FACTOR (dB/m)
1	5150.00	66.8 PK	74.0	-7.2	1.11 H	45	60.80	6.00
2	5150.00	52.3 AV	54.0	-1.7	1.11 H	45	46.30	6.00
3	*5200.00	122.5 PK			1.01 H	40	82.90	39.60
4	*5200.00	112.8 AV			1.01 H	40	73.20	39.60
5	#6933.00	58.0 PK	68.2	-10.2	1.27 H	62	46.30	11.70
6	#10400.00	62.2 PK	74.0	-11.8	1.00 H	60	43.70	18.50
7	#10400.00	49.6 AV	54.0	-4.4	1.00 H	60	31.10	18.50

**ANTENNA POLARITY & TEST DISTANCE: VERTICAL AT 3 M**

NO.	FREQ. (MHz)	EMISSION LEVEL (dBuV/m)	LIMIT (dBuV/m)	MARGIN (dB)	ANTENNA HEIGHT (m)	TABLE ANGLE (Degree)	RAW VALUE (dBuV)	CORRECTION FACTOR (dB/m)
1	5150.00	62.0 PK	74.0	-12.0	1.27 V	19	56.00	6.00
2	5150.00	47.7 AV	54.0	-6.3	1.27 V	19	41.70	6.00
3	*5200.00	117.9 PK			1.00 V	309	78.30	39.60
4	*5200.00	107.8 AV			1.00 V	309	68.20	39.60
5	#6933.00	56.1 PK	68.2	-12.1	1.10 V	331	44.40	11.70
6	#10400.00	60.1 PK	74.0	-13.9	1.34 V	88	41.60	18.50
7	#10400.00	49.0 AV	54.0	-5.0	1.34 V	88	30.50	18.50

**REMARKS:**

1. Emission Level(dBuV/m) = Raw Value(dBuV) + Correction Factor(dB/m)
2. Correction Factor(dB/m) = Antenna Factor(dB/m) + Cable Factor(dB)
3. The other emission levels were very low against the limit.
4. Margin value = Emission Level – Limit value
5. " \* ": Fundamental frequency.
6. " # ": The radiated frequency is out of the restricted band.

<b>CHANNEL</b>	TX Channel 48	<b>DETECTOR FUNCTION</b>	Peak (PK)
<b>FREQUENCY RANGE</b>	1GHz ~ 40GHz		Average (AV)

**ANTENNA POLARITY & TEST DISTANCE: HORIZONTAL AT 3 M**

NO.	FREQ. (MHz)	EMISSION LEVEL (dBuV/m)	LIMIT (dBuV/m)	MARGIN (dB)	ANTENNA HEIGHT (m)	TABLE ANGLE (Degree)	RAW VALUE (dBuV)	CORRECTION FACTOR (dB/m)
1	5088.00	63.7 PK	74.0	-10.3	1.93 H	55	57.90	5.80
2	5088.00	51.4 AV	54.0	-2.6	1.93 H	55	45.60	5.80
3	*5240.00	123.7 PK			1.00 H	42	84.10	39.60
4	*5240.00	114.0 AV			1.00 H	42	74.40	39.60
5	#6986.00	57.5 PK	68.2	-10.7	1.37 H	58	45.20	12.30
6	#10480.00	61.3 PK	74.0	-12.7	1.33 H	18	42.30	19.00
7	#10480.00	49.4 AV	54.0	-4.6	1.33 H	18	30.40	19.00
8	15720.00	65.5 PK	74.0	-8.5	1.00 H	27	47.00	18.50
9	15720.00	52.8 AV	54.0	-1.2	1.00 H	27	34.30	18.50

**ANTENNA POLARITY & TEST DISTANCE: VERTICAL AT 3 M**

NO.	FREQ. (MHz)	EMISSION LEVEL (dBuV/m)	LIMIT (dBuV/m)	MARGIN (dB)	ANTENNA HEIGHT (m)	TABLE ANGLE (Degree)	RAW VALUE (dBuV)	CORRECTION FACTOR (dB/m)
1	5088.00	59.4 PK	74.0	-14.6	1.00 V	11	53.60	5.80
2	5088.00	47.2 AV	54.0	-6.8	1.00 V	11	41.40	5.80
3	*5240.00	119.1 PK			1.13 V	315	79.50	39.60
4	*5240.00	109.0 AV			1.13 V	315	69.40	39.60
5	#6986.00	55.5 PK	68.2	-12.7	1.67 V	343	43.20	12.30
6	#10480.00	61.7 PK	74.0	-12.3	1.02 V	346	42.70	19.00
7	#10480.00	49.3 AV	54.0	-4.7	1.02 V	346	30.30	19.00
8	15720.00	64.5 PK	74.0	-9.5	1.74 V	3	46.00	18.50
9	15720.00	52.1 AV	54.0	-1.9	1.74 V	3	33.60	18.50

**REMARKS:**

1. Emission Level(dBuV/m) = Raw Value(dBuV) + Correction Factor(dB/m)
2. Correction Factor(dB/m) = Antenna Factor(dB/m) + Cable Factor(dB)
3. The other emission levels were very low against the limit.
4. Margin value = Emission Level – Limit value
5. " \* ": Fundamental frequency.
6. " # ": The radiated frequency is out of the restricted band.

**802.11n (HT20)**

<b>CHANNEL</b>	TX Channel 36	<b>DETECTOR FUNCTION</b>	Peak (PK)
<b>FREQUENCY RANGE</b>	1GHz ~ 40GHz		Average (AV)

<b>ANTENNA POLARITY &amp; TEST DISTANCE: HORIZONTAL AT 3 M</b>								
NO.	FREQ. (MHz)	EMISSION LEVEL (dBuV/m)	LIMIT (dBuV/m)	MARGIN (dB)	ANTENNA HEIGHT (m)	TABLE ANGLE (Degree)	RAW VALUE (dBuV)	CORRECTION FACTOR (dB/m)
1	5150.00	68.1 PK	74.0	-5.9	1.10 H	41	62.10	6.00
2	<b>5150.00</b>	<b>53.0 AV</b>	<b>54.0</b>	<b>-1.0</b>	<b>1.10 H</b>	<b>41</b>	<b>47.00</b>	<b>6.00</b>
3	*5180.00	119.7 PK			1.79 H	60	80.20	39.50
4	*5180.00	109.6 AV			1.79 H	60	70.10	39.50
5	#6906.00	56.8 PK	68.2	-11.4	1.38 H	55	45.30	11.50
6	#10360.00	59.9 PK	74.0	-14.1	1.30 H	86	41.50	18.40
7	#10360.00	47.2 AV	54.0	-6.8	1.30 H	86	28.80	18.40
<b>ANTENNA POLARITY &amp; TEST DISTANCE: VERTICAL AT 3 M</b>								
NO.	FREQ. (MHz)	EMISSION LEVEL (dBuV/m)	LIMIT (dBuV/m)	MARGIN (dB)	ANTENNA HEIGHT (m)	TABLE ANGLE (Degree)	RAW VALUE (dBuV)	CORRECTION FACTOR (dB/m)
1	5150.00	61.3 PK	74.0	-12.7	1.08 V	312	55.30	6.00
2	5150.00	48.3 AV	54.0	-5.7	1.08 V	312	42.30	6.00
3	*5180.00	112.0 PK			1.00 V	306	72.50	39.50
4	*5180.00	103.0 AV			1.00 V	306	63.50	39.50
5	#6906.00	55.7 PK	68.2	-12.5	1.16 V	333	44.20	11.50
6	#10360.00	60.7 PK	74.0	-13.3	1.31 V	234	42.30	18.40
7	#10360.00	47.3 AV	54.0	-6.7	1.31 V	234	28.90	18.40

**REMARKS:**

1. Emission Level(dBuV/m) = Raw Value(dBuV) + Correction Factor(dB/m)
2. Correction Factor(dB/m) = Antenna Factor(dB/m) + Cable Factor(dB)
3. The other emission levels were very low against the limit.
4. Margin value = Emission Level – Limit value
5. " \* ": Fundamental frequency.
6. " # ": The radiated frequency is out of the restricted band.

<b>CHANNEL</b>	TX Channel 40	<b>DETECTOR FUNCTION</b>	Peak (PK)
<b>FREQUENCY RANGE</b>	1GHz ~ 40GHz		Average (AV)

**ANTENNA POLARITY & TEST DISTANCE: HORIZONTAL AT 3 M**

NO.	FREQ. (MHz)	EMISSION LEVEL (dBuV/m)	LIMIT (dBuV/m)	MARGIN (dB)	ANTENNA HEIGHT (m)	TABLE ANGLE (Degree)	RAW VALUE (dBuV)	CORRECTION FACTOR (dB/m)
1	5150.00	65.7 PK	74.0	-8.3	1.47 H	54	59.70	6.00
2	5150.00	52.4 AV	54.0	-1.6	1.47 H	54	46.40	6.00
3	*5200.00	123.6 PK			2.14 H	54	84.00	39.60
4	*5200.00	113.6 AV			2.14 H	54	74.00	39.60
5	#6933.00	60.4 PK	68.2	-7.8	1.27 H	57	48.70	11.70
6	#10400.00	60.8 PK	74.0	-13.2	1.16 H	350	42.30	18.50
7	#10400.00	48.7 AV	54.0	-5.3	1.16 H	350	30.20	18.50

**ANTENNA POLARITY & TEST DISTANCE: VERTICAL AT 3 M**

NO.	FREQ. (MHz)	EMISSION LEVEL (dBuV/m)	LIMIT (dBuV/m)	MARGIN (dB)	ANTENNA HEIGHT (m)	TABLE ANGLE (Degree)	RAW VALUE (dBuV)	CORRECTION FACTOR (dB/m)
1	5150.00	60.8 PK	74.0	-13.2	1.93 V	46	54.80	6.00
2	5150.00	47.7 AV	54.0	-6.3	1.93 V	46	41.70	6.00
3	*5200.00	116.8 PK			1.14 V	310	77.20	39.60
4	*5200.00	106.8 AV			1.14 V	310	67.20	39.60
5	#6933.00	57.1 PK	68.2	-11.1	2.21 V	323	45.40	11.70
6	#10400.00	60.6 PK	74.0	-13.4	1.11 V	0	42.10	18.50
7	#10400.00	48.7 AV	54.0	-5.3	1.11 V	0	30.20	18.50

**REMARKS:**

1. Emission Level(dBuV/m) = Raw Value(dBuV) + Correction Factor(dB/m)
2. Correction Factor(dB/m) = Antenna Factor(dB/m) + Cable Factor(dB)
3. The other emission levels were very low against the limit.
4. Margin value = Emission Level – Limit value
5. " \* ": Fundamental frequency.
6. " # ": The radiated frequency is out of the restricted band.



<b>CHANNEL</b>	TX Channel 48	<b>DETECTOR FUNCTION</b>	Peak (PK)
<b>FREQUENCY RANGE</b>	1GHz ~ 40GHz		Average (AV)

**ANTENNA POLARITY & TEST DISTANCE: HORIZONTAL AT 3 M**

NO.	FREQ. (MHz)	EMISSION LEVEL (dBuV/m)	LIMIT (dBuV/m)	MARGIN (dB)	ANTENNA HEIGHT (m)	TABLE ANGLE (Degree)	RAW VALUE (dBuV)	CORRECTION FACTOR (dB/m)
1	5075.00	62.6 PK	74.0	-11.4	1.99 H	60	56.80	5.80
2	5075.00	50.9 AV	54.0	-3.1	1.99 H	60	45.10	5.80
3	*5240.00	123.5 PK			1.00 H	43	83.90	39.60
4	*5240.00	113.7 AV			1.00 H	43	74.10	39.60
5	#6986.00	57.8 PK	68.2	-10.4	1.36 H	54	45.50	12.30
6	#10480.00	61.2 PK	74.0	-12.8	1.15 H	20	42.20	19.00
7	#10480.00	49.2 AV	54.0	-4.8	1.15 H	20	30.20	19.00
8	15720.00	64.7 PK	74.0	-9.3	1.00 H	28	46.20	18.50
9	15720.00	52.2 AV	54.0	-1.8	1.00 H	28	33.70	18.50

**ANTENNA POLARITY & TEST DISTANCE: VERTICAL AT 3 M**

NO.	FREQ. (MHz)	EMISSION LEVEL (dBuV/m)	LIMIT (dBuV/m)	MARGIN (dB)	ANTENNA HEIGHT (m)	TABLE ANGLE (Degree)	RAW VALUE (dBuV)	CORRECTION FACTOR (dB/m)
1	5075.00	59.7 PK	74.0	-14.3	1.00 V	20	53.90	5.80
2	5075.00	47.7 AV	54.0	-6.3	1.00 V	20	41.90	5.80
3	*5240.00	118.6 PK			1.00 V	309	79.00	39.60
4	*5240.00	108.3 AV			1.00 V	309	68.70	39.60
5	#6986.00	55.8 PK	68.2	-12.4	1.14 V	333	43.50	12.30
6	#10480.00	61.0 PK	74.0	-13.0	1.28 V	344	42.00	19.00
7	#10480.00	49.3 AV	54.0	-4.7	1.28 V	344	30.30	19.00
8	15720.00	63.8 PK	74.0	-10.2	1.75 V	5	45.30	18.50
9	15720.00	52.0 AV	54.0	-2.0	1.75 V	5	33.50	18.50

**REMARKS:**

1. Emission Level(dBuV/m) = Raw Value(dBuV) + Correction Factor(dB/m)
2. Correction Factor(dB/m) = Antenna Factor(dB/m) + Cable Factor(dB)
3. The other emission levels were very low against the limit.
4. Margin value = Emission Level – Limit value
5. " \* ": Fundamental frequency.
6. " # ": The radiated frequency is out of the restricted band.

**802.11n (HT40)**

<b>CHANNEL</b>	TX Channel 38	<b>DETECTOR FUNCTION</b>	Peak (PK)
<b>FREQUENCY RANGE</b>	1GHz ~ 40GHz		Average (AV)

**ANTENNA POLARITY & TEST DISTANCE: HORIZONTAL AT 3 M**

NO.	FREQ. (MHz)	EMISSION LEVEL (dBuV/m)	LIMIT (dBuV/m)	MARGIN (dB)	ANTENNA HEIGHT (m)	TABLE ANGLE (Degree)	RAW VALUE (dBuV)	CORRECTION FACTOR (dB/m)
1	5150.00	64.4 PK	74.0	-9.6	1.25 H	48	58.40	6.00
2	5150.00	52.2 AV	54.0	-1.8	1.25 H	48	46.20	6.00
3	*5190.00	111.0 PK			1.00 H	40	71.50	39.50
4	*5190.00	101.1 AV			1.00 H	40	61.60	39.50
5	#6920.00	55.9 PK	68.2	-12.3	1.44 H	57	44.20	11.70
6	#10380.00	58.9 PK	74.0	-15.1	1.31 H	46	40.40	18.50
7	#10380.00	46.9 AV	54.0	-7.1	1.31 H	46	28.40	18.50

**ANTENNA POLARITY & TEST DISTANCE: VERTICAL AT 3 M**

NO.	FREQ. (MHz)	EMISSION LEVEL (dBuV/m)	LIMIT (dBuV/m)	MARGIN (dB)	ANTENNA HEIGHT (m)	TABLE ANGLE (Degree)	RAW VALUE (dBuV)	CORRECTION FACTOR (dB/m)
1	5150.00	62.7 PK	74.0	-11.3	1.76 V	38	56.70	6.00
2	5150.00	49.1 AV	54.0	-4.9	1.76 V	38	43.10	6.00
3	*5190.00	105.8 PK			1.68 V	300	66.30	39.50
4	*5190.00	96.1 AV			1.68 V	300	56.60	39.50
5	#6920.00	54.1 PK	68.2	-14.1	1.29 V	4	42.40	11.70
6	#10380.00	60.0 PK	74.0	-14.0	1.10 V	264	41.50	18.50
7	#10380.00	46.5 AV	54.0	-7.5	1.10 V	264	28.00	18.50

**REMARKS:**

1. Emission Level(dBuV/m) = Raw Value(dBuV) + Correction Factor(dB/m)
2. Correction Factor(dB/m) = Antenna Factor(dB/m) + Cable Factor(dB)
3. The other emission levels were very low against the limit.
4. Margin value = Emission Level – Limit value
5. " \* ": Fundamental frequency.
6. " # ": The radiated frequency is out of the restricted band.

<b>CHANNEL</b>	TX Channel 46	<b>DETECTOR FUNCTION</b>	Peak (PK)
<b>FREQUENCY RANGE</b>	1GHz ~ 40GHz		Average (AV)

**ANTENNA POLARITY & TEST DISTANCE: HORIZONTAL AT 3 M**

NO.	FREQ. (MHz)	EMISSION LEVEL (dBuV/m)	LIMIT (dBuV/m)	MARGIN (dB)	ANTENNA HEIGHT (m)	TABLE ANGLE (Degree)	RAW VALUE (dBuV)	CORRECTION FACTOR (dB/m)
1	5150.00	65.8 PK	74.0	-8.2	1.83 H	64	59.80	6.00
2	5150.00	52.6 AV	54.0	-1.4	1.83 H	64	46.60	6.00
3	*5230.00	118.2 PK			1.22 H	40	78.60	39.60
4	*5230.00	109.0 AV			1.22 H	40	69.40	39.60
5	#6973.00	58.1 PK	68.2	-10.1	1.31 H	56	45.80	12.30
6	#10460.00	60.1 PK	74.0	-13.9	1.22 H	263	41.20	18.90
7	#10460.00	47.2 AV	54.0	-6.8	1.22 H	263	28.30	18.90

**ANTENNA POLARITY & TEST DISTANCE: VERTICAL AT 3 M**

NO.	FREQ. (MHz)	EMISSION LEVEL (dBuV/m)	LIMIT (dBuV/m)	MARGIN (dB)	ANTENNA HEIGHT (m)	TABLE ANGLE (Degree)	RAW VALUE (dBuV)	CORRECTION FACTOR (dB/m)
1	5150.00	61.5 PK	74.0	-12.5	1.06 V	50	55.50	6.00
2	5150.00	49.1 AV	54.0	-4.9	1.06 V	50	43.10	6.00
3	*5230.00	113.6 PK			1.06 V	309	74.00	39.60
4	*5230.00	104.1 AV			1.06 V	309	64.50	39.60
5	#6973.00	56.1 PK	68.2	-12.1	1.02 V	283	43.80	12.30
6	#10460.00	60.1 PK	74.0	-13.9	1.12 V	231	41.20	18.90
7	#10460.00	46.8 AV	54.0	-7.2	1.12 V	231	27.90	18.90

**REMARKS:**

1. Emission Level(dBuV/m) = Raw Value(dBuV) + Correction Factor(dB/m)
2. Correction Factor(dB/m) = Antenna Factor(dB/m) + Cable Factor(dB)
3. The other emission levels were very low against the limit.
4. Margin value = Emission Level – Limit value
5. " \* ": Fundamental frequency.
6. " # ": The radiated frequency is out of the restricted band.

802.11ac (VHT80)

<b>CHANNEL</b>	TX Channel 42	<b>DETECTOR FUNCTION</b>	Peak (PK)
<b>FREQUENCY RANGE</b>	1GHz ~ 40GHz		Average (AV)

**ANTENNA POLARITY & TEST DISTANCE: HORIZONTAL AT 3 M**

NO.	FREQ. (MHz)	EMISSION LEVEL (dBuV/m)	LIMIT (dBuV/m)	MARGIN (dB)	ANTENNA HEIGHT (m)	TABLE ANGLE (Degree)	RAW VALUE (dBuV)	CORRECTION FACTOR (dB/m)
1	5150.00	65.4 PK	74.0	-8.6	1.94 H	65	59.40	6.00
2	5150.00	52.9 AV	54.0	-1.1	1.94 H	65	46.90	6.00
3	*5210.00	104.7 PK			1.27 H	39	65.10	39.60
4	*5210.00	94.3 AV			1.27 H	39	54.70	39.60
5	#10420.00	60.2 PK	74.0	-13.8	1.32 H	47	41.60	18.60
6	#10420.00	47.6 AV	54.0	-6.4	1.32 H	47	29.00	18.60

**ANTENNA POLARITY & TEST DISTANCE: VERTICAL AT 3 M**

NO.	FREQ. (MHz)	EMISSION LEVEL (dBuV/m)	LIMIT (dBuV/m)	MARGIN (dB)	ANTENNA HEIGHT (m)	TABLE ANGLE (Degree)	RAW VALUE (dBuV)	CORRECTION FACTOR (dB/m)
1	5150.00	61.1 PK	74.0	-12.9	1.16 V	310	55.10	6.00
2	5150.00	48.1 AV	54.0	-5.9	1.16 V	310	42.10	6.00
3	*5210.00	100.3 PK			1.00 V	311	60.70	39.60
4	*5210.00	89.4 AV			1.00 V	311	49.80	39.60
5	#10420.00	60.2 PK	74.0	-13.8	1.11 V	216	41.60	18.60
6	#10420.00	47.7 AV	54.0	-6.3	1.11 V	216	29.10	18.60

**REMARKS:**

1. Emission Level(dBuV/m) = Raw Value(dBuV) + Correction Factor(dB/m)
2. Correction Factor(dB/m) = Antenna Factor(dB/m) + Cable Factor(dB)
3. The other emission levels were very low against the limit.
4. Margin value = Emission Level – Limit value
5. " \* ": Fundamental frequency.
6. " # ": The radiated frequency is out of the restricted band.

**802.11a**

<b>CHANNEL</b>	TX Channel 149	<b>DETECTOR FUNCTION</b>	Peak (PK)
<b>FREQUENCY RANGE</b>	1GHz ~ 40GHz		Average (AV)

**ANTENNA POLARITY & TEST DISTANCE: HORIZONTAL AT 3 M**

NO.	FREQ. (MHz)	EMISSION LEVEL (dBuV/m)	LIMIT (dBuV/m)	MARGIN (dB)	ANTENNA HEIGHT (m)	TABLE ANGLE (Degree)	RAW VALUE (dBuV)	CORRECTION FACTOR (dB/m)
1	#5714.00	67.3 PK	74.0	-6.7	1.90 H	45	60.50	6.80
2	#5714.00	52.9 AV	54.0	-1.1	1.90 H	45	46.10	6.80
3	#5722.00	71.3 PK	78.2	-6.9	2.32 H	54	64.50	6.80
4	#5725.00	58.9 PK	78.2	-19.3	2.32 H	57	52.10	6.80
5	*5745.00	120.4 PK			1.22 H	43	80.00	40.40
6	*5745.00	110.5 AV			1.22 H	43	70.10	40.40
7	11490.00	64.9 PK	74.0	-9.1	1.21 H	59	46.50	18.40
8	11490.00	52.7 AV	54.0	-1.3	1.21 H	59	34.30	18.40

**ANTENNA POLARITY & TEST DISTANCE: VERTICAL AT 3 M**

NO.	FREQ. (MHz)	EMISSION LEVEL (dBuV/m)	LIMIT (dBuV/m)	MARGIN (dB)	ANTENNA HEIGHT (m)	TABLE ANGLE (Degree)	RAW VALUE (dBuV)	CORRECTION FACTOR (dB/m)
1	#5714.00	61.7 PK	74.0	-12.3	1.05 V	355	54.90	6.80
2	#5714.00	47.7 AV	54.0	-6.3	1.05 V	355	40.90	6.80
3	#5722.00	65.2 PK	78.2	-13.0	1.05 V	354	58.40	6.80
4	#5725.00	54.0 PK	78.2	-24.2	1.05 V	354	47.20	6.80
5	*5745.00	114.6 PK			1.00 V	34	74.20	40.40
6	*5745.00	104.1 AV			1.00 V	34	63.70	40.40
7	11490.00	63.2 PK	74.0	-10.8	1.03 V	333	44.80	18.40
8	11490.00	51.4 AV	54.0	-2.6	1.03 V	333	33.00	18.40

**REMARKS:**

1. Emission Level(dBuV/m) = Raw Value(dBuV) + Correction Factor(dB/m)
2. Correction Factor(dB/m) = Antenna Factor(dB/m) + Cable Factor(dB)
3. The other emission levels were very low against the limit.
4. Margin value = Emission Level – Limit value
5. " \* ": Fundamental frequency.
6. " # ": The radiated frequency is out of the restricted band.

<b>CHANNEL</b>	TX Channel 157	<b>DETECTOR FUNCTION</b>	Peak (PK)
<b>FREQUENCY RANGE</b>	1GHz ~ 40GHz		Average (AV)

**ANTENNA POLARITY & TEST DISTANCE: HORIZONTAL AT 3 M**

NO.	FREQ. (MHz)	EMISSION LEVEL (dBuV/m)	LIMIT (dBuV/m)	MARGIN (dB)	ANTENNA HEIGHT (m)	TABLE ANGLE (Degree)	RAW VALUE (dBuV)	CORRECTION FACTOR (dB/m)
1	*5785.00	120.4 PK			1.22 H	56	79.90	40.50
2	*5785.00	109.6 AV			1.22 H	56	69.10	40.50
3	11570.00	65.2 PK	74.0	-8.8	1.21 H	58	46.80	18.40
4	11570.00	52.9 AV	54.0	-1.1	1.21 H	58	34.50	18.40

**ANTENNA POLARITY & TEST DISTANCE: VERTICAL AT 3 M**

NO.	FREQ. (MHz)	EMISSION LEVEL (dBuV/m)	LIMIT (dBuV/m)	MARGIN (dB)	ANTENNA HEIGHT (m)	TABLE ANGLE (Degree)	RAW VALUE (dBuV)	CORRECTION FACTOR (dB/m)
1	*5785.00	114.4 PK			1.06 V	35	73.90	40.50
2	*5785.00	103.8 AV			1.06 V	35	63.30	40.50
3	11570.00	64.0 PK	74.0	-10.0	1.00 V	332	45.60	18.40
4	11570.00	51.8 AV	54.0	-2.2	1.00 V	332	33.40	18.40

**REMARKS:**

1. Emission Level(dBuV/m) = Raw Value(dBuV) + Correction Factor(dB/m)
2. Correction Factor(dB/m) = Antenna Factor(dB/m) + Cable Factor(dB)
3. The other emission levels were very low against the limit.
4. Margin value = Emission Level – Limit value
5. " \* ": Fundamental frequency.



<b>CHANNEL</b>	TX Channel 165	<b>DETECTOR FUNCTION</b>	Peak (PK)
<b>FREQUENCY RANGE</b>	1GHz ~ 40GHz		Average (AV)

**ANTENNA POLARITY & TEST DISTANCE: HORIZONTAL AT 3 M**

NO.	FREQ. (MHz)	EMISSION LEVEL (dBuV/m)	LIMIT (dBuV/m)	MARGIN (dB)	ANTENNA HEIGHT (m)	TABLE ANGLE (Degree)	RAW VALUE (dBuV)	CORRECTION FACTOR (dB/m)
1	*5825.00	119.3 PK			1.00 H	31	78.80	40.50
2	*5825.00	109.5 AV			1.00 H	31	69.00	40.50
3	#5850.00	59.0 PK	78.2	-19.2	1.14 H	25	52.10	6.90
4	#5853.00	72.5 PK	78.2	-5.7	1.07 H	42	65.50	7.00
5	#5861.00	67.3 PK	74.0	-6.7	1.38 H	64	60.30	7.00
6	#5861.00	51.5 AV	54.0	-2.5	1.38 H	64	44.50	7.00
7	11650.00	64.7 PK	74.0	-9.3	1.00 H	64	45.80	18.90
8	<b>11650.00</b>	<b>53.0 AV</b>	<b>54.0</b>	<b>-1.0</b>	<b>1.00 H</b>	<b>64</b>	<b>34.10</b>	<b>18.90</b>

**ANTENNA POLARITY & TEST DISTANCE: VERTICAL AT 3 M**

NO.	FREQ. (MHz)	EMISSION LEVEL (dBuV/m)	LIMIT (dBuV/m)	MARGIN (dB)	ANTENNA HEIGHT (m)	TABLE ANGLE (Degree)	RAW VALUE (dBuV)	CORRECTION FACTOR (dB/m)
1	*5825.00	112.6 PK			1.00 V	289	72.10	40.50
2	*5825.00	102.8 AV			1.00 V	289	62.30	40.50
3	#5850.00	50.1 PK	78.2	-28.1	1.51 V	279	43.20	6.90
4	#5853.00	61.9 PK	78.2	-16.3	2.46 V	282	54.90	7.00
5	#5861.00	61.3 PK	74.0	-12.7	1.65 V	274	54.30	7.00
6	#5861.00	48.5 AV	54.0	-5.5	1.65 V	274	41.50	7.00
7	11650.00	63.2 PK	74.0	-10.8	1.05 V	346	44.30	18.90
8	11650.00	51.0 AV	54.0	-3.0	1.05 V	346	32.10	18.90

**REMARKS:**

1. Emission Level(dBuV/m) = Raw Value(dBuV) + Correction Factor(dB/m)
2. Correction Factor(dB/m) = Antenna Factor(dB/m) + Cable Factor(dB)
3. The other emission levels were very low against the limit.
4. Margin value = Emission Level – Limit value
5. " \* ": Fundamental frequency.
6. " # ": The radiated frequency is out of the restricted band.

**802.11n (HT20)**

<b>CHANNEL</b>	TX Channel 149	<b>DETECTOR FUNCTION</b>	Peak (PK)
<b>FREQUENCY RANGE</b>	1GHz ~ 40GHz		Average (AV)

**ANTENNA POLARITY & TEST DISTANCE: HORIZONTAL AT 3 M**

NO.	FREQ. (MHz)	EMISSION LEVEL (dBuV/m)	LIMIT (dBuV/m)	MARGIN (dB)	ANTENNA HEIGHT (m)	TABLE ANGLE (Degree)	RAW VALUE (dBuV)	CORRECTION FACTOR (dB/m)
1	#5714.00	70.4 PK	74.0	-3.6	1.37 H	63	63.60	6.80
2	#5714.00	<b>53.0 AV</b>	<b>54.0</b>	<b>-1.0</b>	<b>1.37 H</b>	<b>63</b>	<b>46.20</b>	<b>6.80</b>
3	#5722.00	70.7 PK	78.2	-7.5	1.51 H	62	63.90	6.80
4	#5725.00	63.6 PK	78.2	-14.6	1.89 H	45	56.80	6.80
5	*5745.00	119.1 PK			1.46 H	50	78.70	40.40
6	*5745.00	108.9 AV			1.46 H	50	68.50	40.40
7	11490.00	63.7 PK	74.0	-10.3	1.40 H	58	45.30	18.40
8	11490.00	51.1 AV	54.0	-2.9	1.40 H	58	32.70	18.40

**ANTENNA POLARITY & TEST DISTANCE: VERTICAL AT 3 M**

NO.	FREQ. (MHz)	EMISSION LEVEL (dBuV/m)	LIMIT (dBuV/m)	MARGIN (dB)	ANTENNA HEIGHT (m)	TABLE ANGLE (Degree)	RAW VALUE (dBuV)	CORRECTION FACTOR (dB/m)
1	#5714.00	60.0 PK	74.0	-14.0	1.76 V	355	53.20	6.80
2	#5714.00	47.7 AV	54.0	-6.3	1.76 V	355	40.90	6.80
3	#5722.00	66.2 PK	78.2	-12.0	2.03 V	351	59.40	6.80
4	#5725.00	57.9 PK	78.2	-20.3	2.15 V	339	51.10	6.80
5	*5745.00	111.7 PK			1.00 V	20	71.30	40.40
6	*5745.00	101.8 AV			1.00 V	20	61.40	40.40
7	11490.00	61.4 PK	74.0	-12.6	1.36 V	333	43.00	18.40
8	11490.00	49.5 AV	54.0	-4.5	1.36 V	333	31.10	18.40

**REMARKS:**

1. Emission Level(dBuV/m) = Raw Value(dBuV) + Correction Factor(dB/m)
2. Correction Factor(dB/m) = Antenna Factor(dB/m) + Cable Factor(dB)
3. The other emission levels were very low against the limit.
4. Margin value = Emission Level – Limit value
5. " \* ": Fundamental frequency.
6. " # ": The radiated frequency is out of the restricted band.



<b>CHANNEL</b>	TX Channel 157	<b>DETECTOR FUNCTION</b>	Peak (PK)
<b>FREQUENCY RANGE</b>	1GHz ~ 40GHz		Average (AV)

**ANTENNA POLARITY & TEST DISTANCE: HORIZONTAL AT 3 M**

NO.	FREQ. (MHz)	EMISSION LEVEL (dBuV/m)	LIMIT (dBuV/m)	MARGIN (dB)	ANTENNA HEIGHT (m)	TABLE ANGLE (Degree)	RAW VALUE (dBuV)	CORRECTION FACTOR (dB/m)
1	*5785.00	120.1 PK			1.41 H	52	79.60	40.50
2	*5785.00	110.4 AV			1.41 H	52	69.90	40.50
3	11570.00	66.2 PK	74.0	-7.8	1.05 H	306	47.80	18.40
4	11570.00	52.8 AV	54.0	-1.2	1.05 H	306	34.40	18.40

**ANTENNA POLARITY & TEST DISTANCE: VERTICAL AT 3 M**

NO.	FREQ. (MHz)	EMISSION LEVEL (dBuV/m)	LIMIT (dBuV/m)	MARGIN (dB)	ANTENNA HEIGHT (m)	TABLE ANGLE (Degree)	RAW VALUE (dBuV)	CORRECTION FACTOR (dB/m)
1	*5785.00	115.1 PK			1.92 V	43	74.60	40.50
2	*5785.00	105.2 AV			1.92 V	43	64.70	40.50
3	11570.00	65.7 PK	74.0	-8.3	1.28 V	332	47.30	18.40
4	11570.00	51.9 AV	54.0	-2.1	1.28 V	332	33.50	18.40

**REMARKS:**

1. Emission Level(dBuV/m) = Raw Value(dBuV) + Correction Factor(dB/m)
2. Correction Factor(dB/m) = Antenna Factor(dB/m) + Cable Factor(dB)
3. The other emission levels were very low against the limit.
4. Margin value = Emission Level – Limit value
5. " \* ": Fundamental frequency.



<b>CHANNEL</b>	TX Channel 165	<b>DETECTOR FUNCTION</b>	Peak (PK)
<b>FREQUENCY RANGE</b>	1GHz ~ 40GHz		Average (AV)

**ANTENNA POLARITY & TEST DISTANCE: HORIZONTAL AT 3 M**

NO.	FREQ. (MHz)	EMISSION LEVEL (dBuV/m)	LIMIT (dBuV/m)	MARGIN (dB)	ANTENNA HEIGHT (m)	TABLE ANGLE (Degree)	RAW VALUE (dBuV)	CORRECTION FACTOR (dB/m)
1	*5825.00	121.3 PK			1.54 H	56	80.80	40.50
2	*5825.00	111.2 AV			1.54 H	56	70.70	40.50
3	#5850.00	63.6 PK	78.2	-14.6	1.09 H	39	56.70	6.90
4	#5853.00	72.8 PK	78.2	-5.4	1.37 H	39	65.80	7.00
5	#5861.00	69.5 PK	74.0	-4.5	1.29 H	57	62.50	7.00
6	#5861.00	52.4 AV	54.0	-1.6	1.29 H	57	45.40	7.00
7	11650.00	65.6 PK	74.0	-8.4	1.00 H	15	46.70	18.90
8	11650.00	52.5 AV	54.0	-1.5	1.00 H	15	33.60	18.90

**ANTENNA POLARITY & TEST DISTANCE: VERTICAL AT 3 M**

NO.	FREQ. (MHz)	EMISSION LEVEL (dBuV/m)	LIMIT (dBuV/m)	MARGIN (dB)	ANTENNA HEIGHT (m)	TABLE ANGLE (Degree)	RAW VALUE (dBuV)	CORRECTION FACTOR (dB/m)
1	*5825.00	112.6 PK			1.82 V	320	72.10	40.50
2	*5825.00	102.5 AV			1.82 V	320	62.00	40.50
3	#5850.00	55.4 PK	78.2	-22.8	2.08 V	319	48.50	6.90
4	#5853.00	63.4 PK	78.2	-14.8	2.09 V	326	56.40	7.00
5	#5861.00	63.1 PK	74.0	-10.9	2.18 V	322	56.10	7.00
6	#5861.00	47.6 AV	54.0	-6.4	2.18 V	322	40.60	7.00
7	11650.00	64.1 PK	74.0	-9.9	1.03 V	6	45.20	18.90
8	11650.00	51.3 AV	54.0	-2.7	1.03 V	6	32.40	18.90

**REMARKS:**

1. Emission Level(dBuV/m) = Raw Value(dBuV) + Correction Factor(dB/m)
2. Correction Factor(dB/m) = Antenna Factor(dB/m) + Cable Factor(dB)
3. The other emission levels were very low against the limit.
4. Margin value = Emission Level – Limit value
5. " \* ": Fundamental frequency.
6. " # ": The radiated frequency is out of the restricted band.

**802.11n (HT40)**

<b>CHANNEL</b>	TX Channel 151	<b>DETECTOR FUNCTION</b>	Peak (PK)
<b>FREQUENCY RANGE</b>	1GHz ~ 40GHz		Average (AV)

**ANTENNA POLARITY & TEST DISTANCE: HORIZONTAL AT 3 M**

NO.	FREQ. (MHz)	EMISSION LEVEL (dBuV/m)	LIMIT (dBuV/m)	MARGIN (dB)	ANTENNA HEIGHT (m)	TABLE ANGLE (Degree)	RAW VALUE (dBuV)	CORRECTION FACTOR (dB/m)
1	#5714.00	67.4 PK	74.0	-6.6	1.01 H	57	60.60	6.80
2	#5714.00	52.4 AV	54.0	-1.6	1.01 H	57	45.60	6.80
3	#5722.00	67.9 PK	78.2	-10.3	1.56 H	66	61.10	6.80
4	#5725.00	63.6 PK	78.2	-14.6	1.03 H	53	56.80	6.80
5	*5755.00	113.1 PK			1.35 H	60	72.60	40.50
6	*5755.00	103.6 AV			1.35 H	60	63.10	40.50
7	11510.00	60.1 PK	74.0	-13.9	1.72 H	48	41.80	18.30
8	11510.00	47.6 AV	54.0	-6.4	1.72 H	48	29.30	18.30

**ANTENNA POLARITY & TEST DISTANCE: VERTICAL AT 3 M**

NO.	FREQ. (MHz)	EMISSION LEVEL (dBuV/m)	LIMIT (dBuV/m)	MARGIN (dB)	ANTENNA HEIGHT (m)	TABLE ANGLE (Degree)	RAW VALUE (dBuV)	CORRECTION FACTOR (dB/m)
1	#5714.00	59.2 PK	74.0	-14.8	1.92 V	22	52.40	6.80
2	#5714.00	46.7 AV	54.0	-7.3	1.92 V	22	39.90	6.80
3	#5722.00	65.7 PK	78.2	-12.5	1.64 V	41	58.90	6.80
4	#5725.00	57.0 PK	78.2	-21.2	1.76 V	44	50.20	6.80
5	*5755.00	107.8 PK			2.08 V	34	67.30	40.50
6	*5755.00	97.4 AV			2.08 V	34	56.90	40.50
7	11510.00	59.0 PK	74.0	-15.0	1.18 V	54	40.70	18.30
8	11510.00	46.4 AV	54.0	-7.6	1.18 V	54	28.10	18.30

**REMARKS:**

1. Emission Level(dBuV/m) = Raw Value(dBuV) + Correction Factor(dB/m)
2. Correction Factor(dB/m) = Antenna Factor(dB/m) + Cable Factor(dB)
3. The other emission levels were very low against the limit.
4. Margin value = Emission Level – Limit value
5. " \* ": Fundamental frequency.
6. " # ": The radiated frequency is out of the restricted band.

<b>CHANNEL</b>	TX Channel 159	<b>DETECTOR FUNCTION</b>	Peak (PK)
<b>FREQUENCY RANGE</b>	1GHz ~ 40GHz		Average (AV)

**ANTENNA POLARITY & TEST DISTANCE: HORIZONTAL AT 3 M**

NO.	FREQ. (MHz)	EMISSION LEVEL (dBuV/m)	LIMIT (dBuV/m)	MARGIN (dB)	ANTENNA HEIGHT (m)	TABLE ANGLE (Degree)	RAW VALUE (dBuV)	CORRECTION FACTOR (dB/m)
1	*5795.00	117.2 PK			1.38 H	61	76.70	40.50
2	*5795.00	107.3 AV			1.38 H	61	66.80	40.50
3	#5850.00	58.0 PK	78.2	-20.2	1.49 H	46	51.10	6.90
4	#5853.00	66.5 PK	78.2	-11.7	1.74 H	38	59.50	7.00
5	#5861.00	67.5 PK	74.0	-6.5	2.09 H	57	60.50	7.00
6	#5861.00	52.3 AV	54.0	-1.7	2.09 H	57	45.30	7.00
7	11590.00	63.6 PK	74.0	-10.4	1.05 H	319	45.10	18.50
8	11590.00	51.2 AV	54.0	-2.8	1.05 H	319	32.70	18.50

**ANTENNA POLARITY & TEST DISTANCE: VERTICAL AT 3 M**

NO.	FREQ. (MHz)	EMISSION LEVEL (dBuV/m)	LIMIT (dBuV/m)	MARGIN (dB)	ANTENNA HEIGHT (m)	TABLE ANGLE (Degree)	RAW VALUE (dBuV)	CORRECTION FACTOR (dB/m)
1	*5795.00	107.3 PK			1.10 V	86	66.80	40.50
2	*5795.00	98.2 AV			1.10 V	86	57.70	40.50
3	#5850.00	52.4 PK	78.2	-25.8	1.15 V	87	45.50	6.90
4	#5853.00	62.3 PK	78.2	-15.9	1.23 V	77	55.30	7.00
5	#5861.00	58.4 PK	74.0	-15.6	1.36 V	56	51.40	7.00
6	#5861.00	46.3 AV	54.0	-7.7	1.36 V	56	39.30	7.00
7	11590.00	61.8 PK	74.0	-12.2	1.24 V	343	43.30	18.50
8	11590.00	49.2 AV	54.0	-4.8	1.24 V	343	30.70	18.50

**REMARKS:**

1. Emission Level(dBuV/m) = Raw Value(dBuV) + Correction Factor(dB/m)
2. Correction Factor(dB/m) = Antenna Factor(dB/m) + Cable Factor(dB)
3. The other emission levels were very low against the limit.
4. Margin value = Emission Level – Limit value
5. " \* ": Fundamental frequency.
6. " # ": The radiated frequency is out of the restricted band.

**802.11ac (VHT80)**

<b>CHANNEL</b>	TX Channel 155	<b>DETECTOR FUNCTION</b>	Peak (PK)
<b>FREQUENCY RANGE</b>	1GHz ~ 40GHz		Average (AV)

**ANTENNA POLARITY & TEST DISTANCE: HORIZONTAL AT 3 M**

NO.	FREQ. (MHz)	EMISSION LEVEL (dBuV/m)	LIMIT (dBuV/m)	MARGIN (dB)	ANTENNA HEIGHT (m)	TABLE ANGLE (Degree)	RAW VALUE (dBuV)	CORRECTION FACTOR (dB/m)
1	#5714.00	66.8 PK	74.0	-7.2	1.18 H	45	60.00	6.80
2	#5714.00	52.8 AV	54.0	-1.2	1.18 H	45	46.00	6.80
3	#5722.00	71.9 PK	78.2	-6.3	1.35 H	67	65.10	6.80
4	#5725.00	65.3 PK	78.2	-12.9	1.59 H	58	58.50	6.80
5	*5775.00	105.0 PK			1.59 H	46	64.50	40.50
6	*5775.00	95.8 AV			1.59 H	46	55.30	40.50
7	#5850.00	49.2 PK	78.2	-29.0	1.30 H	63	42.30	6.90
8	#5853.00	58.4 PK	78.2	-19.8	1.45 H	46	51.40	7.00
9	#5861.00	58.5 PK	74.0	-15.5	1.54 H	57	51.50	7.00
10	#5861.00	46.7 AV	54.0	-7.3	1.54 H	57	39.70	7.00
11	11550.00	58.1 PK	74.0	-15.9	1.34 H	52	39.70	18.40
12	11550.00	44.9 AV	54.0	-9.1	1.34 H	52	26.50	18.40

**ANTENNA POLARITY & TEST DISTANCE: VERTICAL AT 3 M**

NO.	FREQ. (MHz)	EMISSION LEVEL (dBuV/m)	LIMIT (dBuV/m)	MARGIN (dB)	ANTENNA HEIGHT (m)	TABLE ANGLE (Degree)	RAW VALUE (dBuV)	CORRECTION FACTOR (dB/m)
1	#5714.00	57.6 PK	74.0	-16.4	1.19 V	67	50.80	6.80
2	#5714.00	46.1 AV	54.0	-7.9	1.19 V	67	39.30	6.80
3	#5722.00	67.5 PK	78.2	-10.7	1.91 V	63	60.70	6.80
4	#5725.00	59.1 PK	78.2	-19.1	1.93 V	57	52.30	6.80
5	*5775.00	98.3 PK			1.10 V	46	57.80	40.50
6	*5775.00	87.9 AV			1.10 V	46	47.40	40.50
7	#5850.00	49.7 PK	78.2	-28.5	1.67 V	33	42.80	6.90
8	#5853.00	57.6 PK	78.2	-20.6	1.46 V	18	50.60	7.00
9	#5861.00	57.1 PK	74.0	-16.9	1.28 V	49	50.10	7.00
10	#5861.00	44.7 AV	54.0	-9.3	1.28 V	49	37.70	7.00
11	11550.00	57.6 PK	74.0	-16.4	1.07 V	94	39.20	18.40
12	11550.00	45.2 AV	54.0	-8.8	1.07 V	94	26.80	18.40

**REMARKS:**

1. Emission Level(dBuV/m) = Raw Value(dBuV) + Correction Factor(dB/m)
2. Correction Factor(dB/m) = Antenna Factor(dB/m) + Cable Factor(dB)
3. The other emission levels were very low against the limit.
4. Margin value = Emission Level – Limit value
5. " \* ": Fundamental frequency.
6. " # ": The radiated frequency is out of the restricted band.

**Test Mode C**
**802.11a**

<b>CHANNEL</b>	TX Channel 36	<b>DETECTOR FUNCTION</b>	Peak (PK)
<b>FREQUENCY RANGE</b>	1GHz ~ 40GHz		Average (AV)

**ANTENNA POLARITY & TEST DISTANCE: HORIZONTAL AT 3 M**

NO.	FREQ. (MHz)	EMISSION LEVEL (dBuV/m)	LIMIT (dBuV/m)	MARGIN (dB)	ANTENNA HEIGHT (m)	TABLE ANGLE (Degree)	RAW VALUE (dBuV)	CORRECTION FACTOR (dB/m)
1	5150.00	57.3 PK	74.0	-16.7	1.78 H	19	51.30	6.00
2	5150.00	46.1 AV	54.0	-7.9	1.78 H	19	40.10	6.00
3	*5180.00	102.0 PK			1.00 H	29	62.50	39.50
4	*5180.00	92.2 AV			1.00 H	29	52.70	39.50
5	#10360.00	60.4 PK	74.0	-13.6	1.26 H	139	42.00	18.40
6	#10360.00	46.9 AV	54.0	-7.1	1.26 H	139	28.50	18.40

**ANTENNA POLARITY & TEST DISTANCE: VERTICAL AT 3 M**

NO.	FREQ. (MHz)	EMISSION LEVEL (dBuV/m)	LIMIT (dBuV/m)	MARGIN (dB)	ANTENNA HEIGHT (m)	TABLE ANGLE (Degree)	RAW VALUE (dBuV)	CORRECTION FACTOR (dB/m)
1	5150.00	68.5 PK	74.0	-5.5	1.61 V	115	62.50	6.00
2	5150.00	52.2 AV	54.0	-1.8	1.61 V	115	46.20	6.00
3	*5180.00	120.0 PK			1.70 V	55	80.50	39.50
4	*5180.00	109.6 AV			1.70 V	55	70.10	39.50
5	#10360.00	60.9 PK	74.0	-13.1	1.50 V	45	42.50	18.40
6	#10360.00	47.7 AV	54.0	-6.3	1.50 V	45	29.30	18.40

**REMARKS:**

1. Emission Level(dBuV/m) = Raw Value(dBuV) + Correction Factor(dB/m)
2. Correction Factor(dB/m) = Antenna Factor(dB/m) + Cable Factor(dB)
3. The other emission levels were very low against the limit.
4. Margin value = Emission Level – Limit value
5. " \* ": Fundamental frequency.
6. " # ": The radiated frequency is out of the restricted band.

<b>CHANNEL</b>	TX Channel 40	<b>DETECTOR FUNCTION</b>	Peak (PK)
<b>FREQUENCY RANGE</b>	1GHz ~ 40GHz		Average (AV)

**ANTENNA POLARITY & TEST DISTANCE: HORIZONTAL AT 3 M**

NO.	FREQ. (MHz)	EMISSION LEVEL (dBuV/m)	LIMIT (dBuV/m)	MARGIN (dB)	ANTENNA HEIGHT (m)	TABLE ANGLE (Degree)	RAW VALUE (dBuV)	CORRECTION FACTOR (dB/m)
1	5150.00	58.3 PK	74.0	-15.7	1.31 H	303	52.30	6.00
2	5150.00	47.0 AV	54.0	-7.0	1.31 H	303	41.00	6.00
3	*5200.00	106.8 PK			1.26 H	23	67.20	39.60
4	*5200.00	96.2 AV			1.26 H	23	56.60	39.60
5	#10400.00	61.9 PK	74.0	-12.1	1.00 H	60	43.40	18.50
6	#10400.00	49.0 AV	54.0	-5.0	1.00 H	60	30.50	18.50

**ANTENNA POLARITY & TEST DISTANCE: VERTICAL AT 3 M**

NO.	FREQ. (MHz)	EMISSION LEVEL (dBuV/m)	LIMIT (dBuV/m)	MARGIN (dB)	ANTENNA HEIGHT (m)	TABLE ANGLE (Degree)	RAW VALUE (dBuV)	CORRECTION FACTOR (dB/m)
1	5150.00	70.7 PK	74.0	-3.3	1.68 V	53	64.70	6.00
2	5150.00	52.8 AV	54.0	-1.2	1.68 V	53	46.80	6.00
3	*5200.00	124.7 PK			1.71 V	44	85.10	39.60
4	*5200.00	114.3 AV			1.71 V	44	74.70	39.60
5	#10400.00	61.6 PK	74.0	-12.4	1.53 V	130	43.10	18.50
6	#10400.00	48.4 AV	54.0	-5.6	1.53 V	130	29.90	18.50

**REMARKS:**

1. Emission Level(dBuV/m) = Raw Value(dBuV) + Correction Factor(dB/m)
2. Correction Factor(dB/m) = Antenna Factor(dB/m) + Cable Factor(dB)
3. The other emission levels were very low against the limit.
4. Margin value = Emission Level – Limit value
5. " \* ": Fundamental frequency.
6. " # ": The radiated frequency is out of the restricted band.

<b>CHANNEL</b>	TX Channel 48	<b>DETECTOR FUNCTION</b>	Peak (PK)
<b>FREQUENCY RANGE</b>	1GHz ~ 40GHz		Average (AV)

**ANTENNA POLARITY & TEST DISTANCE: HORIZONTAL AT 3 M**

NO.	FREQ. (MHz)	EMISSION LEVEL (dBuV/m)	LIMIT (dBuV/m)	MARGIN (dB)	ANTENNA HEIGHT (m)	TABLE ANGLE (Degree)	RAW VALUE (dBuV)	CORRECTION FACTOR (dB/m)
1	*5240.00	107.7 PK			1.00 H	33	68.10	39.60
2	*5240.00	98.2 AV			1.00 H	33	58.60	39.60
3	5350.00	56.6 PK	74.0	-17.4	1.34 H	19	50.50	6.10
4	5350.00	45.7 AV	54.0	-8.3	1.34 H	19	39.60	6.10
5	#10480.00	61.8 PK	74.0	-12.2	1.32 H	39	42.80	19.00
6	#10480.00	48.8 AV	54.0	-5.2	1.32 H	39	29.80	19.00
7	15720.00	63.5 PK	74.0	-10.5	1.26 H	195	45.00	18.50
8	15720.00	50.8 AV	54.0	-3.2	1.26 H	195	32.30	18.50

**ANTENNA POLARITY & TEST DISTANCE: VERTICAL AT 3 M**

NO.	FREQ. (MHz)	EMISSION LEVEL (dBuV/m)	LIMIT (dBuV/m)	MARGIN (dB)	ANTENNA HEIGHT (m)	TABLE ANGLE (Degree)	RAW VALUE (dBuV)	CORRECTION FACTOR (dB/m)
1	*5240.00	126.8 PK			1.73 V	41	87.20	39.60
2	*5240.00	116.3 AV			1.73 V	41	76.70	39.60
3	5350.00	61.0 PK	74.0	-13.0	1.71 V	38	54.90	6.10
4	5350.00	49.1 AV	54.0	-4.9	1.71 V	38	43.00	6.10
5	#10480.00	61.6 PK	74.0	-12.4	1.39 V	266	42.60	19.00
6	#10480.00	49.6 AV	54.0	-4.4	1.39 V	266	30.60	19.00
7	15720.00	65.1 PK	74.0	-8.9	1.69 V	202	46.60	18.50
8	15720.00	52.3 AV	54.0	-1.7	1.69 V	202	33.80	18.50

**REMARKS:**

1. Emission Level(dBuV/m) = Raw Value(dBuV) + Correction Factor(dB/m)
2. Correction Factor(dB/m) = Antenna Factor(dB/m) + Cable Factor(dB)
3. The other emission levels were very low against the limit.
4. Margin value = Emission Level – Limit value
5. " \* ": Fundamental frequency.
6. " # ": The radiated frequency is out of the restricted band.



802.11n (HT20)

<b>CHANNEL</b>	TX Channel 36	<b>DETECTOR FUNCTION</b>	Peak (PK)
<b>FREQUENCY RANGE</b>	1GHz ~ 40GHz		Average (AV)

**ANTENNA POLARITY & TEST DISTANCE: HORIZONTAL AT 3 M**

NO.	FREQ. (MHz)	EMISSION LEVEL (dBuV/m)	LIMIT (dBuV/m)	MARGIN (dB)	ANTENNA HEIGHT (m)	TABLE ANGLE (Degree)	RAW VALUE (dBuV)	CORRECTION FACTOR (dB/m)
1	5150.00	56.4 PK	74.0	-17.6	1.76 H	44	50.40	6.00
2	5150.00	45.5 AV	54.0	-8.5	1.76 H	44	39.50	6.00
3	*5180.00	101.4 PK			1.00 H	29	61.90	39.50
4	*5180.00	91.3 AV			1.00 H	29	51.80	39.50
5	#10360.00	60.8 PK	74.0	-13.2	1.00 H	56	42.40	18.40
6	#10360.00	47.6 AV	54.0	-6.4	1.00 H	56	29.20	18.40

**ANTENNA POLARITY & TEST DISTANCE: VERTICAL AT 3 M**

NO.	FREQ. (MHz)	EMISSION LEVEL (dBuV/m)	LIMIT (dBuV/m)	MARGIN (dB)	ANTENNA HEIGHT (m)	TABLE ANGLE (Degree)	RAW VALUE (dBuV)	CORRECTION FACTOR (dB/m)
1	5150.00	67.6 PK	74.0	-6.4	1.78 V	195	61.60	6.00
2	5150.00	52.9 AV	54.0	-1.1	1.78 V	195	46.90	6.00
3	*5180.00	118.6 PK			1.70 V	50	79.10	39.50
4	*5180.00	108.1 AV			1.70 V	50	68.60	39.50
5	#10360.00	61.1 PK	74.0	-12.9	1.50 V	55	42.70	18.40
6	#10360.00	48.0 AV	54.0	-6.0	1.50 V	55	29.60	18.40

**REMARKS:**

1. Emission Level(dBuV/m) = Raw Value(dBuV) + Correction Factor(dB/m)
2. Correction Factor(dB/m) = Antenna Factor(dB/m) + Cable Factor(dB)
3. The other emission levels were very low against the limit.
4. Margin value = Emission Level – Limit value
5. " \* ": Fundamental frequency.
6. " # ": The radiated frequency is out of the restricted band.

<b>CHANNEL</b>	TX Channel 40	<b>DETECTOR FUNCTION</b>	Peak (PK)
<b>FREQUENCY RANGE</b>	1GHz ~ 40GHz		Average (AV)

**ANTENNA POLARITY & TEST DISTANCE: HORIZONTAL AT 3 M**

NO.	FREQ. (MHz)	EMISSION LEVEL (dBuV/m)	LIMIT (dBuV/m)	MARGIN (dB)	ANTENNA HEIGHT (m)	TABLE ANGLE (Degree)	RAW VALUE (dBuV)	CORRECTION FACTOR (dB/m)
1	5150.00	59.0 PK	74.0	-15.0	1.50 H	184	53.00	6.00
2	5150.00	47.4 AV	54.0	-6.6	1.50 H	184	41.40	6.00
3	*5200.00	105.6 PK			2.11 H	43	66.00	39.60
4	*5200.00	94.8 AV			2.11 H	43	55.20	39.60
5	#10400.00	61.3 PK	74.0	-12.7	1.24 H	26	42.80	18.50
6	#10400.00	48.2 AV	54.0	-5.8	1.24 H	26	29.70	18.50

**ANTENNA POLARITY & TEST DISTANCE: VERTICAL AT 3 M**

NO.	FREQ. (MHz)	EMISSION LEVEL (dBuV/m)	LIMIT (dBuV/m)	MARGIN (dB)	ANTENNA HEIGHT (m)	TABLE ANGLE (Degree)	RAW VALUE (dBuV)	CORRECTION FACTOR (dB/m)
1	5150.00	68.5 PK	74.0	-5.5	1.71 V	50	62.50	6.00
2	5150.00	52.6 AV	54.0	-1.4	1.71 V	50	46.60	6.00
3	*5200.00	124.2 PK			1.61 V	31	84.60	39.60
4	*5200.00	113.7 AV			1.61 V	31	74.10	39.60
5	#10400.00	62.3 PK	74.0	-11.7	1.64 V	256	43.80	18.50
6	#10400.00	49.2 AV	54.0	-4.8	1.64 V	256	30.70	18.50

**REMARKS:**

1. Emission Level(dBuV/m) = Raw Value(dBuV) + Correction Factor(dB/m)
2. Correction Factor(dB/m) = Antenna Factor(dB/m) + Cable Factor(dB)
3. The other emission levels were very low against the limit.
4. Margin value = Emission Level – Limit value
5. " \* ": Fundamental frequency.
6. " # ": The radiated frequency is out of the restricted band.



<b>CHANNEL</b>	TX Channel 48	<b>DETECTOR FUNCTION</b>	Peak (PK)
<b>FREQUENCY RANGE</b>	1GHz ~ 40GHz		Average (AV)

**ANTENNA POLARITY & TEST DISTANCE: HORIZONTAL AT 3 M**

NO.	FREQ. (MHz)	EMISSION LEVEL (dBuV/m)	LIMIT (dBuV/m)	MARGIN (dB)	ANTENNA HEIGHT (m)	TABLE ANGLE (Degree)	RAW VALUE (dBuV)	CORRECTION FACTOR (dB/m)
1	*5240.00	108.9 PK			1.24 H	29	69.30	39.60
2	*5240.00	98.4 AV			1.24 H	29	58.80	39.60
3	5350.00	58.0 PK	74.0	-16.0	1.20 H	39	51.90	6.10
4	5350.00	46.5 AV	54.0	-7.5	1.20 H	39	40.40	6.10
5	#10480.00	61.3 PK	74.0	-12.7	1.39 H	59	42.30	19.00
6	#10480.00	48.1 AV	54.0	-5.9	1.39 H	59	29.10	19.00
7	15720.00	63.5 PK	74.0	-10.5	1.03 H	60	45.00	18.50
8	15720.00	50.8 AV	54.0	-3.2	1.03 H	60	32.30	18.50

**ANTENNA POLARITY & TEST DISTANCE: VERTICAL AT 3 M**

NO.	FREQ. (MHz)	EMISSION LEVEL (dBuV/m)	LIMIT (dBuV/m)	MARGIN (dB)	ANTENNA HEIGHT (m)	TABLE ANGLE (Degree)	RAW VALUE (dBuV)	CORRECTION FACTOR (dB/m)
1	*5240.00	126.1 PK			1.74 V	45	86.50	39.60
2	*5240.00	115.6 AV			1.74 V	45	76.00	39.60
3	5350.00	60.2 PK	74.0	-13.8	1.68 V	20	54.10	6.10
4	5350.00	49.1 AV	54.0	-4.9	1.68 V	20	43.00	6.10
5	#10480.00	62.0 PK	74.0	-12.0	1.56 V	19	43.00	19.00
6	#10480.00	48.9 AV	54.0	-5.1	1.56 V	19	29.90	19.00
7	15720.00	64.8 PK	74.0	-9.2	1.64 V	227	46.30	18.50
8	15720.00	52.1 AV	54.0	-1.9	1.64 V	227	33.60	18.50

**REMARKS:**

1. Emission Level(dBuV/m) = Raw Value(dBuV) + Correction Factor(dB/m)
2. Correction Factor(dB/m) = Antenna Factor(dB/m) + Cable Factor(dB)
3. The other emission levels were very low against the limit.
4. Margin value = Emission Level – Limit value
5. " \* ": Fundamental frequency.
6. " # ": The radiated frequency is out of the restricted band.

802.11n (HT40)

<b>CHANNEL</b>	TX Channel 38	<b>DETECTOR FUNCTION</b>	Peak (PK)
<b>FREQUENCY RANGE</b>	1GHz ~ 40GHz		Average (AV)

ANTENNA POLARITY & TEST DISTANCE: HORIZONTAL AT 3 M								
NO.	FREQ. (MHz)	EMISSION LEVEL (dBuV/m)	LIMIT (dBuV/m)	MARGIN (dB)	ANTENNA HEIGHT (m)	TABLE ANGLE (Degree)	RAW VALUE (dBuV)	CORRECTION FACTOR (dB/m)
1	5150.00	56.9 PK	74.0	-17.1	1.00 H	62	50.90	6.00
2	5150.00	45.9 AV	54.0	-8.1	1.00 H	62	39.90	6.00
3	*5190.00	94.3 PK			1.00 H	62	54.80	39.50
4	*5190.00	84.8 AV			1.00 H	62	45.30	39.50
5	#10380.00	60.3 PK	74.0	-13.7	1.27 H	194	41.80	18.50
6	#10380.00	47.2 AV	54.0	-6.8	1.27 H	194	28.70	18.50

ANTENNA POLARITY & TEST DISTANCE: VERTICAL AT 3 M								
NO.	FREQ. (MHz)	EMISSION LEVEL (dBuV/m)	LIMIT (dBuV/m)	MARGIN (dB)	ANTENNA HEIGHT (m)	TABLE ANGLE (Degree)	RAW VALUE (dBuV)	CORRECTION FACTOR (dB/m)
1	5150.00	68.5 PK	74.0	-5.5	1.69 V	42	62.50	6.00
2	5150.00	52.9 AV	54.0	-1.1	1.69 V	42	46.90	6.00
3	*5190.00	112.5 PK			1.68 V	31	73.00	39.50
4	*5190.00	102.0 AV			1.68 V	31	62.50	39.50
5	#10380.00	60.5 PK	74.0	-13.5	1.69 V	74	42.00	18.50
6	#10380.00	47.5 AV	54.0	-6.5	1.69 V	74	29.00	18.50

**REMARKS:**

1. Emission Level(dBuV/m) = Raw Value(dBuV) + Correction Factor(dB/m)
2. Correction Factor(dB/m) = Antenna Factor(dB/m) + Cable Factor(dB)
3. The other emission levels were very low against the limit.
4. Margin value = Emission Level – Limit value
5. " \* ": Fundamental frequency.
6. " # ": The radiated frequency is out of the restricted band.

<b>CHANNEL</b>	TX Channel 46	<b>DETECTOR FUNCTION</b>	Peak (PK)
<b>FREQUENCY RANGE</b>	1GHz ~ 40GHz		Average (AV)

**ANTENNA POLARITY & TEST DISTANCE: HORIZONTAL AT 3 M**

NO.	FREQ. (MHz)	EMISSION LEVEL (dBuV/m)	LIMIT (dBuV/m)	MARGIN (dB)	ANTENNA HEIGHT (m)	TABLE ANGLE (Degree)	RAW VALUE (dBuV)	CORRECTION FACTOR (dB/m)
1	5150.00	57.6 PK	74.0	-16.4	1.03 H	50	51.60	6.00
2	5150.00	46.2 AV	54.0	-7.8	1.03 H	50	40.20	6.00
3	*5230.00	102.7 PK			1.00 H	31	63.10	39.60
4	*5230.00	91.8 AV			1.00 H	31	52.20	39.60
5	#10460.00	60.8 PK	74.0	-13.2	1.21 H	190	41.90	18.90
6	#10460.00	47.7 AV	54.0	-6.3	1.21 H	190	28.80	18.90

**ANTENNA POLARITY & TEST DISTANCE: VERTICAL AT 3 M**

NO.	FREQ. (MHz)	EMISSION LEVEL (dBuV/m)	LIMIT (dBuV/m)	MARGIN (dB)	ANTENNA HEIGHT (m)	TABLE ANGLE (Degree)	RAW VALUE (dBuV)	CORRECTION FACTOR (dB/m)
1	5150.00	67.6 PK	74.0	-6.4	1.73 V	85	61.60	6.00
2	5150.00	52.6 AV	54.0	-1.4	1.73 V	85	46.60	6.00
3	*5230.00	120.9 PK			1.65 V	15	81.30	39.60
4	*5230.00	110.3 AV			1.65 V	15	70.70	39.60
5	#10460.00	61.4 PK	74.0	-12.6	1.59 V	101	42.50	18.90
6	#10460.00	48.4 AV	54.0	-5.6	1.59 V	101	29.50	18.90

**REMARKS:**

1. Emission Level(dBuV/m) = Raw Value(dBuV) + Correction Factor(dB/m)
2. Correction Factor(dB/m) = Antenna Factor(dB/m) + Cable Factor(dB)
3. The other emission levels were very low against the limit.
4. Margin value = Emission Level – Limit value
5. " \* ": Fundamental frequency.
6. " # ": The radiated frequency is out of the restricted band.

802.11ac (VHT80)

<b>CHANNEL</b>	TX Channel 42	<b>DETECTOR FUNCTION</b>	Peak (PK)
<b>FREQUENCY RANGE</b>	1GHz ~ 40GHz		Average (AV)

**ANTENNA POLARITY & TEST DISTANCE: HORIZONTAL AT 3 M**

NO.	FREQ. (MHz)	EMISSION LEVEL (dBuV/m)	LIMIT (dBuV/m)	MARGIN (dB)	ANTENNA HEIGHT (m)	TABLE ANGLE (Degree)	RAW VALUE (dBuV)	CORRECTION FACTOR (dB/m)
1	5150.00	56.7 PK	74.0	-17.3	1.15 H	60	50.70	6.00
2	5150.00	45.5 AV	54.0	-8.5	1.15 H	60	39.50	6.00
3	*5210.00	87.9 PK			1.14 H	59	48.30	39.60
4	*5210.00	81.3 AV			1.14 H	59	41.70	39.60
5	#10420.00	60.4 PK	74.0	-13.6	1.13 H	52	41.80	18.60
6	#10420.00	47.3 AV	54.0	-6.7	1.13 H	52	28.70	18.60

**ANTENNA POLARITY & TEST DISTANCE: VERTICAL AT 3 M**

NO.	FREQ. (MHz)	EMISSION LEVEL (dBuV/m)	LIMIT (dBuV/m)	MARGIN (dB)	ANTENNA HEIGHT (m)	TABLE ANGLE (Degree)	RAW VALUE (dBuV)	CORRECTION FACTOR (dB/m)
1	5150.00	66.9 PK	74.0	-7.1	1.68 V	0	60.90	6.00
2	5150.00	52.8 AV	54.0	-1.2	1.68 V	0	46.80	6.00
3	*5210.00	106.8 PK			1.80 V	51	67.20	39.60
4	*5210.00	100.1 AV			1.80 V	51	60.50	39.60
5	#10420.00	60.8 PK	74.0	-13.2	1.60 V	22	42.20	18.60
6	#10420.00	47.5 AV	54.0	-6.5	1.60 V	22	28.90	18.60

**REMARKS:**

1. Emission Level(dBuV/m) = Raw Value(dBuV) + Correction Factor(dB/m)
2. Correction Factor(dB/m) = Antenna Factor(dB/m) + Cable Factor(dB)
3. The other emission levels were very low against the limit.
4. Margin value = Emission Level – Limit value
5. " \* ": Fundamental frequency.
6. " # ": The radiated frequency is out of the restricted band.

**802.11a**

<b>CHANNEL</b>	TX Channel 149	<b>DETECTOR FUNCTION</b>	Peak (PK)
<b>FREQUENCY RANGE</b>	1GHz ~ 40GHz		Average (AV)

<b>ANTENNA POLARITY &amp; TEST DISTANCE: HORIZONTAL AT 3 M</b>								
<b>NO.</b>	<b>FREQ. (MHz)</b>	<b>EMISSION LEVEL (dBuV/m)</b>	<b>LIMIT (dBuV/m)</b>	<b>MARGIN (dB)</b>	<b>ANTENNA HEIGHT (m)</b>	<b>TABLE ANGLE (Degree)</b>	<b>RAW VALUE (dBuV)</b>	<b>CORRECTION FACTOR (dB/m)</b>
1	#5714.00	50.6 PK	74.0	-23.4	1.10 H	81	43.80	6.80
2	#5714.00	36.6 AV	54.0	-17.4	1.10 H	81	29.80	6.80
3	#5722.00	64.3 PK	78.2	-13.9	1.11 H	88	57.50	6.80
4	#5725.00	63.3 PK	78.2	-14.9	1.11 H	88	56.50	6.80
5	*5745.00	107.2 PK			1.10 H	7	66.80	40.40
6	*5745.00	97.1 AV			1.10 H	7	56.70	40.40
7	11490.00	60.9 PK	74.0	-13.1	1.23 H	180	42.50	18.40
8	11490.00	47.7 AV	54.0	-6.3	1.23 H	180	29.30	18.40
<b>ANTENNA POLARITY &amp; TEST DISTANCE: VERTICAL AT 3 M</b>								
<b>NO.</b>	<b>FREQ. (MHz)</b>	<b>EMISSION LEVEL (dBuV/m)</b>	<b>LIMIT (dBuV/m)</b>	<b>MARGIN (dB)</b>	<b>ANTENNA HEIGHT (m)</b>	<b>TABLE ANGLE (Degree)</b>	<b>RAW VALUE (dBuV)</b>	<b>CORRECTION FACTOR (dB/m)</b>
1	#5715.00	70.1 PK	74.0	-3.9	1.65 V	50	63.30	6.80
2	#5715.00	52.6 AV	54.0	-1.4	1.65 V	50	45.80	6.80
3	#5722.00	76.3 PK	78.2	-1.9	1.79 V	53	69.50	6.80
4	#5725.00	66.8 PK	78.2	-11.4	1.79 V	53	60.00	6.80
5	*5745.00	117.7 PK			1.71 V	50	77.30	40.40
6	*5745.00	107.8 AV			1.71 V	50	67.40	40.40
7	11490.00	62.2 PK	74.0	-11.8	1.66 V	171	43.80	18.40
8	11490.00	49.1 AV	54.0	-4.9	1.66 V	171	30.70	18.40

**REMARKS:**

1. Emission Level(dBuV/m) = Raw Value(dBuV) + Correction Factor(dB/m)
2. Correction Factor(dB/m) = Antenna Factor(dB/m) + Cable Factor(dB)
3. The other emission levels were very low against the limit.
4. Margin value = Emission Level – Limit value
5. " \* ": Fundamental frequency.
6. " # ": The radiated frequency is out of the restricted band.

<b>CHANNEL</b>	TX Channel 157	<b>DETECTOR FUNCTION</b>	Peak (PK)
<b>FREQUENCY RANGE</b>	1GHz ~ 40GHz		Average (AV)

**ANTENNA POLARITY & TEST DISTANCE: HORIZONTAL AT 3 M**

NO.	FREQ. (MHz)	EMISSION LEVEL (dBuV/m)	LIMIT (dBuV/m)	MARGIN (dB)	ANTENNA HEIGHT (m)	TABLE ANGLE (Degree)	RAW VALUE (dBuV)	CORRECTION FACTOR (dB/m)
1	*5785.00	113.2 PK			1.35 H	75	72.70	40.50
2	*5785.00	102.4 AV			1.35 H	75	61.90	40.50
3	11570.00	60.8 PK	74.0	-13.2	1.14 H	70	42.40	18.40
4	11570.00	47.6 AV	54.0	-6.4	1.14 H	70	29.20	18.40

**ANTENNA POLARITY & TEST DISTANCE: VERTICAL AT 3 M**

NO.	FREQ. (MHz)	EMISSION LEVEL (dBuV/m)	LIMIT (dBuV/m)	MARGIN (dB)	ANTENNA HEIGHT (m)	TABLE ANGLE (Degree)	RAW VALUE (dBuV)	CORRECTION FACTOR (dB/m)
1	*5785.00	123.7 PK			1.75 V	54	83.20	40.50
2	*5785.00	113.1 AV			1.75 V	54	72.60	40.50
3	11570.00	62.9 PK	74.0	-11.1	1.26 V	84	44.50	18.40
4	11570.00	50.0 AV	54.0	-4.0	1.26 V	84	31.60	18.40

**REMARKS:**

1. Emission Level(dBuV/m) = Raw Value(dBuV) + Correction Factor(dB/m)
2. Correction Factor(dB/m) = Antenna Factor(dB/m) + Cable Factor(dB)
3. The other emission levels were very low against the limit.
4. Margin value = Emission Level – Limit value
5. " \* ": Fundamental frequency.





<b>CHANNEL</b>	TX Channel 165	<b>DETECTOR FUNCTION</b>	Peak (PK)
<b>FREQUENCY RANGE</b>	1GHz ~ 40GHz		Average (AV)

**ANTENNA POLARITY & TEST DISTANCE: HORIZONTAL AT 3 M**

NO.	FREQ. (MHz)	EMISSION LEVEL (dBuV/m)	LIMIT (dBuV/m)	MARGIN (dB)	ANTENNA HEIGHT (m)	TABLE ANGLE (Degree)	RAW VALUE (dBuV)	CORRECTION FACTOR (dB/m)
1	*5825.00	107.7 PK			1.27 H	41	67.20	40.50
2	*5825.00	97.3 AV			1.27 H	41	56.80	40.50
3	#5850.00	57.2 PK	78.2	-21.0	1.33 H	82	50.30	6.90
4	#5853.00	63.6 PK	78.2	-14.6	1.33 H	82	56.60	7.00
5	#5861.00	59.2 PK	74.0	-14.8	1.30 H	50	52.20	7.00
6	#5861.00	47.9 AV	54.0	-6.1	1.30 H	50	40.90	7.00
7	11650.00	61.5 PK	74.0	-12.5	1.42 H	198	42.60	18.90
8	11650.00	48.4 AV	54.0	-5.6	1.42 H	198	29.50	18.90

**ANTENNA POLARITY & TEST DISTANCE: VERTICAL AT 3 M**

NO.	FREQ. (MHz)	EMISSION LEVEL (dBuV/m)	LIMIT (dBuV/m)	MARGIN (dB)	ANTENNA HEIGHT (m)	TABLE ANGLE (Degree)	RAW VALUE (dBuV)	CORRECTION FACTOR (dB/m)
1	*5825.00	118.6 PK			1.74 V	51	78.10	40.50
2	*5825.00	108.8 PK			1.74 V	51	68.30	40.50
3	#5850.00	63.4 PK	78.2	-14.8	1.91 V	30	56.50	6.90
4	#5853.00	73.2 PK	78.2	-5.0	1.91 V	30	66.20	7.00
5	#5861.00	69.0 PK	74.0	-5.0	1.79 V	70	62.00	7.00
6	#5861.00	52.7 AV	54.0	-1.3	1.79 V	70	45.70	7.00
7	11650.00	63.6 PK	74.0	-10.4	1.38 V	43	44.70	18.90
8	11650.00	49.1 AV	54.0	-4.9	1.38 V	43	30.20	18.90

**REMARKS:**

1. Emission Level(dBuV/m) = Raw Value(dBuV) + Correction Factor(dB/m)
2. Correction Factor(dB/m) = Antenna Factor(dB/m) + Cable Factor(dB)
3. The other emission levels were very low against the limit.
4. Margin value = Emission Level – Limit value
5. " \* ": Fundamental frequency.
6. " # ": The radiated frequency is out of the restricted band.

**802.11n (HT20)**

<b>CHANNEL</b>	TX Channel 149	<b>DETECTOR FUNCTION</b>	Peak (PK)
<b>FREQUENCY RANGE</b>	1GHz ~ 40GHz		Average (AV)

**ANTENNA POLARITY & TEST DISTANCE: HORIZONTAL AT 3 M**

NO.	FREQ. (MHz)	EMISSION LEVEL (dBuV/m)	LIMIT (dBuV/m)	MARGIN (dB)	ANTENNA HEIGHT (m)	TABLE ANGLE (Degree)	RAW VALUE (dBuV)	CORRECTION FACTOR (dB/m)
1	#5714.00	58.9 PK	74.0	-15.1	1.50 H	70	52.10	6.80
2	#5714.00	47.7 AV	54.0	-6.3	1.50 H	70	40.90	6.80
3	#5722.00	66.8 PK	78.2	-11.4	1.52 H	62	60.00	6.80
4	#5725.00	62.6 PK	78.2	-15.6	1.52 H	62	55.80	6.80
5	*5745.00	105.0 PK			1.03 H	58	64.60	40.40
6	*5745.00	95.1 AV			1.03 H	58	54.70	40.40
7	11490.00	60.4 PK	74.0	-13.6	1.30 H	98	42.00	18.40
8	11490.00	47.2 AV	54.0	-6.8	1.30 H	98	28.80	18.40

**ANTENNA POLARITY & TEST DISTANCE: VERTICAL AT 3 M**

NO.	FREQ. (MHz)	EMISSION LEVEL (dBuV/m)	LIMIT (dBuV/m)	MARGIN (dB)	ANTENNA HEIGHT (m)	TABLE ANGLE (Degree)	RAW VALUE (dBuV)	CORRECTION FACTOR (dB/m)
1	#5714.00	68.5 PK	74.0	-5.5	1.79 V	117	61.70	6.80
2	#5714.00	52.8 AV	54.0	-1.2	1.79 V	117	46.00	6.80
3	#5722.00	70.3 PK	78.2	-7.9	1.79 V	72	63.50	6.80
4	#5725.00	66.9 PK	78.2	-11.3	1.79 V	72	60.10	6.80
5	*5745.00	116.1 PK			1.69 V	53	75.70	40.40
6	*5745.00	106.0 AV			1.69 V	53	65.60	40.40
7	11490.00	60.7 PK	74.0	-13.3	1.58 V	298	42.30	18.40
8	11490.00	47.6 AV	54.0	-6.4	1.58 V	298	29.20	18.40

**REMARKS:**

1. Emission Level(dBuV/m) = Raw Value(dBuV) + Correction Factor(dB/m)
2. Correction Factor(dB/m) = Antenna Factor(dB/m) + Cable Factor(dB)
3. The other emission levels were very low against the limit.
4. Margin value = Emission Level – Limit value
5. " \* ": Fundamental frequency.
6. " # ": The radiated frequency is out of the restricted band.

<b>CHANNEL</b>	TX Channel 157	<b>DETECTOR FUNCTION</b>	Peak (PK)
<b>FREQUENCY RANGE</b>	1GHz ~ 40GHz		Average (AV)

**ANTENNA POLARITY & TEST DISTANCE: HORIZONTAL AT 3 M**

NO.	FREQ. (MHz)	EMISSION LEVEL (dBuV/m)	LIMIT (dBuV/m)	MARGIN (dB)	ANTENNA HEIGHT (m)	TABLE ANGLE (Degree)	RAW VALUE (dBuV)	CORRECTION FACTOR (dB/m)
1	*5785.00	114.9 PK			1.51 H	40	74.40	40.50
2	*5785.00	104.2 AV			1.51 H	40	63.70	40.50
3	11570.00	60.6 PK	74.0	-13.4	1.47 H	315	42.20	18.40
4	11570.00	47.8 AV	54.0	-6.2	1.47 H	315	29.40	18.40

**ANTENNA POLARITY & TEST DISTANCE: VERTICAL AT 3 M**

NO.	FREQ. (MHz)	EMISSION LEVEL (dBuV/m)	LIMIT (dBuV/m)	MARGIN (dB)	ANTENNA HEIGHT (m)	TABLE ANGLE (Degree)	RAW VALUE (dBuV)	CORRECTION FACTOR (dB/m)
1	*5785.00	122.8 PK			1.79 V	76	82.30	40.50
2	*5785.00	112.7 AV			1.79 V	76	72.20	40.50
3	11570.00	62.9 PK	74.0	-11.1	2.59 V	135	44.50	18.40
4	11570.00	49.8 AV	54.0	-4.2	2.59 V	135	31.40	18.40

**REMARKS:**

1. Emission Level(dBuV/m) = Raw Value(dBuV) + Correction Factor(dB/m)
2. Correction Factor(dB/m) = Antenna Factor(dB/m) + Cable Factor(dB)
3. The other emission levels were very low against the limit.
4. Margin value = Emission Level – Limit value
5. " \* ": Fundamental frequency.



<b>CHANNEL</b>	TX Channel 165	<b>DETECTOR FUNCTION</b>	Peak (PK)
<b>FREQUENCY RANGE</b>	1GHz ~ 40GHz		Average (AV)

**ANTENNA POLARITY & TEST DISTANCE: HORIZONTAL AT 3 M**

NO.	FREQ. (MHz)	EMISSION LEVEL (dBuV/m)	LIMIT (dBuV/m)	MARGIN (dB)	ANTENNA HEIGHT (m)	TABLE ANGLE (Degree)	RAW VALUE (dBuV)	CORRECTION FACTOR (dB/m)
1	*5825.00	106.8 PK			1.14 H	60	66.30	40.50
2	*5825.00	97.0 AV			1.14 H	60	56.50	40.50
3	#5850.00	60.4 PK	78.2	-17.8	1.29 H	60	53.50	6.90
4	#5853.00	62.1 PK	78.2	-16.1	1.29 H	60	55.10	7.00
5	#5861.00	57.5 PK	74.0	-16.5	1.29 H	59	50.50	7.00
6	#5861.00	46.5 AV	54.0	-7.5	1.29 H	59	39.50	7.00
7	11650.00	61.7 PK	74.0	-12.3	1.18 H	159	42.80	18.90
8	11650.00	48.5 AV	54.0	-5.5	1.18 H	159	29.60	18.90

**ANTENNA POLARITY & TEST DISTANCE: VERTICAL AT 3 M**

NO.	FREQ. (MHz)	EMISSION LEVEL (dBuV/m)	LIMIT (dBuV/m)	MARGIN (dB)	ANTENNA HEIGHT (m)	TABLE ANGLE (Degree)	RAW VALUE (dBuV)	CORRECTION FACTOR (dB/m)
1	*5825.00	119.6 PK			1.77 V	55	79.10	40.50
2	*5825.00	109.0 AV			1.77 V	55	68.50	40.50
3	#5850.00	61.4 PK	78.2	-16.8	1.66 V	64	54.50	6.90
4	#5853.00	73.6 PK	78.2	-4.6	1.66 V	64	66.60	7.00
5	#5861.00	67.5 PK	74.0	-6.5	1.72 V	124	60.50	7.00
6	#5861.00	52.1 AV	54.0	-1.9	1.72 V	124	45.10	7.00
7	11650.00	62.7 PK	74.0	-11.3	2.43 V	155	43.80	18.90
8	11650.00	49.8 AV	54.0	-4.2	2.43 V	155	30.90	18.90

**REMARKS:**

1. Emission Level(dBuV/m) = Raw Value(dBuV) + Correction Factor(dB/m)
2. Correction Factor(dB/m) = Antenna Factor(dB/m) + Cable Factor(dB)
3. The other emission levels were very low against the limit.
4. Margin value = Emission Level – Limit value
5. " \* ": Fundamental frequency.
6. " # ": The radiated frequency is out of the restricted band.

**802.11n (HT40)**

<b>CHANNEL</b>	TX Channel 151	<b>DETECTOR FUNCTION</b>	Peak (PK)
<b>FREQUENCY RANGE</b>	1GHz ~ 40GHz		Average (AV)

**ANTENNA POLARITY & TEST DISTANCE: HORIZONTAL AT 3 M**

NO.	FREQ. (MHz)	EMISSION LEVEL (dBuV/m)	LIMIT (dBuV/m)	MARGIN (dB)	ANTENNA HEIGHT (m)	TABLE ANGLE (Degree)	RAW VALUE (dBuV)	CORRECTION FACTOR (dB/m)
1	#5714.00	58.9 PK	74.0	-15.1	1.23 H	53	52.10	6.80
2	#5714.00	48.3 AV	54.0	-5.7	1.23 H	53	41.50	6.80
3	#5722.00	62.5 PK	78.2	-15.7	1.40 H	63	55.70	6.80
4	#5725.00	60.7 PK	78.2	-17.5	1.40 H	63	53.90	6.80
5	*5755.00	98.4 PK			1.20 H	202	57.90	40.50
6	*5755.00	88.9 AV			1.20 H	202	48.40	40.50
7	11570.00	59.8 PK	74.0	-14.2	1.42 H	75	41.40	18.40
8	11570.00	46.8 AV	54.0	-7.2	1.42 H	75	28.40	18.40

**ANTENNA POLARITY & TEST DISTANCE: VERTICAL AT 3 M**

NO.	FREQ. (MHz)	EMISSION LEVEL (dBuV/m)	LIMIT (dBuV/m)	MARGIN (dB)	ANTENNA HEIGHT (m)	TABLE ANGLE (Degree)	RAW VALUE (dBuV)	CORRECTION FACTOR (dB/m)
1	#5714.00	67.3 PK	74.0	-6.7	1.71 V	178	60.50	6.80
2	#5714.00	52.4 AV	54.0	-1.6	1.71 V	178	45.60	6.80
3	#5722.00	70.3 PK	78.2	-7.9	1.77 V	69	63.50	6.80
4	#5725.00	62.6 PK	78.2	-15.6	1.77 V	69	55.80	6.80
5	*5755.00	110.2 PK			1.69 V	55	69.70	40.50
6	*5755.00	101.0 AV			1.69 V	55	60.50	40.50
7	11570.00	60.2 PK	74.0	-13.8	2.42 V	175	41.80	18.40
8	11570.00	47.1 AV	54.0	-6.9	2.42 V	175	28.70	18.40

**REMARKS:**

1. Emission Level(dBuV/m) = Raw Value(dBuV) + Correction Factor(dB/m)
2. Correction Factor(dB/m) = Antenna Factor(dB/m) + Cable Factor(dB)
3. The other emission levels were very low against the limit.
4. Margin value = Emission Level – Limit value
5. " \* ": Fundamental frequency.
6. " # ": The radiated frequency is out of the restricted band.

<b>CHANNEL</b>	TX Channel 159	<b>DETECTOR FUNCTION</b>	Peak (PK)
<b>FREQUENCY RANGE</b>	1GHz ~ 40GHz		Average (AV)

**ANTENNA POLARITY & TEST DISTANCE: HORIZONTAL AT 3 M**

NO.	FREQ. (MHz)	EMISSION LEVEL (dBuV/m)	LIMIT (dBuV/m)	MARGIN (dB)	ANTENNA HEIGHT (m)	TABLE ANGLE (Degree)	RAW VALUE (dBuV)	CORRECTION FACTOR (dB/m)
1	*5795.00	103.4 PK			1.00 H	60	62.90	40.50
2	*5795.00	94.0 AV			1.00 H	60	53.50	40.50
3	#5850.00	59.9 PK	78.2	-18.3	1.38 H	70	53.00	6.90
4	#5853.00	61.2 PK	78.2	-17.0	1.38 H	70	54.20	7.00
5	#5861.00	58.6 PK	74.0	-15.4	1.33 H	50	51.60	7.00
6	#5861.00	47.2 AV	54.0	-6.8	1.33 H	50	40.20	7.00
7	11590.00	60.5 PK	74.0	-13.5	1.05 H	201	42.00	18.50
8	11590.00	47.2 AV	54.0	-6.8	1.05 H	201	28.70	18.50

**ANTENNA POLARITY & TEST DISTANCE: VERTICAL AT 3 M**

NO.	FREQ. (MHz)	EMISSION LEVEL (dBuV/m)	LIMIT (dBuV/m)	MARGIN (dB)	ANTENNA HEIGHT (m)	TABLE ANGLE (Degree)	RAW VALUE (dBuV)	CORRECTION FACTOR (dB/m)
1	*5795.00	116.7 PK			1.74 V	52	76.20	40.50
2	*5795.00	106.2 AV			1.74 V	52	65.70	40.50
3	#5850.00	68.9 PK	78.2	-9.3	1.77 V	162	62.00	6.90
4	#5853.00	65.1 PK	78.2	-13.1	1.77 V	162	58.10	7.00
5	#5861.00	66.7 PK	74.0	-7.3	1.79 V	52	59.70	7.00
6	#5861.00	52.8 AV	54.0	-1.2	1.79 V	52	45.80	7.00
7	11590.00	62.0 PK	74.0	-12.0	2.37 V	175	43.50	18.50
8	11590.00	49.2 AV	54.0	-4.8	2.37 V	175	30.70	18.50

**REMARKS:**

1. Emission Level(dBuV/m) = Raw Value(dBuV) + Correction Factor(dB/m)
2. Correction Factor(dB/m) = Antenna Factor(dB/m) + Cable Factor(dB)
3. The other emission levels were very low against the limit.
4. Margin value = Emission Level – Limit value
5. " \* ": Fundamental frequency.
6. " # ": The radiated frequency is out of the restricted band.

**802.11ac (VHT80)**

<b>CHANNEL</b>	TX Channel 155	<b>DETECTOR FUNCTION</b>	Peak (PK)
<b>FREQUENCY RANGE</b>	1GHz ~ 40GHz		Average (AV)

**ANTENNA POLARITY & TEST DISTANCE: HORIZONTAL AT 3 M**

NO.	FREQ. (MHz)	EMISSION LEVEL (dBuV/m)	LIMIT (dBuV/m)	MARGIN (dB)	ANTENNA HEIGHT (m)	TABLE ANGLE (Degree)	RAW VALUE (dBuV)	CORRECTION FACTOR (dB/m)
1	#5714.00	58.1 PK	74.0	-15.9	1.15 H	92	51.30	6.80
2	#5714.00	46.8 AV	54.0	-7.2	1.15 H	92	40.00	6.80
3	#5722.00	63.1 PK	78.2	-15.1	1.20 H	87	56.30	6.80
4	#5725.00	59.0 PK	78.2	-19.2	1.20 H	87	52.20	6.80
5	*5775.00	94.8 PK			1.09 H	106	54.30	40.50
6	*5775.00	85.8 AV			1.09 H	106	45.30	40.50
7	#5850.00	59.8 PK	78.2	-18.4	1.11 H	56	52.90	6.90
8	#5853.00	62.0 PK	78.2	-16.2	1.11 H	56	55.00	7.00
9	#5861.00	56.9 PK	74.0	-17.1	1.07 H	60	49.90	7.00
10	#5861.00	45.3 AV	54.0	-8.7	1.07 H	60	38.30	7.00
11	11550.00	59.3 PK	74.0	-14.7	1.00 H	343	40.90	18.40
12	11550.00	46.0 AV	54.0	-8.0	1.00 H	343	27.60	18.40

**ANTENNA POLARITY & TEST DISTANCE: VERTICAL AT 3 M**

NO.	FREQ. (MHz)	EMISSION LEVEL (dBuV/m)	LIMIT (dBuV/m)	MARGIN (dB)	ANTENNA HEIGHT (m)	TABLE ANGLE (Degree)	RAW VALUE (dBuV)	CORRECTION FACTOR (dB/m)
1	#5714.00	65.8 PK	74.0	-8.2	1.78 V	185	59.00	6.80
2	#5714.00	52.1 AV	54.0	-1.9	1.78 V	185	45.30	6.80
3	#5722.00	72.1 PK	78.2	-6.1	1.88 V	174	65.30	6.80
4	#5725.00	67.2 PK	78.2	-11.0	1.88 V	174	60.40	6.80
5	*5775.00	106.0 PK			1.85 V	60	65.50	40.50
6	*5775.00	94.9 AV			1.85 V	60	54.40	40.50
7	#5850.00	57.0 PK	78.2	-21.2	1.80 V	72	50.10	6.90
8	#5853.00	59.3 PK	78.2	-18.9	1.80 V	72	52.30	7.00
9	#5861.00	49.8 PK	74.0	-24.2	1.88 V	70	42.80	7.00
10	#5861.00	45.7 AV	54.0	-8.3	1.88 V	70	38.70	7.00
11	11550.00	60.1 PK	74.0	-13.9	1.34 V	52	41.70	18.40
12	11550.00	46.9 AV	54.0	-7.1	1.34 V	52	28.50	18.40

**REMARKS:**

1. Emission Level(dBuV/m) = Raw Value(dBuV) + Correction Factor(dB/m)
2. Correction Factor(dB/m) = Antenna Factor(dB/m) + Cable Factor(dB)
3. The other emission levels were very low against the limit.
4. Margin value = Emission Level – Limit value
5. " \* ": Fundamental frequency.
6. " # ": The radiated frequency is out of the restricted band.

**BELOW 1GHz WORST-CASE DATA**
**Test Mode A**
**802.11a**

<b>CHANNEL</b>	TX Channel 157	<b>DETECTOR FUNCTION</b>	Quasi-Peak (QP)
<b>FREQUENCY RANGE</b>	30MHz ~ 1GHz		

**ANTENNA POLARITY & TEST DISTANCE: HORIZONTAL AT 3 M**

NO.	FREQ. (MHz)	EMISSION LEVEL (dBuV/m)	LIMIT (dBuV/m)	MARGIN (dB)	ANTENNA HEIGHT (m)	TABLE ANGLE (Degree)	RAW VALUE (dBuV)	CORRECTION FACTOR (dB/m)
1	57.12	31.9 QP	40.0	-8.1	1.99 H	84	46.50	-14.60
2	96.01	32.2 QP	43.5	-11.3	1.99 H	70	51.80	-19.60
3	154.33	36.4 QP	43.5	-7.1	1.99 H	89	50.30	-13.90
4	243.77	34.3 QP	46.0	-11.7	1.00 H	86	49.00	-14.70
5	374.04	29.4 QP	46.0	-16.6	1.00 H	226	40.40	-11.00
6	624.85	34.2 QP	46.0	-11.8	1.49 H	5	39.80	-5.60

**ANTENNA POLARITY & TEST DISTANCE: VERTICAL AT 3 M**

NO.	FREQ. (MHz)	EMISSION LEVEL (dBuV/m)	LIMIT (dBuV/m)	MARGIN (dB)	ANTENNA HEIGHT (m)	TABLE ANGLE (Degree)	RAW VALUE (dBuV)	CORRECTION FACTOR (dB/m)
1	66.84	30.2 QP	40.0	-9.8	1.00 V	298	45.90	-15.70
2	125.17	36.6 QP	43.5	-6.9	1.00 V	223	52.70	-16.10
3	249.60	27.7 QP	46.0	-18.3	1.00 V	127	42.10	-14.40
4	461.53	28.9 QP	46.0	-17.1	1.00 V	213	38.00	-9.10
5	624.85	29.5 QP	46.0	-16.5	1.50 V	356	35.10	-5.60
6	832.89	33.0 QP	46.0	-13.0	1.00 V	108	34.90	-1.90

**REMARKS:**

1. Emission Level(dBuV/m) = Raw Value(dBuV) + Correction Factor(dB/m)
2. Correction Factor(dB/m) = Antenna Factor(dB/m) + Cable Factor(dB)
3. The other emission levels were very low against the limit.
4. Margin value = Emission Level – Limit value



**Test Mode B**
**802.11a**

<b>CHANNEL</b>	TX Channel 157	<b>DETECTOR FUNCTION</b>	Quasi-Peak (QP)
<b>FREQUENCY RANGE</b>	30MHz ~ 1GHz		

**ANTENNA POLARITY & TEST DISTANCE: HORIZONTAL AT 3 M**

NO.	FREQ. (MHz)	EMISSION LEVEL (dBuV/m)	LIMIT (dBuV/m)	MARGIN (dB)	ANTENNA HEIGHT (m)	TABLE ANGLE (Degree)	RAW VALUE (dBuV)	CORRECTION FACTOR (dB/m)
1	57.12	32.8 QP	40.0	-7.2	2.00 H	15	47.40	-14.60
2	96.01	31.2 QP	43.5	-12.3	2.00 H	222	50.80	-19.60
3	181.55	33.9 QP	43.5	-9.6	1.50 H	100	49.40	-15.50
4	237.94	34.7 QP	46.0	-11.3	1.00 H	76	49.80	-15.10
5	374.04	32.4 QP	46.0	-13.6	1.00 H	239	43.40	-11.00
6	875.67	33.2 QP	46.0	-12.8	1.50 H	9	34.30	-1.10

**ANTENNA POLARITY & TEST DISTANCE: VERTICAL AT 3 M**

NO.	FREQ. (MHz)	EMISSION LEVEL (dBuV/m)	LIMIT (dBuV/m)	MARGIN (dB)	ANTENNA HEIGHT (m)	TABLE ANGLE (Degree)	RAW VALUE (dBuV)	CORRECTION FACTOR (dB/m)
1	33.79	35.1 QP	40.0	-4.9	1.01 V	243	50.90	-15.80
2	70.73	29.8 QP	40.0	-10.2	1.01 V	199	46.00	-16.20
3	243.77	27.4 QP	46.0	-18.6	1.01 V	61	42.10	-14.70
4	374.04	29.4 QP	46.0	-16.6	1.50 V	244	40.40	-11.00
5	624.85	30.6 QP	46.0	-15.4	1.50 V	9	36.20	-5.60
6	729.84	30.3 QP	46.0	-15.7	1.01 V	10	34.00	-3.70

**REMARKS:**

1. Emission Level(dBuV/m) = Raw Value(dBuV) + Correction Factor(dB/m)
2. Correction Factor(dB/m) = Antenna Factor(dB/m) + Cable Factor(dB)
3. The other emission levels were very low against the limit.
4. Margin value = Emission Level – Limit value

**Test Mode C**
**802.11a**

<b>CHANNEL</b>	TX Channel 157	<b>DETECTOR FUNCTION</b>	Quasi-Peak (QP)
<b>FREQUENCY RANGE</b>	30MHz ~ 1GHz		

**ANTENNA POLARITY & TEST DISTANCE: HORIZONTAL AT 3 M**

NO.	FREQ. (MHz)	EMISSION LEVEL (dBuV/m)	LIMIT (dBuV/m)	MARGIN (dB)	ANTENNA HEIGHT (m)	TABLE ANGLE (Degree)	RAW VALUE (dBuV)	CORRECTION FACTOR (dB/m)
1	74.62	32.5 QP	40.0	-7.5	1.50 H	301	49.80	-17.30
2	138.78	39.7 QP	43.5	-3.8	1.99 H	79	54.50	-14.80
3	226.27	41.7 QP	46.0	-4.3	1.50 H	82	58.30	-16.60
4	243.77	43.7 QP	46.0	-2.3	1.00 H	79	58.40	-14.70
5	374.04	36.4 QP	46.0	-9.6	1.00 H	147	47.40	-11.00
6	525.69	34.4 QP	46.0	-11.6	1.50 H	74	42.30	-7.90
7	961.21	45.2 QP	54.0	-8.8	1.50 H	157	44.70	0.50

**ANTENNA POLARITY & TEST DISTANCE: VERTICAL AT 3 M**

NO.	FREQ. (MHz)	EMISSION LEVEL (dBuV/m)	LIMIT (dBuV/m)	MARGIN (dB)	ANTENNA HEIGHT (m)	TABLE ANGLE (Degree)	RAW VALUE (dBuV)	CORRECTION FACTOR (dB/m)
1	49.34	35.1 QP	40.0	-4.9	1.00 V	345	49.50	-14.40
2	72.67	37.4 QP	40.0	-2.6	1.00 V	212	54.30	-16.90
3	239.88	40.1 QP	46.0	-5.9	1.00 V	148	55.10	-15.00
4	374.04	39.6 QP	46.0	-6.4	1.50 V	261	50.60	-11.00
5	525.69	37.4 QP	46.0	-8.6	1.00 V	266	45.30	-7.90
6	961.21	45.9 QP	54.0	-8.1	1.00 V	120	45.40	0.50

**REMARKS:**

1. Emission Level(dBuV/m) = Raw Value(dBuV) + Correction Factor(dB/m)
2. Correction Factor(dB/m) = Antenna Factor(dB/m) + Cable Factor(dB)
3. The other emission levels were very low against the limit.
4. Margin value = Emission Level – Limit value

**Test Mode D**

**802.11a**

<b>CHANNEL</b>	TX Channel 157	<b>DETECTOR FUNCTION</b>	Quasi-Peak (QP)
<b>FREQUENCY RANGE</b>	30MHz ~ 1GHz		

**ANTENNA POLARITY & TEST DISTANCE: HORIZONTAL AT 3 M**

NO.	FREQ. (MHz)	EMISSION LEVEL (dBuV/m)	LIMIT (dBuV/m)	MARGIN (dB)	ANTENNA HEIGHT (m)	TABLE ANGLE (Degree)	RAW VALUE (dBuV)	CORRECTION FACTOR (dB/m)
1	57.12	30.7 QP	40.0	-9.3	2.00 H	0	45.30	-14.60
2	113.50	29.8 QP	43.5	-13.7	1.00 H	140	46.90	-17.10
3	179.61	32.4 QP	43.5	-11.1	1.00 H	265	47.60	-15.20
4	245.72	40.9 QP	46.0	-5.1	1.00 H	109	55.60	-14.70
5	374.04	33.9 QP	46.0	-12.1	1.00 H	119	44.90	-11.00
6	959.27	43.9 QP	46.0	-2.1	1.49 H	0	43.40	0.50

**ANTENNA POLARITY & TEST DISTANCE: VERTICAL AT 3 M**

NO.	FREQ. (MHz)	EMISSION LEVEL (dBuV/m)	LIMIT (dBuV/m)	MARGIN (dB)	ANTENNA HEIGHT (m)	TABLE ANGLE (Degree)	RAW VALUE (dBuV)	CORRECTION FACTOR (dB/m)
1	57.12	32.3 QP	40.0	-7.7	1.00 V	15	46.90	-14.60
2	103.78	31.9 QP	43.5	-11.6	1.00 V	15	50.20	-18.30
3	235.99	37.8 QP	46.0	-8.2	1.00 V	150	53.10	-15.30
4	374.04	38.3 QP	46.0	-7.7	1.50 V	270	49.30	-11.00
5	527.64	34.0 QP	46.0	-12.0	1.00 V	272	42.00	-8.00
6	960.27	46.7 QP	54.0	-7.3	1.00 V	126	46.20	0.50

**REMARKS:**

1. Emission Level(dBuV/m) = Raw Value(dBuV) + Correction Factor(dB/m)
2. Correction Factor(dB/m) = Antenna Factor(dB/m) + Cable Factor(dB)
3. The other emission levels were very low against the limit.
4. Margin value = Emission Level – Limit value

## 4.2 Conducted Emission Measurement

### 4.2.1 Limits of Conducted Emission Measurement

Frequency (MHz)	Conducted Limit (dBuV)	
	Quasi-peak	Average
0.15 - 0.5	66 - 56	56 - 46
0.50 - 5.0	56	46
5.0 - 30.0	60	50

Note: 1. The lower limit shall apply at the transition frequencies.

2. The limit decreases in line with the logarithm of the frequency in the range of 0.15 to 0.50MHz.

### 4.2.2 Test Instruments

Description & Manufacturer	Model No.	Serial No.	Date Of Calibration	Due Date Of Calibration
Test Receiver ROHDE & SCHWARZ	ESCS30	100288	Apr. 27, 2015	Apr. 26, 2016
RF signal cable Woken	5D-FB	Cable-HYCO2-01	Dec. 26, 2014	Dec. 25, 2015
LISN ROHDE & SCHWARZ (EUT)	ESH2-Z5	100100	Dec. 30, 2014	Dec. 29, 2015
LISN ROHDE & SCHWARZ (Peripheral)	ESH3-Z5	100312	Jul. 10, 2014	Jul. 09, 2015
Software ADT	BV ADT_Cond_ V7.3.7.3	NA	NA	NA

Notes: 1. The calibration interval of the above test instruments is 12 months and the calibrations are traceable to NML/ROC and NIST/USA.

2. The test was performed in HwaYa Shielded Room 2.

3. The VCCI Site Registration No. is C-2047.

#### 4.2.3 Test Procedure

- a. The EUT was placed 0.4 meters from the conducting wall of the shielded room with EUT being connected to the power mains through a line impedance stabilization network (LISN). Other support units were connected to the power mains through another LISN. The two LISNs provide 50 ohm/ 50uH of coupling impedance for the measuring instrument.
- b. Both lines of the power mains connected to the EUT were checked for maximum conducted interference.
- c. The frequency range from 150kHz to 30MHz was searched. Emission levels under (Limit - 20dB) was not recorded.

**NOTE:** The resolution bandwidth and video bandwidth of test receiver is 9kHz for quasi-peak detection (QP) and average detection (AV) at frequency 0.15MHz-30MHz.

#### 4.2.4 Deviation from Test Standard

No deviation.

#### 4.2.5 Test Setup

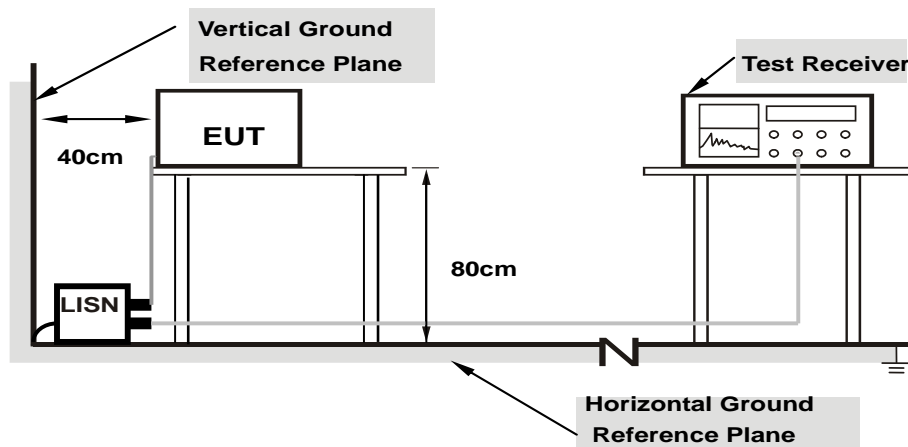

- Note:**
1. Support units were connected to second LISN.
  2. Both of LISNs (AMN) are 80 cm from EUT and at least 80 from other units and other metal planes

For the actual test configuration, please refer to the attached file (Test Setup Photo).

#### 4.2.6 EUT Operating Conditions

Same as 4.1.6.

#### 4.2.7 Test Results

##### Test Mode A

##### 802.11a

Phase	Line (L)	Detector Function	Quasi-Peak (QP) / Average (AV)
-------	----------	-------------------	--------------------------------

No	Freq. [MHz]	Corr. Factor (dB)	Reading Value		Emission Level		Limit		Margin	
			[dB (uV)]		[dB (uV)]		[dB (uV)]		(dB)	
			Q.P.	AV.	Q.P.	AV.	Q.P.	AV.	Q.P.	AV.
1	0.18263	0.20	43.23	32.25	43.43	32.45	64.37	54.37	-20.94	-21.92
2	0.24375	0.20	37.87	27.81	38.07	28.01	61.97	51.97	-23.90	-23.96
3	0.30625	0.20	36.14	29.02	36.34	29.22	60.07	50.07	-23.73	-20.85
4	0.50000	0.22	42.89	33.59	43.11	33.81	56.00	46.00	-12.89	-12.19
5	0.89219	0.28	33.91	24.98	34.19	25.26	56.00	46.00	-21.81	-20.74
6	1.30469	0.32	33.25	26.84	33.57	27.16	56.00	46.00	-22.43	-18.84

#### REMARKS:

1. Q.P. and AV. are abbreviations of quasi-peak and average individually.
2. The emission levels of other frequencies were very low against the limit.
3. Margin value = Emission level - Limit value
4. Correction factor = Insertion loss + Cable loss
5. Emission Level = Correction Factor + Reading Value.

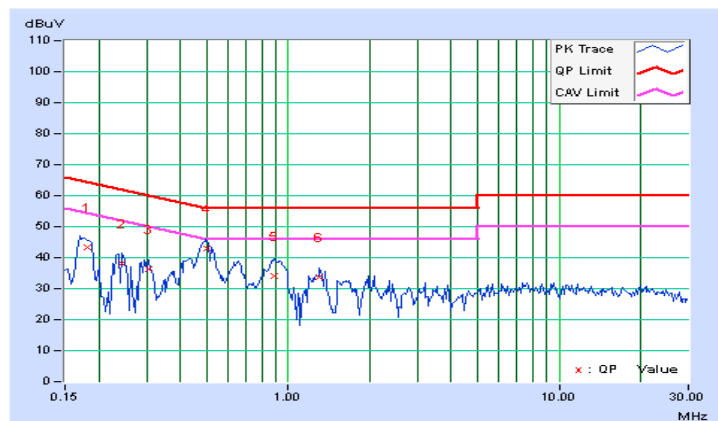

Phase	Neutral (N)	Detector Function	Quasi-Peak (QP) / Average (AV)
-------	-------------	-------------------	--------------------------------

No	Freq. [MHz]	Corr. Factor (dB)	Reading Value		Emission Level		Limit		Margin	
			[dB (uV)]		[dB (uV)]		[dB (uV)]		(dB)	
			Q.P.	AV.	Q.P.	AV.	Q.P.	AV.	Q.P.	AV.
1	0.17734	0.21	44.11	34.51	44.32	34.72	64.61	54.61	-20.29	-19.89
2	0.23594	0.23	38.50	27.73	38.73	27.96	62.24	52.24	-23.51	-24.28
3	0.29844	0.23	37.78	30.28	38.01	30.51	60.29	50.29	-22.27	-19.77
4	0.50156	0.26	44.57	34.51	44.83	34.77	56.00	46.00	-11.17	-11.23
5	0.91172	0.30	37.63	30.53	37.93	30.83	56.00	46.00	-18.07	-15.17
6	3.84766	0.46	33.23	28.11	33.69	28.57	56.00	46.00	-22.31	-17.43

**REMARKS:**

1. Q.P. and AV. are abbreviations of quasi-peak and average individually.
2. The emission levels of other frequencies were very low against the limit.
3. Margin value = Emission level - Limit value
4. Correction factor = Insertion loss + Cable loss
5. Emission Level = Correction Factor + Reading Value.

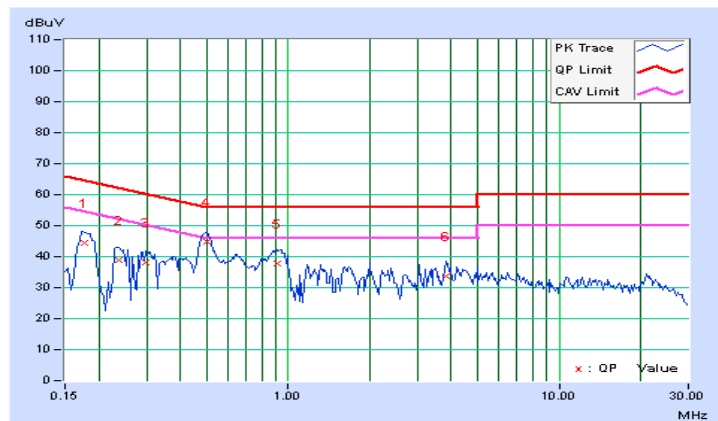

**Test Mode B**  
**802.11a**

Phase	Line (L)	Detector Function	Quasi-Peak (QP) / Average (AV)
-------	----------	-------------------	--------------------------------

No	Freq. [MHz]	Corr. Factor (dB)	Reading Value		Emission Level		Limit		Margin	
			[dB (uV)]		[dB (uV)]		[dB (uV)]		(dB)	
			Q.P.	AV.	Q.P.	AV.	Q.P.	AV.	Q.P.	AV.
1	0.15391	0.20	59.86	47.36	60.06	47.56	65.79	55.79	-5.73	-8.23
2	0.18516	0.20	54.23	41.37	54.43	41.57	64.25	54.25	-9.82	-12.68
3	0.52500	0.22	40.31	34.65	40.53	34.87	56.00	46.00	-15.47	-11.13
4	4.67969	0.44	38.54	32.72	38.98	33.16	56.00	46.00	-17.02	-12.84
5	10.94531	0.52	46.66	41.42	47.18	41.94	60.00	50.00	-12.82	-8.06
6	12.19141	0.54	45.65	40.59	46.19	41.13	60.00	50.00	-13.81	-8.87

**REMARKS:**

1. Q.P. and AV. are abbreviations of quasi-peak and average individually.
2. The emission levels of other frequencies were very low against the limit.
3. Margin value = Emission level - Limit value
4. Correction factor = Insertion loss + Cable loss
5. Emission Level = Correction Factor + Reading Value.

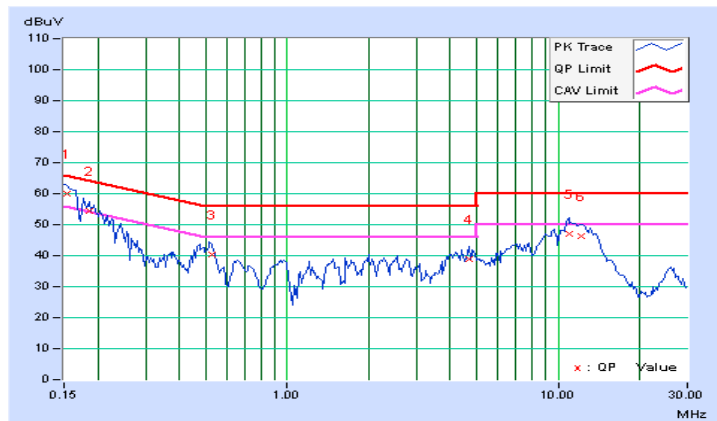



Phase	Neutral (N)	Detector Function	Quasi-Peak (QP) / Average (AV)
-------	-------------	-------------------	--------------------------------

No	Freq. [MHz]	Corr. Factor (dB)	Reading Value [dB (uV)]		Emission Level [dB (uV)]		Limit [dB (uV)]		Margin (dB)	
			Q.P.	AV.	Q.P.	AV.	Q.P.	AV.	Q.P.	AV.
			1	0.15781	0.21	58.96	45.82	59.17	46.03	65.58
2	0.17734	0.21	53.56	35.54	53.77	35.75	64.61	54.61	-10.84	-18.86
3	0.22031	0.22	48.41	34.64	48.63	34.86	62.81	52.81	-14.17	-17.94
4	0.52891	0.26	39.19	33.63	39.45	33.89	56.00	46.00	-16.55	-12.11
5	0.64609	0.27	36.24	31.15	36.51	31.42	56.00	46.00	-19.49	-14.58
6	11.22266	0.60	42.92	37.81	43.52	38.41	60.00	50.00	-16.48	-11.59

**REMARKS:**

1. Q.P. and AV. are abbreviations of quasi-peak and average individually.
2. The emission levels of other frequencies were very low against the limit.
3. Margin value = Emission level - Limit value
4. Correction factor = Insertion loss + Cable loss
5. Emission Level = Correction Factor + Reading Value.

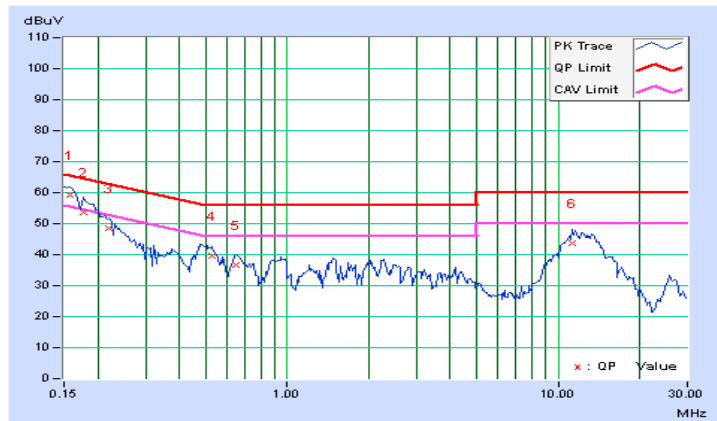

**Test Mode C**  
**802.11a**

Phase	Line (L)	Detector Function	Quasi-Peak (QP) / Average (AV)
-------	----------	-------------------	--------------------------------

No	Freq. [MHz]	Corr. Factor (dB)	Reading Value		Emission Level		Limit		Margin	
			[dB (uV)]		[dB (uV)]		[dB (uV)]		(dB)	
			Q.P.	AV.	Q.P.	AV.	Q.P.	AV.	Q.P.	AV.
1	0.19687	0.20	39.86	29.53	40.06	29.73	63.74	53.74	-23.68	-24.01
2	0.26328	0.20	37.34	29.14	37.54	29.34	61.33	51.33	-23.79	-21.99
3	0.47422	0.21	43.18	33.38	43.39	33.59	56.44	46.44	-13.05	-12.85
4	0.50938	0.22	42.14	35.05	42.36	35.27	56.00	46.00	-13.64	-10.73
5	0.64609	0.24	35.41	28.32	35.65	28.56	56.00	46.00	-20.35	-17.44
6	0.89609	0.28	36.20	28.58	36.48	28.86	56.00	46.00	-19.52	-17.14

**REMARKS:**

1. Q.P. and AV. are abbreviations of quasi-peak and average individually.
2. The emission levels of other frequencies were very low against the limit.
3. Margin value = Emission level - Limit value
4. Correction factor = Insertion loss + Cable loss
5. Emission Level = Correction Factor + Reading Value.

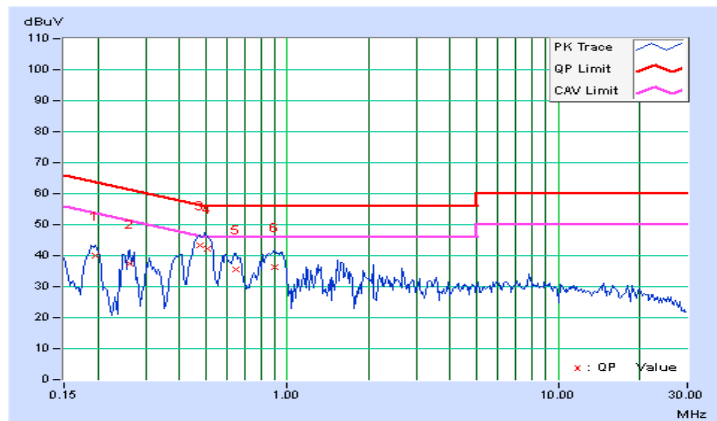

Phase	Neutral (N)	Detector Function	Quasi-Peak (QP) / Average (AV)
-------	-------------	-------------------	--------------------------------

No	Freq. [MHz]	Corr. Factor (dB)	Reading Value [dB (uV)]		Emission Level [dB (uV)]		Limit [dB (uV)]		Margin (dB)	
			Q.P.	AV.	Q.P.	AV.	Q.P.	AV.	Q.P.	AV.
			1	0.19297	0.22	42.62	35.28	42.84	35.50	63.91
2	0.26328	0.23	38.93	31.66	39.16	31.89	61.33	51.33	-22.17	-19.44
3	0.48203	0.26	40.85	32.22	41.11	32.48	56.30	46.30	-15.20	-13.83
4	0.50547	0.26	44.15	36.90	44.41	37.16	56.00	46.00	-11.59	-8.84
5	0.90781	0.30	38.40	31.60	38.70	31.90	56.00	46.00	-17.30	-14.10
6	1.19531	0.33	37.34	29.41	37.67	29.74	56.00	46.00	-18.33	-16.26

**REMARKS:**

1. Q.P. and AV. are abbreviations of quasi-peak and average individually.
2. The emission levels of other frequencies were very low against the limit.
3. Margin value = Emission level - Limit value
4. Correction factor = Insertion loss + Cable loss
5. Emission Level = Correction Factor + Reading Value.

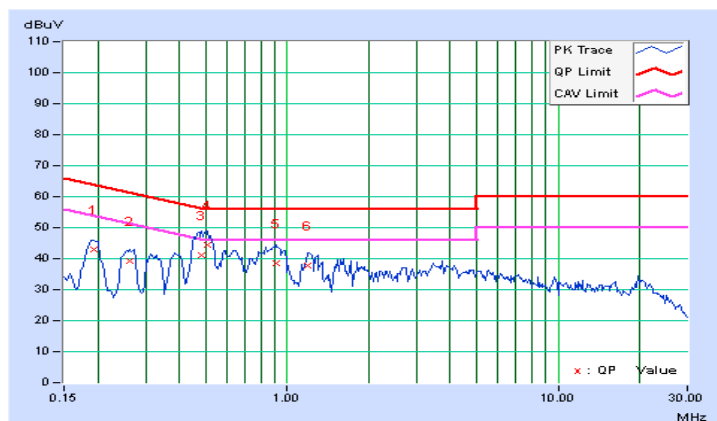

**Test Mode D**  
**802.11a**

Phase	Line (L)	Detector Function	Quasi-Peak (QP) / Average (AV)
-------	----------	-------------------	--------------------------------

No	Freq. [MHz]	Corr. Factor (dB)	Reading Value		Emission Level		Limit		Margin	
			[dB (uV)]		[dB (uV)]		[dB (uV)]		(dB)	
			Q.P.	AV.	Q.P.	AV.	Q.P.	AV.	Q.P.	AV.
<b>1</b>	<b>0.15000</b>	<b>0.19</b>	<b>61.90</b>	<b>44.87</b>	<b>62.09</b>	<b>45.06</b>	<b>66.00</b>	<b>56.00</b>	<b>-3.91</b>	<b>-10.94</b>
2	0.16953	0.20	58.11	42.04	58.31	42.24	64.98	54.98	-6.68	-12.75
3	0.20859	0.20	52.71	39.14	52.91	39.34	63.26	53.26	-10.35	-13.92
4	0.52891	0.22	40.07	33.77	40.29	33.99	56.00	46.00	-15.71	-12.01
5	4.42969	0.44	39.34	33.20	39.78	33.64	56.00	46.00	-16.22	-12.36
6	11.54297	0.53	47.11	41.79	47.64	42.32	60.00	50.00	-12.36	-7.68

**REMARKS:**

1. Q.P. and AV. are abbreviations of quasi-peak and average individually.
2. The emission levels of other frequencies were very low against the limit.
3. Margin value = Emission level - Limit value
4. Correction factor = Insertion loss + Cable loss
5. Emission Level = Correction Factor + Reading Value.

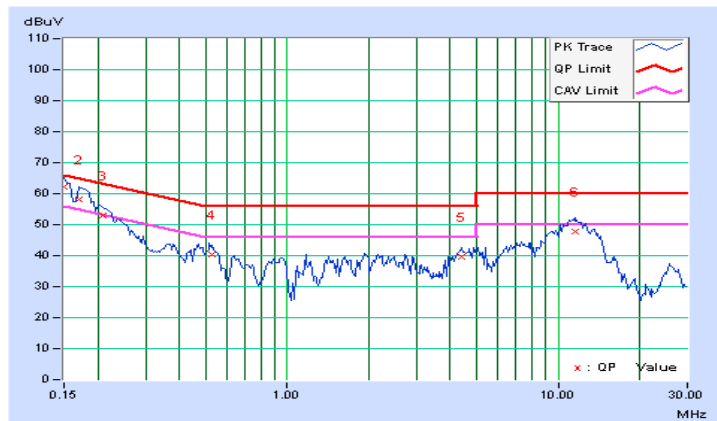

Phase	Neutral (N)	Detector Function	Quasi-Peak (QP) / Average (AV)
-------	-------------	-------------------	--------------------------------

No	Freq. [MHz]	Corr. Factor (dB)	Reading Value [dB (uV)]		Emission Level [dB (uV)]		Limit [dB (uV)]		Margin (dB)	
			Q.P.	AV.	Q.P.	AV.	Q.P.	AV.	Q.P.	AV.
			1	0.15000	0.20	61.12	43.14	61.32	43.34	66.00
2	0.17734	0.21	57.65	44.36	57.86	44.57	64.61	54.61	-6.75	-10.04
3	0.20859	0.22	51.50	34.89	51.72	35.11	63.26	53.26	-11.54	-18.15
4	0.52109	0.26	39.88	33.51	40.14	33.77	56.00	46.00	-15.86	-12.23
5	1.73438	0.38	35.88	31.38	36.26	31.76	56.00	46.00	-19.74	-14.24
6	11.95313	0.62	42.97	37.62	43.59	38.24	60.00	50.00	-16.41	-11.76

**REMARKS:**

1. Q.P. and AV. are abbreviations of quasi-peak and average individually.
2. The emission levels of other frequencies were very low against the limit.
3. Margin value = Emission level - Limit value
4. Correction factor = Insertion loss + Cable loss
5. Emission Level = Correction Factor + Reading Value.

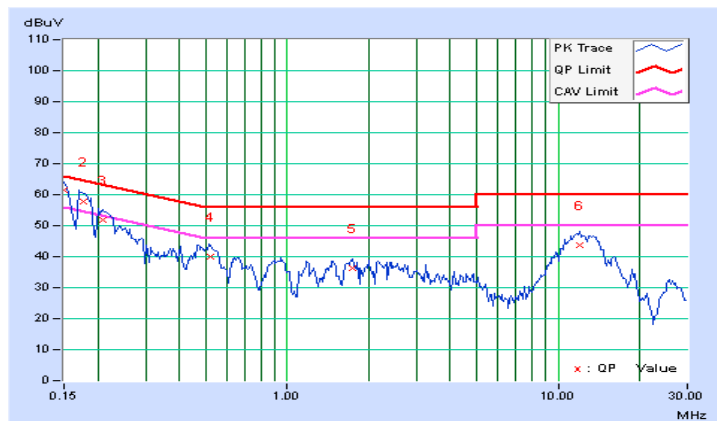

### 4.3 Transmit Power Measurement

#### 4.3.1 Limits of Transmit Power Measurement

Operation Band	EUT Category		LIMIT
U-NII-1		Outdoor Access Point	1 Watt (30 dBm) (Max. e.i.r.p $\leq$ 125mW(21 dBm) at any elevation angle above 30 degrees as measured from the horizon)
		Fixed point-to-point Access Point	1 Watt (30 dBm)
	√	Indoor Access Point	1 Watt (30 dBm)
		Mobile and Portable client device	250mW (24 dBm)
U-NII-2A	---		250mW (24 dBm) or 11 dBm+10 log B*
U-NII-2C	---		250mW (24 dBm) or 11 dBm+10 log B*
U-NII-3	√		1 Watt (30 dBm)

\*B is the 26 dB emission bandwidth in megahertz

Per KDB 662911 Method of conducted output power measurement on IEEE 802.11 devices,

Array Gain = 0 dB (i.e., no array gain) for  $N_{ANT} \leq 4$ ;

Array Gain = 0 dB (i.e., no array gain) for channel widths  $\geq 40$  MHz for any  $N_{ANT}$ ;

Array Gain =  $5 \log(N_{ANT}/N_{SS})$  dB or 3 dB, whichever is less for 20-MHz channel widths with  $N_{ANT} \geq 5$ .

For power measurements on all other devices: Array Gain =  $10 \log(N_{ANT}/N_{SS})$  dB.

#### 4.3.2 Test Setup

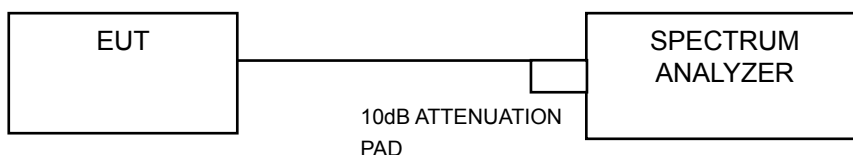
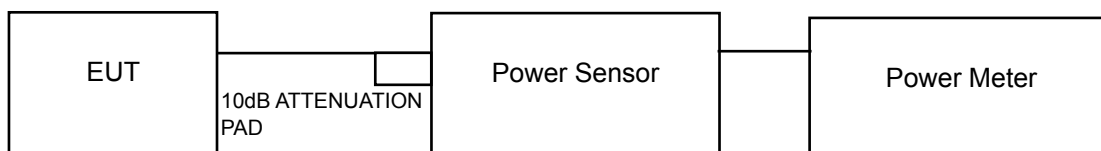

#### 4.3.3 Test Instruments

Refer to section 4.1.2 to get information of above instrument.

#### 4.3.4 Test Procedure

##### FOR AVERAGE POWER MEASUREMENT

###### For 802.11a, 802.11n (HT20), 802.11n (HT40)

Method PM is used to perform output power measurement, trigger and gating function of wide band power meter is enabled to measure max output power of TX on burst. Duty factor is not added to measured value.

###### For 802.11ac (VHT80)

- 1) Set span to encompass the entire 26 dB EBW (or, alternatively, the entire 99% occupied bandwidth) of the signal.
- 2) Set sweep trigger to "free run".
- 3) Set RBW = 1 MHz.
- 4) Set VBW  $\geq$  3 MHz
- 5) Number of points in sweep  $\geq$  2 Span / RBW.
- 6) Sweep time  $\leq$  (number of points in sweep) \* T
- 7) Using emission bandwidth to determine the frequency span for integration the channel bandwidth.
- 8) Detector = RMS.
- 9) Trace mode = max hold.
- 10) Allow max hold to run for at least 60 seconds, or longer as needed to allow the trace to stabilize.

#### 4.3.5 Deviation from Test Standard

No deviation.

#### 4.3.6 EUT Operating Conditions

The software provided by client to enable the EUT under transmission Condition continuously at lowest, middle and highest channel frequencies individually.

#### 4.3.7 Test Result

#### POWER OUTPUT:

##### 802.11a

Chan.	Chan. Freq. (MHz)	Maximum Conducted Power (dBm)			Total Power (mW)	Total Power (dBm)	Power Limit (dBm)	Pass / Fail
		Chain 0	Chain 1	Chain 2				
36	5180	19.07	18.84	19.81	253.003	24.03	29.52	Pass
40	5200	19.50	19.40	20.20	280.934	24.49	29.52	Pass
48	5240	19.40	19.30	20.30	279.362	24.46	29.52	Pass
149	5745	19.21	19.21	19.54	256.686	24.09	29.52	Pass
157	5785	21.25	21.38	21.05	<b>398.106</b>	26.00	29.52	Pass
165	5825	21.55	20.42	20.84	374.382	25.73	29.52	Pass

\* Internal antenna: Max. Gain=6.48dBi, External antenna: Gain=6dBi  
 The Max gain: 6.48dBi > 6dBi, so the limit shall be reduced to 30-(6.48-6) = 29.52dBm.

##### 802.11n (HT20)

Chan.	Chan. Freq. (MHz)	Maximum Conducted Power (dBm)			Total Power (mW)	Total Power (dBm)	Power Limit (dBm)	Pass / Fail
		Chain 0	Chain 1	Chain 2				
36	5180	18.21	18.20	17.86	193.385	22.86	29.52	Pass
40	5200	19.30	18.60	19.40	244.654	23.89	29.52	Pass
48	5240	19.20	18.70	19.50	246.432	23.92	29.52	Pass
149	5745	19.02	19.32	19.48	254.022	24.05	29.52	Pass
157	5785	21.24	21.06	21.03	387.454	25.88	29.52	Pass
165	5825	21.44	20.10	20.54	354.885	25.50	29.52	Pass

\* Internal antenna: Max. Gain=6.48dBi, External antenna: Gain=6dBi  
 The Max gain: 6.48dBi > 6dBi, so the limit shall be reduced to 30-(6.48-6) = 29.52dBm.

##### 802.11n (HT40)

Chan.	Chan. Freq. (MHz)	Maximum Conducted Power (dBm)			Total Power (mW)	Total Power (dBm)	Power Limit (dBm)	Pass / Fail
		Chain 0	Chain 1	Chain 2				
38	5190	15.12	14.60	14.97	92.754	19.67	29.52	Pass
46	5230	21.40	20.90	21.00	<b>386.958</b>	25.88	29.52	Pass
151	5755	15.60	15.82	15.72	111.827	20.49	29.52	Pass
159	5795	20.23	19.98	20.27	311.394	24.93	29.52	Pass

\* Internal antenna: Max. Gain=6.48dBi, External antenna: Gain=6dBi  
 The Max gain: 6.48dBi > 6dBi, so the limit shall be reduced to 30-(6.48-6) = 29.52dBm.



**802.11ac (VHT80)**

Chan.	Chan. Freq. (MHz)	Maximum Conducted Power (dBm)			Total Power (mW)	Total Power (dBm)	Power Limit (dBm)	Pass / Fail
		Chain 0	Chain 1	Chain 2				
42	5210	11.75	11.33	11.62	43.066	16.34	29.52	Pass
155	5775	11.77	11.62	11.63	44.107	16.45	29.52	Pass

\* Internal antenna: Max. Gain=6.48dBi, External antenna: Gain=6dBi

The Max gain: 6.48dBi > 6dBi, so the limit shall be reduced to  $30 - (6.48 - 6) = 29.52$ dBm.

**26dB BANDWIDTH:**
**802.11a**

Channel	Channel Frequency (MHz)	26dBc Bandwidth (MHz)			Pass / Fail
		Chain 0	Chain 1	Chain 2	
36	5180	21.59	21.70	21.95	PASS
40	5200	21.73	21.44	22.14	PASS
48	5240	21.80	21.52	21.96	PASS

**802.11n (HT20)**

Channel	Channel Frequency (MHz)	26dBc Bandwidth (MHz)			Pass / Fail
		Chain 0	Chain 1	Chain 2	
36	5180	23.23	22.86	23.02	PASS
40	5200	22.85	22.77	22.70	PASS
48	5240	22.67	22.87	22.60	PASS

**802.11n (HT40)**

Channel	Channel Frequency (MHz)	26dBc Bandwidth (MHz)			Pass / Fail
		Chain 0	Chain 1	Chain 2	
38	5190	45.21	46.54	47.26	PASS
46	5230	45.53	47.06	48.10	PASS

**802.11ac (VHT80)**

Channel	Channel Frequency (MHz)	26dBc Bandwidth (MHz)			Pass / Fail
		Chain 0	Chain 1	Chain 2	
42	5210	87.14	87.30	86.59	PASS

### SPECTRUM PLOT OF WORST VALUE

**802.11a**

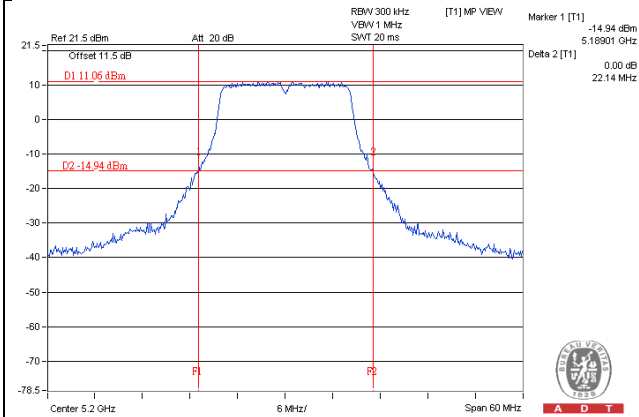

**802.11n (HT20)**

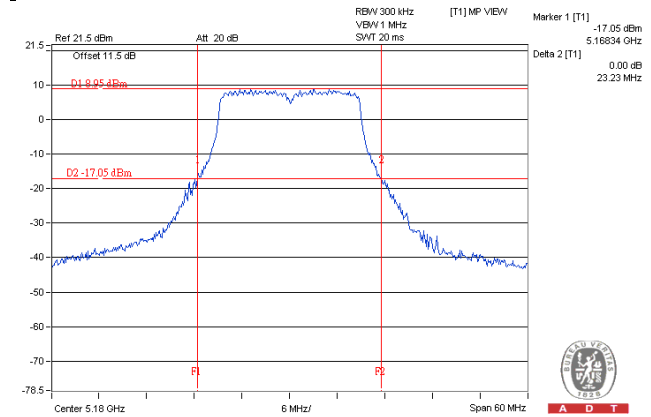

**802.11n (HT40)**

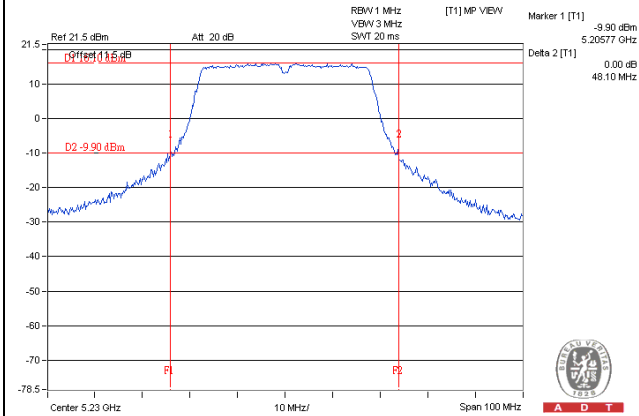

**802.11ac (VHT80)**

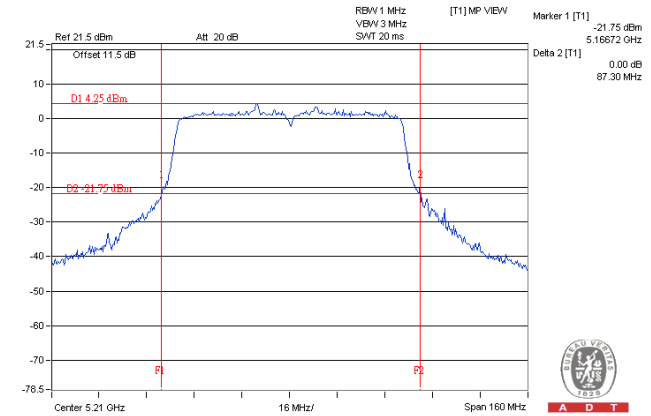

**OCCUPIED BANDWIDTH:**
**802.11a**

Channel	Channel Frequency (MHz)	Occupied Bandwidth (MHz)			Pass / Fail
		Chain 0	Chain 1	Chain 2	
36	5180	16.68	16.80	16.80	PASS
40	5200	16.68	16.68	16.80	PASS
48	5240	16.68	16.68	16.80	PASS
149	5745	16.78	16.78	16.70	PASS
157	5785	16.80	16.80	16.68	PASS
165	5825	16.80	16.68	16.68	PASS

**802.11n (HT20)**

Channel	Channel Frequency (MHz)	Occupied Bandwidth (MHz)			Pass / Fail
		Chain 0	Chain 1	Chain 2	
36	5180	17.88	17.76	18.00	PASS
40	5200	17.88	17.76	17.88	PASS
48	5240	17.76	17.76	17.88	PASS
149	5745	17.88	17.88	17.88	PASS
157	5785	17.88	17.88	17.88	PASS
165	5825	18.00	17.88	17.76	PASS

**802.11n (HT40)**

Channel	Channel Frequency (MHz)	Occupied Bandwidth (MHz)			Pass / Fail
		Chain 0	Chain 1	Chain 2	
38	5190	36.84	36.96	36.96	PASS
46	5230	36.96	36.96	37.08	PASS
151	5755	36.84	36.96	37.08	PASS
159	5795	36.84	36.96	36.84	PASS

**802.11ac (VHT80)**

Channel	Channel Frequency (MHz)	Occupied Bandwidth (MHz)			Pass / Fail
		Chain 0	Chain 1	Chain 2	
42	5210	75.84	75.84	76.08	PASS
155	5775	75.84	76.08	76.08	PASS

### SPECTRUM PLOT OF WORST VALUE

802.11a

802.11n (HT20)

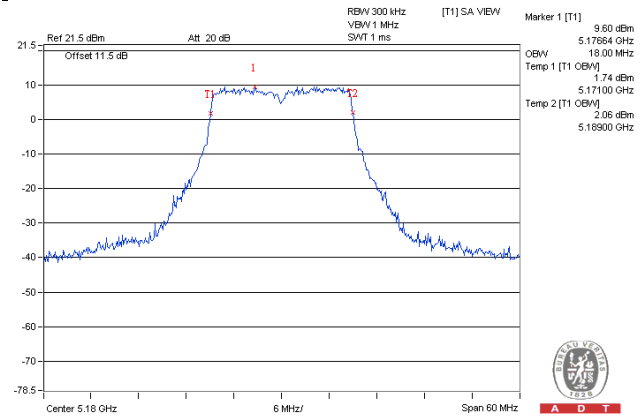
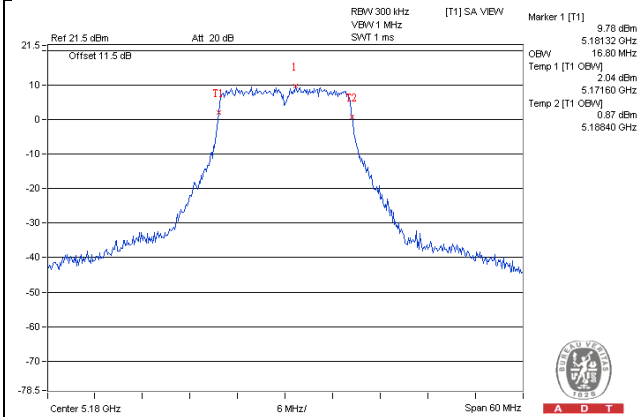

802.11n (HT40)

802.11ac (VHT80)

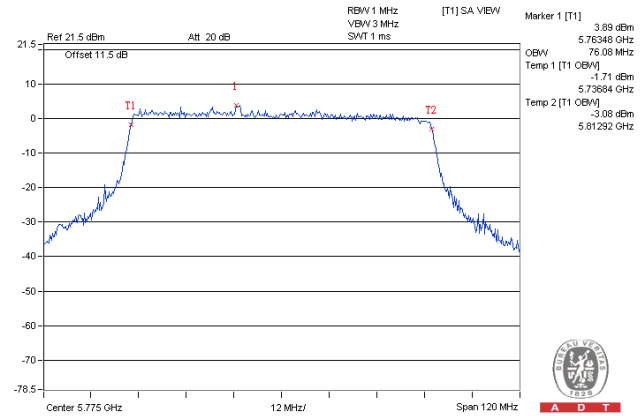
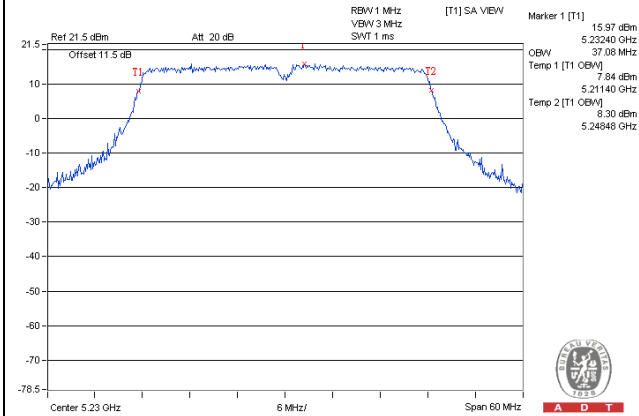

## 4.4 Peak Power Spectral Density Measurement

### 4.4.1 Limits of Peak Power Spectral Density Measurement

Operation Band	EUT Category		LIMIT
U-NII-1		Outdoor Access Point	17dBm/ MHz
		Fixed point-to-point Access Point	
	√	Indoor Access Point	
		Mobile and Portable client device	11dBm/ MHz
U-NII-2A	---		11dBm/ MHz
U-NII-2C	---		11dBm/ MHz
U-NII-3	√		30dBm/ 500kHz

### 4.4.2 Test Setup

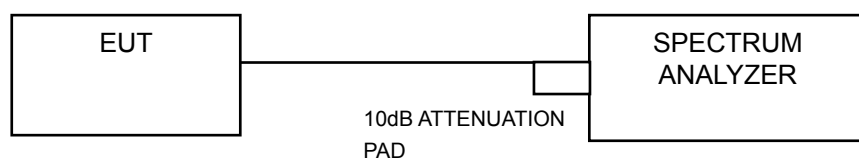

### 4.4.3 Test Instruments

Refer to section 4.1.2 to get information of above instrument.

### 4.4.4 Test Procedure

#### For U-NII-1 band:

Using method SA-2

- 1) Set span to encompass the entire emission bandwidth (EBW) of the signal.
- 2) Set RBW = 1MHz, Set VBW ≥ 3MHz, Detector = RMS
- 3) Set Channel power measure = 1MHz
- 4) Sweep time = auto, trigger set to "free run".
- 5) Trace average at least 100 traces in power averaging mode.
- 6) Record the max value and add 10 log (1/duty cycle)

#### For U-NII-3 band:

- 1) Set span to encompass the entire emission bandwidth (EBW) of the signal.
- 2) Set RBW = 500 kHz, Set VBW ≥ 3 RBW, Detector = RMS
- 3) Sweep time = auto, trigger set to "free run".
- 4) Trace average at least 100 traces in power averaging mode.
- 5) Record the max value and add 10 log (1/duty cycle)
- 6) Scale the observed power level to an equivalent value in 500 kHz by adjusting (reducing) the measured power by a bandwidth correction factor (BWCF) where  $BWCF = 10\log(500\text{kHz}/300\text{kHz})$

#### 4.4.5 Deviation from Test Standard

No deviation.

#### 4.4.6 EUT Operating Condition

Same as Item 4.3.6.

#### 4.4.7 Test Results

### For U-NII-1 Band

#### 802.11a

Chan.	Freq. (MHz)	PSD (dBm)			Total PSD w/o Duty Factor (dBm)	Duty Factor	Total PSD with Duty Factor (dBm)	Max. Limit (dBm)	Pass / Fail
		Chain 0	Chain 1	Chain 2					
36	5180	6.30	5.42	6.37	10.82	0.18	11.00	12.23	Pass
40	5200	6.79	6.16	6.77	11.35	0.18	11.53	12.23	Pass
48	5240	6.17	5.34	6.31	10.73	0.18	10.91	12.23	Pass

**NOTE:** 1. Method 1 of power density measurement of KDB 662911 is using for calculating total power density. Total power density is summing entire spectra across corresponding frequency bins on the various outputs by computer.

**2. For U-NII-1 Band:**

Internal antenna: Directional gain =  $10 \log[(10^{G1/20} + 10^{G2/20} + \dots + 10^{GN/20})^2/3]$  = 10.57 dBi

External antenna: Directional gain = 6dBi + 10log(3) = 10.77dBi

The Max. gain: 10.77dBi > 6dBi , so the power density limit shall be reduced to 17-(10.77-6) = 12.23dBm.

#### 802.11n (HT20)

Chan.	Freq. (MHz)	PSD (dBm)			Total PSD w/o Duty Factor (dBm)	Duty Factor	Total PSD with Duty Factor (dBm)	Max. Limit (dBm)	Pass / Fail
		Chain 0	Chain 1	Chain 2					
36	5180	6.20	4.96	5.94	10.50	0.42	10.92	12.23	Pass
40	5200	6.38	5.03	6.50	10.79	0.42	11.21	12.23	Pass
48	5240	5.78	5.03	6.21	10.47	0.42	10.89	12.23	Pass

**NOTE:** 1. Method 1 of power density measurement of KDB 662911 is using for calculating total power density. Total power density is summing entire spectra across corresponding frequency bins on the various outputs by computer.

**2. For U-NII-1 Band:**

Internal antenna: Directional gain =  $10 \log[(10^{G1/20} + 10^{G2/20} + \dots + 10^{GN/20})^2/3]$  = 10.57 dBi

External antenna: Directional gain = 6dBi + 10log(3) = 10.77dBi

The Max. gain: 10.77dBi > 6dBi , so the power density limit shall be reduced to 17-(10.77-6) = 12.23dBm.



**802.11n (HT40)**

Chan.	Freq. (MHz)	PSD (dBm)			Total PSD w/o Duty Factor (dBm)	Duty Factor	Total PSD with Duty Factor (dBm)	Max. Limit (dBm)	Pass / Fail
		Chain 0	Chain 1	Chain 2					
38	5190	-1.91	-2.44	-1.56	2.82	0.34	3.16	12.23	Pass
46	5230	4.99	4.96	5.55	9.95	0.34	10.29	12.23	Pass

**NOTE:** 1. Method 1 of power density measurement of KDB 662911 is using for calculating total power density. Total power density is summing entire spectra across corresponding frequency bins on the various outputs by computer.

**2. For U-NII-1 Band:**

Internal antenna: Directional gain =  $10 \log[(10^{G1/20} + 10^{G2/20} + \dots + 10^{GN/20})^2/3]$  = 10.57 dBi

External antenna: Directional gain = 6dBi +  $10 \log(3)$  = 10.77dBi

The Max. gain: 10.77dBi > 6dBi , so the power density limit shall be reduced to  $17 - (10.77 - 6) = 12.23$ dBm.

**802.11n (VHT80)**

Chan.	Freq. (MHz)	PSD (dBm)			Total PSD w/o Duty Factor (dBm)	Duty Factor	Total PSD with Duty Factor (dBm)	Max. Limit (dBm)	Pass / Fail
		Chain 0	Chain 1	Chain 2					
42	5210	-9.03	-8.92	-8.47	-4.03	0.79	-3.24	12.23	Pass

**NOTE:** 1. Method 1 of power density measurement of KDB 662911 is using for calculating total power density. Total power density is summing entire spectra across corresponding frequency bins on the various outputs by computer.

**2. For U-NII-1 Band:**

Internal antenna: Directional gain =  $10 \log[(10^{G1/20} + 10^{G2/20} + \dots + 10^{GN/20})^2/3]$  = 10.57 dBi

External antenna: Directional gain = 6dBi +  $10 \log(3)$  = 10.77dBi

The Max. gain: 10.77dBi > 6dBi , so the power density limit shall be reduced to  $17 - (10.77 - 6) = 12.23$ dBm.

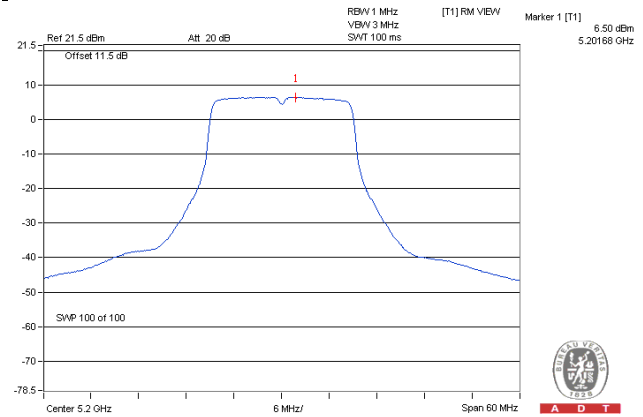
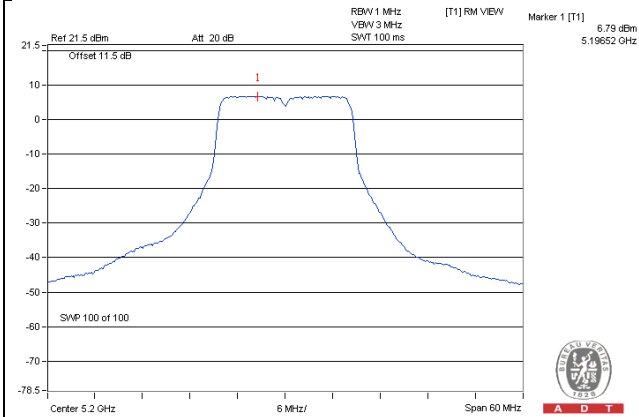
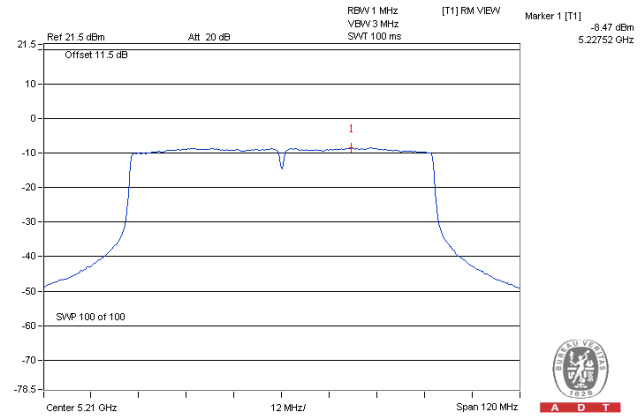
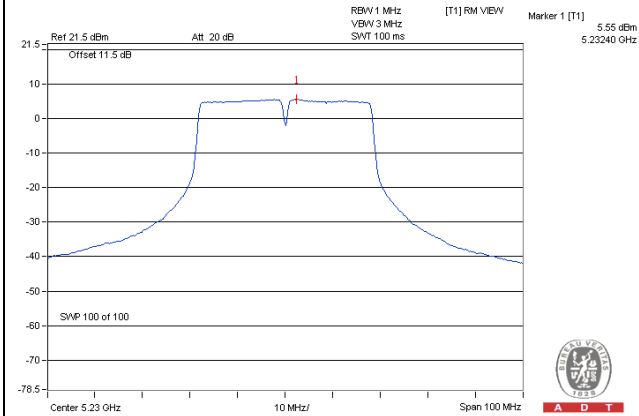
**SPECTRUM PLOT OF WORST VALUE****802.11a****802.11n (HT20)****802.11n (HT40)****802.11ac (VHT80)**

## For U-NII-3 Band

### 802.11a

TX chain	Chan.	Freq. (MHz)	PSD (dBm /300kHz)	PSD (dBm /500kHz)	10 log (N=3) dB	Duty Factor	Total PSD (dBm /500kHz)	Limit (dBm /500kHz)	Pass /Fail
0	149	5745	-3.07	-0.85	4.77	0.18	4.10	25.23	Pass
	157	5785	-0.51	1.71	4.77	0.18	6.66	25.23	Pass
	165	5825	-0.21	2.01	4.77	0.18	6.96	25.23	Pass
1	149	5745	-2.05	0.17	4.77	0.18	5.12	25.23	Pass
	157	5785	-0.34	1.88	4.77	0.18	6.83	25.23	Pass
	165	5825	-0.98	1.24	4.77	0.18	6.19	25.23	Pass
2	149	5745	-2.18	0.04	4.77	0.18	4.99	25.23	Pass
	157	5785	-0.40	1.82	4.77	0.18	6.77	25.23	Pass
	165	5825	-0.53	1.69	4.77	0.18	6.64	25.23	Pass

**NOTE:** Internal antenna: Directional gain =  $10 \log[(10^{G1/20} + 10^{G2/20} + \dots + 10^{GN/20})^2/3] = 10.57 \text{ dBi}$

External antenna: Directional gain =  $6\text{dBi} + 10\log(3) = 10.77\text{dBi}$

The Max. gain:  $10.77\text{dBi} > 6\text{dBi}$ , so the power density limit shall be reduced to  $30 - (10.77 - 6) = 25.23\text{dBm}$ .

### 802.11n (HT20)

TX chain	Chan.	Freq. (MHz)	PSD (dBm /300kHz)	PSD (dBm /500kHz)	10 log (N=3) dB	Duty Factor	Total PSD (dBm /500kHz)	Limit (dBm /500kHz)	Pass /Fail
0	149	5745	-4.71	-2.49	4.77	0.42	2.70	25.23	Pass
	157	5785	-1.27	0.95	4.77	0.42	6.14	25.23	Pass
	165	5825	-0.53	1.69	4.77	0.42	6.88	25.23	Pass
1	149	5745	-3.41	-1.19	4.77	0.42	4.00	25.23	Pass
	157	5785	-0.46	1.76	4.77	0.42	6.95	25.23	Pass
	165	5825	-1.90	0.32	4.77	0.42	5.51	25.23	Pass
2	149	5745	-3.52	-1.30	4.77	0.42	3.89	25.23	Pass
	157	5785	-0.96	1.26	4.77	0.42	6.45	25.23	Pass
	165	5825	-1.19	1.03	4.77	0.42	6.22	25.23	Pass

**NOTE:** Internal antenna: Directional gain =  $10 \log[(10^{G1/20} + 10^{G2/20} + \dots + 10^{GN/20})^2/3] = 10.57 \text{ dBi}$

External antenna: Directional gain =  $6\text{dBi} + 10\log(3) = 10.77\text{dBi}$

The Max. gain:  $10.77\text{dBi} > 6\text{dBi}$ , so the power density limit shall be reduced to  $30 - (10.77 - 6) = 25.23\text{dBm}$ .

**802.11n (HT40)**

TX chain	Chan.	Freq. (MHz)	PSD (dBm /300kHz)	PSD (dBm /500kHz)	10 log (N=3) dB	Duty Factor	Total PSD (dBm /500kHz)	Limit (dBm /500kHz)	Pass /Fail
0	151	5755	-9.87	-7.65	4.77	0.34	-2.54	25.23	Pass
	159	5795	-4.83	-2.61	4.77	0.34	2.50	25.23	Pass
1	151	5755	-9.42	-7.20	4.77	0.34	-2.09	25.23	Pass
	159	5795	-5.48	-3.26	4.77	0.34	1.85	25.23	Pass
2	151	5755	-9.61	-7.39	4.77	0.34	-2.28	25.23	Pass
	159	5795	-5.11	-2.89	4.77	0.34	2.22	25.23	Pass

**NOTE:** Internal antenna: Directional gain =  $10 \log[(10^{G1/20} + 10^{G2/20} + \dots + 10^{GN/20})^2/3]$  = 10.57 dBi  
 External antenna: Directional gain = 6dBi + 10log(3) = 10.77dBi  
 The Max. gain: 10.77dBi > 6dBi , so the power density limit shall be reduced to 30-(10.77-6) = 25.23dBm.

**802.11ac (VHT80)**

TX chain	Chan.	Freq. (MHz)	PSD (dBm /300kHz)	PSD (dBm /500kHz)	10 log (N=3) dB	Duty Factor	Total PSD (dBm /500kHz)	Limit (dBm /500kHz)	Pass /Fail
0	155	5775	-16.68	-14.46	4.77	0.79	-8.90	25.23	Pass
1	155	5775	-12.21	-9.99	4.77	0.79	-4.43	25.23	Pass
2	155	5775	-16.87	-14.65	4.77	0.79	-9.09	25.23	Pass

**NOTE:** Internal antenna: Directional gain =  $10 \log[(10^{G1/20} + 10^{G2/20} + \dots + 10^{GN/20})^2/3]$  = 10.57 dBi  
 External antenna: Directional gain = 6dBi + 10log(3) = 10.77dBi  
 The Max. gain: 10.77dBi > 6dBi , so the power density limit shall be reduced to 30-(10.77-6) = 25.23dBm.

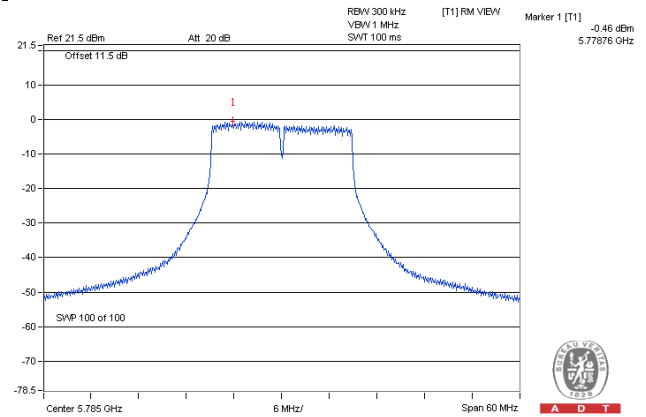
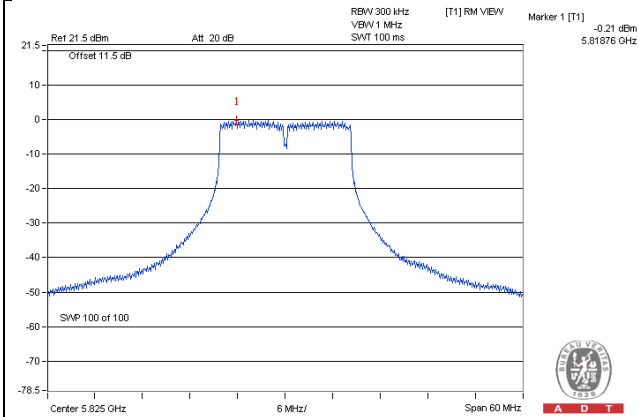
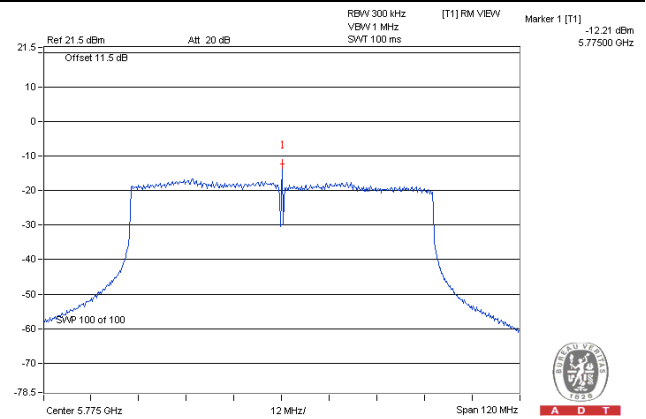
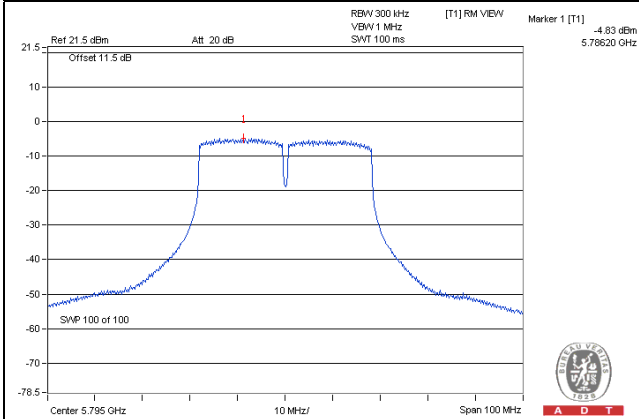
**SPECTRUM PLOT OF WORST VALUE****802.11a****802.11n (HT20)****802.11n (HT40)****802.11ac (VHT80)**

## 4.5 Frequency Stability

### 4.5.1 Limits of Frequency Stability Measurement

The frequency of the carrier signal shall be maintained within band of operation

### 4.5.2 Test Setup

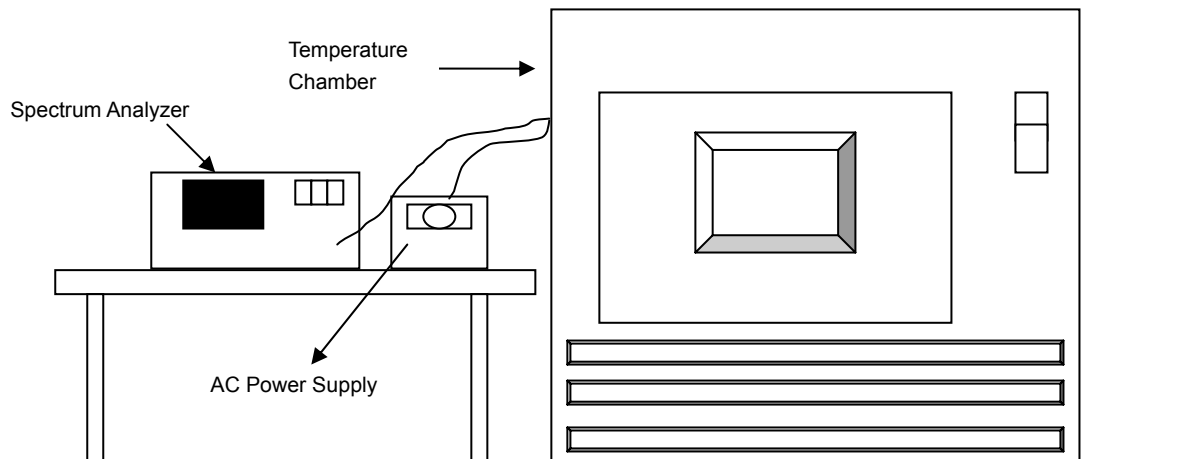

### 4.5.3 Test Instruments

Refer to section 4.1.2 to get information of above instrument.

### 4.5.4 Test Procedure

- The EUT was placed inside the environmental test chamber and powered by nominal AC voltage.
- Turn the EUT on and couple its output to a spectrum analyzer.
- Turn the EUT off and set the chamber to the highest temperature specified.
- Allow sufficient time (approximately 30 min) for the temperature of the chamber to stabilize, turn the EUT on and measure the operating frequency after 2, 5, and 10 minutes.
- Repeat step 2 and 3 with the temperature chamber set to the lowest temperature.
- The test chamber was allowed to stabilize at +20 degree C for a minimum of 30 minutes. The supply voltage was then adjusted on the EUT from 85% to 115% and the frequency record.

### 4.5.5 Deviation from Test Standard

No deviation.

### 4.5.6 EUT Operating Condition

Set the EUT transmit at un-modulation mode to test frequency stability.

**4.5.7 Test Results**

FREQUENCY STABILITY VERSUS TEMP.									
OPERATING FREQUENCY: 5240MHz									
TEMP. (°C)	POWER SUPPLY (Vac)	0 MINUTE		2 MINUTE		5 MINUTE		10 MINUTE	
		Measured Frequency( MHz)	Frequency Drift (%)	Measured Frequency( MHz)	Frequency Drift (%)	Measured Frequency( MHz)	Frequency Drift (%)	Measured Frequency( MHz)	Frequency Drift (%)
50	120	5240.0087	0.00017	5240.0111	0.00021	5240.0119	0.00023	5240.0100	0.00019
40	120	5239.9899	-0.00019	5239.9867	-0.00025	5239.9868	-0.00025	5239.9878	-0.00023
30	120	5239.9941	-0.00011	5239.9912	-0.00017	5239.9919	-0.00015	5239.9941	-0.00011
20	120	5239.9998	0.00000	5239.9999	0.00000	5239.9989	-0.00002	5239.9956	-0.00008
10	120	5239.9870	-0.00025	5239.9861	-0.00027	5239.9894	-0.00020	5239.9868	-0.00025
0	120	5240.0035	0.00007	5240.0056	0.00011	5240.0027	0.00005	5240.0063	0.00012
-10	120	5240.0168	0.00032	5240.018	0.00034	5240.0188	0.00036	5240.0193	0.00037
-20	120	5239.9889	-0.00021	5239.9921	-0.00015	5239.9907	-0.00018	5239.9886	-0.00022
-30	120	5240.0065	0.00012	5240.0051	0.00010	5240.0043	0.00008	5240.0042	0.00008

FREQUENCY STABILITY VERSUS TEMP.									
OPERATING FREQUENCY: 5240MHz									
TEMP. (°C)	POWER SUPPLY (Vac)	0 MINUTE		2 MINUTE		5 MINUTE		10 MINUTE	
		Measured Frequency( MHz)	Frequency Drift (%)	Measured Frequency( MHz)	Frequency Drift (%)	Measured Frequency( MHz)	Frequency Drift (%)	Measured Frequency( MHz)	Frequency Drift (%)
20	138	5240.0001	0.00000	5240.0001	0.00000	5239.999	-0.00002	5239.9951	-0.00009
	120	5239.9998	0.00000	5239.9999	0.00000	5239.9989	-0.00002	5239.9956	-0.00008
	102	5239.9995	-0.00001	5239.9996	-0.00001	5239.9998	0.00000	5239.9954	-0.00009

## 4.6 6dB Bandwidth Measurement

### 4.6.1 Limits of 6dB Bandwidth Measurement

The minimum of 6dB Bandwidth Measurement is 0.5MHz.

### 4.6.2 Test Setup

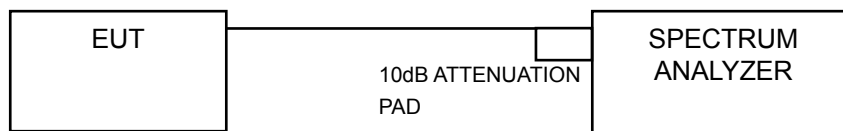

### 4.6.3 Test Instruments

Refer to section 4.1.2 to get information of above instrument.

### 4.6.4 Test Procedure

#### MEASUREMENT PROCEDURE REF

- Set resolution bandwidth (RBW) = 100kHz
- Set the video bandwidth (VBW)  $\geq 3 \times$  RBW, Detector = Peak.
- Trace mode = max hold.
- Sweep = auto couple.
- Measure the maximum width of the emission that is constrained by the frequencies associated with the two amplitude points (upper and lower) that are attenuated by 6 dB relative to the maximum level measured in the fundamental emission

### 4.6.5 Deviation from Test Standard

No deviation.

### 4.6.6 EUT Operating Condition

The software provided by client to enable the EUT under transmission Condition continuously at lowest, middle and highest channel frequencies individually.



#### 4.6.7 Test Results

##### 802.11a

Channel	Frequency (MHz)	6dB Bandwidth (MHz)			Minimum Limit (MHz)	Pass / Fail
		Chain 0	Chain 1	Chain 2		
149	5745	16.38	16.38	16.41	0.5	PASS
157	5785	16.41	16.41	16.43	0.5	PASS
165	5825	16.41	16.41	16.41	0.5	PASS

##### 802.11n (HT20)

Channel	Frequency (MHz)	6dB Bandwidth (MHz)			Minimum Limit (MHz)	Pass / Fail
		Chain 0	Chain 1	Chain 2		
149	5745	17.64	17.62	17.64	0.5	PASS
157	5785	17.62	17.63	17.65	0.5	PASS
165	5825	17.63	17.64	17.65	0.5	PASS

##### 802.11n (HT40)

Channel	Frequency (MHz)	6dB Bandwidth (MHz)			Minimum Limit (MHz)	Pass / Fail
		Chain 0	Chain 1	Chain 2		
151	5755	36.12	36.45	36.44	0.5	PASS
159	5795	36.16	36.18	36.43	0.5	PASS

##### 802.11ac (VHT80)

Channel	Frequency (MHz)	6dB Bandwidth (MHz)			Minimum Limit (MHz)	Pass / Fail
		Chain 0	Chain 1	Chain 2		
155	5775	73.49	76.23	65.26	0.5	PASS

### SPECTRUM PLOT OF WORST VALUE

802.11a

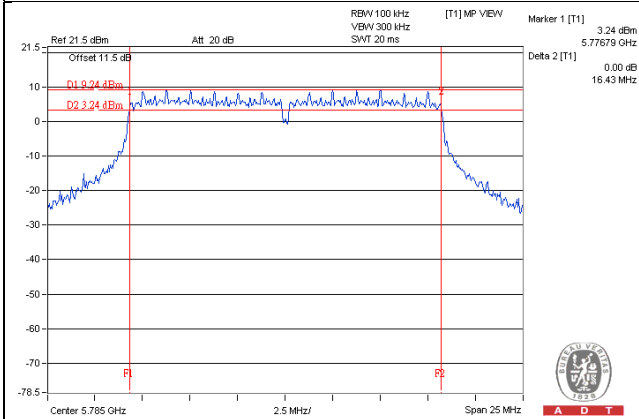

802.11n (HT20)

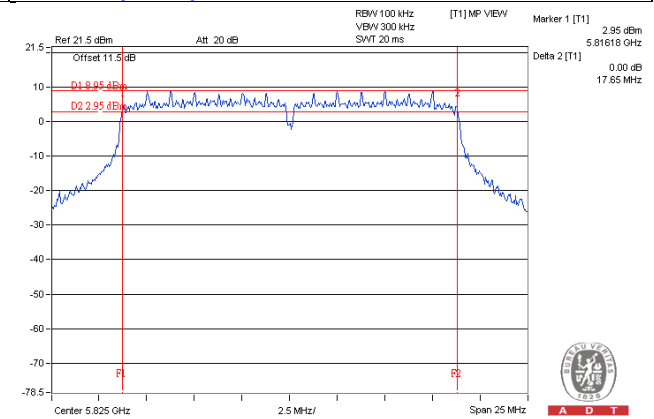

802.11n (HT40)

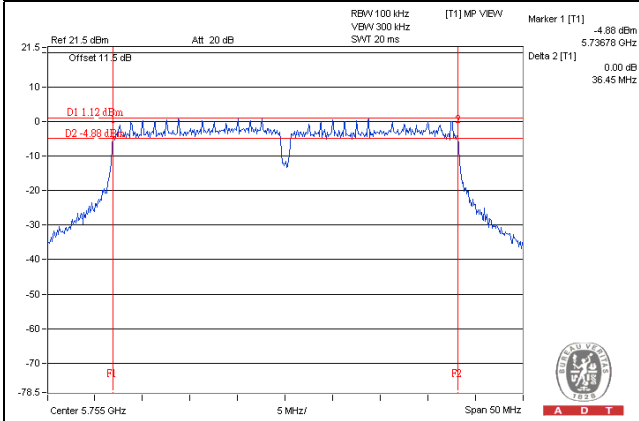

802.11ac (VHT80)

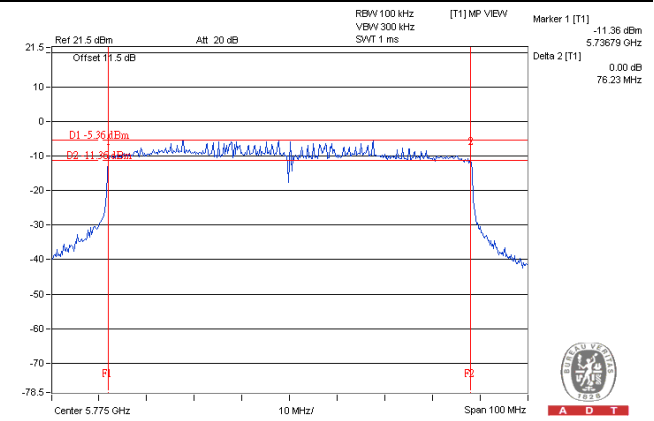

## 5 Pictures of Test Arrangements

Please refer to the attached file (Test Setup Photo).

## Appendix – Information on the Testing Laboratories

We, Bureau Veritas Consumer Products Services (H.K.) Ltd., Taoyuan Branch, were founded in 1988 to provide our best service in EMC, Radio, Telecom and Safety consultation. Our laboratories are accredited and approved according to ISO/IEC 17025.

If you have any comments, please feel free to contact us at the following:

**Linko EMC/RF Lab**

Tel: 886-2-26052180

Fax: 886-2-26051924

**Hsin Chu EMC/RF Lab/Telecom Lab**

Tel: 886-3-5935343

Fax: 886-3-5935342

**Hwa Ya EMC/RF/Safety**

Tel: 886-3-3183232

Fax: 886-3-3270892

**Email:** [service.adt@tw.bureauveritas.com](mailto:service.adt@tw.bureauveritas.com)

**Web Site:** [www.bureauveritas-adt.com](http://www.bureauveritas-adt.com)

The address and road map of all our labs can be found in our web site also.

--- END ---