

FCC Test Report

Report No.: RF150414C33

FCC ID: TVE-23155011

Test Model: FAP-S321CR, FAP-S323CR

Series Model: FortiAP-S321CRxxxxxx, FAP-S321CRxxxxxx, FORTIAP-S321CRxxxxxx, FortiAP-S323CRxxxxxx, FAP-S323CRxxxxxx, FORTIAP-S323CRxxxxxx (where "x" can be used as "A-Z", or "0-9", or "-", or blank for software changes or marketing purposes only)

Received Date: Apr. 29, 2015

Test Date: Apr. 29 ~ May 30, 2015

Issued Date: Jun. 11, 2015

Applicant: Fortinet Inc.

Address: 899 Kifer Road Sunnyvale, CA 94086 USA

Issued By: Bureau Veritas Consumer Products Services (H.K.) Ltd., Taoyuan Branch

Lab Address: No. 47-2, 14th Ling, Chia Pau Vil., Lin Kou Dist., New Taipei City, Taiwan

Test Location: No. 19, Hwa Ya 2nd Rd., Wen Hwa Vil., Kwei Shan Dist., Taoyuan City 33383, TAIWAN (R.O.C.)



This report is for your exclusive use. Any copying or replication of this report to or for any other person or entity, or use of our name or trademark, is permitted only with our prior written permission. This report sets forth our findings solely with respect to the test samples identified herein. The results set forth in this report are not indicative or representative of the quality or characteristics of the lot from which a test sample was taken or any similar or identical product unless specifically and expressly noted. Our report includes all of the tests requested by you and the results thereof based upon the information that you provided to us. You have 60 days from date of issuance of this report to notify us of any material error or omission caused by our negligence, provided, however, that such notice shall be in writing and shall specifically address the issue you wish to raise. A failure to raise such issue within the prescribed time shall constitute your unqualified acceptance of the completeness of this report, the tests conducted and the correctness of the report contents. Unless specific mention, the uncertainty of measurement has been explicitly taken into account to declare the compliance or non-compliance to the specification. This report should not be used by the client to claim product certification, approval, or endorsement by TAF or any government agencies.



Table of Contents

Release Control Record	4
1 Certificate of Conformity	5
2 Summary of Test Results	6
2.1 Measurement Uncertainty.....	6
2.2 Modification Record.....	6
3 General Information	7
3.1 General Description of EUT.....	7
3.2 Description of Test Modes.....	9
3.2.1 Test Mode Applicability and Tested Channel Detail.....	10
3.3 Duty Cycle of Test Signal.....	12
3.4 Description of Support Units.....	13
3.4.1 Configuration of System under Test.....	14
3.5 General Description of Applied Standards.....	15
4 Test Types and Results	16
4.1 Radiated Emission and Bandedge Measurement.....	16
4.1.1 Limits of Radiated Emission and Bandedge Measurement.....	16
4.1.2 Test Instruments.....	17
4.1.3 Test Procedures.....	18
4.1.4 Deviation from Test Standard.....	18
4.1.5 Test Set Up.....	19
4.1.6 EUT Operating Conditions.....	19
4.1.7 Test Results.....	20
4.2 Conducted Emission Measurement.....	48
4.2.1 Limits of Conducted Emission Measurement.....	48
4.2.2 Test Instruments.....	48
4.2.3 Test Procedures.....	49
4.2.4 Deviation from Test Standard.....	49
4.2.5 Test Setup.....	49
4.2.6 EUT Operating Conditions.....	49
4.2.7 Test Results.....	50
4.3 6dB Bandwidth Measurement.....	58
4.3.1 Limits of 6dB Bandwidth Measurement.....	58
4.3.2 Test Setup.....	58
4.3.3 Test Instruments.....	58
4.3.4 Test Procedure.....	58
4.3.5 Deviation from Test Standard.....	58
4.3.6 EUT Operating Conditions.....	58
4.3.7 Test Result.....	59
4.4 Conducted Output Power Measurement.....	61
4.4.1 Limits of Conducted Output Power Measurement.....	61
4.4.2 Test Setup.....	61
4.4.3 Test Instruments.....	61
4.4.4 Test Procedures.....	61
4.4.5 Deviation from Test Standard.....	61
4.4.6 EUT Operating Conditions.....	61
4.4.7 Test Results.....	62
4.5 Power Spectral Density Measurement.....	63
4.5.1 Limits of Power Spectral Density Measurement.....	63
4.5.2 Test Setup.....	63
4.5.3 Test Instruments.....	63
4.5.4 Test Procedure.....	63
4.5.5 Deviation from Test Standard.....	63
4.5.6 EUT Operating Condition.....	63



4.5.7 Test Results	64
4.6 Conducted Out of Band Emission Measurement.....	67
4.6.1 Limits of Conducted Out of Band Emission Measurement	67
4.6.2 Test Setup.....	67
4.6.3 Test Instruments	67
4.6.4 Test Procedure	67
4.6.5 Deviation from Test Standard	67
4.6.6 EUT Operating Condition	67
4.6.7 Test Results	67
5 Pictures of Test Arrangements.....	80
Appendix – Information on the Testing Laboratories	81



A D T

Release Control Record

Issue No.	Description	Date Issued
RF150414C33	Original release.	Jun. 11, 2015

1 Certificate of Conformity

Product: Secured Wireless Access Point

Brand: Fortinet Inc.

Test Model: FAP-S321CR, FAP-S323CR

Series Model: FortiAP-S321CRxxxxxx, FAP-S321CRxxxxxx, FORTIAP-S321CRxxxxxx, FortiAP-S323CRxxxxxx, FAP-S323CRxxxxxx, FORTIAP-S323CRxxxxxx (where "x" can be used as "A-Z", or "0-9", or "-", or blank for software changes or marketing purposes only)

Sample Status: Engineering sample

Applicant: Fortinet Inc.

Test Date: Apr. 29 ~ May 30, 2015

Standards: 47 CFR FCC Part 15, Subpart C (Section 15.247)
ANSI C63.10:2009

The above equipment has been tested by **Bureau Veritas Consumer Products Services (H.K.) Ltd., Taoyuan Branch**, and found compliance with the requirement of the above standards. The test record, data evaluation & Equipment Under Test (EUT) configurations represented herein are true and accurate accounts of the measurements of the sample's EMC characteristics under the conditions specified in this report.

Prepared by :  , **Date:** Jun. 11, 2015
Pettie Chen / Senior Specialist

Approved by :  , **Date:** Jun. 11, 2015
Ken Liu / Senior Manager

2 Summary of Test Results

47 CFR FCC Part 15, Subpart C (SECTION 15.247)			
FCC Clause	Test Item	Result	Remarks
15.207	AC Power Conducted Emission	PASS	Meet the requirement of limit. Minimum passing margin is -5.33dB at 0.15000MHz.
15.205 / 15.209 / 15.247(d)	Radiated Emissions and Band Edge Measurement	PASS	Meet the requirement of limit. Minimum passing margin is -1.0dB at 2390.00, 2483.50MHz.
15.247(d)	Antenna Port Emission	PASS	Meet the requirement of limit.
15.247(a)(2)	6dB bandwidth	PASS	Meet the requirement of limit.
15.247(b)	Conducted power	PASS	Meet the requirement of limit.
15.247(e)	Power Spectral Density	PASS	Meet the requirement of limit.
15.203	Antenna Requirement	PASS	Printed Antenna: Antenna connector is I-PEX not a standard connector. Dipole Antenna: Antenna connector is SMA jack RP not a standard connector.

2.1 Measurement Uncertainty

Where relevant, the following measurement uncertainty levels have been estimated for tests performed on the EUT as specified in CISPR 16-4-2:

Measurement	Frequency	Expanded Uncertainty (k=2) (\pm)
Conducted Emissions at mains ports	150kHz ~ 30MHz	2.44 dB
Radiated Emissions up to 1 GHz	30MHz ~ 200MHz	3.86 dB
	200MHz ~ 1000MHz	3.87 dB
Radiated Emissions above 1 GHz	1GHz ~ 18GHz	2.29 dB
	18GHz ~ 40GHz	2.29 dB

2.2 Modification Record

There were no modifications required for compliance.

3 General Information

3.1 General Description of EUT

Product	Secured Wireless Access Point
Brand	Fortinet Inc.
Test Model	FAP-S321CR, FAP-S323CR
Series Model	FortiAP-S321CRxxxxxx, FAP-S321CRxxxxxx, FORTIAP-S321CRxxxxxx, FortiAP-S323CRxxxxxx, FAP-S323CRxxxxxx, FORTIAP-S323CRxxxxxx (where “x” can be used as “A-Z”, or “0-9”, or “-”, or blank for software changes or marketing purposes only)
Model Difference	Refer to note
Status of EUT	Engineering sample
Power Supply Rating	12Vdc from adapter 48Vdc from PoE
Modulation Type	CCK, DQPSK, DBPSK for DSSS 64QAM, 16QAM, QPSK, BPSK for OFDM
Modulation Technology	DSSS, OFDM
Transfer Rate	802.11b:11.0/ 5.5/ 2.0/ 1.0Mbps 802.11g: 54.0/ 48.0/ 36.0/ 24.0/ 18.0/ 12.0/ 9.0/ 6.0Mbps 802.11n: up to 450.0Mbps
Operating Frequency	2412 ~ 2462MHz
Number of Channel	11 for 802.11b, 802.11g, 802.11n (HT20) 7 for 802.11n (HT40)
Output Power	863.299mW
Antenna Type	Refer to Note
Antenna Connector	Refer to Note
Accessory Device	NA
Data Cable Supplied	NA

Note:

- All models are listed as below. All models are hardware, software, electrically identical, different model names are for different antennas.

Brand	Model	Difference
Fortinet Inc.	FortiAP-S321CRxxxxxx	“x” can be used as “A-Z”, or “0-9”, or “-”, or blank for software changes or marketing purposes only
	FAP-S321CRxxxxxx (Main test model: FAP-S321CR)	
	FORTIAP-S321CRxxxxxx	
	FortiAP-S323CRxxxxxx	With External Antenna
	FAP-S323CRxxxxxx (Main test model: FAP-S323CR)	
	FORTIAP-S323CRxxxxxx	

2. The EUT incorporates a MIMO function. Physically, the EUT provides 3 completed transmitters and 3 receivers.

Modulation Mode	TX Function
802.11b	3TX
802.11g	3TX
802.11n (HT20)	3TX
802.11n (HT40)	3TX

* The EUT doesn't support diversity function.

3. The EUT consumes power from the following adapter and PoE (provided as support units only).

Adapter	
Brand	Powertron Electronics Corp.
Model	PA1024-2HUB PA1024-2HU PA1024-120HUB200
Input Power	100-240Vac, 50-60Hz, 0.6A
Output Power	12Vdc, 2.0A, 24W Max
Power Line	DC 1.5m power cable with 1 core attached on adapter

PoE	
Brand	EnGenius
Model	EPE-48GR
Rating	48Vdc, 0.8A

Adapter of PoE	
Brand	Powertron Electronics Corp.
Model	PA1040-480IB080
Input Power	100-240Vac, 50-60Hz 1.5A
Output Power	48Vdc, 0.8A, 38.4W Max
Power Line	DC 1.55m power cable with 1 core attached on adapter

4. The following antennas were provided to the EUT.

No.	Type	Gain(dBi)		Connector
		2.4GHz Band	5GHz Band	
1	Printed	Ant. 1: 3.51dBi	Ant. 4: 6.48dBi	IPEX
		Ant. 2: 2.99dBi	Ant. 5: 5.20dBi	
		Ant. 3: 3.21dBi	Ant. 6: 5.66dBi	
2	Dipole	4dBi	6dBi	SMA jack RP

5. The above EUT information is declared by manufacturer and for more detailed features description, please refer to the manufacturer's specifications or user's manual.

3.2 Description of Test Modes

11 channels are provided for 802.11b, 802.11g and 802.11n (HT20):

Channel	Frequency	Channel	Frequency
1	2412MHz	7	2442MHz
2	2417MHz	8	2447MHz
3	2422MHz	9	2452MHz
4	2427MHz	10	2457MHz
5	2432MHz	11	2462MHz
6	2437MHz		

7 channels are provided for 802.11n (HT40):

Channel	Frequency	Channel	Frequency
3	2422MHz	7	2442MHz
4	2427MHz	8	2447MHz
5	2432MHz	9	2452MHz
6	2437MHz		

3.2.1 Test Mode Applicability and Tested Channel Detail

EUT CONFIGURE MODE	APPLICABLE TO				DESCRIPTION	
	RE≥1G	RE<1G	PLC	APCM	EUT Antenna	Power Supply
A	√	√	√	-	Internal antenna	Power form PoE
B	-	√	√	-		Power from adapter
C	√	√	√	√	External antenna	Power form PoE
D	-	√	√	-		Power from adapter

Where **RE≥1G**: Radiated Emission above 1GHz & Bandedge Measurement **RE<1G**: Radiated Emission below 1GHz
PLC: Power Line Conducted Emission **APCM**: Antenna Port Conducted Measurement

Note: 1. The EUT had been pre-tested on the positioned of each 3 axis. The worst case was found when positioned on **Y-plane** for mode A & B while on **X-plane** for mode C & D.
2. "-" means no effect.

Radiated Emission Test (Above 1GHz):

- Pre-Scan has been conducted to determine the worst-case mode from all possible combinations between available modulations, data rates and antenna ports (if EUT with antenna diversity architecture).
- Following channel(s) was (were) selected for the final test as listed below.

EUT CONFIGURE MODE	MODE	AVAILABLE CHANNEL	TESTED CHANNEL	MODULATION TECHNOLOGY	MODULATION TYPE	DATA RATE (Mbps)
A, C	802.11b	1 to 11	1, 6, 11	DSSS	DBPSK	1.0
A, C	802.11g	1 to 11	1, 6, 11	OFDM	BPSK	6.0
A, C	802.11n (HT20)	1 to 11	1, 6, 11	OFDM	BPSK	7.2
A, C	802.11n (HT40)	3 to 9	3, 6, 9	OFDM	BPSK	15.0

Radiated Emission Test (Below 1GHz):

- Pre-Scan has been conducted to determine the worst-case mode from all possible combinations between available modulations, data rates and antenna ports (if EUT with antenna diversity architecture).
- Following channel(s) was (were) selected for the final test as listed below.

EUT CONFIGURE MODE	MODE	AVAILABLE CHANNEL	TESTED CHANNEL	MODULATION TECHNOLOGY	MODULATION TYPE	DATA RATE (Mbps)
A, B, C, D	802.11b	1 to 11	6	DSSS	DBPSK	1.0

Power Line Conducted Emission Test:

- Pre-Scan has been conducted to determine the worst-case mode from all possible combinations between available modulations, data rates and antenna ports (if EUT with antenna diversity architecture).
- Following channel(s) was (were) selected for the final test as listed below.

EUT CONFIGURE MODE	MODE	AVAILABLE CHANNEL	TESTED CHANNEL	MODULATION TECHNOLOGY	MODULATION TYPE	DATA RATE (Mbps)
A, B, C, D	802.11b	1 to 11	6	DSSS	DBPSK	1.0

Antenna Port Conducted Measurement:

- This item includes all test value of each mode, but only includes spectrum plot of worst value of each mode.
- Pre-Scan has been conducted to determine the worst-case mode from all possible combinations between available modulations, data rates and antenna ports (if EUT with antenna diversity architecture).
- Following channel(s) was (were) selected for the final test as listed below.

EUT CONFIGURE MODE	MODE	AVAILABLE CHANNEL	TESTED CHANNEL	MODULATION TECHNOLOGY	MODULATION TYPE	DATA RATE (Mbps)
C	802.11b	1 to 11	1, 6, 11	DSSS	DBPSK	1.0
C	802.11g	1 to 11	1, 6, 11	OFDM	BPSK	6.0
C	802.11n (HT20)	1 to 11	1, 6, 11	OFDM	BPSK	7.2
C	802.11n (HT40)	3 to 9	3, 6, 9	OFDM	BPSK	15.0

Test Condition:

APPLICABLE TO	ENVIRONMENTAL CONDITIONS	INPUT POWER	TESTED BY
RE \geq 1G	18deg. C, 70%RH	48Vdc	Nick Hsu
RE $<$ 1G	20deg. C, 70%RH 19deg. C, 68%RH	48Vdc 120Vac, 60Hz	Jones Chang
PLC	20deg. C, 70%RH 19deg. C, 68%RH	48Vdc 120Vac, 60Hz	Jones Chang
APCM	25deg. C, 60%RH	48Vdc	Nick Chen

3.3 Duty Cycle of Test Signal

Duty cycle of test signal is $\geq 98\%$, duty factor is not required.
 Duty cycle of test signal is $< 98\%$, duty factor shall be considered.

802.11b: Duty cycle = $12.163/12.288 = 0.99$

802.11g: Duty cycle = $2.024/2.106 = 0.961$, Duty factor = $10 * \log(1/0.961) = 0.17$

802.11n (HT20): Duty cycle = $1.882/1.963 = 0.959$, Duty factor = $10 * \log(1/0.959) = 0.18$

802.11n (HT40): Duty cycle = $0.924/1 = 0.924$, Duty factor = $10 * \log(1/0.924) = 0.34$

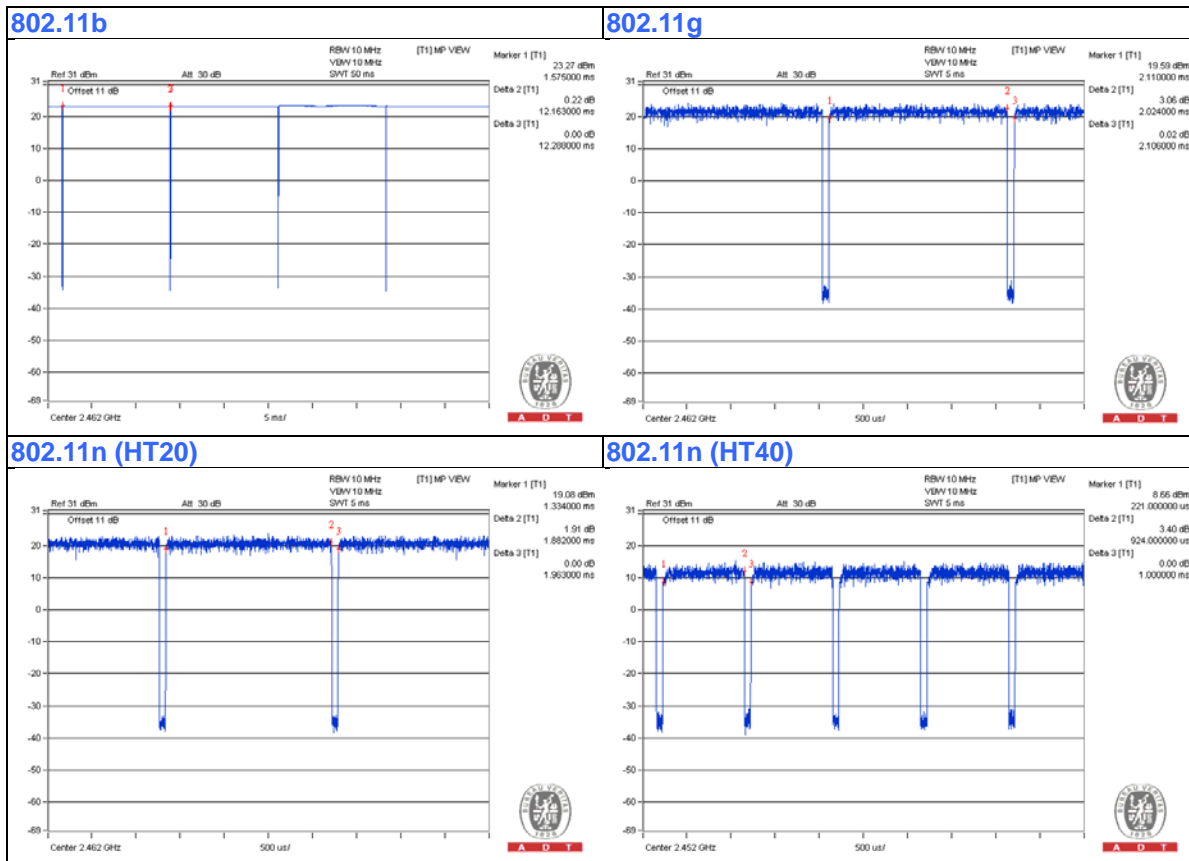

3.4 Description of Support Units

The EUT has been tested as an independent unit together with other necessary accessories or support units. The following support units or accessories were used to form a representative test configuration during the tests.

ID	Product	Brand	Model No.	Serial No.	FCC ID	Remarks
A.	Notebook	DELL	E5410	1HC2XM1	FCC DoC Approved	-
B.	Flash Drive	Transcend	V85	538455 4489		
C.	Load	NA	NA	NA	NA	-
D.	PoE	EnGenius	EPE-48GR	NA	NA	Supplied by the manufacturer
E.	Adapter of PoE	Powertron Electronics Corp.	PA1040-480IB080	NA	NA	Supplied by the manufacturer
F.	Adapter	Powertron Electronics Corp.	PA1024-2HUB PA1024-2HU PA1024-120HUB200	NA	NA	Supplied by the manufacturer

Note:

1. All power cords of the above support units are non-shielded (1.8m).
2. Item A acted as communication partners to transfer data.

ID	Descriptions	Qty.	Length (m)	Shielding (Yes/No)	Cores (Qty.)	Remarks
1.	LAN cable	1	3	N	0	Cat5e
2.	LAN cable	1	1.8	N	0	Cat5e
3.	Console cable	1	1.5	N	0	-
4.	LAN cable	1	1.8	N	0	Cat5e
5.	DC cable	1	1.55	N	1	Attached on adapter
6.	DC cable	1	1.5	N	1	Attached on adapter

Note: The core(s) is(are) originally attached to the cable(s).

3.4.1 Configuration of System under Test

<PoE Mode>

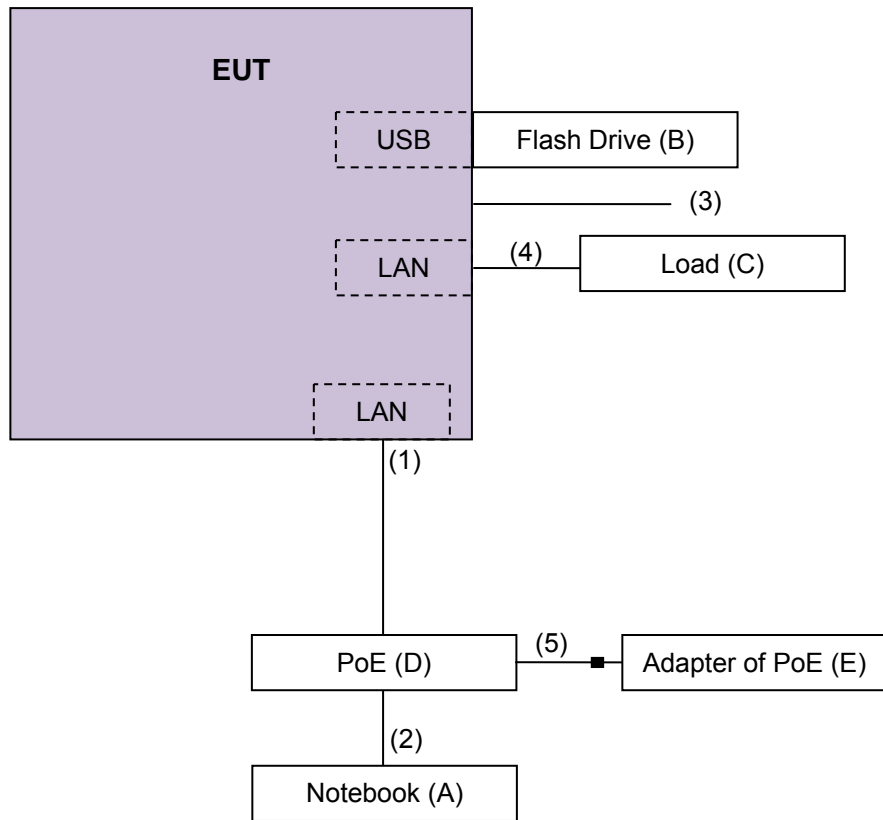

<Adapter Mode>

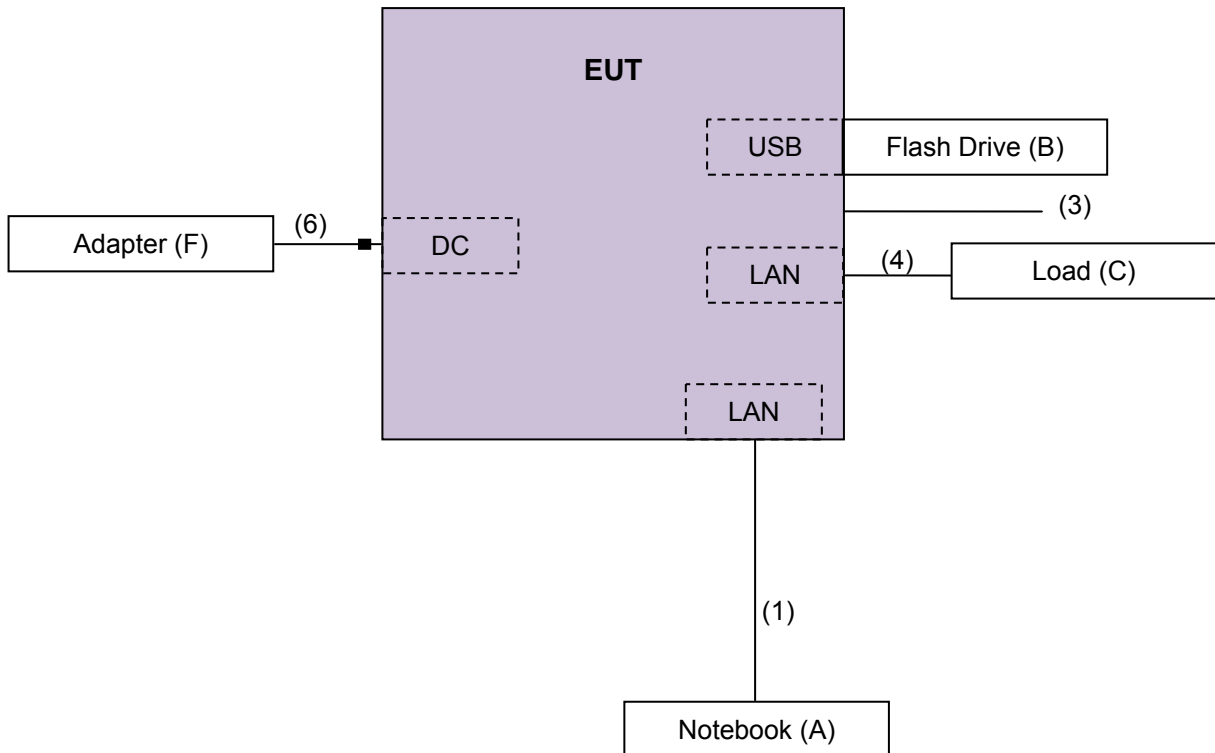



3.5 General Description of Applied Standards

The EUT is a RF Product. According to the specifications of the manufacturer, it must comply with the requirements of the following standards:

FCC Part 15, Subpart C (15.247)
558074 D01 DTS Meas Guidance v03r02
662911 D01 Multiple Transmitter Output v02r01
ANSI C63.10-2009

All test items have been performed and recorded as per the above standards.

NOTE: The EUT has been verified to comply with the requirements of FCC Part 15, Subpart B, Class B (DoC). The test report has been issued separately.

4 Test Types and Results

4.1 Radiated Emission and Bandedge Measurement

4.1.1 Limits of Radiated Emission and Bandedge Measurement

Radiated emissions which fall in the restricted bands must comply with the radiated emission limits specified as below table. Other emissions shall be at least 30dB below the highest level of the desired power:

Frequencies (MHz)	Field Strength (microvolts/meter)	Measurement Distance (meters)
0.009 ~ 0.490	2400/F(kHz)	300
0.490 ~ 1.705	24000/F(kHz)	30
1.705 ~ 30.0	30	30
30 ~ 88	100	3
88 ~ 216	150	3
216 ~ 960	200	3
Above 960	500	3

NOTE:

1. The lower limit shall apply at the transition frequencies.
2. Emission level (dBuV/m) = 20 log Emission level (uV/m).
3. For frequencies above 1000MHz, the field strength limits are based on average detector, however, the peak field strength of any emission shall not exceed the maximum permitted average limits, specified above by more than 30dB under any condition of modulation.

4.1.2 Test Instruments

Description & Manufacturer	Model No.	Serial No.	Cal. Date	Cal. Due
Test Receiver ROHDE & SCHWARZ	ESIB7	100187	Apr. 10, 2015	Apr. 09, 2016
Spectrum Analyzer ROHDE & SCHWARZ	FSP40	100041	Aug. 29, 2014	Aug. 28, 2015
BILOG Antenna SCHWARZBECK	VULB9168	9168-160	Feb. 05, 2015	Feb. 04, 2016
HORN Antenna SCHWARZBECK	9120D	209	Feb. 09, 2015	Feb. 08, 2016
HORN Antenna SCHWARZBECK	BBHA 9170	BBHA9170241	Feb. 09, 2015	Feb. 08, 2016
Preamplifier Agilent	8447D	2944A10738	Oct.18, 2014	Oct. 17, 2015
Preamplifier Agilent	8449B	3008A01964	Aug. 22, 2014	Aug. 21, 2015
RF signal cable HUBER+SUHNNER	SUCOFLEX 104	214378/4	Aug. 22, 2014	Aug. 21, 2015
RF signal cable HUBER+SUHNNER	SUCOFLEX 106	12738/6 +309224/4	Aug. 22, 2014	Aug. 21, 2015
Software BV ADT	ADT_Radiated_ V7.6.15.9.4	NA	NA	NA
Antenna Tower inn-co GmbH	MA 4000	013303	NA	NA
Antenna Tower Controller BV ADT	AT100	AT93021702	NA	NA
Turn Table BV ADT	TT100	TT93021702	NA	NA
Turn Table Controller BV ADT	SC100	SC93021702	NA	NA
High Speed Peak Power Meter	ML2495A	0824011	Jul. 26, 2014	Jul. 25, 2015
Power Sensor	MA2411B	0738171	Jul. 26, 2014	Jul. 25, 2015

NOTE: 1. The calibration interval of the above test instruments is 12 months and the calibrations are traceable to NML/ROC and NIST/USA.

2. The test was performed in HwaYa Chamber 3.

3. The horn antenna and HP preamplifier (model: 8449B) are used only for the measurement of emission frequency above 1GHz if tested.

4. The FCC Site Registration No. is 988962.

5. The IC Site Registration No. is IC 7450F-3.

4.1.3 Test Procedures

- a. The EUT was placed on the top of a rotating table 0.8 meters above the ground at 3 meter chamber room for test. The table was rotated 360 degrees to determine the position of the highest radiation.
- b. The EUT was set 3 meters away from the interference-receiving antenna, which was mounted on the top of a variable-height antenna tower.
- c. The height of antenna is varied from one meter to four meters above the ground to determine the maximum value of the field strength. Both horizontal and vertical polarizations of the antenna are set to make the measurement.
- d. For each suspected emission, the EUT was arranged to its worst case and then the antenna was tuned to heights from 1 meter to 4 meters and the rotatable table was turned from 0 degrees to 360 degrees to find the maximum reading.
- e. The test-receiver system was set to quasi-peak detect function and specified bandwidth with maximum hold mode when the test frequency is below 1 GHz.
- f. The test-receiver system was set to peak and average detect function and specified bandwidth with maximum hold mode when the test frequency is above 1 GHz. If the peak reading value also meets average limit, measurement with the average detector is unnecessary.

Note:

1. For emission measurements above 1 GHz, the EUT shall be placed at a height of 1.5 m above the ground at 3 meter chamber room for test
2. The resolution bandwidth and video bandwidth of test receiver/spectrum analyzer is 120kHz for Quasi-peak detection (QP) at frequency below 1GHz.
3. The resolution bandwidth of test receiver/spectrum analyzer is 1 MHz and the video bandwidth is 3 MHz for Peak detection (PK) at frequency above 1GHz.
4. The resolution bandwidth of test receiver/spectrum analyzer is 1MHz and the video bandwidth is 3MHz for RMS Average (Duty cycle < 98%) for Average detection (AV) at frequency above 1GHz, then the measurement results was added to a correction factor ($10 \log(1/\text{duty cycle})$).
5. The resolution bandwidth of test receiver/spectrum analyzer is 1MHz and the video bandwidth is 10Hz (Duty cycle $\geq 98\%$) for Average detection (AV) at frequency above 1GHz.
6. All modes of operation were investigated and the worst-case emissions are reported.

4.1.4 Deviation from Test Standard

No deviation.

4.1.5 Test Set Up

<Frequency Range below 1GHz>

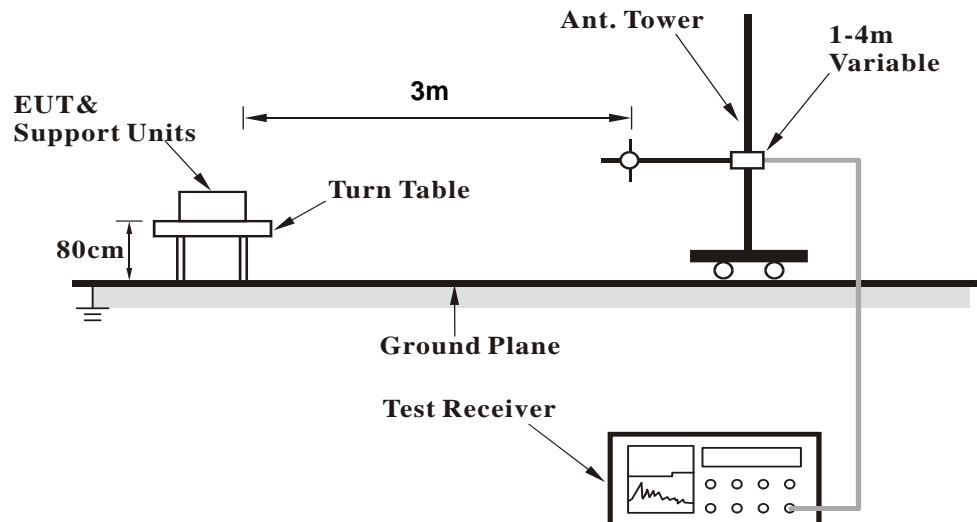

<Frequency Range above 1GHz>

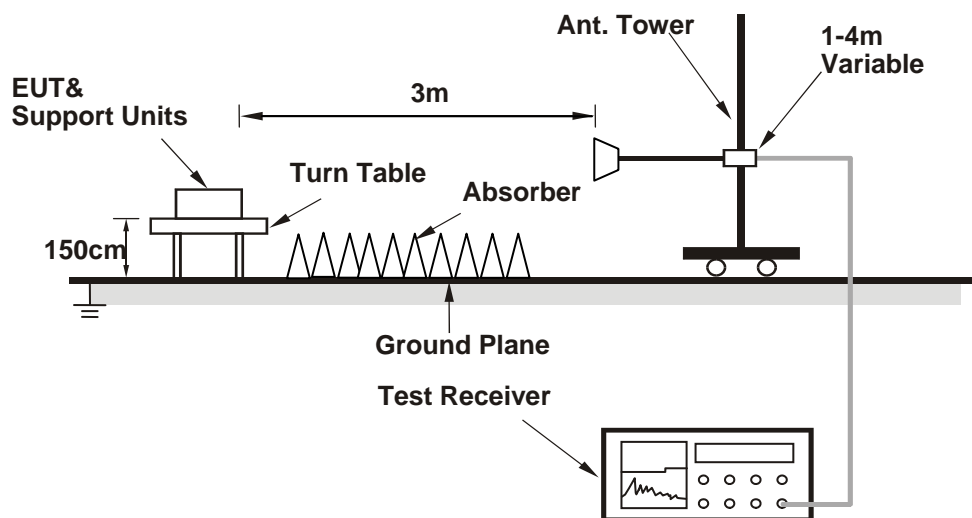

For the actual test configuration, please refer to the attached file (Test Setup Photo).

4.1.6 EUT Operating Conditions

- Placed the EUT on the testing table.
- Prepared notebook to act as communication partner and placed it outside of testing area.
- The communication partner connected with EUT via a RJ45 cable and ran a test program (provided by manufacturer) to enable EUT under transmission condition continuously at specific channel frequency.
- The communication partner sent data to EUT by command "PING".
- The necessary accessories enable the system in full functions.

4.1.7 Test Results

Above 1GHz Data :

Test Mode A

802.11b

CHANNEL	TX Channel 1	DETECTOR FUNCTION	Peak (PK)
FREQUENCY RANGE	1GHz ~ 25GHz		Average (AV)

ANTENNA POLARITY & TEST DISTANCE: HORIZONTAL AT 3 M

NO.	FREQ. (MHz)	EMISSION LEVEL (dBuV/m)	LIMIT (dBuV/m)	MARGIN (dB)	ANTENNA HEIGHT (m)	TABLE ANGLE (Degree)	RAW VALUE (dBuV)	CORRECTION FACTOR (dB/m)
1	2386.00	60.7 PK	74.0	-13.3	1.86 H	357	28.20	32.50
2	2386.00	52.5 AV	54.0	-1.5	1.86 H	357	20.00	32.50
3	*2412.00	116.8 PK			1.55 H	35	84.20	32.60
4	*2412.00	113.2 AV			1.55 H	35	80.60	32.60
5	4824.00	49.4 PK	74.0	-24.6	1.06 H	335	43.50	5.90
6	4824.00	41.9 AV	54.0	-12.1	1.06 H	335	36.00	5.90

ANTENNA POLARITY & TEST DISTANCE: VERTICAL AT 3 M

NO.	FREQ. (MHz)	EMISSION LEVEL (dBuV/m)	LIMIT (dBuV/m)	MARGIN (dB)	ANTENNA HEIGHT (m)	TABLE ANGLE (Degree)	RAW VALUE (dBuV)	CORRECTION FACTOR (dB/m)
1	2386.00	59.2 PK	74.0	-14.8	1.62 V	313	26.70	32.50
2	2386.00	51.5 AV	54.0	-2.5	1.62 V	313	19.00	32.50
3	*2412.00	110.8 PK			1.00 V	260	78.20	32.60
4	*2412.00	107.6 AV			1.00 V	260	75.00	32.60
5	4824.00	48.3 PK	74.0	-25.7	1.70 V	345	42.40	5.90
6	4824.00	38.1 AV	54.0	-15.9	1.70 V	345	32.20	5.90

REMARKS:

1. Emission Level(dBuV/m) = Raw Value(dBuV) + Correction Factor(dB/m)
2. Correction Factor(dB/m) = Antenna Factor(dB/m) + Cable Factor(dB)
3. The other emission levels were very low against the limit.
4. Margin value = Emission Level – Limit value
5. " * ": Fundamental frequency.



CHANNEL	TX Channel 6	DETECTOR FUNCTION	Peak (PK)
FREQUENCY RANGE	1GHz ~ 25GHz		Average (AV)

ANTENNA POLARITY & TEST DISTANCE: HORIZONTAL AT 3 M

NO.	FREQ. (MHz)	EMISSION LEVEL (dBuV/m)	LIMIT (dBuV/m)	MARGIN (dB)	ANTENNA HEIGHT (m)	TABLE ANGLE (Degree)	RAW VALUE (dBuV)	CORRECTION FACTOR (dB/m)
1	*2437.00	121.5 PK			1.54 H	35	88.80	32.70
2	*2437.00	117.7 AV			1.54 H	35	85.00	32.70
3	4874.00	52.2 PK	74.0	-21.8	1.97 H	357	46.30	5.90
4	4874.00	47.8 AV	54.0	-6.2	1.97 H	357	41.90	5.90

ANTENNA POLARITY & TEST DISTANCE: VERTICAL AT 3 M

NO.	FREQ. (MHz)	EMISSION LEVEL (dBuV/m)	LIMIT (dBuV/m)	MARGIN (dB)	ANTENNA HEIGHT (m)	TABLE ANGLE (Degree)	RAW VALUE (dBuV)	CORRECTION FACTOR (dB/m)
1	*2437.00	118.2 PK			1.43 V	312	85.50	32.70
2	*2437.00	114.4 AV			1.43 V	312	81.70	32.70
3	4874.00	49.4 PK	74.0	-24.6	1.00 V	296	43.50	5.90
4	4874.00	41.3 AV	54.0	-12.7	1.00 V	296	35.40	5.90

REMARKS:

1. Emission Level(dBuV/m) = Raw Value(dBuV) + Correction Factor(dB/m)
2. Correction Factor(dB/m) = Antenna Factor(dB/m) + Cable Factor(dB)
3. The other emission levels were very low against the limit.
4. Margin value = Emission Level – Limit value
5. " * ": Fundamental frequency.

CHANNEL	TX Channel 11	DETECTOR FUNCTION	Peak (PK)
FREQUENCY RANGE	1GHz ~ 25GHz		Average (AV)

ANTENNA POLARITY & TEST DISTANCE: HORIZONTAL AT 3 M

NO.	FREQ. (MHz)	EMISSION LEVEL (dBuV/m)	LIMIT (dBuV/m)	MARGIN (dB)	ANTENNA HEIGHT (m)	TABLE ANGLE (Degree)	RAW VALUE (dBuV)	CORRECTION FACTOR (dB/m)
1	*2462.00	117.9 PK			1.38 H	43	85.30	32.60
2	*2462.00	113.9 AV			1.38 H	43	81.30	32.60
3	2483.50	64.9 PK	74.0	-9.1	1.62 H	355	32.20	32.70
4	2483.50	52.2 AV	54.0	-1.8	1.62 H	355	19.50	32.70
5	4924.00	51.2 PK	74.0	-22.8	1.00 H	335	45.20	6.00
6	4924.00	44.5 AV	54.0	-9.5	1.00 H	335	38.50	6.00

ANTENNA POLARITY & TEST DISTANCE: VERTICAL AT 3 M

NO.	FREQ. (MHz)	EMISSION LEVEL (dBuV/m)	LIMIT (dBuV/m)	MARGIN (dB)	ANTENNA HEIGHT (m)	TABLE ANGLE (Degree)	RAW VALUE (dBuV)	CORRECTION FACTOR (dB/m)
1	*2462.00	112.6 PK			1.55 V	271	80.00	32.60
2	*2462.00	108.8 AV			1.55 V	271	76.20	32.60
3	2483.50	59.3 PK	74.0	-14.7	1.68 V	264	26.60	32.70
4	2483.50	47.8 AV	54.0	-6.2	1.68 V	264	15.10	32.70
5	4924.00	49.5 PK	74.0	-24.5	1.01 V	329	43.50	6.00
6	4924.00	40.6 AV	54.0	-13.4	1.01 V	329	34.60	6.00

REMARKS:

1. Emission Level(dBuV/m) = Raw Value(dBuV) + Correction Factor(dB/m)
2. Correction Factor(dB/m) = Antenna Factor(dB/m) + Cable Factor(dB)
3. The other emission levels were very low against the limit.
4. Margin value = Emission Level – Limit value
5. " * ": Fundamental frequency.

802.11g

CHANNEL	TX Channel 1	DETECTOR FUNCTION	Peak (PK)
FREQUENCY RANGE	1GHz ~ 25GHz		Average (AV)

ANTENNA POLARITY & TEST DISTANCE: HORIZONTAL AT 3 M

NO.	FREQ. (MHz)	EMISSION LEVEL (dBuV/m)	LIMIT (dBuV/m)	MARGIN (dB)	ANTENNA HEIGHT (m)	TABLE ANGLE (Degree)	RAW VALUE (dBuV)	CORRECTION FACTOR (dB/m)
1	2390.00	67.0 PK	74.0	-7.0	1.00 H	52	34.50	32.50
2	2390.00	52.8 AV	54.0	-1.2	1.00 H	52	20.30	32.50
3	*2412.00	117.2 PK			1.05 H	307	84.60	32.60
4	*2412.00	106.8 AV			1.05 H	307	74.20	32.60
5	4824.00	47.1 PK	74.0	-26.9	1.42 H	166	41.20	5.90
6	4824.00	33.6 AV	54.0	-20.4	1.42 H	166	27.70	5.90

ANTENNA POLARITY & TEST DISTANCE: VERTICAL AT 3 M

NO.	FREQ. (MHz)	EMISSION LEVEL (dBuV/m)	LIMIT (dBuV/m)	MARGIN (dB)	ANTENNA HEIGHT (m)	TABLE ANGLE (Degree)	RAW VALUE (dBuV)	CORRECTION FACTOR (dB/m)
1	2390.00	65.1 PK	74.0	-8.9	1.27 V	314	32.60	32.50
2	2390.00	50.8 AV	54.0	-3.2	1.27 V	314	18.30	32.50
3	*2412.00	110.7 PK			1.00 V	267	78.10	32.60
4	*2412.00	101.4 AV			1.00 V	267	68.80	32.60
5	4824.00	46.6 PK	74.0	-27.4	1.12 V	193	40.70	5.90
6	4824.00	33.2 AV	54.0	-20.8	1.12 V	193	27.30	5.90

REMARKS:

1. Emission Level(dBuV/m) = Raw Value(dBuV) + Correction Factor(dB/m)
2. Correction Factor(dB/m) = Antenna Factor(dB/m) + Cable Factor(dB)
3. The other emission levels were very low against the limit.
4. Margin value = Emission Level – Limit value
5. " * ": Fundamental frequency.

CHANNEL	TX Channel 6	DETECTOR FUNCTION	Peak (PK)
FREQUENCY RANGE	1GHz ~ 25GHz		Average (AV)

ANTENNA POLARITY & TEST DISTANCE: HORIZONTAL AT 3 M

NO.	FREQ. (MHz)	EMISSION LEVEL (dBuV/m)	LIMIT (dBuV/m)	MARGIN (dB)	ANTENNA HEIGHT (m)	TABLE ANGLE (Degree)	RAW VALUE (dBuV)	CORRECTION FACTOR (dB/m)
1	2390.00	69.2 PK	74.0	-4.8	1.00 H	43	36.70	32.50
2	2390.00	52.5 AV	54.0	-1.5	1.00 H	43	20.00	32.50
3	*2437.00	124.7 PK			1.50 H	306	92.00	32.70
4	*2437.00	114.6 AV			1.50 H	306	81.90	32.70
5	2483.50	72.2 PK	74.0	-1.8	1.00 H	40	39.50	32.70
6	2483.50	52.8 AV	54.0	-1.2	1.00 H	40	20.10	32.70
7	4874.00	49.2 PK	74.0	-24.8	1.79 H	0	43.30	5.90
8	4874.00	36.4 AV	54.0	-17.6	1.79 H	0	30.50	5.90

ANTENNA POLARITY & TEST DISTANCE: VERTICAL AT 3 M

NO.	FREQ. (MHz)	EMISSION LEVEL (dBuV/m)	LIMIT (dBuV/m)	MARGIN (dB)	ANTENNA HEIGHT (m)	TABLE ANGLE (Degree)	RAW VALUE (dBuV)	CORRECTION FACTOR (dB/m)
1	2390.00	67.5 PK	74.0	-6.5	1.62 V	314	35.00	32.50
2	2390.00	51.2 AV	54.0	-2.8	1.62 V	314	18.70	32.50
3	*2437.00	119.7 PK			1.44 V	313	87.00	32.70
4	*2437.00	109.7 AV			1.44 V	313	77.00	32.70
5	2483.50	68.1 PK	74.0	-5.9	1.26 V	113	35.40	32.70
6	2483.50	49.4 AV	54.0	-4.6	1.26 V	113	16.70	32.70
7	4874.00	47.2 PK	74.0	-26.8	1.00 V	67	41.30	5.90
8	4874.00	35.1 AV	54.0	-18.9	1.00 V	67	29.20	5.90

REMARKS:

1. Emission Level(dBuV/m) = Raw Value(dBuV) + Correction Factor(dB/m)
2. Correction Factor(dB/m) = Antenna Factor(dB/m) + Cable Factor(dB)
3. The other emission levels were very low against the limit.
4. Margin value = Emission Level – Limit value
5. " * ": Fundamental frequency.

CHANNEL	TX Channel 11	DETECTOR FUNCTION	Peak (PK)
FREQUENCY RANGE	1GHz ~ 25GHz		Average (AV)

ANTENNA POLARITY & TEST DISTANCE: HORIZONTAL AT 3 M

NO.	FREQ. (MHz)	EMISSION LEVEL (dBuV/m)	LIMIT (dBuV/m)	MARGIN (dB)	ANTENNA HEIGHT (m)	TABLE ANGLE (Degree)	RAW VALUE (dBuV)	CORRECTION FACTOR (dB/m)
1	*2462.00	118.4 PK			1.64 H	313	85.80	32.60
2	*2462.00	108.7 AV			1.64 H	313	76.10	32.60
3	2483.50	66.6 PK	74.0	-7.4	1.60 H	0	33.90	32.70
4	2483.50	52.2 AV	54.0	-1.8	1.60 H	0	19.50	32.70
5	4924.00	46.9 PK	74.0	-27.1	1.13 H	216	40.90	6.00
6	4924.00	33.8 AV	54.0	-20.2	1.13 H	216	27.80	6.00

ANTENNA POLARITY & TEST DISTANCE: VERTICAL AT 3 M

NO.	FREQ. (MHz)	EMISSION LEVEL (dBuV/m)	LIMIT (dBuV/m)	MARGIN (dB)	ANTENNA HEIGHT (m)	TABLE ANGLE (Degree)	RAW VALUE (dBuV)	CORRECTION FACTOR (dB/m)
1	*2462.00	114.3 PK			1.25 V	315	81.70	32.60
2	*2462.00	104.2 AV			1.25 V	315	71.60	32.60
3	2483.50	60.2 PK	74.0	-13.8	1.24 V	236	27.50	32.70
4	2483.50	47.7 AV	54.0	-6.3	1.24 V	236	15.00	32.70
5	4924.00	46.5 PK	74.0	-27.5	1.03 V	89	40.50	6.00
6	4924.00	33.6 AV	54.0	-20.4	1.03 V	89	27.60	6.00

REMARKS:

1. Emission Level(dBuV/m) = Raw Value(dBuV) + Correction Factor(dB/m)
2. Correction Factor(dB/m) = Antenna Factor(dB/m) + Cable Factor(dB)
3. The other emission levels were very low against the limit.
4. Margin value = Emission Level – Limit value
5. " * ": Fundamental frequency.

802.11n (HT20)

CHANNEL	TX Channel 1	DETECTOR FUNCTION	Peak (PK)
FREQUENCY RANGE	1GHz ~ 25GHz		Average (AV)

ANTENNA POLARITY & TEST DISTANCE: HORIZONTAL AT 3 M								
NO.	FREQ. (MHz)	EMISSION LEVEL (dBuV/m)	LIMIT (dBuV/m)	MARGIN (dB)	ANTENNA HEIGHT (m)	TABLE ANGLE (Degree)	RAW VALUE (dBuV)	CORRECTION FACTOR (dB/m)
1	2390.00	68.1 PK	74.0	-5.9	1.56 H	31	35.60	32.50
2	2390.00	52.9 AV	54.0	-1.1	1.56 H	31	20.40	32.50
3	*2412.00	114.2 PK			1.00 H	318	81.60	32.60
4	*2412.00	104.6 AV			1.00 H	318	72.00	32.60
5	4824.00	46.7 PK	74.0	-27.3	1.24 H	203	40.80	5.90
6	4824.00	33.4 AV	54.0	-20.6	1.24 H	203	27.50	5.90

ANTENNA POLARITY & TEST DISTANCE: VERTICAL AT 3 M								
NO.	FREQ. (MHz)	EMISSION LEVEL (dBuV/m)	LIMIT (dBuV/m)	MARGIN (dB)	ANTENNA HEIGHT (m)	TABLE ANGLE (Degree)	RAW VALUE (dBuV)	CORRECTION FACTOR (dB/m)
1	2390.00	63.1 PK	74.0	-10.9	1.05 V	282	30.60	32.50
2	2390.00	49.4 AV	54.0	-4.6	1.05 V	282	16.90	32.50
3	*2412.00	109.1 PK			1.00 V	266	76.50	32.60
4	*2412.00	100.1 AV			1.00 V	266	67.50	32.60
5	4824.00	46.3 PK	74.0	-27.7	1.18 V	59	40.40	5.90
6	4824.00	33.3 AV	54.0	-20.7	1.18 V	59	27.40	5.90

REMARKS:

1. Emission Level(dBuV/m) = Raw Value(dBuV) + Correction Factor(dB/m)
2. Correction Factor(dB/m) = Antenna Factor(dB/m) + Cable Factor(dB)
3. The other emission levels were very low against the limit.
4. Margin value = Emission Level – Limit value
5. " * ": Fundamental frequency.

CHANNEL	TX Channel 6	DETECTOR FUNCTION	Peak (PK)
FREQUENCY RANGE	1GHz ~ 25GHz		Average (AV)

ANTENNA POLARITY & TEST DISTANCE: HORIZONTAL AT 3 M

NO.	FREQ. (MHz)	EMISSION LEVEL (dBuV/m)	LIMIT (dBuV/m)	MARGIN (dB)	ANTENNA HEIGHT (m)	TABLE ANGLE (Degree)	RAW VALUE (dBuV)	CORRECTION FACTOR (dB/m)
1	2390.00	67.1 PK	74.0	-6.9	1.00 H	318	34.60	32.50
2	2390.00	52.4 AV	54.0	-1.6	1.00 H	318	19.90	32.50
3	*2437.00	121.9 PK			1.00 H	320	89.20	32.70
4	*2437.00	112.2 AV			1.00 H	320	79.50	32.70
5	4874.00	49.5 PK	74.0	-24.5	1.26 H	343	43.60	5.90
6	4874.00	37.4 AV	54.0	-16.6	1.26 H	343	31.50	5.90

ANTENNA POLARITY & TEST DISTANCE: VERTICAL AT 3 M

NO.	FREQ. (MHz)	EMISSION LEVEL (dBuV/m)	LIMIT (dBuV/m)	MARGIN (dB)	ANTENNA HEIGHT (m)	TABLE ANGLE (Degree)	RAW VALUE (dBuV)	CORRECTION FACTOR (dB/m)
1	2390.00	66.0 PK	74.0	-8.0	1.46 V	333	33.50	32.50
2	2390.00	50.5 AV	54.0	-3.5	1.46 V	333	18.00	32.50
3	*2437.00	119.6 PK			1.60 V	335	86.90	32.70
4	*2437.00	108.7 AV			1.60 V	335	76.00	32.70
5	4874.00	48.8 PK	74.0	-25.2	1.41 V	76	42.90	5.90
6	4874.00	35.4 AV	54.0	-18.6	1.41 V	76	29.50	5.90

REMARKS:

1. Emission Level(dBuV/m) = Raw Value(dBuV) + Correction Factor(dB/m)
2. Correction Factor(dB/m) = Antenna Factor(dB/m) + Cable Factor(dB)
3. The other emission levels were very low against the limit.
4. Margin value = Emission Level – Limit value
5. " * " : Fundamental frequency.

CHANNEL	TX Channel 11	DETECTOR FUNCTION	Peak (PK)
FREQUENCY RANGE	1GHz ~ 25GHz		Average (AV)

ANTENNA POLARITY & TEST DISTANCE: HORIZONTAL AT 3 M

NO.	FREQ. (MHz)	EMISSION LEVEL (dBuV/m)	LIMIT (dBuV/m)	MARGIN (dB)	ANTENNA HEIGHT (m)	TABLE ANGLE (Degree)	RAW VALUE (dBuV)	CORRECTION FACTOR (dB/m)
1	*2462.00	115.7 PK			1.00 H	34	83.10	32.60
2	*2462.00	106.1 AV			1.00 H	34	73.50	32.60
3	2483.50	65.6 PK	74.0	-8.4	1.01 H	353	32.90	32.70
4	2483.50	52.5 AV	54.0	-1.5	1.01 H	353	19.80	32.70
5	4924.00	46.8 PK	74.0	-27.2	1.27 H	69	40.80	6.00
6	4924.00	34.5 AV	54.0	-19.5	1.27 H	69	28.50	6.00

ANTENNA POLARITY & TEST DISTANCE: VERTICAL AT 3 M

NO.	FREQ. (MHz)	EMISSION LEVEL (dBuV/m)	LIMIT (dBuV/m)	MARGIN (dB)	ANTENNA HEIGHT (m)	TABLE ANGLE (Degree)	RAW VALUE (dBuV)	CORRECTION FACTOR (dB/m)
1	*2462.00	113.6 PK			1.26 V	313	81.00	32.60
2	*2462.00	103.8 AV			1.26 V	313	71.20	32.60
3	2483.50	59.3 PK	74.0	-14.7	1.00 V	90	26.60	32.70
4	2483.50	48.0 AV	54.0	-6.0	1.00 V	90	15.30	32.70
5	4924.00	46.7 PK	74.0	-27.3	1.04 V	306	40.70	6.00
6	4924.00	34.2 AV	54.0	-19.8	1.04 V	306	28.20	6.00

REMARKS:

1. Emission Level(dBuV/m) = Raw Value(dBuV) + Correction Factor(dB/m)
2. Correction Factor(dB/m) = Antenna Factor(dB/m) + Cable Factor(dB)
3. The other emission levels were very low against the limit.
4. Margin value = Emission Level – Limit value
5. " * ": Fundamental frequency.

802.11n (HT40)

CHANNEL	TX Channel 3	DETECTOR FUNCTION	Peak (PK)
FREQUENCY RANGE	1GHz ~ 25GHz		Average (AV)

ANTENNA POLARITY & TEST DISTANCE: HORIZONTAL AT 3 M

NO.	FREQ. (MHz)	EMISSION LEVEL (dBuV/m)	LIMIT (dBuV/m)	MARGIN (dB)	ANTENNA HEIGHT (m)	TABLE ANGLE (Degree)	RAW VALUE (dBuV)	CORRECTION FACTOR (dB/m)
1	2390.00	64.5 PK	74.0	-9.5	1.00 H	4	32.00	32.50
2	2390.00	53.0 AV	54.0	-1.0	1.00 H	4	20.50	32.50
3	*2422.00	107.0 PK			1.00 H	316	74.40	32.60
4	*2422.00	97.7 AV			1.00 H	316	65.10	32.60
5	4844.00	48.1 PK	74.0	-25.9	1.43 H	206	42.20	5.90
6	4844.00	34.8 AV	54.0	-19.2	1.43 H	206	28.90	5.90

ANTENNA POLARITY & TEST DISTANCE: VERTICAL AT 3 M

NO.	FREQ. (MHz)	EMISSION LEVEL (dBuV/m)	LIMIT (dBuV/m)	MARGIN (dB)	ANTENNA HEIGHT (m)	TABLE ANGLE (Degree)	RAW VALUE (dBuV)	CORRECTION FACTOR (dB/m)
1	2390.00	62.6 PK	74.0	-11.4	1.78 V	332	30.10	32.50
2	2390.00	49.9 AV	54.0	-4.1	1.78 V	332	17.40	32.50
3	*2422.00	103.9 PK			1.28 V	338	71.30	32.60
4	*2422.00	93.9 AV			1.28 V	338	61.30	32.60
5	4844.00	46.6 PK	74.0	-27.4	1.05 V	97	40.70	5.90
6	4844.00	34.5 AV	54.0	-19.5	1.05 V	97	28.60	5.90

REMARKS:

1. Emission Level(dBuV/m) = Raw Value(dBuV) + Correction Factor(dB/m)
2. Correction Factor(dB/m) = Antenna Factor(dB/m) + Cable Factor(dB)
3. The other emission levels were very low against the limit.
4. Margin value = Emission Level – Limit value
5. " * ": Fundamental frequency.
6. " # ": The radiated frequency is out of the restricted band.



CHANNEL	TX Channel 6	DETECTOR FUNCTION	Peak (PK)
FREQUENCY RANGE	1GHz ~ 25GHz		Average (AV)

ANTENNA POLARITY & TEST DISTANCE: HORIZONTAL AT 3 M

NO.	FREQ. (MHz)	EMISSION LEVEL (dBuV/m)	LIMIT (dBuV/m)	MARGIN (dB)	ANTENNA HEIGHT (m)	TABLE ANGLE (Degree)	RAW VALUE (dBuV)	CORRECTION FACTOR (dB/m)
1	2390.00	67.7 PK	74.0	-6.3	1.13 H	11	35.20	32.50
2	2390.00	52.9 AV	54.0	-1.1	1.13 H	11	20.40	32.50
3	*2437.00	113.0 PK			1.00 H	35	80.30	32.70
4	*2437.00	103.8 AV			1.00 H	35	71.10	32.70
5	4874.00	47.0 PK	74.0	-27.0	1.37 H	78	41.10	5.90
6	4874.00	35.2 AV	54.0	-18.8	1.37 H	78	29.30	5.90

ANTENNA POLARITY & TEST DISTANCE: VERTICAL AT 3 M

NO.	FREQ. (MHz)	EMISSION LEVEL (dBuV/m)	LIMIT (dBuV/m)	MARGIN (dB)	ANTENNA HEIGHT (m)	TABLE ANGLE (Degree)	RAW VALUE (dBuV)	CORRECTION FACTOR (dB/m)
1	2390.00	62.1 PK	74.0	-11.9	1.81 V	294	29.60	32.50
2	2390.00	50.4 AV	54.0	-3.6	1.81 V	294	17.90	32.50
3	*2437.00	108.3 PK			1.00 V	270	75.60	32.70
4	*2437.00	100.1 AV			1.00 V	270	67.40	32.70
5	4874.00	47.6 PK	74.0	-26.4	1.08 V	254	41.70	5.90
6	4874.00	35.2 AV	54.0	-18.8	1.08 V	254	29.30	5.90

REMARKS:

1. Emission Level(dBuV/m) = Raw Value(dBuV) + Correction Factor(dB/m)
2. Correction Factor(dB/m) = Antenna Factor(dB/m) + Cable Factor(dB)
3. The other emission levels were very low against the limit.
4. Margin value = Emission Level – Limit value
5. " * " : Fundamental frequency.

CHANNEL	TX Channel 9	DETECTOR FUNCTION	Peak (PK)
FREQUENCY RANGE	1GHz ~ 25GHz		Average (AV)

ANTENNA POLARITY & TEST DISTANCE: HORIZONTAL AT 3 M

NO.	FREQ. (MHz)	EMISSION LEVEL (dBuV/m)	LIMIT (dBuV/m)	MARGIN (dB)	ANTENNA HEIGHT (m)	TABLE ANGLE (Degree)	RAW VALUE (dBuV)	CORRECTION FACTOR (dB/m)
1	*2452.00	106.5 PK			1.01 H	44	73.80	32.70
2	*2452.00	98.1 AV			1.01 H	44	65.40	32.70
3	2483.50	66.5 PK	74.0	-7.5	1.81 H	9	33.80	32.70
4	2483.50	53.0 AV	54.0	-1.0	1.81 H	9	20.30	32.70
5	4904.00	46.8 PK	74.0	-27.2	1.08 H	94	41.00	5.80
6	4904.00	35.6 AV	54.0	-18.4	1.08 H	94	29.80	5.80

ANTENNA POLARITY & TEST DISTANCE: VERTICAL AT 3 M

NO.	FREQ. (MHz)	EMISSION LEVEL (dBuV/m)	LIMIT (dBuV/m)	MARGIN (dB)	ANTENNA HEIGHT (m)	TABLE ANGLE (Degree)	RAW VALUE (dBuV)	CORRECTION FACTOR (dB/m)
1	*2452.00	101.7 PK			1.40 V	340	69.00	32.70
2	*2452.00	92.1 AV			1.40 V	340	59.40	32.70
3	2483.50	63.1 PK	74.0	-10.9	1.21 V	334	30.40	32.70
4	2483.50	49.7 AV	54.0	-4.3	1.21 V	334	17.00	32.70
5	4904.00	47.7 PK	74.0	-26.3	1.00 V	97	41.90	5.80
6	4904.00	35.0 AV	54.0	-19.0	1.00 V	97	29.20	5.80

REMARKS:

1. Emission Level(dBuV/m) = Raw Value(dBuV) + Correction Factor(dB/m)
2. Correction Factor(dB/m) = Antenna Factor(dB/m) + Cable Factor(dB)
3. The other emission levels were very low against the limit.
4. Margin value = Emission Level – Limit value
5. " * ": Fundamental frequency.

Test Mode C
802.11b

CHANNEL	TX Channel 1	DETECTOR FUNCTION	Peak (PK)
FREQUENCY RANGE	1GHz ~ 25GHz		Average (AV)

ANTENNA POLARITY & TEST DISTANCE: HORIZONTAL AT 3 M

NO.	FREQ. (MHz)	EMISSION LEVEL (dBuV/m)	LIMIT (dBuV/m)	MARGIN (dB)	ANTENNA HEIGHT (m)	TABLE ANGLE (Degree)	RAW VALUE (dBuV)	CORRECTION FACTOR (dB/m)
1	2386.00	56.5 PK	74.0	-17.5	1.04 H	259	24.00	32.50
2	2386.00	46.6 AV	54.0	-7.4	1.04 H	259	14.10	32.50
3	*2412.00	106.2 PK			1.02 H	256	73.60	32.60
4	*2412.00	102.4 AV			1.02 H	256	69.80	32.60
5	4824.00	47.5 PK	74.0	-26.5	1.00 H	237	41.60	5.90
6	4824.00	35.6 AV	54.0	-18.4	1.00 H	237	29.70	5.90

ANTENNA POLARITY & TEST DISTANCE: VERTICAL AT 3 M

NO.	FREQ. (MHz)	EMISSION LEVEL (dBuV/m)	LIMIT (dBuV/m)	MARGIN (dB)	ANTENNA HEIGHT (m)	TABLE ANGLE (Degree)	RAW VALUE (dBuV)	CORRECTION FACTOR (dB/m)
1	2386.00	65.3 PK	74.0	-8.7	1.60 V	126	32.80	32.50
2	2386.00	52.8 AV	54.0	-1.2	1.60 V	126	20.30	32.50
3	*2412.00	115.3 PK			1.43 V	247	82.70	32.60
4	*2412.00	111.8 AV			1.43 V	247	79.20	32.60
5	4824.00	48.0 PK	74.0	-26.0	1.11 V	248	42.10	5.90
6	4824.00	37.4 AV	54.0	-16.6	1.11 V	248	31.50	5.90

REMARKS:

1. Emission Level(dBuV/m) = Raw Value(dBuV) + Correction Factor(dB/m)
2. Correction Factor(dB/m) = Antenna Factor(dB/m) + Cable Factor(dB)
3. The other emission levels were very low against the limit.
4. Margin value = Emission Level – Limit value
5. " * ": Fundamental frequency.

CHANNEL	TX Channel 6	DETECTOR FUNCTION	Peak (PK)
FREQUENCY RANGE	1GHz ~ 25GHz		Average (AV)

ANTENNA POLARITY & TEST DISTANCE: HORIZONTAL AT 3 M

NO.	FREQ. (MHz)	EMISSION LEVEL (dBuV/m)	LIMIT (dBuV/m)	MARGIN (dB)	ANTENNA HEIGHT (m)	TABLE ANGLE (Degree)	RAW VALUE (dBuV)	CORRECTION FACTOR (dB/m)
1	*2437.00	109.8 PK			1.67 H	323	77.10	32.70
2	*2437.00	106.2 AV			1.67 H	323	73.50	32.70
3	4874.00	49.3 PK	74.0	-24.7	1.50 H	237	43.40	5.90
4	4874.00	38.7 AV	54.0	-15.3	1.50 H	237	32.80	5.90

ANTENNA POLARITY & TEST DISTANCE: VERTICAL AT 3 M

NO.	FREQ. (MHz)	EMISSION LEVEL (dBuV/m)	LIMIT (dBuV/m)	MARGIN (dB)	ANTENNA HEIGHT (m)	TABLE ANGLE (Degree)	RAW VALUE (dBuV)	CORRECTION FACTOR (dB/m)
1	*2437.00	119.5 PK			1.57 V	126	86.80	32.70
2	*2437.00	116.0 AV			1.57 V	126	83.30	32.70
3	4874.00	49.8 PK	74.0	-24.2	1.16 V	294	43.90	5.90
4	4874.00	41.8 AV	54.0	-12.2	1.16 V	294	35.90	5.90

REMARKS:

1. Emission Level(dBuV/m) = Raw Value(dBuV) + Correction Factor(dB/m)
2. Correction Factor(dB/m) = Antenna Factor(dB/m) + Cable Factor(dB)
3. The other emission levels were very low against the limit.
4. Margin value = Emission Level – Limit value
5. " * ": Fundamental frequency.

CHANNEL	TX Channel 11	DETECTOR FUNCTION	Peak (PK)
FREQUENCY RANGE	1GHz ~ 25GHz		Average (AV)

ANTENNA POLARITY & TEST DISTANCE: HORIZONTAL AT 3 M

NO.	FREQ. (MHz)	EMISSION LEVEL (dBuV/m)	LIMIT (dBuV/m)	MARGIN (dB)	ANTENNA HEIGHT (m)	TABLE ANGLE (Degree)	RAW VALUE (dBuV)	CORRECTION FACTOR (dB/m)
1	*2462.00	106.2 PK			1.00 H	0	73.60	32.60
2	*2462.00	102.6 AV			1.00 H	0	70.00	32.60
3	2483.50	57.0 PK	74.0	-17.0	1.16 H	32	24.30	32.70
4	2483.50	47.6 AV	54.0	-6.4	1.16 H	32	14.90	32.70
5	4924.00	47.7 PK	74.0	-26.3	1.57 H	237	41.70	6.00
6	4924.00	35.3 AV	54.0	-18.7	1.57 H	237	29.30	6.00

ANTENNA POLARITY & TEST DISTANCE: VERTICAL AT 3 M

NO.	FREQ. (MHz)	EMISSION LEVEL (dBuV/m)	LIMIT (dBuV/m)	MARGIN (dB)	ANTENNA HEIGHT (m)	TABLE ANGLE (Degree)	RAW VALUE (dBuV)	CORRECTION FACTOR (dB/m)
1	*2462.00	117.1 PK			1.55 V	239	84.50	32.60
2	*2462.00	112.8 AV			1.55 V	239	80.20	32.60
3	2483.50	60.5 PK	74.0	-13.5	1.52 V	131	27.80	32.70
4	2483.50	52.5 AV	54.0	-1.5	1.52 V	131	19.80	32.70
5	4924.00	48.8 PK	74.0	-25.2	1.31 V	247	42.80	6.00
6	4924.00	38.0 AV	54.0	-16.0	1.31 V	247	32.00	6.00

REMARKS:

1. Emission Level(dBuV/m) = Raw Value(dBuV) + Correction Factor(dB/m)
2. Correction Factor(dB/m) = Antenna Factor(dB/m) + Cable Factor(dB)
3. The other emission levels were very low against the limit.
4. Margin value = Emission Level – Limit value
5. " * ": Fundamental frequency.

802.11g

CHANNEL	TX Channel 1	DETECTOR FUNCTION	Peak (PK)
FREQUENCY RANGE	1GHz ~ 25GHz		Average (AV)

ANTENNA POLARITY & TEST DISTANCE: HORIZONTAL AT 3 M

NO.	FREQ. (MHz)	EMISSION LEVEL (dBuV/m)	LIMIT (dBuV/m)	MARGIN (dB)	ANTENNA HEIGHT (m)	TABLE ANGLE (Degree)	RAW VALUE (dBuV)	CORRECTION FACTOR (dB/m)
1	2390.00	57.3 PK	74.0	-16.7	1.30 H	81	24.80	32.50
2	2390.00	46.1 AV	54.0	-7.9	1.30 H	81	13.60	32.50
3	*2412.00	105.0 PK			1.03 H	252	72.40	32.60
4	*2412.00	95.2 AV			1.03 H	252	62.60	32.60
5	4824.00	47.0 PK	74.0	-27.0	1.15 H	160	41.10	5.90
6	4824.00	33.9 AV	54.0	-20.1	1.15 H	160	28.00	5.90

ANTENNA POLARITY & TEST DISTANCE: VERTICAL AT 3 M

NO.	FREQ. (MHz)	EMISSION LEVEL (dBuV/m)	LIMIT (dBuV/m)	MARGIN (dB)	ANTENNA HEIGHT (m)	TABLE ANGLE (Degree)	RAW VALUE (dBuV)	CORRECTION FACTOR (dB/m)
1	2390.00	69.3 PK	74.0	-4.7	1.59 V	126	36.80	32.50
2	2390.00	52.3 AV	54.0	-1.7	1.59 V	126	19.80	32.50
3	*2412.00	114.4 PK			1.40 V	112	81.80	32.60
4	*2412.00	104.5 AV			1.40 V	112	71.90	32.60
5	4824.00	47.0 PK	74.0	-27.0	1.17 V	169	41.10	5.90
6	4824.00	34.0 AV	54.0	-20.0	1.17 V	169	28.10	5.90

REMARKS:

1. Emission Level(dBuV/m) = Raw Value(dBuV) + Correction Factor(dB/m)
2. Correction Factor(dB/m) = Antenna Factor(dB/m) + Cable Factor(dB)
3. The other emission levels were very low against the limit.
4. Margin value = Emission Level – Limit value
5. " * ": Fundamental frequency.

CHANNEL	TX Channel 6	DETECTOR FUNCTION	Peak (PK)
FREQUENCY RANGE	1GHz ~ 25GHz		Average (AV)

ANTENNA POLARITY & TEST DISTANCE: HORIZONTAL AT 3 M

NO.	FREQ. (MHz)	EMISSION LEVEL (dBuV/m)	LIMIT (dBuV/m)	MARGIN (dB)	ANTENNA HEIGHT (m)	TABLE ANGLE (Degree)	RAW VALUE (dBuV)	CORRECTION FACTOR (dB/m)
1	2390.00	57.6 PK	74.0	-16.4	1.30 H	79	25.10	32.50
2	2390.00	46.2 AV	54.0	-7.8	1.30 H	79	13.70	32.50
3	*2437.00	110.5 PK			1.01 H	252	77.80	32.70
4	*2437.00	100.5 AV			1.01 H	252	67.80	32.70
5	2483.50	58.5 PK	74.0	-15.5	1.44 H	2	25.80	32.70
6	2483.50	46.1 AV	54.0	-7.9	1.44 H	2	13.40	32.70
7	4874.00	47.5 PK	74.0	-26.5	1.23 H	262	41.60	5.90
8	4874.00	34.2 AV	54.0	-19.8	1.23 H	262	28.30	5.90

ANTENNA POLARITY & TEST DISTANCE: VERTICAL AT 3 M

NO.	FREQ. (MHz)	EMISSION LEVEL (dBuV/m)	LIMIT (dBuV/m)	MARGIN (dB)	ANTENNA HEIGHT (m)	TABLE ANGLE (Degree)	RAW VALUE (dBuV)	CORRECTION FACTOR (dB/m)
1	2390.00	66.2 PK	74.0	-7.8	1.53 V	219	33.70	32.50
2	2390.00	50.8 AV	54.0	-3.2	1.53 V	219	18.30	32.50
3	*2437.00	121.4 PK			1.25 V	156	88.70	32.70
4	*2437.00	111.1 AV			1.25 V	156	78.40	32.70
5	2483.50	68.9 PK	74.0	-5.1	1.10 V	130	36.20	32.70
6	2483.50	51.6 AV	54.0	-2.4	1.10 V	130	18.90	32.70
7	4874.00	48.0 PK	74.0	-26.0	1.26 V	257	42.10	5.90
8	4874.00	34.5 AV	54.0	-19.5	1.26 V	257	28.60	5.90

REMARKS:

1. Emission Level(dBuV/m) = Raw Value(dBuV) + Correction Factor(dB/m)
2. Correction Factor(dB/m) = Antenna Factor(dB/m) + Cable Factor(dB)
3. The other emission levels were very low against the limit.
4. Margin value = Emission Level – Limit value
5. " * ": Fundamental frequency.

CHANNEL	TX Channel 11	DETECTOR FUNCTION	Peak (PK)
FREQUENCY RANGE	1GHz ~ 25GHz		Average (AV)

ANTENNA POLARITY & TEST DISTANCE: HORIZONTAL AT 3 M

NO.	FREQ. (MHz)	EMISSION LEVEL (dBuV/m)	LIMIT (dBuV/m)	MARGIN (dB)	ANTENNA HEIGHT (m)	TABLE ANGLE (Degree)	RAW VALUE (dBuV)	CORRECTION FACTOR (dB/m)
1	*2462.00	106.6 PK			1.01 H	1	74.00	32.60
2	*2462.00	96.4 AV			1.01 H	1	63.80	32.60
3	2483.50	60.6 PK	74.0	-13.4	1.65 H	23	27.90	32.70
4	2483.50	47.7 AV	54.0	-6.3	1.65 H	23	15.00	32.70
5	4924.00	47.5 PK	74.0	-26.5	1.25 H	316	41.50	6.00
6	4924.00	34.6 AV	54.0	-19.4	1.25 H	316	28.60	6.00

ANTENNA POLARITY & TEST DISTANCE: VERTICAL AT 3 M

NO.	FREQ. (MHz)	EMISSION LEVEL (dBuV/m)	LIMIT (dBuV/m)	MARGIN (dB)	ANTENNA HEIGHT (m)	TABLE ANGLE (Degree)	RAW VALUE (dBuV)	CORRECTION FACTOR (dB/m)
1	*2462.00	116.1 PK			1.40 V	113	83.50	32.60
2	*2462.00	106.1 AV			1.40 V	113	73.50	32.60
3	2483.50	66.2 PK	74.0	-7.8	1.12 V	132	33.50	32.70
4	2483.50	52.2 AV	54.0	-1.8	1.12 V	132	19.50	32.70
5	4924.00	47.6 PK	74.0	-26.4	1.36 V	126	41.60	6.00
6	4924.00	34.5 AV	54.0	-19.5	1.36 V	126	28.50	6.00

REMARKS:

1. Emission Level(dBuV/m) = Raw Value(dBuV) + Correction Factor(dB/m)
2. Correction Factor(dB/m) = Antenna Factor(dB/m) + Cable Factor(dB)
3. The other emission levels were very low against the limit.
4. Margin value = Emission Level – Limit value
5. " * ": Fundamental frequency.

802.11n (HT20)

CHANNEL	TX Channel 1	DETECTOR FUNCTION	Peak (PK)
FREQUENCY RANGE	1GHz ~ 25GHz		Average (AV)

ANTENNA POLARITY & TEST DISTANCE: HORIZONTAL AT 3 M

NO.	FREQ. (MHz)	EMISSION LEVEL (dBuV/m)	LIMIT (dBuV/m)	MARGIN (dB)	ANTENNA HEIGHT (m)	TABLE ANGLE (Degree)	RAW VALUE (dBuV)	CORRECTION FACTOR (dB/m)
1	2390.00	59.7 PK	74.0	-14.3	1.03 H	249	27.20	32.50
2	2390.00	47.5 AV	54.0	-6.5	1.03 H	249	15.00	32.50
3	*2412.00	104.1 PK			1.02 H	252	71.50	32.60
4	*2412.00	94.2 AV			1.02 H	252	61.60	32.60
5	4824.00	47.3 PK	74.0	-26.7	1.28 H	118	41.40	5.90
6	4824.00	34.0 AV	54.0	-20.0	1.28 H	118	28.10	5.90

ANTENNA POLARITY & TEST DISTANCE: VERTICAL AT 3 M

NO.	FREQ. (MHz)	EMISSION LEVEL (dBuV/m)	LIMIT (dBuV/m)	MARGIN (dB)	ANTENNA HEIGHT (m)	TABLE ANGLE (Degree)	RAW VALUE (dBuV)	CORRECTION FACTOR (dB/m)
1	2390.00	67.3 PK	74.0	-6.7	1.62 V	258	34.80	32.50
2	2390.00	52.9 AV	54.0	-1.1	1.62 V	258	20.40	32.50
3	*2412.00	115.3 PK			1.76 V	124	82.70	32.60
4	*2412.00	104.5 AV			1.76 V	124	71.90	32.60
5	4824.00	47.0 PK	74.0	-27.0	1.51 V	49	41.10	5.90
6	4824.00	34.0 AV	54.0	-20.0	1.51 V	49	28.10	5.90

REMARKS:

1. Emission Level(dBuV/m) = Raw Value(dBuV) + Correction Factor(dB/m)
2. Correction Factor(dB/m) = Antenna Factor(dB/m) + Cable Factor(dB)
3. The other emission levels were very low against the limit.
4. Margin value = Emission Level – Limit value
5. " * ": Fundamental frequency.

CHANNEL	TX Channel 6	DETECTOR FUNCTION	Peak (PK)
FREQUENCY RANGE	1GHz ~ 25GHz		Average (AV)

ANTENNA POLARITY & TEST DISTANCE: HORIZONTAL AT 3 M

NO.	FREQ. (MHz)	EMISSION LEVEL (dBuV/m)	LIMIT (dBuV/m)	MARGIN (dB)	ANTENNA HEIGHT (m)	TABLE ANGLE (Degree)	RAW VALUE (dBuV)	CORRECTION FACTOR (dB/m)
1	2390.00	57.7 PK	74.0	-16.3	1.40 H	89	25.20	32.50
2	2390.00	45.6 AV	54.0	-8.4	1.40 H	89	13.10	32.50
3	*2437.00	111.0 PK			1.03 H	271	78.30	32.70
4	*2437.00	100.5 AV			1.03 H	271	67.80	32.70
5	4874.00	46.9 PK	74.0	-27.1	1.26 H	127	41.00	5.90
6	4874.00	34.3 AV	54.0	-19.7	1.26 H	127	28.40	5.90

ANTENNA POLARITY & TEST DISTANCE: VERTICAL AT 3 M

NO.	FREQ. (MHz)	EMISSION LEVEL (dBuV/m)	LIMIT (dBuV/m)	MARGIN (dB)	ANTENNA HEIGHT (m)	TABLE ANGLE (Degree)	RAW VALUE (dBuV)	CORRECTION FACTOR (dB/m)
1	2390.00	68.4 PK	74.0	-5.6	1.48 V	157	35.90	32.50
2	2390.00	52.2 AV	54.0	-1.8	1.48 V	157	19.70	32.50
3	*2437.00	121.9 PK			1.59 V	159	89.20	32.70
4	*2437.00	111.6 AV			1.59 V	159	78.90	32.70
5	4874.00	47.1 PK	74.0	-26.9	1.42 V	149	41.20	5.90
6	4874.00	34.2 AV	54.0	-19.8	1.42 V	149	28.30	5.90

REMARKS:

1. Emission Level(dBuV/m) = Raw Value(dBuV) + Correction Factor(dB/m)
2. Correction Factor(dB/m) = Antenna Factor(dB/m) + Cable Factor(dB)
3. The other emission levels were very low against the limit.
4. Margin value = Emission Level – Limit value
5. " * " : Fundamental frequency.

CHANNEL	TX Channel 11	DETECTOR FUNCTION	Peak (PK)
FREQUENCY RANGE	1GHz ~ 25GHz		Average (AV)

ANTENNA POLARITY & TEST DISTANCE: HORIZONTAL AT 3 M

NO.	FREQ. (MHz)	EMISSION LEVEL (dBuV/m)	LIMIT (dBuV/m)	MARGIN (dB)	ANTENNA HEIGHT (m)	TABLE ANGLE (Degree)	RAW VALUE (dBuV)	CORRECTION FACTOR (dB/m)
1	*2462.00	104.3 PK			1.50 H	39	71.70	32.60
2	*2462.00	94.6 AV			1.50 H	39	62.00	32.60
3	2483.50	59.3 PK	74.0	-14.7	1.46 H	12	26.60	32.70
4	2483.50	47.1 AV	54.0	-6.9	1.46 H	12	14.40	32.70
5	4924.00	47.1 PK	74.0	-26.9	1.35 H	284	41.10	6.00
6	4924.00	34.2 AV	54.0	-19.8	1.35 H	284	28.20	6.00

ANTENNA POLARITY & TEST DISTANCE: VERTICAL AT 3 M

NO.	FREQ. (MHz)	EMISSION LEVEL (dBuV/m)	LIMIT (dBuV/m)	MARGIN (dB)	ANTENNA HEIGHT (m)	TABLE ANGLE (Degree)	RAW VALUE (dBuV)	CORRECTION FACTOR (dB/m)
1	*2462.00	115.8 PK			1.43 V	160	83.20	32.60
2	*2462.00	105.8 AV			1.43 V	160	73.20	32.60
3	2483.50	67.9 PK	74.0	-6.1	1.63 V	63	35.20	32.70
4	2483.50	52.7 AV	54.0	-1.3	1.63 V	63	20.00	32.70
5	4924.00	47.1 PK	74.0	-26.9	1.24 V	79	41.10	6.00
6	4924.00	34.6 AV	54.0	-19.4	1.24 V	79	28.60	6.00

REMARKS:

1. Emission Level(dBuV/m) = Raw Value(dBuV) + Correction Factor(dB/m)
2. Correction Factor(dB/m) = Antenna Factor(dB/m) + Cable Factor(dB)
3. The other emission levels were very low against the limit.
4. Margin value = Emission Level – Limit value
5. " * ": Fundamental frequency.

802.11n (HT40)

CHANNEL	TX Channel 3	DETECTOR FUNCTION	Peak (PK)
FREQUENCY RANGE	1GHz ~ 25GHz		Average (AV)

ANTENNA POLARITY & TEST DISTANCE: HORIZONTAL AT 3 M

NO.	FREQ. (MHz)	EMISSION LEVEL (dBuV/m)	LIMIT (dBuV/m)	MARGIN (dB)	ANTENNA HEIGHT (m)	TABLE ANGLE (Degree)	RAW VALUE (dBuV)	CORRECTION FACTOR (dB/m)
1	2390.00	58.8 PK	74.0	-15.2	2.46 H	247	26.30	32.50
2	2390.00	47.2 AV	54.0	-6.8	2.46 H	247	14.70	32.50
3	*2422.00	97.0 PK			2.31 H	358	64.40	32.60
4	*2422.00	87.8 AV			2.31 H	358	55.20	32.60
5	4844.00	46.7 PK	74.0	-27.3	1.64 H	174	40.80	5.90
6	4844.00	34.5 AV	54.0	-19.5	1.64 H	174	28.60	5.90

ANTENNA POLARITY & TEST DISTANCE: VERTICAL AT 3 M

NO.	FREQ. (MHz)	EMISSION LEVEL (dBuV/m)	LIMIT (dBuV/m)	MARGIN (dB)	ANTENNA HEIGHT (m)	TABLE ANGLE (Degree)	RAW VALUE (dBuV)	CORRECTION FACTOR (dB/m)
1	2390.00	65.2 PK	74.0	-8.8	1.57 V	223	32.70	32.50
2	2390.00	52.8 AV	54.0	-1.2	1.57 V	223	20.30	32.50
3	*2422.00	107.4 PK			1.76 V	112	74.80	32.60
4	*2422.00	98.0 AV			1.76 V	112	65.40	32.60
5	4844.00	47.1 PK	74.0	-26.9	1.00 V	97	41.20	5.90
6	4844.00	34.2 AV	54.0	-19.8	1.00 V	97	28.30	5.90

REMARKS:

1. Emission Level(dBuV/m) = Raw Value(dBuV) + Correction Factor(dB/m)
2. Correction Factor(dB/m) = Antenna Factor(dB/m) + Cable Factor(dB)
3. The other emission levels were very low against the limit.
4. Margin value = Emission Level – Limit value
5. " * ": Fundamental frequency.
6. " # ": The radiated frequency is out of the restricted band.

CHANNEL	TX Channel 6	DETECTOR FUNCTION	Peak (PK)
FREQUENCY RANGE	1GHz ~ 25GHz		Average (AV)

ANTENNA POLARITY & TEST DISTANCE: HORIZONTAL AT 3 M

NO.	FREQ. (MHz)	EMISSION LEVEL (dBuV/m)	LIMIT (dBuV/m)	MARGIN (dB)	ANTENNA HEIGHT (m)	TABLE ANGLE (Degree)	RAW VALUE (dBuV)	CORRECTION FACTOR (dB/m)
1	2390.00	57.0 PK	74.0	-17.0	1.04 H	105	24.50	32.50
2	2390.00	46.5 AV	54.0	-7.5	1.04 H	105	14.00	32.50
3	*2437.00	102.8 PK			1.48 H	2	70.10	32.70
4	*2437.00	93.3 AV			1.48 H	2	60.60	32.70
5	4874.00	47.1 PK	74.0	-26.9	1.13 H	84	41.20	5.90
6	4874.00	34.8 AV	54.0	-19.2	1.13 H	84	28.90	5.90

ANTENNA POLARITY & TEST DISTANCE: VERTICAL AT 3 M

NO.	FREQ. (MHz)	EMISSION LEVEL (dBuV/m)	LIMIT (dBuV/m)	MARGIN (dB)	ANTENNA HEIGHT (m)	TABLE ANGLE (Degree)	RAW VALUE (dBuV)	CORRECTION FACTOR (dB/m)
1	2390.00	65.6 PK	74.0	-8.4	1.64 V	242	33.10	32.50
2	2390.00	52.2 AV	54.0	-1.8	1.64 V	242	19.70	32.50
3	*2437.00	112.2 PK			1.59 V	124	79.50	32.70
4	*2437.00	103.2 AV			1.59 V	124	70.50	32.70
5	4874.00	47.0 PK	74.0	-27.0	1.37 V	49	41.10	5.90
6	4874.00	35.0 AV	54.0	-19.0	1.37 V	49	29.10	5.90

REMARKS:

1. Emission Level(dBuV/m) = Raw Value(dBuV) + Correction Factor(dB/m)
2. Correction Factor(dB/m) = Antenna Factor(dB/m) + Cable Factor(dB)
3. The other emission levels were very low against the limit.
4. Margin value = Emission Level – Limit value
5. " * ": Fundamental frequency.

CHANNEL	TX Channel 9	DETECTOR FUNCTION	Peak (PK)
FREQUENCY RANGE	1GHz ~ 25GHz		Average (AV)

ANTENNA POLARITY & TEST DISTANCE: HORIZONTAL AT 3 M

NO.	FREQ. (MHz)	EMISSION LEVEL (dBuV/m)	LIMIT (dBuV/m)	MARGIN (dB)	ANTENNA HEIGHT (m)	TABLE ANGLE (Degree)	RAW VALUE (dBuV)	CORRECTION FACTOR (dB/m)
1	*2452.00	96.7 PK			1.00 H	347	64.00	32.70
2	*2452.00	87.6 AV			1.00 H	347	54.90	32.70
3	2483.50	59.6 PK	74.0	-14.4	1.32 H	79	26.90	32.70
4	2483.50	47.7 AV	54.0	-6.3	1.32 H	79	15.00	32.70
5	4904.00	47.3 PK	74.0	-26.7	1.21 H	98	41.50	5.80
6	4904.00	34.2 AV	54.0	-19.8	1.21 H	98	28.40	5.80

ANTENNA POLARITY & TEST DISTANCE: VERTICAL AT 3 M

NO.	FREQ. (MHz)	EMISSION LEVEL (dBuV/m)	LIMIT (dBuV/m)	MARGIN (dB)	ANTENNA HEIGHT (m)	TABLE ANGLE (Degree)	RAW VALUE (dBuV)	CORRECTION FACTOR (dB/m)
1	*2452.00	108.4 PK			1.54 V	155	75.70	32.70
2	*2452.00	98.9 AV			1.54 V	155	66.20	32.70
3	2483.50	66.5 PK	74.0	-7.5	1.67 V	102	33.80	32.70
4	2483.50	52.6 AV	54.0	-1.4	1.67 V	102	19.90	32.70
5	4904.00	47.1 PK	74.0	-26.9	1.42 V	43	41.30	5.80
6	4904.00	34.6 AV	54.0	-19.4	1.42 V	43	28.80	5.80

REMARKS:

1. Emission Level(dBuV/m) = Raw Value(dBuV) + Correction Factor(dB/m)
2. Correction Factor(dB/m) = Antenna Factor(dB/m) + Cable Factor(dB)
3. The other emission levels were very low against the limit.
4. Margin value = Emission Level – Limit value
5. " * " : Fundamental frequency.

Below 1GHz Data:
Test Mode A
802.11b

CHANNEL	TX Channel 6	DETECTOR FUNCTION	Quasi-Peak (QP)
FREQUENCY RANGE	30MHz ~ 1GHz		

ANTENNA POLARITY & TEST DISTANCE: HORIZONTAL AT 3 M

NO.	FREQ. (MHz)	EMISSION LEVEL (dBuV/m)	LIMIT (dBuV/m)	MARGIN (dB)	ANTENNA HEIGHT (m)	TABLE ANGLE (Degree)	RAW VALUE (dBuV)	CORRECTION FACTOR (dB/m)
1	57.12	32.6 QP	40.0	-7.4	2.00 H	39	47.20	-14.60
2	96.01	32.0 QP	43.5	-11.5	2.00 H	80	51.60	-19.60
3	125.17	36.7 QP	43.5	-6.8	1.51 H	250	52.80	-16.10
4	154.33	36.5 QP	43.5	-7.0	1.00 H	91	50.40	-13.90
5	624.85	33.4 QP	46.0	-12.6	1.00 H	4	39.00	-5.60
6	834.84	44.0 QP	46.0	-2.0	1.51 H	162	45.90	-1.90

ANTENNA POLARITY & TEST DISTANCE: VERTICAL AT 3 M

NO.	FREQ. (MHz)	EMISSION LEVEL (dBuV/m)	LIMIT (dBuV/m)	MARGIN (dB)	ANTENNA HEIGHT (m)	TABLE ANGLE (Degree)	RAW VALUE (dBuV)	CORRECTION FACTOR (dB/m)
1	66.84	31.6 QP	40.0	-8.4	1.00 V	330	47.30	-15.70
2	125.17	37.6 QP	43.5	-5.9	1.00 V	188	53.70	-16.10
3	237.94	28.7 QP	46.0	-17.3	1.00 V	278	43.80	-15.10
4	374.04	28.9 QP	46.0	-17.1	1.00 V	247	39.90	-11.00
5	527.64	28.3 QP	46.0	-17.7	1.00 V	174	36.30	-8.00
6	825.11	34.9 QP	46.0	-11.1	1.99 V	144	36.80	-1.90

REMARKS:

1. Emission Level(dBuV/m) = Raw Value(dBuV) + Correction Factor(dB/m)
2. Correction Factor(dB/m) = Antenna Factor(dB/m) + Cable Factor(dB)
3. The other emission levels were very low against the limit.
4. Margin value = Emission Level – Limit value

Test Mode B
802.11b

CHANNEL	TX Channel 6	DETECTOR FUNCTION	Quasi-Peak (QP)
FREQUENCY RANGE	30MHz ~ 1GHz		

ANTENNA POLARITY & TEST DISTANCE: HORIZONTAL AT 3 M

NO.	FREQ. (MHz)	EMISSION LEVEL (dBuV/m)	LIMIT (dBuV/m)	MARGIN (dB)	ANTENNA HEIGHT (m)	TABLE ANGLE (Degree)	RAW VALUE (dBuV)	CORRECTION FACTOR (dB/m)
1	57.12	31.1 QP	40.0	-8.9	1.50 H	299	45.70	-14.60
2	183.50	34.3 QP	43.5	-9.2	1.00 H	108	50.10	-15.80
3	239.88	34.3 QP	46.0	-11.7	1.00 H	89	49.30	-15.00
4	523.75	30.5 QP	46.0	-15.5	1.50 H	86	38.40	-7.90
5	624.85	33.6 QP	46.0	-12.4	1.00 H	358	39.20	-5.60
6	875.67	34.5 QP	46.0	-11.5	1.50 H	10	35.60	-1.10

ANTENNA POLARITY & TEST DISTANCE: VERTICAL AT 3 M

NO.	FREQ. (MHz)	EMISSION LEVEL (dBuV/m)	LIMIT (dBuV/m)	MARGIN (dB)	ANTENNA HEIGHT (m)	TABLE ANGLE (Degree)	RAW VALUE (dBuV)	CORRECTION FACTOR (dB/m)
1	35.73	33.6 QP	40.0	-6.4	1.00 V	164	49.20	-15.60
2	76.56	29.7 QP	40.0	-10.3	1.00 V	159	47.10	-17.40
3	185.44	27.2 QP	43.5	-16.3	1.00 V	6	43.20	-16.00
4	235.99	26.6 QP	46.0	-19.4	1.00 V	49	41.90	-15.30
5	374.04	29.2 QP	46.0	-16.8	1.50 V	248	40.20	-11.00
6	624.85	30.2 QP	46.0	-15.8	1.50 V	6	35.80	-5.60

REMARKS:

1. Emission Level(dBuV/m) = Raw Value(dBuV) + Correction Factor(dB/m)
2. Correction Factor(dB/m) = Antenna Factor(dB/m) + Cable Factor(dB)
3. The other emission levels were very low against the limit.
4. Margin value = Emission Level – Limit value

Test Mode C
802.11b

CHANNEL	TX Channel 6	DETECTOR FUNCTION	Quasi-Peak (QP)
FREQUENCY RANGE	30MHz ~ 1GHz		

ANTENNA POLARITY & TEST DISTANCE: HORIZONTAL AT 3 M

NO.	FREQ. (MHz)	EMISSION LEVEL (dBuV/m)	LIMIT (dBuV/m)	MARGIN (dB)	ANTENNA HEIGHT (m)	TABLE ANGLE (Degree)	RAW VALUE (dBuV)	CORRECTION FACTOR (dB/m)
1	57.12	32.2 QP	40.0	-7.8	2.00 H	62	46.80	-14.60
2	72.67	32.4 QP	40.0	-7.6	1.50 H	295	49.30	-16.90
3	90.17	34.1 QP	43.5	-9.4	2.00 H	253	53.90	-19.80
4	136.84	39.5 QP	43.5	-4.0	2.00 H	73	54.60	-15.10
5	162.11	37.5 QP	43.5	-6.0	1.50 H	80	51.60	-14.10
6	220.44	42.3 QP	46.0	-3.7	1.00 H	73	58.60	-16.30
7	239.98	42.1 QP	46.0	-3.9	1.42 H	80	57.10	-15.00
8	374.04	37.3 QP	46.0	-8.7	1.00 H	131	48.30	-11.00
9	529.58	34.4 QP	46.0	-11.6	1.50 H	67	42.40	-8.00
10	961.21	45.6 QP	54.0	-8.4	1.50 H	159	45.10	0.50

ANTENNA POLARITY & TEST DISTANCE: VERTICAL AT 3 M

NO.	FREQ. (MHz)	EMISSION LEVEL (dBuV/m)	LIMIT (dBuV/m)	MARGIN (dB)	ANTENNA HEIGHT (m)	TABLE ANGLE (Degree)	RAW VALUE (dBuV)	CORRECTION FACTOR (dB/m)
1	49.34	35.1 QP	40.0	-4.9	1.00 V	323	49.50	-14.40
2	72.67	37.8 QP	40.0	-2.2	1.00 V	198	54.70	-16.90
3	239.88	41.0 QP	46.0	-5.0	1.00 V	134	56.00	-15.00
4	374.04	40.3 QP	46.0	-5.7	1.50 V	253	51.30	-11.00
5	527.64	37.2 QP	46.0	-8.8	1.00 V	242	45.20	-8.00
6	961.21	46.3 QP	54.0	-7.7	1.00 V	122	45.80	0.50

REMARKS:

1. Emission Level(dBuV/m) = Raw Value(dBuV) + Correction Factor(dB/m)
2. Correction Factor(dB/m) = Antenna Factor(dB/m) + Cable Factor(dB)
3. The other emission levels were very low against the limit.
4. Margin value = Emission Level – Limit value

Test Mode D
802.11b

CHANNEL	TX Channel 6	DETECTOR FUNCTION	Quasi-Peak (QP)
FREQUENCY RANGE	30MHz ~ 1GHz		

ANTENNA POLARITY & TEST DISTANCE: HORIZONTAL AT 3 M

NO.	FREQ. (MHz)	EMISSION LEVEL (dBuV/m)	LIMIT (dBuV/m)	MARGIN (dB)	ANTENNA HEIGHT (m)	TABLE ANGLE (Degree)	RAW VALUE (dBuV)	CORRECTION FACTOR (dB/m)
1	57.12	32.6 QP	40.0	-7.4	2.00 H	342	47.20	-14.60
2	90.17	33.5 QP	43.5	-10.0	2.00 H	280	53.30	-19.80
3	111.56	34.7 QP	43.5	-8.8	1.51 H	270	52.00	-17.30
4	241.83	41.4 QP	46.0	-4.6	1.00 H	102	56.20	-14.80
5	374.04	35.1 QP	46.0	-10.9	1.00 H	130	46.10	-11.00
6	529.58	35.4 QP	46.0	-10.6	1.51 H	77	43.40	-8.00
7	959.27	41.8 QP	46.0	-4.2	1.00 H	145	41.30	0.50

ANTENNA POLARITY & TEST DISTANCE: VERTICAL AT 3 M

NO.	FREQ. (MHz)	EMISSION LEVEL (dBuV/m)	LIMIT (dBuV/m)	MARGIN (dB)	ANTENNA HEIGHT (m)	TABLE ANGLE (Degree)	RAW VALUE (dBuV)	CORRECTION FACTOR (dB/m)
1	84.34	33.6 QP	40.0	-6.4	1.50 V	212	52.90	-19.30
2	111.56	36.2 QP	43.5	-7.3	1.00 V	8	53.50	-17.30
3	239.88	39.5 QP	46.0	-6.5	1.00 V	153	54.50	-15.00
4	374.04	37.6 QP	46.0	-8.4	1.50 V	258	48.60	-11.00
5	529.58	36.4 QP	46.0	-9.6	1.00 V	74	44.40	-8.00
6	959.27	43.8 QP	46.0	-2.2	1.50 V	70	43.30	0.50

REMARKS:

1. Emission Level(dBuV/m) = Raw Value(dBuV) + Correction Factor(dB/m)
2. Correction Factor(dB/m) = Antenna Factor(dB/m) + Cable Factor(dB)
3. The other emission levels were very low against the limit.
4. Margin value = Emission Level – Limit value

4.2 Conducted Emission Measurement

4.2.1 Limits of Conducted Emission Measurement

Frequency (MHz)	Conducted Limit (dBuV)	
	Quasi-peak	Average
0.15 - 0.5	66 - 56	56 - 46
0.50 - 5.0	56	46
5.0 - 30.0	60	50

Note: 1. The lower limit shall apply at the transition frequencies.

2. The limit decreases in line with the logarithm of the frequency in the range of 0.15 to 0.50MHz.

4.2.2 Test Instruments

Description & Manufacturer	Model No.	Serial No.	Date Of Calibration	Due Date Of Calibration
Test Receiver ROHDE & SCHWARZ	ESCS30	100288	Apr. 27, 2015	Apr. 26, 2016
RF signal cable Woken	5D-FB	Cable-HYCO2-01	Dec. 26, 2014	Dec. 25, 2015
LISN ROHDE & SCHWARZ (EUT)	ESH2-Z5	100100	Dec. 30, 2014	Dec. 29, 2015
LISN ROHDE & SCHWARZ (Peripheral)	ESH3-Z5	100312	Jul. 10, 2014	Jul. 09, 2015
Software ADT	BV ADT_Cond_ V7.3.7.3	NA	NA	NA

Notes: 1. The calibration interval of the above test instruments is 12 months and the calibrations are traceable to NML/ROC and NIST/USA.

2. The test was performed in HwaYa Shielded Room 2.

3. The VCCI Site Registration No. is C-2047.

4.2.3 Test Procedures

- The EUT was placed 0.4 meters from the conducting wall of the shielded room with EUT being connected to the power mains through a line impedance stabilization network (LISN). Other support units were connected to the power mains through another LISN. The two LISNs provide 50 ohm/ 50uH of coupling impedance for the measuring instrument.
- Both lines of the power mains connected to the EUT were checked for maximum conducted interference.
- The frequency range from 150kHz to 30MHz was searched. Emission levels under (Limit - 20dB) was not recorded.

NOTE: The resolution bandwidth and video bandwidth of test receiver is 9kHz for quasi-peak detection (QP) and average detection (AV) at frequency 0.15MHz-30MHz.

4.2.4 Deviation from Test Standard

No deviation.

4.2.5 Test Setup

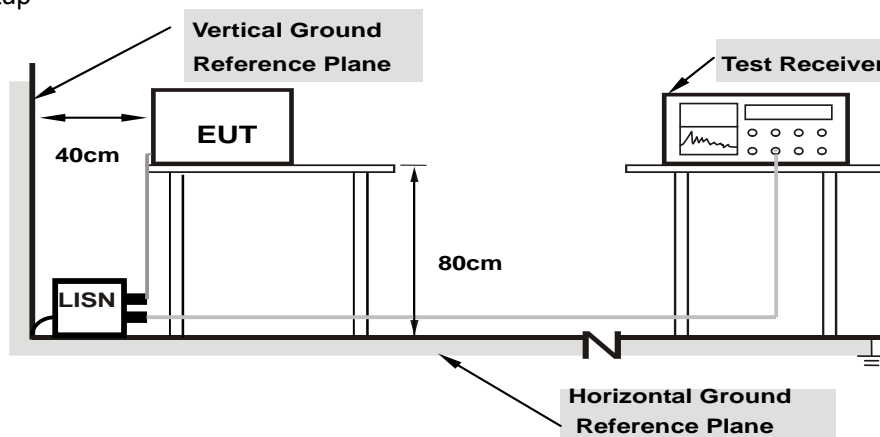

Note: 1.Support units were connected to second LISN.

For the actual test configuration, please refer to the attached file (Test Setup Photo).

4.2.6 EUT Operating Conditions

Same as 4.1.6.

4.2.7 Test Results

Test Mode A

802.11b

Phase	Line (L)	Detector Function	Quasi-Peak (QP) / Average (AV)
-------	----------	-------------------	--------------------------------

No	Freq. [MHz]	Corr. Factor (dB)	Reading Value [dB (uV)]		Emission Level [dB (uV)]		Limit [dB (uV)]		Margin (dB)	
			Q.P.	AV.	Q.P.	AV.	Q.P.	AV.	Q.P.	AV.
			1	0.18516	0.20	44.07	36.23	44.27	36.43	64.25
2	0.24375	0.20	39.37	31.64	39.57	31.84	61.97	51.97	-22.40	-20.13
3	0.30625	0.20	38.91	32.84	39.11	33.04	60.07	50.07	-20.96	-17.03
4	0.50156	0.22	45.17	35.08	45.39	35.30	56.00	46.00	-10.61	-10.70
5	0.95469	0.29	36.84	28.69	37.13	28.98	56.00	46.00	-18.87	-17.02
6	1.25781	0.32	35.93	29.17	36.25	29.49	56.00	46.00	-19.75	-16.51

REMARKS:

1. Q.P. and AV. are abbreviations of quasi-peak and average individually.
2. The emission levels of other frequencies were very low against the limit.
3. Margin value = Emission level - Limit value
4. Correction factor = Insertion loss + Cable loss
5. Emission Level = Correction Factor + Reading Value.

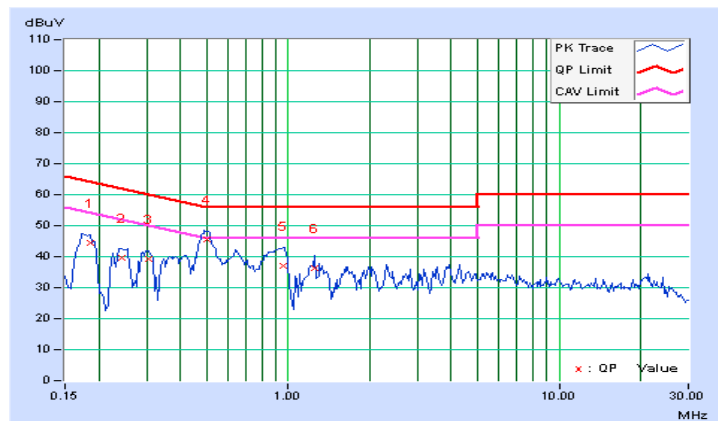

Phase	Neutral (N)	Detector Function	Quasi-Peak (QP) / Average (AV)
-------	-------------	-------------------	--------------------------------

No	Freq. [MHz]	Corr. Factor (dB)	Reading Value		Emission Level		Limit		Margin	
			[dB (uV)]		[dB (uV)]		[dB (uV)]		(dB)	
			Q.P.	AV.	Q.P.	AV.	Q.P.	AV.	Q.P.	AV.
1	0.17734	0.21	42.56	28.70	42.77	28.91	64.61	54.61	-21.84	-25.70
2	0.25156	0.23	34.57	24.14	34.80	24.37	61.71	51.71	-26.91	-27.34
3	0.31016	0.24	36.37	28.84	36.61	29.08	59.97	49.97	-23.36	-20.89
4	0.50156	0.26	43.78	34.02	44.04	34.28	56.00	46.00	-11.96	-11.72
5	0.93906	0.30	36.17	27.40	36.47	27.70	56.00	46.00	-19.53	-18.30
6	1.60156	0.36	33.56	27.11	33.92	27.47	56.00	46.00	-22.08	-18.53

REMARKS:

1. Q.P. and AV. are abbreviations of quasi-peak and average individually.
2. The emission levels of other frequencies were very low against the limit.
3. Margin value = Emission level - Limit value
4. Correction factor = Insertion loss + Cable loss
5. Emission Level = Correction Factor + Reading Value.

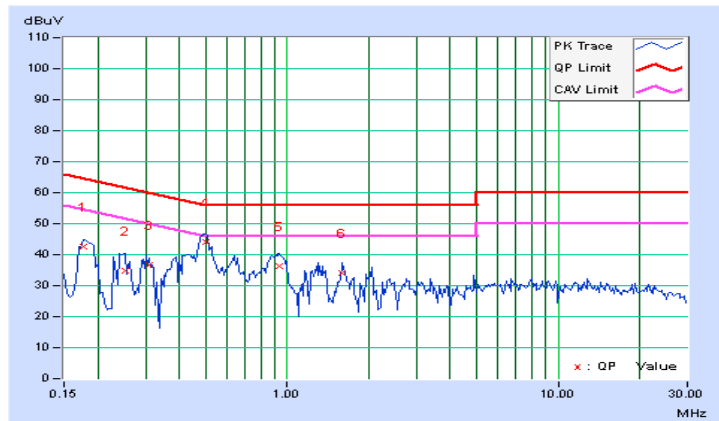

Test Mode B
802.11b

Phase	Line (L)	Detector Function	Quasi-Peak (QP) / Average (AV)
-------	----------	-------------------	--------------------------------

No	Freq. [MHz]	Corr. Factor (dB)	Reading Value		Emission Level		Limit		Margin	
			[dB (uV)]		[dB (uV)]		[dB (uV)]		(dB)	
			Q.P.	AV.	Q.P.	AV.	Q.P.	AV.	Q.P.	AV.
1	0.15391	0.20	59.68	47.13	59.88	47.33	65.79	55.79	-5.91	-8.46
2	0.18125	0.20	54.05	39.14	54.25	39.34	64.43	54.43	-10.18	-15.09
3	0.21641	0.20	49.39	36.37	49.59	36.57	62.96	52.96	-13.37	-16.39
4	0.52500	0.22	40.33	34.59	40.55	34.81	56.00	46.00	-15.45	-11.19
5	4.64453	0.44	38.25	32.53	38.69	32.97	56.00	46.00	-17.31	-13.03
6	11.42188	0.52	47.12	41.86	47.64	42.38	60.00	50.00	-12.36	-7.62

REMARKS:

1. Q.P. and AV. are abbreviations of quasi-peak and average individually.
2. The emission levels of other frequencies were very low against the limit.
3. Margin value = Emission level - Limit value
4. Correction factor = Insertion loss + Cable loss
5. Emission Level = Correction Factor + Reading Value.

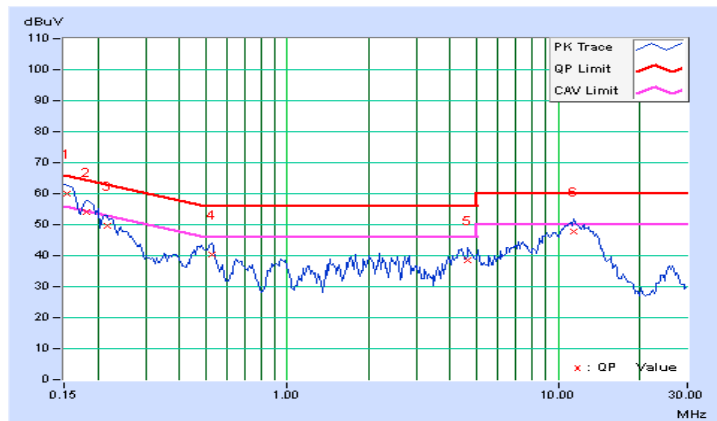

Phase	Neutral (N)	Detector Function	Quasi-Peak (QP) / Average (AV)
-------	-------------	-------------------	--------------------------------

No	Freq. [MHz]	Corr. Factor (dB)	Reading Value		Emission Level		Limit		Margin	
			[dB (uV)]		[dB (uV)]		[dB (uV)]		(dB)	
			Q.P.	AV.	Q.P.	AV.	Q.P.	AV.	Q.P.	AV.
1	0.15781	0.21	58.82	45.95	59.03	46.16	65.58	55.58	-6.55	-9.42
2	0.18125	0.21	53.83	38.96	54.04	39.17	64.43	54.43	-10.38	-15.25
3	0.20859	0.22	48.42	31.15	48.64	31.37	63.26	53.26	-14.62	-21.89
4	0.22031	0.22	48.29	34.33	48.51	34.55	62.81	52.81	-14.29	-18.25
5	0.52891	0.26	39.25	33.65	39.51	33.91	56.00	46.00	-16.49	-12.09
6	12.03516	0.62	42.65	37.21	43.27	37.83	60.00	50.00	-16.73	-12.17

REMARKS:

1. Q.P. and AV. are abbreviations of quasi-peak and average individually.
2. The emission levels of other frequencies were very low against the limit.
3. Margin value = Emission level - Limit value
4. Correction factor = Insertion loss + Cable loss
5. Emission Level = Correction Factor + Reading Value.

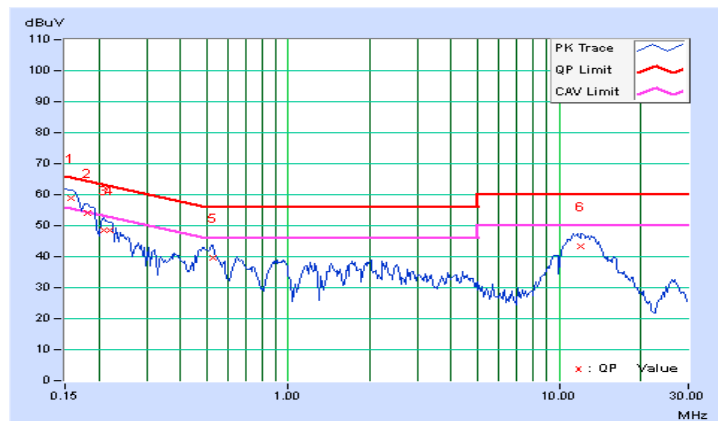

Test Mode C
802.11b

Phase	Line (L)	Detector Function	Quasi-Peak (QP) / Average (AV)
-------	----------	-------------------	--------------------------------

No	Freq. [MHz]	Corr. Factor (dB)	Reading Value		Emission Level		Limit		Margin	
			[dB (uV)]		[dB (uV)]		[dB (uV)]		(dB)	
			Q.P.	AV.	Q.P.	AV.	Q.P.	AV.	Q.P.	AV.
1	0.19687	0.20	42.18	34.51	42.38	34.71	63.74	53.74	-21.36	-19.03
2	0.25938	0.20	38.78	31.87	38.98	32.07	61.45	51.45	-22.47	-19.38
3	0.46641	0.21	43.60	35.60	43.81	35.81	56.58	46.58	-12.77	-10.77
4	0.50156	0.22	44.09	36.42	44.31	36.64	56.00	46.00	-11.69	-9.36
5	0.88828	0.28	38.60	31.28	38.88	31.56	56.00	46.00	-17.12	-14.44
6	3.83594	0.42	33.96	28.01	34.38	28.43	56.00	46.00	-21.62	-17.57

REMARKS:

1. Q.P. and AV. are abbreviations of quasi-peak and average individually.
2. The emission levels of other frequencies were very low against the limit.
3. Margin value = Emission level - Limit value
4. Correction factor = Insertion loss + Cable loss
5. Emission Level = Correction Factor + Reading Value.

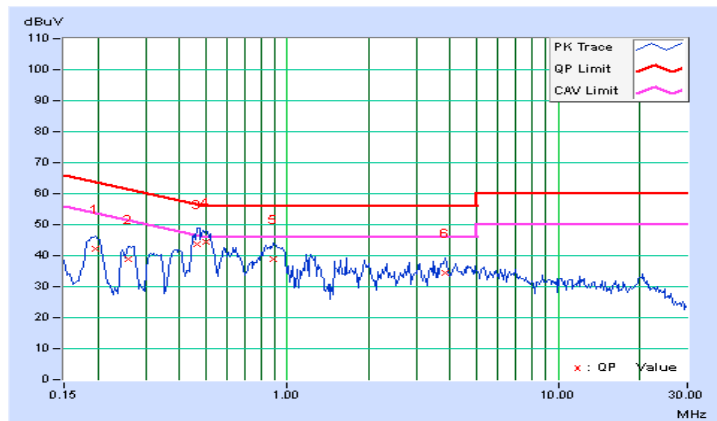

Phase	Neutral (N)	Detector Function	Quasi-Peak (QP) / Average (AV)
-------	-------------	-------------------	--------------------------------

No	Freq. [MHz]	Corr. Factor (dB)	Reading Value		Emission Level		Limit		Margin	
			[dB (uV)]		[dB (uV)]		[dB (uV)]		(dB)	
			Q.P.	AV.	Q.P.	AV.	Q.P.	AV.	Q.P.	AV.
1	0.19687	0.22	40.30	29.45	40.52	29.67	63.74	53.74	-23.22	-24.07
2	0.26328	0.23	37.02	28.52	37.25	28.75	61.33	51.33	-24.08	-22.58
3	0.47422	0.26	42.25	32.32	42.51	32.58	56.44	46.44	-13.93	-13.86
4	0.50156	0.26	42.42	34.69	42.68	34.95	56.00	46.00	-13.32	-11.05
5	0.88828	0.30	36.24	28.30	36.54	28.60	56.00	46.00	-19.46	-17.40
6	1.29688	0.34	35.40	28.03	35.74	28.37	56.00	46.00	-20.26	-17.63

REMARKS:

1. Q.P. and AV. are abbreviations of quasi-peak and average individually.
2. The emission levels of other frequencies were very low against the limit.
3. Margin value = Emission level - Limit value
4. Correction factor = Insertion loss + Cable loss
5. Emission Level = Correction Factor + Reading Value.

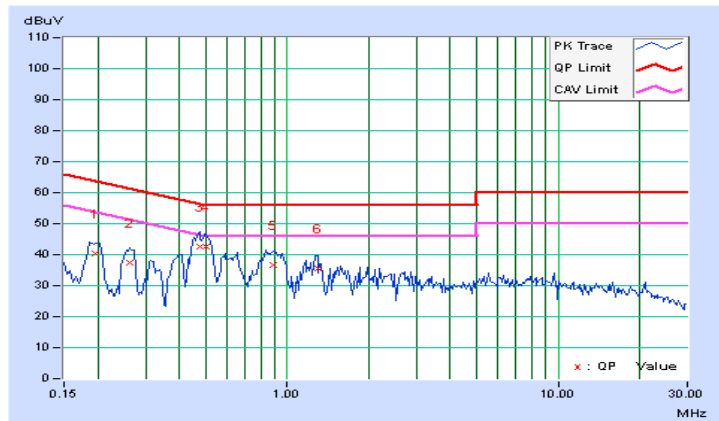

Test Mode D
802.11b

Phase	Line (L)	Detector Function	Quasi-Peak (QP) / Average (AV)
-------	----------	-------------------	--------------------------------

No	Freq. [MHz]	Corr. Factor (dB)	Reading Value [dB (uV)]		Emission Level [dB (uV)]		Limit [dB (uV)]		Margin (dB)	
			Q.P.	AV.	Q.P.	AV.	Q.P.	AV.	Q.P.	AV.
			1	0.15000	0.19	60.48	40.89	60.67	41.08	66.00
2	0.16953	0.20	59.43	46.03	59.63	46.23	64.98	54.98	-5.36	-8.76
3	0.20859	0.20	53.89	40.60	54.09	40.80	63.26	53.26	-9.17	-12.46
4	0.24375	0.20	48.83	35.73	49.03	35.93	61.97	51.97	-12.94	-16.04
5	0.53281	0.22	40.23	33.98	40.45	34.20	56.00	46.00	-15.55	-11.80
6	11.10547	0.52	47.46	42.18	47.98	42.70	60.00	50.00	-12.02	-7.30

REMARKS:

1. Q.P. and AV. are abbreviations of quasi-peak and average individually.
2. The emission levels of other frequencies were very low against the limit.
3. Margin value = Emission level - Limit value
4. Correction factor = Insertion loss + Cable loss
5. Emission Level = Correction Factor + Reading Value.

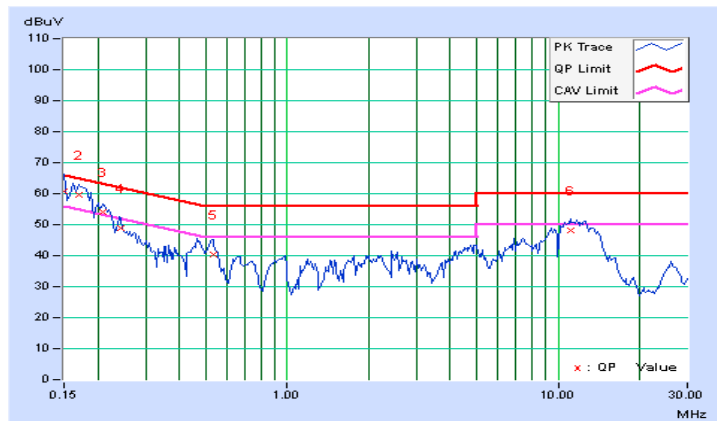

Phase	Neutral (N)	Detector Function	Quasi-Peak (QP) / Average (AV)
-------	-------------	-------------------	--------------------------------

No	Freq. [MHz]	Corr. Factor (dB)	Reading Value		Emission Level		Limit		Margin	
			[dB (uV)]		[dB (uV)]		[dB (uV)]		(dB)	
			Q.P.	AV.	Q.P.	AV.	Q.P.	AV.	Q.P.	AV.
1	0.15000	0.20	59.36	38.63	59.56	38.83	66.00	56.00	-6.44	-17.17
2	0.16172	0.21	56.02	36.28	56.23	36.49	65.38	55.38	-9.15	-18.89
3	0.20859	0.22	52.89	39.42	53.11	39.64	63.26	53.26	-10.15	-13.62
4	0.24766	0.23	46.69	32.55	46.92	32.78	61.84	51.84	-14.92	-19.06
5	0.52500	0.26	40.53	34.14	40.79	34.40	56.00	46.00	-15.21	-11.60
6	11.57031	0.61	43.57	38.36	44.18	38.97	60.00	50.00	-15.82	-11.03

REMARKS:

1. Q.P. and AV. are abbreviations of quasi-peak and average individually.
2. The emission levels of other frequencies were very low against the limit.
3. Margin value = Emission level - Limit value
4. Correction factor = Insertion loss + Cable loss
5. Emission Level = Correction Factor + Reading Value.

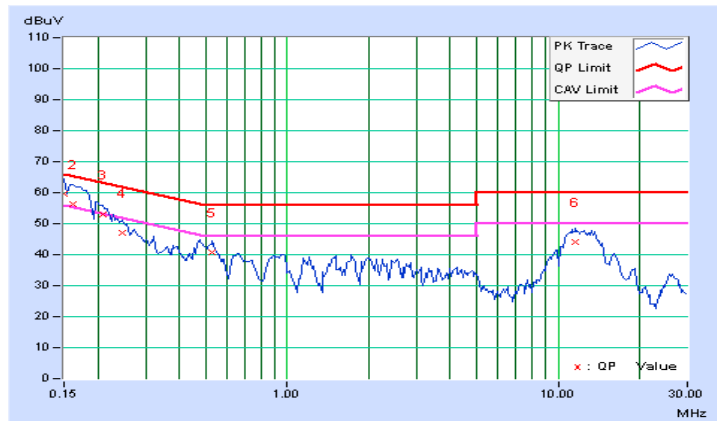

4.3 6dB Bandwidth Measurement

4.3.1 Limits of 6dB Bandwidth Measurement

The minimum of 6dB Bandwidth Measurement is 0.5 MHz.

4.3.2 Test Setup

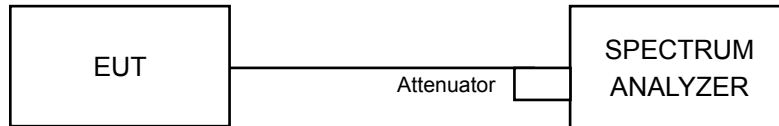

4.3.3 Test Instruments

Refer to section 4.1.2 to get information of above instrument.

4.3.4 Test Procedure

- a. Set resolution bandwidth (RBW) = 100kHz
- b. Set the video bandwidth (VBW) $\geq 3 \times$ RBW, Detector = Peak.
- c. Trace mode = max hold.
- d. Sweep = auto couple.
- e. Measure the maximum width of the emission that is constrained by the frequencies associated with the two amplitude points (upper and lower) that are attenuated by 6 dB relative to the maximum level measured in the fundamental emission

4.3.5 Deviation from Test Standard

No deviation.

4.3.6 EUT Operating Conditions

The software provided by client to enable the EUT under transmission condition continuously at lowest, middle and highest channel frequencies individually.

4.3.7 Test Result

802.11b

Channel	Frequency (MHz)	6dB Bandwidth (MHz)			Minimum Limit (MHz)	Pass / Fail
		CHAIN 0	CHAIN 1	CHAIN 2		
1	2412	10.10	10.11	10.11	0.5	PASS
6	2437	10.11	10.12	10.13	0.5	PASS
11	2462	10.12	10.12	10.11	0.5	PASS

802.11g

Channel	Frequency (MHz)	6dB Bandwidth (MHz)			Minimum Limit (MHz)	Pass / Fail
		CHAIN 0	CHAIN 1	CHAIN 2		
1	2412	16.38	16.39	16.36	0.5	PASS
6	2437	16.36	16.33	16.08	0.5	PASS
11	2462	16.38	16.36	16.37	0.5	PASS

802.11n (HT20)

Channel	Frequency (MHz)	6dB Bandwidth (MHz)			Minimum Limit (MHz)	Pass / Fail
		CHAIN 0	CHAIN 1	CHAIN 2		
1	2412	17.59	17.17	17.31	0.5	PASS
6	2437	17.56	16.70	16.97	0.5	PASS
11	2462	17.33	17.59	17.30	0.5	PASS

802.11n (HT40)

Channel	Frequency (MHz)	6dB Bandwidth (MHz)			Minimum Limit (MHz)	Pass / Fail
		CHAIN 0	CHAIN 1	CHAIN 2		
3	2422	35.56	35.58	35.86	0.5	PASS
6	2437	35.29	35.40	35.58	0.5	PASS
9	2452	35.54	35.28	35.57	0.5	PASS

Spectrum Plot of Worst Value

802.11b

802.11g

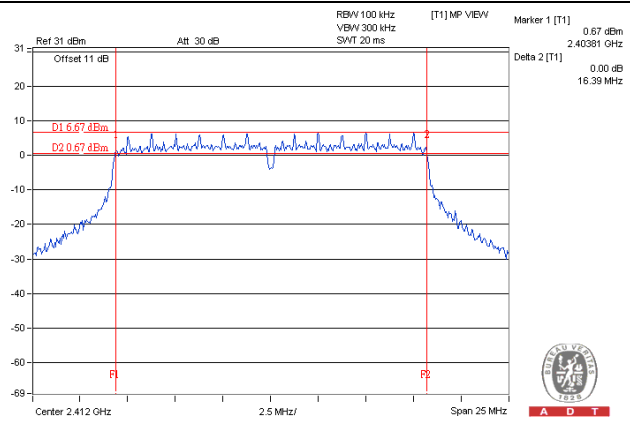
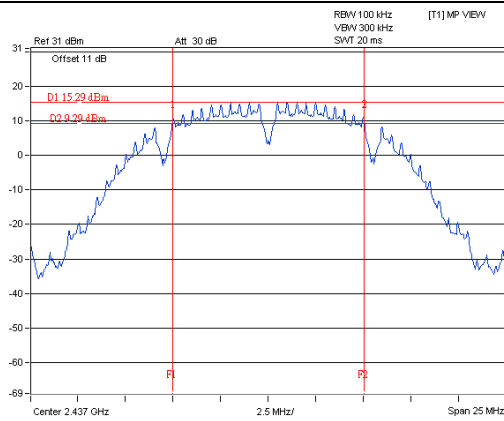

802.11n (HT20)

802.11n (HT40)

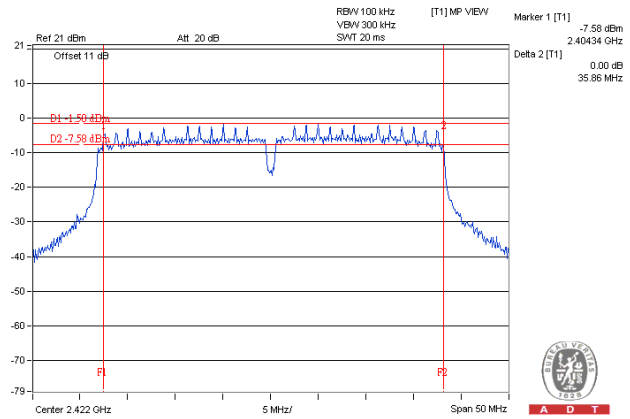
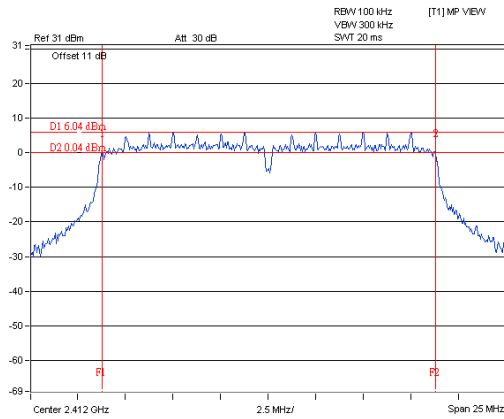

4.4 Conducted Output Power Measurement

4.4.1 Limits of Conducted Output Power Measurement

For systems using digital modulation in the 2400–2483.5 MHz bands: 1 Watt (30dBm)

Per KDB 662911 D01 Multiple Transmitter Output Method of conducted output power measurement on IEEE 802.11 devices,

Array Gain = 0 dB (i.e., no array gain) for $NANT \leq 4$;

Array Gain = 0 dB (i.e., no array gain) for channel widths ≥ 40 MHz for any NANT;

Array Gain = $5 \log(NANT/NSS)$ dB or 3 dB, whichever is less for 20-MHz channel widths with $NANT \geq 5$.

For power measurements on all other devices: Array Gain = $10 \log(NANT/NSS)$ dB.

4.4.2 Test Setup

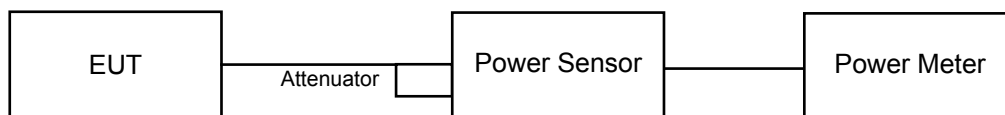

4.4.3 Test Instruments

Refer to section 4.1.2 to get information of above instrument.

4.4.4 Test Procedures

An average power sensor was used on the output port of the EUT. A power meter was used to read the response of the average power sensor. Record the power level.

4.4.5 Deviation from Test Standard

No deviation.

4.4.6 EUT Operating Conditions

Same as Item 4.3.6.

4.4.7 Test Results

FOR AVERAGE POWER

802.11b

Chan.	Freq. (MHz)	Average Power (dBm)			Total Power (mW)	Total Power (dBm)	Limit (dBm)	Pass / Fail
		Chain 0	Chain 1	Chain 2				
1	2412	20.66	20.60	20.90	354.255	25.49	30	Pass
6	2437	24.57	24.53	24.67	863.299	29.36	30	Pass
11	2462	21.29	21.06	21.53	404.463	26.07	30	Pass

802.11g

Chan.	Freq. (MHz)	Average Power (dBm)			Total Power (mW)	Total Power (dBm)	Limit (dBm)	Pass / Fail
		Chain 0	Chain 1	Chain 2				
1	2412	17.26	17.31	17.56	164.054	22.15	30	Pass
6	2437	24.25	24.28	24.30	803.143	29.05	30	Pass
11	2462	18.81	18.92	18.97	232.902	23.67	30	Pass

802.11n (HT20)

Chan.	Freq. (MHz)	Average Power (dBm)			Total Power (mW)	Total Power (dBm)	Limit (dBm)	Pass / Fail
		Chain 0	Chain 1	Chain 2				
1	2412	17.02	17.08	17.41	156.481	21.94	30	Pass
6	2437	23.46	23.62	23.45	673.273	28.28	30	Pass
11	2462	18.02	18.26	18.37	199.082	22.99	30	Pass

802.11n (HT40)

Chan.	Freq. (MHz)	Average Power (dBm)			Total Power (mW)	Total Power (dBm)	Limit (dBm)	Pass / Fail
		Chain 0	Chain 1	Chain 2				
3	2422	11.59	11.92	12.06	46.050	16.63	30	Pass
6	2437	17.41	17.53	17.66	170.050	22.31	30	Pass
9	2452	11.63	11.74	12.03	45.442	16.57	30	Pass

4.5 Power Spectral Density Measurement

4.5.1 Limits of Power Spectral Density Measurement

The Maximum of Power Spectral Density Measurement is 8dBm.

4.5.2 Test Setup

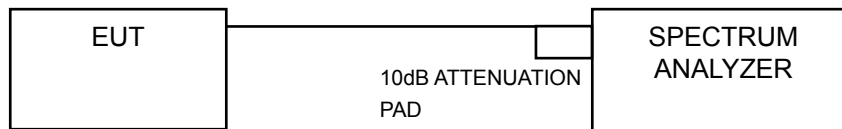

4.5.3 Test Instruments

Refer to section 4.1.2 to get information of above instrument.

4.5.4 Test Procedure

For AVG. power (duty cycle $\geq 98\%$)

- Set instrument center frequency to DTS channel center frequency.
- Set span to at least 1.5 times the OBW.
- Set RBW to: $3 \text{ kHz} \leq \text{RBW} \leq 100 \text{ kHz}$.
- Set VBW $\geq 3 \times \text{RBW}$.
- Detector = power averaging (RMS) or sample detector (when RMS not available).
- Ensure that the number of measurement points in the sweep $\geq 2 \times \text{span}/\text{RBW}$.
- Sweep time = auto couple.
- Employ trace averaging (RMS) mode over a minimum of 100 traces.
- Use the peak marker function to determine the maximum amplitude level.

For AVG. power (duty cycle $< 98\%$)

- Measure the duty cycle (x).
- Set instrument center frequency to DTS channel center frequency.
- Set span to at least 1.5 times the OBW.
- Set RBW to: $3 \text{ kHz} \leq \text{RBW} \leq 100 \text{ kHz}$.
- Set VBW $\geq 3 \times \text{RBW}$.
- Detector = power averaging (RMS) or sample detector (when RMS not available).
- Ensure that the number of measurement points in the sweep $\geq 2 \times \text{span}/\text{RBW}$.
- Sweep time = auto couple.
- Do not use sweep triggering. Allow sweep to "free run".
- Employ trace averaging (RMS) mode over a minimum of 100 traces.
- Use the peak marker function to determine the maximum amplitude level.
- Add $10 \log(1/x)$, where x is the duty cycle measured in step (a), to the measured PSD to compute the average PSD during the actual transmission time.

4.5.5 Deviation from Test Standard

No deviation.

4.5.6 EUT Operating Condition

Same as Item 4.3.6

4.5.7 Test Results

802.11b

TX chain	Channel	Freq. (MHz)	PSD (dBm)	10 log (N=3) dB	Total PSD (dBm)	Limit (dBm)	Pass /Fail
0	1	2412	-8.33	4.77	-3.56	5.23	Pass
	6	2437	-4.30	4.77	0.47	5.23	Pass
	11	2462	-7.56	4.77	-2.79	5.23	Pass
1	1	2412	-7.50	4.77	-2.73	5.23	Pass
	6	2437	-4.49	4.77	0.28	5.23	Pass
	11	2462	-8.04	4.77	-3.27	5.23	Pass
2	1	2412	-8.21	4.77	-3.44	5.23	Pass
	6	2437	-4.47	4.77	0.30	5.23	Pass
	11	2462	-7.73	4.77	-2.96	5.23	Pass

NOTE:

- Method 1 of power density measurement of KDB 662911 is using for calculating total power density. Total power density is summing entire spectra across corresponding frequency bins on the various outputs by computer.
- Internal antenna: Directional gain = $10 \log[(10^{G1/20} + 10^{G2/20} + \dots + 10^{GN/20})^2/3]$ = 8.01dBi
 External antenna: Directional gain = 4dBi + $10 \log(3)$ = 8.77dBi
 The Max. gain: 8.77dBi > 6dBi, so the power density limit shall be reduced to $8 - (8.77 - 6) = 5.23$ dBm.

802.11g

TX chain	Channel	Freq. (MHz)	PSD (dBm)	10 log (N=3) dB	Duty Factor	Total PSD with Duty Factor (dBm)	Limit (dBm)	Pass /Fail
0	1	2412	-14.11	4.77	0.17	-9.17	5.23	Pass
	6	2437	-6.33	4.77	0.17	-1.39	5.23	Pass
	11	2462	-11.83	4.77	0.17	-6.89	5.23	Pass
1	1	2412	-13.48	4.77	0.17	-8.54	5.23	Pass
	6	2437	-6.36	4.77	0.17	-1.42	5.23	Pass
	11	2462	-12.01	4.77	0.17	-7.07	5.23	Pass
2	1	2412	-13.44	4.77	0.17	-8.50	5.23	Pass
	6	2437	-6.45	4.77	0.17	-1.51	5.23	Pass
	11	2462	-12.55	4.77	0.17	-7.61	5.23	Pass

NOTE:

- Method 1 of power density measurement of KDB 662911 is using for calculating total power density. Total power density is summing entire spectra across corresponding frequency bins on the various outputs by computer.
- Internal antenna: Directional gain = $10 \log[(10^{G1/20} + 10^{G2/20} + \dots + 10^{GN/20})^2/3]$ = 8.01dBi
 External antenna: Directional gain = 4dBi + $10 \log(3)$ = 8.77dBi
 The Max. gain: 8.77dBi > 6dBi, so the power density limit shall be reduced to $8 - (8.77 - 6) = 5.23$ dBm.
- Refer to section 3.3 for duty cycle spectrum plot.

802.11n (HT20)

TX chain	Channel	Freq. (MHz)	PSD (dBm)	10 log (N=3) dB	Duty Factor	Total PSD with Duty Factor (dBm)	Limit (dBm)	Pass /Fail
0	1	2412	-14.50	4.77	0.18	-9.55	5.23	Pass
	6	2437	-7.91	4.77	0.18	-2.96	5.23	Pass
	11	2462	-12.66	4.77	0.18	-7.71	5.23	Pass
1	1	2412	-13.64	4.77	0.18	-8.69	5.23	Pass
	6	2437	-7.55	4.77	0.18	-2.60	5.23	Pass
	11	2462	-12.98	4.77	0.18	-8.03	5.23	Pass
2	1	2412	-14.00	4.77	0.18	-9.05	5.23	Pass
	6	2437	-8.21	4.77	0.18	-3.26	5.23	Pass
	11	2462	-12.76	4.77	0.18	-7.81	5.23	Pass

NOTE:

- Method 1 of power density measurement of KDB 662911 is using for calculating total power density. Total power density is summing entire spectra across corresponding frequency bins on the various outputs by computer.
- Internal antenna: Directional gain = $10 \log[(10^{G1/20} + 10^{G2/20} + \dots + 10^{GN/20})^2/3]$ = 8.01dBi
 External antenna: Directional gain = 4dBi + $10 \log(3)$ = 8.77dBi
 The Max. gain: 8.77dBi > 6dBi, so the power density limit shall be reduced to 8-(8.77-6) = 5.23dBm.
- Refer to section 3.3 for duty cycle spectrum plot.

802.11n (HT40)

TX chain	Channel	Freq. (MHz)	PSD (dBm)	10 log (N=3) dB	Duty Factor	Total PSD with Duty Factor (dBm)	Limit (dBm)	Pass /Fail
0	3	2422	-21.71	4.77	0.34	-16.60	5.23	Pass
	6	2437	-16.26	4.77	0.34	-11.15	5.23	Pass
	9	2452	-22.07	4.77	0.34	-16.96	5.23	Pass
1	3	2422	-21.91	4.77	0.34	-16.80	5.23	Pass
	6	2437	-16.12	4.77	0.34	-11.01	5.23	Pass
	9	2452	-22.16	4.77	0.34	-17.05	5.23	Pass
2	3	2422	-21.31	4.77	0.34	-16.20	5.23	Pass
	6	2437	-16.36	4.77	0.34	-11.25	5.23	Pass
	9	2452	-21.71	4.77	0.34	-16.60	5.23	Pass

NOTE:

- Method 1 of power density measurement of KDB 662911 is using for calculating total power density. Total power density is summing entire spectra across corresponding frequency bins on the various outputs by computer.
- Internal antenna: Directional gain = $10 \log[(10^{G1/20} + 10^{G2/20} + \dots + 10^{GN/20})^2/3]$ = 8.01dBi
 External antenna: Directional gain = 4dBi + $10 \log(3)$ = 8.77dBi
 The Max. gain: 8.77dBi > 6dBi, so the power density limit shall be reduced to 8-(8.77-6) = 5.23dBm.
- Refer to section 3.3 for duty cycle spectrum plot.

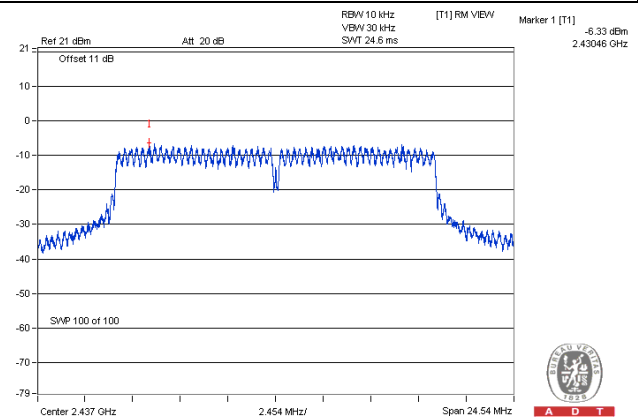
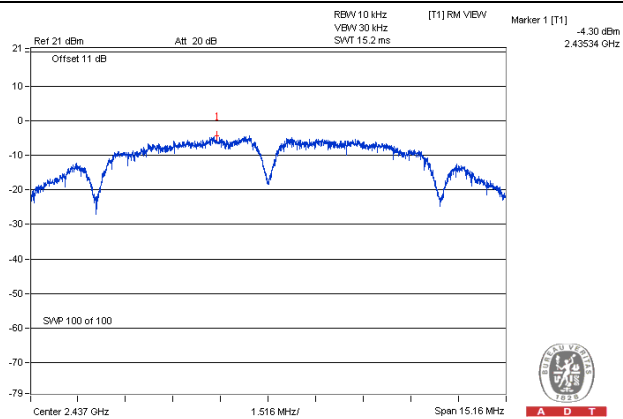
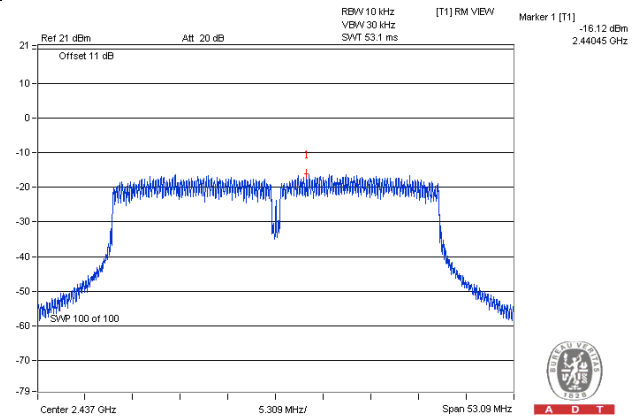
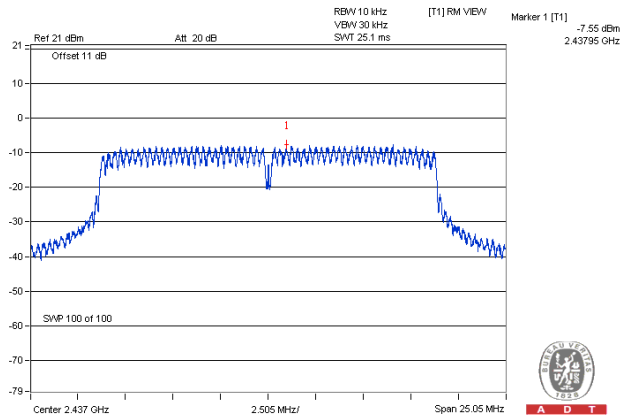
Spectrum Plot of Worst Value**802.11b****802.11g****802.11n (HT20)****802.11n (HT40)**

4.6 Conducted Out of Band Emission Measurement

4.6.1 Limits of Conducted Out of Band Emission Measurement

Below 30dB of the highest emission level of operating band (in 100kHz Resolution Bandwidth).

4.6.2 Test Setup

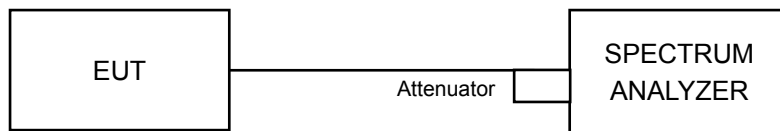

4.6.3 Test Instruments

Refer to section 4.1.2 to get information of above instrument.

4.6.4 Test Procedure

MEASUREMENT PROCEDURE REF

1. Set the RBW = 100 kHz.
2. Set the VBW \geq 300 kHz.
3. Detector = peak.
4. Sweep time = auto couple.
5. Trace mode = max hold.
6. Allow trace to fully stabilize.
7. Use the peak marker function to determine the maximum power level in any 100 kHz band segment within the fundamental EBW.

MEASUREMENT PROCEDURE OOB

1. Set RBW = 100 kHz.
2. Set VBW \geq 300 kHz.
3. Detector = peak.
4. Sweep = auto couple.
5. Trace Mode = max hold.
6. Allow trace to fully stabilize.
7. Use the peak marker function to determine the maximum amplitude level.

4.6.5 Deviation from Test Standard

No deviation.

4.6.6 EUT Operating Condition

Same as Item 4.3.6

4.6.7 Test Results

The spectrum plots are attached on the following pages. D1 line indicates the highest level, and D2 line indicates the 30dB offset below D1. It shows compliance with the requirement.

802.11b
CHAIN 0

CH 1

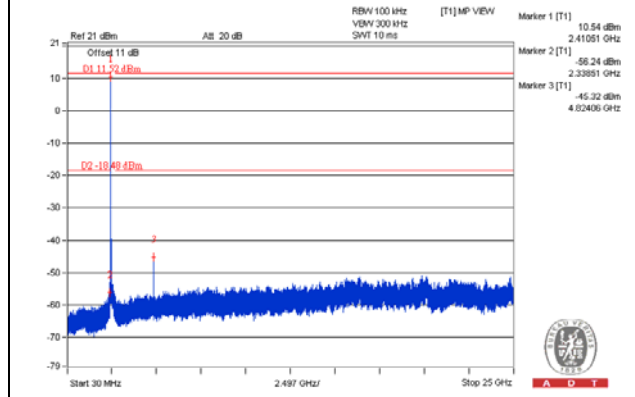
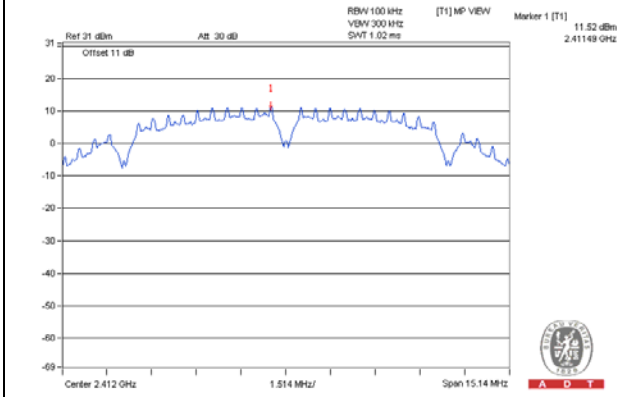

CH 6

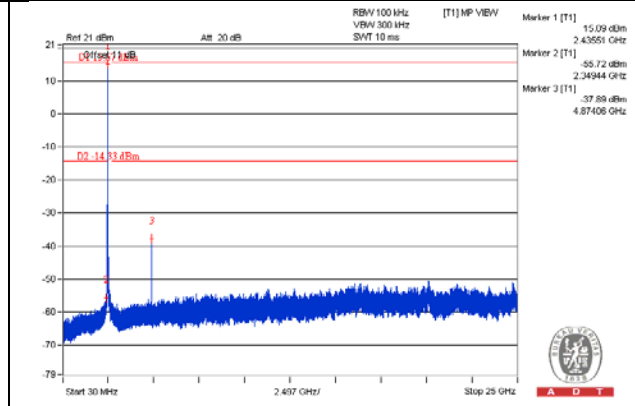
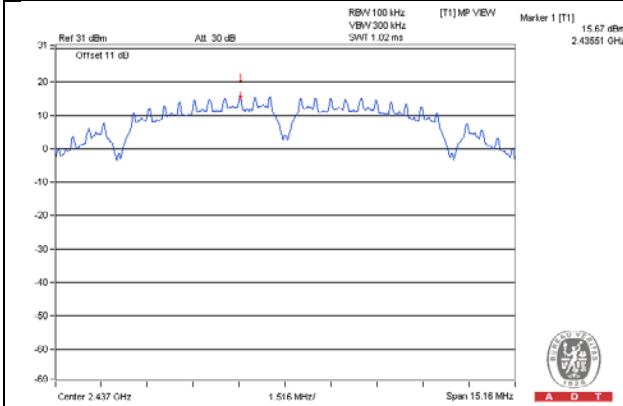

CH 11

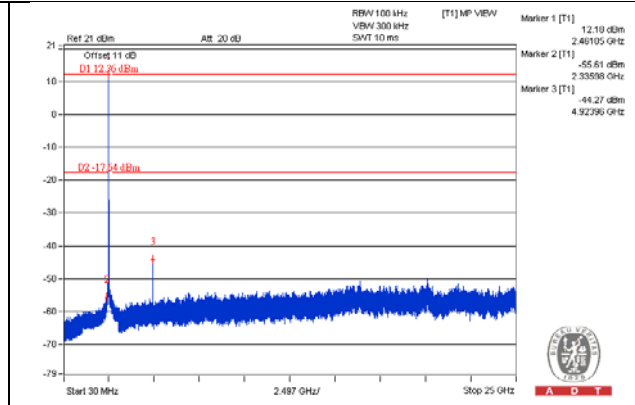
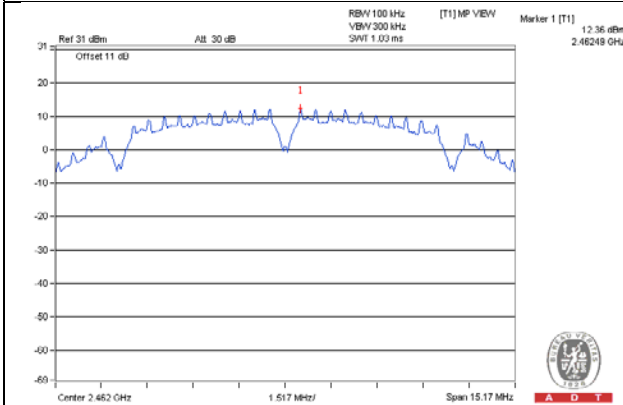

CH 1 Band edge

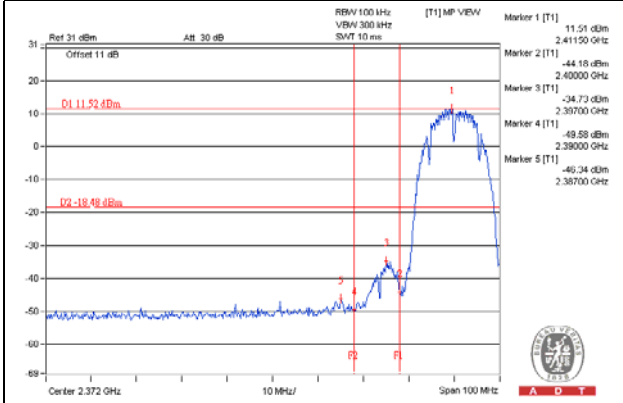

CH 11 Band edge

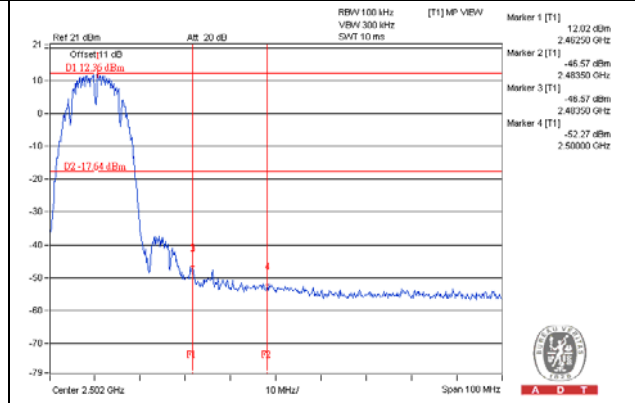

CHAIN 1

CH 1

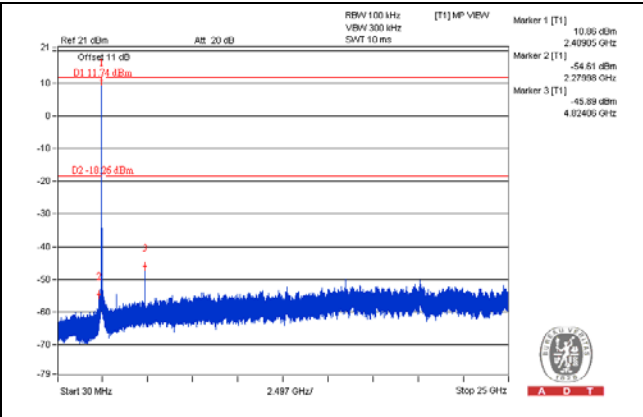
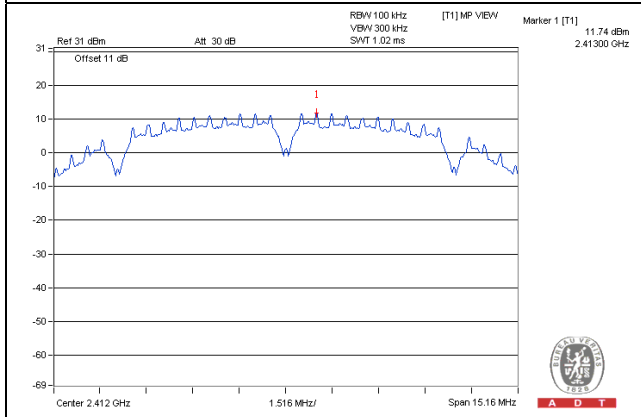

CH 6

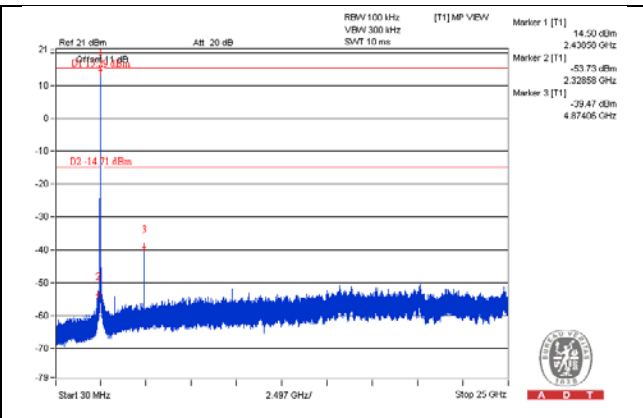
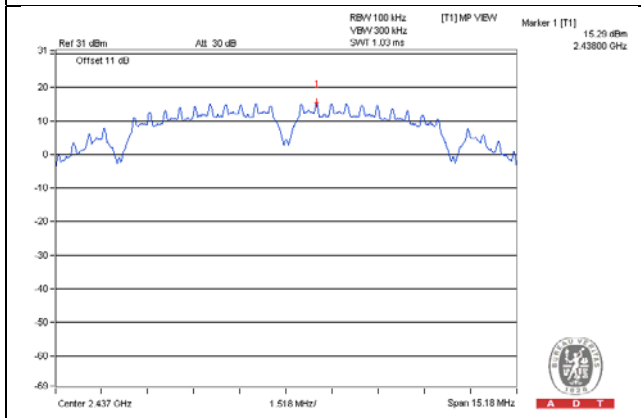

CH 11

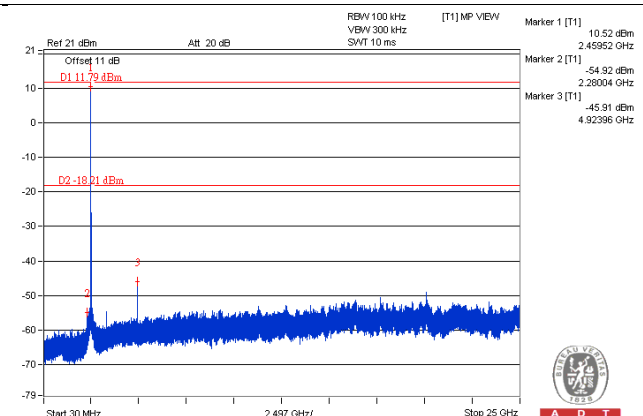
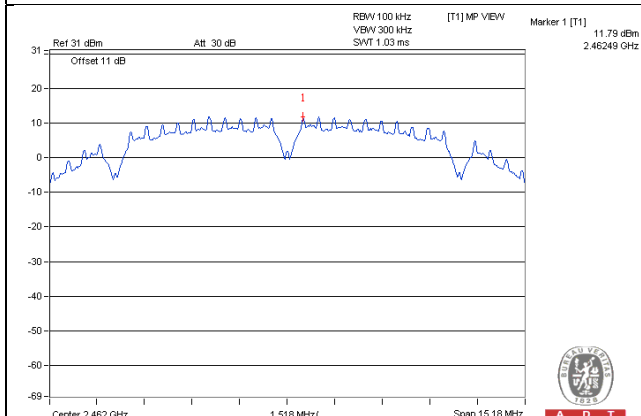

CH 1 Band edge

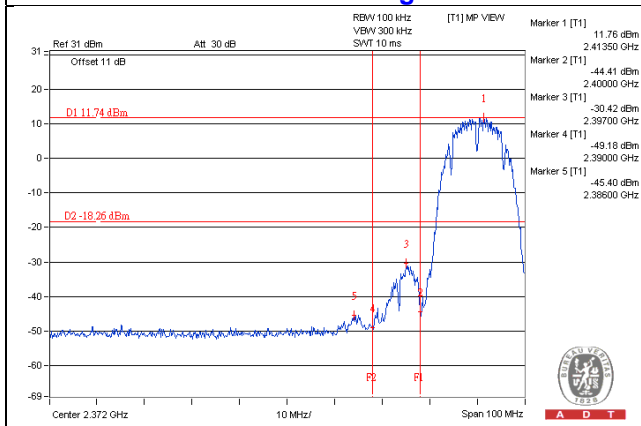

CH 11 Band edge

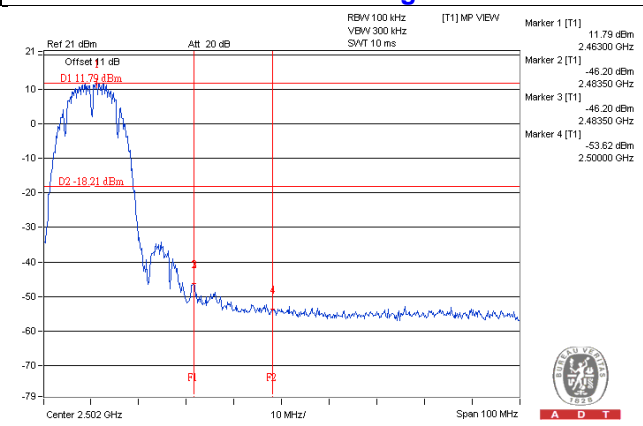

CHAIN 2

CH 1

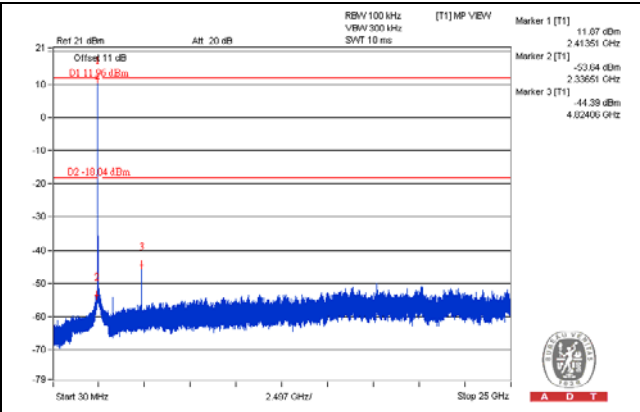
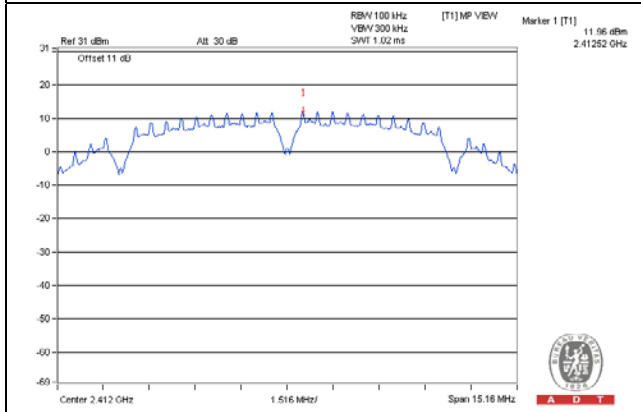

CH 6

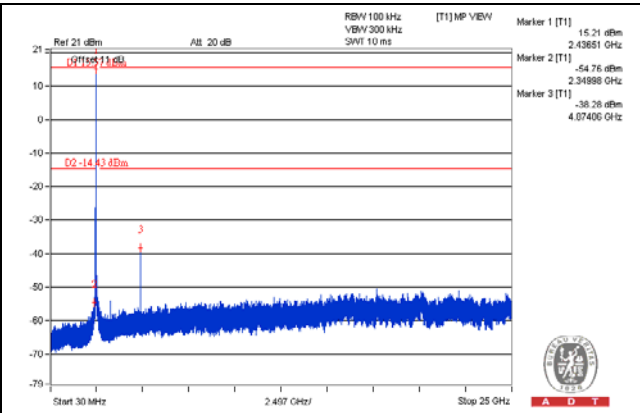
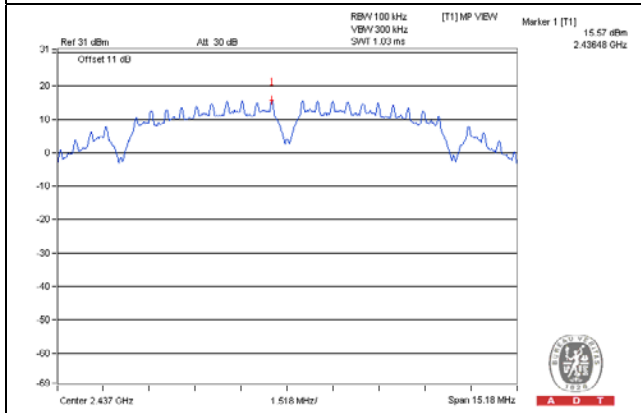

CH 11

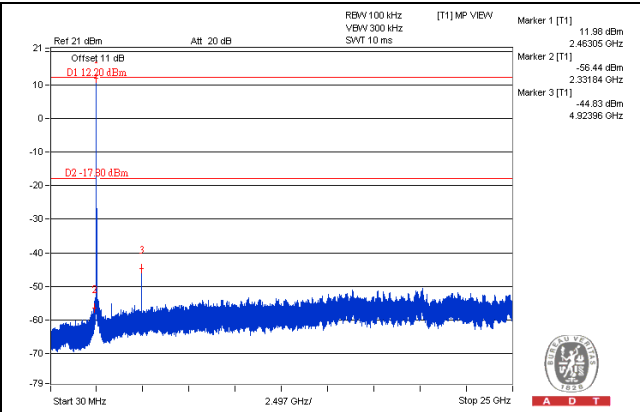
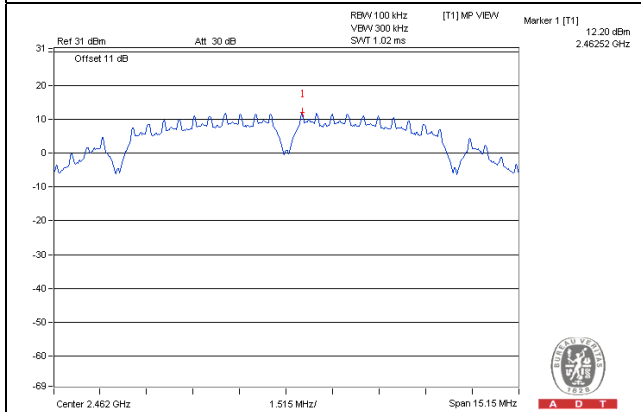

CH 1 Band edge

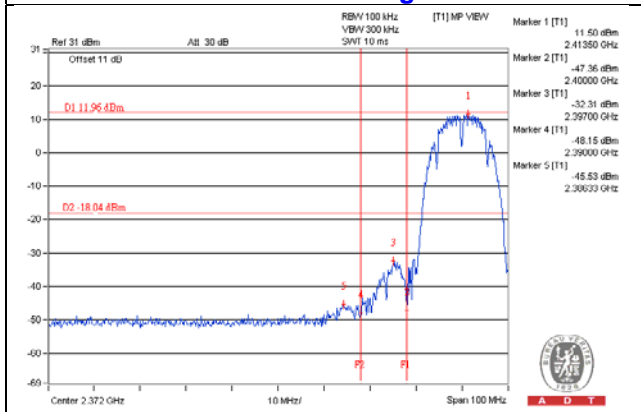

CH 11 Band edge

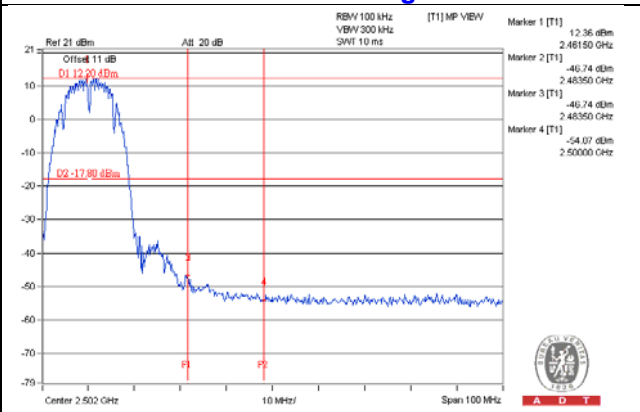

802.11g
CHAIN 0

CH 1

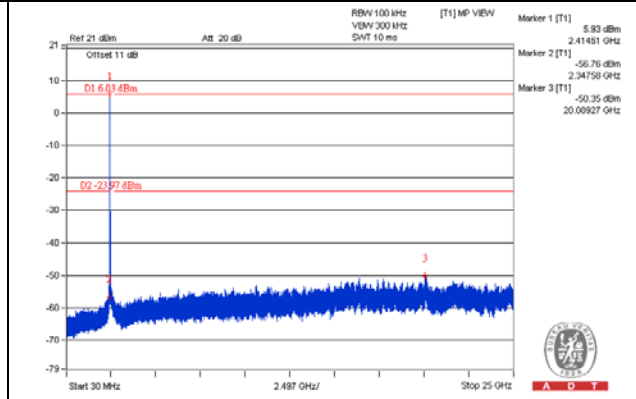
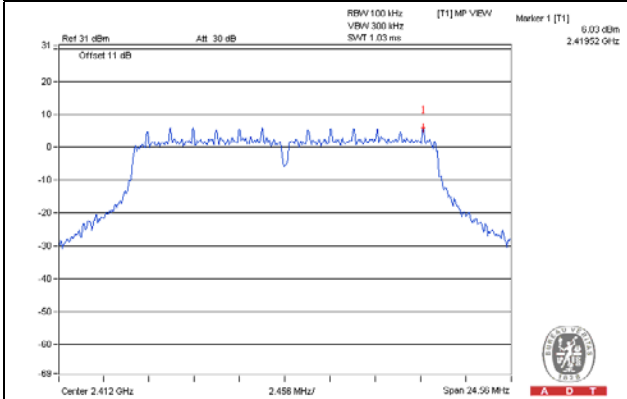

CH 6

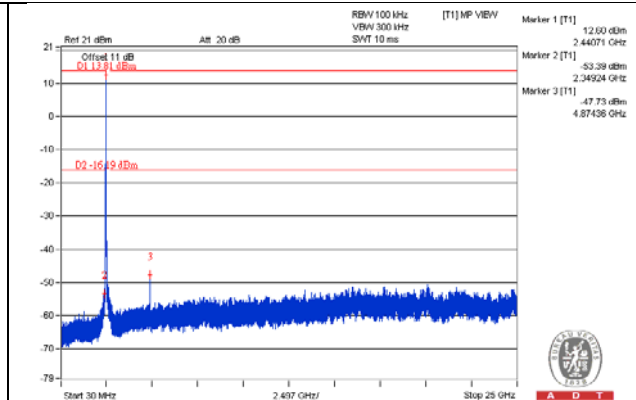
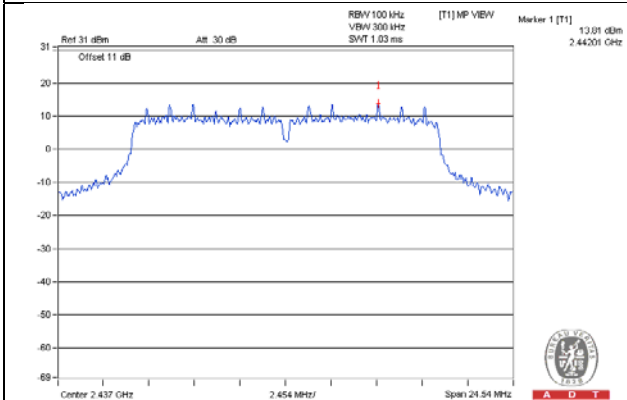

CH 11

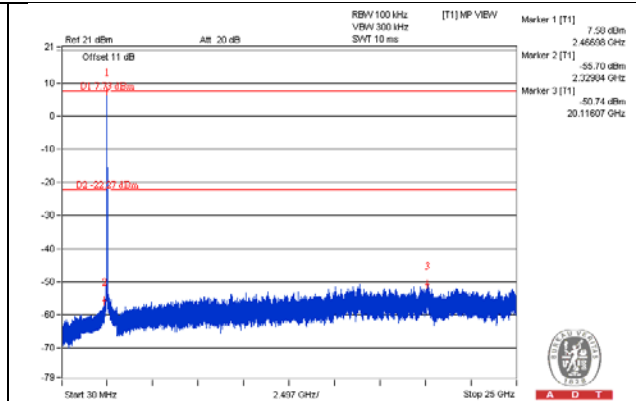
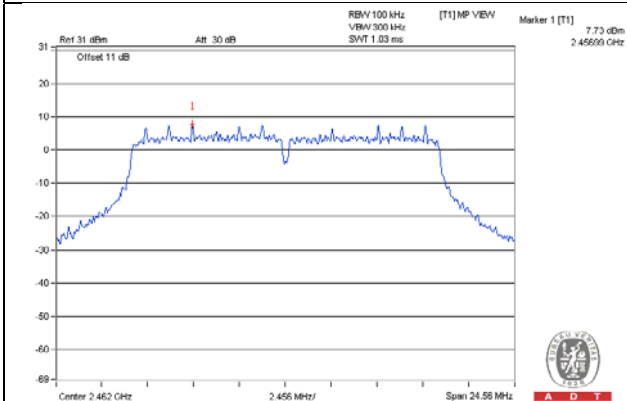

CH 1 Band edge

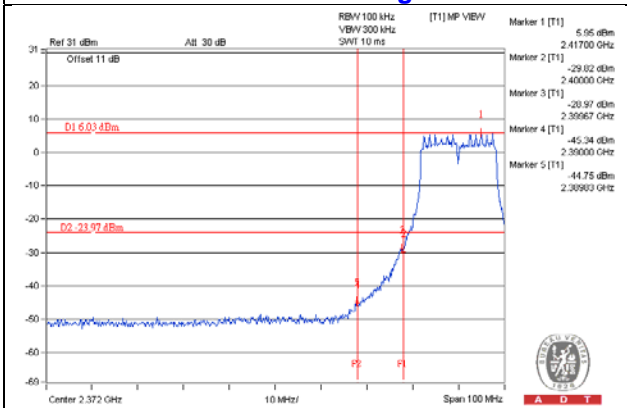

CH 11 Band edge

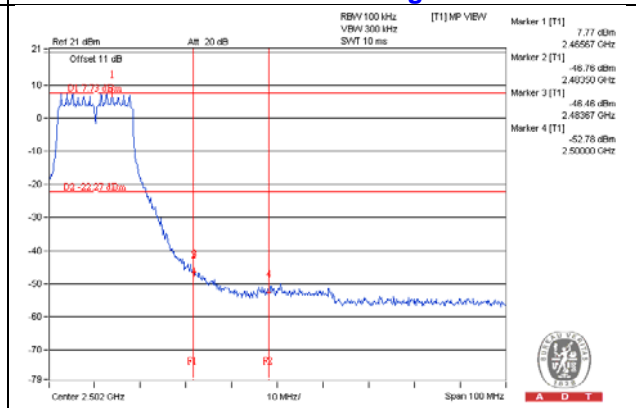

CHAIN 1

CH 1

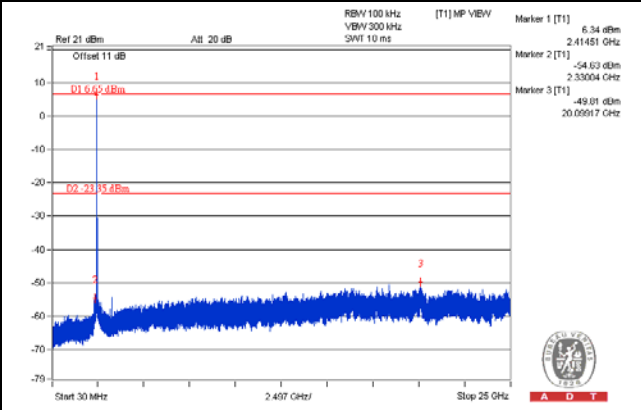
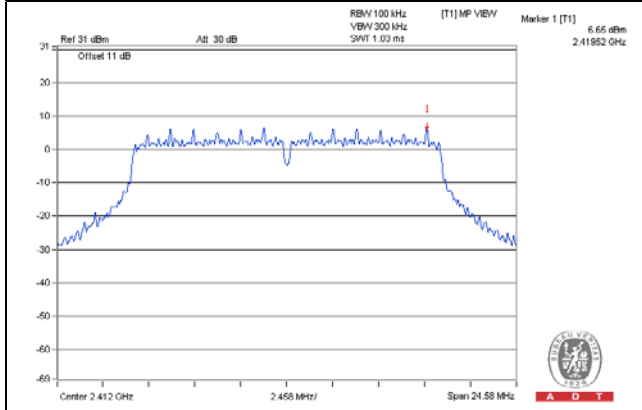

CH 6

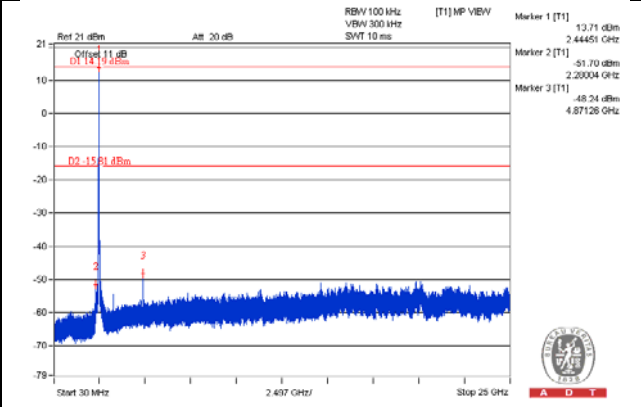
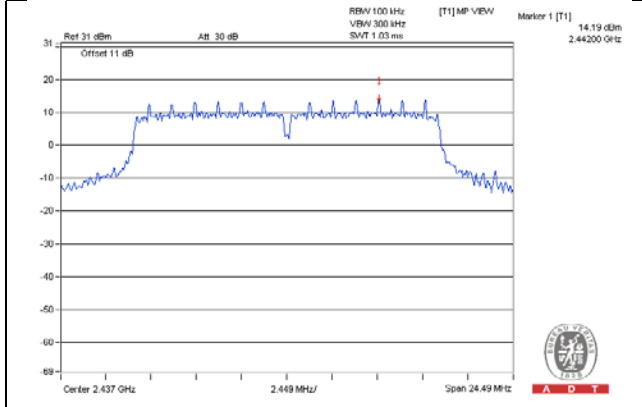

CH 11

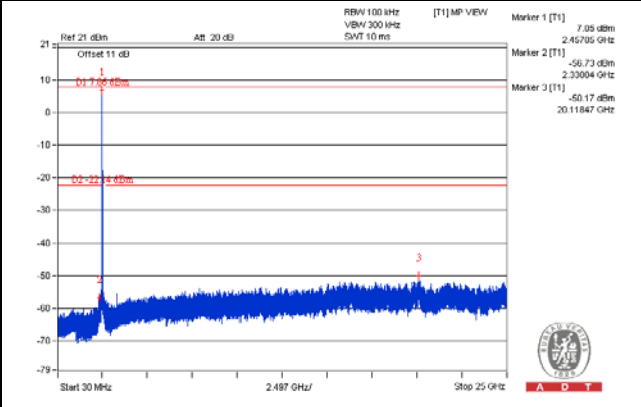
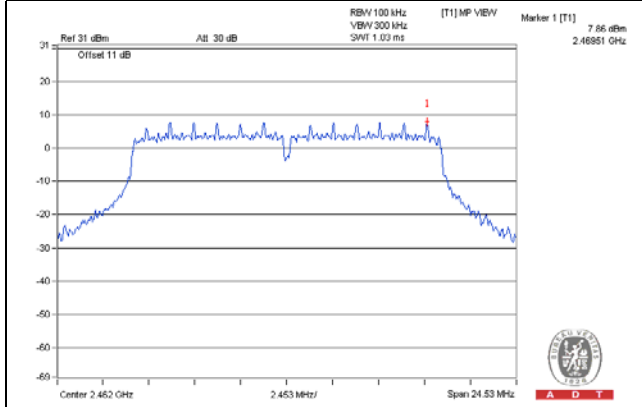

CH 1 Band edge

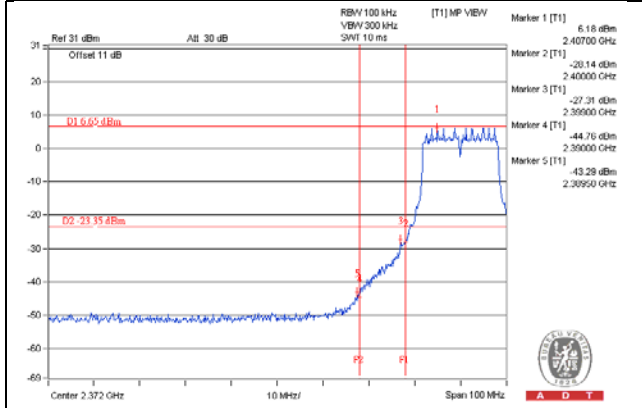

CH 11 Band edge

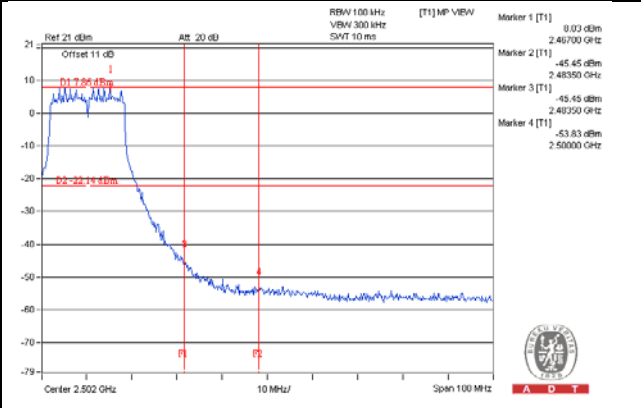

CHAIN 2

CH 1

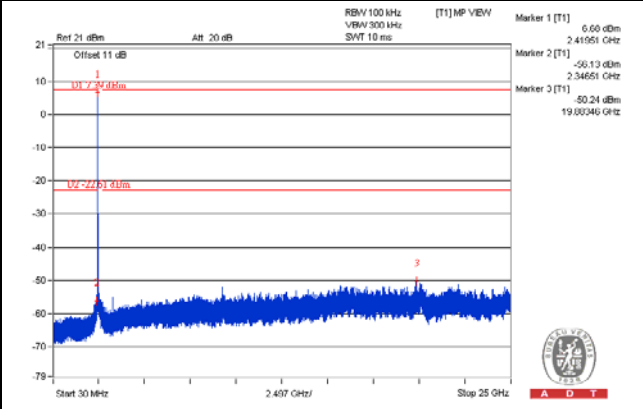
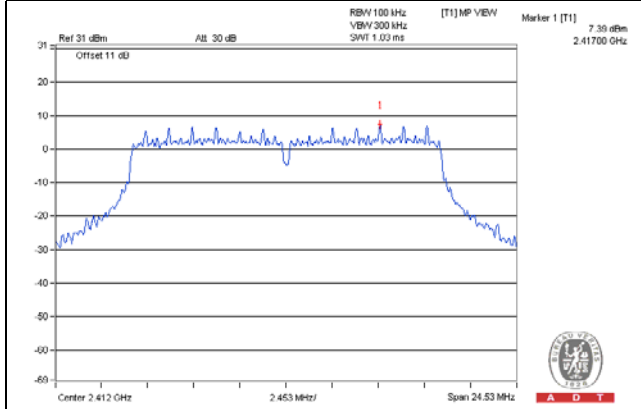

CH 6

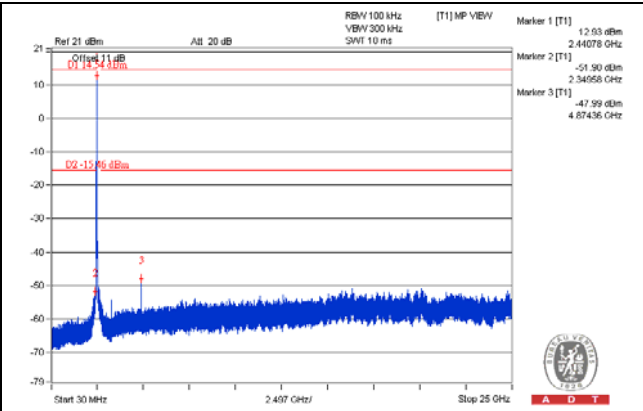
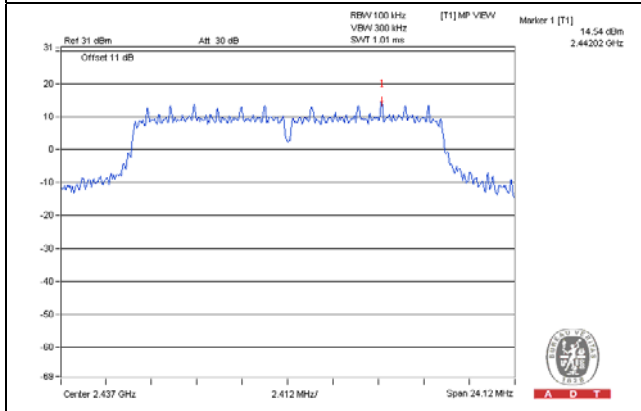

CH 11

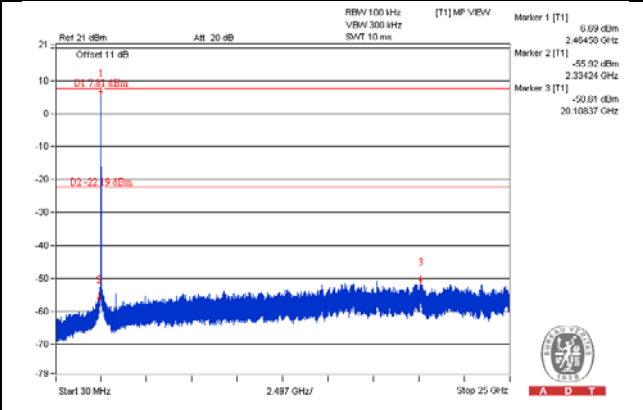
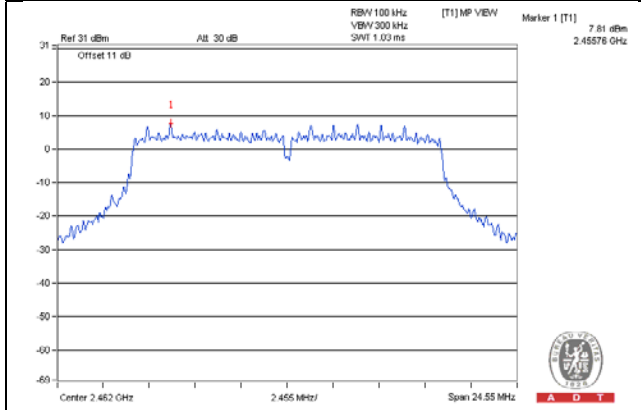

CH 1 Band edge

CH 11 Band edge

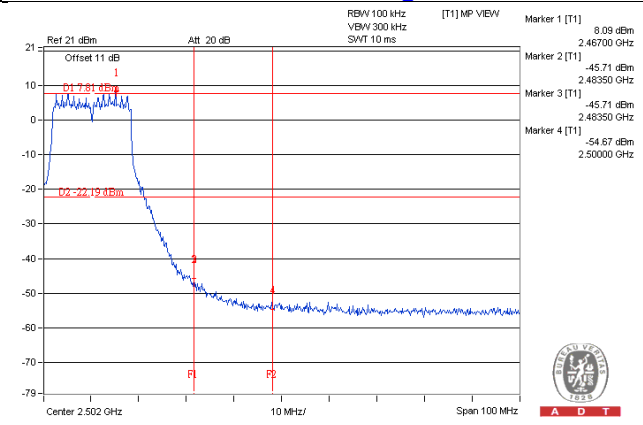
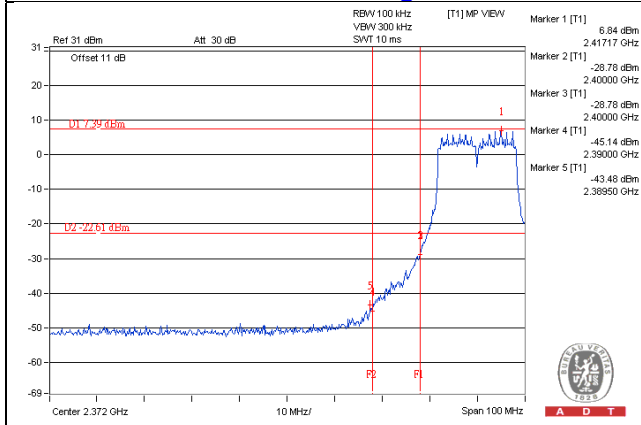

802.11n (HT20)
CHAIN 0

CH 1

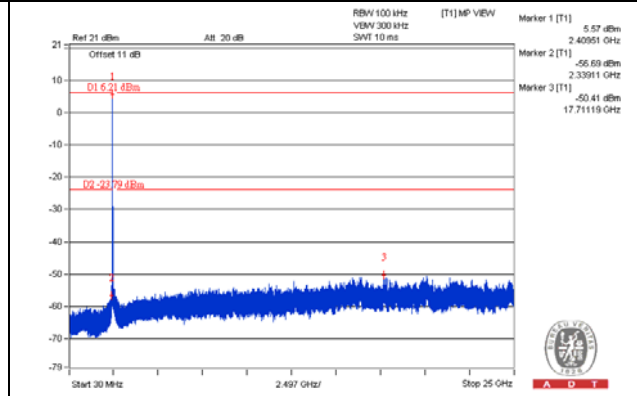
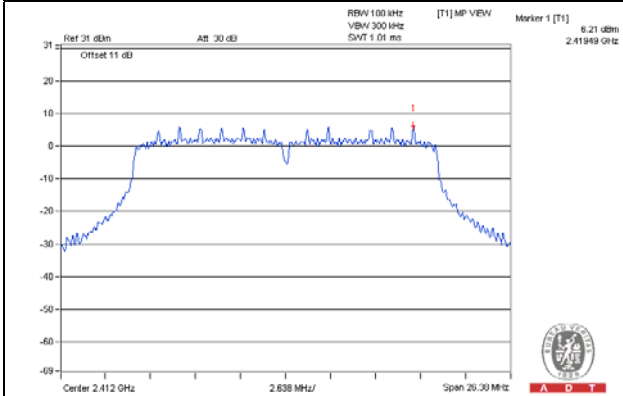

CH 6

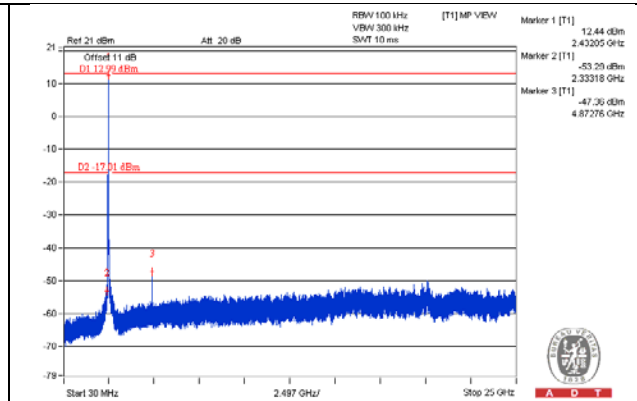
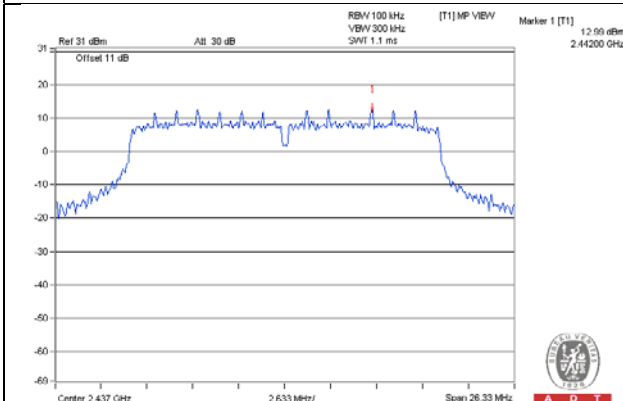

CH 11

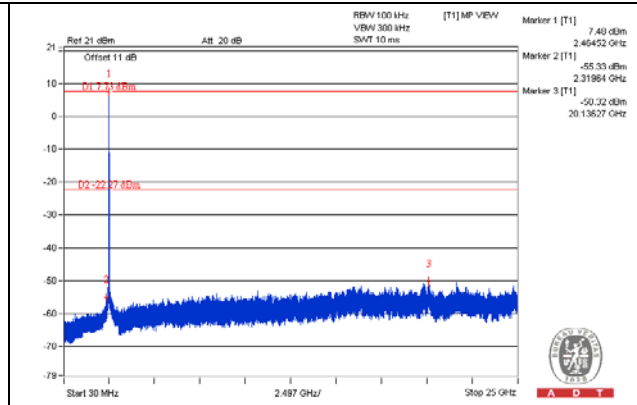
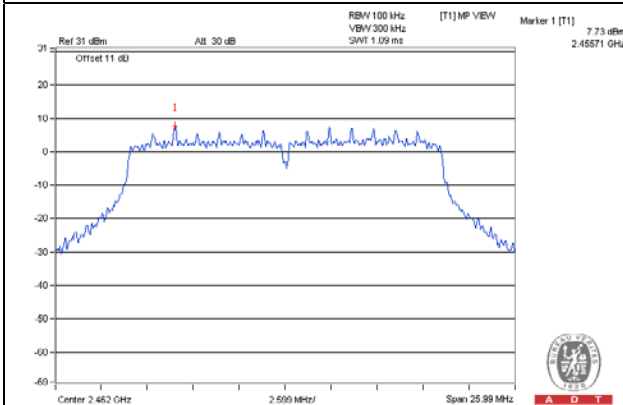

CH 1 Band edge

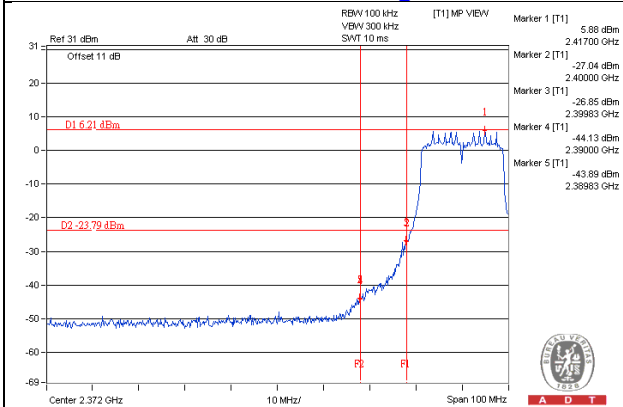

CH 11 Band edge

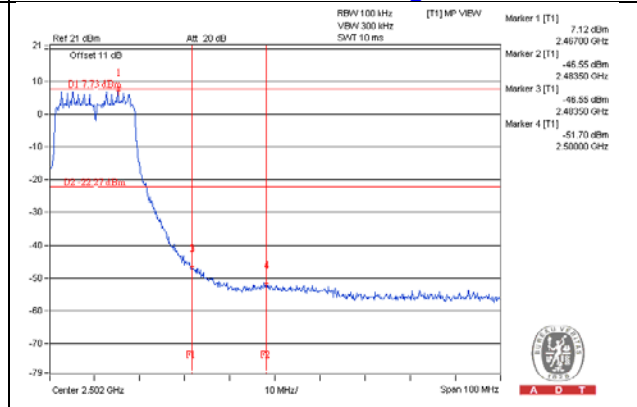

CHAIN 1

CH 1

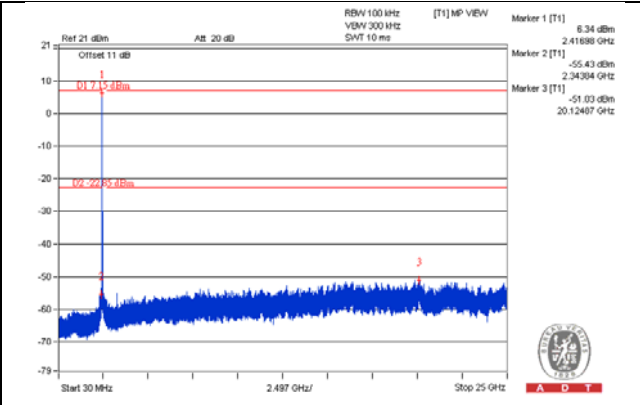
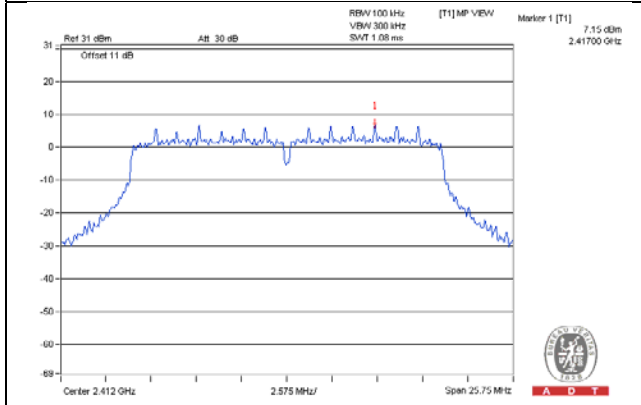

CH 6

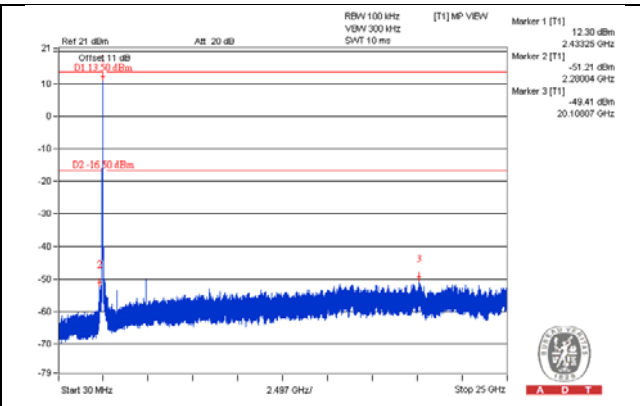
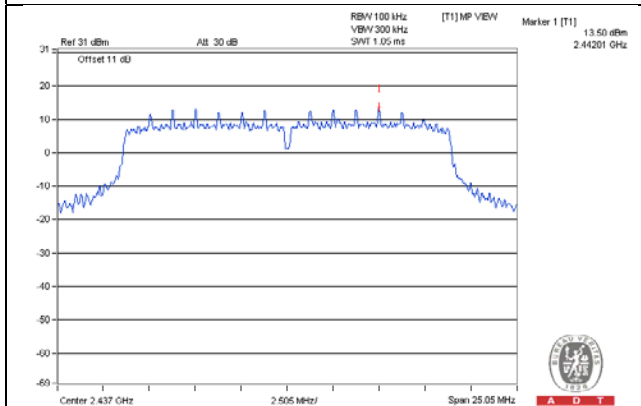

CH 11

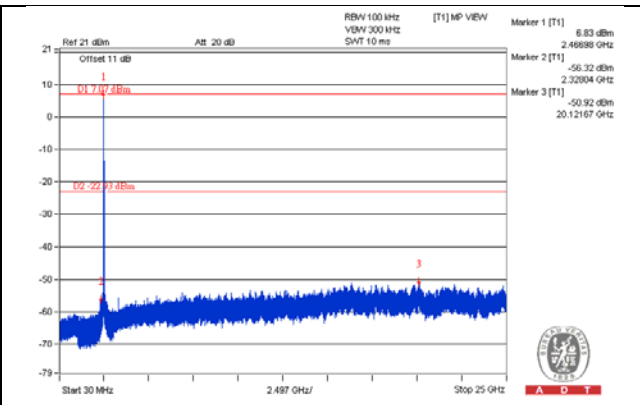
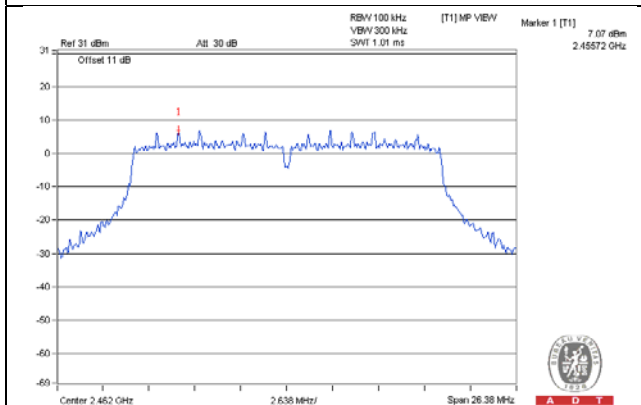

CH 1 Band edge

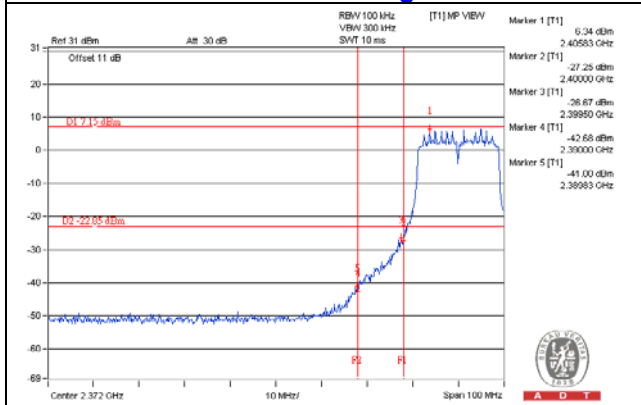

CH 11 Band edge

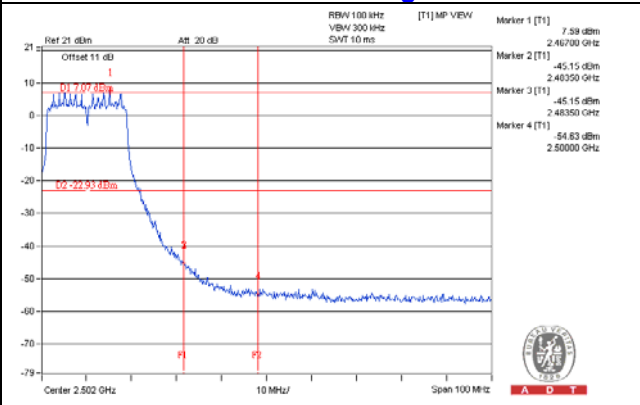

CHAIN 2

CH 1

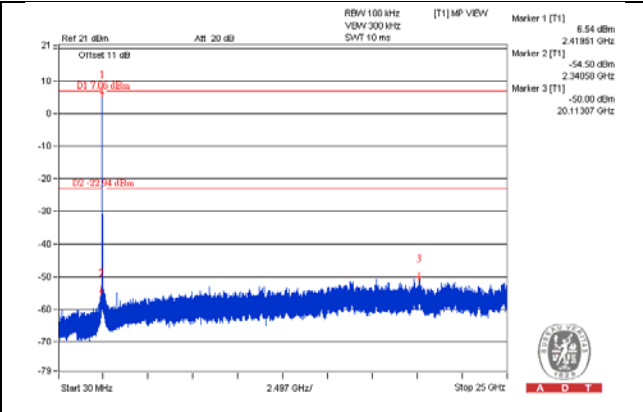
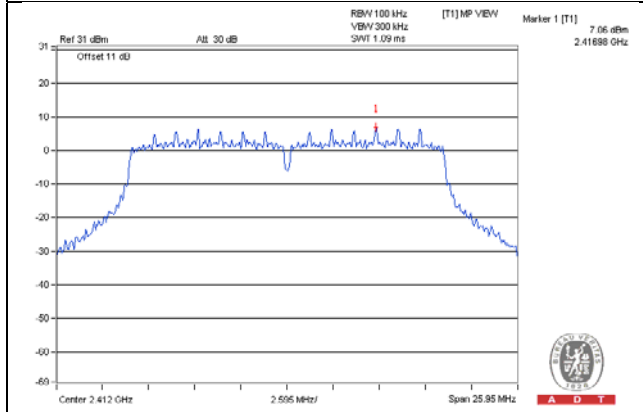

CH 6

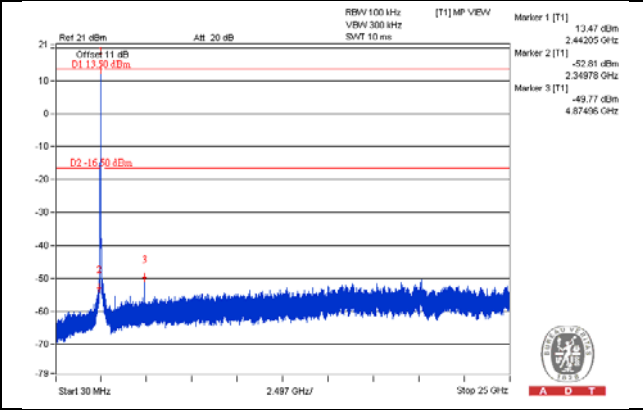
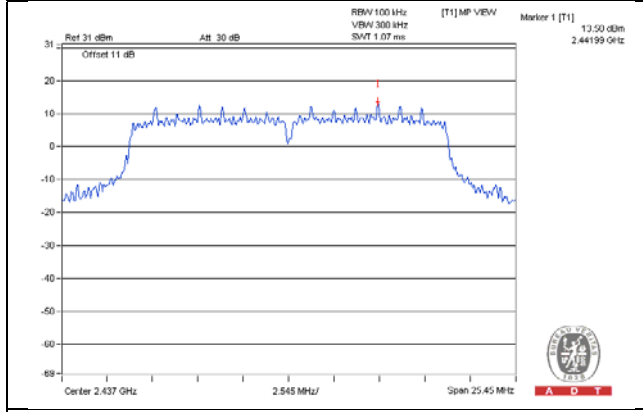

CH 11

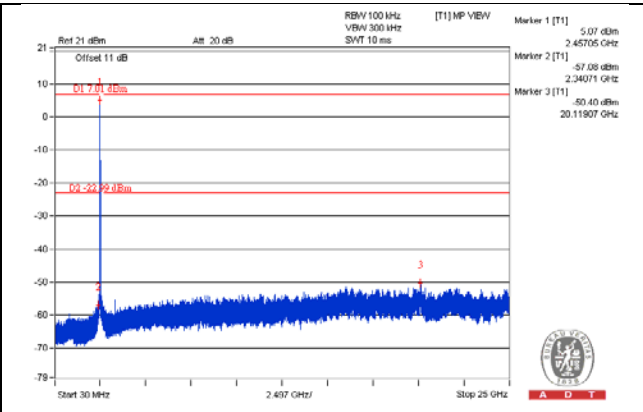
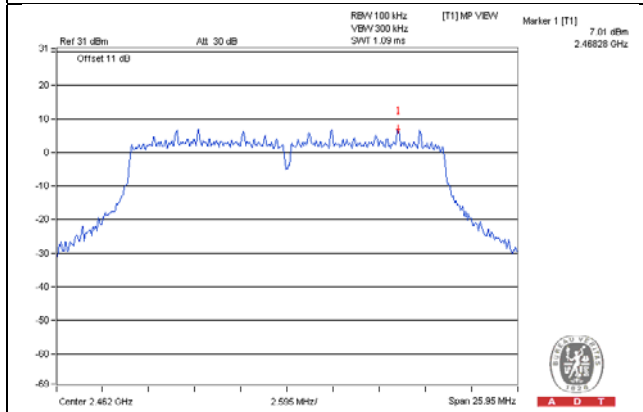

CH 1 Band edge

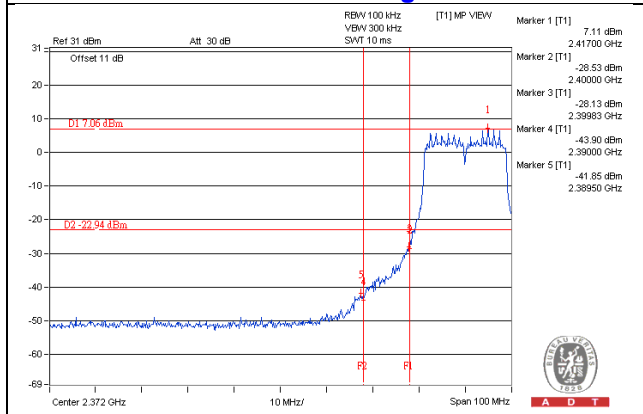

CH 11 Band edge

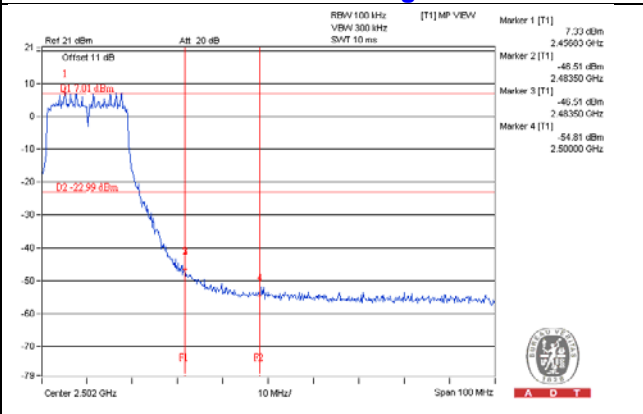

802.11n (HT40)
CHAIN 0

CH 3

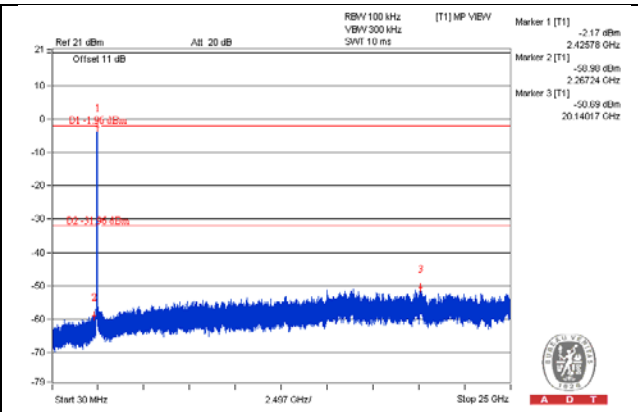
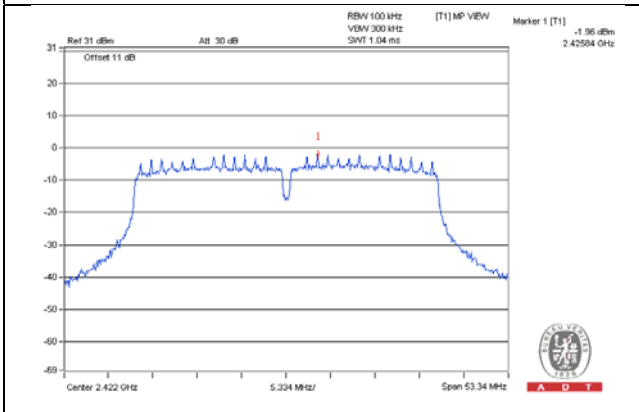

CH 6

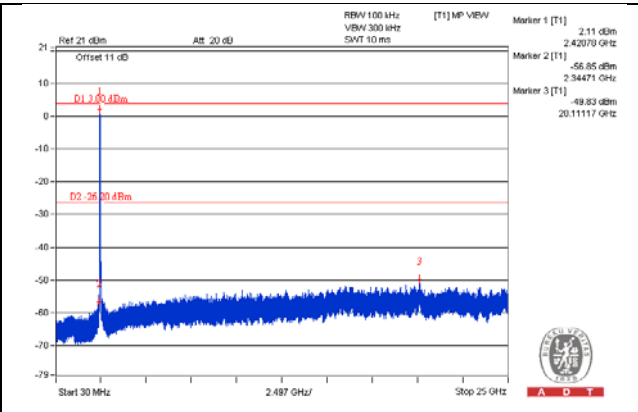
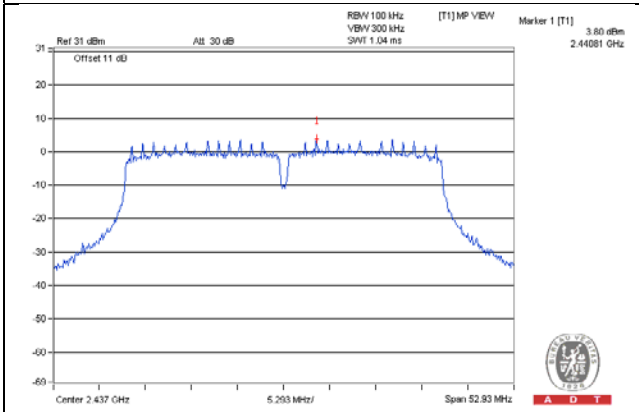

CH 9

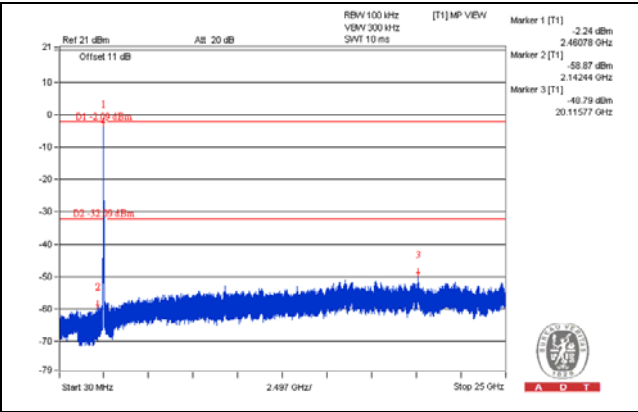
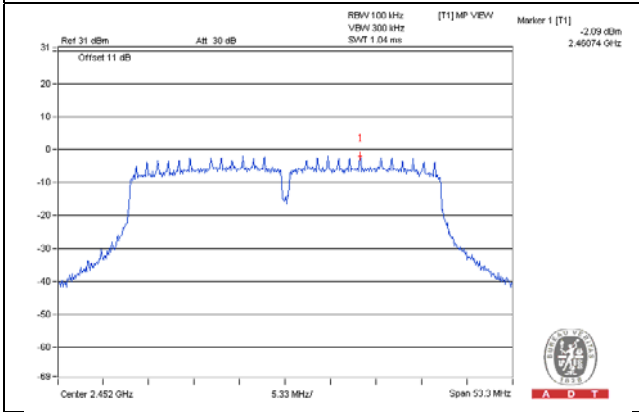

CH 3 Band edge

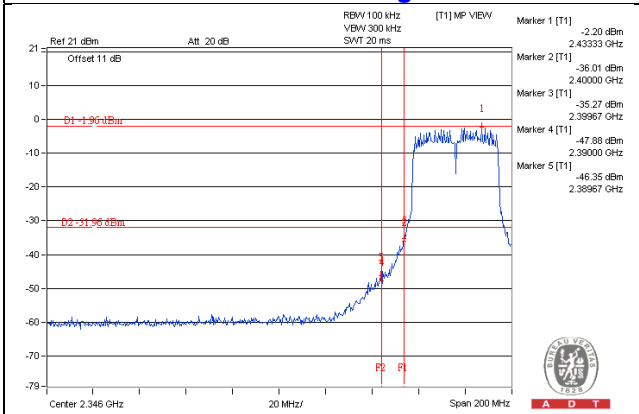

CH 9 Band edge

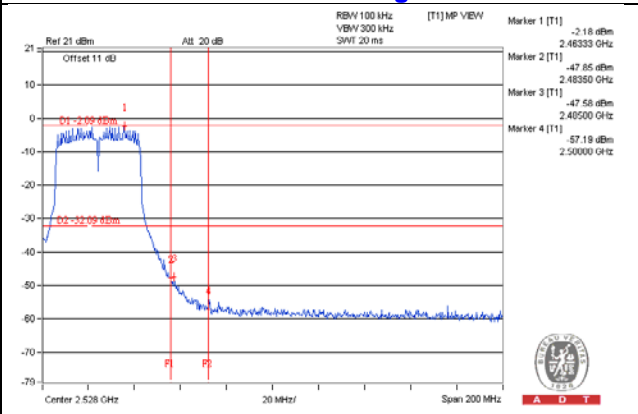

CHAIN 1

CH 3

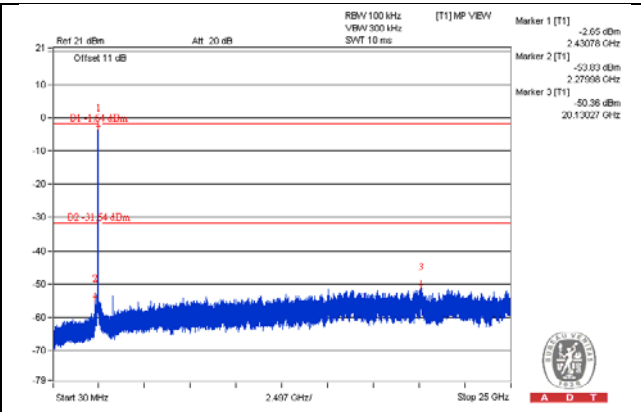
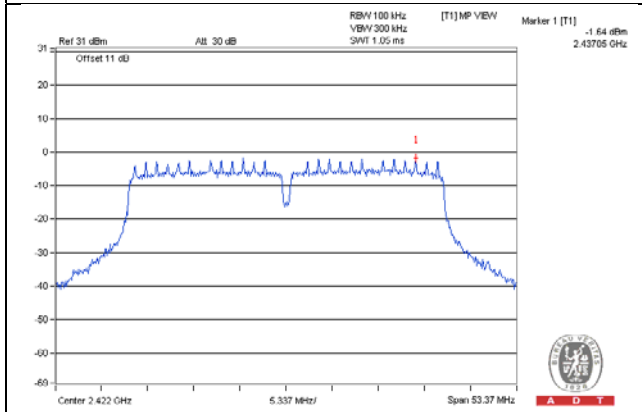

CH 6

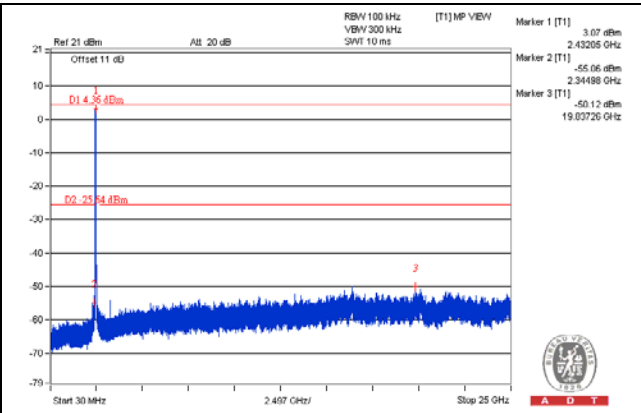
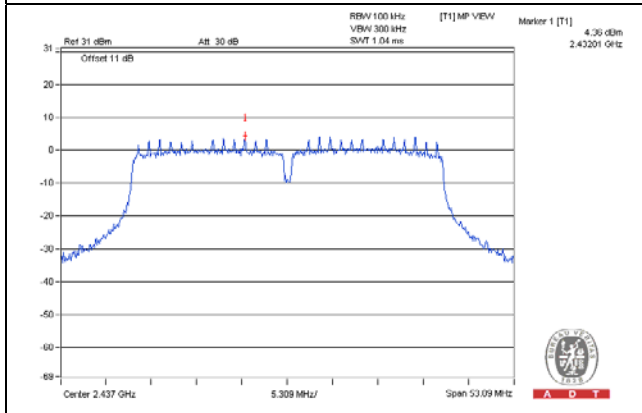

CH 9

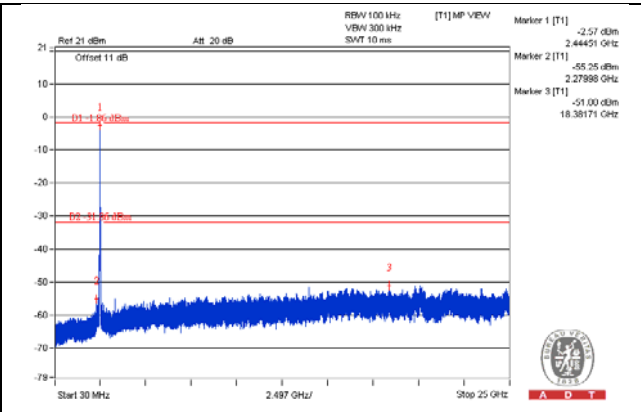
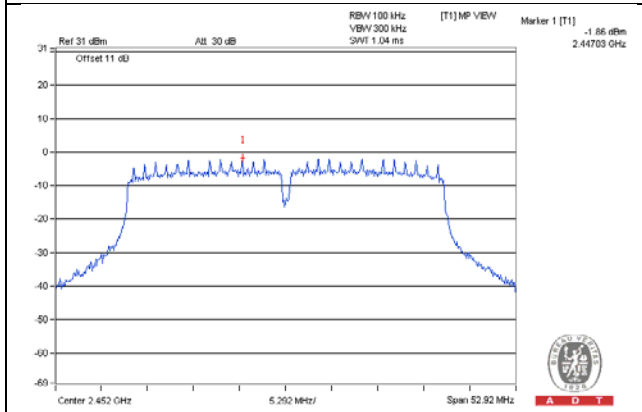

CH 3 Band edge

CH 9 Band edge

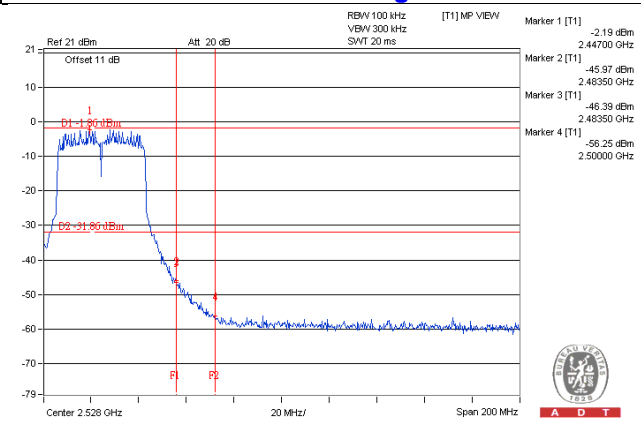
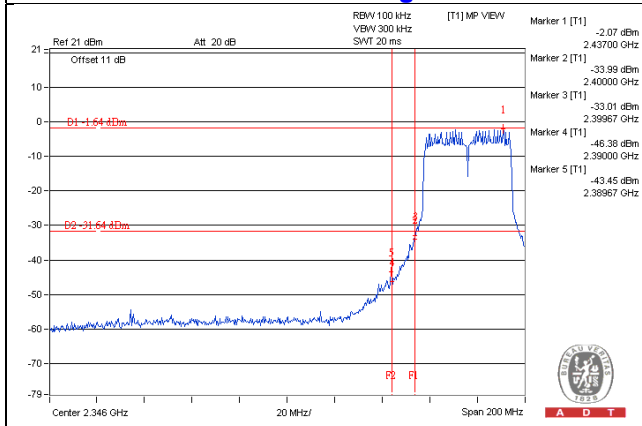

CHAIN 2

CH 3

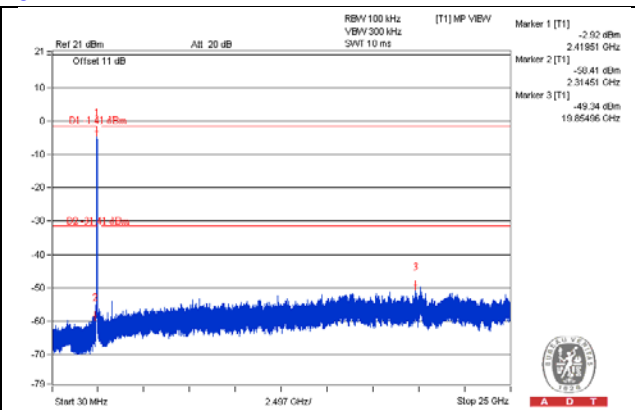
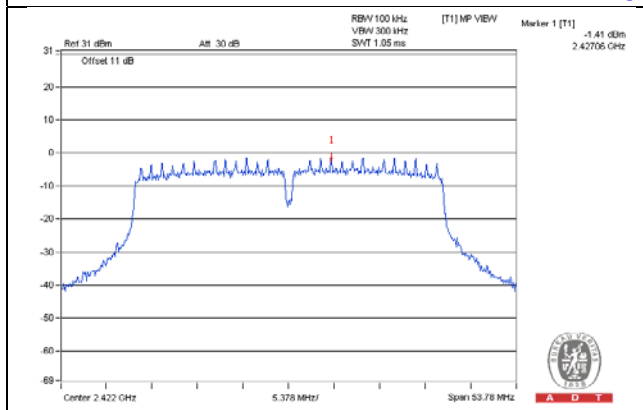

CH 6

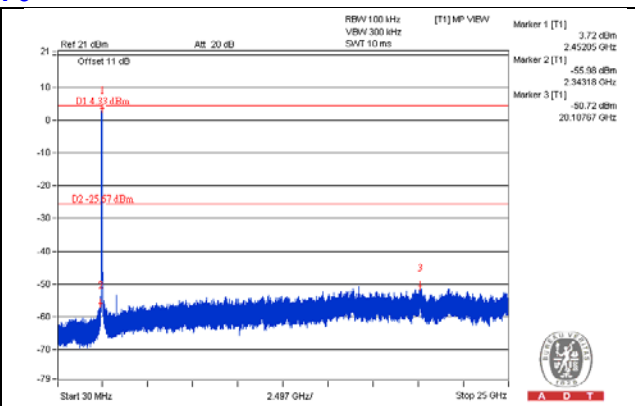
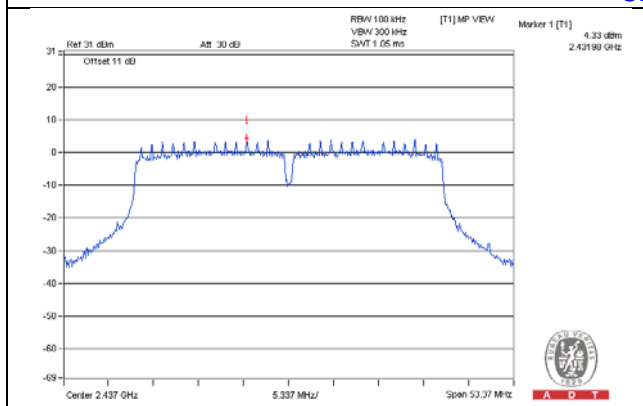

CH 9

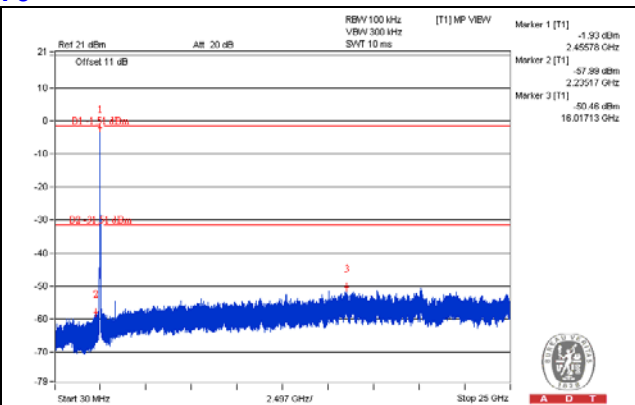
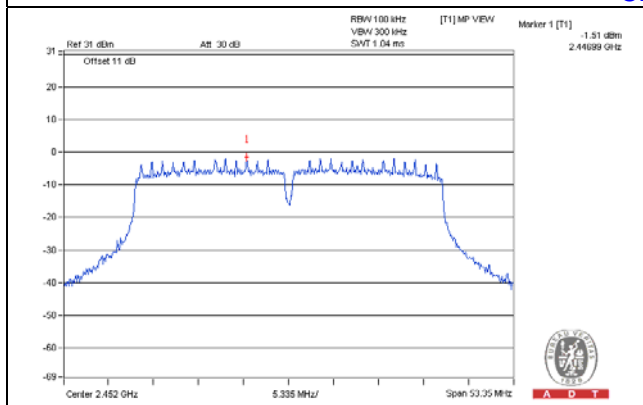

CH 3 Band edge

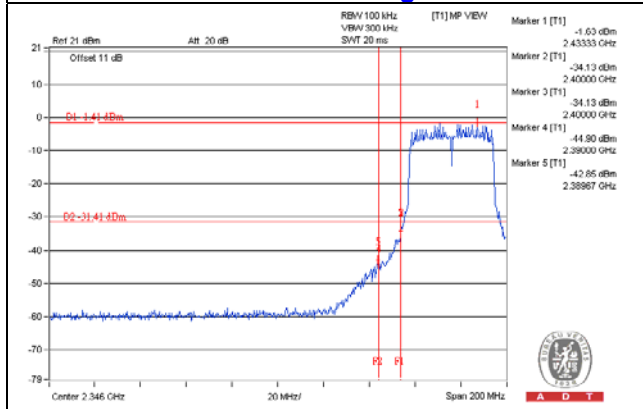

CH 9 Band edge

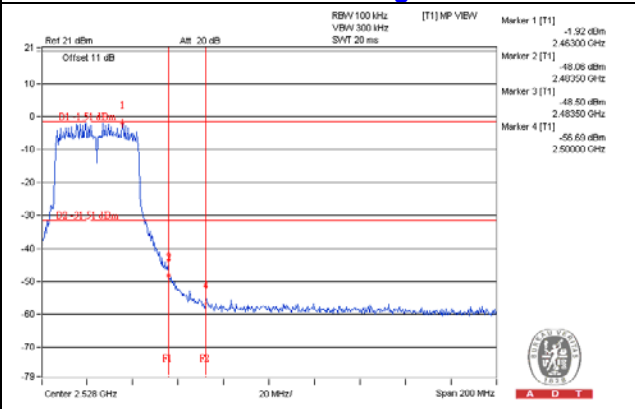

5 Pictures of Test Arrangements

Please refer to the attached file (Test Setup Photo).

Appendix – Information on the Testing Laboratories

We, Bureau Veritas Consumer Products Services (H.K.) Ltd., Taoyuan Branch, were founded in 1988 to provide our best service in EMC, Radio, Telecom and Safety consultation. Our laboratories are accredited and approved according to ISO/IEC 17025.

If you have any comments, please feel free to contact us at the following:

Linko EMC/RF Lab

Tel: 886-2-26052180

Fax: 886-2-26051924

Hsin Chu EMC/RF/Telecom Lab

Tel: 886-3-5935343

Fax: 886-3-5935342

Hwa Ya EMC/RF/Safety Lab

Tel: 886-3-3183232

Fax: 886-3-3270892

Email: service.adt@tw.bureauveritas.com

Web Site: www.bureauveritas-adt.com

The address and road map of all our labs can be found in our web site also.

--- END ---