

FCC Test Report

Report No.: RF161004C24-1

FCC ID: TVE-140701

Test Model: FAP-221E, FAP-223E (refer to item 3.1 for more details)

Series Model: FortiAP 221Exxxxx, FAP-221Exxxxx, FORTIAP-221Exxxxx, FortiAP 223Exxxxx, FAP-223Exxxxx, FORTIAP-223Exxxxx (where "x" can be used as "A-Z", or "0-9", or "-", or blank for marketing purposes only) (refer to item 3.1 for more details)

Received Date: Oct. 04, 2016

Test Date: Oct. 08, 2016 ~ Jan. 19, 2017

Issued Date: Feb. 07, 2017

Applicant: Fortinet Inc.

Address: 899 Kifer Road Sunnyvale, CA 94086 USA

Issued By: Bureau Veritas Consumer Products Services (H.K.) Ltd., Taoyuan Branch

Lab Address: No. 47-2, 14th Ling, Chia Pau Vil., Lin Kou Dist., New Taipei City, Taiwan (R.O.C.)

Test Location: No.19, Hwa Ya 2nd Rd., Wen Hwa Vil., Kwei Shan Dist., Taoyuan City 33383, TAIWAN (R.O.C.)



This report is for your exclusive use. Any copying or replication of this report to or for any other person or entity, or use of our name or trademark, is permitted only with our prior written permission. This report sets forth our findings solely with respect to the test samples identified herein. The results set forth in this report are not indicative or representative of the quality or characteristics of the lot from which a test sample was taken or any similar or identical product specifically and expressly noted. Our report includes all of the tests requested by you and the results thereof based upon the information that you provided to us. You have 60 days from date of issuance of this report to notify us of any material error or omission caused by our negligence, provided, however, that such notice shall be in writing and shall specifically address the issue you wish to raise. A failure to raise such issue within the prescribed time shall constitute your unqualified acceptance of the completeness of this report, the tests conducted and the correctness of the report contents. Unless specific mention, the uncertainty of measurement has been explicitly taken into account to declare the compliance or non-compliance to the specification. The report must not be used by the client to claim product certification, approval, or endorsement by TAF or any government agencies.

Table of Contents

Release Control Record	4
1 Certificate of Conformity	5
2 Summary of Test Results	6
2.1 Measurement Uncertainty.....	6
2.2 Modification Record.....	6
3 General Information	7
3.1 General Description of EUT.....	7
3.2 Description of Test Modes.....	9
3.2.1 Test Mode Applicability and Tested Channel Detail.....	10
3.3 Duty Cycle of Test Signal.....	13
3.4 Description of Support Units.....	14
3.4.1 Configuration of System under Test.....	15
3.5 General Description of Applied Standards.....	16
4 Test Types and Results	17
4.1 Radiated Emission and Bandedge Measurement.....	17
4.1.1 Limits of Radiated Emission and Bandedge Measurement.....	17
4.1.2 Test Instruments.....	18
4.1.3 Test Procedures.....	19
4.1.4 Deviation from Test Standard.....	19
4.1.5 Test Set Up.....	20
4.1.6 EUT Operating Conditions.....	21
4.1.7 Test Results.....	22
4.2 Conducted Emission Measurement.....	62
4.2.1 Limits of Conducted Emission Measurement.....	62
4.2.2 Test Instruments.....	62
4.2.3 Test Procedures.....	63
4.2.4 Deviation from Test Standard.....	63
4.2.5 Test Setup.....	63
4.2.6 EUT Operating Conditions.....	63
4.2.7 Test Results.....	64
4.3 Transmit Power Measurement.....	72
4.3.1 Limits of Transmit Power Measurement.....	72
4.3.2 Test Setup.....	72
4.3.3 Test Instruments.....	72
4.3.4 Test Procedure.....	73
4.3.5 Deviation from Test Standard.....	73
4.3.6 EUT Operating Conditions.....	73
4.3.7 Test Result.....	74
4.4 Occupied Bandwidth Measurement.....	76
4.4.1 Test Setup.....	76
4.4.2 Test Instruments.....	76
4.4.3 Test Procedure.....	76
4.4.4 Test Result.....	77
4.5 Peak Power Spectral Density Measurement.....	79
4.5.1 Limits of Peak Power Spectral Density Measurement.....	79
4.5.2 Test Setup.....	79
4.5.3 Test Instruments.....	79
4.5.4 Test Procedures.....	79
4.5.5 Deviation from Test Standard.....	80
4.5.6 EUT Operating Conditions.....	80
4.5.7 Test Results.....	81
4.6 Frequency Stability.....	86
4.6.1 Limits of Frequency Stability Measurement.....	86

4.6.2	Test Setup.....	86
4.6.3	Test Procedure	86
4.6.4	Deviation from Test Standard	86
4.6.5	EUT Operating Condition	86
4.6.6	Test Results	87
4.7	6dB Bandwidth Measurement.....	88
4.7.1	Limits of 6dB Bandwidth Measurement.....	88
4.7.2	Test Setup.....	88
4.7.3	Test Instruments	88
4.7.4	Test Procedure	88
4.7.5	Deviation from Test Standard	88
4.7.6	EUT Operating Condition	88
4.7.7	Test Results	89
5	Pictures of Test Arrangements.....	91
	Annex A- Radiated Out of Band Emission (OOBE) Measurement (For U-NII-3 band).....	92
	Appendix – Information on the Testing Laboratories	98

Release Control Record

Issue No.	Description	Date Issued
RF161004C24-1	Original release	Feb. 07, 2017

1 Certificate of Conformity

Product: Secured Wireless Access Point

Brand: Fortinet Inc.

Test Model: FAP-221E, FAP-223E (refer to item 3.1 for more details)

Series Model: FortiAP 221Exxxxx, FAP-221Exxxxx, FORTIAP-221Exxxxx, FortiAP 223Exxxxx, FAP-223Exxxxx, FORTIAP-223Exxxxx (where "x" can be used as "A-Z", or "0-9", or "-", or blank for marketing purposes only) (refer to item 3.1 for more details)

Sample Status: Engineering sample

Applicant: Fortinet Inc.

Test Date: Oct. 08, 2016 ~ Jan. 19, 2017

Standards: 47 CFR FCC Part 15, Subpart E (Section 15.407)
ANSI C63.10:2013

The above equipment has been tested by **Bureau Veritas Consumer Products Services (H.K.) Ltd., Taoyuan Branch**, and found compliance with the requirement of the above standards. The test record, data evaluation & Equipment Under Test (EUT) configurations represented herein are true and accurate accounts of the measurements of the sample's EMC characteristics under the conditions specified in this report.

Prepared by : Celine Chou , **Date:** Feb. 07, 2017
Celine Chou / Specialist

Approved by : Ken Liu , **Date:** Feb. 07, 2017
Ken Liu / Senior Manager

2 Summary of Test Results

47 CFR FCC Part 15, Subpart E (Section 15.407)			
FCC Clause	Test Item	Result	Remarks
15.407(b)(6)	AC Power Conducted Emissions	Pass	Meet the requirement of limit. Minimum passing margin is -3.00dB at 0.52500MHz.
15.407(b)(1/2/3/4(i/ii)/6)	Radiated Emissions & Band Edge Measurement	Pass	Meet the requirement of limit. Minimum passing margin is -1.3dB at 5649.00MHz.
15.407(a)(1/2/3)	Max Average Transmit Power	Pass	Meet the requirement of limit.
---	Occupied Bandwidth Measurement	-	Reference only.
15.407(a)(1/2/3)	Peak Power Spectral Density	Pass	Meet the requirement of limit.
15.407(e)	6dB bandwidth	Pass	Meet the requirement of limit. (U-NII-3 Band only)
15.407(g)	Frequency Stability	Pass	Meet the requirement of limit.
15.203	Antenna Requirement	Pass	For printed antenna Antenna connector is IPEX not a standard connector. For dipole antenna Antenna connector is RP SMA plug not a standard connector.

*For U-NII-3 band compliance with rule part 15.407(b)(4)(i), the OOB test plots were recorded in Annex A.

2.1 Measurement Uncertainty

Where relevant, the following measurement uncertainty levels have been estimated for tests performed on the EUT as specified in CISPR 16-4-2:

Measurement	Frequency	Expanded Uncertainty (k=2) (\pm)
Conducted Emissions at mains ports	150kHz ~ 30MHz	2.44 dB
Radiated Emissions up to 1 GHz	30MHz ~ 200MHz	3.86 dB
	200MHz ~ 1000MHz	3.87 dB
Radiated Emissions above 1 GHz	1GHz ~ 18GHz	2.29 dB
	18GHz ~ 40GHz	2.29 dB

2.2 Modification Record

There were no modifications required for compliance.

3 General Information

3.1 General Description of EUT

Product	Secured Wireless Access Point
Brand	Fortinet Inc.
Test Model	FAP-221E, FAP-223E
Series Model	FortiAP 221Exxxxx, FAP-221Exxxxx, FORTIAP-221Exxxxx, FortiAP 223Exxxxx, FAP-223Exxxxx, FORTIAP-223Exxxxx (where “x” can be used as “A-Z”, or “0-9”, or “-“, or blank for marketing purposes only)
Model Difference	Refer to note for more details
Sample Status	Engineering sample
Power Supply Rating	12Vdc from adapter 54Vdc from POE
Modulation Type	256QAM, 64QAM, 16QAM, QPSK, BPSK for OFDM
Modulation Technology	OFDM
Transfer Rate	802.11a: 54.0/ 48.0/ 36.0/ 24.0/ 18.0/ 12.0/ 9.0/ 6.0Mbps 802.11n: up to 300Mbps 802.11ac: up to 867Mbps
Operating Frequency	5180 ~ 5240MHz, 5745 ~ 5825MHz
Number of Channel	5180 ~ 5240MHz: 4 for 802.11a, 802.11n (HT20), 802.11ac (VHT20) 2 for 802.11n (HT40), 802.11ac (VHT40) 1 for 802.11ac (VHT80) 5745 ~ 5825MHz: 5 for 802.11a, 802.11n (HT20), 802.11ac (VHT20) 2 for 802.11n (HT40), 802.11ac (VHT40) 1 for 802.11ac (VHT80)
Output Power	CDD Mode: 5180 ~ 5240MHz: 52.252mW 5745 ~ 5825MHz: 379.358mW Beamforming Mode: 5180 ~ 5240MHz: 26.128mW 5745 ~ 5825MHz: 189.691mW
Antenna Type	Refer to note
Antenna Connector	Refer to note
Accessory Device	Adapter (option)
Data Cable Supplied	NA

Note:

1. All models are listed as below. Model: FAP-221E and FAP-223E were chosen for final test.

Brand	Model	Difference
Fortinet Inc.	FortiAP 221Exxxxx	With Internal Antenna
	FAP-221Exxxxx (Main test model: FAP-221E)	
	FORTIAP-221Exxxxx	
	FortiAP 223Exxxxx	With External Antenna
	FAP-223Exxxxx (Main test model: FAP-223E)	
	FORTIAP-223Exxxxx	

where "x" can be used as "A-Z", or "0-9", or "-", or blank for marketing purposes only

2. The EUT incorporates a MIMO function. Physically, the EUT provides 2 completed transmitters and 2 receivers.

Modulation Mode	TX Function	Beamforming
802.11a	2TX	Not Support
802.11n (HT20)	2TX	Support
802.11n (HT40)	2TX	Support
802.11ac (VHT20)	2TX	Support
802.11ac (VHT40)	2TX	Support
802.11ac (VHT80)	2TX	Support

* For 5GHz band, CDD mode is the worst case for final tests except RF output power test after pretesting CDD mode and beamforming mode.

*The modulation and bandwidth are similar for 802.11n mode for HT20/HT40 and 802.11ac mode for VHT20/VHT40, therefore investigated worst case to representative mode in test report. (Final test mode refer section 3.2.1)

3. The EUT uses following antennas.

For Model: FAP-221E (Internal antenna)

Antenna Type	Printed	Antenna Connector	IPEX
Gain (dBi)	Frequency (MHz)		
	2400-2500	5150-5850	
Internal Ant. 1	4.4	-	
Internal Ant. 2	4.5	-	
Internal Ant. 3	-	5.6	
Internal Ant. 4	-	5.6	

For Model: FAP-223E (External antenna)

Antenna Type	Dipole		Antenna Connector	RP SMA plug		
Gain (dBi)	Frequency (MHz)					
	2400	2450	2500	5150	5550	5850
External Ant.	4.06	4.26	4.58	5.27	5.35	5.04

* The highest antenna gain was chosen for antenna port conducted measurement tested only

4. 2.4GHz and 5GHz technology can transmit at same time.

5. Spurious emission of the simultaneous operation (2.4GHz and 5GHz) has been evaluated and no non-compliance was found.

3.2 Description of Test Modes

For 5180 ~ 5240MHz

4 channels are provided for 802.11a, 802.11n (HT20), 802.11ac (VHT20):

Channel	Frequency	Channel	Frequency
36	5180 MHz	44	5220 MHz
40	5200 MHz	48	5240 MHz

2 channels are provided for 802.11n (HT40), 802.11ac (VHT40):

Channel	Frequency	Channel	Frequency
38	5190 MHz	46	5230 MHz

1 channel is provided for 802.11ac (VHT80):

Channel	Frequency
42	5210MHz

For 5745 ~ 5825MHz:

5 channels are provided for 802.11a, 802.11n (HT20), 802.11ac (VHT20):

Channel	Frequency	Channel	Frequency
149	5745MHz	161	5805MHz
153	5765MHz	165	5825MHz
157	5785MHz		

2 channels are provided for 802.11n (HT40), 802.11ac (VHT40):

Channel	Frequency	Channel	Frequency
151	5755MHz	159	5795MHz

1 channel is provided for 802.11ac (VHT80):

Channel	Frequency
155	5775MHz

3.2.1 Test Mode Applicability and Tested Channel Detail

EUT CONFIGURE MODE	APPLICABLE TO				DESCRIPTION
	RE \geq 1G	RE<1G	PLC	APCM	
A	√	√	√	√	Model: FAP-221E Power from adapter
B	-	√	√	-	Model: FAP-221E Power from POE
C	√	√	√	-	Model: FAP-223E Power from adapter
D	-	√	√	-	Model: FAP-223E Power from POE

Where **RE \geq 1G**: Radiated Emission above 1GHz & Bandedge Measurement
RE<1G: Radiated Emission below 1GHz
PLC: Power Line Conducted Emission
APCM: Antenna Port Conducted Measurement

Note:

1. The EUT had been pre-tested on the positioned of each 3 axis. The worst case was found when positioned on **Z-plane**.
2. "-" means no effect.

Radiated Emission Test (Above 1GHz):

- Pre-Scan has been conducted to determine the worst-case mode from all possible combinations between available modulations, data rates and antenna ports (if EUT with antenna diversity architecture).
- Following channel(s) was (were) selected for the final test as listed below.

EUT CONFIGURE MODE	MODE	FREQ. BAND (MHz)	AVAILABLE CHANNEL	TESTED CHANNEL	MODULATION TECHNOLOGY	MODULATION TYPE	DATA RATE (Mbps)
A, C	802.11a	5180-5240	36 to 48	36, 40, 48	OFDM	BPSK	6.0
A, C	802.11n (HT20)		36 to 48	36, 40, 48	OFDM	BPSK	7.2
A, C	802.11n (HT40)		38 to 46	38, 46	OFDM	BPSK	15.0
A, C	802.11ac (VHT80)		42	42	OFDM	BPSK	65.0
A, C	802.11a	5745-5825	149 to 165	149, 157, 165	OFDM	BPSK	6.0
A, C	802.11n (HT20)		149 to 165	149, 157, 165	OFDM	BPSK	7.2
A, C	802.11n (HT40)		151 to 159	151, 159	OFDM	BPSK	15.0
A, C	802.11ac (VHT80)		155	155	OFDM	BPSK	65.0

Radiated Emission Test (Below 1GHz):

- Pre-Scan has been conducted to determine the worst-case mode from all possible combinations between available modulations, data rates and antenna ports (if EUT with antenna diversity architecture).
- Following channel(s) was (were) selected for the final test as listed below.

EUT CONFIGURE MODE	MODE	FREQ. BAND (MHz)	AVAILABLE CHANNEL	TESTED CHANNEL	MODULATION TECHNOLOGY	MODULATION TYPE	DATA RATE (Mbps)
A, B, C, D	802.11a	5180-5240	36 to 48	36	OFDM	BPSK	6.0
	802.11a	5745-5825	149 to 165		OFDM	BPSK	6.0

Power Line Conducted Emission Test:

- Pre-Scan has been conducted to determine the worst-case mode from all possible combinations between available modulations, data rates and antenna ports (if EUT with antenna diversity architecture).
- Following channel(s) was (were) selected for the final test as listed below.

EUT CONFIGURE MODE	MODE	FREQ. BAND (MHz)	AVAILABLE CHANNEL	TESTED CHANNEL	MODULATION TECHNOLOGY	MODULATION TYPE	DATA RATE (Mbps)
A, B, C, D	802.11a	5180-5240	36 to 48	36	OFDM	BPSK	6.0
	802.11a	5745-5825	149 to 165		OFDM	BPSK	6.0

Bandwidth, Peak Power Spectral Density and Frequency Stability Measurement:

- This item includes all test value of each mode, but only includes spectrum plot of worst value of each mode.
- Pre-Scan has been conducted to determine the worst-case mode from all possible combinations between available modulations, data rates and antenna ports (if EUT with antenna diversity architecture).
- Following channel(s) was (were) selected for the final test as listed below.

EUT CONFIGURE MODE	MODE	FREQ. BAND (MHz)	AVAILABLE CHANNEL	TESTED CHANNEL	MODULATION TECHNOLOGY	MODULATION TYPE	DATA RATE (Mbps)
A	802.11a	5180-5240	36 to 48	36, 40, 48	OFDM	BPSK	6.0
A	802.11n (HT20)		36 to 48	36, 40, 48	OFDM	BPSK	7.2
A	802.11n (HT40)		38 to 46	38, 46	OFDM	BPSK	15.0
A	802.11ac (VHT80)		42	42	OFDM	BPSK	65.0
A	802.11a	5745-5825	149 to 165	149, 157, 165	OFDM	BPSK	6.0
A	802.11n (HT20)		149 to 165	149, 157, 165	OFDM	BPSK	7.2
A	802.11n (HT40)		151 to 159	151, 159	OFDM	BPSK	15.0
A	802.11ac (VHT80)		155	155	OFDM	BPSK	65.0

Transmit Power Measurement:

- This item includes all test value of each mode, but only includes spectrum plot of worst value of each mode.
- Pre-Scan has been conducted to determine the worst-case mode from all possible combinations between available modulations, data rates and antenna ports (if EUT with antenna diversity architecture).
- Following channel(s) was (were) selected for the final test as listed below.

EUT CONFIGURE MODE	MODE	FREQ. BAND (MHz)	AVAILABLE CHANNEL	TESTED CHANNEL	MODULATION TECHNOLOGY	MODULATION TYPE	DATA RATE (Mbps)
CDD Mode							
A	802.11a	5180-5240	36 to 48	36, 40, 48	OFDM	BPSK	6.0
A	802.11n (HT20)		36 to 48	36, 40, 48	OFDM	BPSK	7.2
A	802.11n (HT40)		38 to 46	38, 46	OFDM	BPSK	15.0
A	802.11ac (VHT80)		42	42	OFDM	BPSK	65.0
A	802.11a	5745-5825	149 to 165	149, 157, 165	OFDM	BPSK	6.0
A	802.11n (HT20)		149 to 165	149, 157, 165	OFDM	BPSK	7.2
A	802.11n (HT40)		151 to 159	151, 159	OFDM	BPSK	15.0
A	802.11ac (VHT80)		155	155	OFDM	BPSK	65.0
Beamforming Mode							
A	802.11n (HT20)	5180-5240	36 to 48	36, 40, 48	OFDM	BPSK	7.2
A	802.11n (HT40)		38 to 46	38, 46	OFDM	BPSK	15.0
A	802.11ac (VHT80)		42	42	OFDM	BPSK	65.0
A	802.11n (HT20)	5745-5825	149 to 165	149, 157, 165	OFDM	BPSK	7.2
A	802.11n (HT40)		151 to 159	151, 159	OFDM	BPSK	15.0
A	802.11ac (VHT80)		155	155	OFDM	BPSK	65.0

Test Condition:

APPLICABLE TO	ENVIRONMENTAL CONDITIONS	INPUT POWER	TESTED BY
RE≥1G	19deg. C, 70%RH 18deg. C, 70%RH	120Vac, 60Hz	James Yang Nick Hsu
RE<1G	21deg. C, 69%RH	120Vac, 60Hz 54Vdc	James Yang Jones Chang
PLC	23deg. C, 70%RH	120Vac, 60Hz 54Vdc	Jones Chang
APCM	16deg. C, 70%RH	120Vac, 60Hz	Nick Hsu

3.3 Duty Cycle of Test Signal

802.11a, 802.11n (HT40), 802.11ac (VHT80): Duty cycle of test signal is < 98 %, duty factor is required.
 802.11n (HT20): Duty cycle of test signal is > 98%, duty factor is not required.

802.11a: Duty cycle = $2.052/2.135 = 0.961$, Duty factor = $10 * \log(1/0.961) = 0.17$

802.11n (HT20): Duty cycle = $4.995/5.090 = 0.981$

802.11n (HT40): Duty cycle = $2.413/2.503 = 0.964$, Duty factor = $10 * \log(1/0.964) = 0.16$

802.11ac (VHT80): Duty cycle = $1.135/1.232 = 0.921$, Duty factor = $10 * \log(1/0.921) = 0.36$

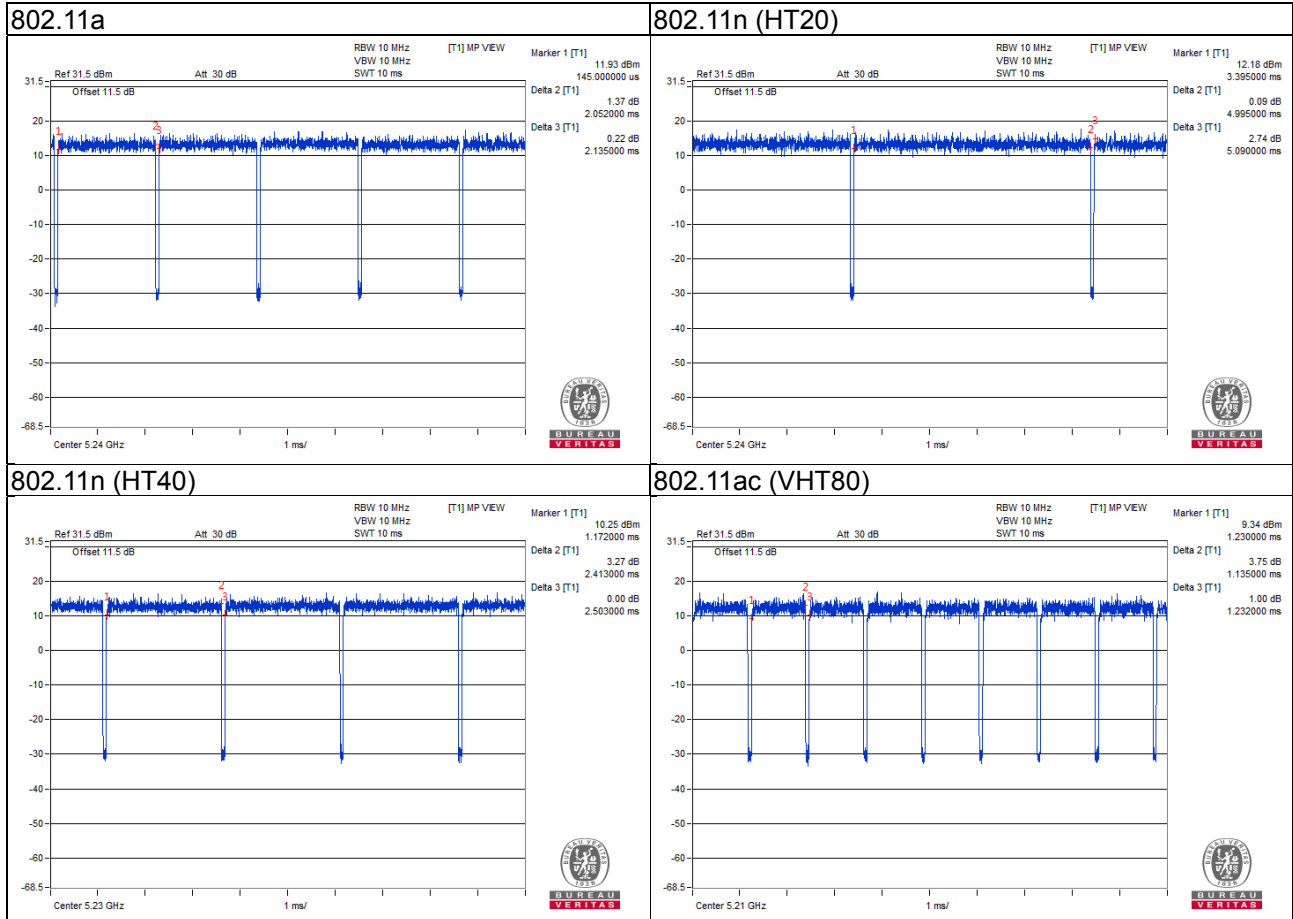

3.4 Description of Support Units

The EUT has been tested as an independent unit together with other necessary accessories or support units. The following support units or accessories were used to form a representative test configuration during the tests.

ID	Product	Brand	Model No.	Serial No.	FCC ID	Remarks
A.	Notebook	DELL	Latitude E6420	HPFC5Q1	FCC DoC Approved	-
B.	Adapter	Asian Power Devices Inc.	WA-30J12R	NA	NA	Option of EUT I/P: 100-240Vac, 50-60Hz, 0.9A Max. O/P: 12Vdc, 2.5A 1.8m power cable without core attached on adapter For test mode A and C only
C.	POE	EnGenius	EPA5006GAT	NA	NA	Provided by client I/P: 100-240Vac, 50-60Hz 0.8A O/P: 54Vdc, 0.6A 0.5m power cable without core For test mode B and D only

Note:

1. All power cords of the above support units are non-shielded (1.8m).
2. Item A acted as communication partner to transfer data.

ID	Descriptions	Qty.	Length (m)	Shielding (Yes/No)	Cores (Qty.)	Remarks
1.	RJ45 Cable	1	3	N	0	Cat5e
2.	RJ45 Cable	1	1.8	N	0	Cat5e For test mode B and D only

3.4.1 Configuration of System under Test

Test Mode A, C

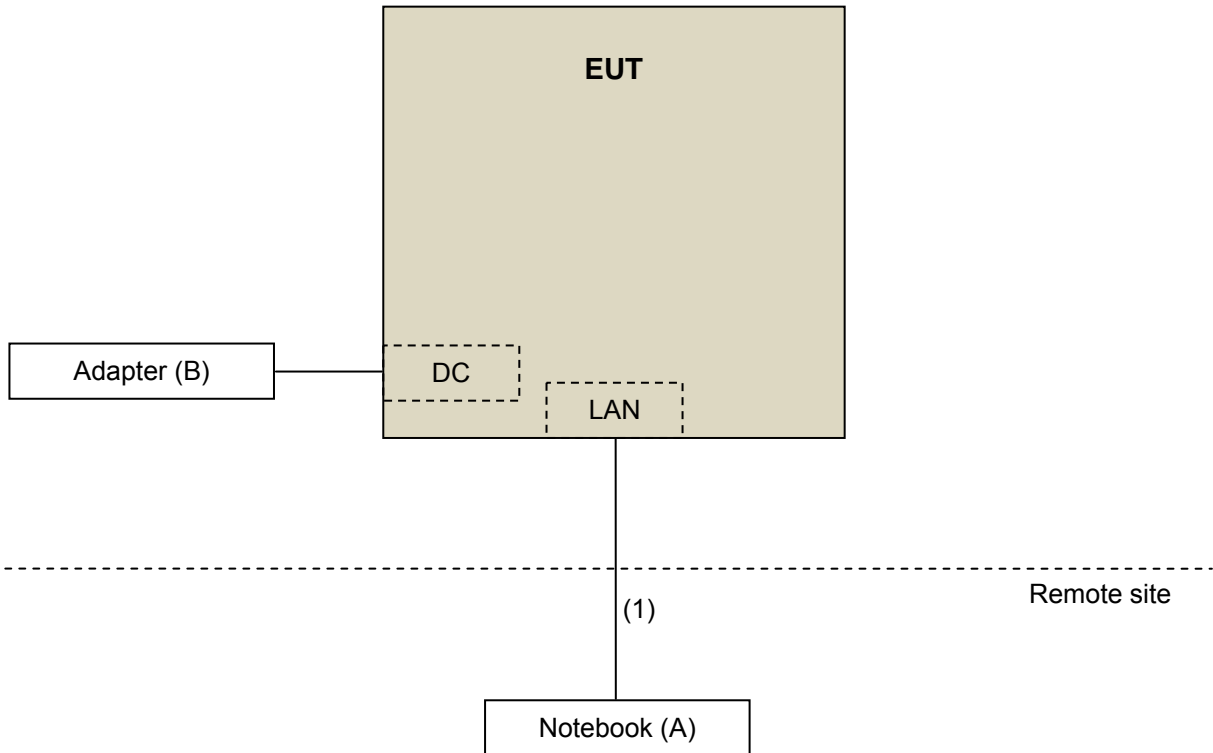

Test Mode B, D

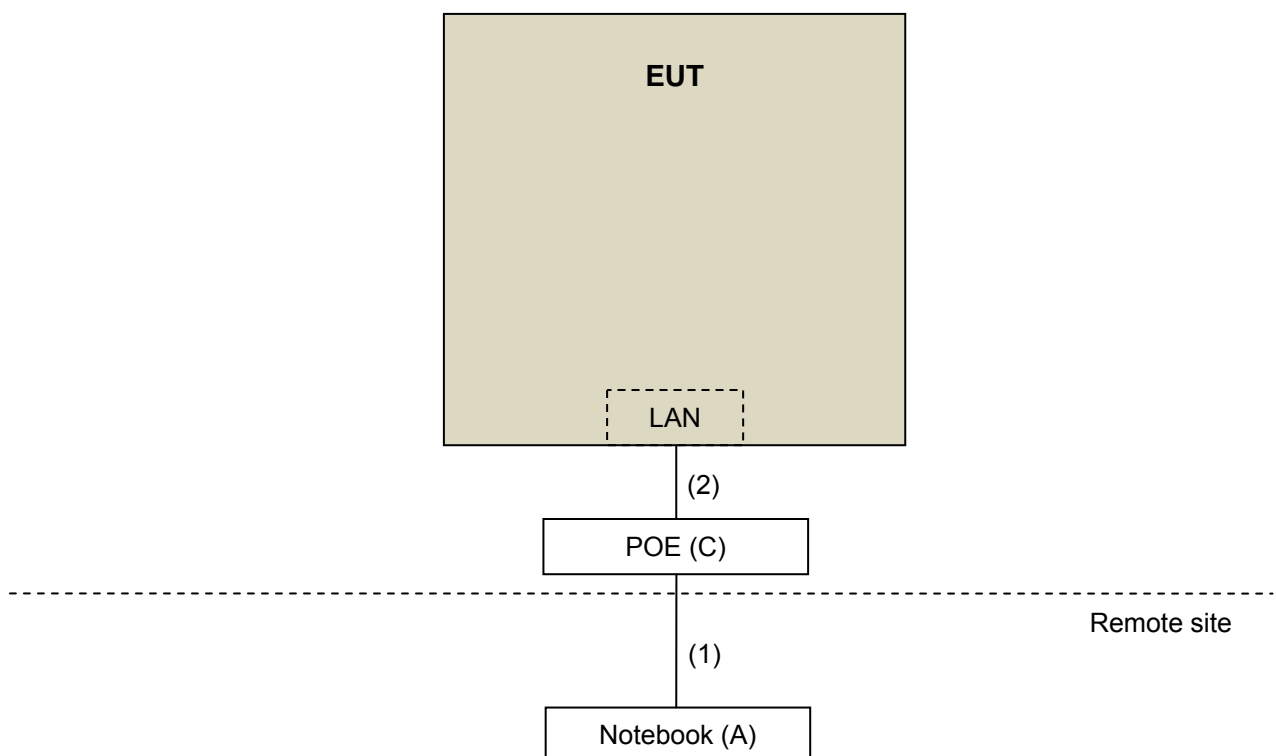

3.5 General Description of Applied Standards

The EUT is a RF Product. According to the specifications of the manufacturer, it must comply with the requirements of the following standards:

FCC Part 15, Subpart E (15.407)

KDB 789033 D02 General UNII Test Procedure New Rules v01r04

KDB 662911 D01 Multiple Transmitter Output v02r01

ANSI C63.10:2013

All test items have been performed and recorded as per the above standards.

Note: The EUT has been verified to comply with the requirements of FCC Part 15, Subpart B, Class B (DoC).
The test report has been issued separately.

4 Test Types and Results

4.1 Radiated Emission and Bandedge Measurement

4.1.1 Limits of Radiated Emission and Bandedge Measurement

Radiated emissions which fall in the restricted bands must comply with the radiated emission limits specified as below table.

Frequencies (MHz)	Field Strength (microvolts/meter)	Measurement Distance (meters)
0.009 ~ 0.490	2400/F(kHz)	300
0.490 ~ 1.705	24000/F(kHz)	30
1.705 ~ 30.0	30	30
30 ~ 88	100	3
88 ~ 216	150	3
216 ~ 960	200	3
Above 960	500	3

NOTE:

- The lower limit shall apply at the transition frequencies.
- Emission level (dBuV/m) = 20 log Emission level (uV/m).
- For frequencies above 1000MHz, the field strength limits are based on average detector, however, the peak field strength of any emission shall not exceed the maximum permitted average limits, specified above by more than 20dB under any condition of modulation.

Limits of unwanted emission out of the restricted bands

Applicable To		Limit	
789033 D02 General UNII Test Procedure New Rules v01r04		Field Strength at 3m	
		PK:74 (dBµV/m)	AV:54 (dBµV/m)
Frequency Band	Applicable To	EIRP Limit	Equivalent Field Strength at 3m
5150~5250 MHz	15.407(b)(1)	PK:-27 (dBm/MHz)	PK:68.2(dBµV/m)
5250~5350 MHz	15.407(b)(2)		
5470~5725 MHz	15.407(b)(3)		
5725~5850 MHz	<input checked="" type="checkbox"/> 15.407(b)(4)(i)	PK:-27 (dBm/MHz) ^{*1} PK:10 (dBm/MHz) ^{*2} PK:15.6 (dBm/MHz) ^{*3} PK:27 (dBm/MHz) ^{*4}	PK: 68.2(dBµV/m) ^{*1} PK:105.2 (dBµV/m) ^{*2} PK: 110.8(dBµV/m) ^{*3} PK:122.2 (dBµV/m) ^{*4}
	<input type="checkbox"/> 15.407(b)(4)(ii)	Emission limits in section 15.247(d)	
^{*1} beyond 75 MHz or more above of the band edge.		^{*2} below the band edge increasing linearly to 10 dBm/MHz at 25 MHz above.	
^{*3} below the band edge increasing linearly to a level of 15.6 dBm/MHz at 5 MHz above.		^{*4} from 5 MHz above or below the band edge increasing linearly to a level of 27 dBm/MHz at the band edge.	

Note: The following formula is used to convert the equipment isotropic radiated power (eirp) to field strength:

$$E = \frac{1000000 \sqrt{30P}}{3} \mu\text{V/m, where P is the eirp (Watts).}$$

4.1.2 Test Instruments

Description & Manufacturer	Model No.	Serial No.	Cal. Date	Cal. Due
Test Receiver ROHDE & SCHWARZ	ESIB7	100187	Apr. 18, 2016	Apr. 17, 2017
Spectrum Analyzer ROHDE & SCHWARZ	FSP40	100041	Nov. 16, 2015	Nov. 15, 2016
			Nov. 16, 2016	Nov. 15, 2017
BILOG Antenna SCHWARZBECK	VULB9168	9168-171	Dec. 28, 2015	Dec. 27, 2016
			Dec. 28, 2016	Dec. 27, 2017
HORN Antenna SCHWARZBECK	9120D	209	Dec. 27, 2015	Dec. 26, 2016
			Dec. 27, 2016	Dec. 26, 2017
HORN Antenna SCHWARZBECK	BBHA 9170	BBHA9170241	Dec. 14, 2015	Dec. 13, 2016
			Dec. 14, 2016	Dec. 13, 2017
Loop Antenna	EM-6879	269	Aug. 11, 2016	Aug. 10, 2017
Preamplifier Agilent	8447D	2944A10738	Aug. 22, 2016	Aug. 21, 2017
Preamplifier Agilent	8449B	3008A01922	Sep. 18, 2016	Sep. 17, 2017
RF signal cable HUBER+SUHNER	SUCOFLEX 104	Cable-CH3-03 (214378)	Aug. 22, 2016	Aug. 21, 2017
RF signal cable HUBER+SUHNER	SUCOFLEX 106	Cable-CH3-03 (309224+12738)	Aug. 22, 2016	Aug. 21, 2017
Software BV ADT	ADT_Radiated_ V7.6.15.9.4	NA	NA	NA
Antenna Tower inn-co GmbH	MA 4000	013303	NA	NA
Antenna Tower Controller BV ADT	AT100	AT93021702	NA	NA
Turn Table BV ADT	TT100	TT93021702	NA	NA
Turn Table Controller BV ADT	SC100	SC93021702	NA	NA
26GHz ~ 40GHz Amplifier	EM26400	815221	Oct. 17, 2015	Oct. 16, 2016
			Oct. 17, 2016	Oct. 16, 2017
High Speed Peak Power Meter	ML2495A	0824012	Aug. 11, 2016	Aug. 10, 2017
Power Sensor	MA2411B	0738171	Aug. 11, 2016	Aug. 10, 2017
WIT Standard Temperature And Humidity Chamber	TH-4S-C	W981030	Jun. 08, 2016	Jun. 07, 2017

- Note:
1. The calibration interval of the above test instruments is 12 months and the calibrations are traceable to NML/ROC and NIST/USA.
 2. The test was performed in HwaYa Chamber 3.
 3. The horn antenna and preamplifier (model: 8449B) are used only for the measurement of emission frequency above 1GHz if tested.
 4. The FCC Site Registration No. is 988962.
 5. The IC Site Registration No. is IC 7450F-3.

4.1.3 Test Procedures

For Radiated emission below 30MHz

- a. The EUT was placed on the top of a rotating table 0.8 meters above the ground at a 3 meter chamber room. The table was rotated 360 degrees to determine the position of the highest radiation.
- b. The EUT was set 3 meters away from the interference-receiving antenna, which was mounted on the top of a variable-height antenna tower.
- c. Both X and Y axes of the antenna are set to make the measurement.
- d. For each suspected emission, the EUT was arranged to its worst case and the rotatable table was turned from 0 degrees to 360 degrees to find the maximum reading.
- e. The test-receiver system was set to Quasi-Peak Detect Function and Specified Bandwidth with Maximum Hold Mode.

Note:

1. The resolution bandwidth and video bandwidth of test receiver/spectrum analyzer is 9kHz at frequency below 30MHz.

For Radiated emission above 30MHz

- a. The EUT was placed on the top of a rotating table 0.8 meters (for 30MHz ~ 1GHz) / 1.5 meters (for above 1GHz) above the ground at 3 meter chamber room for test. The table was rotated 360 degrees to determine the position of the highest radiation.
- b. The EUT was set 3 meters away from the interference-receiving antenna, which was mounted on the top of a variable-height antenna tower.
- c. The height of antenna is varied from one meter to four meters above the ground to determine the maximum value of the field strength. Both horizontal and vertical polarizations of the antenna are set to make the measurement.
- d. For each suspected emission, the EUT was arranged to its worst case and then the antenna was tuned to heights from 1 meter to 4 meters and the rotatable table was turned from 0 degrees to 360 degrees to find the maximum reading.
- e. The test-receiver system was set to quasi-peak detect function and specified bandwidth with maximum hold mode when the test frequency is below 1 GHz.
- f. The test-receiver system was set to peak and average detect function and specified bandwidth with maximum hold mode when the test frequency is above 1 GHz. If the peak reading value also meets average limit, measurement with the average detector is unnecessary.

Note:

1. The resolution bandwidth and video bandwidth of test receiver/spectrum analyzer is 120kHz for Quasi-peak detection (QP) at frequency below 1GHz.
2. The resolution bandwidth of test receiver/spectrum analyzer is 1 MHz and the video bandwidth is 3 MHz for Peak detection (PK) at frequency above 1GHz.
3. The resolution bandwidth of test receiver/spectrum analyzer is 1MHz and the video bandwidth is $\geq 1/T$ (Duty cycle < 98%) or 10Hz (Duty cycle $\geq 98\%$) for Average detection (AV) at frequency above 1GHz.
4. All modes of operation were investigated and the worst-case emissions are reported.

4.1.4 Deviation from Test Standard

No deviation.

4.1.5 Test Set Up

For Radiated emission below 30MHz

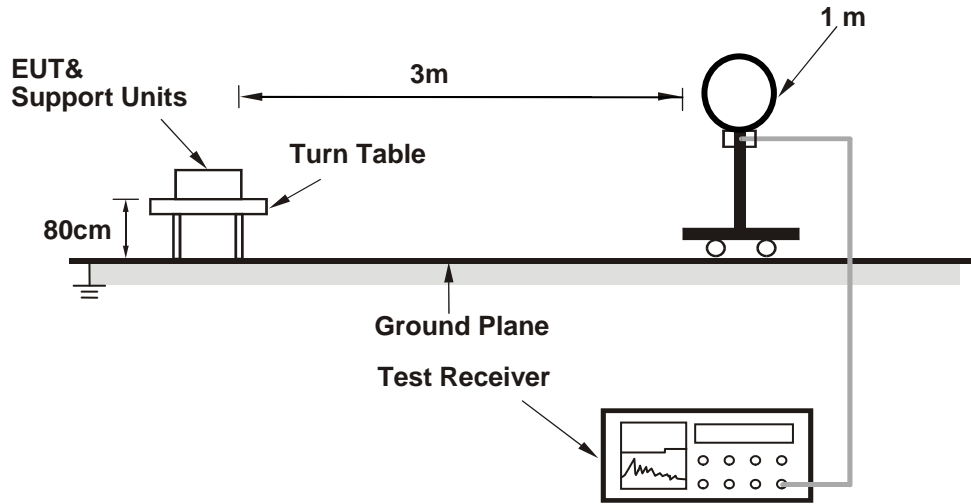

For Radiated emission 30MHz to 1GHz

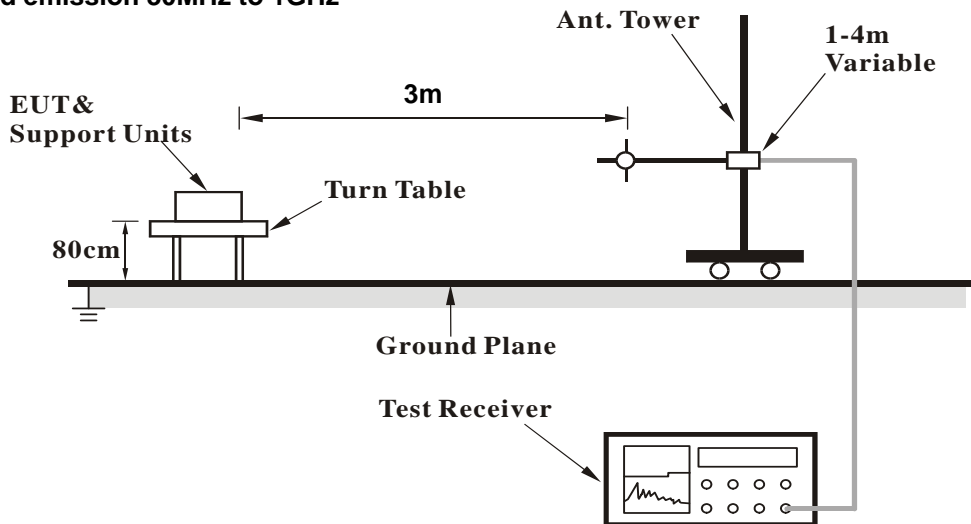

For Radiated emission above 1GHz

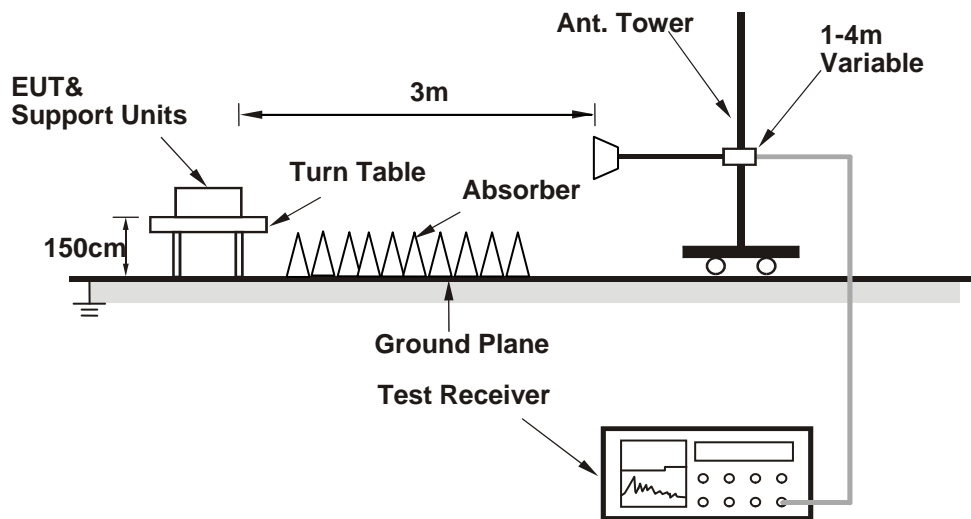

For the actual test configuration, please refer to the attached file (Test Setup Photo).

4.1.6 EUT Operating Conditions

- Placed the EUT on the testing table.
- Prepared a notebook to act as a communication partner and placed it outside of testing area.
- The communication partner connected with EUT via a RJ45 cable and ran a test program (provided by manufacturer) to enable EUT under transmission condition continuously at specific channel frequency.
- The communication partner sent data to EUT by command "PING".

4.1.7 Test Results

Above 1GHz worst-Case Data:

Test Mode A

802.11a

CHANNEL	TX Channel 36	DETECTOR FUNCTION	Peak (PK)
FREQUENCY RANGE	1GHz ~ 40GHz		Average (AV)

ANTENNA POLARITY & TEST DISTANCE: HORIZONTAL AT 3 M								
NO.	FREQ. (MHz)	EMISSION LEVEL (dBuV/m)	LIMIT (dBuV/m)	MARGIN (dB)	ANTENNA HEIGHT (m)	TABLE ANGLE (Degree)	RAW VALUE (dBuV)	CORRECTION FACTOR (dB/m)
1	5150.00	70.4 PK	74.0	-3.6	1.33 H	305	65.6	4.8
2	5150.00	52.5 AV	54.0	-1.5	1.33 H	305	47.7	4.8
3	*5180.00	117.4 PK			1.93 H	301	78.7	38.7
4	*5180.00	106.9 AV			1.93 H	301	68.2	38.7
5	#10360.00	58.9 PK	74.0	-15.1	2.05 H	114	41.3	17.6
6	#10360.00	46.6 AV	54.0	-7.4	2.05 H	114	29.0	17.6
ANTENNA POLARITY & TEST DISTANCE: VERTICAL AT 3 M								
NO.	FREQ. (MHz)	EMISSION LEVEL (dBuV/m)	LIMIT (dBuV/m)	MARGIN (dB)	ANTENNA HEIGHT (m)	TABLE ANGLE (Degree)	RAW VALUE (dBuV)	CORRECTION FACTOR (dB/m)
1	5150.00	68.3 PK	74.0	-5.7	1.71 V	346	63.5	4.8
2	5150.00	49.6 AV	54.0	-4.4	1.71 V	346	44.8	4.8
3	*5180.00	111.7 PK			1.77 V	343	73.0	38.7
4	*5180.00	101.5 AV			1.77 V	343	62.8	38.7
5	#10360.00	59.8 PK	74.0	-14.2	1.87 V	254	42.2	17.6
6	#10360.00	46.6 AV	54.0	-7.4	1.87 V	254	29.0	17.6

Remarks:

1. Emission Level(dBuV/m) = Raw Value(dBuV) + Correction Factor(dB/m)
2. Correction Factor(dB/m) = Antenna Factor(dB/m) + Cable Factor(dB) – Pre-Amplifier Factor(dB)
3. The other emission levels were very low against the limit.
4. Margin value = Emission Level – Limit value
5. " * ": Fundamental frequency.
6. " # ": The radiated frequency is out of the restricted band.

CHANNEL	TX Channel 40	DETECTOR FUNCTION	Peak (PK)
FREQUENCY RANGE	1GHz ~ 40GHz		Average (AV)

ANTENNA POLARITY & TEST DISTANCE: HORIZONTAL AT 3 M								
NO.	FREQ. (MHz)	EMISSION LEVEL (dBuV/m)	LIMIT (dBuV/m)	MARGIN (dB)	ANTENNA HEIGHT (m)	TABLE ANGLE (Degree)	RAW VALUE (dBuV)	CORRECTION FACTOR (dB/m)
1	*5200.00	119.1 PK			1.05 H	300	80.4	38.7
2	*5200.00	108.4 AV			1.05 H	300	69.7	38.7
3	#10400.00	59.9 PK	74.0	-14.1	1.98 H	145	42.3	17.6
4	#10400.00	46.5 AV	54.0	-7.5	1.98 H	145	28.9	17.6
ANTENNA POLARITY & TEST DISTANCE: VERTICAL AT 3 M								
NO.	FREQ. (MHz)	EMISSION LEVEL (dBuV/m)	LIMIT (dBuV/m)	MARGIN (dB)	ANTENNA HEIGHT (m)	TABLE ANGLE (Degree)	RAW VALUE (dBuV)	CORRECTION FACTOR (dB/m)
1	*5200.00	115.4 PK			1.75 V	344	76.7	38.7
2	*5200.00	105.1 AV			1.75 V	344	66.4	38.7
3	#10400.00	59.1 PK	74.0	-14.9	1.78 V	224	41.5	17.6
4	#10400.00	46.5 AV	54.0	-7.5	1.78 V	224	28.9	17.6

Remarks:

1. Emission Level(dBuV/m) = Raw Value(dBuV) + Correction Factor(dB/m)
2. Correction Factor(dB/m) = Antenna Factor(dB/m) + Cable Factor(dB) – Pre-Amplifier Factor(dB)
3. The other emission levels were very low against the limit.
4. Margin value = Emission Level – Limit value
5. " * ": Fundamental frequency.
6. " # ": The radiated frequency is out of the restricted band.

CHANNEL	TX Channel 48	DETECTOR FUNCTION	Peak (PK)
FREQUENCY RANGE	1GHz ~ 40GHz		Average (AV)

ANTENNA POLARITY & TEST DISTANCE: HORIZONTAL AT 3 M

NO.	FREQ. (MHz)	EMISSION LEVEL (dBuV/m)	LIMIT (dBuV/m)	MARGIN (dB)	ANTENNA HEIGHT (m)	TABLE ANGLE (Degree)	RAW VALUE (dBuV)	CORRECTION FACTOR (dB/m)
1	*5240.00	119.7 PK			1.02 H	297	80.8	38.9
2	*5240.00	108.8 AV			1.02 H	297	69.9	38.9
3	5350.00	57.2 PK	74.0	-16.8	1.08 H	293	51.7	5.5
4	5350.00	44.0 AV	54.0	-10.0	1.08 H	293	38.5	5.5
5	#10480.00	59.5 PK	74.0	-14.5	1.48 H	261	41.1	18.4
6	#10480.00	46.9 AV	54.0	-7.1	1.48 H	261	28.5	18.4

ANTENNA POLARITY & TEST DISTANCE: VERTICAL AT 3 M

NO.	FREQ. (MHz)	EMISSION LEVEL (dBuV/m)	LIMIT (dBuV/m)	MARGIN (dB)	ANTENNA HEIGHT (m)	TABLE ANGLE (Degree)	RAW VALUE (dBuV)	CORRECTION FACTOR (dB/m)
1	*5240.00	116.0 PK			1.76 V	348	77.1	38.9
2	*5240.00	105.6 AV			1.76 V	348	66.7	38.9
3	5350.00	56.1 PK	74.0	-17.9	1.61 V	358	50.6	5.5
4	5350.00	43.5 AV	54.0	-10.5	1.61 V	358	38.0	5.5
5	#10480.00	60.0 PK	74.0	-14.0	1.74 V	328	41.6	18.4
6	#10480.00	47.1 AV	54.0	-6.9	1.74 V	328	28.7	18.4

Remarks:

1. Emission Level(dBuV/m) = Raw Value(dBuV) + Correction Factor(dB/m)
2. Correction Factor(dB/m) = Antenna Factor(dB/m) + Cable Factor(dB) – Pre-Amplifier Factor(dB)
3. The other emission levels were very low against the limit.
4. Margin value = Emission Level – Limit value
5. " * ": Fundamental frequency.
6. " # ": The radiated frequency is out of the restricted band.

CHANNEL	TX Channel 149	DETECTOR FUNCTION	Peak (PK)
FREQUENCY RANGE	1GHz ~ 40GHz		Average (AV)

ANTENNA POLARITY & TEST DISTANCE: HORIZONTAL AT 3 M								
NO.	FREQ. (MHz)	EMISSION LEVEL (dBuV/m)	LIMIT (dBuV/m)	MARGIN (dB)	ANTENNA HEIGHT (m)	TABLE ANGLE (Degree)	RAW VALUE (dBuV)	CORRECTION FACTOR (dB/m)
1	#5616.80	57.8 PK	68.2	-10.4	1.20 H	317	51.7	6.1
2	*5745.00	118.6 PK			1.20 H	317	78.6	40.0
3	*5745.00	108.2 AV			1.20 H	317	68.2	40.0
4	#5954.40	58.1 PK	68.2	-10.1	1.20 H	317	51.5	6.6
5	11490.00	58.4 PK	74.0	-15.6	1.78 H	50	39.1	19.3
6	11490.00	46.5 AV	54.0	-7.5	1.78 H	50	27.2	19.3
ANTENNA POLARITY & TEST DISTANCE: VERTICAL AT 3 M								
NO.	FREQ. (MHz)	EMISSION LEVEL (dBuV/m)	LIMIT (dBuV/m)	MARGIN (dB)	ANTENNA HEIGHT (m)	TABLE ANGLE (Degree)	RAW VALUE (dBuV)	CORRECTION FACTOR (dB/m)
1	#5640.80	58.4 PK	68.2	-9.8	1.00 V	1	52.3	6.1
2	*5745.00	118.5 PK			1.00 V	1	78.5	40.0
3	*5745.00	107.7 AV			1.00 V	1	67.7	40.0
4	#5992.00	58.4 PK	68.2	-9.8	1.00 V	1	51.7	6.7
5	11490.00	59.0 PK	74.0	-15.0	1.31 V	216	39.7	19.3
6	11490.00	46.2 AV	54.0	-7.8	1.31 V	216	26.9	19.3

Remarks:

1. Emission Level(dBuV/m) = Raw Value(dBuV) + Correction Factor(dB/m)
2. Correction Factor(dB/m) = Antenna Factor(dB/m) + Cable Factor(dB) – Pre-Amplifier Factor(dB)
3. The other emission levels were very low against the limit.
4. Margin value = Emission Level – Limit value
5. " * ": Fundamental frequency.
6. " # ": The radiated frequency is out of the restricted band.

CHANNEL	TX Channel 157	DETECTOR FUNCTION	Peak (PK)
FREQUENCY RANGE	1GHz ~ 40GHz		Average (AV)

ANTENNA POLARITY & TEST DISTANCE: HORIZONTAL AT 3 M

NO.	FREQ. (MHz)	EMISSION LEVEL (dBuV/m)	LIMIT (dBuV/m)	MARGIN (dB)	ANTENNA HEIGHT (m)	TABLE ANGLE (Degree)	RAW VALUE (dBuV)	CORRECTION FACTOR (dB/m)
1	#5640.80	58.0 PK	68.2	-10.2	1.69 H	319	51.9	6.1
2	*5785.00	119.3 PK			1.69 H	320	79.2	40.1
3	*5785.00	108.8 AV			1.69 H	320	68.7	40.1
4	#5970.40	59.1 PK	68.2	-9.1	1.69 H	320	52.4	6.7
5	11570.00	61.5 PK	74.0	-12.5	2.71 H	270	42.3	19.2
6	11570.00	48.2 AV	54.0	-5.8	2.71 H	270	29.0	19.2

ANTENNA POLARITY & TEST DISTANCE: VERTICAL AT 3 M

NO.	FREQ. (MHz)	EMISSION LEVEL (dBuV/m)	LIMIT (dBuV/m)	MARGIN (dB)	ANTENNA HEIGHT (m)	TABLE ANGLE (Degree)	RAW VALUE (dBuV)	CORRECTION FACTOR (dB/m)
1	#5629.60	57.9 PK	68.2	-10.3	1.13 V	7	51.8	6.1
2	*5785.00	117.2 PK			1.13 V	7	77.1	40.1
3	*5785.00	106.7 AV			1.13 V	7	66.6	40.1
4	#5969.60	58.5 PK	68.2	-9.7	1.13 V	7	51.8	6.7
5	11570.00	61.8 PK	74.0	-12.2	2.50 V	296	42.6	19.2
6	11570.00	48.7 AV	54.0	-5.3	2.50 V	296	29.5	19.2

Remarks:

1. Emission Level(dBuV/m) = Raw Value(dBuV) + Correction Factor(dB/m)
2. Correction Factor(dB/m) = Antenna Factor(dB/m) + Cable Factor(dB) – Pre-Amplifier Factor(dB)
3. The other emission levels were very low against the limit.
4. Margin value = Emission Level – Limit value
5. " * ": Fundamental frequency.

CHANNEL	TX Channel 165	DETECTOR FUNCTION	Peak (PK)
FREQUENCY RANGE	1GHz ~ 40GHz		Average (AV)

ANTENNA POLARITY & TEST DISTANCE: HORIZONTAL AT 3 M

NO.	FREQ. (MHz)	EMISSION LEVEL (dBuV/m)	LIMIT (dBuV/m)	MARGIN (dB)	ANTENNA HEIGHT (m)	TABLE ANGLE (Degree)	RAW VALUE (dBuV)	CORRECTION FACTOR (dB/m)
1	#5618.40	57.5 PK	68.2	-10.7	1.44 H	312	51.4	6.1
2	*5825.00	119.0 PK			1.44 H	312	78.9	40.1
3	*5825.00	109.0 AV			1.44 H	312	68.9	40.1
4	#5945.60	58.9 PK	68.2	-9.3	1.44 H	312	52.3	6.6
5	11650.00	60.2 PK	74.0	-13.8	2.78 H	288	40.9	19.3
6	11650.00	48.0 AV	54.0	-6.0	2.78 H	288	28.7	19.3

ANTENNA POLARITY & TEST DISTANCE: VERTICAL AT 3 M

NO.	FREQ. (MHz)	EMISSION LEVEL (dBuV/m)	LIMIT (dBuV/m)	MARGIN (dB)	ANTENNA HEIGHT (m)	TABLE ANGLE (Degree)	RAW VALUE (dBuV)	CORRECTION FACTOR (dB/m)
1	#5637.60	57.8 PK	68.2	-10.4	1.00 V	318	51.7	6.1
2	*5825.00	116.9 PK			1.00 V	318	76.8	40.1
3	*5825.00	106.8 AV			1.00 V	318	66.7	40.1
4	#5938.40	58.6 PK	68.2	-9.6	1.00 V	318	52.0	6.6
5	11650.00	60.2 PK	74.0	-13.8	2.02 V	215	40.9	19.3
6	11650.00	47.2 AV	54.0	-6.8	2.02 V	215	27.9	19.3

Remarks:

1. Emission Level(dBuV/m) = Raw Value(dBuV) + Correction Factor(dB/m)
2. Correction Factor(dB/m) = Antenna Factor(dB/m) + Cable Factor(dB) – Pre-Amplifier Factor(dB)
3. The other emission levels were very low against the limit.
4. Margin value = Emission Level – Limit value
5. " * ": Fundamental frequency.
6. " # ": The radiated frequency is out of the restricted band.

802.11n (HT20)

CHANNEL	TX Channel 36	DETECTOR FUNCTION	Peak (PK) Average (AV)
FREQUENCY RANGE	1GHz ~ 40GHz		

ANTENNA POLARITY & TEST DISTANCE: HORIZONTAL AT 3 M

NO.	FREQ. (MHz)	EMISSION LEVEL (dBuV/m)	LIMIT (dBuV/m)	MARGIN (dB)	ANTENNA HEIGHT (m)	TABLE ANGLE (Degree)	RAW VALUE (dBuV)	CORRECTION FACTOR (dB/m)
1	5150.00	70.0 PK	74.0	-4.0	1.90 H	304	65.2	4.8
2	5150.00	52.6 AV	54.0	-1.4	1.90 H	304	47.8	4.8
3	*5180.00	116.1 PK			1.95 H	295	77.4	38.7
4	*5180.00	105.5 AV			1.95 H	295	66.8	38.7
5	#10360.00	59.9 PK	74.0	-14.1	2.43 H	285	42.3	17.6
6	#10360.00	46.7 AV	54.0	-7.3	2.43 H	285	29.1	17.6

ANTENNA POLARITY & TEST DISTANCE: VERTICAL AT 3 M

NO.	FREQ. (MHz)	EMISSION LEVEL (dBuV/m)	LIMIT (dBuV/m)	MARGIN (dB)	ANTENNA HEIGHT (m)	TABLE ANGLE (Degree)	RAW VALUE (dBuV)	CORRECTION FACTOR (dB/m)
1	5150.00	61.7 PK	74.0	-12.3	1.99 V	311	56.9	4.8
2	5150.00	46.1 AV	54.0	-7.9	1.99 V	311	41.3	4.8
3	*5180.00	112.0 PK			1.79 V	345	73.3	38.7
4	*5180.00	101.8 AV			1.79 V	345	63.1	38.7
5	#10360.00	60.5 PK	74.0	-13.5	1.76 V	226	42.9	17.6
6	#10360.00	46.5 AV	54.0	-7.5	1.76 V	226	28.9	17.6

Remarks:

1. Emission Level(dBuV/m) = Raw Value(dBuV) + Correction Factor(dB/m)
2. Correction Factor(dB/m) = Antenna Factor(dB/m) + Cable Factor(dB) – Pre-Amplifier Factor(dB)
3. The other emission levels were very low against the limit.
4. Margin value = Emission Level – Limit value
5. " * ": Fundamental frequency.
6. " # ": The radiated frequency is out of the restricted band.

CHANNEL	TX Channel 40	DETECTOR FUNCTION	Peak (PK)
FREQUENCY RANGE	1GHz ~ 40GHz		Average (AV)

ANTENNA POLARITY & TEST DISTANCE: HORIZONTAL AT 3 M

NO.	FREQ. (MHz)	EMISSION LEVEL (dBuV/m)	LIMIT (dBuV/m)	MARGIN (dB)	ANTENNA HEIGHT (m)	TABLE ANGLE (Degree)	RAW VALUE (dBuV)	CORRECTION FACTOR (dB/m)
1	*5200.00	118.4 PK			1.12 H	300	79.7	38.7
2	*5200.00	107.9 AV			1.12 H	300	69.2	38.7
3	#10400.00	59.7 PK	74.0	-14.3	1.86 H	259	42.1	17.6
4	#10400.00	46.6 AV	54.0	-7.4	1.86 H	259	29.0	17.6

ANTENNA POLARITY & TEST DISTANCE: VERTICAL AT 3 M

NO.	FREQ. (MHz)	EMISSION LEVEL (dBuV/m)	LIMIT (dBuV/m)	MARGIN (dB)	ANTENNA HEIGHT (m)	TABLE ANGLE (Degree)	RAW VALUE (dBuV)	CORRECTION FACTOR (dB/m)
1	*5200.00	115.1 PK			1.75 V	346	76.4	38.7
2	*5200.00	104.8 AV			1.75 V	346	66.1	38.7
3	#10400.00	59.1 PK	74.0	-14.9	2.88 V	99	41.5	17.6
4	#10400.00	46.5 AV	54.0	-7.5	2.88 V	99	28.9	17.6

Remarks:

1. Emission Level(dBuV/m) = Raw Value(dBuV) + Correction Factor(dB/m)
2. Correction Factor(dB/m) = Antenna Factor(dB/m) + Cable Factor(dB) – Pre-Amplifier Factor(dB)
3. The other emission levels were very low against the limit.
4. Margin value = Emission Level – Limit value
5. " * ": Fundamental frequency.
6. " # ": The radiated frequency is out of the restricted band.

CHANNEL	TX Channel 48	DETECTOR FUNCTION	Peak (PK)
FREQUENCY RANGE	1GHz ~ 40GHz		Average (AV)

ANTENNA POLARITY & TEST DISTANCE: HORIZONTAL AT 3 M								
NO.	FREQ. (MHz)	EMISSION LEVEL (dBuV/m)	LIMIT (dBuV/m)	MARGIN (dB)	ANTENNA HEIGHT (m)	TABLE ANGLE (Degree)	RAW VALUE (dBuV)	CORRECTION FACTOR (dB/m)
1	*5240.00	119.3 PK			1.00 H	297	80.4	38.9
2	*5240.00	108.8 AV			1.00 H	297	69.9	38.9
3	5350.00	57.2 PK	74.0	-16.8	1.11 H	301	51.7	5.5
4	5350.00	43.9 AV	54.0	-10.1	1.11 H	301	38.4	5.5
5	#10480.00	59.9 PK	74.0	-14.1	1.77 H	189	41.5	18.4
6	#10480.00	46.7 AV	54.0	-7.3	1.77 H	189	28.3	18.4
ANTENNA POLARITY & TEST DISTANCE: VERTICAL AT 3 M								
NO.	FREQ. (MHz)	EMISSION LEVEL (dBuV/m)	LIMIT (dBuV/m)	MARGIN (dB)	ANTENNA HEIGHT (m)	TABLE ANGLE (Degree)	RAW VALUE (dBuV)	CORRECTION FACTOR (dB/m)
1	*5240.00	115.7 PK			1.75 V	349	76.8	38.9
2	*5240.00	105.9 AV			1.75 V	349	67.0	38.9
3	5350.00	56.9 PK	74.0	-17.1	1.77 V	352	51.4	5.5
4	5350.00	44.4 AV	54.0	-9.6	1.77 V	352	38.9	5.5
5	#10480.00	59.8 PK	74.0	-14.2	2.27 V	146	41.4	18.4
6	#10480.00	46.9 AV	54.0	-7.1	2.27 V	146	28.5	18.4

Remarks:

1. Emission Level(dBuV/m) = Raw Value(dBuV) + Correction Factor(dB/m)
2. Correction Factor(dB/m) = Antenna Factor(dB/m) + Cable Factor(dB) – Pre-Amplifier Factor(dB)
3. The other emission levels were very low against the limit.
4. Margin value = Emission Level – Limit value
5. " * ": Fundamental frequency.
6. " # ": The radiated frequency is out of the restricted band.

CHANNEL	TX Channel 149	DETECTOR FUNCTION	Peak (PK)
FREQUENCY RANGE	1GHz ~ 40GHz		Average (AV)

ANTENNA POLARITY & TEST DISTANCE: HORIZONTAL AT 3 M								
NO.	FREQ. (MHz)	EMISSION LEVEL (dBuV/m)	LIMIT (dBuV/m)	MARGIN (dB)	ANTENNA HEIGHT (m)	TABLE ANGLE (Degree)	RAW VALUE (dBuV)	CORRECTION FACTOR (dB/m)
1	#5626.40	59.0 PK	68.2	-9.2	1.14 H	309	52.9	6.1
2	*5745.00	119.1 PK			1.14 H	309	79.1	40.0
3	*5745.00	108.2 AV			1.14 H	309	68.2	40.0
4	#5987.20	59.0 PK	68.2	-9.2	1.14 H	309	52.3	6.7
5	11490.00	59.1 PK	74.0	-14.9	2.20 H	247	39.8	19.3
6	11490.00	46.2 AV	54.0	-7.8	2.20 H	247	26.9	19.3

ANTENNA POLARITY & TEST DISTANCE: VERTICAL AT 3 M								
NO.	FREQ. (MHz)	EMISSION LEVEL (dBuV/m)	LIMIT (dBuV/m)	MARGIN (dB)	ANTENNA HEIGHT (m)	TABLE ANGLE (Degree)	RAW VALUE (dBuV)	CORRECTION FACTOR (dB/m)
1	#5627.20	58.2 PK	68.2	-10.0	1.00 V	1	52.1	6.1
2	*5745.00	118.6 PK			1.00 V	1	78.6	40.0
3	*5745.00	108.1 AV			1.00 V	1	68.1	40.0
4	#5982.40	58.3 PK	68.2	-9.9	1.00 V	1	51.6	6.7
5	11490.00	58.9 PK	74.0	-15.1	1.34 V	252	39.6	19.3
6	11490.00	45.8 AV	54.0	-8.2	1.34 V	252	26.5	19.3

Remarks:

1. Emission Level(dBuV/m) = Raw Value(dBuV) + Correction Factor(dB/m)
2. Correction Factor(dB/m) = Antenna Factor(dB/m) + Cable Factor(dB) – Pre-Amplifier Factor(dB)
3. The other emission levels were very low against the limit.
4. Margin value = Emission Level – Limit value
5. " * ": Fundamental frequency.
6. " # ": The radiated frequency is out of the restricted band.

CHANNEL	TX Channel 157	DETECTOR FUNCTION	Peak (PK)
FREQUENCY RANGE	1GHz ~ 40GHz		Average (AV)

ANTENNA POLARITY & TEST DISTANCE: HORIZONTAL AT 3 M

NO.	FREQ. (MHz)	EMISSION LEVEL (dBuV/m)	LIMIT (dBuV/m)	MARGIN (dB)	ANTENNA HEIGHT (m)	TABLE ANGLE (Degree)	RAW VALUE (dBuV)	CORRECTION FACTOR (dB/m)
1	#5632.00	57.7 PK	68.2	-10.5	1.23 H	319	51.6	6.1
2	*5785.00	119.9 PK			1.23 H	319	79.8	40.1
3	*5785.00	109.1 AV			1.23 H	319	69.0	40.1
4	#5934.40	58.4 PK	68.2	-9.8	1.23 H	319	51.8	6.6
5	11570.00	63.0 PK	74.0	-11.0	2.74 H	260	43.8	19.2
6	11570.00	50.2 AV	54.0	-3.8	2.74 H	260	31.0	19.2

ANTENNA POLARITY & TEST DISTANCE: VERTICAL AT 3 M

NO.	FREQ. (MHz)	EMISSION LEVEL (dBuV/m)	LIMIT (dBuV/m)	MARGIN (dB)	ANTENNA HEIGHT (m)	TABLE ANGLE (Degree)	RAW VALUE (dBuV)	CORRECTION FACTOR (dB/m)
1	#5620.80	58.8 PK	68.2	-9.4	1.00 V	7	52.7	6.1
2	*5785.00	117.4 PK			1.00 V	7	77.3	40.1
3	*5785.00	107.1 AV			1.00 V	7	67.0	40.1
4	#5956.80	58.4 PK	68.2	-9.8	1.00 V	7	51.8	6.6
5	11570.00	62.3 PK	74.0	-11.7	2.40 V	300	43.1	19.2
6	11570.00	49.1 AV	54.0	-4.9	2.40 V	300	29.9	19.2

Remarks:

1. Emission Level(dBuV/m) = Raw Value(dBuV) + Correction Factor(dB/m)
2. Correction Factor(dB/m) = Antenna Factor(dB/m) + Cable Factor(dB) – Pre-Amplifier Factor(dB)
3. The other emission levels were very low against the limit.
4. Margin value = Emission Level – Limit value
5. " * ": Fundamental frequency.

CHANNEL	TX Channel 165	DETECTOR FUNCTION	Peak (PK)
FREQUENCY RANGE	1GHz ~ 40GHz		Average (AV)

ANTENNA POLARITY & TEST DISTANCE: HORIZONTAL AT 3 M

NO.	FREQ. (MHz)	EMISSION LEVEL (dBuV/m)	LIMIT (dBuV/m)	MARGIN (dB)	ANTENNA HEIGHT (m)	TABLE ANGLE (Degree)	RAW VALUE (dBuV)	CORRECTION FACTOR (dB/m)
1	#5628.00	57.8 PK	68.2	-10.4	1.59 H	315	51.7	6.1
2	*5825.00	120.2 PK			1.59 H	315	80.1	40.1
3	*5825.00	109.1 AV			1.59 H	315	69.0	40.1
4	#5982.40	58.5 PK	68.2	-9.7	1.59 H	315	51.8	6.7
5	11650.00	60.4 PK	74.0	-13.6	2.54 H	269	41.1	19.3
6	11650.00	47.5 AV	54.0	-6.5	2.54 H	269	28.2	19.3

ANTENNA POLARITY & TEST DISTANCE: VERTICAL AT 3 M

NO.	FREQ. (MHz)	EMISSION LEVEL (dBuV/m)	LIMIT (dBuV/m)	MARGIN (dB)	ANTENNA HEIGHT (m)	TABLE ANGLE (Degree)	RAW VALUE (dBuV)	CORRECTION FACTOR (dB/m)
1	#5600.80	57.5 PK	68.2	-10.7	1.00 V	6	51.4	6.1
2	*5825.00	117.1 PK			1.00 V	6	77.0	40.1
3	*5825.00	106.5 AV			1.00 V	6	66.4	40.1
4	#5956.80	58.4 PK	68.2	-9.8	1.00 V	6	51.8	6.6
5	11650.00	59.8 PK	74.0	-14.2	2.55 V	250	40.5	19.3
6	11650.00	47.1 AV	54.0	-6.9	2.55 V	250	27.8	19.3

Remarks:

1. Emission Level(dBuV/m) = Raw Value(dBuV) + Correction Factor(dB/m)
2. Correction Factor(dB/m) = Antenna Factor(dB/m) + Cable Factor(dB) – Pre-Amplifier Factor(dB)
3. The other emission levels were very low against the limit.
4. Margin value = Emission Level – Limit value
5. " * ": Fundamental frequency.
6. " # ": The radiated frequency is out of the restricted band.

802.11n (HT40)

CHANNEL	TX Channel 38	DETECTOR FUNCTION	Peak (PK) Average (AV)
FREQUENCY RANGE	1GHz ~ 40GHz		

ANTENNA POLARITY & TEST DISTANCE: HORIZONTAL AT 3 M

NO.	FREQ. (MHz)	EMISSION LEVEL (dBuV/m)	LIMIT (dBuV/m)	MARGIN (dB)	ANTENNA HEIGHT (m)	TABLE ANGLE (Degree)	RAW VALUE (dBuV)	CORRECTION FACTOR (dB/m)
1	5150.00	68.2 PK	74.0	-5.8	2.47 H	297	63.4	4.8
2	5150.00	52.6 AV	54.0	-1.4	2.47 H	297	47.8	4.8
3	*5190.00	111.5 PK			2.44 H	298	72.8	38.7
4	*5190.00	102.1 AV			2.44 H	298	63.4	38.7
5	#10380.00	59.4 PK	74.0	-14.6	2.54 H	336	41.8	17.6
6	#10380.00	46.5 AV	54.0	-7.5	2.54 H	336	28.9	17.6

ANTENNA POLARITY & TEST DISTANCE: VERTICAL AT 3 M

NO.	FREQ. (MHz)	EMISSION LEVEL (dBuV/m)	LIMIT (dBuV/m)	MARGIN (dB)	ANTENNA HEIGHT (m)	TABLE ANGLE (Degree)	RAW VALUE (dBuV)	CORRECTION FACTOR (dB/m)
1	5150.00	64.0 PK	74.0	-10.0	1.69 V	346	59.2	4.8
2	5150.00	47.2 AV	54.0	-6.8	1.69 V	346	42.4	4.8
3	*5190.00	107.6 PK			1.78 V	342	68.9	38.7
4	*5190.00	98.1 AV			1.78 V	342	59.4	38.7
5	#10380.00	59.8 PK	74.0	-14.2	1.87 V	286	42.2	17.6
6	#10380.00	46.3 AV	54.0	-7.7	1.87 V	286	28.7	17.6

Remarks:

1. Emission Level(dBuV/m) = Raw Value(dBuV) + Correction Factor(dB/m)
2. Correction Factor(dB/m) = Antenna Factor(dB/m) + Cable Factor(dB) – Pre-Amplifier Factor(dB)
3. The other emission levels were very low against the limit.
4. Margin value = Emission Level – Limit value
5. " * ": Fundamental frequency.
6. " # ": The radiated frequency is out of the restricted band.

CHANNEL	TX Channel 46	DETECTOR FUNCTION	Peak (PK)
FREQUENCY RANGE	1GHz ~ 40GHz		Average (AV)

ANTENNA POLARITY & TEST DISTANCE: HORIZONTAL AT 3 M								
NO.	FREQ. (MHz)	EMISSION LEVEL (dBuV/m)	LIMIT (dBuV/m)	MARGIN (dB)	ANTENNA HEIGHT (m)	TABLE ANGLE (Degree)	RAW VALUE (dBuV)	CORRECTION FACTOR (dB/m)
1	5150.00	67.1 PK	74.0	-6.9	2.43 H	301	62.3	4.8
2	5150.00	52.6 AV	54.0	-1.4	2.43 H	301	47.8	4.8
3	*5230.00	115.1 PK			2.54 H	297	76.2	38.9
4	*5230.00	105.2 AV			2.54 H	297	66.3	38.9
5	#10460.00	60.1 PK	74.0	-13.9	2.47 H	114	41.9	18.2
6	#10460.00	46.8 AV	54.0	-7.2	2.47 H	114	28.6	18.2

ANTENNA POLARITY & TEST DISTANCE: VERTICAL AT 3 M								
NO.	FREQ. (MHz)	EMISSION LEVEL (dBuV/m)	LIMIT (dBuV/m)	MARGIN (dB)	ANTENNA HEIGHT (m)	TABLE ANGLE (Degree)	RAW VALUE (dBuV)	CORRECTION FACTOR (dB/m)
1	5150.00	61.6 PK	74.0	-12.4	1.67 V	343	56.8	4.8
2	5150.00	46.2 AV	54.0	-7.8	1.67 V	343	41.4	4.8
3	*5230.00	112.4 PK			1.83 V	348	73.5	38.9
4	*5230.00	102.6 AV			1.83 V	348	63.7	38.9
5	#10460.00	60.2 PK	74.0	-13.8	1.68 V	63	42.0	18.2
6	#10460.00	46.6 AV	54.0	-7.4	1.68 V	63	28.4	18.2

Remarks:

1. Emission Level(dBuV/m) = Raw Value(dBuV) + Correction Factor(dB/m)
2. Correction Factor(dB/m) = Antenna Factor(dB/m) + Cable Factor(dB) – Pre-Amplifier Factor(dB)
3. The other emission levels were very low against the limit.
4. Margin value = Emission Level – Limit value
5. " * ": Fundamental frequency.
6. " # ": The radiated frequency is out of the restricted band.

CHANNEL	TX Channel 151	DETECTOR FUNCTION	Peak (PK)
FREQUENCY RANGE	1GHz ~ 40GHz		Average (AV)

ANTENNA POLARITY & TEST DISTANCE: HORIZONTAL AT 3 M

NO.	FREQ. (MHz)	EMISSION LEVEL (dBuV/m)	LIMIT (dBuV/m)	MARGIN (dB)	ANTENNA HEIGHT (m)	TABLE ANGLE (Degree)	RAW VALUE (dBuV)	CORRECTION FACTOR (dB/m)
1	#5640.80	61.0 PK	68.2	-7.2	1.23 H	320	54.9	6.1
2	*5755.00	117.1 PK			1.23 H	320	77.1	40.0
3	*5755.00	106.9 AV			1.23 H	320	66.9	40.0
4	#5936.80	58.5 PK	68.2	-9.7	1.23 H	320	51.9	6.6
5	11510.00	58.9 PK	74.0	-15.1	1.96 H	279	39.6	19.3
6	11510.00	46.5 AV	54.0	-7.5	1.96 H	279	27.2	19.3

ANTENNA POLARITY & TEST DISTANCE: VERTICAL AT 3 M

NO.	FREQ. (MHz)	EMISSION LEVEL (dBuV/m)	LIMIT (dBuV/m)	MARGIN (dB)	ANTENNA HEIGHT (m)	TABLE ANGLE (Degree)	RAW VALUE (dBuV)	CORRECTION FACTOR (dB/m)
1	#5644.00	61.9 PK	68.2	-6.3	1.09 V	5	55.8	6.1
2	*5755.00	115.7 PK			1.09 V	5	75.7	40.0
3	*5755.00	105.8 AV			1.09 V	5	65.8	40.0
4	#5934.40	58.5 PK	68.2	-9.7	1.09 V	5	51.9	6.6
5	11510.00	59.8 PK	74.0	-14.2	1.78 V	261	40.5	19.3
6	11510.00	47.0 AV	54.0	-7.0	1.78 V	261	27.7	19.3

Remarks:

1. Emission Level(dBuV/m) = Raw Value(dBuV) + Correction Factor(dB/m)
2. Correction Factor(dB/m) = Antenna Factor(dB/m) + Cable Factor(dB) – Pre-Amplifier Factor(dB)
3. The other emission levels were very low against the limit.
4. Margin value = Emission Level – Limit value
5. " * ": Fundamental frequency.
6. " # ": The radiated frequency is out of the restricted band.

CHANNEL	TX Channel 159	DETECTOR FUNCTION	Peak (PK)
FREQUENCY RANGE	1GHz ~ 40GHz		Average (AV)

ANTENNA POLARITY & TEST DISTANCE: HORIZONTAL AT 3 M								
NO.	FREQ. (MHz)	EMISSION LEVEL (dBuV/m)	LIMIT (dBuV/m)	MARGIN (dB)	ANTENNA HEIGHT (m)	TABLE ANGLE (Degree)	RAW VALUE (dBuV)	CORRECTION FACTOR (dB/m)
1	#5632.00	58.5 PK	68.2	-9.7	1.08 H	308	52.4	6.1
2	*5795.00	117.7 PK			1.08 H	308	77.6	40.1
3	*5795.00	107.6 AV			1.08 H	308	67.5	40.1
4	#5932.00	61.4 PK	68.2	-6.8	1.08 H	308	54.8	6.6
5	11590.00	59.4 PK	74.0	-14.6	1.59 H	271	40.2	19.2
6	11590.00	47.3 AV	54.0	-6.7	1.59 H	271	28.1	19.2

ANTENNA POLARITY & TEST DISTANCE: VERTICAL AT 3 M								
NO.	FREQ. (MHz)	EMISSION LEVEL (dBuV/m)	LIMIT (dBuV/m)	MARGIN (dB)	ANTENNA HEIGHT (m)	TABLE ANGLE (Degree)	RAW VALUE (dBuV)	CORRECTION FACTOR (dB/m)
1	#5609.60	57.5 PK	68.2	-10.7	1.00 V	8	51.4	6.1
2	*5795.00	115.5 PK			1.00 V	8	75.4	40.1
3	*5795.00	105.5 AV			1.00 V	8	65.4	40.1
4	#5930.40	60.0 PK	68.2	-8.2	1.00 V	8	53.4	6.6
5	11590.00	60.2 PK	74.0	-13.8	1.85 V	285	41.0	19.2
6	11590.00	46.9 AV	54.0	-7.1	1.85 V	285	27.7	19.2

Remarks:

1. Emission Level(dBuV/m) = Raw Value(dBuV) + Correction Factor(dB/m)
2. Correction Factor(dB/m) = Antenna Factor(dB/m) + Cable Factor(dB) – Pre-Amplifier Factor(dB)
3. The other emission levels were very low against the limit.
4. Margin value = Emission Level – Limit value
5. " * ": Fundamental frequency.
6. " # ": The radiated frequency is out of the restricted band.

802.11ac (VHT80)

CHANNEL	TX Channel 42	DETECTOR FUNCTION	Peak (PK) Average (AV)
FREQUENCY RANGE	1GHz ~ 40GHz		

ANTENNA POLARITY & TEST DISTANCE: HORIZONTAL AT 3 M

NO.	FREQ. (MHz)	EMISSION LEVEL (dBuV/m)	LIMIT (dBuV/m)	MARGIN (dB)	ANTENNA HEIGHT (m)	TABLE ANGLE (Degree)	RAW VALUE (dBuV)	CORRECTION FACTOR (dB/m)
1	5150.00	67.2 PK	74.0	-6.8	2.42 H	299	62.4	4.8
2	5150.00	52.6 AV	54.0	-1.4	2.42 H	299	47.8	4.8
3	*5210.00	107.5 PK			2.40 H	291	68.8	38.7
4	*5210.00	97.4 AV			2.40 H	291	58.7	38.7
5	5350.00	58.3 PK	74.0	-15.7	2.45 H	302	52.8	5.5
6	5350.00	45.5 AV	54.0	-8.5	2.45 H	302	40.0	5.5
7	#10420.00	59.8 PK	74.0	-14.2	1.82 H	135	42.0	17.8
8	#10420.00	46.6 AV	54.0	-7.4	1.82 H	135	28.8	17.8

ANTENNA POLARITY & TEST DISTANCE: VERTICAL AT 3 M

NO.	FREQ. (MHz)	EMISSION LEVEL (dBuV/m)	LIMIT (dBuV/m)	MARGIN (dB)	ANTENNA HEIGHT (m)	TABLE ANGLE (Degree)	RAW VALUE (dBuV)	CORRECTION FACTOR (dB/m)
1	5150.00	61.4 PK	74.0	-12.6	1.70 V	348	56.6	4.8
2	5150.00	48.7 AV	54.0	-5.3	1.70 V	348	43.9	4.8
3	*5210.00	103.4 PK			1.72 V	346	64.7	38.7
4	*5210.00	94.3 AV			1.72 V	346	55.6	38.7
5	5350.00	57.7 PK	74.0	-16.3	1.77 V	352	52.2	5.5
6	5350.00	44.6 AV	54.0	-9.4	1.77 V	352	39.1	5.5
7	#10420.00	59.5 PK	74.0	-14.5	2.55 V	87	41.7	17.8
8	#10420.00	46.6 AV	54.0	-7.4	2.55 V	87	28.8	17.8

Remarks:

1. Emission Level(dBuV/m) = Raw Value(dBuV) + Correction Factor(dB/m)
2. Correction Factor(dB/m) = Antenna Factor(dB/m) + Cable Factor(dB) – Pre-Amplifier Factor(dB)
3. The other emission levels were very low against the limit.
4. Margin value = Emission Level – Limit value
5. " * ": Fundamental frequency.
6. " # ": The radiated frequency is out of the restricted band.

CHANNEL	TX Channel 155	DETECTOR FUNCTION	Peak (PK)
FREQUENCY RANGE	1GHz ~ 40GHz		Average (AV)

ANTENNA POLARITY & TEST DISTANCE: HORIZONTAL AT 3 M								
NO.	FREQ. (MHz)	EMISSION LEVEL (dBuV/m)	LIMIT (dBuV/m)	MARGIN (dB)	ANTENNA HEIGHT (m)	TABLE ANGLE (Degree)	RAW VALUE (dBuV)	CORRECTION FACTOR (dB/m)
1	#5635.20	66.4 PK	68.2	-1.8	1.14 H	311	60.3	6.1
2	*5775.00	110.2 PK			1.14 H	311	70.2	40.0
3	*5775.00	100.5 AV			1.14 H	311	60.5	40.0
4	#5927.20	64.0 PK	68.2	-4.2	1.14 H	311	57.4	6.6
5	11550.00	60.4 PK	74.0	-13.6	2.00 H	286	41.2	19.2
6	11550.00	47.1 AV	54.0	-6.9	2.00 H	286	27.9	19.2

ANTENNA POLARITY & TEST DISTANCE: VERTICAL AT 3 M								
NO.	FREQ. (MHz)	EMISSION LEVEL (dBuV/m)	LIMIT (dBuV/m)	MARGIN (dB)	ANTENNA HEIGHT (m)	TABLE ANGLE (Degree)	RAW VALUE (dBuV)	CORRECTION FACTOR (dB/m)
1	#5642.40	64.4 PK	68.2	-3.8	1.00 V	5	58.3	6.1
2	*5775.00	108.5 PK			1.00 V	5	68.5	40.0
3	*5775.00	98.5 AV			1.00 V	5	58.5	40.0
4	#5930.40	62.6 PK	68.2	-5.6	1.00 V	5	56.0	6.6
5	11550.00	59.5 PK	74.0	-14.5	1.64 V	241	40.3	19.2
6	11550.00	46.6 AV	54.0	-7.4	1.64 V	241	27.4	19.2

Remarks:

1. Emission Level(dBuV/m) = Raw Value(dBuV) + Correction Factor(dB/m)
2. Correction Factor(dB/m) = Antenna Factor(dB/m) + Cable Factor(dB) – Pre-Amplifier Factor(dB)
3. The other emission levels were very low against the limit.
4. Margin value = Emission Level – Limit value
5. " * ": Fundamental frequency.
6. " # ": The radiated frequency is out of the restricted band.

Test Mode C

802.11a

CHANNEL	TX Channel 36	DETECTOR FUNCTION	Peak (PK)
FREQUENCY RANGE	1GHz ~ 40GHz		Average (AV)

ANTENNA POLARITY & TEST DISTANCE: HORIZONTAL AT 3 M

NO.	FREQ. (MHz)	EMISSION LEVEL (dBuV/m)	LIMIT (dBuV/m)	MARGIN (dB)	ANTENNA HEIGHT (m)	TABLE ANGLE (Degree)	RAW VALUE (dBuV)	CORRECTION FACTOR (dB/m)
1	5150.00	66.2 PK	74.0	-7.8	1.79 H	175	61.4	4.8
2	5150.00	48.6 AV	54.0	-5.4	1.79 H	175	43.8	4.8
3	*5180.00	111.8 PK			1.84 H	169	73.1	38.7
4	*5180.00	101.9 AV			1.84 H	169	63.2	38.7
5	#10360.00	58.7 PK	74.0	-15.3	1.63 H	121	41.1	17.6
6	#10360.00	46.5 AV	54.0	-7.5	1.63 H	121	28.9	17.6

ANTENNA POLARITY & TEST DISTANCE: VERTICAL AT 3 M

NO.	FREQ. (MHz)	EMISSION LEVEL (dBuV/m)	LIMIT (dBuV/m)	MARGIN (dB)	ANTENNA HEIGHT (m)	TABLE ANGLE (Degree)	RAW VALUE (dBuV)	CORRECTION FACTOR (dB/m)
1	5150.00	69.9 PK	74.0	-4.1	1.43 V	348	65.1	4.8
2	5150.00	52.4 AV	54.0	-1.6	1.43 V	348	47.6	4.8
3	*5180.00	116.3 PK			1.52 V	347	77.6	38.7
4	*5180.00	106.0 AV			1.52 V	347	67.3	38.7
5	#10360.00	58.6 PK	74.0	-15.4	1.87 V	153	41.0	17.6
6	#10360.00	46.0 AV	54.0	-8.0	1.87 V	153	28.4	17.6

Remarks:

1. Emission Level(dBuV/m) = Raw Value(dBuV) + Correction Factor(dB/m)
2. Correction Factor(dB/m) = Antenna Factor(dB/m) + Cable Factor(dB) – Pre-Amplifier Factor(dB)
3. The other emission levels were very low against the limit.
4. Margin value = Emission Level – Limit value
5. " * ": Fundamental frequency.
6. " # ": The radiated frequency is out of the restricted band.

CHANNEL	TX Channel 40	DETECTOR FUNCTION	Peak (PK)
FREQUENCY RANGE	1GHz ~ 40GHz		Average (AV)

ANTENNA POLARITY & TEST DISTANCE: HORIZONTAL AT 3 M								
NO.	FREQ. (MHz)	EMISSION LEVEL (dBuV/m)	LIMIT (dBuV/m)	MARGIN (dB)	ANTENNA HEIGHT (m)	TABLE ANGLE (Degree)	RAW VALUE (dBuV)	CORRECTION FACTOR (dB/m)
1	*5200.00	114.5 PK			3.22 H	273	75.8	38.7
2	*5200.00	104.6 AV			3.22 H	273	65.9	38.7
3	#10400.00	59.1 PK	74.0	-14.9	1.69 H	52	41.5	17.6
4	#10400.00	46.5 AV	54.0	-7.5	1.69 H	52	28.9	17.6
ANTENNA POLARITY & TEST DISTANCE: VERTICAL AT 3 M								
NO.	FREQ. (MHz)	EMISSION LEVEL (dBuV/m)	LIMIT (dBuV/m)	MARGIN (dB)	ANTENNA HEIGHT (m)	TABLE ANGLE (Degree)	RAW VALUE (dBuV)	CORRECTION FACTOR (dB/m)
1	*5200.00	118.1 PK			1.50 V	9	79.4	38.7
2	*5200.00	107.8 AV			1.50 V	9	69.1	38.7
3	#10400.00	59.5 PK	74.0	-14.5	1.61 V	82	41.9	17.6
4	#10400.00	46.2 AV	54.0	-7.8	1.61 V	82	28.6	17.6

Remarks:

1. Emission Level(dBuV/m) = Raw Value(dBuV) + Correction Factor(dB/m)
2. Correction Factor(dB/m) = Antenna Factor(dB/m) + Cable Factor(dB) – Pre-Amplifier Factor(dB)
3. The other emission levels were very low against the limit.
4. Margin value = Emission Level – Limit value
5. " * ": Fundamental frequency.
6. " # ": The radiated frequency is out of the restricted band.

CHANNEL	TX Channel 48	DETECTOR FUNCTION	Peak (PK)
FREQUENCY RANGE	1GHz ~ 40GHz		Average (AV)

ANTENNA POLARITY & TEST DISTANCE: HORIZONTAL AT 3 M								
NO.	FREQ. (MHz)	EMISSION LEVEL (dBuV/m)	LIMIT (dBuV/m)	MARGIN (dB)	ANTENNA HEIGHT (m)	TABLE ANGLE (Degree)	RAW VALUE (dBuV)	CORRECTION FACTOR (dB/m)
1	*5240.00	114.9 PK			1.50 H	171	76.0	38.9
2	*5240.00	104.3 AV			1.50 H	171	65.4	38.9
3	5350.00	56.0 PK	74.0	-18.0	1.70 H	160	50.5	5.5
4	5350.00	43.7 AV	54.0	-10.3	1.70 H	160	38.2	5.5
5	#10480.00	59.3 PK	74.0	-14.7	1.55 H	107	40.9	18.4
6	#10480.00	46.6 AV	54.0	-7.4	1.55 H	107	28.2	18.4
ANTENNA POLARITY & TEST DISTANCE: VERTICAL AT 3 M								
NO.	FREQ. (MHz)	EMISSION LEVEL (dBuV/m)	LIMIT (dBuV/m)	MARGIN (dB)	ANTENNA HEIGHT (m)	TABLE ANGLE (Degree)	RAW VALUE (dBuV)	CORRECTION FACTOR (dB/m)
1	*5240.00	119.9 PK			1.48 V	351	81.0	38.9
2	*5240.00	109.2 AV			1.48 V	351	70.3	38.9
3	5350.00	56.6 PK	74.0	-17.4	1.60 V	335	51.1	5.5
4	5350.00	44.8 AV	54.0	-9.2	1.60 V	335	39.3	5.5
5	#10480.00	59.5 PK	74.0	-14.5	1.68 V	89	41.1	18.4
6	#10480.00	46.6 AV	54.0	-7.4	1.68 V	89	28.2	18.4

Remarks:

1. Emission Level(dBuV/m) = Raw Value(dBuV) + Correction Factor(dB/m)
2. Correction Factor(dB/m) = Antenna Factor(dB/m) + Cable Factor(dB) – Pre-Amplifier Factor(dB)
3. The other emission levels were very low against the limit.
4. Margin value = Emission Level – Limit value
5. " * ": Fundamental frequency.
6. " # ": The radiated frequency is out of the restricted band.

CHANNEL	TX Channel 149	DETECTOR FUNCTION	Peak (PK)
FREQUENCY RANGE	1GHz ~ 40GHz		Average (AV)

ANTENNA POLARITY & TEST DISTANCE: HORIZONTAL AT 3 M

NO.	FREQ. (MHz)	EMISSION LEVEL (dBuV/m)	LIMIT (dBuV/m)	MARGIN (dB)	ANTENNA HEIGHT (m)	TABLE ANGLE (Degree)	RAW VALUE (dBuV)	CORRECTION FACTOR (dB/m)
1	#5612.80	57.9 PK	68.2	-10.3	2.30 H	307	51.8	6.1
2	*5745.00	117.3 PK			2.30 H	307	77.3	40.0
3	*5745.00	106.3 AV			2.30 H	307	66.3	40.0
4	#5945.60	59.5 PK	68.2	-8.7	2.30 H	307	52.9	6.6
5	11490.00	61.5 PK	74.0	-12.5	2.87 H	291	42.2	19.3
6	11490.00	47.4 AV	54.0	-6.6	2.87 H	291	28.1	19.3

ANTENNA POLARITY & TEST DISTANCE: VERTICAL AT 3 M

NO.	FREQ. (MHz)	EMISSION LEVEL (dBuV/m)	LIMIT (dBuV/m)	MARGIN (dB)	ANTENNA HEIGHT (m)	TABLE ANGLE (Degree)	RAW VALUE (dBuV)	CORRECTION FACTOR (dB/m)
1	#5600.80	58.9 PK	68.2	-9.3	1.71 V	341	52.8	6.1
2	*5745.00	121.0 PK			1.71 V	341	81.0	40.0
3	*5745.00	111.1 AV			1.71 V	341	71.1	40.0
4	#5944.00	59.3 PK	68.2	-8.9	1.71 V	341	52.7	6.6
5	11490.00	61.1 PK	74.0	-12.9	2.36 V	118	41.8	19.3
6	11490.00	48.5 AV	54.0	-5.5	2.36 V	118	29.2	19.3

Remarks:

1. Emission Level(dBuV/m) = Raw Value(dBuV) + Correction Factor(dB/m)
2. Correction Factor(dB/m) = Antenna Factor(dB/m) + Cable Factor(dB) – Pre-Amplifier Factor(dB)
3. The other emission levels were very low against the limit.
4. Margin value = Emission Level – Limit value
5. " * ": Fundamental frequency.
6. " # ": The radiated frequency is out of the restricted band.

CHANNEL	TX Channel 157	DETECTOR FUNCTION	Peak (PK)
FREQUENCY RANGE	1GHz ~ 40GHz		Average (AV)

ANTENNA POLARITY & TEST DISTANCE: HORIZONTAL AT 3 M

NO.	FREQ. (MHz)	EMISSION LEVEL (dBuV/m)	LIMIT (dBuV/m)	MARGIN (dB)	ANTENNA HEIGHT (m)	TABLE ANGLE (Degree)	RAW VALUE (dBuV)	CORRECTION FACTOR (dB/m)
1	#5643.20	57.6 PK	68.2	-10.6	2.32 H	304	51.5	6.1
2	*5785.00	116.5 PK			2.32 H	304	76.4	40.1
3	*5785.00	106.0 AV			2.32 H	304	65.9	40.1
4	#5972.00	58.6 PK	68.2	-9.6	2.32 H	304	51.9	6.7
5	11570.00	60.5 PK	74.0	-13.5	2.41 H	284	41.3	19.2
6	11570.00	47.2 AV	54.0	-6.8	2.41 H	284	28.0	19.2

ANTENNA POLARITY & TEST DISTANCE: VERTICAL AT 3 M

NO.	FREQ. (MHz)	EMISSION LEVEL (dBuV/m)	LIMIT (dBuV/m)	MARGIN (dB)	ANTENNA HEIGHT (m)	TABLE ANGLE (Degree)	RAW VALUE (dBuV)	CORRECTION FACTOR (dB/m)
1	#5612.80	58.0 PK	68.2	-10.2	1.53 V	341	51.9	6.1
2	*5785.00	120.9 PK			1.53 V	341	80.8	40.1
3	*5785.00	110.5 AV			1.53 V	341	70.4	40.1
4	#5926.40	59.2 PK	68.2	-9.0	1.53 V	341	52.6	6.6
5	11570.00	61.8 PK	74.0	-12.2	2.44 V	227	42.6	19.2
6	11570.00	48.9 AV	54.0	-5.1	2.44 V	227	29.7	19.2

Remarks:

1. Emission Level(dBuV/m) = Raw Value(dBuV) + Correction Factor(dB/m)
2. Correction Factor(dB/m) = Antenna Factor(dB/m) + Cable Factor(dB) – Pre-Amplifier Factor(dB)
3. The other emission levels were very low against the limit.
4. Margin value = Emission Level – Limit value
5. " * ": Fundamental frequency.

CHANNEL	TX Channel 165	DETECTOR FUNCTION	Peak (PK)
FREQUENCY RANGE	1GHz ~ 40GHz		Average (AV)

ANTENNA POLARITY & TEST DISTANCE: HORIZONTAL AT 3 M

NO.	FREQ. (MHz)	EMISSION LEVEL (dBuV/m)	LIMIT (dBuV/m)	MARGIN (dB)	ANTENNA HEIGHT (m)	TABLE ANGLE (Degree)	RAW VALUE (dBuV)	CORRECTION FACTOR (dB/m)
1	#5606.40	57.3 PK	68.2	-10.9	2.32 H	307	51.2	6.1
2	*5825.00	115.7 PK			2.32 H	307	75.6	40.1
3	*5825.00	105.4 AV			2.32 H	307	65.3	40.1
4	#5941.60	58.5 PK	68.2	-9.7	2.32 H	307	51.9	6.6
5	11650.00	60.2 PK	74.0	-13.8	1.80 H	352	40.9	19.3
6	11650.00	47.3 AV	54.0	-6.7	1.80 H	352	28.0	19.3

ANTENNA POLARITY & TEST DISTANCE: VERTICAL AT 3 M

NO.	FREQ. (MHz)	EMISSION LEVEL (dBuV/m)	LIMIT (dBuV/m)	MARGIN (dB)	ANTENNA HEIGHT (m)	TABLE ANGLE (Degree)	RAW VALUE (dBuV)	CORRECTION FACTOR (dB/m)
1	#5610.40	58.0 PK	68.2	-10.2	1.53 V	310	51.9	6.1
2	*5825.00	121.3 PK			1.53 V	310	81.2	40.1
3	*5825.00	111.1 AV			1.53 V	310	71.0	40.1
4	#5928.00	59.1 PK	68.2	-9.1	1.53 V	310	52.5	6.6
5	11650.00	61.6 PK	74.0	-12.4	1.87 V	199	42.3	19.3
6	11650.00	47.9 AV	54.0	-6.1	1.87 V	199	28.6	19.3

Remarks:

1. Emission Level(dBuV/m) = Raw Value(dBuV) + Correction Factor(dB/m)
2. Correction Factor(dB/m) = Antenna Factor(dB/m) + Cable Factor(dB) – Pre-Amplifier Factor(dB)
3. The other emission levels were very low against the limit.
4. Margin value = Emission Level – Limit value
5. " * ": Fundamental frequency.
6. " # ": The radiated frequency is out of the restricted band.

802.11n (HT20)

CHANNEL	TX Channel 36	DETECTOR FUNCTION	Peak (PK) Average (AV)
FREQUENCY RANGE	1GHz ~ 40GHz		

ANTENNA POLARITY & TEST DISTANCE: HORIZONTAL AT 3 M

NO.	FREQ. (MHz)	EMISSION LEVEL (dBuV/m)	LIMIT (dBuV/m)	MARGIN (dB)	ANTENNA HEIGHT (m)	TABLE ANGLE (Degree)	RAW VALUE (dBuV)	CORRECTION FACTOR (dB/m)
1	5150.00	67.2 PK	74.0	-6.8	1.98 H	186	62.4	4.8
2	5150.00	49.3 AV	54.0	-4.7	1.98 H	186	44.5	4.8
3	*5180.00	113.1 PK			1.86 H	171	74.4	38.7
4	*5180.00	101.9 AV			1.86 H	171	63.2	38.7
5	#10360.00	58.8 PK	74.0	-15.2	1.73 H	118	41.2	17.6
6	#10360.00	45.6 AV	54.0	-8.4	1.73 H	118	28.0	17.6

ANTENNA POLARITY & TEST DISTANCE: VERTICAL AT 3 M

NO.	FREQ. (MHz)	EMISSION LEVEL (dBuV/m)	LIMIT (dBuV/m)	MARGIN (dB)	ANTENNA HEIGHT (m)	TABLE ANGLE (Degree)	RAW VALUE (dBuV)	CORRECTION FACTOR (dB/m)
1	5150.00	70.3 PK	74.0	-3.7	1.72 V	340	65.5	4.8
2	5150.00	52.2 AV	54.0	-1.8	1.72 V	340	47.4	4.8
3	*5180.00	116.5 PK			1.36 V	349	77.8	38.7
4	*5180.00	105.2 AV			1.36 V	349	66.5	38.7
5	#10360.00	58.6 PK	74.0	-15.4	1.43 V	261	41.0	17.6
6	#10360.00	46.1 AV	54.0	-7.9	1.43 V	261	28.5	17.6

Remarks:

1. Emission Level(dBuV/m) = Raw Value(dBuV) + Correction Factor(dB/m)
2. Correction Factor(dB/m) = Antenna Factor(dB/m) + Cable Factor(dB) – Pre-Amplifier Factor(dB)
3. The other emission levels were very low against the limit.
4. Margin value = Emission Level – Limit value
5. " * ": Fundamental frequency.
6. " # ": The radiated frequency is out of the restricted band.

CHANNEL	TX Channel 40	DETECTOR FUNCTION	Peak (PK)
FREQUENCY RANGE	1GHz ~ 40GHz		Average (AV)

ANTENNA POLARITY & TEST DISTANCE: HORIZONTAL AT 3 M								
NO.	FREQ. (MHz)	EMISSION LEVEL (dBuV/m)	LIMIT (dBuV/m)	MARGIN (dB)	ANTENNA HEIGHT (m)	TABLE ANGLE (Degree)	RAW VALUE (dBuV)	CORRECTION FACTOR (dB/m)
1	*5200.00	116.3 PK			1.78 H	170	77.6	38.7
2	*5200.00	105.0 AV			1.78 H	170	66.3	38.7
3	#10400.00	58.7 PK	74.0	-15.3	1.71 H	116	41.1	17.6
4	#10400.00	45.4 AV	54.0	-8.6	1.71 H	116	27.8	17.6
ANTENNA POLARITY & TEST DISTANCE: VERTICAL AT 3 M								
NO.	FREQ. (MHz)	EMISSION LEVEL (dBuV/m)	LIMIT (dBuV/m)	MARGIN (dB)	ANTENNA HEIGHT (m)	TABLE ANGLE (Degree)	RAW VALUE (dBuV)	CORRECTION FACTOR (dB/m)
1	*5200.00	119.2 PK			1.64 V	346	80.5	38.7
2	*5200.00	108.6 AV			1.64 V	346	69.9	38.7
3	#10400.00	59.4 PK	74.0	-14.6	1.53 V	242	41.8	17.6
4	#10400.00	45.9 AV	54.0	-8.1	1.53 V	242	28.3	17.6

Remarks:

1. Emission Level(dBuV/m) = Raw Value(dBuV) + Correction Factor(dB/m)
2. Correction Factor(dB/m) = Antenna Factor(dB/m) + Cable Factor(dB) – Pre-Amplifier Factor(dB)
3. The other emission levels were very low against the limit.
4. Margin value = Emission Level – Limit value
5. " * ": Fundamental frequency.
6. " # ": The radiated frequency is out of the restricted band.

CHANNEL	TX Channel 48	DETECTOR FUNCTION	Peak (PK)
FREQUENCY RANGE	1GHz ~ 40GHz		Average (AV)

ANTENNA POLARITY & TEST DISTANCE: HORIZONTAL AT 3 M

NO.	FREQ. (MHz)	EMISSION LEVEL (dBuV/m)	LIMIT (dBuV/m)	MARGIN (dB)	ANTENNA HEIGHT (m)	TABLE ANGLE (Degree)	RAW VALUE (dBuV)	CORRECTION FACTOR (dB/m)
1	*5240.00	116.8 PK			1.84 H	169	77.9	38.9
2	*5240.00	105.3 AV			1.84 H	169	66.4	38.9
3	5350.00	55.9 PK	74.0	-18.1	1.67 H	156	50.4	5.5
4	5350.00	43.5 AV	54.0	-10.5	1.67 H	156	38.0	5.5
5	#10480.00	59.1 PK	74.0	-14.9	1.75 H	134	40.7	18.4
6	#10480.00	46.4 AV	54.0	-7.6	1.75 H	134	28.0	18.4

ANTENNA POLARITY & TEST DISTANCE: VERTICAL AT 3 M

NO.	FREQ. (MHz)	EMISSION LEVEL (dBuV/m)	LIMIT (dBuV/m)	MARGIN (dB)	ANTENNA HEIGHT (m)	TABLE ANGLE (Degree)	RAW VALUE (dBuV)	CORRECTION FACTOR (dB/m)
1	*5240.00	119.6 PK			1.65 V	348	80.7	38.9
2	*5240.00	109.6 AV			1.65 V	348	70.7	38.9
3	5350.00	47.2 PK	74.0	-26.8	1.52 V	316	41.7	5.5
4	5350.00	44.8 AV	54.0	-9.2	1.52 V	316	39.3	5.5
5	#10480.00	59.2 PK	74.0	-14.8	1.64 V	228	40.8	18.4
6	#10480.00	46.1 AV	54.0	-7.9	1.64 V	228	27.7	18.4

Remarks:

1. Emission Level(dBuV/m) = Raw Value(dBuV) + Correction Factor(dB/m)
2. Correction Factor(dB/m) = Antenna Factor(dB/m) + Cable Factor(dB) – Pre-Amplifier Factor(dB)
3. The other emission levels were very low against the limit.
4. Margin value = Emission Level – Limit value
5. " * ": Fundamental frequency.
6. " # ": The radiated frequency is out of the restricted band.

CHANNEL	TX Channel 149	DETECTOR FUNCTION	Peak (PK)
FREQUENCY RANGE	1GHz ~ 40GHz		Average (AV)

ANTENNA POLARITY & TEST DISTANCE: HORIZONTAL AT 3 M

NO.	FREQ. (MHz)	EMISSION LEVEL (dBuV/m)	LIMIT (dBuV/m)	MARGIN (dB)	ANTENNA HEIGHT (m)	TABLE ANGLE (Degree)	RAW VALUE (dBuV)	CORRECTION FACTOR (dB/m)
1	#5645.60	57.6 PK	68.2	-10.6	2.36 H	306	51.5	6.1
2	*5745.00	116.6 PK			2.36 H	306	76.6	40.0
3	*5745.00	106.0 AV			2.36 H	306	66.0	40.0
4	#5927.20	57.9 PK	68.2	-10.3	2.36 H	306	51.3	6.6
5	11490.00	60.8 PK	74.0	-13.2	1.87 H	246	41.5	19.3
6	11490.00	47.7 AV	54.0	-6.3	1.87 H	246	28.4	19.3

ANTENNA POLARITY & TEST DISTANCE: VERTICAL AT 3 M

NO.	FREQ. (MHz)	EMISSION LEVEL (dBuV/m)	LIMIT (dBuV/m)	MARGIN (dB)	ANTENNA HEIGHT (m)	TABLE ANGLE (Degree)	RAW VALUE (dBuV)	CORRECTION FACTOR (dB/m)
1	#5630.40	59.1 PK	68.2	-9.1	1.53 V	326	53.0	6.1
2	*5745.00	120.8 PK			1.53 V	326	80.8	40.0
3	*5745.00	110.2 AV			1.53 V	326	70.2	40.0
4	#5964.00	59.3 PK	68.2	-8.9	1.53 V	326	52.6	6.7
5	11490.00	61.5 PK	74.0	-12.5	1.87 V	246	42.2	19.3
6	11490.00	48.5 AV	54.0	-5.5	1.87 V	246	29.2	19.3

Remarks:

1. Emission Level(dBuV/m) = Raw Value(dBuV) + Correction Factor(dB/m)
2. Correction Factor(dB/m) = Antenna Factor(dB/m) + Cable Factor(dB) – Pre-Amplifier Factor(dB)
3. The other emission levels were very low against the limit.
4. Margin value = Emission Level – Limit value
5. " * ": Fundamental frequency.
6. " # ": The radiated frequency is out of the restricted band.

CHANNEL	TX Channel 157	DETECTOR FUNCTION	Peak (PK)
FREQUENCY RANGE	1GHz ~ 40GHz		Average (AV)

ANTENNA POLARITY & TEST DISTANCE: HORIZONTAL AT 3 M

NO.	FREQ. (MHz)	EMISSION LEVEL (dBuV/m)	LIMIT (dBuV/m)	MARGIN (dB)	ANTENNA HEIGHT (m)	TABLE ANGLE (Degree)	RAW VALUE (dBuV)	CORRECTION FACTOR (dB/m)
1	#5608.00	57.7 PK	68.2	-10.5	2.52 H	307	51.6	6.1
2	*5785.00	116.2 PK			2.52 H	307	76.1	40.1
3	*5785.00	105.9 AV			2.52 H	307	65.8	40.1
4	#5932.80	59.2 PK	68.2	-9.0	2.52 H	307	52.6	6.6
5	11570.00	60.4 PK	74.0	-13.6	2.86 H	192	41.2	19.2
6	11570.00	47.3 AV	54.0	-6.7	2.86 H	192	28.1	19.2

ANTENNA POLARITY & TEST DISTANCE: VERTICAL AT 3 M

NO.	FREQ. (MHz)	EMISSION LEVEL (dBuV/m)	LIMIT (dBuV/m)	MARGIN (dB)	ANTENNA HEIGHT (m)	TABLE ANGLE (Degree)	RAW VALUE (dBuV)	CORRECTION FACTOR (dB/m)
1	#5640.80	57.8 PK	68.2	-10.4	1.53 V	340	51.7	6.1
2	*5785.00	121.8 PK			1.53 V	340	81.7	40.1
3	*5785.00	110.9 AV			1.53 V	340	70.8	40.1
4	#5935.20	59.0 PK	68.2	-9.2	1.53 V	340	52.4	6.6
5	11570.00	60.9 PK	74.0	-13.1	2.86 V	196	41.7	19.2
6	11570.00	48.2 AV	54.0	-5.8	2.86 V	196	29.0	19.2

Remarks:

1. Emission Level(dBuV/m) = Raw Value(dBuV) + Correction Factor(dB/m)
2. Correction Factor(dB/m) = Antenna Factor(dB/m) + Cable Factor(dB) – Pre-Amplifier Factor(dB)
3. The other emission levels were very low against the limit.
4. Margin value = Emission Level – Limit value
5. " * ": Fundamental frequency.

CHANNEL	TX Channel 165	DETECTOR FUNCTION	Peak (PK)
FREQUENCY RANGE	1GHz ~ 40GHz		Average (AV)

ANTENNA POLARITY & TEST DISTANCE: HORIZONTAL AT 3 M								
NO.	FREQ. (MHz)	EMISSION LEVEL (dBuV/m)	LIMIT (dBuV/m)	MARGIN (dB)	ANTENNA HEIGHT (m)	TABLE ANGLE (Degree)	RAW VALUE (dBuV)	CORRECTION FACTOR (dB/m)
1	#5638.40	58.2 PK	68.2	-10.0	2.58 H	305	52.1	6.1
2	*5825.00	115.5 PK			2.58 H	305	75.4	40.1
3	*5825.00	104.8 AV			2.58 H	305	64.7	40.1
4	#5945.60	57.9 PK	68.2	-10.3	2.58 H	305	51.3	6.6
5	11650.00	60.1 PK	74.0	-13.9	2.50 H	300	40.8	19.3
6	11650.00	47.0 AV	54.0	-7.0	2.50 H	300	27.7	19.3
ANTENNA POLARITY & TEST DISTANCE: VERTICAL AT 3 M								
NO.	FREQ. (MHz)	EMISSION LEVEL (dBuV/m)	LIMIT (dBuV/m)	MARGIN (dB)	ANTENNA HEIGHT (m)	TABLE ANGLE (Degree)	RAW VALUE (dBuV)	CORRECTION FACTOR (dB/m)
1	#5647.20	57.9 PK	68.2	-10.3	1.60 V	334	51.8	6.1
2	*5825.00	120.9 PK			1.60 V	334	80.8	40.1
3	*5825.00	110.6 AV			1.60 V	334	70.5	40.1
4	#5941.60	59.3 PK	68.2	-8.9	1.60 V	334	52.7	6.6
5	11650.00	61.5 PK	74.0	-12.5	1.98 V	191	42.2	19.3
6	11650.00	47.8 AV	54.0	-6.2	1.98 V	191	28.5	19.3

Remarks:

1. Emission Level(dBuV/m) = Raw Value(dBuV) + Correction Factor(dB/m)
2. Correction Factor(dB/m) = Antenna Factor(dB/m) + Cable Factor(dB) – Pre-Amplifier Factor(dB)
3. The other emission levels were very low against the limit.
4. Margin value = Emission Level – Limit value
5. " * ": Fundamental frequency.
6. " # ": The radiated frequency is out of the restricted band.

802.11n (HT40)

CHANNEL	TX Channel 38	DETECTOR FUNCTION	Peak (PK) Average (AV)
FREQUENCY RANGE	1GHz ~ 40GHz		

ANTENNA POLARITY & TEST DISTANCE: HORIZONTAL AT 3 M

NO.	FREQ. (MHz)	EMISSION LEVEL (dBuV/m)	LIMIT (dBuV/m)	MARGIN (dB)	ANTENNA HEIGHT (m)	TABLE ANGLE (Degree)	RAW VALUE (dBuV)	CORRECTION FACTOR (dB/m)
1	5150.00	64.9 PK	74.0	-9.1	1.91 H	173	60.1	4.8
2	5150.00	49.1 AV	54.0	-4.9	1.91 H	173	44.3	4.8
3	*5190.00	107.9 PK			1.81 H	170	69.2	38.7
4	*5190.00	98.2 AV			1.81 H	170	59.5	38.7
5	#10380.00	59.7 PK	74.0	-14.3	1.67 H	242	42.1	17.6
6	#10380.00	45.9 AV	54.0	-8.1	1.67 H	242	28.3	17.6

ANTENNA POLARITY & TEST DISTANCE: VERTICAL AT 3 M

NO.	FREQ. (MHz)	EMISSION LEVEL (dBuV/m)	LIMIT (dBuV/m)	MARGIN (dB)	ANTENNA HEIGHT (m)	TABLE ANGLE (Degree)	RAW VALUE (dBuV)	CORRECTION FACTOR (dB/m)
1	5150.00	68.7 PK	74.0	-5.3	1.41 V	349	63.9	4.8
2	5150.00	52.2 AV	54.0	-1.8	1.41 V	349	47.4	4.8
3	*5190.00	112.4 PK			1.50 V	347	73.7	38.7
4	*5190.00	102.6 AV			1.50 V	347	63.9	38.7
5	#10380.00	58.4 PK	74.0	-15.6	1.61 V	255	40.8	17.6
6	#10380.00	45.7 AV	54.0	-8.3	1.61 V	255	28.1	17.6

Remarks:

1. Emission Level(dBuV/m) = Raw Value(dBuV) + Correction Factor(dB/m)
2. Correction Factor(dB/m) = Antenna Factor(dB/m) + Cable Factor(dB) – Pre-Amplifier Factor(dB)
3. The other emission levels were very low against the limit.
4. Margin value = Emission Level – Limit value
5. " * ": Fundamental frequency.
6. " # ": The radiated frequency is out of the restricted band.

CHANNEL	TX Channel 46	DETECTOR FUNCTION	Peak (PK)
FREQUENCY RANGE	1GHz ~ 40GHz		Average (AV)

ANTENNA POLARITY & TEST DISTANCE: HORIZONTAL AT 3 M

NO.	FREQ. (MHz)	EMISSION LEVEL (dBuV/m)	LIMIT (dBuV/m)	MARGIN (dB)	ANTENNA HEIGHT (m)	TABLE ANGLE (Degree)	RAW VALUE (dBuV)	CORRECTION FACTOR (dB/m)
1	5150.00	60.7 PK	74.0	-13.3	1.26 H	339	55.9	4.8
2	5150.00	47.0 AV	54.0	-7.0	1.26 H	339	42.2	4.8
3	*5230.00	110.8 PK			1.56 H	344	71.9	38.9
4	*5230.00	101.3 AV			1.56 H	344	62.4	38.9
5	#10460.00	59.8 PK	74.0	-14.2	1.35 H	229	41.6	18.2
6	#10460.00	46.2 AV	54.0	-7.8	1.35 H	229	28.0	18.2

ANTENNA POLARITY & TEST DISTANCE: VERTICAL AT 3 M

NO.	FREQ. (MHz)	EMISSION LEVEL (dBuV/m)	LIMIT (dBuV/m)	MARGIN (dB)	ANTENNA HEIGHT (m)	TABLE ANGLE (Degree)	RAW VALUE (dBuV)	CORRECTION FACTOR (dB/m)
1	5150.00	66.8 PK	74.0	-7.2	1.47 V	349	62.0	4.8
2	5150.00	52.3 AV	54.0	-1.7	1.47 V	349	47.5	4.8
3	*5230.00	116.2 PK			1.67 V	348	77.3	38.9
4	*5230.00	106.5 AV			1.67 V	348	67.6	38.9
5	#10460.00	58.2 PK	74.0	-15.8	1.59 V	243	40.0	18.2
6	#10460.00	46.0 AV	54.0	-8.0	1.59 V	243	27.8	18.2

Remarks:

1. Emission Level(dBuV/m) = Raw Value(dBuV) + Correction Factor(dB/m)
2. Correction Factor(dB/m) = Antenna Factor(dB/m) + Cable Factor(dB) – Pre-Amplifier Factor(dB)
3. The other emission levels were very low against the limit.
4. Margin value = Emission Level – Limit value
5. " * ": Fundamental frequency.
6. " # ": The radiated frequency is out of the restricted band.

CHANNEL	TX Channel 151	DETECTOR FUNCTION	Peak (PK)
FREQUENCY RANGE	1GHz ~ 40GHz		Average (AV)

ANTENNA POLARITY & TEST DISTANCE: HORIZONTAL AT 3 M

NO.	FREQ. (MHz)	EMISSION LEVEL (dBuV/m)	LIMIT (dBuV/m)	MARGIN (dB)	ANTENNA HEIGHT (m)	TABLE ANGLE (Degree)	RAW VALUE (dBuV)	CORRECTION FACTOR (dB/m)
1	#5634.40	59.1 PK	68.2	-9.1	2.47 H	309	53.0	6.1
2	*5755.00	114.2 PK			2.47 H	309	74.2	40.0
3	*5755.00	104.4 AV			2.47 H	309	64.4	40.0
4	#5934.40	58.5 PK	68.2	-9.7	2.47 H	309	51.9	6.6
5	11510.00	60.2 PK	74.0	-13.8	1.86 H	267	40.9	19.3
6	11510.00	47.5 AV	54.0	-6.5	1.86 H	267	28.2	19.3

ANTENNA POLARITY & TEST DISTANCE: VERTICAL AT 3 M

NO.	FREQ. (MHz)	EMISSION LEVEL (dBuV/m)	LIMIT (dBuV/m)	MARGIN (dB)	ANTENNA HEIGHT (m)	TABLE ANGLE (Degree)	RAW VALUE (dBuV)	CORRECTION FACTOR (dB/m)
1	#5648.00	62.6 PK	68.2	-5.6	1.47 V	327	56.5	6.1
2	*5755.00	118.2 PK			1.47 V	327	78.2	40.0
3	*5755.00	109.1 AV			1.47 V	327	69.1	40.0
4	#5929.60	59.2 PK	68.2	-9.0	1.47 V	327	52.6	6.6
5	11510.00	61.2 PK	74.0	-12.8	1.89 V	163	41.9	19.3
6	11510.00	47.7 AV	54.0	-6.3	1.89 V	163	28.4	19.3

Remarks:

1. Emission Level(dBuV/m) = Raw Value(dBuV) + Correction Factor(dB/m)
2. Correction Factor(dB/m) = Antenna Factor(dB/m) + Cable Factor(dB) – Pre-Amplifier Factor(dB)
3. The other emission levels were very low against the limit.
4. Margin value = Emission Level – Limit value
5. " * ": Fundamental frequency.
6. " # ": The radiated frequency is out of the restricted band.

CHANNEL	TX Channel 159	DETECTOR FUNCTION	Peak (PK)
FREQUENCY RANGE	1GHz ~ 40GHz		Average (AV)

ANTENNA POLARITY & TEST DISTANCE: HORIZONTAL AT 3 M

NO.	FREQ. (MHz)	EMISSION LEVEL (dBuV/m)	LIMIT (dBuV/m)	MARGIN (dB)	ANTENNA HEIGHT (m)	TABLE ANGLE (Degree)	RAW VALUE (dBuV)	CORRECTION FACTOR (dB/m)
1	#5621.60	56.9 PK	68.2	-11.3	2.59 H	308	50.8	6.1
2	*5795.00	113.5 PK			2.59 H	308	73.4	40.1
3	*5795.00	103.3 AV			2.59 H	308	63.2	40.1
4	#5958.40	57.9 PK	68.2	-10.3	2.59 H	308	51.3	6.6
5	11590.00	60.5 PK	74.0	-13.5	1.76 H	138	41.3	19.2
6	11590.00	47.5 AV	54.0	-6.5	1.76 H	138	28.3	19.2

ANTENNA POLARITY & TEST DISTANCE: VERTICAL AT 3 M

NO.	FREQ. (MHz)	EMISSION LEVEL (dBuV/m)	LIMIT (dBuV/m)	MARGIN (dB)	ANTENNA HEIGHT (m)	TABLE ANGLE (Degree)	RAW VALUE (dBuV)	CORRECTION FACTOR (dB/m)
1	#5622.40	57.8 PK	68.2	-10.4	1.56 V	310	51.7	6.1
2	*5795.00	118.4 PK			1.56 V	310	78.3	40.1
3	*5795.00	108.5 AV			1.56 V	310	68.4	40.1
4	#5925.60	59.7 PK	68.2	-8.5	1.56 V	310	53.1	6.6
5	11590.00	60.4 PK	74.0	-13.6	1.82 V	173	41.2	19.2
6	11590.00	47.5 AV	54.0	-6.5	1.82 V	173	28.3	19.2

Remarks:

1. Emission Level(dBuV/m) = Raw Value(dBuV) + Correction Factor(dB/m)
2. Correction Factor(dB/m) = Antenna Factor(dB/m) + Cable Factor(dB) – Pre-Amplifier Factor(dB)
3. The other emission levels were very low against the limit.
4. Margin value = Emission Level – Limit value
5. " * ": Fundamental frequency.
6. " # ": The radiated frequency is out of the restricted band.

802.11ac (VHT80)

CHANNEL	TX Channel 42	DETECTOR FUNCTION	Peak (PK) Average (AV)
FREQUENCY RANGE	1GHz ~ 40GHz		

ANTENNA POLARITY & TEST DISTANCE: HORIZONTAL AT 3 M

NO.	FREQ. (MHz)	EMISSION LEVEL (dBuV/m)	LIMIT (dBuV/m)	MARGIN (dB)	ANTENNA HEIGHT (m)	TABLE ANGLE (Degree)	RAW VALUE (dBuV)	CORRECTION FACTOR (dB/m)
1	5150.00	63.5 PK	74.0	-10.5	2.24 H	180	58.7	4.8
2	5150.00	49.6 AV	54.0	-4.4	2.24 H	180	44.8	4.8
3	*5210.00	105.1 PK			1.76 H	170	66.4	38.7
4	*5210.00	95.0 AV			1.76 H	170	56.3	38.7
5	5350.00	56.9 PK	74.0	-17.1	1.47 H	173	51.4	5.5
6	5350.00	44.1 AV	54.0	-9.9	1.47 H	173	38.6	5.5
7	#10420.00	58.8 PK	74.0	-15.2	1.77 H	263	41.0	17.8
8	#10420.00	46.2 AV	54.0	-7.8	1.77 H	263	28.4	17.8

ANTENNA POLARITY & TEST DISTANCE: VERTICAL AT 3 M

NO.	FREQ. (MHz)	EMISSION LEVEL (dBuV/m)	LIMIT (dBuV/m)	MARGIN (dB)	ANTENNA HEIGHT (m)	TABLE ANGLE (Degree)	RAW VALUE (dBuV)	CORRECTION FACTOR (dB/m)
1	5150.00	65.0 PK	74.0	-9.0	1.52 V	347	60.2	4.8
2	5150.00	52.3 AV	54.0	-1.7	1.52 V	347	47.5	4.8
3	*5210.00	109.0 PK			1.71 V	348	70.3	38.7
4	*5210.00	98.5 AV			1.71 V	348	59.8	38.7
5	5350.00	58.3 PK	74.0	-15.7	1.53 V	333	52.8	5.5
6	5350.00	45.7 AV	54.0	-8.3	1.53 V	333	40.2	5.5
7	#10420.00	58.2 PK	74.0	-15.8	1.61 V	262	40.4	17.8
8	#10420.00	46.1 AV	54.0	-7.9	1.61 V	262	28.3	17.8

Remarks:

1. Emission Level(dBuV/m) = Raw Value(dBuV) + Correction Factor(dB/m)
2. Correction Factor(dB/m) = Antenna Factor(dB/m) + Cable Factor(dB) – Pre-Amplifier Factor(dB)
3. The other emission levels were very low against the limit.
4. Margin value = Emission Level – Limit value
5. " * ": Fundamental frequency.
6. " # ": The radiated frequency is out of the restricted band.

CHANNEL	TX Channel 155	DETECTOR FUNCTION	Peak (PK)
FREQUENCY RANGE	1GHz ~ 40GHz		Average (AV)

ANTENNA POLARITY & TEST DISTANCE: HORIZONTAL AT 3 M								
NO.	FREQ. (MHz)	EMISSION LEVEL (dBuV/m)	LIMIT (dBuV/m)	MARGIN (dB)	ANTENNA HEIGHT (m)	TABLE ANGLE (Degree)	RAW VALUE (dBuV)	CORRECTION FACTOR (dB/m)
1	#5646.40	60.2 PK	68.2	-8.0	1.63 H	98	54.1	6.1
2	#5649.00	61.3 PK	68.2	-6.9	1.62 H	106	55.2	6.1
3	*5775.00	103.8 PK			1.63 H	98	63.8	40.0
4	*5775.00	93.8 AV			1.63 H	98	53.8	40.0
5	#5927.00	57.5 PK	68.2	-10.7	1.65 H	108	50.9	6.6
6	#5946.40	58.2 PK	68.2	-10.0	1.63 H	98	51.6	6.6
7	11550.00	59.6 PK	74.0	-14.4	2.87 H	229	40.4	19.2
8	11550.00	47.4 AV	54.0	-6.6	2.87 H	229	28.2	19.2

ANTENNA POLARITY & TEST DISTANCE: VERTICAL AT 3 M								
NO.	FREQ. (MHz)	EMISSION LEVEL (dBuV/m)	LIMIT (dBuV/m)	MARGIN (dB)	ANTENNA HEIGHT (m)	TABLE ANGLE (Degree)	RAW VALUE (dBuV)	CORRECTION FACTOR (dB/m)
1	#5649.00	66.9 PK	68.2	-1.3	1.45 V	308	60.8	6.1
2	#5649.60	64.7 PK	68.2	-3.5	1.67 V	342	58.6	6.1
3	*5775.00	111.3 PK			1.67 V	342	71.3	40.0
4	*5775.00	101.6 AV			1.67 V	342	61.6	40.0
5	#5924.80	63.6 PK	68.3	-4.7	1.67 V	342	57.0	6.6
6	#5927.00	66.8 PK	68.2	-1.4	1.55 V	308	60.2	6.6
7	11550.00	60.3 PK	74.0	-13.7	1.76 V	228	41.1	19.2
8	11550.00	47.3 AV	54.0	-6.7	1.76 V	228	28.1	19.2

Remarks:

1. Emission Level(dBuV/m) = Raw Value(dBuV) + Correction Factor(dB/m)
2. Correction Factor(dB/m) = Antenna Factor(dB/m) + Cable Factor(dB) – Pre-Amplifier Factor(dB)
3. The other emission levels were very low against the limit.
4. Margin value = Emission Level – Limit value
5. " * ": Fundamental frequency.
6. " # ": The radiated frequency is out of the restricted band.

Below 1GHz Worst-Case Data:

802.11a

CHANNEL	TX Channel 36	DETECTOR FUNCTION	Quasi-Peak (QP)
FREQUENCY RANGE	9kHz ~ 1GHz		
TEST MODE	A		

ANTENNA POLARITY & TEST DISTANCE: HORIZONTAL AT 3 M

NO.	FREQ. (MHz)	EMISSION LEVEL (dBuV/m)	LIMIT (dBuV/m)	MARGIN (dB)	ANTENNA HEIGHT (m)	TABLE ANGLE (Degree)	RAW VALUE (dBuV)	CORRECTION FACTOR (dB/m)
1	57.12	27.4 QP	40.0	-12.6	2.00 H	91	41.9	-14.5
2	249.60	26.8 QP	46.0	-19.2	1.00 H	55	40.7	-13.9
3	360.43	36.3 QP	46.0	-9.7	1.00 H	158	47.1	-10.8
4	500.42	29.1 QP	46.0	-16.9	1.49 H	179	36.9	-7.8
5	714.29	36.1 QP	46.0	-9.9	1.49 H	226	39.5	-3.4
6	924.27	31.8 QP	46.0	-14.2	2.00 H	160	30.8	1.0

ANTENNA POLARITY & TEST DISTANCE: VERTICAL AT 3 M

NO.	FREQ. (MHz)	EMISSION LEVEL (dBuV/m)	LIMIT (dBuV/m)	MARGIN (dB)	ANTENNA HEIGHT (m)	TABLE ANGLE (Degree)	RAW VALUE (dBuV)	CORRECTION FACTOR (dB/m)
1	51.29	34.4 QP	40.0	-5.6	1.00 V	292	48.7	-14.3
2	125.17	29.1 QP	43.5	-14.4	1.00 V	10	44.9	-15.8
3	364.32	36.4 QP	46.0	-9.6	1.00 V	193	47.1	-10.7
4	498.47	27.4 QP	46.0	-18.6	1.00 V	285	35.2	-7.8
5	714.29	34.0 QP	46.0	-12.0	1.00 V	41	37.4	-3.4
6	965.10	32.6 QP	54.0	-21.4	1.51 V	226	31.2	1.4

Remarks:

1. Emission Level(dBuV/m) = Raw Value(dBuV) + Correction Factor(dB/m)
2. Correction Factor(dB/m) = Antenna Factor(dB/m) + Cable Factor(dB) – Pre-Amplifier Factor(dB)
3. The other emission levels were very low against the limit.
4. Margin value = Emission Level – Limit value

CHANNEL	TX Channel 36	DETECTOR FUNCTION	Quasi-Peak (QP)
FREQUENCY RANGE	9kHz ~ 1GHz		
TEST MODE	B		

ANTENNA POLARITY & TEST DISTANCE: HORIZONTAL AT 3 M

NO.	FREQ. (MHz)	EMISSION LEVEL (dBuV/m)	LIMIT (dBuV/m)	MARGIN (dB)	ANTENNA HEIGHT (m)	TABLE ANGLE (Degree)	RAW VALUE (dBuV)	CORRECTION FACTOR (dB/m)
1	80.45	34.7 QP	40.0	-5.3	1.49 H	275	53.2	-18.5
2	129.06	34.2 QP	43.5	-9.3	1.49 H	81	49.8	-15.6
3	364.32	39.6 QP	46.0	-6.4	1.00 H	267	50.3	-10.7
4	500.42	28.3 QP	46.0	-17.7	1.00 H	227	36.1	-7.8
5	644.30	28.0 QP	46.0	-18.0	1.00 H	318	32.4	-4.4
6	967.05	32.7 QP	54.0	-21.3	1.00 H	307	31.2	1.5

ANTENNA POLARITY & TEST DISTANCE: VERTICAL AT 3 M

NO.	FREQ. (MHz)	EMISSION LEVEL (dBuV/m)	LIMIT (dBuV/m)	MARGIN (dB)	ANTENNA HEIGHT (m)	TABLE ANGLE (Degree)	RAW VALUE (dBuV)	CORRECTION FACTOR (dB/m)
1	57.12	38.1 QP	40.0	-1.9	1.01 V	348	52.6	-14.5
2	79.67	35.4 QP	40.0	-4.6	1.00 V	132	53.8	-18.4
3	199.05	30.6 QP	43.5	-12.9	1.51 V	297	46.4	-15.8
4	360.43	36.4 QP	46.0	-9.6	1.51 V	283	47.2	-10.8
5	784.28	30.6 QP	46.0	-15.4	1.01 V	16	32.3	-1.7
6	908.72	31.9 QP	46.0	-14.1	1.51 V	12	31.1	0.8

Remarks:

1. Emission Level(dBuV/m) = Raw Value(dBuV) + Correction Factor(dB/m)
2. Correction Factor(dB/m) = Antenna Factor(dB/m) + Cable Factor(dB) – Pre-Amplifier Factor(dB)
3. The other emission levels were very low against the limit.
4. Margin value = Emission Level – Limit value

CHANNEL	TX Channel 36	DETECTOR FUNCTION	Quasi-Peak (QP)
FREQUENCY RANGE	9kHz ~ 1GHz		
TEST MODE	C		

ANTENNA POLARITY & TEST DISTANCE: HORIZONTAL AT 3 M

NO.	FREQ. (MHz)	EMISSION LEVEL (dBuV/m)	LIMIT (dBuV/m)	MARGIN (dB)	ANTENNA HEIGHT (m)	TABLE ANGLE (Degree)	RAW VALUE (dBuV)	CORRECTION FACTOR (dB/m)
1	57.12	27.6 QP	40.0	-12.4	2.00 H	74	42.1	-14.5
2	125.17	28.8 QP	43.5	-14.7	1.49 H	86	44.6	-15.8
3	206.83	26.1 QP	43.5	-17.4	1.00 H	167	42.0	-15.9
4	249.60	29.9 QP	46.0	-16.1	1.00 H	216	43.8	-13.9
5	304.04	32.5 QP	46.0	-13.5	1.00 H	208	44.4	-11.9
6	500.42	27.3 QP	46.0	-18.7	1.49 H	131	35.1	-7.8

ANTENNA POLARITY & TEST DISTANCE: VERTICAL AT 3 M

NO.	FREQ. (MHz)	EMISSION LEVEL (dBuV/m)	LIMIT (dBuV/m)	MARGIN (dB)	ANTENNA HEIGHT (m)	TABLE ANGLE (Degree)	RAW VALUE (dBuV)	CORRECTION FACTOR (dB/m)
1	51.29	36.0 QP	40.0	-4.0	1.00 V	259	50.3	-14.3
2	66.84	35.7 QP	40.0	-4.3	1.00 V	234	51.4	-15.7
3	173.78	31.1 QP	43.5	-12.4	1.00 V	109	45.1	-14.0
4	249.60	29.0 QP	46.0	-17.0	2.00 V	132	42.9	-13.9
5	321.54	26.9 QP	46.0	-19.1	1.51 V	307	38.4	-11.5
6	500.42	28.2 QP	46.0	-17.8	1.00 V	246	36.0	-7.8

Remarks:

1. Emission Level(dBuV/m) = Raw Value(dBuV) + Correction Factor(dB/m)
2. Correction Factor(dB/m) = Antenna Factor(dB/m) + Cable Factor(dB) – Pre-Amplifier Factor(dB)
3. The other emission levels were very low against the limit.
4. Margin value = Emission Level – Limit value

CHANNEL	TX Channel 36	DETECTOR FUNCTION	Quasi-Peak (QP)
FREQUENCY RANGE	9kHz ~ 1GHz		
TEST MODE	D		

ANTENNA POLARITY & TEST DISTANCE: HORIZONTAL AT 3 M

NO.	FREQ. (MHz)	EMISSION LEVEL (dBuV/m)	LIMIT (dBuV/m)	MARGIN (dB)	ANTENNA HEIGHT (m)	TABLE ANGLE (Degree)	RAW VALUE (dBuV)	CORRECTION FACTOR (dB/m)
1	76.56	36.3 QP	40.0	-3.7	1.99 H	141	53.9	-17.6
2	117.39	33.4 QP	43.5	-10.1	1.49 H	266	49.6	-16.2
3	169.89	28.9 QP	43.5	-14.6	1.49 H	241	42.8	-13.9
4	206.83	32.2 QP	43.5	-11.3	1.00 H	156	48.1	-15.9
5	337.10	36.0 QP	46.0	-10.0	1.00 H	140	47.2	-11.2
6	897.05	32.6 QP	46.0	-13.4	1.00 H	144	32.3	0.3

ANTENNA POLARITY & TEST DISTANCE: VERTICAL AT 3 M

NO.	FREQ. (MHz)	EMISSION LEVEL (dBuV/m)	LIMIT (dBuV/m)	MARGIN (dB)	ANTENNA HEIGHT (m)	TABLE ANGLE (Degree)	RAW VALUE (dBuV)	CORRECTION FACTOR (dB/m)
1	58.55	36.3 QP	40.0	-3.7	1.50 V	14	50.8	-14.5
2	78.13	37.9 QP	40.0	-2.1	1.00 V	187	56.0	-18.1
3	103.78	32.0 QP	43.5	-11.5	1.00 V	91	49.9	-17.9
4	257.38	31.3 QP	46.0	-14.7	1.50 V	283	45.0	-13.7
5	339.04	33.7 QP	46.0	-12.3	1.00 V	150	44.8	-11.1
6	899.00	34.8 QP	46.0	-11.2	1.00 V	128	34.5	0.3

Remarks:

1. Emission Level(dBuV/m) = Raw Value(dBuV) + Correction Factor(dB/m)
2. Correction Factor(dB/m) = Antenna Factor(dB/m) + Cable Factor(dB) – Pre-Amplifier Factor(dB)
3. The other emission levels were very low against the limit.
4. Margin value = Emission Level – Limit value

4.2 Conducted Emission Measurement

4.2.1 Limits of Conducted Emission Measurement

Frequency (MHz)	Conducted Limit (dBuV)	
	Quasi-peak	Average
0.15 - 0.5	66 - 56	56 - 46
0.50 - 5.0	56	46
5.0 - 30.0	60	50

- Note:** 1. The lower limit shall apply at the transition frequencies.
 2. The limit decreases in line with the logarithm of the frequency in the range of 0.15 to 0.50MHz.

4.2.2 Test Instruments

Description & Manufacturer	Model No.	Serial No.	Cal. Date	Cal. Due
Test Receiver ROHDE & SCHWARZ	ESCS 30	100288	Aug. 18, 2016	Aug. 17, 2017
RF signal cable (with 10dB PAD) Woken	5D-FB	Cable-cond2-01	Dec. 22, 2015	Dec. 21, 2016
			Dec. 22, 2016	Dec. 21, 2017
LISN ROHDE & SCHWARZ (EUT)	ESH2-Z5	100100	Jan. 17, 2016	Jan. 16, 2017
			Jan. 17, 2017	Jan. 16, 2018
LISN ROHDE & SCHWARZ (Peripheral)	ESH3-Z5	100312	Jul. 26, 2016	Jul. 25, 2017
Software ADT	BV ADT_Cond_ V7.3.7.3	NA	NA	NA

- Note:** 1. The calibration interval of the above test instruments is 12 months and the calibrations are traceable to NML/ROC and NIST/USA.
 2. The test was performed in HwaYa Shielded Room 2.
 3. The VCCI Site Registration No. is C-2047.

4.2.3 Test Procedures

- The EUT was placed 0.4 meters from the conducting wall of the shielded room with EUT being connected to the power mains through a line impedance stabilization network (LISN). Other support units were connected to the power mains through another LISN. The two LISNs provide 50 ohm/ 50uH of coupling impedance for the measuring instrument.
- Both lines of the power mains connected to the EUT were checked for maximum conducted interference.
- The frequency range from 150kHz to 30MHz was searched. Emission levels under (Limit - 20dB) was not recorded.

NOTE: The resolution bandwidth and video bandwidth of test receiver is 9kHz for quasi-peak detection (QP) and average detection (AV) at frequency 0.15MHz-30MHz.

4.2.4 Deviation from Test Standard

No deviation.

4.2.5 Test Setup

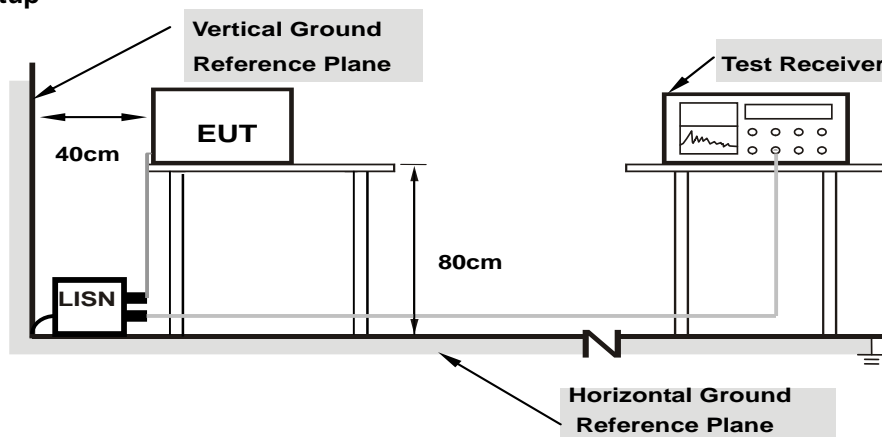

Note: 1.Support units were connected to second LISN.

For the actual test configuration, please refer to the attached file (Test Setup Photo).

4.2.6 EUT Operating Conditions

Same as 4.1.6.

4.2.7 Test Results

802.11a

Phase	Line (L)	Detector Function	Quasi-Peak (QP) / Average (AV)
Test Mode	A		

No	Freq. [MHz]	Corr. Factor (dB)	Reading Value		Emission Level		Limit		Margin	
			[dB (uV)]		[dB (uV)]		[dB (uV)]		(dB)	
			Q.P.	AV.	Q.P.	AV.	Q.P.	AV.	Q.P.	AV.
1	0.15391	10.01	36.99	20.09	47.00	30.10	65.79	55.79	-18.79	-25.69
2	0.20469	10.03	30.70	18.29	40.73	28.32	63.42	53.42	-22.69	-25.10
3	0.35313	10.03	36.53	30.71	46.56	40.74	58.89	48.89	-12.33	-8.15
4	0.54453	10.05	13.94	8.22	23.99	18.27	56.00	46.00	-32.01	-27.73
5	4.82813	10.16	14.09	6.47	24.25	16.63	56.00	46.00	-31.75	-29.37
6	8.80469	10.26	12.24	7.28	22.50	17.54	60.00	50.00	-37.50	-32.46

Remarks:

1. Q.P. and AV. are abbreviations of quasi-peak and average individually.
2. The emission levels of other frequencies were very low against the limit.
3. Margin value = Emission level - Limit value
4. Correction factor = Insertion loss + Cable loss
5. Emission Level = Correction Factor + Reading Value.

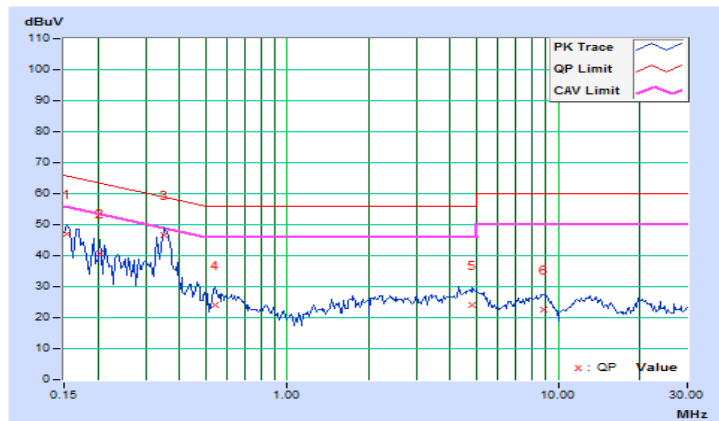

Phase	Neutral (N)	Detector Function	Quasi-Peak (QP) / Average (AV)
Test Mode	A		

No	Freq. [MHz]	Corr. Factor (dB)	Reading Value [dB (uV)]		Emission Level [dB (uV)]		Limit [dB (uV)]		Margin (dB)	
			Q.P.	AV.	Q.P.	AV.	Q.P.	AV.	Q.P.	AV.
			1	0.15391	10.01	37.19	21.77	47.20	31.78	65.79
2	0.19297	9.98	33.10	21.60	43.08	31.58	63.91	53.91	-20.83	-22.33
3	0.34922	10.02	34.62	27.15	44.64	37.17	58.98	48.98	-14.34	-11.81
4	0.65000	10.05	16.58	11.57	26.63	21.62	56.00	46.00	-29.37	-24.38
5	5.06641	10.26	13.30	5.43	23.56	15.69	60.00	50.00	-36.44	-34.31
6	8.53516	10.30	11.96	6.87	22.26	17.17	60.00	50.00	-37.74	-32.83

Remarks:

1. Q.P. and AV. are abbreviations of quasi-peak and average individually.
2. The emission levels of other frequencies were very low against the limit.
3. Margin value = Emission level - Limit value
4. Correction factor = Insertion loss + Cable loss
5. Emission Level = Correction Factor + Reading Value.

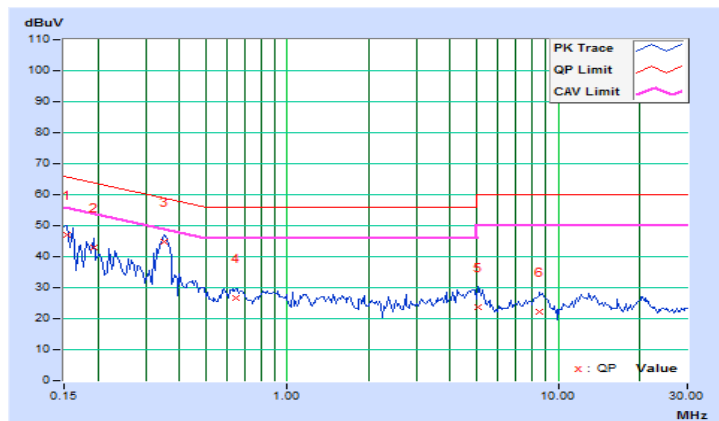

Phase	Line (L)	Detector Function	Quasi-Peak (QP) / Average (AV)
Test Mode	B		

No	Freq. [MHz]	Corr. Factor (dB)	Reading Value [dB (uV)]		Emission Level [dB (uV)]		Limit [dB (uV)]		Margin (dB)	
			Q.P.	AV.	Q.P.	AV.	Q.P.	AV.	Q.P.	AV.
			1	0.15391	10.01	36.58	22.13	46.59	32.14	65.79
2	0.45078	10.04	24.24	24.05	34.28	34.09	56.86	46.86	-22.58	-12.77
3	0.52500	10.05	37.37	32.95	47.42	43.00	56.00	46.00	-8.58	-3.00
4	0.76719	10.08	20.01	10.64	30.09	20.72	56.00	46.00	-25.91	-25.28
5	3.27734	10.13	25.54	20.50	35.67	30.63	56.00	46.00	-20.33	-15.37
6	12.24219	10.33	29.91	25.17	40.24	35.50	60.00	50.00	-19.76	-14.50

Remarks:

1. Q.P. and AV. are abbreviations of quasi-peak and average individually.
2. The emission levels of other frequencies were very low against the limit.
3. Margin value = Emission level - Limit value
4. Correction factor = Insertion loss + Cable loss
5. Emission Level = Correction Factor + Reading Value.

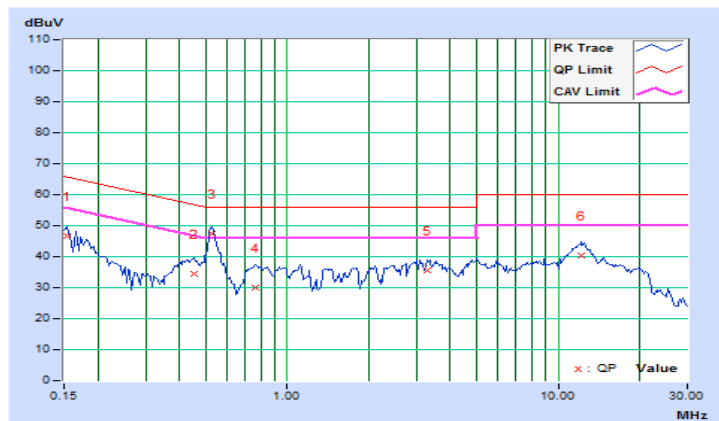

Phase	Neutral (N)	Detector Function	Quasi-Peak (QP) / Average (AV)
Test Mode	B		

No	Freq. [MHz]	Corr. Factor (dB)	Reading Value [dB (uV)]		Emission Level [dB (uV)]		Limit [dB (uV)]		Margin (dB)	
			Q.P.	AV.	Q.P.	AV.	Q.P.	AV.	Q.P.	AV.
			1	0.15391	10.01	36.40	22.11	46.41	32.12	65.79
2	0.17344	9.99	33.50	17.65	43.49	27.64	64.79	54.79	-21.30	-27.15
3	0.52109	10.04	37.52	32.93	47.56	42.97	56.00	46.00	-8.44	-3.03
4	0.64609	10.05	24.04	19.81	34.09	29.86	56.00	46.00	-21.91	-16.14
5	3.33203	10.21	22.71	16.99	32.92	27.20	56.00	46.00	-23.08	-18.80
6	12.08203	10.39	29.15	24.26	39.54	34.65	60.00	50.00	-20.46	-15.35

Remarks:

1. Q.P. and AV. are abbreviations of quasi-peak and average individually.
2. The emission levels of other frequencies were very low against the limit.
3. Margin value = Emission level - Limit value
4. Correction factor = Insertion loss + Cable loss
5. Emission Level = Correction Factor + Reading Value.

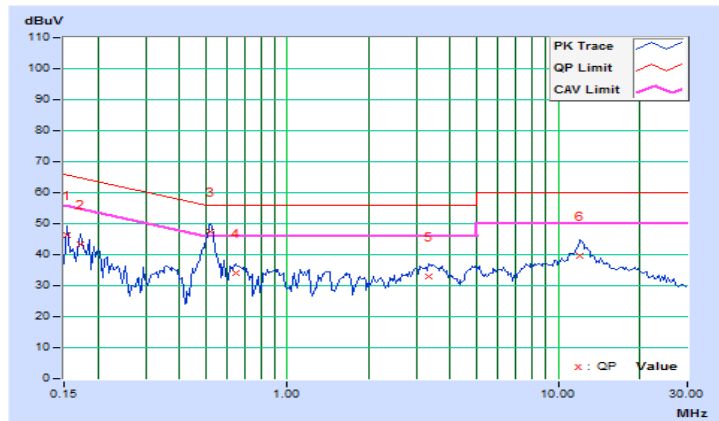

Phase	Line (L)	Detector Function	Quasi-Peak (QP) / Average (AV)
Test Mode	C		

No	Freq. [MHz]	Corr. Factor (dB)	Reading Value [dB (uV)]		Emission Level [dB (uV)]		Limit [dB (uV)]		Margin (dB)	
			Q.P.	AV.	Q.P.	AV.	Q.P.	AV.	Q.P.	AV.
			1	0.15000	10.01	36.94	18.67	46.95	28.68	66.00
2	0.18516	10.02	30.16	13.72	40.18	23.74	64.25	54.25	-24.07	-30.51
3	0.25547	10.03	24.57	13.48	34.60	23.51	61.58	51.58	-26.98	-28.07
4	0.34531	10.03	34.85	23.92	44.88	33.95	59.07	49.07	-14.19	-15.12
5	0.61094	10.06	12.07	3.21	22.13	13.27	56.00	46.00	-33.87	-32.73
6	13.06641	10.35	9.64	0.88	19.99	11.23	60.00	50.00	-40.01	-38.77

Remarks:

1. Q.P. and AV. are abbreviations of quasi-peak and average individually.
2. The emission levels of other frequencies were very low against the limit.
3. Margin value = Emission level - Limit value
4. Correction factor = Insertion loss + Cable loss
5. Emission Level = Correction Factor + Reading Value.

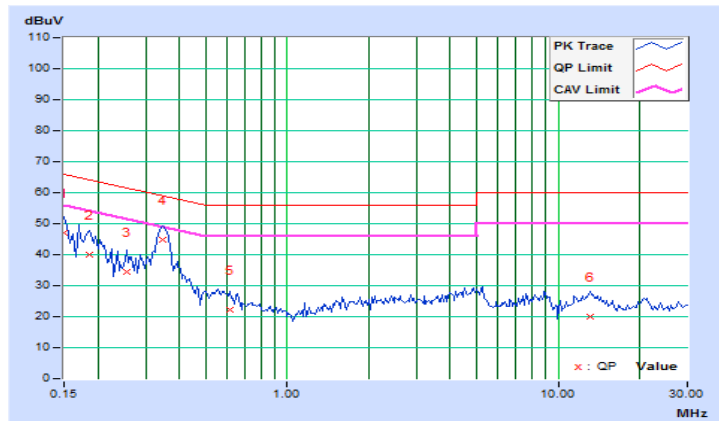

Phase	Neutral (N)	Detector Function	Quasi-Peak (QP) / Average (AV)
Test Mode	C		

No	Freq. [MHz]	Corr. Factor (dB)	Reading Value [dB (uV)]		Emission Level [dB (uV)]		Limit [dB (uV)]		Margin (dB)	
			Q.P.	AV.	Q.P.	AV.	Q.P.	AV.	Q.P.	AV.
			1	0.15000	10.02	36.43	18.31	46.45	28.33	66.00
2	0.18516	9.98	30.83	15.37	40.81	25.35	64.25	54.25	-23.44	-28.90
3	0.34141	10.02	33.40	23.21	43.42	33.23	59.17	49.17	-15.75	-15.94
4	0.54453	10.04	15.91	4.94	25.95	14.98	56.00	46.00	-30.05	-31.02
5	4.96094	10.26	12.90	1.68	23.16	11.94	56.00	46.00	-32.84	-34.06
6	8.60547	10.30	11.19	5.80	21.49	16.10	60.00	50.00	-38.51	-33.90

Remarks:

1. Q.P. and AV. are abbreviations of quasi-peak and average individually.
2. The emission levels of other frequencies were very low against the limit.
3. Margin value = Emission level - Limit value
4. Correction factor = Insertion loss + Cable loss
5. Emission Level = Correction Factor + Reading Value.

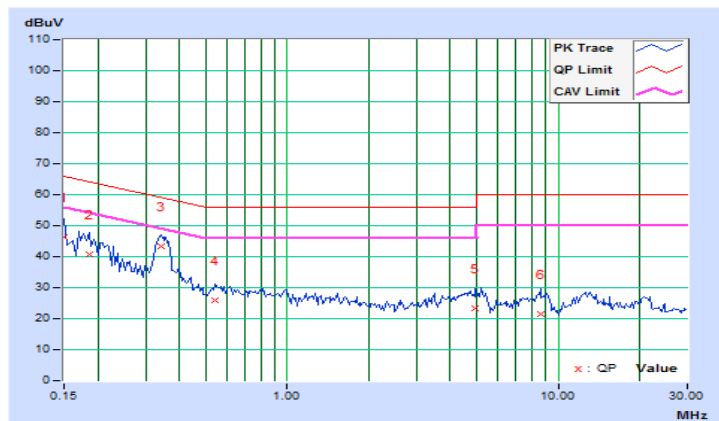

Phase	Line (L)	Detector Function	Quasi-Peak (QP) / Average (AV)
Test Mode	D		

No	Freq. [MHz]	Corr. Factor (dB)	Reading Value [dB (uV)]		Emission Level [dB (uV)]		Limit [dB (uV)]		Margin (dB)	
			Q.P.	AV.	Q.P.	AV.	Q.P.	AV.	Q.P.	AV.
			1	0.15000	10.01	37.79	23.36	47.80	33.37	66.00
2	0.37266	10.03	25.84	21.54	35.87	31.57	58.44	48.44	-22.57	-16.87
3	0.52500	10.05	37.86	32.95	47.91	43.00	56.00	46.00	-8.09	-3.00
4	0.69297	10.07	23.75	19.90	33.82	29.97	56.00	46.00	-22.18	-16.03
5	3.64453	10.13	24.72	20.25	34.85	30.38	56.00	46.00	-21.15	-15.62
6	10.21094	10.29	31.17	26.41	41.46	36.70	60.00	50.00	-18.54	-13.30

Remarks:

1. Q.P. and AV. are abbreviations of quasi-peak and average individually.
2. The emission levels of other frequencies were very low against the limit.
3. Margin value = Emission level - Limit value
4. Correction factor = Insertion loss + Cable loss
5. Emission Level = Correction Factor + Reading Value.

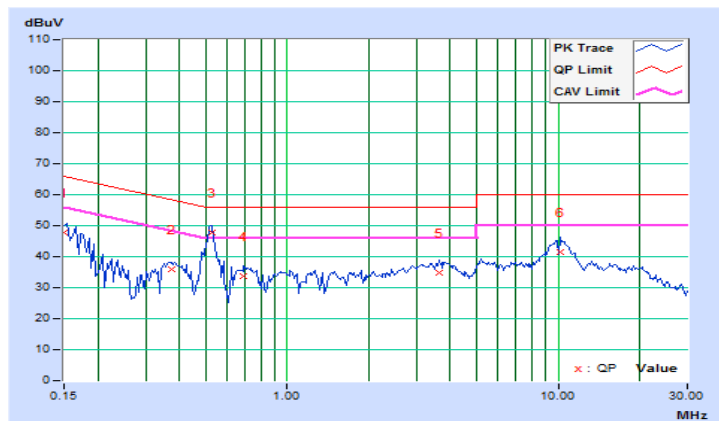

Phase	Neutral (N)	Detector Function	Quasi-Peak (QP) / Average (AV)
Test Mode	D		

No	Freq. [MHz]	Corr. Factor (dB)	Reading Value [dB (uV)]		Emission Level [dB (uV)]		Limit [dB (uV)]		Margin (dB)	
			Q.P.	AV.	Q.P.	AV.	Q.P.	AV.	Q.P.	AV.
			1	0.15000	10.02	37.79	21.52	47.81	31.54	66.00
2	0.38828	10.04	22.77	16.79	32.81	26.83	58.10	48.10	-25.29	-21.27
3	0.52500	10.04	37.25	32.48	47.29	42.52	56.00	46.00	-8.71	-3.48
4	3.63672	10.23	21.79	16.87	32.02	27.10	56.00	46.00	-23.98	-18.90
5	10.14063	10.32	30.71	25.82	41.03	36.14	60.00	50.00	-18.97	-13.86
6	18.75000	10.66	20.39	15.28	31.05	25.94	60.00	50.00	-28.95	-24.06

Remarks:

1. Q.P. and AV. are abbreviations of quasi-peak and average individually.
2. The emission levels of other frequencies were very low against the limit.
3. Margin value = Emission level - Limit value
4. Correction factor = Insertion loss + Cable loss
5. Emission Level = Correction Factor + Reading Value.

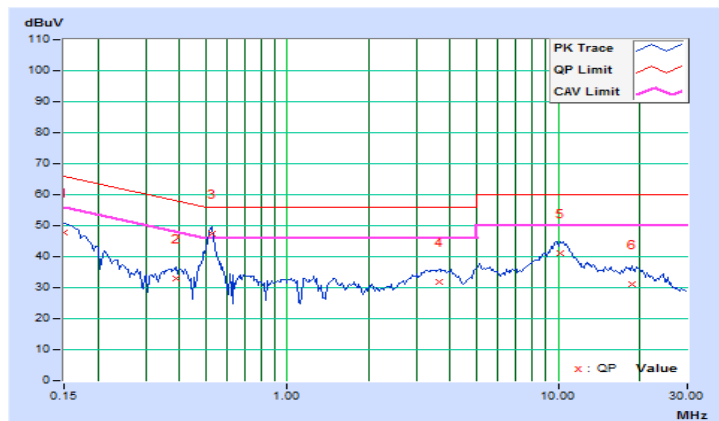

4.3 Transmit Power Measurement

4.3.1 Limits of Transmit Power Measurement

Operation Band	EUT Category		LIMIT
U-NII-1		Outdoor Access Point	1 Watt (30 dBm) (Max. e.i.r.p \leq 125mW(21 dBm) at any elevation angle above 30 degrees as measured from the horizon)
		Fixed point-to-point Access Point	1 Watt (30 dBm)
	√	Indoor Access Point	1 Watt (30 dBm)
		Mobile and Portable client device	250mW (24 dBm)
U-NII-2A	---		250mW (24 dBm) or 11 dBm+10 log B*
U-NII-2C	---		250mW (24 dBm) or 11 dBm+10 log B*
U-NII-3	√		1 Watt (30 dBm)

*B is the 26 dB emission bandwidth in megahertz

Per KDB 662911 Method of conducted output power measurement on IEEE 802.11 devices,

Array Gain = 0 dB (i.e., no array gain) for $N_{ANT} \leq 4$;

Array Gain = 0 dB (i.e., no array gain) for channel widths ≥ 40 MHz for any N_{ANT} ;

Array Gain = $5 \log(N_{ANT}/N_{SS})$ dB or 3 dB, whichever is less for 20-MHz channel widths with $N_{ANT} \geq 5$.

For power measurements on all other devices: Array Gain = $10 \log(N_{ANT}/N_{SS})$ dB.

4.3.2 Test Setup

For Power Output Measurement

802.11a, 802.11n (HT20), 802.11n (HT40)

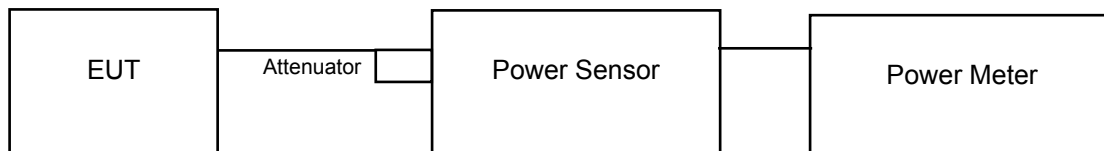

802.11ac (VHT80)

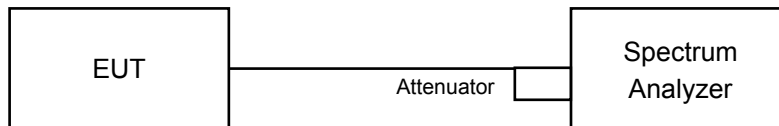

4.3.3 Test Instruments

Refer to section 4.1.2 to get information of above instrument.

4.3.4 Test Procedure

For Average Power Measurement

For 802.11a, 802.11n (HT20), 802.11n (HT40)

Method PM is used to perform output power measurement, trigger and gating function of wide band power meter is enabled to measure max output power of TX on burst. Duty factor is not added to measured value.

For 802.11ac (VHT80)

- a. Set span to encompass the entire 26 dB EBW (or, alternatively, the entire 99% occupied bandwidth) of the signal.
- b. Set sweep trigger to "free run".
- c. Set RBW = 1 MHz.
- d. Set VBW \geq 3 MHz
- e. Number of points in sweep \geq 2 Span / RBW.
- f. Sweep time \leq (number of points in sweep) * T
- g. Using emission bandwidth to determine the frequency span for integration the channel bandwidth.
- h. Detector = RMS.
- i. Trace mode = max hold.
- j. Allow max hold to run for at least 60 seconds, or longer as needed to allow the trace to stabilize.
- k. Compute power by integrating the spectrum across the EBW (or, alternatively, the entire 99% occupied bandwidth) of the signal using the instrument's band power measurement function with band limits set equal to the EBW (or occupied bandwidth) band edges. If the instrument does not have a band power function, sum the spectrum levels (in power units) at 1 MHz intervals extending across the EBW (or, alternatively, the entire 99% occupied bandwidth) of the spectrum.

4.3.5 Deviation from Test Standard

No deviation.

4.3.6 EUT Operating Conditions

The software provided by client to enable the EUT under transmission condition continuously at lowest, middle and highest channel frequencies individually.

4.3.7 Test Result

CDD Mode

802.11a

Chan.	Freq. (MHz)	Maximum Conducted Power (dBm)		Total Power (mW)	Total Power (dBm)	Power Limit (dBm)	Pass / Fail
		Chain 0	Chain 1				
36	5180	9.63	7.81	15.222	11.82	30.00	Pass
40	5200	10.06	8.38	17.026	12.31	30.00	Pass
48	5240	9.34	7.78	14.588	11.64	30.00	Pass
149	5745	19.89	19.81	193.218	22.86	30.00	Pass
157	5785	22.76	22.67	373.726	25.73	30.00	Pass
165	5825	20.43	20.58	224.696	23.52	30.00	Pass

802.11n (HT20)

Chan.	Freq. (MHz)	Maximum Conducted Power (dBm)		Total Power (mW)	Total Power (dBm)	Power Limit (dBm)	Pass / Fail
		Chain 0	Chain 1				
36	5180	9.96	8.21	16.530	12.18	30.00	Pass
40	5200	10.34	8.33	17.622	12.46	30.00	Pass
48	5240	9.27	7.73	14.382	11.58	30.00	Pass
149	5745	19.95	19.83	195.016	22.90	30.00	Pass
157	5785	22.74	22.82	379.358	25.79	30.00	Pass
165	5825	20.17	20.12	206.794	23.16	30.00	Pass

802.11n (HT40)

Chan.	Freq. (MHz)	Maximum Conducted Power (dBm)		Total Power (mW)	Total Power (dBm)	Power Limit (dBm)	Pass / Fail
		Chain 0	Chain 1				
38	5190	12.68	10.94	30.952	14.91	30.00	Pass
46	5230	11.59	9.95	24.307	13.86	30.00	Pass
151	5755	18.66	18.44	143.274	21.56	30.00	Pass
159	5795	20.03	20.39	210.089	23.22	30.00	Pass

802.11ac (VHT80)

Chan.	Freq. (MHz)	Maximum Conducted Power (dBm)		Total Power (mW)	Total Power (dBm)	Power Limit (dBm)	Pass / Fail
		Chain 0	Chain 1				
42	5210	14.09	14.25	52.252	17.18	30.00	Pass
155	5775	17.91	18.22	128.176	21.08	30.00	Pass

Beamforming Mode

802.11n (HT20)

Chan.	Freq. (MHz)	Maximum Conducted Power (dBm)		Total Power (mW)	Total Power (dBm)	Power Limit (dBm)	Pass / Fail
		Chain 0	Chain 1				
36	5180	6.95	5.20	8.266	9.17	27.39	Pass
40	5200	7.33	5.32	8.812	9.45	27.39	Pass
48	5240	6.26	4.72	7.192	8.57	27.39	Pass
149	5745	16.94	16.82	97.515	19.89	27.39	Pass
157	5785	19.73	19.81	189.691	22.78	27.39	Pass
165	5825	17.16	17.11	103.404	20.15	27.39	Pass

Note: Directional gain = 5.60dBi + 10log(2) = 8.61dBi > 6dBi, so the power limit shall be reduced to 30-(8.61-6) = 27.39dBm

802.11n (HT40)

Chan.	Freq. (MHz)	Maximum Conducted Power (dBm)		Total Power (mW)	Total Power (dBm)	Power Limit (dBm)	Pass / Fail
		Chain 0	Chain 1				
38	5190	9.67	7.93	15.477	11.90	27.39	Pass
46	5230	8.58	6.94	12.154	10.85	27.39	Pass
151	5755	15.65	15.43	71.642	18.55	27.39	Pass
159	5795	17.02	17.38	105.052	20.21	27.39	Pass

Note: Directional gain = 5.60dBi + 10log(2) = 8.61dBi > 6dBi, so the power limit shall be reduced to 30-(8.61-6) = 27.39dBm

802.11ac (VHT80)

Chan.	Freq. (MHz)	Maximum Conducted Power (dBm)		Total Power (mW)	Total Power (dBm)	Power Limit (dBm)	Pass / Fail
		Chain 0	Chain 1				
42	5210	11.08	11.24	26.128	14.17	27.39	Pass
155	5775	14.90	15.21	64.092	18.07	27.39	Pass

Note: Directional gain = 5.60dBi + 10log(2) = 8.61dBi > 6dBi, so the power limit shall be reduced to 30-(8.61-6) = 27.39dBm

4.4 Occupied Bandwidth Measurement

4.4.1 Test Setup

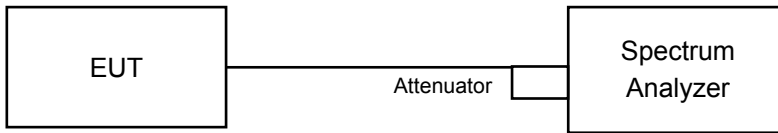

4.4.2 Test Instruments

Refer to section 4.1.2 to get information of above instrument.

4.4.3 Test Procedure

The transmitter output was connected to the spectrum analyzer through an attenuator. The bandwidth of the fundamental frequency was measured by spectrum analyzer with resolution bandwidth in the range of 1% to 5% of the anticipated emission bandwidth, and a video bandwidth at least 3x the resolution bandwidth and set the detector to Sampling. The width of a frequency band such that, below the lower and above the upper frequency limits, the mean powers emitted are each equal to a specified percentage 0.5 %of the total mean power of a given emission.

4.4.4 Test Result

802.11a

Chan.	Freq. (MHz)	Occupied Bandwidth (MHz)	
		Chain 0	Chain 1
36	5180	16.44	16.44
40	5200	16.56	16.44
48	5240	16.56	16.44
149	5745	16.92	16.56
157	5785	29.64	22.56
165	5825	17.88	16.56

802.11n (HT20)

Chan.	Freq. (MHz)	Occupied Bandwidth (MHz)	
		Chain 0	Chain 1
36	5180	17.64	17.76
40	5200	17.64	17.64
48	5240	17.64	17.64
149	5745	17.88	17.76
157	5785	30.72	22.92
165	5825	18.00	17.64

802.11n (HT40)

Chan.	Freq. (MHz)	Occupied Bandwidth (MHz)	
		Chain 0	Chain 1
38	5190	36.24	36.24
46	5230	36.24	36.24
151	5755	36.36	36.24
159	5795	36.72	36.36

802.11ac (VHT80)

Chan.	Freq. (MHz)	Occupied Bandwidth (MHz)	
		Chain 0	Chain 1
42	5210	75.88	75.88
155	5775	76.16	75.88

Spectrum Plot of Worst Value

802.11a

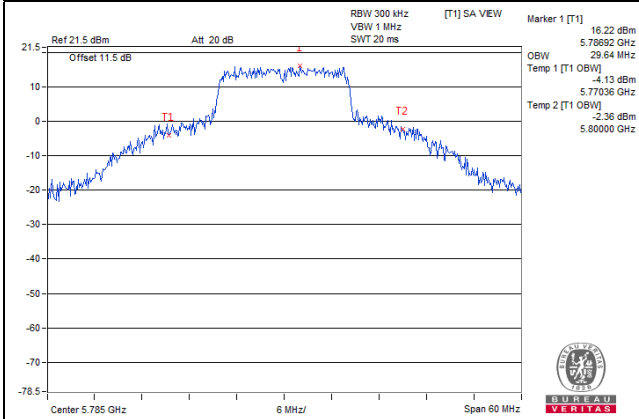

802.11n (HT20)

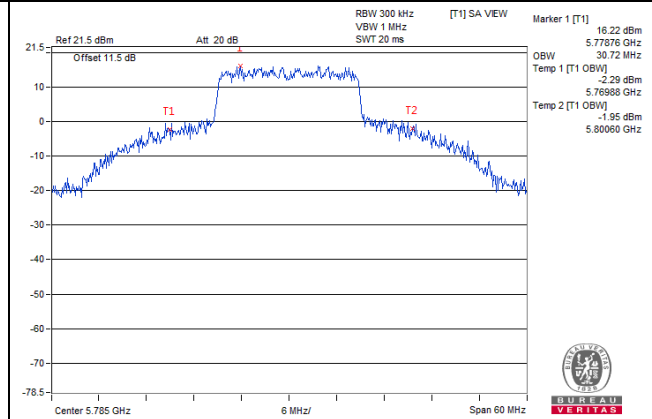

802.11n (HT40)

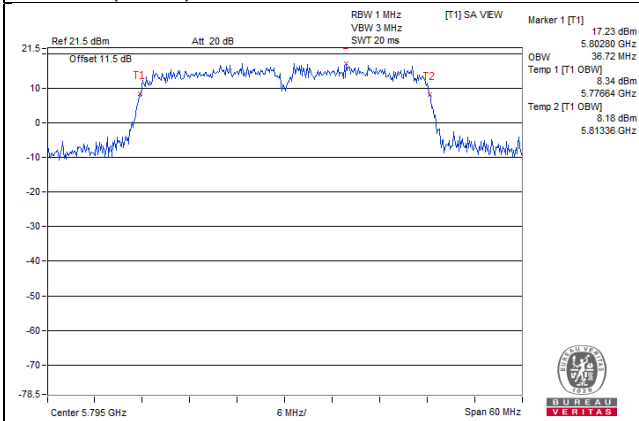

802.11ac (VHT80)

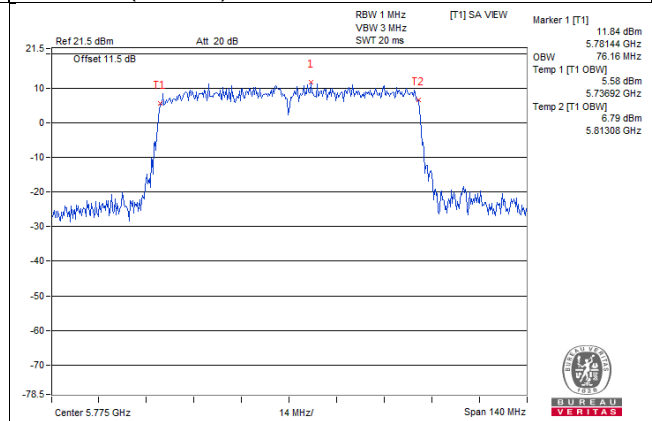

4.5 Peak Power Spectral Density Measurement

4.5.1 Limits of Peak Power Spectral Density Measurement

Operation Band	EUT Category		LIMIT
U-NII-1		Outdoor Access Point	17dBm/ MHz
		Fixed point-to-point Access Point	
	√	Indoor Access Point	11dBm/ MHz
		Mobile and Portable client device	
U-NII-2A	---		11dBm/ MHz
U-NII-2C	---		11dBm/ MHz
U-NII-3	√		30dBm/ 500kHz

4.5.2 Test Setup

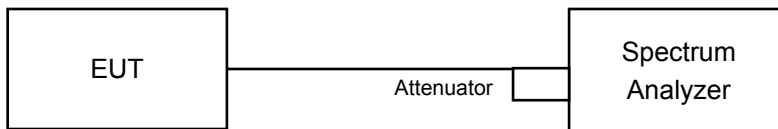

4.5.3 Test Instruments

Refer to section 4.1.2 to get information of above instrument.

4.5.4 Test Procedures

For U-NII-1 band:

Duty cycle >98%, using method SA-1

- Set span to encompass the entire emission bandwidth (EBW) of the signal.
- Set RBW = 1 MHz, Set VBW ≥ 3 MHz, Detector = RMS
- Sweep time = auto, trigger set to “free run”.
- Trace average at least 100 traces in power averaging mode.
- Record the max value

Duty cycle <98%, using method SA-2

- Set span to encompass the entire emission bandwidth (EBW) of the signal.
- Set RBW = 1 MHz, Set VBW ≥ 3 MHz, Detector = RMS
- Sweep time = auto, trigger set to “free run”.
- Trace average at least 100 traces in power averaging mode.
- Record the max value and add 10 log (1/duty cycle)

For U-NII-3 band:

Duty cycle >98%

- a. Set span to encompass the entire emission bandwidth (EBW) of the signal.
- b. Set RBW = 300 kHz, Set VBW \geq 1 MHz, Detector = RMS
- c. Use the peak marker function to determine the maximum power level in any 300 kHz band segment within the fundamental EBW.
- d. Scale the observed power level to an equivalent value in 500 kHz by adjusting (reducing) the measured power by a bandwidth correction factor (BWCF) where $BWCF = 10\log(500 \text{ kHz}/300\text{kHz})$
- e. Sweep time = auto, trigger set to "free run".
- f. Trace average at least 100 traces in power averaging mode.
- g. Record the max value

Duty cycle <98%

- a. Set span to encompass the entire emission bandwidth (EBW) of the signal.
- b. Set RBW = 300 kHz, Set VBW \geq 1 MHz, Detector = RMS
- c. Use the peak marker function to determine the maximum power level in any 300 kHz band segment within the fundamental EBW.
- d. Scale the observed power level to an equivalent value in 500 kHz by adjusting (reducing) the measured power by a bandwidth correction factor (BWCF) where $BWCF = 10\log(500 \text{ kHz}/300\text{kHz})$
- e. Sweep time = auto, trigger set to "free run".
- f. Trace average at least 100 traces in power averaging mode.
- g. Record the max value and add $10 \log (1/\text{duty cycle})$

4.5.5 Deviation from Test Standard

No deviation.

4.5.6 EUT Operating Conditions

Same as Item 4.3.6.

4.5.7 Test Results

For U-NII-1 Band

802.11a

Chan.	Freq. (MHz)	PSD w/o Duty Factor (dBm)		Duty Factor (dB)	Total PSD with Duty Factor (dBm)	Max. Limit (dBm)	Pass / Fail
		Chain 0	Chain 1				
36	5180	-0.65	-3.59	0.17	1.31	14.39	Pass
40	5200	-0.52	-3.64	0.17	1.38	14.39	Pass
48	5240	-0.76	-3.73	0.17	1.19	14.39	Pass

Note:

1. Method 1 of power density measurement of KDB 662911 is using for calculating total power density. Total power density is summing entire spectra across corresponding frequency bins on the various outputs by computer.
2. Directional gain = $5.60\text{dBi} + 10\log(2) = 8.61\text{dBi} > 6\text{dBi}$, so the power density limit shall be reduced to $17 - (8.61 - 6) = 14.39\text{dBm}$
3. Refer to section 3.3 for duty cycle spectrum plot.

802.11n (HT20)

Chan.	Freq. (MHz)	PSD (dBm/MHz)		Total PSD (dBm/MHz)	Max. Limit (dBm/MHz)	Pass / Fail
		Chain 0	Chain 1			
36	5180	-0.47	-3.37	1.33	14.39	Pass
40	5200	-0.59	-3.46	1.22	14.39	Pass
48	5240	-0.99	-3.63	0.90	14.39	Pass

Note:

1. Method 1 of power density measurement of KDB 662911 is using for calculating total power density. Total power density is summing entire spectra across corresponding frequency bins on the various outputs by computer.
2. Directional gain = $5.60\text{dBi} + 10\log(2) = 8.61\text{dBi} > 6\text{dBi}$, so the power density limit shall be reduced to $17 - (8.61 - 6) = 14.39\text{dBm}$

802.11n (HT40)

Chan.	Freq. (MHz)	PSD w/o Duty Factor (dBm)		Duty Factor (dB)	Total PSD with Duty Factor (dBm)	Max. Limit (dBm)	Pass / Fail
		Chain 0	Chain 1				
38	5190	-0.79	-3.19	0.16	1.34	14.39	Pass
46	5230	-0.97	-2.88	0.16	1.35	14.39	Pass

Note:

1. Method 1 of power density measurement of KDB 662911 is using for calculating total power density. Total power density is summing entire spectra across corresponding frequency bins on the various outputs by computer.
2. Directional gain = $5.60\text{dBi} + 10\log(2) = 8.61\text{dBi} > 6\text{dBi}$, so the power density limit shall be reduced to $17 - (8.61 - 6) = 14.39\text{dBm}$
3. Refer to section 3.3 for duty cycle spectrum plot.

802.11ac (VHT80)

Chan.	Freq. (MHz)	PSD w/o Duty Factor (dBm)		Duty Factor (dB)	Total PSD with Duty Factor (dBm)	Max. Limit (dBm)	Pass / Fail
		Chain 0	Chain 1				
42	5210	-2.25	-3.74	0.36	0.44	14.39	Pass

Note:

1. Method 1 of power density measurement of KDB 662911 is using for calculating total power density. Total power density is summing entire spectra across corresponding frequency bins on the various outputs by computer.
2. Directional gain = $5.60\text{dBi} + 10\log(2) = 8.61\text{dBi} > 6\text{dBi}$, so the power density limit shall be reduced to $17-(8.61-6) = 14.39\text{dBm}$
3. Refer to section 3.3 for duty cycle spectrum plot.

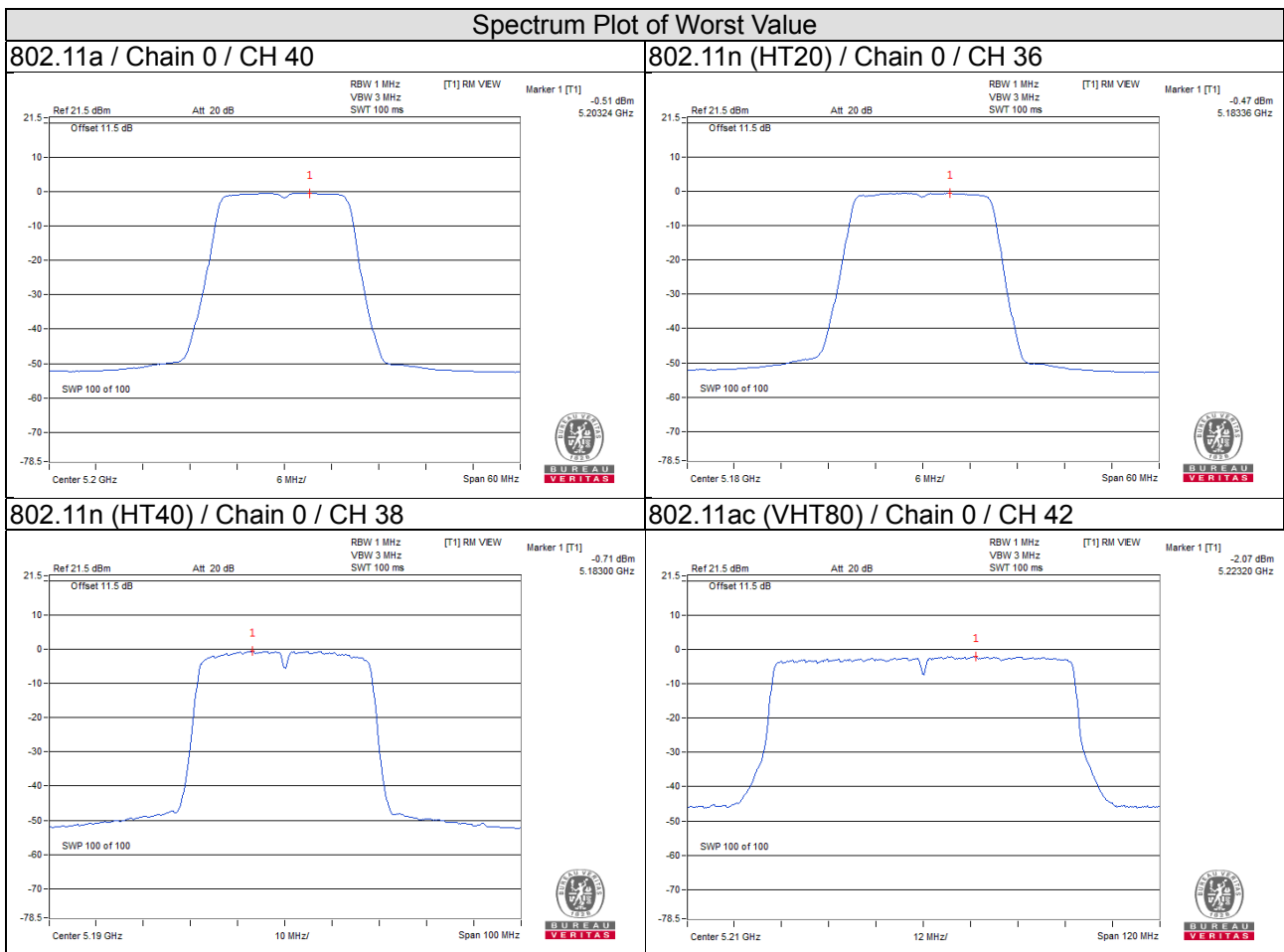

For U-NII-3 Band

802.11a

TX chain	Chan.	Freq. (MHz)	PSD w/o Duty Factor		10 log (N=2) dB	Duty Factor (dB)	Total PSD with Duty Factor (dBm/500kHz)	Limit (dBm/500 kHz)	Pass / Fail
			(dBm/300kHz)	(dBm/500kHz)					
0	149	5745	6.19	8.41	3.01	0.17	11.59	27.39	Pass
	157	5785	9.11	11.33	3.01	0.17	14.51	27.39	Pass
	165	5825	8.00	10.22	3.01	0.17	13.40	27.39	Pass
1	149	5745	4.72	6.94	3.01	0.17	10.12	27.39	Pass
	157	5785	7.88	10.10	3.01	0.17	13.28	27.39	Pass
	165	5825	6.20	8.42	3.01	0.17	11.60	27.39	Pass

Note:

- Method 1 of power density measurement of KDB 662911 is using for calculating total power density. Total power density is summing entire spectra across corresponding frequency bins on the various outputs by computer.
- Directional gain = $5.60\text{dBi} + 10\log(2) = 8.61\text{dBi} > 6\text{dBi}$, so the power density limit shall be reduced to $30 - (8.61 - 6) = 27.39\text{dBm}$
- Refer to section 3.3 for duty cycle spectrum plot.

802.11n (HT20)

TX chain	Chan.	Freq. (MHz)	PSD (dBm/300 kHz)	PSD (dBm/500 kHz)	10 log (N=2) dB	Total PSD (dBm/500 kHz)	Limit (dBm/500 kHz)	Pass / Fail
0	149	5745	6.07	8.29	3.01	11.30	27.39	Pass
	157	5785	8.66	10.88	3.01	13.89	27.39	Pass
	165	5825	7.33	9.55	3.01	12.56	27.39	Pass
1	149	5745	4.62	6.84	3.01	9.85	27.39	Pass
	157	5785	7.67	9.89	3.01	12.90	27.39	Pass
	165	5825	5.80	8.02	3.01	11.03	27.39	Pass

Note:

- Method 1 of power density measurement of KDB 662911 is using for calculating total power density. Total power density is summing entire spectra across corresponding frequency bins on the various outputs by computer.
- Directional gain = $5.60\text{dBi} + 10\log(2) = 8.61\text{dBi} > 6\text{dBi}$, so the power density limit shall be reduced to $30 - (8.61 - 6) = 27.39\text{dBm}$

802.11n (HT40)

TX chain	Chan.	Freq. (MHz)	PSD w/o Duty Factor		10 log (N=2) dB	Duty Factor (dB)	Total PSD with Duty Factor (dBm/500kHz)	Limit (dBm/500 kHz)	Pass / Fail
			(dBm/300kHz)	(dBm/500kHz)					
0	151	5755	2.33	4.55	3.01	0.16	7.72	27.39	Pass
	159	5795	3.99	6.21	3.01	0.16	9.38	27.39	Pass
1	151	5755	0.48	2.70	3.01	0.16	5.87	27.39	Pass
	159	5795	2.40	4.62	3.01	0.16	7.79	27.39	Pass

Note:

1. Method 1 of power density measurement of KDB 662911 is using for calculating total power density. Total power density is summing entire spectra across corresponding frequency bins on the various outputs by computer.
2. Directional gain = $5.60\text{dBi} + 10\log(2) = 8.61\text{dBi} > 6\text{dBi}$, so the power density limit shall be reduced to $30 - (8.61 - 6) = 27.39\text{dBm}$
3. Refer to section 3.3 for duty cycle spectrum plot.

802.11ac (VHT80)

TX chain	Chan.	Freq. (MHz)	PSD w/o Duty Factor		10 log (N=2) dB	Duty Factor (dB)	Total PSD with Duty Factor (dBm/500kHz)	Limit (dBm/500 kHz)	Pass / Fail
			(dBm/300kHz)	(dBm/500kHz)					
0	155	5775	-1.55	0.67	3.01	0.36	4.04	27.39	Pass
1	155	5775	-3.59	-1.37	3.01	0.36	2.00	27.39	Pass

Note:

1. Method 1 of power density measurement of KDB 662911 is using for calculating total power density. Total power density is summing entire spectra across corresponding frequency bins on the various outputs by computer.
2. Directional gain = $5.60\text{dBi} + 10\log(2) = 8.61\text{dBi} > 6\text{dBi}$, so the power density limit shall be reduced to $30 - (8.61 - 6) = 27.39\text{dBm}$
3. Refer to section 3.3 for duty cycle spectrum plot.

Spectrum Plot of Worst Value

802.11a

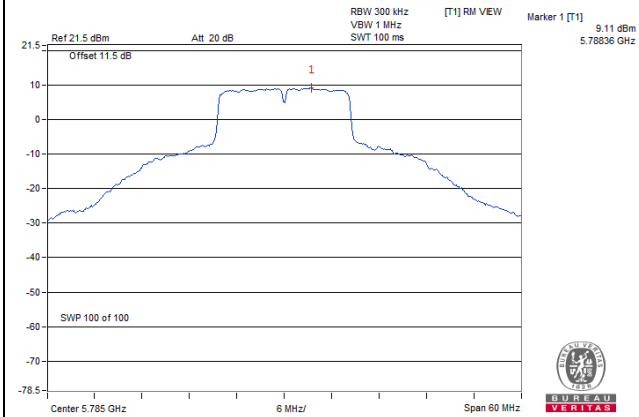

802.11n (HT20)

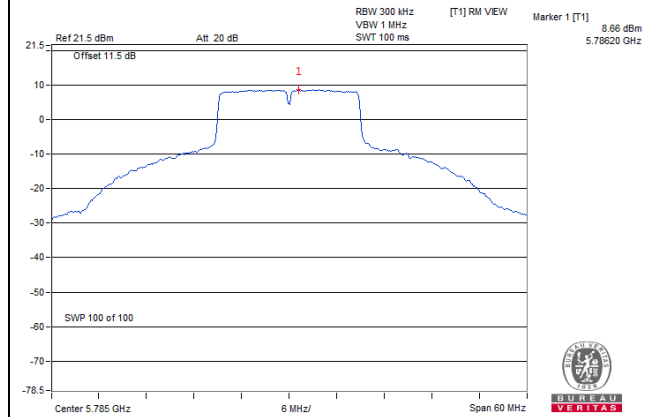

802.11n (HT40)

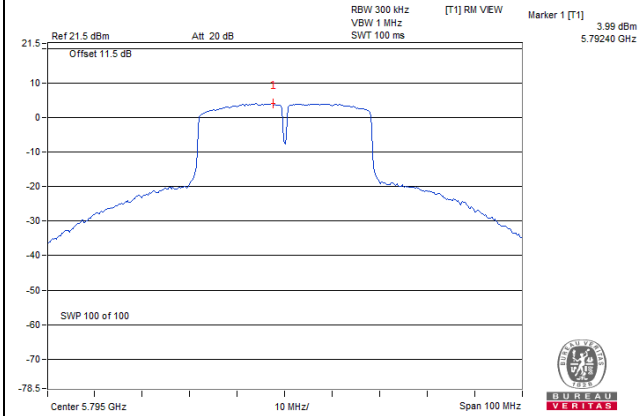

802.11ac (VHT80)

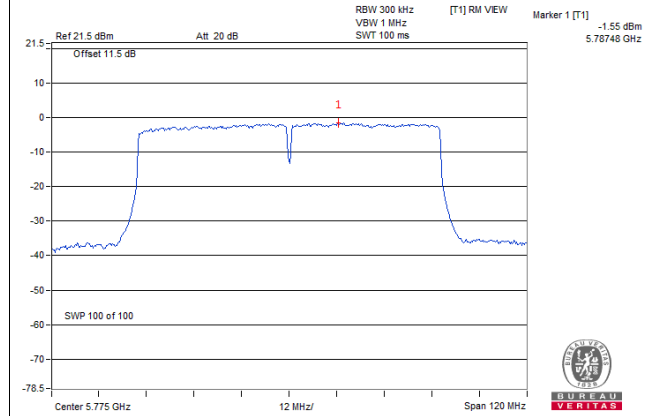

4.6 Frequency Stability

4.6.1 Limits of Frequency Stability Measurement

The frequency of the carrier signal shall be maintained within band of operation

4.6.2 Test Setup

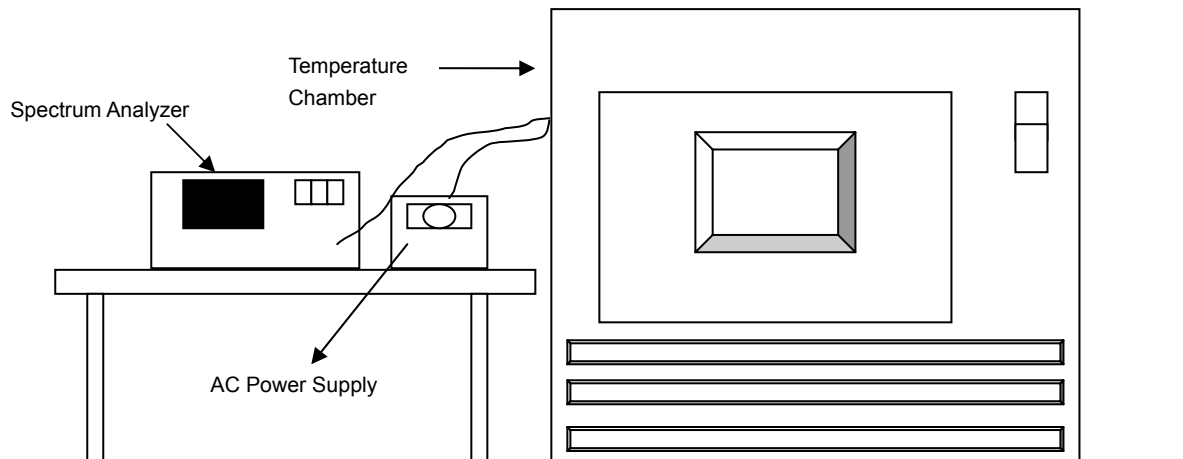

4.6.3 Test Procedure

- The EUT was placed inside the environmental test chamber and powered by nominal AC voltage.
- Turn the EUT on and couple its output to a spectrum analyzer.
- Turn the EUT off and set the chamber to the highest temperature specified.
- Allow sufficient time (approximately 30 min) for the temperature of the chamber to stabilize, turn the EUT on and measure the operating frequency after 2, 5, and 10 minutes.
- Repeat step 2 and 3 with the temperature chamber set to the lowest temperature.
- The test chamber was allowed to stabilize at +20 degree C for a minimum of 30 minutes. The supply voltage was then adjusted on the EUT from 85% to 115% and the frequency record.

4.6.4 Deviation from Test Standard

No deviation.

4.6.5 EUT Operating Condition

Set the EUT transmit at un-modulation mode to test frequency stability.

4.6.6 Test Results

Frequency Stability Versus Temp.									
Operating Frequency: 5240MHz									
Temp. (°C)	Power Supply (Vac)	0 Minute		2 Minute		5 Minute		10 Minute	
		Measured Frequency(MHz)	Frequency Drift (%)	Measured Frequency(MHz)	Frequency Drift (%)	Measured Frequency(MHz)	Frequency Drift (%)	Measured Frequency(MHz)	Frequency Drift (%)
50	120	5240.0161	0.00031	5240.0171	0.00033	5240.0127	0.00024	5240.0128	0.00024
40	120	5239.9942	-0.00011	5239.9953	-0.00009	5239.9954	-0.00009	5239.9947	-0.00010
30	120	5239.989	-0.00021	5239.9895	-0.00020	5239.9889	-0.00021	5239.9895	-0.00020
20	120	5239.9856	-0.00027	5239.9827	-0.00033	5239.9853	-0.00028	5239.9826	-0.00033
10	120	5239.9924	-0.00015	5239.9946	-0.00010	5239.9946	-0.00010	5239.9939	-0.00012
0	120	5239.9757	-0.00046	5239.9756	-0.00047	5239.9764	-0.00045	5239.9778	-0.00042
-10	120	5240.0067	0.00013	5240.0071	0.00014	5240.0036	0.00007	5240.0061	0.00012
-20	120	5239.9746	-0.00048	5239.9733	-0.00051	5239.9745	-0.00049	5239.9758	-0.00046
-30	120	5240.0083	0.00016	5240.0084	0.00016	5240.004	0.00008	5240.0066	0.00013

Frequency Stability Versus Voltage									
Operating Frequency: 5240MHz									
Temp. (°C)	Power Supply (Vac)	0 Minute		2 Minute		5 Minute		10 Minute	
		Measured Frequency(MHz)	Frequency Drift (%)	Measured Frequency(MHz)	Frequency Drift (%)	Measured Frequency(MHz)	Frequency Drift (%)	Measured Frequency(MHz)	Frequency Drift (%)
20	138	5239.9848	-0.00029	5239.9822	-0.00034	5239.9847	-0.00029	5239.9824	-0.00034
	120	5239.9856	-0.00027	5239.9827	-0.00033	5239.9853	-0.00028	5239.9826	-0.00033
	102	5239.9852	-0.00028	5239.9824	-0.00034	5239.9853	-0.00028	5239.9821	-0.00034

4.7 6dB Bandwidth Measurement

4.7.1 Limits of 6dB Bandwidth Measurement

The minimum of 6dB Bandwidth Measurement is 0.5MHz.

4.7.2 Test Setup

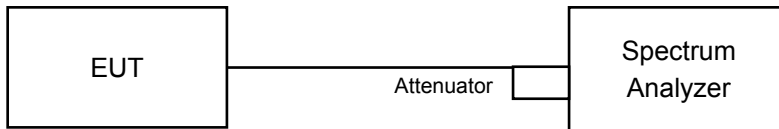

4.7.3 Test Instruments

Refer to section 4.1.2 to get information of above instrument.

4.7.4 Test Procedure

MEASUREMENT PROCEDURE REF

- Set resolution bandwidth (RBW) = 100kHz
- Set the video bandwidth (VBW) $\geq 3 \times$ RBW, Detector = average.
- Trace mode = max hold.
- Sweep = auto couple.
- Measure the maximum width of the emission that is constrained by the frequencies associated with the two amplitude points (upper and lower) that are attenuated by 6 dB relative to the maximum level measured in the fundamental emission

4.7.5 Deviation from Test Standard

No deviation.

4.7.6 EUT Operating Condition

The software provided by client to enable the EUT under transmission condition continuously at lowest, middle and highest channel frequencies individually.

4.7.7 Test Results

802.11a

Channel	Frequency (MHz)	6dB Bandwidth (MHz)		Minimum Limit (MHz)	Pass / Fail
		Chain 0	Chain 1		
149	5745	16.41	16.43	0.5	Pass
157	5785	16.37	16.39	0.5	Pass
165	5825	16.38	16.42	0.5	Pass

802.11n (HT20)

Channel	Frequency (MHz)	6dB Bandwidth (MHz)		Minimum Limit (MHz)	Pass / Fail
		Chain 0	Chain 1		
149	5745	17.61	17.62	0.5	Pass
157	5785	17.59	17.61	0.5	Pass
165	5825	17.58	17.57	0.5	Pass

802.11n (HT40)

Channel	Frequency (MHz)	6dB Bandwidth (MHz)		Minimum Limit (MHz)	Pass / Fail
		Chain 0	Chain 1		
151	5755	35.32	35.31	0.5	Pass
159	5795	35.18	35.24	0.5	Pass

802.11ac (VHT80)

Channel	Frequency (MHz)	6dB Bandwidth (MHz)		Minimum Limit (MHz)	Pass / Fail
		Chain 0	Chain 1		
155	5775	76.32	75.99	0.5	Pass

Spectrum Plot of Worst Value

802.11a

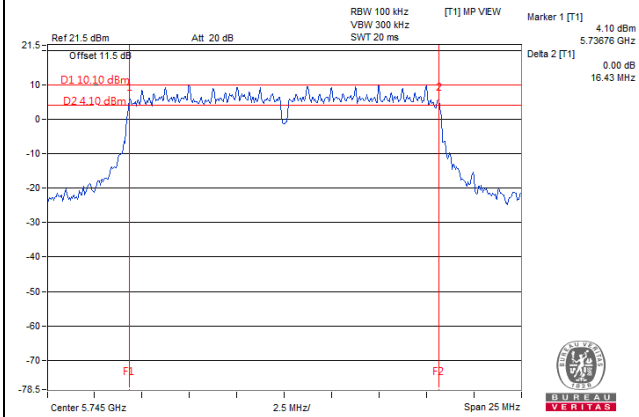

802.11n (HT20)

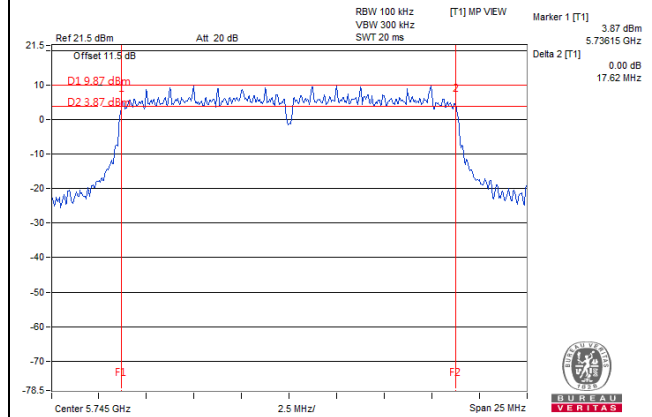

802.11n (HT40)

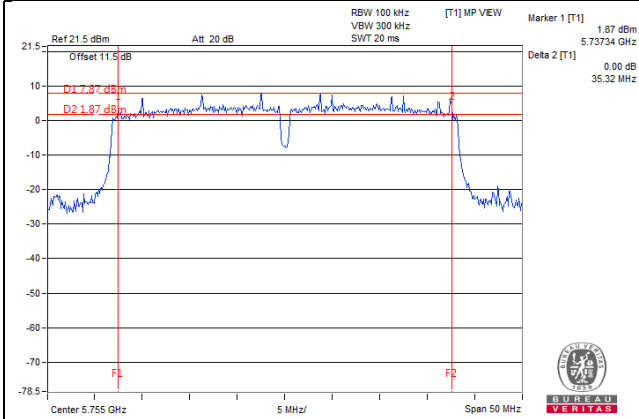

802.11ac (VHT80)

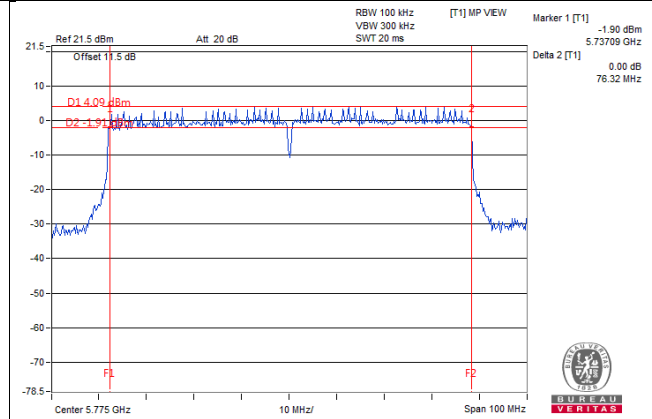

5 Pictures of Test Arrangements

Please refer to the attached file (Test Setup Photo).

Annex A- Radiated Out of Band Emission (OOBE) Measurement (For U-NII-3 band)

Test Mode A

802.11a

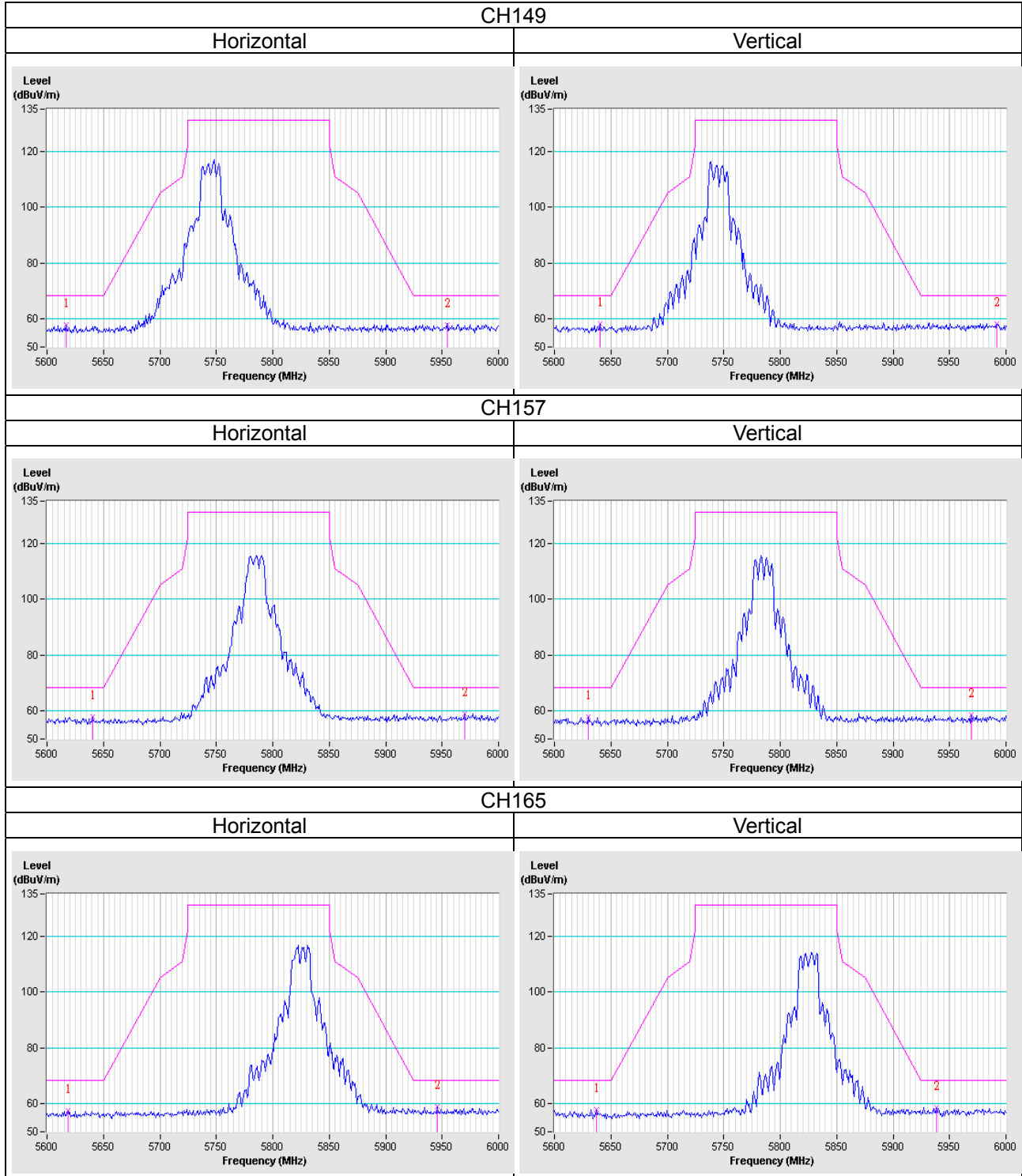

802.11n (HT20)

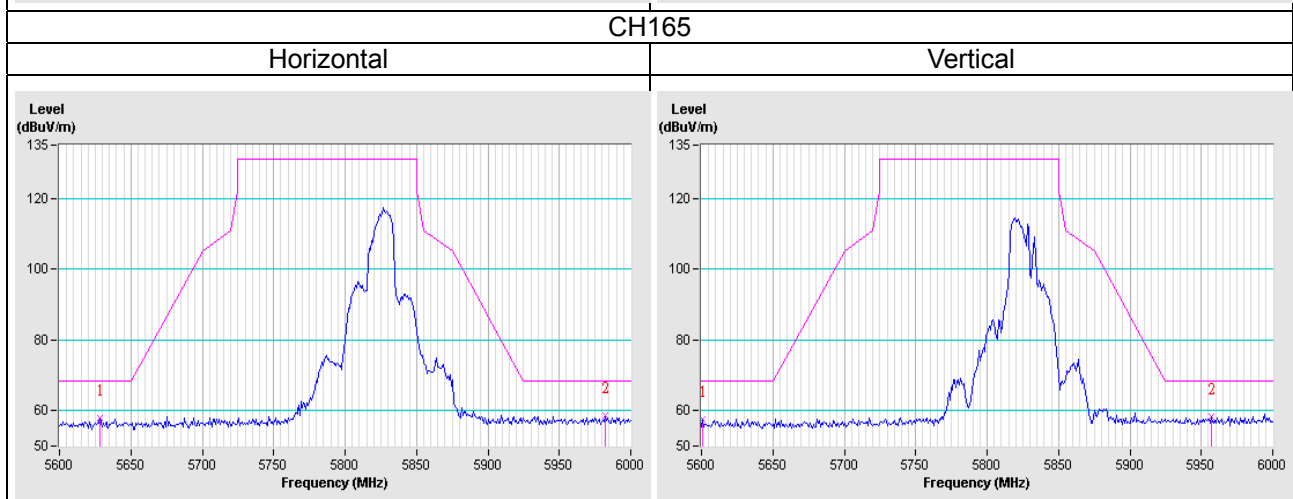
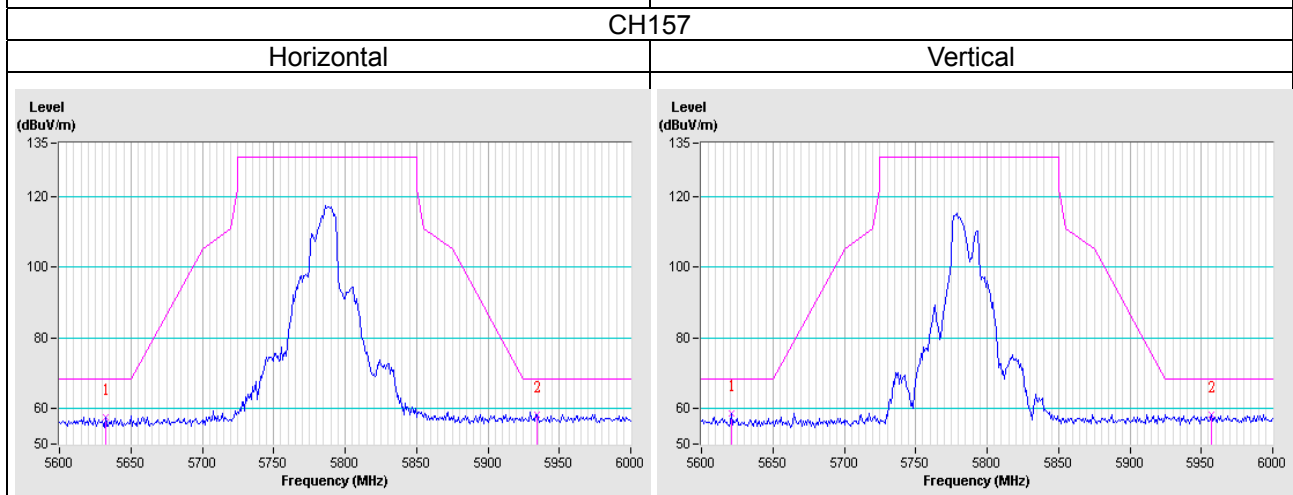
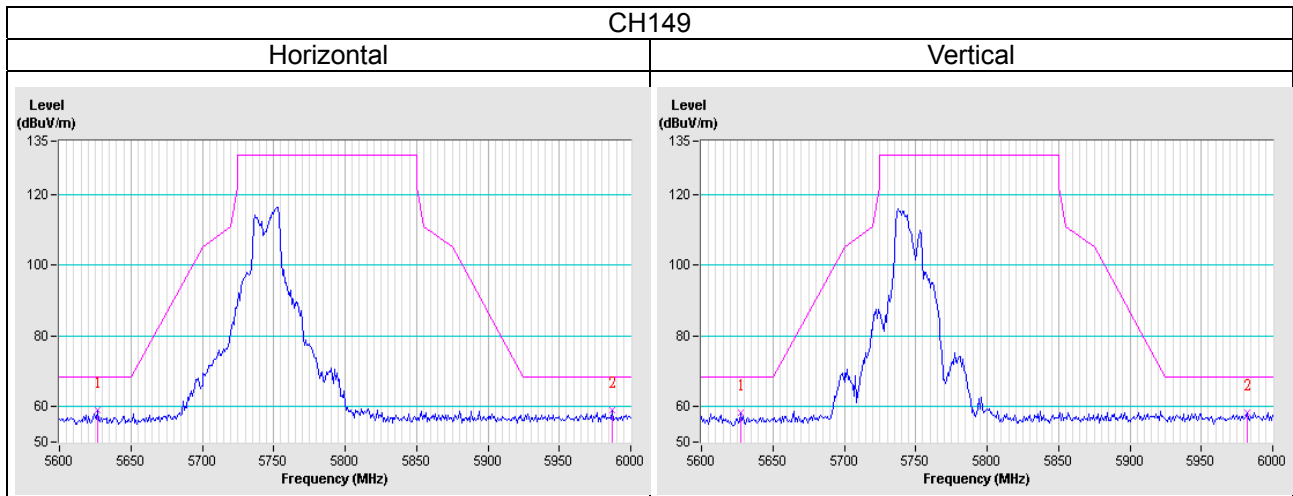

802.11n (HT40)

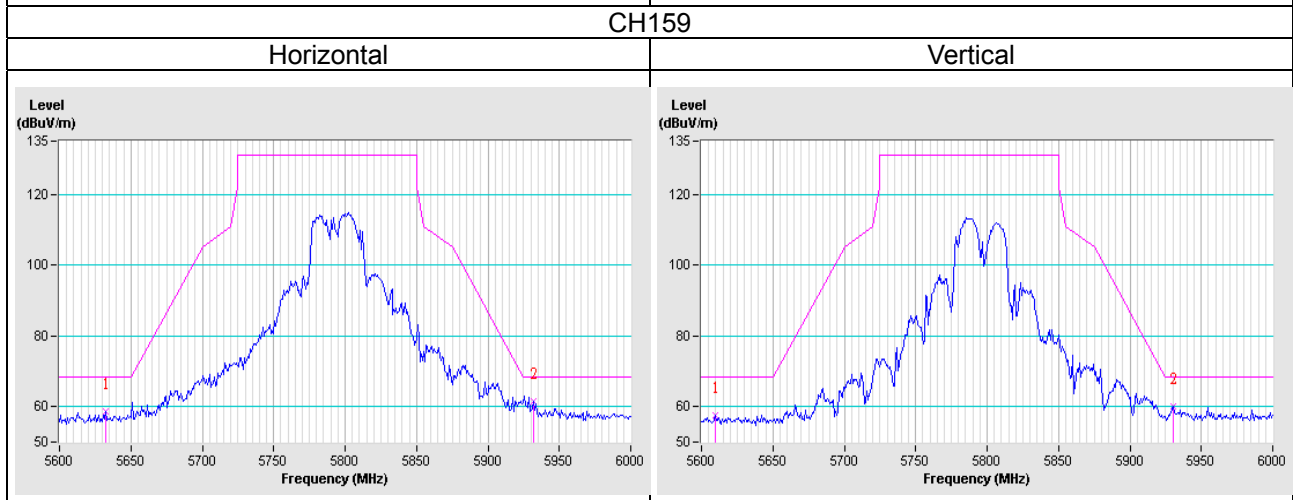
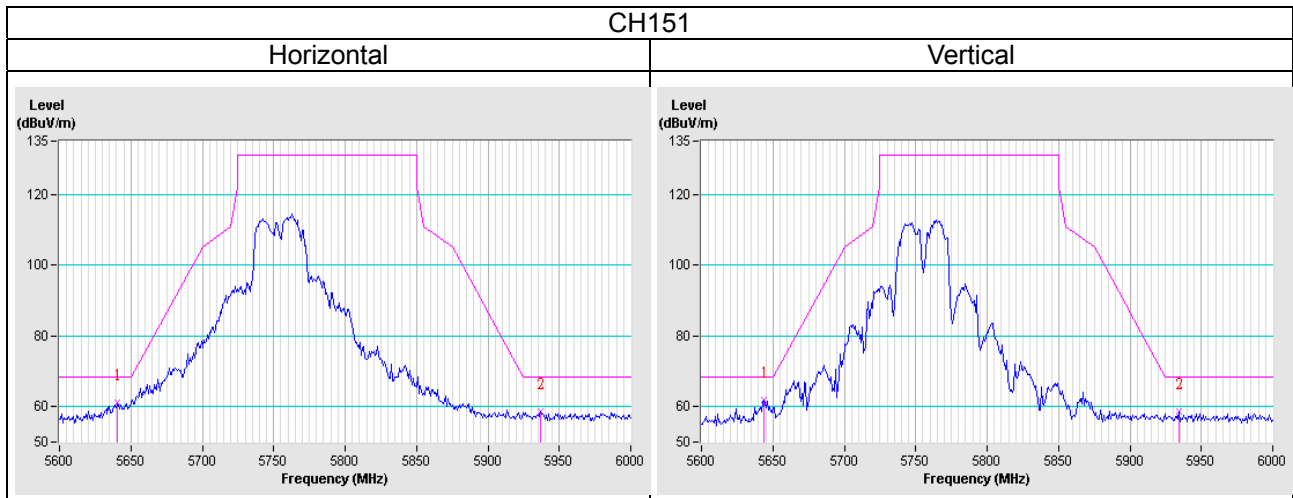

802.11ac (VHT80)

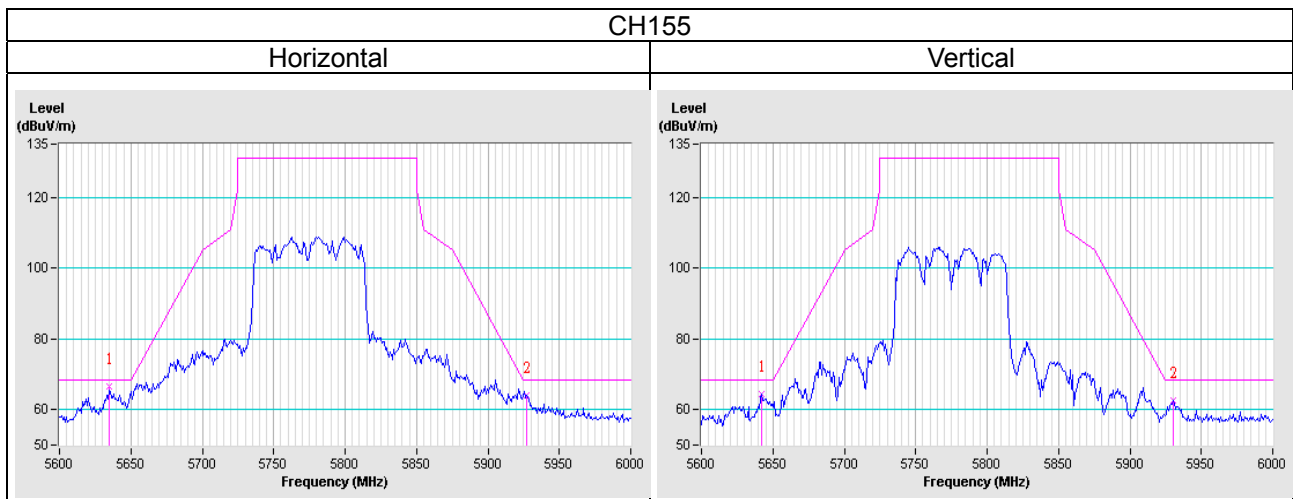

Test Mode C
802.11a

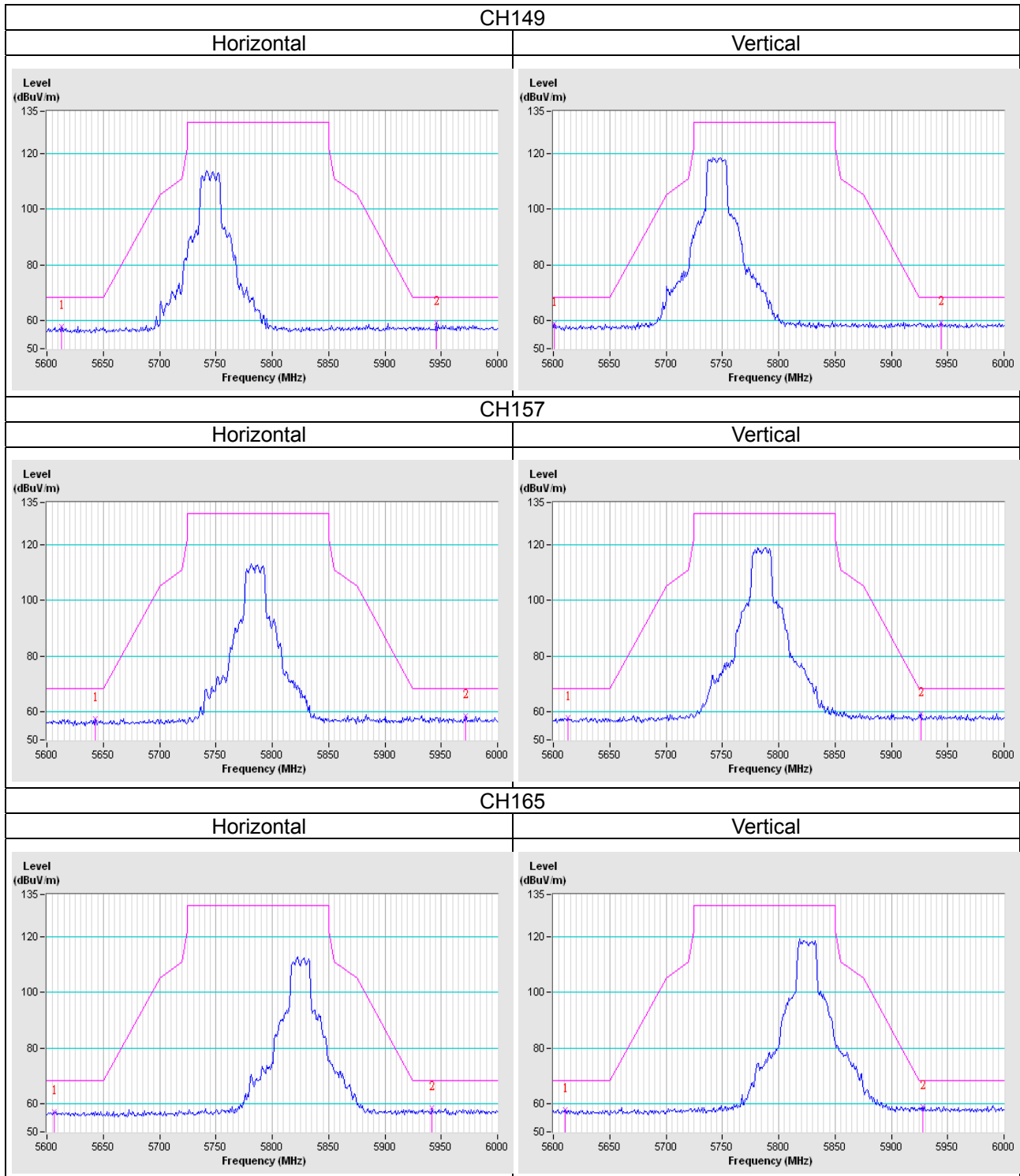

802.11n (HT20)

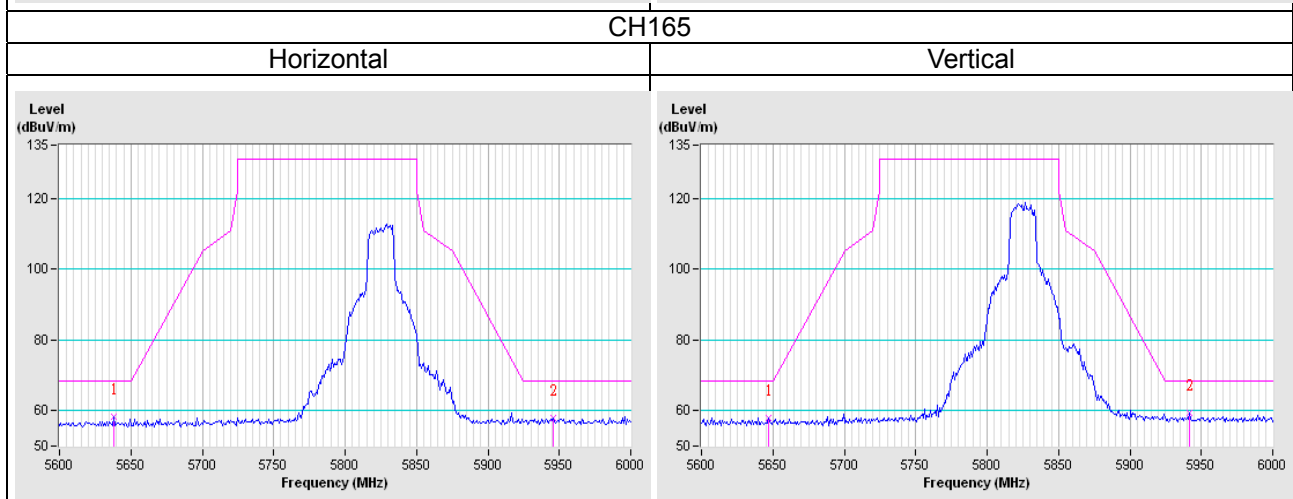
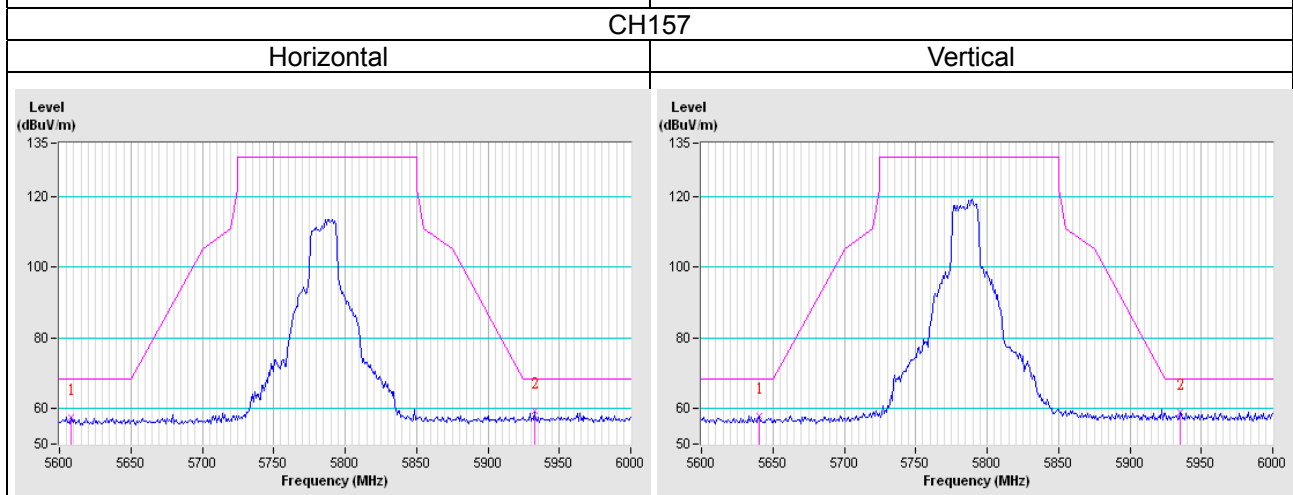
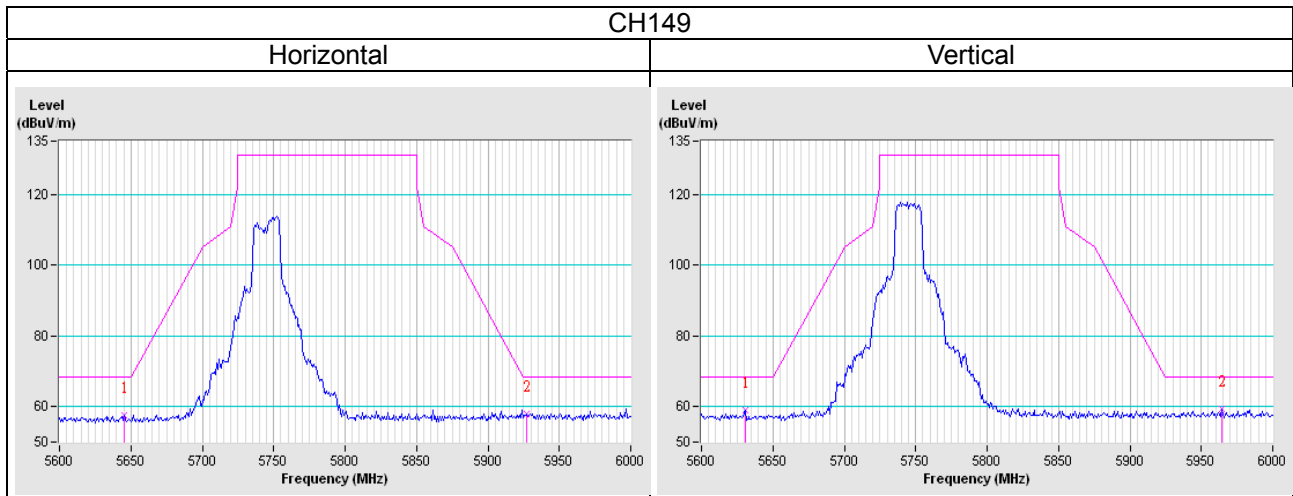

802.11n (HT40)

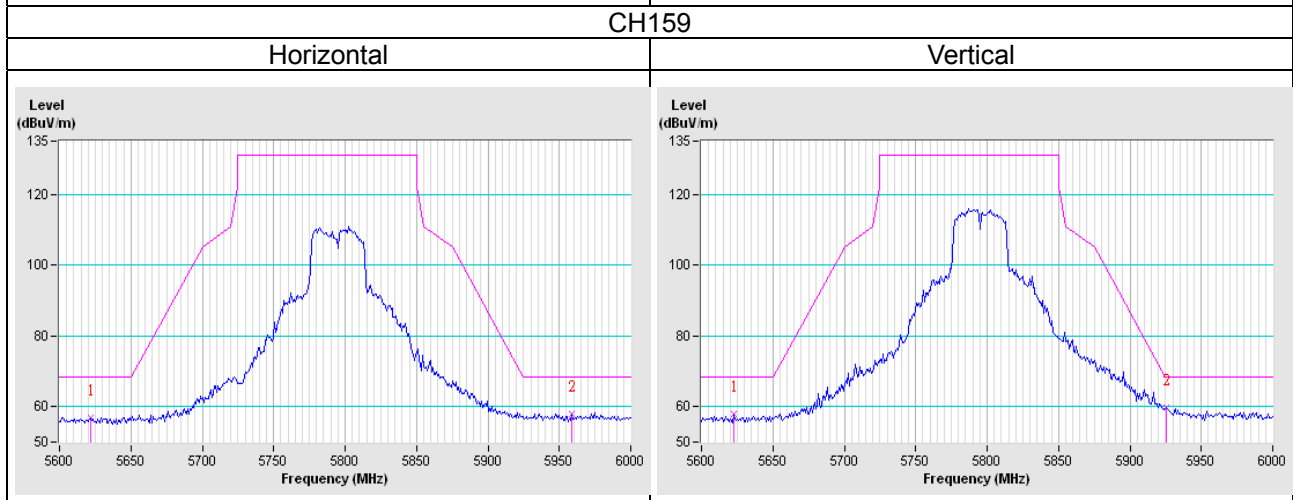
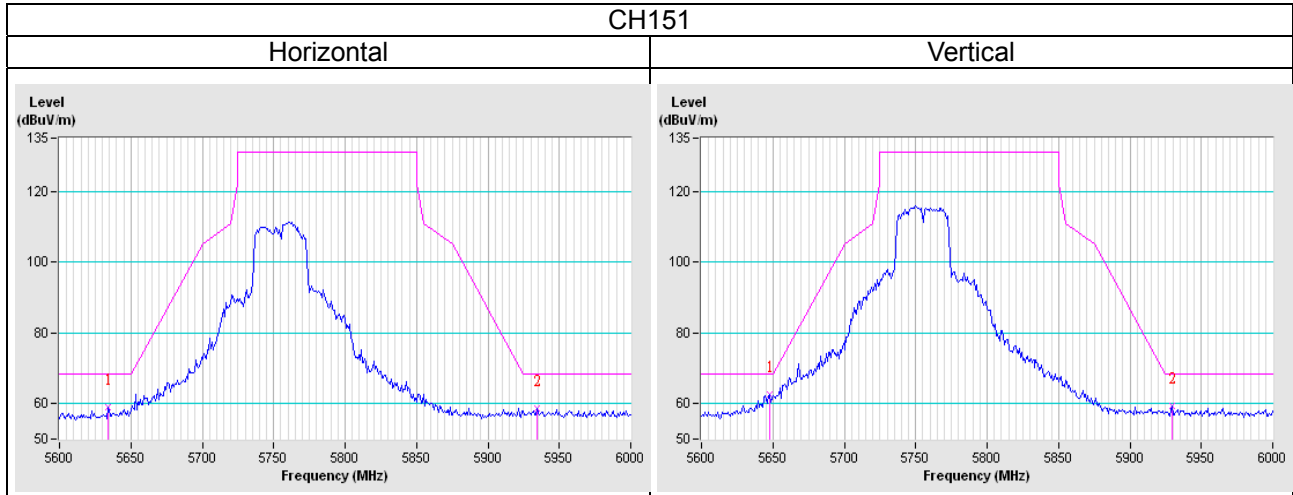

802.11ac (VHT80)

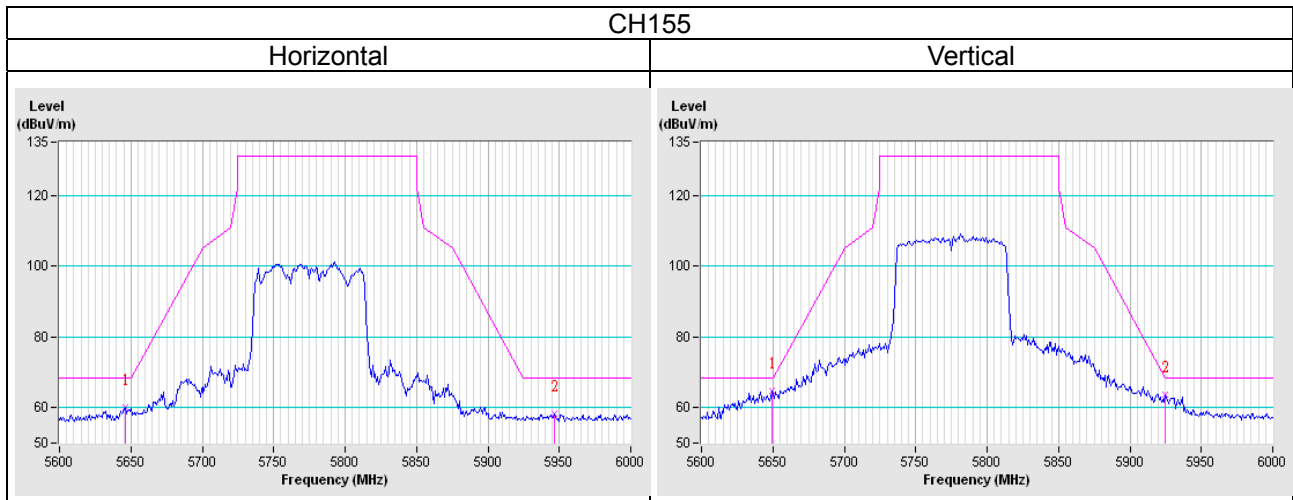

Appendix – Information on the Testing Laboratories

We, Bureau Veritas Consumer Products Services (H.K.) Ltd., Taoyuan Branch, were founded in 1988 to provide our best service in EMC, Radio, Telecom and Safety consultation. Our laboratories are accredited and approved according to ISO/IEC 17025.

If you have any comments, please feel free to contact us at the following:

Linko EMC/RF Lab

Tel: 886-2-26052180

Fax: 886-2-26051924

Hsin Chu EMC/RF/Telecom Lab

Tel: 886-3-6668565

Fax: 886-3-6668323

Hwa Ya EMC/RF/Safety Lab

Tel: 886-3-3183232

Fax: 886-3-3270892

Email: service.adt@tw.bureauveritas.com

Web Site: www.bureauveritas-adt.com

The address and road map of all our labs can be found in our web site also.

--- END ---