

FCC Test Report

Report No.: RF150427C31-1

FCC ID: TVE-120512

Test Model: PCE4302AN

Series Model: PCE4302AN-xxxxxx (where "x" can be used as "A-Z", or "-0-9", or "-", or blank for software changes or marketing purposes only)

Received Date: Apr. 27, 2015

Test Date: May 14 ~ May 29, 2015

Issued Date: Jun. 12, 2015

Applicant: Fortinet Inc.

Address: 899 Kifer Road Sunnyvale, CA 94086 USA

Issued By: Bureau Veritas Consumer Products Services (H.K.) Ltd., Taoyuan Branch

Lab Address: No. 47-2, 14th Ling, Chia Pau Vil., Lin Kou Dist., New Taipei City, Taiwan, R.O.C.

Lab Address: No.19, Hwa Ya 2nd Rd., Wen Hwa Vil., Kwei Shan Dist., Taoyuan City 33383, TAIWAN (R.O.C.)



This report is for your exclusive use. Any copying or replication of this report to or for any other person or entity, or use of our name or trademark, is permitted only with our prior written permission. This report sets forth our findings solely with respect to the test samples identified herein. The results set forth in this report are not indicative or representative of the quality or characteristics of the lot from which a test sample was taken or any similar or identical product specifically and expressly noted. Our report includes all of the tests requested by you and the results thereof based upon the information that you provided to us. You have 60 days from date of issuance of this report to notify us of any material error or omission caused by our negligence, provided, however, that such notice shall be in writing and shall specifically address the issue you wish to raise. A failure to raise such issue within the prescribed time shall constitute your unqualified acceptance of the completeness of this report, the tests conducted and the correctness of the report contents. Unless specific mention, the uncertainty of measurement has been explicitly taken into account to declare the compliance or non-compliance to the specification. The report must not be used by the client to claim product certification, approval, or endorsement by TAF or any government agencies.

Table of Contents

Release Control Record	4
1 Certificate of Conformity	5
2 Summary of Test Results	6
2.1 Measurement Uncertainty	6
2.2 Modification Record	6
3 General Information	7
3.1 General Description of EUT	7
3.2 Description of Test Modes	9
3.2.1 Test Mode Applicability and Tested Channel Detail	10
3.3 Duty Cycle of Test Signal	12
3.4 Description of Support Units	13
3.4.1 Configuration of System under Test	13
3.5 General Description of Applied Standards	14
4 Test Types and Results	15
4.1 Radiated Emission and Bandedge Measurement.....	15
4.1.1 Limits of Radiated Emission and Bandedge Measurement	15
4.1.2 Test Instruments	16
4.1.3 Test Procedures.....	17
4.1.4 Deviation from Test Standard	17
4.1.5 Test Set Up	18
4.1.6 EUT Operating Conditions.....	18
4.1.7 Test Results	19
4.2 Conducted Emission Measurement	38
4.2.1 Limits of Conducted Emission Measurement	38
4.2.2 Test Instruments	38
4.2.3 Test Procedures.....	39
4.2.4 Deviation from Test Standard	39
4.2.5 Test Setup.....	39
4.2.6 EUT Operating Conditions.....	39
4.2.7 Test Results	40
4.3 Transmit Power Measurement	42
4.3.1 Limits of Transmit Power Measurement	42
4.3.2 Test Setup.....	42
4.3.3 Test Instruments	42
4.3.4 Test Procedure	43
4.3.5 Deviation from Test Standard	43
4.3.6 EUT Operating Conditions.....	43
4.3.7 Test Result.....	44
4.4 Peak Power Spectral Density Measurement	49
4.4.1 Limits of Peak Power Spectral Density Measurement	49
4.4.2 Test Setup.....	49
4.4.3 Test Instruments	49
4.4.4 Test Procedures.....	49
4.4.5 Deviation from Test Standard	50
4.4.6 EUT Operating Conditions.....	50
4.4.7 Test Results	51
4.5 Frequency Stability.....	56
4.5.1 Limits of Frequency Stability Measurement	56
4.5.2 Test Setup.....	56
4.5.3 Test Instruments	56
4.5.4 Test Procedure	56
4.5.5 Deviation from Test Standard	56
4.5.6 EUT Operating Condition	56



4.5.7 Test Results	57
4.6 6dB Bandwidth Measurement.....	58
4.6.1 Limits of 6dB Bandwidth Measurement.....	58
4.6.2 Test Setup.....	58
4.6.3 Test Instruments	58
4.6.4 Test Procedure	58
4.6.5 Deviation from Test Standard	58
4.6.6 EUT Operating Condition	58
4.6.7 Test Results	59
5 Pictures of Test Arrangements.....	61
Appendix – Information on the Testing Laboratories	62



A D T

Release Control Record

Issue No.	Description	Date Issued
RF150427C31-1	Original release	Jun. 12, 2015



1 Certificate of Conformity

Product: 802.11 ac 2x2 Module

Brand: Fortinet Inc.

Test Model: PCE4302AN

Series Model: PCE4302AN-xxxxxx (where "x" can be used as "A-Z", or "-0-9", or "-", or blank for software changes or marketing purposes only)

Sample Status: Engineering sample

Applicant: Fortinet Inc.

Test Date: May 14 ~ May 29, 2015

Standards: 47 CFR FCC Part 15, Subpart E (Section 15.407)
ANSI C63.10:2009

The above equipment has been tested by **Bureau Veritas Consumer Products Services (H.K.) Ltd., Taoyuan Branch**, and found compliance with the requirement of the above standards. The test record, data evaluation & Equipment Under Test (EUT) configurations represented herein are true and accurate accounts of the measurements of the sample's EMC characteristics under the conditions specified in this report.

Prepared by : Celine Chou , **Date:** Jun. 12, 2015
Celine Chou / Specialist

Approved by : Ken Liu , **Date:** Jun. 12, 2015
Ken Liu / Senior Manager

2 Summary of Test Results

47 CFR FCC Part 15, Subpart E (SECTION 15.407)			
FCC Clause	Test Item	Result	Remarks
15.207 15.407(b)(6)	AC Power Conducted Emissions	Pass	Meet the requirement of limit. Minimum passing margin is -15.65dB at 4.34543MHz.
15.407(b) (1/2/3/4/6)	Radiated Emissions & Band Edge Measurement	Pass	Meet the requirement of limit. Minimum passing margin is -1.0dB at 5714.00MHz and 5280.00MHz.
15.407(a)(1/2 /3)	Max Average Transmit Power	Pass	Meet the requirement of limit.
15.407(a)(1/2 /3)	Peak Power Spectral Density	Pass	Meet the requirement of limit.
15.407(e)	6dB bandwidth	Pass	Meet the requirement of limit. (U-NII-3 Band only)
15.407(g)	Frequency Stability	Pass	Meet the requirement of limit.
15.203	Antenna Requirement	Pass	Antenna connectors is R-SMA not a standard connector.

2.1 Measurement Uncertainty

Where relevant, the following measurement uncertainty levels have been estimated for tests performed on the EUT as specified in CISPR 16-4-2:

Measurement	Frequency	Expanded Uncertainty (k=2) (±)
Conducted Emissions at mains ports0	150kHz ~ 30MHz	2.44 dB
Radiated Emissions up to 1 GHz	30MHz ~ 200MHz	3.86 dB
	200MHz ~1000MHz	3.87 dB
Radiated Emissions above 1 GHz	1GHz ~ 18GHz	2.29 dB
	18GHz ~ 40GHz	2.29 dB

2.2 Modification Record

There were no modifications required for compliance.

3 General Information

3.1 General Description of EUT

Product	802.11 ac 2x2 Module
Brand	Fortinet Inc.
Test Model	PCE4302AN
Series Model	PCE4302AN-xxxxxx (where “x” can be used as “A-Z”, or “-0-9”, or “-“, or blank for software changes or marketing purposes only)
Model Difference	For software changes or marketing purposes only
Status of EUT	Engineering sample
Power Supply Rating	3.3Vdc (External Board)
Modulation Type	256QAM, 64QAM, 16QAM, QPSK, BPSK for OFDM
Modulation Technology	OFDM
Transfer Rate	802.11a: 54.0/ 48.0/ 36.0/ 24.0/ 18.0/ 12.0/ 9.0/ 6.0Mbps 802.11n: up to 300Mbps 802.11ac: up to 867Mbps
Operating Frequency	5180 ~ 5240MHz, 5745 ~ 5825MHz
Number of Channel	5180 ~ 5240MHz: 4 for 802.11a, 802.11n (HT20), 802.11ac (VHT20) 2 for 802.11n (HT40), 802.11ac (VHT40) 1 for 802.11ac (VHT80) 5745 ~ 5825MHz: 5 for 802.11a, 802.11n (HT20), 802.11ac (VHT20) 2 for 802.11n (HT40), 802.11ac (VHT40) 1 for 802.11ac (VHT80)
Output Power	5180 ~ 5240MHz: 246.350mW 5745 ~ 5825MHz: 50.231mW
Antenna Type	Refer to Note
Antenna Connector	Refer to Note
Accessory Device	NA
Data Cable Supplied	NA

Note:

1. The module will limited at in-door use only
2. The EUT incorporates a MIMO function. Physically, the EUT provides 2 completed transmitters and 2 receivers.

Modulation Mode	TX Function
802.11a	2TX
802.11n (HT20)	2TX
802.11n (HT40)	2TX
802.11ac (VHT20)	2TX
802.11ac (VHT40)	2TX
802.11ac (VHT80)	2TX

* The modulation and bandwidth are similar for 802.11n mode for 20MHz/40MHz and 802.11ac mode for 20MHz/40MHz, therefore investigated worst case to representative mode in test report. (Final test mode refer section 3.2.1)

3. The EUT uses following adapter. (For support unit only)

Adapter	
Brand	DVE
Model	DSA-12G-12 FUS 120120
Input	100-240Vac, 50/60Hz, 0.3A
Output	12Vdc, 1A
Power Line	1.5m cable without core attached on adapter

4. The following antennas were provided to the EUT.

No.	Type	Gain(dBi)		Connector
		2.4GHz Band	5GHz Band	
1	Dipole	3	6	R-SMA
2	Dipole	2	3	R-SMA

3.2 Description of Test Modes

For 5180 ~ 5240MHz

4 channels are provided for 802.11a, 802.11n (HT20), 802.11ac (VHT20):

Channel	Frequency	Channel	Frequency
36	5180 MHz	44	5220 MHz
40	5200 MHz	48	5240 MHz

2 channels are provided for 802.11n (HT40), 802.11ac (VHT40):

Channel	Frequency	Channel	Frequency
38	5190 MHz	46	5230 MHz

1 channel is provided for 802.11ac (VHT80):

Channel	Frequency
42	5210MHz

For 5745 ~ 5825MHz:

5 channels are provided for 802.11a, 802.11n (HT20), 802.11ac (VHT20):

Channel	Frequency	Channel	Frequency
149	5745MHz	161	5805MHz
153	5765MHz	165	5825MHz
157	5785MHz		

2 channels are provided for 802.11n (HT40), 802.11ac (VHT40):

Channel	Frequency	Channel	Frequency
151	5755MHz	159	5795MHz

1 channel is provided for 802.11ac (VHT80):

Channel	Frequency
155	5775MHz

3.2.1 Test Mode Applicability and Tested Channel Detail

EUT CONFIGURE MODE	APPLICABLE TO				DESCRIPTION
	RE \geq 1G	RE<1G	PLC	APCM	
-	√	√	√	√	-

Where **RE \geq 1G**: Radiated Emission above 1GHz & Bandedge Measurement
RE<1G: Radiated Emission below 1GHz
PLC: Power Line Conducted Emission
APCM: Antenna Port Conducted Measurement

Note: The EUT had been pre-tested on the positioned of each 3 axis. The worst case was found when positioned on **X-plane**.

Radiated Emission Test (Above 1GHz):

- Pre-Scan has been conducted to determine the worst-case mode from all possible combinations between available modulations, data rates and antenna ports (if EUT with antenna diversity architecture).
- Following channel(s) was (were) selected for the final test as listed below.

EUT CONFIGURE MODE	MODE	FREQ. BAND (MHz)	AVAILABLE CHANNEL	TESTED CHANNEL	MODULATION TECHNOLOGY	MODULATION TYPE	DATA RATE (Mbps)
-	802.11a	5180-5240	36 to 48	36, 40, 48	OFDM	BPSK	6.0
-	802.11n (HT20)		36 to 48	36, 40, 48	OFDM	BPSK	7.2
-	802.11n (HT40)		38 to 46	38, 46	OFDM	BPSK	15.0
-	802.11ac (VHT80)		42	42	OFDM	BPSK	65.0
-	802.11a	5745-5825	149 to 165	149, 157, 165	OFDM	BPSK	6.0
-	802.11n (HT20)		149 to 165	149, 157, 165	OFDM	BPSK	7.2
-	802.11n (HT40)		151 to 159	151, 159	OFDM	BPSK	15.0
-	802.11ac (VHT80)		155	155	OFDM	BPSK	65.0

Radiated Emission Test (Below 1GHz):

- Pre-Scan has been conducted to determine the worst-case mode from all possible combinations between available modulations, data rates and antenna ports (if EUT with antenna diversity architecture).
- Following channel(s) was (were) selected for the final test as listed below.

EUT CONFIGURE MODE	MODE	FREQ. BAND (MHz)	AVAILABLE CHANNEL	TESTED CHANNEL	MODULATION TECHNOLOGY	MODULATION TYPE	DATA RATE (Mbps)
-	802.11a	5180-5240	36 to 48	36	OFDM	BPSK	6.0
	802.11a	5745-5825	149 to 165		OFDM	BPSK	6.0

Power Line Conducted Emission Test:

- Pre-Scan has been conducted to determine the worst-case mode from all possible combinations between available modulations, data rates and antenna ports (if EUT with antenna diversity architecture).
- Following channel(s) was (were) selected for the final test as listed below.

EUT CONFIGURE MODE	MODE	FREQ. BAND (MHz)	AVAILABLE CHANNEL	TESTED CHANNEL	MODULATION TECHNOLOGY	MODULATION TYPE	DATA RATE (Mbps)
-	802.11a	5180-5240	36 to 48	36	OFDM	BPSK	6.0
	802.11a	5745-5825	149 to 165		OFDM	BPSK	6.0

Antenna Port Conducted Measurement:

- This item includes all test value of each mode, but only includes spectrum plot of worst value of each mode.
- Pre-Scan has been conducted to determine the worst-case mode from all possible combinations between available modulations, data rates and antenna ports (if EUT with antenna diversity architecture).
- Following channel(s) was (were) selected for the final test as listed below.

EUT CONFIGURE MODE	MODE	FREQ. BAND (MHz)	AVAILABLE CHANNEL	TESTED CHANNEL	MODULATION TECHNOLOGY	MODULATION TYPE	DATA RATE (Mbps)
-	802.11a	5180-5240	36 to 48	36, 40, 48	OFDM	BPSK	6.0
-	802.11n (HT20)		36 to 48	36, 40, 48	OFDM	BPSK	7.2
-	802.11n (HT40)		38 to 46	38, 46	OFDM	BPSK	15.0
-	802.11ac (VHT80)		42	42	OFDM	BPSK	65.0
-	802.11a	5745-5825	149 to 165	149, 157, 165	OFDM	BPSK	6.0
-	802.11n (HT20)		149 to 165	149, 157, 165	OFDM	BPSK	7.2
-	802.11n (HT40)		151 to 159	151, 159	OFDM	BPSK	15.0
-	802.11ac (VHT80)		155	155	OFDM	BPSK	65.0

Test Condition:

APPLICABLE TO	ENVIRONMENTAL CONDITIONS	INPUT POWER	TESTED BY
RE \geq 1G	19deg. C, 69%RH	120Vac, 60Hz	Jones Chang
RE $<$ 1G	20deg. C, 69%RH	120Vac, 60Hz	Jones Chang
PLC	23deg. C, 70%RH	120Vac, 60Hz	Jones Chang
APCM	25deg. C, 60%RH	120Vac, 60Hz	Leo Tsai

3.3 Duty Cycle of Test Signal

Duty cycle of test signal is < 98 %, duty factor is required

802.11a: Duty cycle = $2.022/2.105 = 0.961$, Duty factor = $10 * \log(1/0.961) = 0.17$

802.11n (HT20): Duty cycle = $1.879/2.024 = 0.928$, Duty factor = $10 * \log(1/0.928) = 0.32$

802.11n (HT40): Duty cycle = $0.922/0.999 = 0.923$, Duty factor = $10 * \log(1/0.923) = 0.35$

802.11ac (VHT80): Duty cycle = $0.452/0.545 = 0.829$, Duty factor = $10 * \log(1/0.829) = 0.81$

802.11a

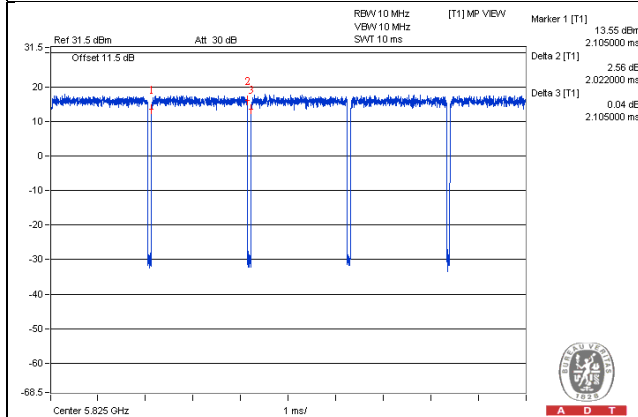

802.11n (HT20)

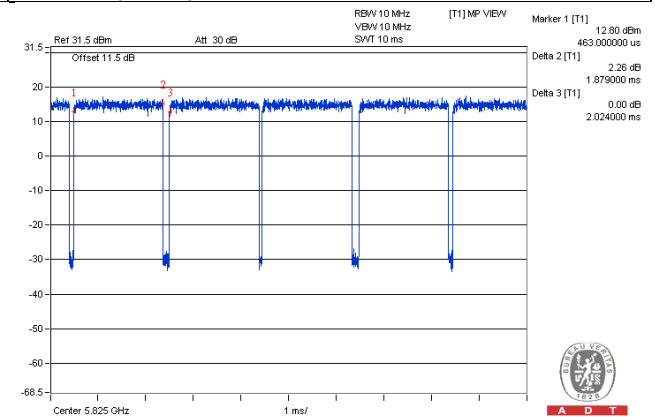

802.11n (HT40)

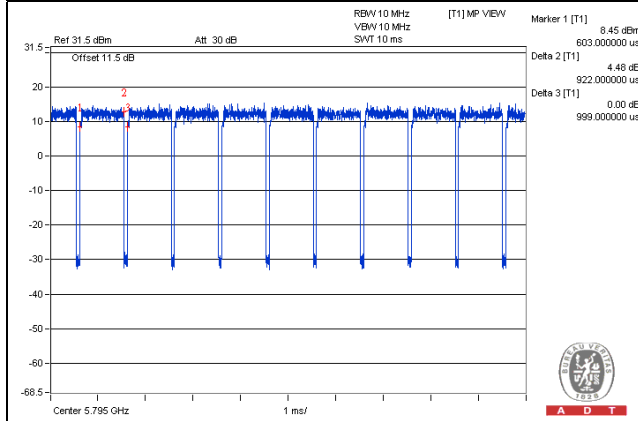

802.11ac (VHT80)

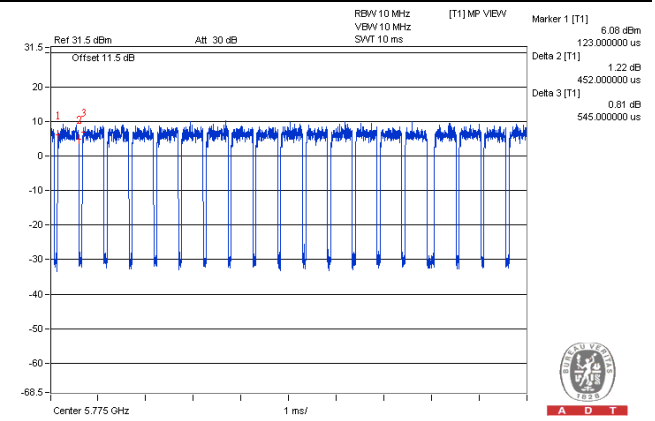

3.4 Description of Support Units

The EUT has been tested as an independent unit together with other necessary accessories or support units. The following support units or accessories were used to form a representative test configuration during the tests.

ID	Product	Brand	Model No.	Serial No.	FCC ID	Remarks
A.	Notebook	DELL	E5410	1HC2XM1	FCC DoC Approved	-
B.	External Board	NA	NA	NA	NA	Provided by Manufacturer
C.	Adapter	DVE	DSA-12G-12 FUS 120120	NA	NA	Provided by Manufacturer

Note:

1. All power cords of the above support units are non-shielded (1.8m).
2. Item A acted as a communication partner to transfer data.

ID	Descriptions	Qty.	Length (m)	Shielding (Yes/No)	Cores (Qty.)	Remarks
1.	RJ45 , Cat5e	1	3	N	0	-
2.	Power	1	1.5	N	0	Attached on adapter Provided by Manufacturer

3.4.1 Configuration of System under Test

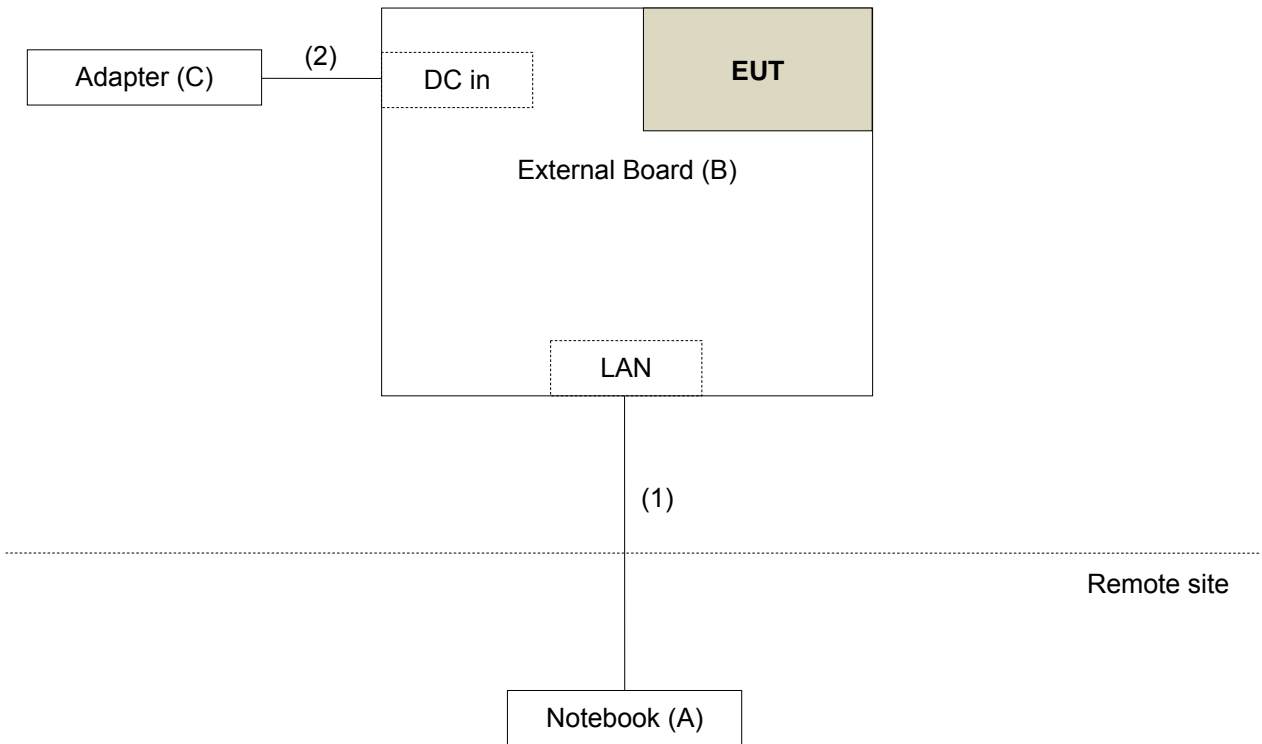

3.5 General Description of Applied Standards

The EUT is a RF Product. According to the specifications of the manufacturer, it must comply with the requirements of the following standards:

FCC Part 15, Subpart E (15.407)
789033 D02 General UNII Test Procedures New Rules v01
662911 D01 Multiple Transmitter Output v02r01
ANSI C63.10-2009

All test items have been performed and recorded as per the above standards.

4 Test Types and Results

4.1 Radiated Emission and Bandedge Measurement

4.1.1 Limits of Radiated Emission and Bandedge Measurement

Radiated emissions which fall in the restricted bands must comply with the radiated emission limits specified as below table.

Frequencies (MHz)	Field Strength (microvolts/meter)	Measurement Distance (meters)
0.009 ~ 0.490	2400/F(kHz)	300
0.490 ~ 1.705	24000/F(kHz)	30
1.705 ~ 30.0	30	30
30 ~ 88	100	3
88 ~ 216	150	3
216 ~ 960	200	3
Above 960	500	3

NOTE:

1. The lower limit shall apply at the transition frequencies.
2. Emission level (dBuV/m) = 20 log Emission level (uV/m).
3. For frequencies above 1000MHz, the field strength limits are based on average detector, however, the peak field strength of any emission shall not exceed the maximum permitted average limits, specified above by more than 20dB under any condition of modulation.

LIMITS OF UNWANTED EMISSION OUT OF THE RESTRICTED BANDS

APPLICABLE TO	LIMIT	
789033 D02 General UNII Test Procedures New Rules v01	FIELD STRENGTH AT 3m	
	PK:74 (dBµV/m)	AV:54 (dBµV/m)
APPLICABLE TO	EIRP LIMIT	EQUIVALENT FIELD STRENGTH AT 3m
15.407(b)(1)	PK:-27 (dBm/MHz)	PK:68.2(dBµV/m)
15.407(b)(2)		
15.407(b)(3)		
15.407(b)(4)	PK:-27 (dBm/MHz) ^{*1} PK:-17 (dBm/MHz) ^{*2}	PK: 68.2(dBµV/m) ^{*1} PK:78.2 (dBµV/m) ^{*2}

NOTE: ^{*1} beyond 10MHz of the band edge ^{*2} within 10 MHz of band edge

The following formula is used to convert the equipment isotropic radiated power (eirp) to field strength:

$$E = \frac{1000000\sqrt{30P}}{3} \mu\text{V/m, where P is the eirp (Watts).}$$



4.1.2 Test Instruments

Description & Manufacturer	Model No.	Serial No.	Date Of Calibration	Due Date Of Calibration
Test Receiver ROHDE & SCHWARZ	ESIB7	100187	Apr. 10, 2015	Apr. 09, 2016
Spectrum Analyzer ROHDE & SCHWARZ	FSP40	100041	Aug. 29, 2014	Aug. 28, 2015
BILOG Antenna SCHWARZBECK	VULB9168	9168-160	Feb. 05, 2015	Feb. 04, 2016
HORN Antenna SCHWARZBECK	9120D	209	Feb. 09, 2015	Feb. 08, 2016
HORN Antenna SCHWARZBECK	BBHA 9170	BBHA9170241	Feb. 09, 2015	Feb. 08, 2016
Preamplifier Agilent	8447D	2944A10738	Oct.18, 2014	Oct. 17, 2015
Preamplifier Agilent	8449B	3008A01964	Aug. 22, 2014	Aug. 21, 2015
RF signal cable HUBER+SUHNNER	SUCOFLEX 104	214378/4	Aug. 22, 2014	Aug. 21, 2015
RF signal cable HUBER+SUHNNER	SUCOFLEX 106	12738/6 +309224/4	Aug. 22, 2014	Aug. 21, 2015
Software BV ADT	ADT_Radiated_ V7.6.15.9.4	NA	NA	NA
Antenna Tower inn-co GmbH	MA 4000	013303	NA	NA
Antenna Tower Controller BV ADT	AT100	AT93021702	NA	NA
Turn Table BV ADT	TT100	TT93021702	NA	NA
Turn Table Controller BV ADT	SC100	SC93021702	NA	NA
26GHz ~ 40GHz Amplifier	EM26400	815221	Oct. 18, 2014	Oct. 17, 2015
High Speed Power Meter	ML2495A	0824011	Jul. 26, 2014	Jul. 25, 2015
Power Sensor	MA2411B	0738171	Jul. 26, 2014	Jul. 25, 2015
WIT Standard Temperature And Humidity Chamber	TH-4S-C	W981030	Jun. 09, 2014	Jun. 08, 2015
			Jun. 09, 2015	Jun. 08, 2016

- Note:**
1. The calibration interval of the above test instruments is 12 months and the calibrations are traceable to NML/ROC and NIST/USA.
 2. The test was performed in HwaYa Chamber 3.
 3. The horn antenna and HP preamplifier (model: 8449B) are used only for the measurement of emission frequency above 1GHz if tested.
 4. The FCC Site Registration No. is 988962.
 5. The IC Site Registration No. is IC 7450F-3.

4.1.3 Test Procedures

- a. The EUT was placed on the top of a rotating table 0.8 meters above the ground at 3 meter chamber room for test. The table was rotated 360 degrees to determine the position of the highest radiation.
- b. The EUT was set 3 meters away from the interference-receiving antenna, which was mounted on the top of a variable-height antenna tower.
- c. The height of antenna is varied from one meter to four meters above the ground to determine the maximum value of the field strength. Both horizontal and vertical polarizations of the antenna are set to make the measurement.
- d. For each suspected emission, the EUT was arranged to its worst case and then the antenna was tuned to heights from 1 meter to 4 meters and the rotatable table was turned from 0 degrees to 360 degrees to find the maximum reading.
- e. The test-receiver system was set to quasi-peak detect function and specified bandwidth with maximum hold mode when the test frequency is below 1 GHz.
- f. The test-receiver system was set to peak and average detect function and specified bandwidth with maximum hold mode when the test frequency is above 1 GHz. If the peak reading value also meets average limit, measurement with the average detector is unnecessary.

Note:

1. For emission measurements above 1 GHz, the EUT shall be placed at a height of 1.5 m above the ground at 3 meter chamber room for test.
2. The resolution bandwidth and video bandwidth of test receiver/spectrum analyzer is 120kHz for Quasi-peak detection (QP) at frequency below 1GHz.
3. The resolution bandwidth of test receiver/spectrum analyzer is 1 MHz and the video bandwidth is 3 MHz for Peak detection (PK) at frequency above 1GHz.
4. The resolution bandwidth of test receiver/spectrum analyzer is 1MHz and the video bandwidth is 3MHz for RMS Average (Duty cycle < 98%) for Average detection (AV) at frequency above 1GHz, then the measurement results was added to a correction factor ($10 \log(1/\text{duty cycle})$).
5. The resolution bandwidth of test receiver/spectrum analyzer is 1MHz and the video bandwidth is 10Hz (Duty cycle $\geq 98\%$) for Average detection (AV) at frequency above 1GHz.
6. All modes of operation were investigated and the worst-case emissions are reported.

4.1.4 Deviation from Test Standard

No deviation.

4.1.5 Test Set Up

<Frequency Range below 1GHz>

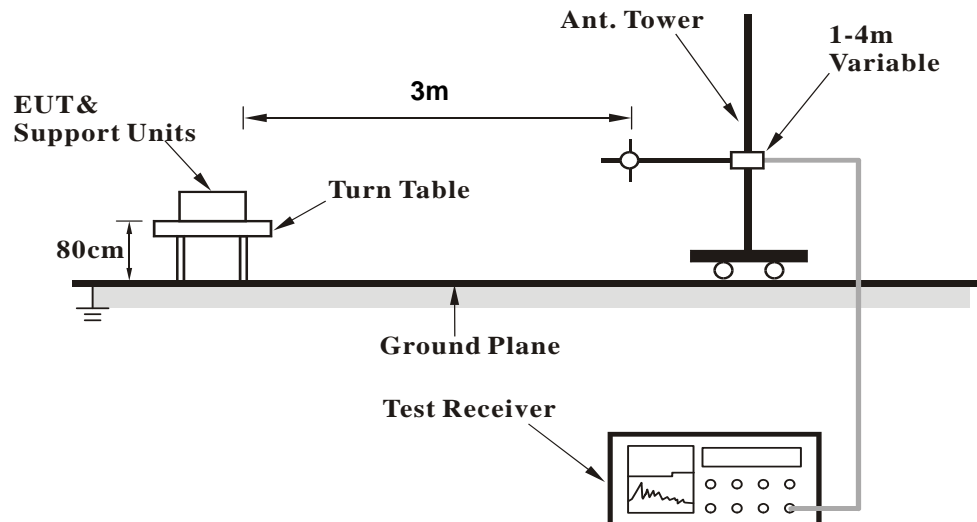

<Frequency Range above 1GHz>

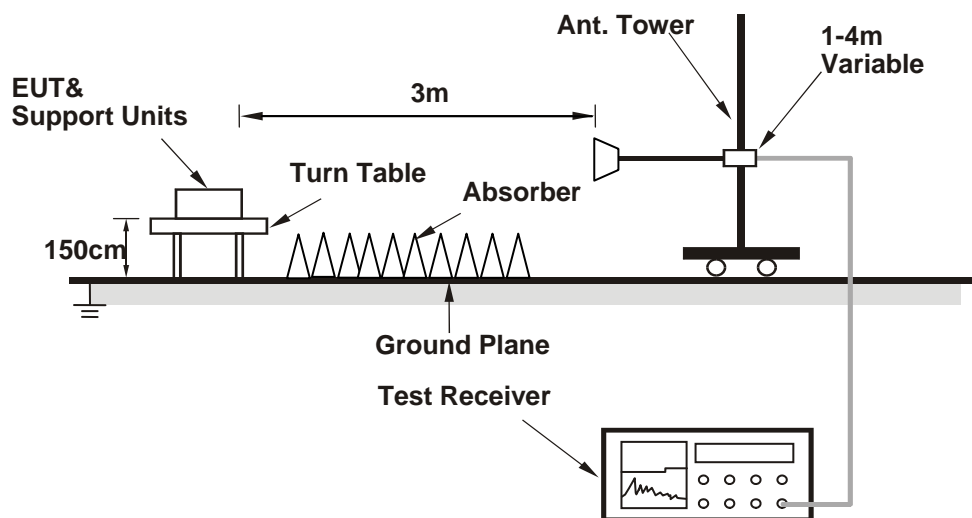

For the actual test configuration, please refer to the attached file (Test Setup Photo)

4.1.6 EUT Operating Conditions

- Installed EUT in external board and placed them on the testing table.
- Prepared a notebook to act as a communication partner and placed it outside of testing area.
- The communication partner connected with EUT via external board through a RJ45 cable and ran a test program (provided by manufacturer) to enable EUT under transmission condition continuously at specific channel frequency.
- The communication partner sent data to EUT by command "PING".

4.1.7 Test Results

Above 1GHz Data

802.11a

CHANNEL	TX Channel 36	DETECTOR FUNCTION	Peak (PK)
FREQUENCY RANGE	1GHz ~ 40GHz		Average (AV)

ANTENNA POLARITY & TEST DISTANCE: HORIZONTAL AT 3 M								
NO.	FREQ. (MHz)	EMISSION LEVEL (dBuV/m)	LIMIT (dBuV/m)	MARGIN (dB)	ANTENNA HEIGHT (m)	TABLE ANGLE (Degree)	RAW VALUE (dBuV)	CORRECTION FACTOR (dB/m)
1	5150.00	57.6 PK	74.0	-16.4	1.23 H	215	51.60	6.00
2	5150.00	46.4 AV	54.0	-7.6	1.23 H	215	40.40	6.00
3	*5180.00	104.7 PK			1.18 H	130	65.20	39.50
4	*5180.00	94.5 AV			1.18 H	130	55.00	39.50
5	5350.00	58.2 PK	74.0	-15.8	1.30 H	304	52.10	6.10
6	5350.00	47.1 AV	54.0	-6.9	1.30 H	304	41.00	6.10
7	#10360.00	60.5 PK	74.0	-13.5	1.50 H	252	42.10	18.40
8	#10360.00	47.4 AV	54.0	-6.6	1.50 H	252	29.00	18.40
ANTENNA POLARITY & TEST DISTANCE: VERTICAL AT 3 M								
NO.	FREQ. (MHz)	EMISSION LEVEL (dBuV/m)	LIMIT (dBuV/m)	MARGIN (dB)	ANTENNA HEIGHT (m)	TABLE ANGLE (Degree)	RAW VALUE (dBuV)	CORRECTION FACTOR (dB/m)
1	5150.00	69.4 PK	74.0	-4.6	1.71 V	254	63.40	6.00
2	5150.00	52.1 AV	54.0	-1.9	1.71 V	254	46.10	6.00
3	*5180.00	118.7 PK			1.71 V	276	79.20	39.50
4	*5180.00	108.9 AV			1.71 V	276	69.40	39.50
5	5350.00	64.6 PK	74.0	-9.4	1.88 V	275	58.50	6.10
6	5350.00	51.6 AV	54.0	-2.4	1.88 V	275	45.50	6.10
7	#10360.00	61.2 PK	74.0	-12.8	1.48 V	354	42.80	18.40
8	#10360.00	48.1 AV	54.0	-5.9	1.48 V	354	29.70	18.40

Remarks:

1. Emission Level(dBuV/m) = Raw Value(dBuV) + Correction Factor(dB/m)
2. Correction Factor(dB/m) = Antenna Factor(dB/m) + Cable Factor(dB)
3. The other emission levels were very low against the limit.
4. Margin value = Emission Level – Limit value
5. " * ": Fundamental frequency.
6. " # ": The radiated frequency is out of the restricted band.

CHANNEL	TX Channel 40	DETECTOR FUNCTION	Peak (PK)
FREQUENCY RANGE	1GHz ~ 40GHz		Average (AV)

ANTENNA POLARITY & TEST DISTANCE: HORIZONTAL AT 3 M

NO.	FREQ. (MHz)	EMISSION LEVEL (dBuV/m)	LIMIT (dBuV/m)	MARGIN (dB)	ANTENNA HEIGHT (m)	TABLE ANGLE (Degree)	RAW VALUE (dBuV)	CORRECTION FACTOR (dB/m)
1	5150.00	58.9 PK	74.0	-15.1	1.40 H	217	52.90	6.00
2	5150.00	47.0 AV	54.0	-7.0	1.40 H	217	41.00	6.00
3	*5200.00	104.1 PK			1.57 H	57	64.50	39.60
4	*5200.00	93.9 AV			1.57 H	57	54.30	39.60
5	5440.00	58.3 PK	74.0	-15.7	1.57 H	19	52.00	6.30
6	5440.00	46.6 AV	54.0	-7.4	1.57 H	19	40.30	6.30
7	#10400.00	60.6 PK	74.0	-13.4	1.29 H	256	42.10	18.50
8	#10400.00	47.4 AV	54.0	-6.6	1.29 H	256	28.90	18.50

ANTENNA POLARITY & TEST DISTANCE: VERTICAL AT 3 M

NO.	FREQ. (MHz)	EMISSION LEVEL (dBuV/m)	LIMIT (dBuV/m)	MARGIN (dB)	ANTENNA HEIGHT (m)	TABLE ANGLE (Degree)	RAW VALUE (dBuV)	CORRECTION FACTOR (dB/m)
1	5150.00	66.5 PK	74.0	-7.5	2.00 V	273	60.50	6.00
2	5150.00	52.1 AV	54.0	-1.9	2.00 V	273	46.10	6.00
3	*5200.00	120.9 PK			1.96 V	276	81.30	39.60
4	*5200.00	110.9 AV			1.96 V	276	71.30	39.60
5	5360.00	65.6 PK	74.0	-8.4	1.69 V	274	59.50	6.10
6	5360.00	52.6 AV	54.0	-1.4	1.69 V	274	46.50	6.10
7	#10400.00	65.2 PK	74.0	-8.8	2.05 V	70	46.70	18.50
8	#10400.00	51.0 AV	54.0	-3.0	2.05 V	70	32.50	18.50

Remarks:

1. Emission Level(dBuV/m) = Raw Value(dBuV) + Correction Factor(dB/m)
2. Correction Factor(dB/m) = Antenna Factor(dB/m) + Cable Factor(dB)
3. The other emission levels were very low against the limit.
4. Margin value = Emission Level – Limit value
5. " * ": Fundamental frequency.
6. " # ": The radiated frequency is out of the restricted band.

CHANNEL	TX Channel 48	DETECTOR FUNCTION	Peak (PK)
FREQUENCY RANGE	1GHz ~ 40GHz		Average (AV)

ANTENNA POLARITY & TEST DISTANCE: HORIZONTAL AT 3 M								
NO.	FREQ. (MHz)	EMISSION LEVEL (dBuV/m)	LIMIT (dBuV/m)	MARGIN (dB)	ANTENNA HEIGHT (m)	TABLE ANGLE (Degree)	RAW VALUE (dBuV)	CORRECTION FACTOR (dB/m)
1	*5240.00	107.3 PK			1.20 H	110	67.70	39.60
2	*5240.00	96.5 AV			1.20 H	110	56.90	39.60
3	5400.00	58.4 PK	74.0	-15.6	1.28 H	72	52.10	6.30
4	5400.00	46.3 AV	54.0	-7.7	1.28 H	72	40.00	6.30
5	#10480.00	61.3 PK	74.0	-12.7	1.39 H	244	42.30	19.00
6	#10480.00	48.2 AV	54.0	-5.8	1.39 H	244	29.20	19.00
ANTENNA POLARITY & TEST DISTANCE: VERTICAL AT 3 M								
NO.	FREQ. (MHz)	EMISSION LEVEL (dBuV/m)	LIMIT (dBuV/m)	MARGIN (dB)	ANTENNA HEIGHT (m)	TABLE ANGLE (Degree)	RAW VALUE (dBuV)	CORRECTION FACTOR (dB/m)
1	*5240.00	120.5 PK			1.79 V	277	80.90	39.60
2	*5240.00	110.4 AV			1.79 V	277	70.80	39.60
3	5360.00	66.0 PK	74.0	-8.0	1.91 V	277	59.90	6.10
4	5360.00	52.5 AV	54.0	-1.5	1.91 V	277	46.40	6.10
5	#10480.00	65.3 PK	74.0	-8.7	2.01 V	88	46.30	19.00
6	#10480.00	51.4 AV	54.0	-2.6	2.01 V	88	32.40	19.00

Remarks:

1. Emission Level(dBuV/m) = Raw Value(dBuV) + Correction Factor(dB/m)
2. Correction Factor(dB/m) = Antenna Factor(dB/m) + Cable Factor(dB)
3. The other emission levels were very low against the limit.
4. Margin value = Emission Level – Limit value
5. " * ": Fundamental frequency.
6. " # ": The radiated frequency is out of the restricted band.

CHANNEL	TX Channel 149	DETECTOR FUNCTION	Peak (PK)
FREQUENCY RANGE	1GHz ~ 40GHz		Average (AV)

ANTENNA POLARITY & TEST DISTANCE: HORIZONTAL AT 3 M

NO.	FREQ. (MHz)	EMISSION LEVEL (dBuV/m)	LIMIT (dBuV/m)	MARGIN (dB)	ANTENNA HEIGHT (m)	TABLE ANGLE (Degree)	RAW VALUE (dBuV)	CORRECTION FACTOR (dB/m)
1	5400.00	58.4 PK	74.0	-15.6	1.44 H	116	52.10	6.30
2	5400.00	47.2 AV	54.0	-6.8	1.44 H	116	40.90	6.30
3	#5722.00	60.3 PK	78.2	-17.9	1.15 H	121	53.50	6.80
4	#5725.00	57.4 PK	78.2	-20.8	1.15 H	121	50.60	6.80
5	*5745.00	102.0 PK			1.15 H	119	61.60	40.40
6	*5745.00	92.0 AV			1.15 H	119	51.60	40.40
7	11490.00	60.2 PK	74.0	-13.8	1.00 H	277	41.80	18.40
8	11490.00	47.1 AV	54.0	-6.9	1.00 H	277	28.70	18.40

ANTENNA POLARITY & TEST DISTANCE: VERTICAL AT 3 M

NO.	FREQ. (MHz)	EMISSION LEVEL (dBuV/m)	LIMIT (dBuV/m)	MARGIN (dB)	ANTENNA HEIGHT (m)	TABLE ANGLE (Degree)	RAW VALUE (dBuV)	CORRECTION FACTOR (dB/m)
1	#5280.00	66.8 PK	68.2	-1.4	1.91 V	272	60.70	6.10
2	5360.00	65.7 PK	74.0	-8.3	1.91 V	73	59.60	6.10
3	5360.00	52.4 AV	54.0	-1.6	1.91 V	73	46.30	6.10
4	#5722.00	67.9 PK	78.2	-10.3	1.89 V	273	61.10	6.80
5	#5725.00	57.3 PK	78.2	-20.9	1.89 V	273	50.50	6.80
6	*5745.00	113.8 PK			1.85 V	67	73.40	40.40
7	*5745.00	103.7 AV			1.85 V	67	63.30	40.40
8	11490.00	60.9 PK	74.0	-13.1	1.70 V	283	42.50	18.40
9	11490.00	47.5 AV	54.0	-6.5	1.70 V	283	29.10	18.40

Remarks:

1. Emission Level(dBuV/m) = Raw Value(dBuV) + Correction Factor(dB/m)
2. Correction Factor(dB/m) = Antenna Factor(dB/m) + Cable Factor(dB)
3. The other emission levels were very low against the limit.
4. Margin value = Emission Level – Limit value
5. " * ": Fundamental frequency.
6. " # ": The radiated frequency is out of the restricted band.

CHANNEL	TX Channel 157	DETECTOR FUNCTION	Peak (PK)
FREQUENCY RANGE	1GHz ~ 40GHz		Average (AV)

ANTENNA POLARITY & TEST DISTANCE: HORIZONTAL AT 3 M								
NO.	FREQ. (MHz)	EMISSION LEVEL (dBuV/m)	LIMIT (dBuV/m)	MARGIN (dB)	ANTENNA HEIGHT (m)	TABLE ANGLE (Degree)	RAW VALUE (dBuV)	CORRECTION FACTOR (dB/m)
1	5350.00	59.2 PK	74.0	-14.8	1.50 H	201	53.10	6.10
2	5350.00	48.1 AV	54.0	-5.9	1.50 H	201	42.00	6.10
3	*5785.00	101.6 PK			1.20 H	122	61.10	40.50
4	*5785.00	90.8 AV			1.20 H	122	50.30	40.50
5	11570.00	60.9 PK	74.0	-13.1	1.21 H	64	42.50	18.40
6	11570.00	47.4 AV	54.0	-6.6	1.21 H	64	29.00	18.40
ANTENNA POLARITY & TEST DISTANCE: VERTICAL AT 3 M								
NO.	FREQ. (MHz)	EMISSION LEVEL (dBuV/m)	LIMIT (dBuV/m)	MARGIN (dB)	ANTENNA HEIGHT (m)	TABLE ANGLE (Degree)	RAW VALUE (dBuV)	CORRECTION FACTOR (dB/m)
1	#5280.00	66.7 PK	68.2	-1.5	2.00 V	244	60.60	6.10
2	5360.00	64.2 PK	74.0	-9.8	1.86 V	72	58.10	6.10
3	5360.00	51.7 AV	54.0	-2.3	1.86 V	72	45.60	6.10
4	*5785.00	112.7 PK			1.83 V	68	72.20	40.50
5	*5785.00	102.7 AV			1.83 V	68	62.20	40.50
6	11570.00	61.0 PK	74.0	-13.0	1.62 V	280	42.60	18.40
7	11570.00	47.8 AV	54.0	-6.2	1.62 V	280	29.40	18.40

Remarks:

1. Emission Level(dBuV/m) = Raw Value(dBuV) + Correction Factor(dB/m)
2. Correction Factor(dB/m) = Antenna Factor(dB/m) + Cable Factor(dB)
3. The other emission levels were very low against the limit.
4. Margin value = Emission Level – Limit value
5. " * ": Fundamental frequency.

CHANNEL	TX Channel 165	DETECTOR FUNCTION	Peak (PK)
FREQUENCY RANGE	1GHz ~ 40GHz		Average (AV)

ANTENNA POLARITY & TEST DISTANCE: HORIZONTAL AT 3 M

NO.	FREQ. (MHz)	EMISSION LEVEL (dBuV/m)	LIMIT (dBuV/m)	MARGIN (dB)	ANTENNA HEIGHT (m)	TABLE ANGLE (Degree)	RAW VALUE (dBuV)	CORRECTION FACTOR (dB/m)
1	5350.00	57.6 PK	74.0	-16.4	1.30 H	279	51.50	6.10
2	5350.00	46.4 AV	54.0	-7.6	1.30 H	279	40.30	6.10
3	*5825.00	101.5 PK			1.18 H	126	61.00	40.50
4	*5825.00	90.6 AV			1.18 H	126	50.10	40.50
5	#5850.00	57.4 PK	78.2	-20.8	1.16 H	111	50.50	6.90
6	#5853.00	59.6 PK	78.2	-18.6	1.16 H	111	52.60	7.00
7	#5861.00	57.4 PK	74.0	-16.6	1.21 H	129	50.40	7.00
8	#5861.00	46.5 AV	54.0	-7.5	1.21 H	129	39.50	7.00
9	11650.00	61.1 PK	74.0	-12.9	1.00 H	215	42.20	18.90
10	11650.00	47.8 AV	54.0	-6.2	1.00 H	215	28.90	18.90

ANTENNA POLARITY & TEST DISTANCE: VERTICAL AT 3 M

NO.	FREQ. (MHz)	EMISSION LEVEL (dBuV/m)	LIMIT (dBuV/m)	MARGIN (dB)	ANTENNA HEIGHT (m)	TABLE ANGLE (Degree)	RAW VALUE (dBuV)	CORRECTION FACTOR (dB/m)
1	#5280.00	67.2 PK	68.2	-1.0	2.01 V	270	61.10	6.10
2	5360.00	65.6 PK	74.0	-8.4	2.01 V	72	59.50	6.10
3	5360.00	52.8 AV	54.0	-1.2	2.01 V	72	46.70	6.10
4	*5825.00	113.0 PK			1.83 V	66	72.50	40.50
5	*5825.00	102.8 AV			1.83 V	66	62.30	40.50
6	#5850.00	61.2 PK	78.2	-17.0	1.92 V	61	54.30	6.90
7	#5853.00	62.3 PK	78.2	-15.9	1.92 V	61	55.30	7.00
8	#5861.00	60.5 PK	74.0	-13.5	1.86 V	76	53.50	7.00
9	#5861.00	47.2 AV	54.0	-6.8	1.86 V	76	40.20	7.00
10	11650.00	61.8 PK	74.0	-12.2	1.68 V	225	42.90	18.90
11	11650.00	48.6 AV	54.0	-5.4	1.68 V	225	29.70	18.90

Remarks:

1. Emission Level(dBuV/m) = Raw Value(dBuV) + Correction Factor(dB/m)
2. Correction Factor(dB/m) = Antenna Factor(dB/m) + Cable Factor(dB)
3. The other emission levels were very low against the limit.
4. Margin value = Emission Level – Limit value
5. " * ": Fundamental frequency.
6. " # ": The radiated frequency is out of the restricted band.

802.11n (HT20)

CHANNEL	TX Channel 36	DETECTOR FUNCTION	Peak (PK)
FREQUENCY RANGE	1GHz ~ 40GHz		Average (AV)

ANTENNA POLARITY & TEST DISTANCE: HORIZONTAL AT 3 M

NO.	FREQ. (MHz)	EMISSION LEVEL (dBuV/m)	LIMIT (dBuV/m)	MARGIN (dB)	ANTENNA HEIGHT (m)	TABLE ANGLE (Degree)	RAW VALUE (dBuV)	CORRECTION FACTOR (dB/m)
1	5150.00	57.5 PK	74.0	-16.5	1.28 H	306	51.50	6.00
2	5150.00	46.3 AV	54.0	-7.7	1.28 H	306	40.30	6.00
3	*5180.00	102.6 PK			1.28 H	237	63.10	39.50
4	*5180.00	92.8 AV			1.28 H	237	53.30	39.50
5	5350.00	58.7 PK	74.0	-15.3	1.33 H	202	52.60	6.10
6	5350.00	47.6 AV	54.0	-6.4	1.33 H	202	41.50	6.10
7	#10360.00	60.5 PK	74.0	-13.5	1.00 H	123	42.10	18.40
8	#10360.00	47.3 AV	54.0	-6.7	1.00 H	123	28.90	18.40

ANTENNA POLARITY & TEST DISTANCE: VERTICAL AT 3 M

NO.	FREQ. (MHz)	EMISSION LEVEL (dBuV/m)	LIMIT (dBuV/m)	MARGIN (dB)	ANTENNA HEIGHT (m)	TABLE ANGLE (Degree)	RAW VALUE (dBuV)	CORRECTION FACTOR (dB/m)
1	5150.00	71.1 PK	74.0	-2.9	1.73 V	281	65.10	6.00
2	5150.00	52.9 AV	54.0	-1.1	1.73 V	281	46.90	6.00
3	*5180.00	119.3 PK			2.01 V	73	79.80	39.50
4	*5180.00	108.9 AV			2.01 V	73	69.40	39.50
5	5360.00	62.8 PK	74.0	-11.2	1.85 V	276	56.70	6.10
6	5360.00	51.4 AV	54.0	-2.6	1.85 V	276	45.30	6.10
7	#10360.00	61.7 PK	74.0	-12.3	1.53 V	80	43.30	18.40
8	#10360.00	48.2 AV	54.0	-5.8	1.53 V	80	29.80	18.40

Remarks:

1. Emission Level(dBuV/m) = Raw Value(dBuV) + Correction Factor(dB/m)
2. Correction Factor(dB/m) = Antenna Factor(dB/m) + Cable Factor(dB)
3. The other emission levels were very low against the limit.
4. Margin value = Emission Level – Limit value
5. " * ": Fundamental frequency.
6. " # ": The radiated frequency is out of the restricted band.

CHANNEL	TX Channel 40	DETECTOR FUNCTION	Peak (PK)
FREQUENCY RANGE	1GHz ~ 40GHz		Average (AV)

ANTENNA POLARITY & TEST DISTANCE: HORIZONTAL AT 3 M								
NO.	FREQ. (MHz)	EMISSION LEVEL (dBuV/m)	LIMIT (dBuV/m)	MARGIN (dB)	ANTENNA HEIGHT (m)	TABLE ANGLE (Degree)	RAW VALUE (dBuV)	CORRECTION FACTOR (dB/m)
1	5150.00	57.5 PK	74.0	-16.5	1.30 H	133	51.50	6.00
2	5150.00	46.7 AV	54.0	-7.3	1.30 H	133	40.70	6.00
3	*5200.00	105.2 PK			1.23 H	112	65.60	39.60
4	*5200.00	95.1 AV			1.23 H	112	55.50	39.60
5	5400.00	59.2 PK	74.0	-14.8	1.20 H	341	52.90	6.30
6	5400.00	48.2 AV	54.0	-5.8	1.20 H	341	41.90	6.30
7	#10400.00	61.1 PK	74.0	-12.9	1.40 H	301	42.60	18.50
8	#10400.00	47.8 AV	54.0	-6.2	1.40 H	301	29.30	18.50
ANTENNA POLARITY & TEST DISTANCE: VERTICAL AT 3 M								
NO.	FREQ. (MHz)	EMISSION LEVEL (dBuV/m)	LIMIT (dBuV/m)	MARGIN (dB)	ANTENNA HEIGHT (m)	TABLE ANGLE (Degree)	RAW VALUE (dBuV)	CORRECTION FACTOR (dB/m)
1	5150.00	64.2 PK	74.0	-9.8	1.80 V	222	58.20	6.00
2	5150.00	51.4 AV	54.0	-2.6	1.80 V	222	45.40	6.00
3	*5200.00	120.7 PK			1.94 V	219	81.10	39.60
4	*5200.00	110.0 AV			1.94 V	219	70.40	39.60
5	5360.00	65.4 PK	74.0	-8.6	1.79 V	278	59.30	6.10
6	5360.00	52.7 AV	54.0	-1.3	1.79 V	278	46.60	6.10
7	#10360.00	64.7 PK	74.0	-9.3	1.85 V	81	46.30	18.40
8	#10360.00	51.0 AV	54.0	-3.0	1.85 V	81	32.60	18.40

Remarks:

1. Emission Level(dBuV/m) = Raw Value(dBuV) + Correction Factor(dB/m)
2. Correction Factor(dB/m) = Antenna Factor(dB/m) + Cable Factor(dB)
3. The other emission levels were very low against the limit.
4. Margin value = Emission Level – Limit value
5. " * ": Fundamental frequency.
6. " # ": The radiated frequency is out of the restricted band.

CHANNEL	TX Channel 48	DETECTOR FUNCTION	Peak (PK)
FREQUENCY RANGE	1GHz ~ 40GHz		Average (AV)

ANTENNA POLARITY & TEST DISTANCE: HORIZONTAL AT 3 M								
NO.	FREQ. (MHz)	EMISSION LEVEL (dBuV/m)	LIMIT (dBuV/m)	MARGIN (dB)	ANTENNA HEIGHT (m)	TABLE ANGLE (Degree)	RAW VALUE (dBuV)	CORRECTION FACTOR (dB/m)
1	*5240.00	106.1 PK			1.16 H	111	66.50	39.60
2	*5240.00	95.9 AV			1.16 H	111	56.30	39.60
3	5400.00	58.5 PK	74.0	-15.5	1.33 H	88	52.20	6.30
4	5400.00	47.3 AV	54.0	-6.7	1.33 H	88	41.00	6.30
5	#10480.00	60.9 PK	74.0	-13.1	1.44 H	266	41.90	19.00
6	#10480.00	47.8 AV	54.0	-6.2	1.44 H	266	28.80	19.00
ANTENNA POLARITY & TEST DISTANCE: VERTICAL AT 3 M								
NO.	FREQ. (MHz)	EMISSION LEVEL (dBuV/m)	LIMIT (dBuV/m)	MARGIN (dB)	ANTENNA HEIGHT (m)	TABLE ANGLE (Degree)	RAW VALUE (dBuV)	CORRECTION FACTOR (dB/m)
1	*5240.00	120.9 PK			1.79 V	278	81.30	39.60
2	*5240.00	110.8 AV			1.79 V	278	71.20	39.60
3	5360.00	65.3 PK	74.0	-8.7	1.75 V	278	59.20	6.10
4	5360.00	52.3 AV	54.0	-1.7	1.75 V	278	46.20	6.10
5	#10480.00	64.3 PK	74.0	-9.7	1.81 V	94	45.30	19.00
6	#10480.00	50.9 AV	54.0	-3.1	1.81 V	94	31.90	19.00

Remarks:

1. Emission Level(dBuV/m) = Raw Value(dBuV) + Correction Factor(dB/m)
2. Correction Factor(dB/m) = Antenna Factor(dB/m) + Cable Factor(dB)
3. The other emission levels were very low against the limit.
4. Margin value = Emission Level – Limit value
5. " * ": Fundamental frequency.
6. " # ": The radiated frequency is out of the restricted band.

CHANNEL	TX Channel 149	DETECTOR FUNCTION	Peak (PK)
FREQUENCY RANGE	1GHz ~ 40GHz		Average (AV)

ANTENNA POLARITY & TEST DISTANCE: HORIZONTAL AT 3 M

NO.	FREQ. (MHz)	EMISSION LEVEL (dBuV/m)	LIMIT (dBuV/m)	MARGIN (dB)	ANTENNA HEIGHT (m)	TABLE ANGLE (Degree)	RAW VALUE (dBuV)	CORRECTION FACTOR (dB/m)
1	5400.00	59.2 PK	74.0	-14.8	1.36 H	125	52.90	6.30
2	5400.00	46.6 AV	54.0	-7.4	1.36 H	125	40.30	6.30
3	#5722.00	60.6 PK	78.2	-17.6	1.18 H	121	53.80	6.80
4	#5725.00	57.3 PK	78.2	-20.9	1.18 H	121	50.50	6.80
5	*5745.00	100.5 PK			1.16 H	119	60.10	40.40
6	*5745.00	90.2 AV			1.16 H	119	49.80	40.40
7	11490.00	60.0 PK	74.0	-14.0	1.29 H	150	41.60	18.40
8	11490.00	46.8 AV	54.0	-7.2	1.29 H	150	28.40	18.40

ANTENNA POLARITY & TEST DISTANCE: VERTICAL AT 3 M

NO.	FREQ. (MHz)	EMISSION LEVEL (dBuV/m)	LIMIT (dBuV/m)	MARGIN (dB)	ANTENNA HEIGHT (m)	TABLE ANGLE (Degree)	RAW VALUE (dBuV)	CORRECTION FACTOR (dB/m)
1	#5280.00	65.3 PK	68.2	-2.9	1.99 V	270	59.20	6.10
2	5360.00	62.4 PK	74.0	-11.6	1.98 V	65	56.30	6.10
3	5360.00	49.6 AV	54.0	-4.4	1.98 V	65	43.50	6.10
4	#5722.00	66.7 PK	78.2	-11.5	1.91 V	91	59.90	6.80
5	#5725.00	59.9 PK	78.2	-18.3	1.91 V	91	53.10	6.80
6	*5745.00	111.9 PK			1.93 V	66	71.50	40.40
7	*5745.00	101.8 AV			1.93 V	66	61.40	40.40
8	11490.00	60.9 PK	74.0	-13.1	1.60 V	299	42.50	18.40
9	11490.00	47.9 AV	54.0	-6.1	1.60 V	299	29.50	18.40

Remarks:

1. Emission Level(dBuV/m) = Raw Value(dBuV) + Correction Factor(dB/m)
2. Correction Factor(dB/m) = Antenna Factor(dB/m) + Cable Factor(dB)
3. The other emission levels were very low against the limit.
4. Margin value = Emission Level – Limit value
5. " * ": Fundamental frequency.
6. " # ": The radiated frequency is out of the restricted band.

CHANNEL	TX Channel 157	DETECTOR FUNCTION	Peak (PK)
FREQUENCY RANGE	1GHz ~ 40GHz		Average (AV)

ANTENNA POLARITY & TEST DISTANCE: HORIZONTAL AT 3 M

NO.	FREQ. (MHz)	EMISSION LEVEL (dBuV/m)	LIMIT (dBuV/m)	MARGIN (dB)	ANTENNA HEIGHT (m)	TABLE ANGLE (Degree)	RAW VALUE (dBuV)	CORRECTION FACTOR (dB/m)
1	5360.00	58.2 PK	74.0	-15.8	1.28 H	89	52.10	6.10
2	5360.00	46.9 AV	54.0	-7.1	1.28 H	89	40.80	6.10
3	*5785.00	100.7 PK			1.21 H	120	60.20	40.50
4	*5785.00	90.5 AV			1.21 H	120	50.00	40.50
5	11570.00	59.9 PK	74.0	-14.1	1.15 H	140	41.50	18.40
6	11570.00	46.5 AV	54.0	-7.5	1.15 H	140	28.10	18.40

ANTENNA POLARITY & TEST DISTANCE: VERTICAL AT 3 M

NO.	FREQ. (MHz)	EMISSION LEVEL (dBuV/m)	LIMIT (dBuV/m)	MARGIN (dB)	ANTENNA HEIGHT (m)	TABLE ANGLE (Degree)	RAW VALUE (dBuV)	CORRECTION FACTOR (dB/m)
1	#5280.00	66.5 PK	68.2	-1.7	2.01 V	271	60.40	6.10
2	5360.00	65.1 PK	74.0	-8.9	1.83 V	255	59.00	6.10
3	5360.00	52.4 AV	54.0	-1.6	1.83 V	255	46.30	6.10
4	*5785.00	113.2 PK			1.89 V	66	72.70	40.50
5	*5785.00	103.0 AV			1.89 V	66	62.50	40.50
6	11570.00	60.8 PK	74.0	-13.2	1.56 V	291	42.40	18.40
7	11570.00	47.7 AV	54.0	-6.3	1.56 V	291	29.30	18.40

Remarks:

1. Emission Level(dBuV/m) = Raw Value(dBuV) + Correction Factor(dB/m)
2. Correction Factor(dB/m) = Antenna Factor(dB/m) + Cable Factor(dB)
3. The other emission levels were very low against the limit.
4. Margin value = Emission Level – Limit value
5. " * ": Fundamental frequency.
6. " # ": The radiated frequency is out of the restricted band.

CHANNEL	TX Channel 165	DETECTOR FUNCTION	Peak (PK)
FREQUENCY RANGE	1GHz ~ 40GHz		Average (AV)

ANTENNA POLARITY & TEST DISTANCE: HORIZONTAL AT 3 M

NO.	FREQ. (MHz)	EMISSION LEVEL (dBuV/m)	LIMIT (dBuV/m)	MARGIN (dB)	ANTENNA HEIGHT (m)	TABLE ANGLE (Degree)	RAW VALUE (dBuV)	CORRECTION FACTOR (dB/m)
1	5400.00	60.4 PK	74.0	-13.6	1.54 H	245	54.10	6.30
2	5400.00	48.3 AV	54.0	-5.7	1.54 H	245	42.00	6.30
3	*5825.00	100.6 PK			1.26 H	117	60.10	40.50
4	*5825.00	90.0 AV			1.26 H	117	49.50	40.50
5	#5850.00	57.9 PK	78.2	-20.3	1.25 H	73	51.00	6.90
6	#5853.00	61.4 PK	78.2	-16.8	1.25 H	73	54.40	7.00
7	#5861.00	58.5 PK	74.0	-15.5	1.29 H	123	51.50	7.00
8	#5861.00	47.0 AV	54.0	-7.0	1.29 H	123	40.00	7.00
9	11650.00	60.2 PK	74.0	-13.8	1.09 H	61	41.30	18.90
10	11650.00	46.9 AV	54.0	-7.1	1.09 H	61	28.00	18.90

ANTENNA POLARITY & TEST DISTANCE: VERTICAL AT 3 M

NO.	FREQ. (MHz)	EMISSION LEVEL (dBuV/m)	LIMIT (dBuV/m)	MARGIN (dB)	ANTENNA HEIGHT (m)	TABLE ANGLE (Degree)	RAW VALUE (dBuV)	CORRECTION FACTOR (dB/m)
1	#5280.00	66.4 PK	68.2	-1.8	2.01 V	271	60.30	6.10
2	5350.00	63.6 PK	74.0	-10.4	2.06 V	244	57.50	6.10
3	5350.00	51.3 AV	54.0	-2.7	2.06 V	244	45.20	6.10
4	*5825.00	112.1 PK			1.86 V	64	71.60	40.50
5	*5825.00	101.8 AV			1.86 V	64	61.30	40.50
6	#5850.00	59.1 PK	78.2	-19.1	1.90 V	78	52.20	6.90
7	#5853.00	62.2 PK	78.2	-16.0	1.90 V	78	55.20	7.00
8	#5861.00	60.3 PK	74.0	-13.7	2.06 V	76	53.30	7.00
9	#5861.00	47.2 AV	54.0	-6.8	2.06 V	76	40.20	7.00
10	11650.00	60.9 PK	74.0	-13.1	1.68 V	288	42.00	18.90
11	11650.00	47.9 AV	54.0	-6.1	1.68 V	288	29.00	18.90

Remarks:

1. Emission Level(dBuV/m) = Raw Value(dBuV) + Correction Factor(dB/m)
2. Correction Factor(dB/m) = Antenna Factor(dB/m) + Cable Factor(dB)
3. The other emission levels were very low against the limit.
4. Margin value = Emission Level – Limit value
5. " * ": Fundamental frequency.
6. " # ": The radiated frequency is out of the restricted band.

802.11n (HT40)

CHANNEL	TX Channel 38	DETECTOR FUNCTION	Peak (PK)
FREQUENCY RANGE	1GHz ~ 40GHz		Average (AV)

ANTENNA POLARITY & TEST DISTANCE: HORIZONTAL AT 3 M

NO.	FREQ. (MHz)	EMISSION LEVEL (dBuV/m)	LIMIT (dBuV/m)	MARGIN (dB)	ANTENNA HEIGHT (m)	TABLE ANGLE (Degree)	RAW VALUE (dBuV)	CORRECTION FACTOR (dB/m)
1	5150.00	56.5 PK	74.0	-17.5	1.22 H	180	50.50	6.00
2	5150.00	45.3 AV	54.0	-8.7	1.22 H	180	39.30	6.00
3	*5190.00	94.5 PK			1.17 H	109	55.00	39.50
4	*5190.00	84.6 AV			1.17 H	109	45.10	39.50
5	#10380.00	60.3 PK	74.0	-13.7	1.10 H	70	41.80	18.50
6	#10380.00	47.2 AV	54.0	-6.8	1.10 H	70	28.70	18.50

ANTENNA POLARITY & TEST DISTANCE: VERTICAL AT 3 M

NO.	FREQ. (MHz)	EMISSION LEVEL (dBuV/m)	LIMIT (dBuV/m)	MARGIN (dB)	ANTENNA HEIGHT (m)	TABLE ANGLE (Degree)	RAW VALUE (dBuV)	CORRECTION FACTOR (dB/m)
1	5150.00	68.9 PK	74.0	-5.1	2.04 V	98	62.90	6.00
2	5150.00	52.5 AV	54.0	-1.5	2.04 V	98	46.50	6.00
3	*5190.00	109.3 PK			1.91 V	277	69.80	39.50
4	*5190.00	99.0 AV			1.91 V	277	59.50	39.50
5	#10380.00	61.1 PK	74.0	-12.9	1.37 V	310	42.60	18.50
6	#10380.00	47.9 AV	54.0	-6.1	1.37 V	310	29.40	18.50

Remarks:

1. Emission Level(dBuV/m) = Raw Value(dBuV) + Correction Factor(dB/m)
2. Correction Factor(dB/m) = Antenna Factor(dB/m) + Cable Factor(dB)
3. The other emission levels were very low against the limit.
4. Margin value = Emission Level – Limit value
5. " * ": Fundamental frequency.
6. " # ": The radiated frequency is out of the restricted band.

CHANNEL	TX Channel 46	DETECTOR FUNCTION	Peak (PK)
FREQUENCY RANGE	1GHz ~ 40GHz		Average (AV)

ANTENNA POLARITY & TEST DISTANCE: HORIZONTAL AT 3 M

NO.	FREQ. (MHz)	EMISSION LEVEL (dBuV/m)	LIMIT (dBuV/m)	MARGIN (dB)	ANTENNA HEIGHT (m)	TABLE ANGLE (Degree)	RAW VALUE (dBuV)	CORRECTION FACTOR (dB/m)
1	5150.00	56.0 PK	74.0	-18.0	1.48 H	95	50.00	6.00
2	5150.00	46.1 AV	54.0	-7.9	1.48 H	95	40.10	6.00
3	*5230.00	101.6 PK			1.24 H	199	62.00	39.60
4	*5230.00	91.5 AV			1.24 H	199	51.90	39.60
5	5400.00	58.5 PK	74.0	-15.5	1.24 H	102	52.20	6.30
6	5400.00	47.4 AV	54.0	-6.6	1.24 H	102	41.10	6.30
7	#10460.00	60.7 PK	74.0	-13.3	1.20 H	197	41.80	18.90
8	#10460.00	47.3 AV	54.0	-6.7	1.20 H	197	28.40	18.90

ANTENNA POLARITY & TEST DISTANCE: VERTICAL AT 3 M

NO.	FREQ. (MHz)	EMISSION LEVEL (dBuV/m)	LIMIT (dBuV/m)	MARGIN (dB)	ANTENNA HEIGHT (m)	TABLE ANGLE (Degree)	RAW VALUE (dBuV)	CORRECTION FACTOR (dB/m)
1	5150.00	67.0 PK	74.0	-7.0	1.70 V	280	61.00	6.00
2	5150.00	52.1 AV	54.0	-1.9	1.70 V	280	46.10	6.00
3	*5230.00	117.8 PK			1.98 V	276	78.20	39.60
4	*5230.00	107.7 AV			1.98 V	276	68.10	39.60
5	5360.00	65.1 PK	74.0	-8.9	1.71 V	280	59.00	6.10
6	5360.00	51.6 AV	54.0	-2.4	1.71 V	280	45.50	6.10
7	#10460.00	64.6 PK	74.0	-9.4	2.00 V	81	45.70	18.90
8	#10460.00	50.2 AV	54.0	-3.8	2.00 V	81	31.30	18.90

Remarks:

1. Emission Level(dBuV/m) = Raw Value(dBuV) + Correction Factor(dB/m)
2. Correction Factor(dB/m) = Antenna Factor(dB/m) + Cable Factor(dB)
3. The other emission levels were very low against the limit.
4. Margin value = Emission Level – Limit value
5. " * ": Fundamental frequency.
6. " # ": The radiated frequency is out of the restricted band.

CHANNEL	TX Channel 151	DETECTOR FUNCTION	Peak (PK)
FREQUENCY RANGE	1GHz ~ 40GHz		Average (AV)

ANTENNA POLARITY & TEST DISTANCE: HORIZONTAL AT 3 M

NO.	FREQ. (MHz)	EMISSION LEVEL (dBuV/m)	LIMIT (dBuV/m)	MARGIN (dB)	ANTENNA HEIGHT (m)	TABLE ANGLE (Degree)	RAW VALUE (dBuV)	CORRECTION FACTOR (dB/m)
1	5400.00	56.4 PK	74.0	-17.6	1.41 H	133	50.10	6.30
2	5400.00	45.5 AV	54.0	-8.5	1.41 H	133	39.20	6.30
3	#5714.00	56.6 PK	74.0	-17.4	1.26 H	311	49.80	6.80
4	#5714.00	45.5 AV	54.0	-8.5	1.26 H	311	38.70	6.80
5	#5722.00	62.1 PK	78.2	-16.1	1.33 H	71	55.30	6.80
6	#5725.00	59.0 PK	78.2	-19.2	1.33 H	71	52.20	6.80
7	*5755.00	96.3 PK			1.32 H	119	55.80	40.50
8	*5755.00	86.0 AV			1.32 H	119	45.50	40.50
9	11510.00	59.6 PK	74.0	-14.4	1.06 H	63	41.30	18.30
10	11510.00	46.3 AV	54.0	-7.7	1.06 H	63	28.00	18.30

ANTENNA POLARITY & TEST DISTANCE: VERTICAL AT 3 M

NO.	FREQ. (MHz)	EMISSION LEVEL (dBuV/m)	LIMIT (dBuV/m)	MARGIN (dB)	ANTENNA HEIGHT (m)	TABLE ANGLE (Degree)	RAW VALUE (dBuV)	CORRECTION FACTOR (dB/m)
1	#5280.00	67.2 PK	68.2	-1.0	1.93 V	268	61.10	6.10
2	5350.00	64.3 PK	74.0	-9.7	1.92 V	76	58.20	6.10
3	5350.00	51.4 AV	54.0	-2.6	1.92 V	76	45.30	6.10
4	#5714.00	66.9 PK	74.0	-7.1	1.75 V	292	60.10	6.80
5	#5714.00	51.1 AV	54.0	-2.9	1.75 V	292	44.30	6.80
6	#5722.00	74.2 PK	78.2	-4.0	1.89 V	69	67.40	6.80
7	#5725.00	63.4 PK	78.2	-14.8	1.89 V	69	56.60	6.80
8	*5755.00	110.1 PK			1.90 V	68	69.60	40.50
9	*5755.00	100.1 AV			1.90 V	68	59.60	40.50
10	11510.00	60.2 PK	74.0	-13.8	1.49 V	291	41.90	18.30
11	11510.00	47.2 AV	54.0	-6.8	1.49 V	291	28.90	18.30

Remarks:

1. Emission Level(dBuV/m) = Raw Value(dBuV) + Correction Factor(dB/m)
2. Correction Factor(dB/m) = Antenna Factor(dB/m) + Cable Factor(dB)
3. The other emission levels were very low against the limit.
4. Margin value = Emission Level – Limit value
5. " * ": Fundamental frequency.
6. " # ": The radiated frequency is out of the restricted band.

CHANNEL	TX Channel 159	DETECTOR FUNCTION	Peak (PK)
FREQUENCY RANGE	1GHz ~ 40GHz		Average (AV)

ANTENNA POLARITY & TEST DISTANCE: HORIZONTAL AT 3 M

NO.	FREQ. (MHz)	EMISSION LEVEL (dBuV/m)	LIMIT (dBuV/m)	MARGIN (dB)	ANTENNA HEIGHT (m)	TABLE ANGLE (Degree)	RAW VALUE (dBuV)	CORRECTION FACTOR (dB/m)
1	5400.00	58.5 PK	74.0	-15.5	1.40 H	62	52.20	6.30
2	5400.00	46.4 AV	54.0	-7.6	1.40 H	62	40.10	6.30
3	*5795.00	96.9 PK			1.20 H	120	56.40	40.50
4	*5795.00	86.9 AV			1.20 H	120	46.40	40.50
5	#5850.00	58.2 PK	78.2	-20.0	1.30 H	120	51.30	6.90
6	#5853.00	60.5 PK	78.2	-17.7	1.30 H	120	53.50	7.00
7	#5861.00	58.0 PK	74.0	-16.0	1.22 H	115	51.00	7.00
8	#5861.00	46.9 AV	54.0	-7.1	1.22 H	115	39.90	7.00
9	11590.00	59.7 PK	74.0	-14.3	1.00 H	111	41.20	18.50
10	11590.00	46.4 AV	54.0	-7.6	1.00 H	111	27.90	18.50

ANTENNA POLARITY & TEST DISTANCE: VERTICAL AT 3 M

NO.	FREQ. (MHz)	EMISSION LEVEL (dBuV/m)	LIMIT (dBuV/m)	MARGIN (dB)	ANTENNA HEIGHT (m)	TABLE ANGLE (Degree)	RAW VALUE (dBuV)	CORRECTION FACTOR (dB/m)
1	#5280.00	67.2 PK	68.2	-1.0	1.99 V	269	61.10	6.10
2	5360.00	64.4 PK	74.0	-9.6	1.93 V	67	58.30	6.10
3	5360.00	51.1 AV	54.0	-2.9	1.93 V	67	45.00	6.10
4	*5795.00	108.2 PK			1.75 V	91	67.70	40.50
5	*5795.00	99.1 AV			1.75 V	91	58.60	40.50
6	#5850.00	59.9 PK	78.2	-18.3	1.82 V	75	53.00	6.90
7	#5853.00	61.4 PK	78.2	-16.8	1.82 V	75	54.40	7.00
8	#5861.00	57.0 PK	74.0	-17.0	1.77 V	67	50.00	7.00
9	#5861.00	46.1 AV	54.0	-7.9	1.77 V	67	39.10	7.00
10	11590.00	60.5 PK	74.0	-13.5	1.52 V	81	42.00	18.50
11	11590.00	47.4 AV	54.0	-6.6	1.52 V	81	28.90	18.50

Remarks:

1. Emission Level(dBuV/m) = Raw Value(dBuV) + Correction Factor(dB/m)
2. Correction Factor(dB/m) = Antenna Factor(dB/m) + Cable Factor(dB)
3. The other emission levels were very low against the limit.
4. Margin value = Emission Level – Limit value
5. " * ": Fundamental frequency.
6. " # ": The radiated frequency is out of the restricted band.

802.11ac (VHT80)

CHANNEL	TX Channel 42	DETECTOR FUNCTION	Peak (PK)
FREQUENCY RANGE	1GHz ~ 40GHz		Average (AV)

ANTENNA POLARITY & TEST DISTANCE: HORIZONTAL AT 3 M

NO.	FREQ. (MHz)	EMISSION LEVEL (dBuV/m)	LIMIT (dBuV/m)	MARGIN (dB)	ANTENNA HEIGHT (m)	TABLE ANGLE (Degree)	RAW VALUE (dBuV)	CORRECTION FACTOR (dB/m)
1	5150.00	57.6 PK	74.0	-16.4	1.10 H	66	51.60	6.00
2	5150.00	46.4 AV	54.0	-7.6	1.10 H	66	40.40	6.00
3	*5210.00	90.5 PK			1.06 H	109	50.90	39.60
4	*5210.00	80.9 AV			1.06 H	109	41.30	39.60
5	#10420.00	60.6 PK	74.0	-13.4	1.43 H	155	42.00	18.60
6	#10420.00	47.3 AV	54.0	-6.7	1.43 H	155	28.70	18.60

ANTENNA POLARITY & TEST DISTANCE: VERTICAL AT 3 M

NO.	FREQ. (MHz)	EMISSION LEVEL (dBuV/m)	LIMIT (dBuV/m)	MARGIN (dB)	ANTENNA HEIGHT (m)	TABLE ANGLE (Degree)	RAW VALUE (dBuV)	CORRECTION FACTOR (dB/m)
1	5150.00	66.5 PK	74.0	-7.5	2.01 V	50	60.50	6.00
2	5150.00	52.7 AV	54.0	-1.3	2.01 V	50	46.70	6.00
3	*5210.00	105.7 PK			1.97 V	274	66.10	39.60
4	*5210.00	95.3 AV			1.97 V	274	55.70	39.60
5	#10420.00	61.3 PK	74.0	-12.7	1.40 V	313	42.70	18.60
6	#10420.00	48.1 AV	54.0	-5.9	1.40 V	313	29.50	18.60

Remarks:

1. Emission Level(dBuV/m) = Raw Value(dBuV) + Correction Factor(dB/m)
2. Correction Factor(dB/m) = Antenna Factor(dB/m) + Cable Factor(dB)
3. The other emission levels were very low against the limit.
4. Margin value = Emission Level – Limit value
5. " * ": Fundamental frequency.
6. " # ": The radiated frequency is out of the restricted band.

CHANNEL	TX Channel 155	DETECTOR FUNCTION	Peak (PK)
FREQUENCY RANGE	1GHz ~ 40GHz		Average (AV)

ANTENNA POLARITY & TEST DISTANCE: HORIZONTAL AT 3 M								
NO.	FREQ. (MHz)	EMISSION LEVEL (dBuV/m)	LIMIT (dBuV/m)	MARGIN (dB)	ANTENNA HEIGHT (m)	TABLE ANGLE (Degree)	RAW VALUE (dBuV)	CORRECTION FACTOR (dB/m)
1	5350.00	57.0 PK	74.0	-17.0	1.19 H	123	50.90	6.10
2	5350.00	45.7 AV	54.0	-8.3	1.19 H	123	39.60	6.10
3	#5714.00	58.6 PK	74.0	-15.4	1.22 H	118	51.80	6.80
4	#5714.00	47.0 AV	54.0	-7.0	1.22 H	118	40.20	6.80
5	#5722.00	61.7 PK	78.2	-16.5	1.29 H	111	54.90	6.80
6	#5725.00	58.8 PK	78.2	-19.4	1.29 H	111	52.00	6.80
7	*5775.00	92.0 PK			1.22 H	120	51.50	40.50
8	*5775.00	81.2 AV			1.22 H	120	40.70	40.50
9	11550.00	59.4 PK	74.0	-14.6	1.26 H	163	41.00	18.40
10	11550.00	46.3 AV	54.0	-7.7	1.26 H	163	27.90	18.40

ANTENNA POLARITY & TEST DISTANCE: VERTICAL AT 3 M								
NO.	FREQ. (MHz)	EMISSION LEVEL (dBuV/m)	LIMIT (dBuV/m)	MARGIN (dB)	ANTENNA HEIGHT (m)	TABLE ANGLE (Degree)	RAW VALUE (dBuV)	CORRECTION FACTOR (dB/m)
1	#5280.00	65.8 PK	68.2	-2.4	1.92 V	267	59.70	6.10
2	5360.00	63.7 PK	74.0	-10.3	1.99 V	255	57.60	6.10
3	5360.00	51.6 AV	54.0	-2.4	1.99 V	255	45.50	6.10
4	#5714.00	69.6 PK	74.0	-4.4	1.83 V	228	62.80	6.80
5	#5714.00	53.0 AV	54.0	-1.0	1.83 V	228	46.20	6.80
6	#5722.00	73.2 PK	78.2	-5.0	1.90 V	290	66.40	6.80
7	#5725.00	65.3 PK	78.2	-12.9	1.90 V	290	58.50	6.80
8	*5775.00	105.5 PK			1.90 V	70	65.00	40.50
9	*5775.00	94.1 AV			1.90 V	70	53.60	40.50
10	11550.00	60.3 PK	74.0	-13.7	1.75 V	244	41.90	18.40
11	11550.00	47.1 AV	54.0	-6.9	1.75 V	244	28.70	18.40

Remarks:

1. Emission Level(dBuV/m) = Raw Value(dBuV) + Correction Factor(dB/m)
2. Correction Factor(dB/m) = Antenna Factor(dB/m) + Cable Factor(dB)
3. The other emission levels were very low against the limit.
4. Margin value = Emission Level – Limit value
5. " * ": Fundamental frequency.
6. " # ": The radiated frequency is out of the restricted band.

Below 1GHz Data

802.11a

CHANNEL	TX Channel 36	DETECTOR FUNCTION	Quasi-Peak (QP)
FREQUENCY RANGE	30MHz ~ 1GHz		

ANTENNA POLARITY & TEST DISTANCE: HORIZONTAL AT 3 M								
NO.	FREQ. (MHz)	EMISSION LEVEL (dBuV/m)	LIMIT (dBuV/m)	MARGIN (dB)	ANTENNA HEIGHT (m)	TABLE ANGLE (Degree)	RAW VALUE (dBuV)	CORRECTION FACTOR (dB/m)
1	57.12	31.7 QP	40.0	-8.3	1.99 H	215	46.30	-14.60
2	134.89	29.4 QP	43.5	-14.1	1.99 H	97	44.60	-15.20
3	187.39	32.1 QP	43.5	-11.4	1.50 H	80	48.30	-16.20
4	300.16	28.6 QP	46.0	-17.4	1.00 H	132	41.00	-12.40
5	374.04	23.7 QP	46.0	-22.3	1.00 H	215	34.70	-11.00
6	500.42	28.0 QP	46.0	-18.0	1.50 H	153	36.40	-8.40

ANTENNA POLARITY & TEST DISTANCE: VERTICAL AT 3 M								
NO.	FREQ. (MHz)	EMISSION LEVEL (dBuV/m)	LIMIT (dBuV/m)	MARGIN (dB)	ANTENNA HEIGHT (m)	TABLE ANGLE (Degree)	RAW VALUE (dBuV)	CORRECTION FACTOR (dB/m)
1	33.79	33.1 QP	40.0	-6.9	1.00 V	310	48.90	-15.80
2	57.12	30.5 QP	40.0	-9.5	1.00 V	336	45.10	-14.60
3	202.94	26.9 QP	43.5	-16.6	1.00 V	246	43.80	-16.90
4	340.99	26.4 QP	46.0	-19.6	1.00 V	185	38.10	-11.70
5	424.59	25.8 QP	46.0	-20.2	1.00 V	217	35.70	-9.90
6	500.42	28.9 QP	46.0	-17.1	1.00 V	232	37.30	-8.40

Remarks:

1. Emission Level(dBuV/m) = Raw Value(dBuV) + Correction Factor(dB/m)
2. Correction Factor(dB/m) = Antenna Factor(dB/m) + Cable Factor(dB)
3. The other emission levels were very low against the limit.
4. Margin value = Emission Level – Limit value

4.2 Conducted Emission Measurement

4.2.1 Limits of Conducted Emission Measurement

Frequency (MHz)	Conducted Limit (dBuV)	
	Quasi-peak	Average
0.15 - 0.5	66 - 56	56 - 46
0.50 - 5.0	56	46
5.0 - 30.0	60	50

- Note:** 1. The lower limit shall apply at the transition frequencies.
 2. The limit decreases in line with the logarithm of the frequency in the range of 0.15 to 0.50MHz.

4.2.2 Test Instruments

Description & Manufacturer	Model No.	Serial No.	Date Of Calibration	Due Date Of Calibration
Test Receiver ROHDE & SCHWARZ	ESCI	100613	Nov. 11, 2014	Nov. 10, 2015
RF signal cable Woken	5D-FB	Cable-HYC01-01	Dec. 26, 2014	Dec. 25, 2015
LISN ROHDE & SCHWARZ (EUT)	ESH3-Z5	835239/001	Mar. 02, 2015	Mar. 01, 2016
LISN ROHDE & SCHWARZ (Peripheral)	ESH3-Z5	100311	Jul. 21, 2014	Jul. 20, 2015
Software ADT	BV ADT_Cond_ V7.3.7.3	NA	NA	NA

- Note:** 1. The calibration interval of the above test instruments is 12 months and the calibrations are traceable to NML/ROC and NIST/USA.
 2. The test was performed in HwaYa Shielded Room 1.
 3. The VCCI Site Registration No. is C-2040.

4.2.3 Test Procedures

- The EUT was placed 0.4 meters from the conducting wall of the shielded room with EUT being connected to the power mains through a line impedance stabilization network (LISN). Other support units were connected to the power mains through another LISN. The two LISNs provide 50 ohm/ 50uH of coupling impedance for the measuring instrument.
- Both lines of the power mains connected to the EUT were checked for maximum conducted interference.
- The frequency range from 150kHz to 30MHz was searched. Emission levels under (Limit - 20dB) was not recorded.

NOTE: The resolution bandwidth and video bandwidth of test receiver is 9kHz for quasi-peak detection (QP) and average detection (AV) at frequency 0.15MHz-30MHz.

4.2.4 Deviation from Test Standard

No deviation.

4.2.5 Test Setup

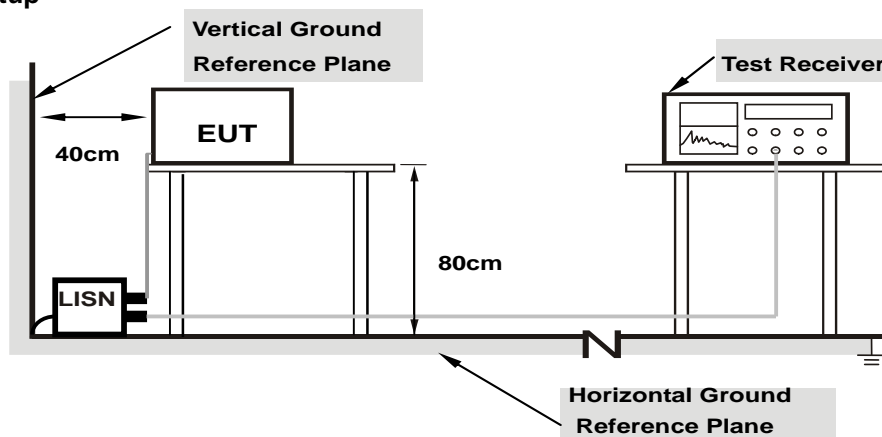

Note: 1.Support units were connected to second LISN.

For the actual test configuration, please refer to the attached file (Test Setup Photo).

4.2.6 EUT Operating Conditions

Same as 4.1.6.

4.2.7 Test Results

Phase	Line (L)	Detector Function	Quasi-Peak (QP) / Average (AV)
-------	----------	-------------------	--------------------------------

No	Freq. [MHz]	Corr. Factor (dB)	Reading Value [dB (uV)]		Emission Level [dB (uV)]		Limit [dB (uV)]		Margin (dB)	
			Q.P.	AV.	Q.P.	AV.	Q.P.	AV.	Q.P.	AV.
			1	0.23648	0.14	39.83	31.14	39.97	31.28	62.22
2	0.26346	0.13	39.34	29.20	39.47	29.33	61.32	51.32	-21.85	-21.99
3	4.34543	0.26	40.09	29.86	40.35	30.12	56.00	46.00	-15.65	-15.88
4	4.79899	0.28	39.86	30.01	40.14	30.29	56.00	46.00	-15.86	-15.71
5	6.07756	0.33	38.38	28.70	38.71	29.03	60.00	50.00	-21.29	-20.97
6	21.81922	1.01	40.35	31.02	41.36	32.03	60.00	50.00	-18.64	-17.97

Remarks:

1. Q.P. and AV. are abbreviations of quasi-peak and average individually.
2. The emission levels of other frequencies were very low against the limit.
3. Margin value = Emission level - Limit value
4. Correction factor = Insertion loss + Cable loss
5. Emission Level = Correction Factor + Reading Value.

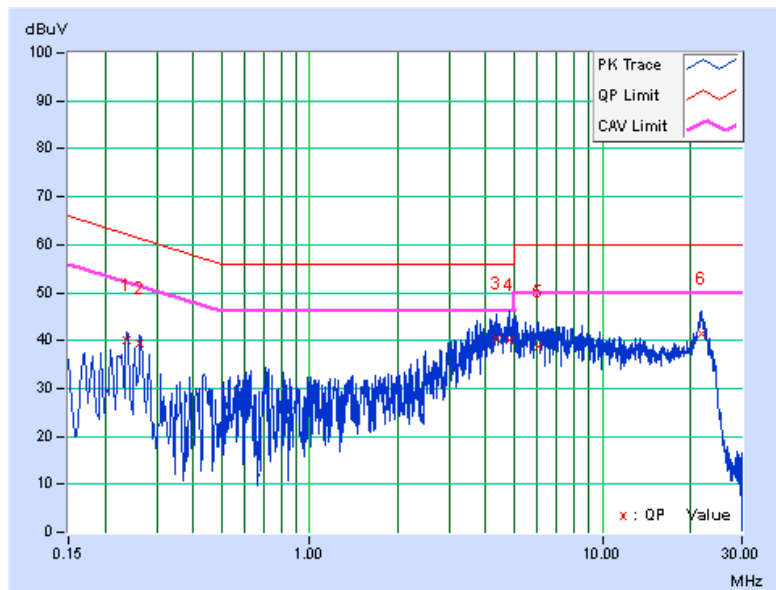

Phase	Neutral (N)	Detector Function	Quasi-Peak (QP) / Average (AV)
-------	-------------	-------------------	--------------------------------

No	Freq. [MHz]	Corr. Factor (dB)	Reading Value [dB (uV)]		Emission Level [dB (uV)]		Limit [dB (uV)]		Margin (dB)	
			Q.P.	AV.	Q.P.	AV.	Q.P.	AV.	Q.P.	AV.
			1	0.23602	0.24	39.49	34.01	39.73	34.25	62.24
2	0.27120	0.22	38.89	30.46	39.11	30.68	61.08	51.08	-21.97	-20.40
3	4.44709	0.40	37.05	27.19	37.45	27.59	56.00	46.00	-18.55	-18.41
4	5.23691	0.42	36.28	26.14	36.70	26.56	60.00	50.00	-23.30	-23.44
5	7.21928	0.47	34.63	24.65	35.10	25.12	60.00	50.00	-24.90	-24.88
6	21.49860	0.88	37.88	26.73	38.76	27.61	60.00	50.00	-21.24	-22.39

Remarks:

1. Q.P. and AV. are abbreviations of quasi-peak and average individually.
2. The emission levels of other frequencies were very low against the limit.
3. Margin value = Emission level - Limit value
4. Correction factor = Insertion loss + Cable loss
5. Emission Level = Correction Factor + Reading Value.

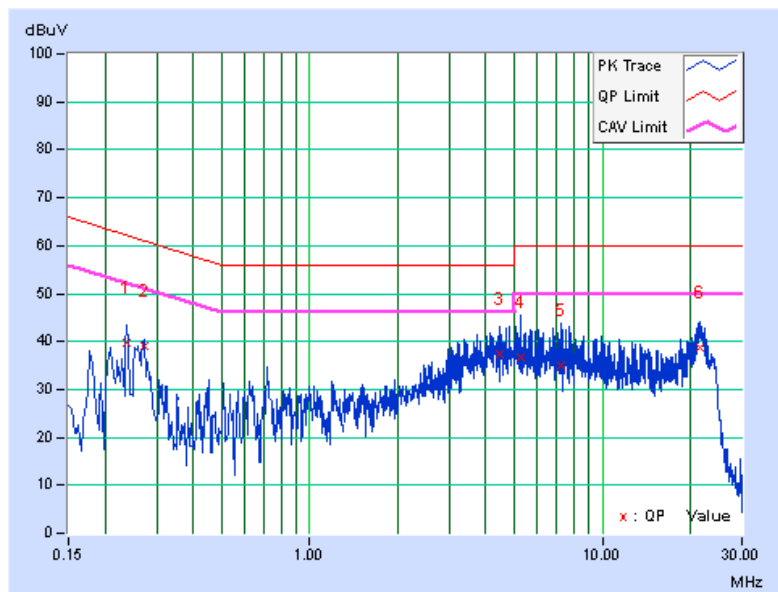

4.3 Transmit Power Measurement

4.3.1 Limits of Transmit Power Measurement

Operation Band	EUT Category		LIMIT
U-NII-1		Outdoor Access Point	1 Watt (30 dBm) (Max. e.i.r.p \leq 125mW(21 dBm) at any elevation angle above 30 degrees as measured from the horizon)
		Fixed point-to-point Access Point	1 Watt (30 dBm)
	√	Indoor Access Point	1 Watt (30 dBm)
		Mobile and Portable client device	250mW (24 dBm)
U-NII-2A	---		250mW (24 dBm) or 11 dBm+10 log B*
U-NII-2C	---		250mW (24 dBm) or 11 dBm+10 log B*
U-NII-3	√		1 Watt (30 dBm)

*B is the 26 dB emission bandwidth in megahertz

Per KDB 662911 Method of conducted output power measurement on IEEE 802.11 devices,

Array Gain = 0 dB (i.e., no array gain) for $N_{ANT} \leq 4$;

Array Gain = 0 dB (i.e., no array gain) for channel widths ≥ 40 MHz for any N_{ANT} ;

Array Gain = $5 \log(N_{ANT}/N_{SS})$ dB or 3 dB, whichever is less for 20-MHz channel widths with $N_{ANT} \geq 5$.

For power measurements on all other devices: Array Gain = $10 \log(N_{ANT}/N_{SS})$ dB.

4.3.2 Test Setup

For 802.11a, 802.11n (HT20), 802.11n (HT40), 802.11ac (VHT20), 802.11ac (VHT40)

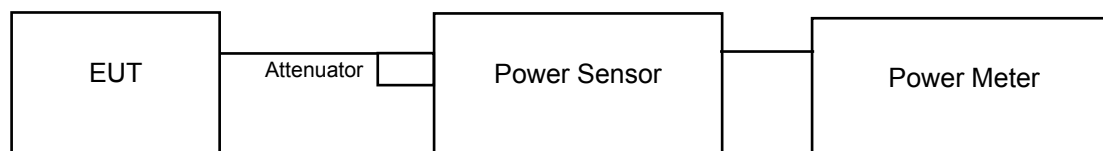

For 802.11ac (VHT80)

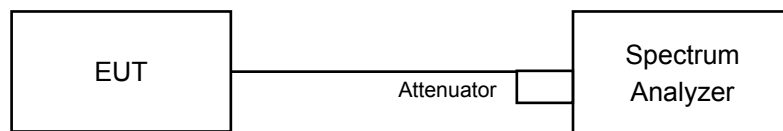

4.3.3 Test Instruments

Refer to section 4.1.2 to get information of above instrument.

4.3.4 Test Procedure

FOR AVERAGE POWER MEASUREMENT

For 802.11a, 802.11n (HT20), 802.11n (HT40), 802.11ac (VHT20), 802.11ac (VHT40)

Method PM is used to perform output power measurement, trigger and gating function of wide band power meter is enabled to measure max output power of TX on burst. Duty factor is not added to measured value.

For 802.11ac (VHT80)

- a. Set span to encompass the entire 26 dB EBW (or, alternatively, the entire 99% occupied bandwidth) of the signal.
- b. Set sweep trigger to “free run”.
- c. Set RBW = 1 MHz.
- d. Set VBW \geq 3 MHz
- e. Number of points in sweep \geq 2 Span / RBW.
- f. Sweep time \leq (number of points in sweep) * T
- g. Using emission bandwidth to determine the frequency span for integration the channel bandwidth.
- h. Detector = RMS.
- i. Trace mode = max hold.
- j. Allow max hold to run for at least 60 seconds, or longer as needed to allow the trace to stabilize.

4.3.5 Deviation from Test Standard

No deviation.

4.3.6 EUT Operating Conditions

The software provided by client to enable the EUT under transmission condition continuously at lowest, middle and highest channel frequencies individually.

4.3.7 Test Result

Power Output:

802.11a

Chan.	Chan. Freq. (MHz)	Maximum Conducted Power (dBm)		Total Power (mW)	Total Power (dBm)	Power Limit (dBm)	Pass / Fail
		Chain 0	Chain 1				
36	5180	19.16	17.84	143.228	21.56	30	Pass
40	5200	20.95	20.86	246.350	23.92	30	Pass
48	5240	19.56	18.03	153.898	21.87	30	Pass
149	5745	13.03	14.05	45.501	16.58	30	Pass
157	5785	13.45	14.13	48.013	16.81	30	Pass
165	5825	13.63	14.34	50.231	17.01	30	Pass

802.11n (HT20)

Chan.	Chan. Freq. (MHz)	Maximum Conducted Power (dBm)		Total Power (mW)	Total Power (dBm)	Power Limit (dBm)	Pass / Fail
		Chain 0	Chain 1				
36	5180	18.90	17.33	131.700	21.20	30	Pass
40	5200	21.02	20.78	246.148	23.91	30	Pass
48	5240	19.65	18.21	158.479	22.00	30	Pass
149	5745	12.53	13.33	39.434	15.96	30	Pass
157	5785	12.70	13.74	42.280	16.26	30	Pass
165	5825	12.30	13.42	38.961	15.91	30	Pass

802.11n (HT40)

Chan.	Chan. Freq. (MHz)	Maximum Conducted Power (dBm)		Total Power (mW)	Total Power (dBm)	Power Limit (dBm)	Pass / Fail
		Chain 0	Chain 1				
38	5190	13.03	12.25	36.879	15.67	30	Pass
46	5230	20.82	20.45	231.698	23.65	30	Pass
151	5755	12.07	12.81	35.205	15.47	30	Pass
159	5795	12.30	13.15	37.636	15.76	30	Pass

802.11ac (VHT80)

Chan.	Chan. Freq. (MHz)	Maximum Conducted Power (dBm)		Total Power (mW)	Total Power (dBm)	Power Limit (dBm)	Pass / Fail
		Chain 0	Chain 1				
42	5210	11.25	10.23	23.879	13.78	30	Pass
155	5775	9.70	10.57	20.735	13.17	30	Pass

26dB Bandwidth:
802.11a

Channel	Channel Frequency (MHz)	26dBc Bandwidth (MHz)		Pass / Fail
		Chain 0	Chain 1	
36	5180	32.18	27.69	Pass
40	5200	43.05	40.89	Pass
48	5240	36.74	25.28	Pass

802.11n (HT20)

Channel	Channel Frequency (MHz)	26dBc Bandwidth (MHz)		Pass / Fail
		Chain 0	Chain 1	
36	5180	32.97	29.20	Pass
40	5200	45.85	42.99	Pass
48	5240	39.41	27.59	Pass

802.11n (HT40)

Channel	Channel Frequency (MHz)	26dBc Bandwidth (MHz)		Pass / Fail
		Chain 0	Chain 1	
38	5190	47.50	47.28	Pass
46	5230	94.65	84.30	Pass

802.11ac (VHT80)

Channel	Channel Frequency (MHz)	26dBc Bandwidth (MHz)		Pass / Fail
		Chain 0	Chain 1	
42	5210	88.03	88.30	Pass

Spectrum Plot of Worst Value

802.11a

802.11n (HT20)

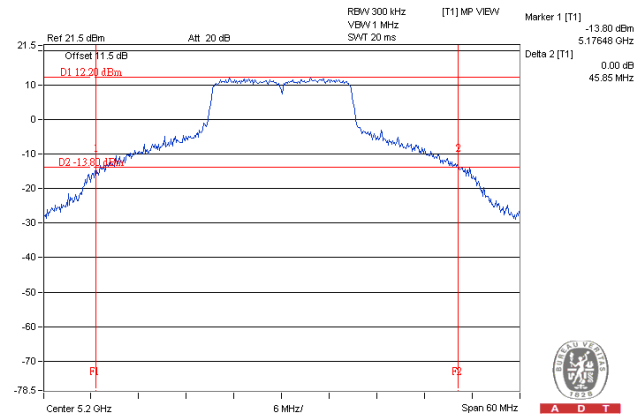
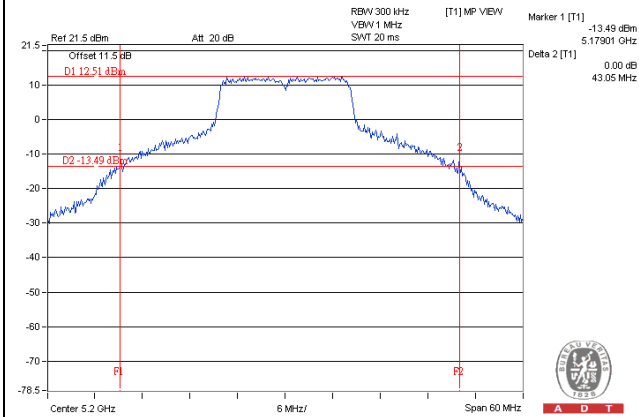

802.11n (HT40)

802.11ac (VHT80)

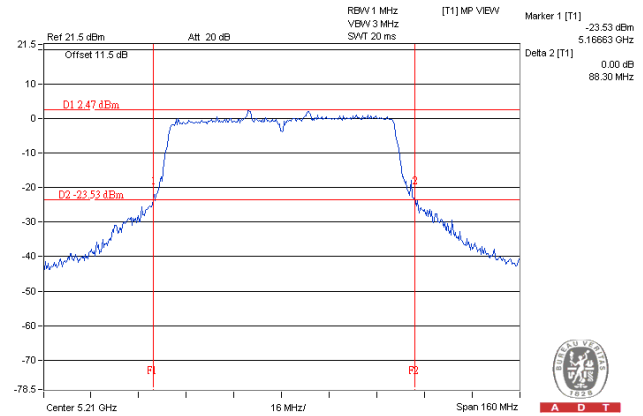
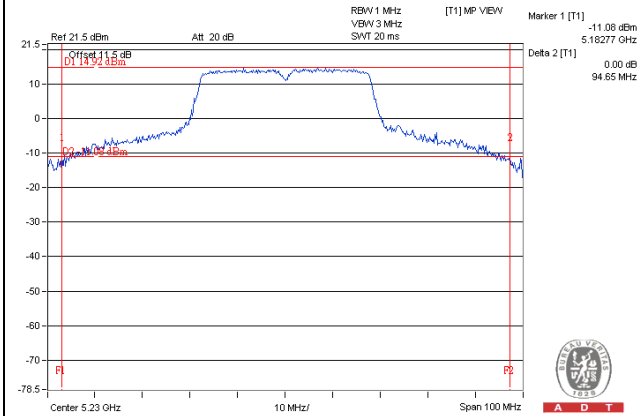

Occupied Bandwidth:
802.11a

Channel	Channel Frequency (MHz)	Occupied Bandwidth (MHz)	
		Chain 0	Chain 1
36	5180	17.52	17.16
40	5200	25.44	22.80
48	5240	18.72	17.04
149	5745	16.87	16.70
157	5785	16.80	16.68
165	5825	16.68	16.80

802.11n (HT20)

Channel	Channel Frequency (MHz)	Occupied Bandwidth (MHz)	
		Chain 0	Chain 1
36	5180	18.60	18.24
40	5200	25.80	23.64
48	5240	19.44	18.12
149	5745	17.88	17.88
157	5785	17.88	17.88
165	5825	17.88	17.88

802.11n (HT40)

Channel	Channel Frequency (MHz)	Occupied Bandwidth (MHz)	
		Chain 0	Chain 1
38	5190	36.96	36.96
46	5230	39.24	37.92
151	5755	36.96	36.96
159	5795	37.08	36.96

802.11ac (VHT80)

Channel	Channel Frequency (MHz)	Occupied Bandwidth (MHz)	
		Chain 0	Chain 1
42	5210	76.32	76.08
155	5775	76.32	76.08

Spectrum Plot of Worst Value

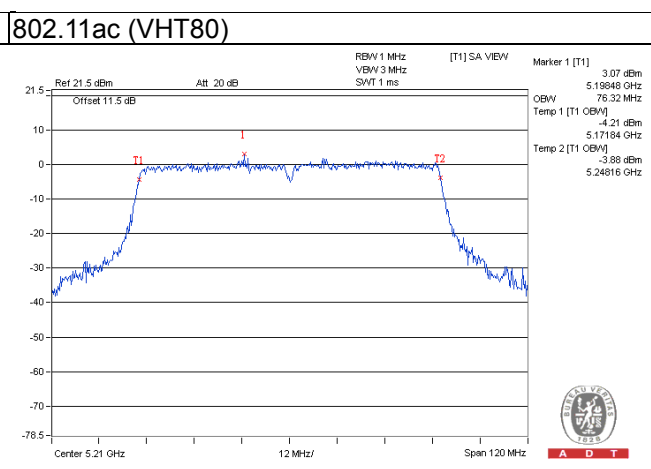
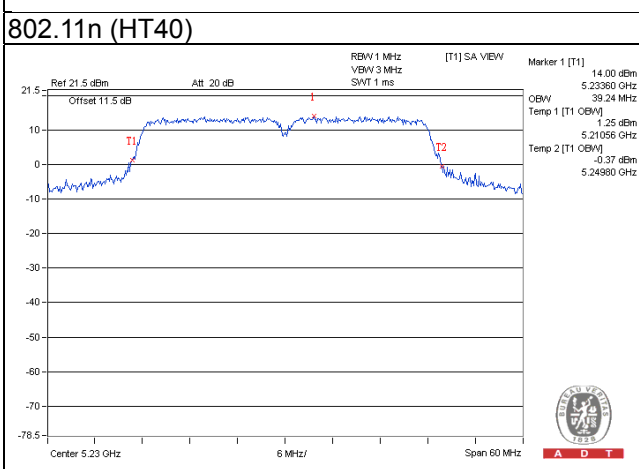
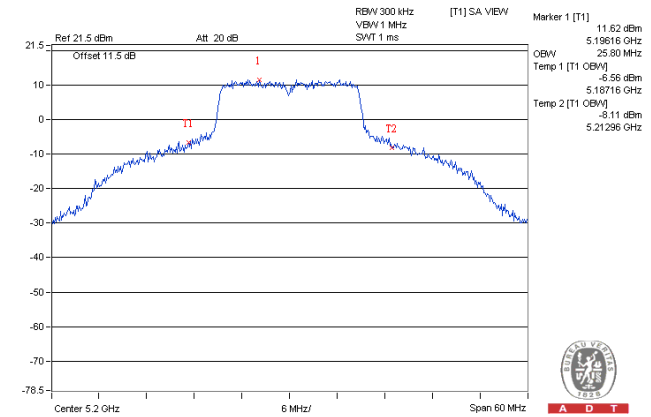
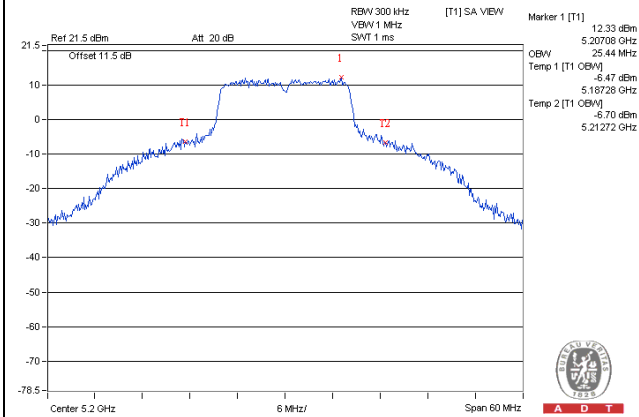

4.4 Peak Power Spectral Density Measurement

4.4.1 Limits of Peak Power Spectral Density Measurement

Operation Band	EUT Category		LIMIT
U-NII-1		Outdoor Access Point	17dBm/ MHz
		Fixed point-to-point Access Point	
	√	Indoor Access Point	
		Mobile and Portable client device	11dBm/ MHz
U-NII-2A	---		11dBm/ MHz
U-NII-2C	---		11dBm/ MHz
U-NII-3	√		30dBm/ 500kHz

4.4.2 Test Setup

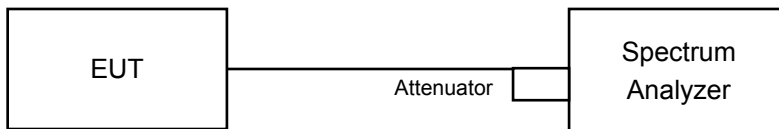

4.4.3 Test Instruments

Refer to section 4.1.2 to get information of above instrument.

4.4.4 Test Procedures

For U-NII-1 band:

Using method SA-2

- Set span to encompass the entire emission bandwidth (EBW) of the signal.
- Set RBW = 1 MHz, Set VBW ≥ 3 MHz, Detector = RMS
- Sweep time = auto, trigger set to “free run”.
- Trace average at least 100 traces in power averaging mode.
- Record the max value and add 10 log (1/duty cycle)

For U-NII-3 band:

- Set span to encompass the entire emission bandwidth (EBW) of the signal.
- Set RBW = 300 kHz, Set VBW ≥ 1 MHz, Detector = RMS
- Use the peak marker function to determine the maximum power level in any 300 kHz band segment within the fundamental EBW.
- Scale the observed power level to an equivalent value in 500 kHz by adjusting (reducing) the measured power by a bandwidth correction factor (BWCF) where $BWCF = 10\log(500\text{ kHz}/300\text{kHz})$
- Sweep time = auto, trigger set to “free run”.
- Trace average at least 100 traces in power averaging mode.
- Record the max value and add 10 log (1/duty cycle)

4.4.5 Deviation from Test Standard

No deviation.

4.4.6 EUT Operating Conditions

Same as Item 4.3.6.

4.4.7 Test Results

For U-NII-1 Band

802.11a

Chan.	Freq. (MHz)	PSD (dBm)		Total PSD w/o duty factor (dBm)	Duty factor	Total PSD with duty factor (dBm)	Max. Limit (dBm)	Pass / Fail
		Chain 0	Chain 1					
36	5180	5.76	5.40	8.59	0.17	8.76	15.36	Pass
40	5200	8.07	7.72	10.91	0.17	11.08	15.36	Pass
48	5240	7.96	7.35	10.68	0.17	10.85	15.36	Pass

Note:

- Method 1 of power density measurement of KDB 662911 is using for calculating total power density. Total power density is summing entire spectra across corresponding frequency bins on the various outputs by computer.
- Directional gain = $10 \log[(10^{G1/20} + 10^{G2/20} + \dots + 10^{GN/20})^2/2] = 7.64 \text{ dBi} > 6\text{dBi}$, so the power density limit shall be reduced to $17 - (7.64 - 6) = 15.36\text{dBm}$.
- Refer to section 3.3 for duty cycle spectrum plot.

802.11n (HT20)

Chan.	Freq. (MHz)	PSD (dBm)		Total PSD w/o duty factor (dBm)	Duty factor	Total PSD with duty factor (dBm)	Max. Limit (dBm)	Pass / Fail
		Chain 0	Chain 1					
36	5180	5.05	3.43	7.33	0.32	7.65	15.36	Pass
40	5200	7.39	7.35	10.38	0.32	10.70	15.36	Pass
48	5240	7.37	7.05	10.23	0.32	10.55	15.36	Pass

Note:

- Method 1 of power density measurement of KDB 662911 is using for calculating total power density. Total power density is summing entire spectra across corresponding frequency bins on the various outputs by computer.
- Directional gain = $10 \log[(10^{G1/20} + 10^{G2/20} + \dots + 10^{GN/20})^2/2] = 7.64 \text{ dBi} > 6\text{dBi}$, so the power density limit shall be reduced to $17 - (7.64 - 6) = 15.36\text{dBm}$.
- Refer to section 3.3 for duty cycle spectrum plot.

802.11n (HT40)

Chan.	Freq. (MHz)	PSD (dBm)		Total PSD w/o duty factor (dBm)	Duty factor	Total PSD with duty factor (dBm)	Max. Limit (dBm)	Pass / Fail
		Chain 0	Chain 1					
38	5190	-3.95	-4.92	-1.40	0.35	-1.05	15.36	Pass
46	5230	3.64	3.27	6.47	0.35	6.79	15.36	Pass

Note:

- Method 1 of power density measurement of KDB 662911 is using for calculating total power density. Total power density is summing entire spectra across corresponding frequency bins on the various outputs by computer.
- Directional gain = $10 \log[(10^{G1/20} + 10^{G2/20} + \dots + 10^{GN/20})^2/2] = 7.64 \text{ dBi} > 6\text{dBi}$, so the power density limit shall be reduced to $17 - (7.64 - 6) = 15.36\text{dBm}$.
- Refer to section 3.3 for duty cycle spectrum plot.

802.11ac (VHT80)

Chan.	Freq. (MHz)	PSD (dBm)		Total PSD w/o duty factor (dBm)	Duty factor	Total PSD with duty factor (dBm)	Max. Limit (dBm)	Pass / Fail
		Chain 0	Chain 1					
42	5210	-9.13	-10.27	-6.66	0.81	-5.85	15.36	Pass

Note:

1. Method 1 of power density measurement of KDB 662911 is using for calculating total power density. Total power density is summing entire spectra across corresponding frequency bins on the various outputs by computer.
2. Directional gain = $10 \log[(10^{G^1/20} + 10^{G^2/20} + \dots + 10^{G^N/20})^2/2] = 7.64 \text{ dBi} > 6\text{dBi}$, so the power density limit shall be reduced to $17 - (7.64 - 6) = 15.36\text{dBm}$.
3. Refer to section 3.3 for duty cycle spectrum plot.

Spectrum Plot of Worst Value

802.11a 802.11n (HT20)

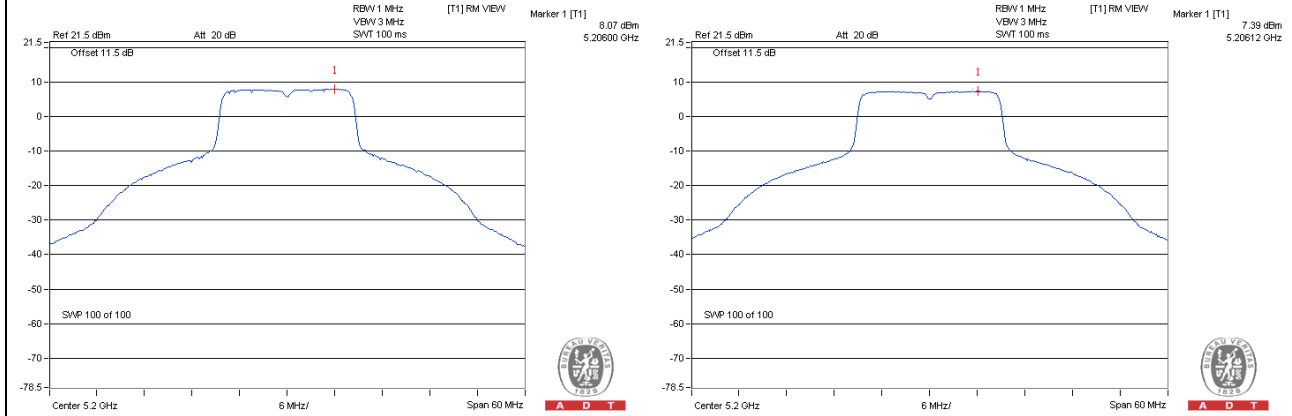

802.11n (HT40) 802.11ac (VHT80)

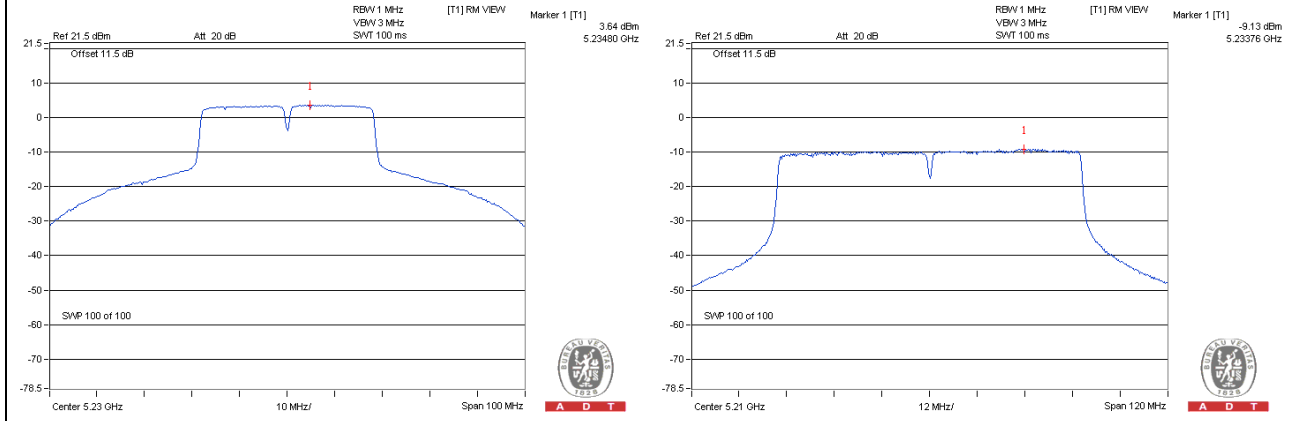

For U-NII-3 Band
802.11a

TX chain	Channel	Freq. (MHz)	PSD (dBm/300 kHz)	PSD (dBm/500 kHz)	10 log (N=2) dB	Duty factor	Total PSD (dBm/500 kHz)	Limit (dBm/500 kHz)	Pass / Fail
0	149	5745	-8.83	-6.61	3.01	0.17	-3.43	28.36	Pass
	157	5785	-8.69	-6.47	3.01	0.17	-3.29	28.36	Pass
	165	5825	-8.76	-6.54	3.01	0.17	-3.36	28.36	Pass
1	149	5745	-8.31	-6.09	3.01	0.17	-2.91	28.36	Pass
	157	5785	-8.03	-5.81	3.01	0.17	-2.63	28.36	Pass
	165	5825	-7.73	-5.51	3.01	0.17	-2.33	28.36	Pass

Note:

- Method 1 of power density measurement of KDB 662911 is using for calculating total power density. Total power density is summing entire spectra across corresponding frequency bins on the various outputs by computer.
- Directional gain = $10 \log[(10^{G1/20} + 10^{G2/20} + \dots + 10^{GN/20})^2/2] = 7.64 \text{ dBi} > 6\text{dBi}$, so the power density limit shall be reduced to $30 - (7.64 - 6) = 28.36\text{dBm}$.
- Refer to section 3.3 for duty cycle spectrum plot.

802.11n (HT20)

TX chain	Channel	Freq. (MHz)	PSD (dBm/300 kHz)	PSD (dBm/500 kHz)	10 log (N=2) dB	Duty factor	Total PSD (dBm/500 kHz)	Limit (dBm/500 kHz)	Pass / Fail
0	149	5745	-9.79	-7.57	3.01	0.32	-4.24	28.36	Pass
	157	5785	-9.55	-7.33	3.01	0.32	-4.00	28.36	Pass
	165	5825	-10.00	-7.78	3.01	0.32	-4.45	28.36	Pass
1	149	5745	-9.14	-6.92	3.01	0.32	-3.59	28.36	Pass
	157	5785	-8.87	-6.65	3.01	0.32	-3.32	28.36	Pass
	165	5825	-9.14	-6.92	3.01	0.32	-3.59	28.36	Pass

Note:

- Method 1 of power density measurement of KDB 662911 is using for calculating total power density. Total power density is summing entire spectra across corresponding frequency bins on the various outputs by computer.
- Directional gain = $10 \log[(10^{G1/20} + 10^{G2/20} + \dots + 10^{GN/20})^2/2] = 7.64 \text{ dBi} > 6\text{dBi}$, so the power density limit shall be reduced to $30 - (7.64 - 6) = 28.36\text{dBm}$.
- Refer to section 3.3 for duty cycle spectrum plot.

802.11n (HT40)

TX chain	Channel	Freq. (MHz)	PSD (dBm/300 kHz)	PSD (dBm/500 kHz)	10 log (N=2) dB	Duty factor	Total PSD (dBm/500 kHz)	Limit (dBm/500 kHz)	Pass / Fail
0	151	5755	-13.55	-11.33	3.01	0.35	-7.97	28.36	Pass
	159	5795	-13.48	-11.26	3.01	0.35	-7.90	28.36	Pass
1	151	5755	-13.20	-10.98	3.01	0.35	-7.62	28.36	Pass
	159	5795	-12.76	-10.54	3.01	0.35	-7.18	28.36	Pass

Note:

- Method 1 of power density measurement of KDB 662911 is using for calculating total power density. Total power density is summing entire spectra across corresponding frequency bins on the various outputs by computer.
- Directional gain = $10 \log[(10^{G1/20} + 10^{G2/20} + \dots + 10^{GN/20})^2/2] = 7.64 \text{ dBi} > 6\text{dBi}$, so the power density limit shall be reduced to $30-(7.64-6) = 28.36\text{dBm}$.
- Refer to section 3.3 for duty cycle spectrum plot.

802.11ac (VHT80)

TX chain	Channel	Freq. (MHz)	PSD (dBm/300 kHz)	PSD (dBm/500 kHz)	10 log (N=2) dB	Duty factor	Total PSD (dBm/500 kHz)	Limit (dBm/500 kHz)	Pass / Fail
0	155	5775	-19.43	-17.21	3.01	0.81	-13.39	28.36	Pass
1	155	5775	-19.22	-17.00	3.01	0.81	-13.18	28.36	Pass

Note:

- Method 1 of power density measurement of KDB 662911 is using for calculating total power density. Total power density is summing entire spectra across corresponding frequency bins on the various outputs by computer.
- Directional gain = $10 \log[(10^{G1/20} + 10^{G2/20} + \dots + 10^{GN/20})^2/2] = 7.64 \text{ dBi} > 6\text{dBi}$, so the power density limit shall be reduced to $30-(7.64-6) = 28.36\text{dBm}$.
- Refer to section 3.3 for duty cycle spectrum plot.

Spectrum Plot of Worst Value

802.11a

802.11n (HT20)

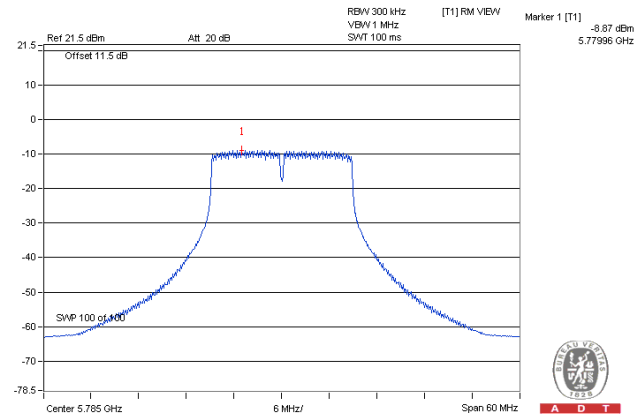
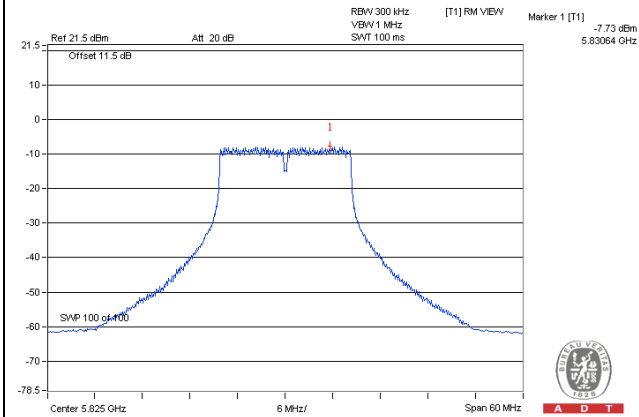

802.11n (HT40)

802.11ac (VHT80)

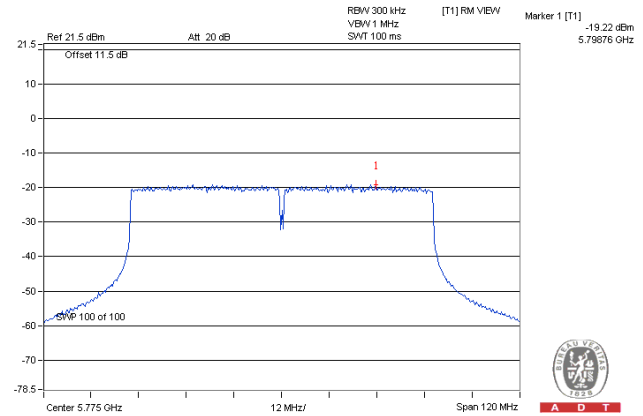
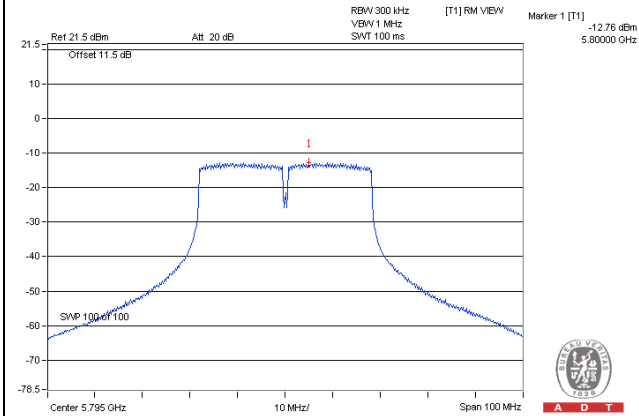

4.5 Frequency Stability

4.5.1 Limits of Frequency Stability Measurement

The frequency of the carrier signal shall be maintained within band of operation

4.5.2 Test Setup

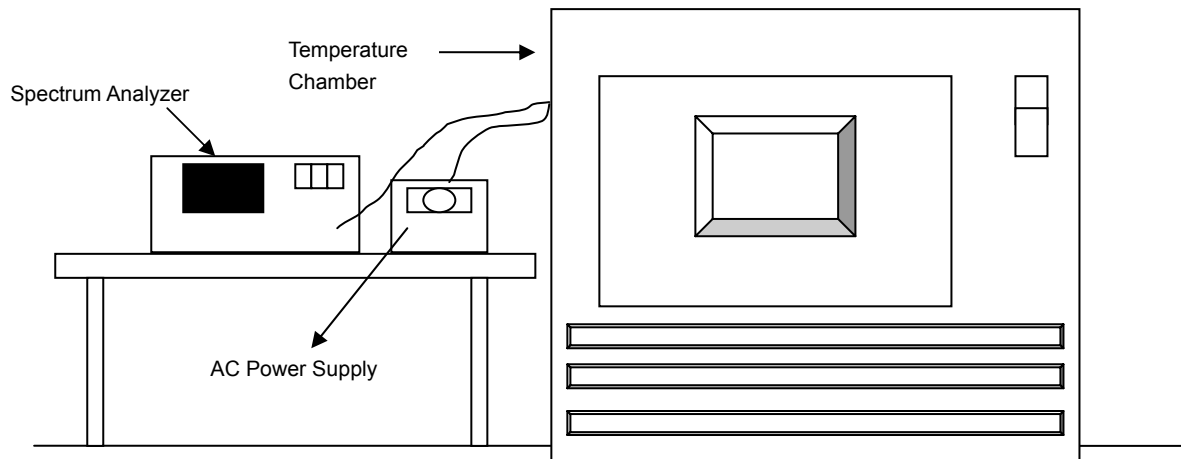

4.5.3 Test Instruments

Refer to section 4.1.2 to get information of above instrument.

4.5.4 Test Procedure

- a. The EUT was placed inside the environmental test chamber and powered by nominal AC voltage.
- b. Turn the EUT on and couple its output to a spectrum analyzer.
- c. Turn the EUT off and set the chamber to the highest temperature specified.
- d. Allow sufficient time (approximately 30 min) for the temperature of the chamber to stabilize, turn the EUT on and measure the operating frequency after 2, 5, and 10 minutes.
- e. Repeat step 2 and 3 with the temperature chamber set to the lowest temperature.
- f. The test chamber was allowed to stabilize at +20 degree C for a minimum of 30 minutes. The supply voltage was then adjusted on the EUT from 85% to 115% and the frequency record.

4.5.5 Deviation from Test Standard

No deviation.

4.5.6 EUT Operating Condition

Set the EUT transmit at un-modulation mode to test frequency stability.

4.5.7 Test Results

Frequency Stability Versus Temp.									
Operating Frequency: 5240MHz									
Temp. (°C)	Power Supply (Vac)	0 Minute		2 Minute		5 Minute		10 Minute	
		Measured Frequency (MHz)	Frequency Drift (%)	Measured Frequency (MHz)	Frequency Drift (%)	Measured Frequency (MHz)	Frequency Drift (%)	Measured Frequency (MHz)	Frequency Drift (%)
50	120	5239.987	-0.00025	5239.9876	-0.00024	5239.9875	-0.00024	5239.9839	-0.00031
40	120	5240.0238	0.00045	5240.0245	0.00047	5240.0274	0.00052	5240.0269	0.00051
30	120	5239.981	-0.00036	5239.9839	-0.00031	5239.9804	-0.00037	5239.984	-0.00031
20	120	5240.0143	0.00027	5240.0106	0.00020	5240.014	0.00027	5240.0111	0.00021
10	120	5240.0216	0.00041	5240.0194	0.00037	5240.0225	0.00043	5240.0242	0.00046
0	120	5239.9759	-0.00046	5239.9759	-0.00046	5239.9798	-0.00039	5239.9796	-0.00039
-10	120	5239.9858	-0.00027	5239.9821	-0.00034	5239.9857	-0.00027	5239.985	-0.00029
-20	120	5239.9934	-0.00013	5239.9941	-0.00011	5239.9947	-0.00010	5239.9948	-0.00010
-30	120	5239.9927	-0.00014	5239.9932	-0.00013	5239.9901	-0.00019	5239.9946	-0.00010

Frequency Stability Versus Temp.									
Operating Frequency: 5240MHz									
Temp. (°C)	Power Supply (Vac)	0 Minute		2 Minute		5 Minute		10 Minute	
		Measured Frequency (MHz)	Frequency Drift (%)	Measured Frequency (MHz)	Frequency Drift (%)	Measured Frequency (MHz)	Frequency Drift (%)	Measured Frequency (MHz)	Frequency Drift (%)
20	138	5240.0142	0.00027	5240.0111	0.00021	5240.0145	0.00028	5240.0101	0.00019
	120	5240.0143	0.00027	5240.0106	0.00020	5240.014	0.00027	5240.0111	0.00021
	102	5240.0138	0.00026	5240.0113	0.00022	5240.013	0.00025	5240.0114	0.00022

4.6 6dB Bandwidth Measurement

4.6.1 Limits of 6dB Bandwidth Measurement

The minimum of 6dB Bandwidth Measurement is 0.5MHz.

4.6.2 Test Setup

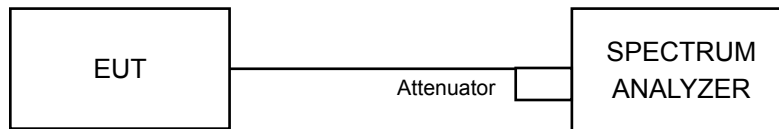

4.6.3 Test Instruments

Refer to section 4.1.2 to get information of above instrument.

4.6.4 Test Procedure

MEASUREMENT PROCEDURE REF

- Set resolution bandwidth (RBW) = 100kHz
- Set the video bandwidth (VBW) $\geq 3 \times$ RBW, Detector = Peak.
- Trace mode = max hold.
- Sweep = auto couple.
- Measure the maximum width of the emission that is constrained by the frequencies associated with the two amplitude points (upper and lower) that are attenuated by 6 dB relative to the maximum level measured in the fundamental emission

4.6.5 Deviation from Test Standard

No deviation.

4.6.6 EUT Operating Condition

The software provided by client to enable the EUT under transmission condition continuously at lowest, middle and highest channel frequencies individually.

4.6.7 Test Results

802.11a

Channel	Frequency (MHz)	6dB Bandwidth (MHz)		Minimum Limit (MHz)	Pass / Fail
		Chain 0	Chain 1		
149	5745	16.38	16.37	0.5	Pass
157	5785	16.41	16.39	0.5	Pass
165	5825	16.39	16.41	0.5	Pass

802.11n (HT20)

Channel	Frequency (MHz)	6dB Bandwidth (MHz)		Minimum Limit (MHz)	Pass / Fail
		Chain 0	Chain 1		
149	5745	17.62	17.36	0.5	Pass
157	5785	17.62	17.60	0.5	Pass
165	5825	17.62	17.61	0.5	Pass

802.11n (HT40)

Channel	Frequency (MHz)	6dB Bandwidth (MHz)		Minimum Limit (MHz)	Pass / Fail
		Chain 0	Chain 1		
151	5755	36.43	36.43	0.5	Pass
159	5795	36.44	36.43	0.5	Pass

802.11ac (VHT80)

Channel	Frequency (MHz)	6dB Bandwidth (MHz)		Minimum Limit (MHz)	Pass / Fail
		Chain 0	Chain 1		
155	5775	76.35	76.44	0.5	Pass

Spectrum Plot of Worst Value

802.11a

802.11n (HT20)

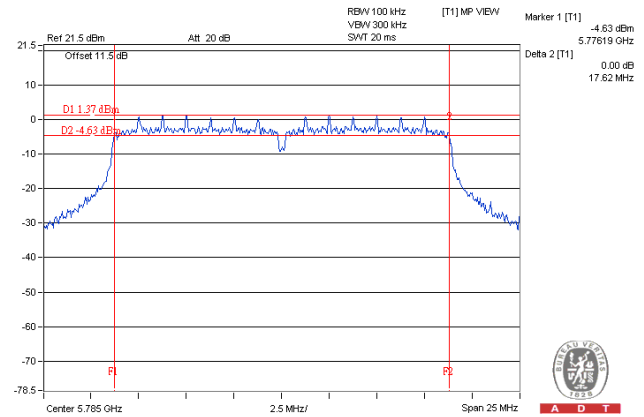
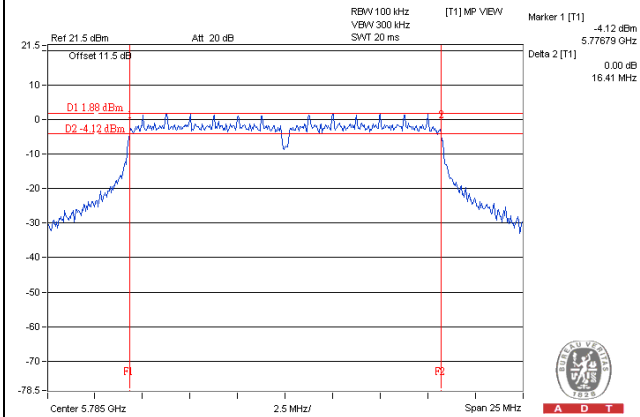

802.11n (HT40)

802.11ac (VHT80)

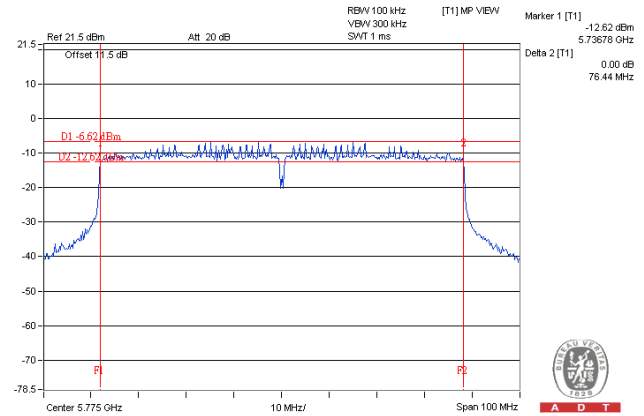
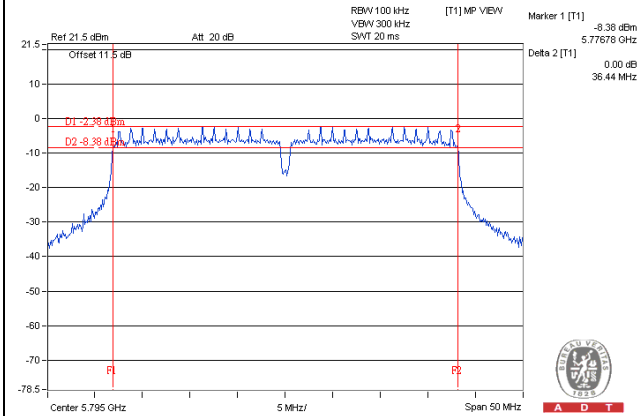

5 Pictures of Test Arrangements

Please refer to the attached file (Test Setup Photo).

Appendix – Information on the Testing Laboratories

We, Bureau Veritas Consumer Products Services (H.K.) Ltd., Taoyuan Branch, were founded in 1988 to provide our best service in EMC, Radio, Telecom and Safety consultation. Our laboratories are accredited and approved according to ISO/IEC 17025.

If you have any comments, please feel free to contact us at the following:

Linko EMC/RF Lab

Tel: 886-2-26052180

Fax: 886-2-26051924

Hsin Chu EMC/RF Lab/Telecom Lab

Tel: 886-3-5935343

Fax: 886-3-5935342

Hwa Ya EMC/RF/Safety

Tel: 886-3-3183232

Fax: 886-3-3270892

Email: service.adt@tw.bureauveritas.com

Web Site: www.bureauveritas-adt.com

The address and road map of all our labs can be found in our web site also.

--- END ---