



FCC TEST REPORT (15.407)

REPORT NO.: RF111005C22A-1
MODEL NO.: EMP7618
(Refer to item 3.1 for more details)
FCC ID: TVE-0120201
RECEIVED: Mar. 07, 2013
TESTED: Mar. 11 ~ May 09, 2013
ISSUED: May 13, 2013

APPLICANT: Fortinet, Inc.

ADDRESS: 1090 Kifer Road Sunnyvale, CA 94086, USA

ISSUED BY: Bureau Veritas Consumer Products Services
(H.K.) Ltd., Taoyuan Branch

LAB ADDRESS: No. 47, 14th Ling, Chia Pau Vil., Lin Kou Dist.,
New Taipei City, Taiwan, R.O.C.

TEST LOCATION: No. 19, Hwa Ya 2nd Rd, Wen Hwa Tsuen, Kwei
Shan Hsiang, Taoyuan Hsien 333, Taiwan, R.O.C.

This report should not be used by the client to claim product certification, approval, or endorsement by TAF or any government agencies.



This report is for your exclusive use. Any copying or replication of this report to or for any other person or entity, or use of our name or trademark, is permitted only with our prior written permission. This report sets forth our findings solely with respect to the test samples identified herein. The results set forth in this report are not indicative or representative of the quality or characteristics of the lot from which a test sample was taken or any similar or identical product unless specifically and expressly noted. Our report includes all of the tests requested by you and the results thereof based upon the information that you provided to us. You have 60 days from date of issuance of this report to notify us of any material error or omission caused by our negligence, provided, however, that such notice shall be in writing and shall specifically address the issue you wish to raise. A failure to raise such issue within the prescribed time shall constitute your unqualified acceptance of the completeness of this report, the tests conducted and the correctness of the report contents. Unless specific mention, the uncertainty of measurement has been explicitly taken into account to declare the compliance or non-compliance to the specification.



TABLE OF CONTENTS

RELEASE CONTROL RECORD	4
1. CERTIFICATION	5
2. SUMMARY OF TEST RESULTS	6
2.1 MEASUREMENT UNCERTAINTY	6
3. GENERAL INFORMATION	7
3.1 GENERAL DESCRIPTION OF EUT	7
3.2 DESCRIPTION OF TEST MODES	8
3.2.1 TEST MODE APPLICABILITY AND TESTED CHANNEL DETAIL	9
3.3 DUTY CYCLE OF TEST SIGNAL	11
3.4 DESCRIPTION OF SUPPORT UNITS	12
3.4.1 CONFIGURATION OF SYSTEM UNDER TEST	12
3.5 GENERAL DESCRIPTION OF APPLIED STANDARDS	13
4. TEST TYPES AND RESULTS	14
4.1 RADIATED EMISSION AND BANDEDGE MEASUREMENT	14
4.1.1 LIMITS OF RADIATED EMISSION AND BANDEDGE MEASUREMENT	14
4.1.2 LIMITS OF UNWANTED EMISSION OUT OF THE RESTRICTED BANDS	14
4.1.3 TEST INSTRUMENTS	15
4.1.4 TEST PROCEDURES	17
4.1.5 DEVIATION FROM TEST STANDARD	17
4.1.6 TEST SETUP	18
4.1.7 EUT OPERATING CONDITION	18
4.1.8 TEST RESULTS	19
4.2 CONDUCTED EMISSION MEASUREMENT	28
4.2.1 LIMITS OF CONDUCTED EMISSION MEASUREMENT	28
4.2.2 TEST INSTRUMENTS	28
4.2.3 TEST PROCEDURES	29
4.2.4 DEVIATION FROM TEST STANDARD	29
4.2.5 TEST SETUP	29
4.2.6 EUT OPERATING CONDITIONS	29
4.2.7 TEST RESULTS	30
4.3 PEAK TRANSMIT POWER MEASUREMENT	32
4.3.1 LIMITS OF PEAK TRANSMIT POWER MEASUREMENT	32
4.3.2 TEST SETUP	32
4.3.3 TEST INSTRUMENTS	32
4.3.4 TEST PROCEDURE	33
4.3.5 DEVIATION FROM TEST STANDARD	33
4.3.6 EUT OPERATING CONDITIONS	33
4.3.7 TEST RESULTS	34
4.4 PEAK POWER SPECTRAL DENSITY MEASUREMENT	36
4.4.1 LIMITS OF PEAK POWER SPECTRAL DENSITY MEASUREMENT	36
4.4.2 TEST SETUP	36
4.4.3 TEST INSTRUMENTS	36
4.4.4 TEST PROCEDURES	36
4.4.5 DEVIATION FROM TEST STANDARD	36
4.4.6 EUT OPERATING CONDITIONS	36
4.4.7 TEST RESULTS	37
4.5 PEAK POWER EXCURSION MEASUREMENT	39
4.5.1 LIMITS OF PEAK POWER EXCURSION MEASUREMENT	39
4.5.2 TEST SETUP	39
4.5.3 TEST INSTRUMENTS	39
4.5.4 TEST PROCEDURE	39
4.5.5 DEVIATION FROM TEST STANDARD	39
4.5.6 EUT OPERATING CONDITIONS	39
4.5.7 TEST RESULTS	40
4.6 FREQUENCY STABILITY	43



A D T

4.6.1	LIMITS OF FREQUENCY STABILITY MEASUREMENT.....	43
4.6.2	TEST SETUP.....	43
4.6.3	TEST INSTRUMENTS.....	43
4.6.4	TEST PROCEDURE.....	44
4.6.5	DEVIATION FROM TEST STANDARD	44
4.6.6	EUT OPERATING CONDITION	44
4.6.7	TEST RESULTS	45
5.	PHOTOGRAPHS OF THE TEST CONFIGURATION	46
6.	INFORMATION ON THE TESTING LABORATORIES.....	47
7.	APPENDIX A - MODIFICATIONS RECORDERS FOR ENGINEERING CHANGES TO THE EUT BY THE LAB	48



A D T

RELEASE CONTROL RECORD

ISSUE NO.	REASON FOR CHANGE	DATE ISSUED
RF111005C22A-1	Original release	May 13, 2013



1. CERTIFICATION

PRODUCT: 802.11 abgn RF Module Card

MODEL: EMP7618 (Refer to item 3.1 for more details)

BRAND: Fortinet

APPLICANT: Fortinet, Inc.

TESTED: Mar. 11 ~ May 09, 2013

TEST SAMPLE: ENGINEERING SAMPLE

STANDARDS: FCC Part 15, Subpart E (Section 15.407)

ANSI C63.10-2009

The above equipment (model: EMP7618) has been tested by **Bureau Veritas Consumer Products Services (H.K.) Ltd., Taoyuan Branch**, and found compliance with the requirement of the above standards. The test record, data evaluation & Equipment Under Test (EUT) configurations represented herein are true and accurate accounts of the measurements of the sample's EMC characteristics under the conditions specified in this report.

PREPARED BY : Polly Chien , **DATE :** May 13, 2013
Polly Chien / Specialist

APPROVED BY : Ken Liu , **DATE :** May 13, 2013
Ken Liu / Senior Manager

2. SUMMARY OF TEST RESULTS

The EUT has been tested according to the following specifications:

APPLIED STANDARD: FCC PART 15, SUBPART E (SECTION 15.407)			
STANDARD SECTION	TEST TYPE	RESULT	REMARK
15.407(b)(6)	AC Power Conducted Emission	PASS	Meet the requirement of limit. Minimum passing margin is -6.96dB at 0.49584MHz.
15.407(b/1/2/3)(b)(6)	Spurious Emissions	PASS	Meet the requirement of limit. Minimum passing margin is -1.5dB at 5150.00MHz.
15.407(a/1/2)	Max Average Transmit Power	PASS	Meet the requirement of limit.
15.407(a)(6)	Peak Power Excursion	PASS	Meet the requirement of limit.
15.407(a/1/2)	Peak Power Spectral Density	PASS	Meet the requirement of limit.
15.407(g)	Frequency Stability	PASS	Meet the requirement of limit.
15.203	Antenna Requirement	PASS	Antenna connector is RSMA not a standard connector.

2.1 MEASUREMENT UNCERTAINTY

Where relevant, the following measurement uncertainty levels have been estimated for tests performed on the EUT as specified in CISPR 16-4-2:

MEASUREMENT	FREQUENCY	UNCERTAINTY
Conducted emissions	9kHz~30MHz	2.44 dB
Radiated emissions	30MHz ~ 200MHz	3.19 dB
	200MHz ~1000MHz	3.21 dB
	1GHz ~ 18GHz	2.26 dB
	18GHz ~ 40GHz	1.94 dB

This uncertainty represents an expanded uncertainty expressed at approximately the 95% confidence level using a coverage factor of $k = 2$.

3. GENERAL INFORMATION

3.1 GENERAL DESCRIPTION OF EUT

EUT	802.11 abgn RF Module Card
MODEL NO.	EMP7618 (Refer to Note for more details)
NOMINAL VOLTAGE	3.3Vdc (host equipment)
MODULATION TYPE	64QAM, 16QAM, QPSK, BPSK
MODULATION TECHNOLOGY	OFDM
TRANSFER RATE	802.11a: 54.0/ 48.0/ 36.0/ 24.0/ 18.0/ 12.0/ 9.0/ 6.0Mbps 802.11n: up to 300.0Mbps
OPERATING FREQUENCY	5180.0 ~ 5240.0MHz
NUMBER OF CHANNEL	4 for 802.11a, 802.11n (20MHz) 2 for 802.11n (40MHz)
OUTPUT POWER	46.086mW
ANTENNA TYPE	Refer to note as below
ANTENNA CONNECTOR	RSMA
DATA CABLE	NA
I/O PORTS	Refer to user's manual
ACCESSORY DEVICES	NA

NOTE:

1. This report is issued as a supplementary report of original report no.: RF111005C22-1.
2. This report is prepared for FCC class II permissive change. The difference is adding new antenna. Therefore, all relevant items had been re-tested and recorded in this test report.
3. The following models are electrically identical, different model names are for marketing purpose.

BRAND	MODEL
Fortinet	EMP7618
Fortinet	EMP7618-FT

* The model of the EMP7618 was chosen for final test.

4. The EUT incorporates a MIMO function. Physically, the EUT provides 2 completed transmitters and 2 receivers.

MODULATION MODE	TX FUNCTION
802.11b	2TX
802.11g	2TX
802.11a	2TX
802.11n (20MHz)	2TX
802.11n (40MHz)	2TX

5. The following antennas are used in this EUT.

Original antennas

SET	TRANSMITTER CIRCUIT	TYPE	CONNECTOR	GAIN (dBi)	
				2.4GHz	5 GHz
1	Chain (0)	Dipole	RSMA	2	4.5
	Chain (1)			2	4.5
2	Chain (0)	Dipole		2	1
	Chain (1)			2	1
3	Chain (0)	Dipole		2	2
	Chain (1)			2	2

* For original report, the set 1 was chosen for final test.

New antennas

SET	TRANSMITTER CIRCUIT	TYPE	CONNECTOR	GAIN (dBi)	
				2.4GHz	5 GHz
1	Chain (0)	Dipole	RSMA	3	6
	Chain (1)			3	6
2	Chain (0)	Dipole		2	1
	Chain (1)			2	1
3	Chain (0)	Dipole		2	3
	Chain (1)			2	3

* For this test report, the set 1 was chosen for final test.

6. The above EUT information is declared by the manufacturer and for more detailed feature description, please refer to the manufacturer's specifications or User's Manual.

3.2 DESCRIPTION OF TEST MODES

4 channels are provided for 802.11a, 802.11n (20MHz):

CHANNEL	FREQUENCY	CHANNEL	FREQUENCY
36	5180MHz	44	5220MHz
40	5200MHz	48	5240MHz

2 channels are provided for 802.11n (40MHz):

CHANNEL	FREQUENCY	CHANNEL	FREQUENCY
38	5190MHz	46	5230MHz

3.2.1 TEST MODE APPLICABILITY AND TESTED CHANNEL DETAIL

EUT CONFIGURE MODE	APPLICABLE TO				DESCRIPTION
	RE \geq 1G	RE<1G	PLC	APCM	
-	√	√	√	√	-

Where **RE \geq 1G**: Radiated Emission above 1GHz **RE<1G**: Radiated Emission below 1GHz
PLC: Power Line Conducted Emission **APCM**: Antenna Port Conducted Measurement

NOTE: The EUT had been pre-tested on the positioned of each 3 axis. The worst case was found when positioned on Z-plane.

RADIATED EMISSION TEST (ABOVE 1GHz):

- Pre-Scan has been conducted to determine the worst-case mode from all possible combinations between available modulations, data rates and antenna ports (if EUT with antenna diversity architecture).
- Following channel(s) was (were) selected for the final test as listed below.

EUT CONFIGURE MODE	MODE	AVAILABLE CHANNEL	TESTED CHANNEL	MODULATION TECHNOLOGY	MODULATION TYPE	DATA RATE (Mbps)
-	802.11a	36 to 48	36, 40, 48	OFDM	BPSK	6.0
-	802.11n (20MHz)	36 to 48	36, 40, 48	OFDM	BPSK	7.2
-	802.11n (40MHz)	38 to 46	38, 46	OFDM	BPSK	15.0

RADIATED EMISSION TEST (BELOW 1GHz):

- Pre-Scan has been conducted to determine the worst-case mode from all possible combinations between available modulations, data rates and antenna ports (if EUT with antenna diversity architecture).
- Following channel(s) was (were) selected for the final test as listed below.

EUT CONFIGURE MODE	MODE	AVAILABLE CHANNEL	TESTED CHANNEL	MODULATION TECHNOLOGY	MODULATION TYPE	DATA RATE (Mbps)
-	802.11n (40MHz)	38 to 46	46	OFDM	BPSK	15.0

POWER LINE CONDUCTED EMISSION TEST:

- Pre-Scan has been conducted to determine the worst-case mode from all possible combinations between available modulations, data rates and antenna ports (if EUT with antenna diversity architecture).
- Following channel(s) was (were) selected for the final test as listed below.

EUT CONFIGURE MODE	MODE	AVAILABLE CHANNEL	TESTED CHANNEL	MODULATION TECHNOLOGY	MODULATION TYPE	DATA RATE (Mbps)
-	802.11n (40MHz)	38 to 46	46	OFDM	BPSK	15.0



ANTENNA PORT CONDUCTED MEASUREMENT:

- This item includes all test value of each mode, but only includes spectrum plot of worst value of each mode.
- Pre-Scan has been conducted to determine the worst-case mode from all possible combinations between available modulations, data rates and antenna ports (if EUT with antenna diversity architecture).
- Following channel(s) was (were) selected for the final test as listed below.

EUT CONFIGURE MODE	MODE	AVAILABLE CHANNEL	TESTED CHANNEL	MODULATION TECHNOLOGY	MODULATION TYPE	DATA RATE (Mbps)
-	802.11a	36 to 48	36, 40, 48	OFDM	BPSK	6.0
-	802.11n (20MHz)	36 to 48	36, 40, 48	OFDM	BPSK	7.2
-	802.11n (40MHz)	38 to 46	38, 46	OFDM	BPSK	15.0

TEST CONDITION:

APPLICABLE TO	ENVIRONMENTAL CONDITIONS	INPUT POWER (SYSTEM)	TESTED BY
RE \geq 1G	25deg. C, 65%RH	120Vac, 60Hz	Brad Wu
RE $<$ 1G	25deg. C, 65%RH	120Vac, 60Hz	Brad Wu
PLC	25deg. C, 65%RH	120Vac, 60Hz	Brad Wu
APCM	25deg. C, 60%RH	120Vac, 60Hz	Antony Lee

3.3 DUTY CYCLE OF TEST SIGNAL

If duty cycle is < 98%, duty factor shall be considered.

802.11a: Duty cycle = 1.357/1.404 = 0.967, Duty factor = $10 * \log(1/0.967) = 0.15$

802.11n (20MHz): Duty cycle = 1.270/1.316 = 0.965, Duty factor = $10 * \log(1/0.965) = 0.15$

802.11n (40MHz): Duty cycle = 0.340/0.372 = 0.914, Duty factor = $10 * \log(1/0.914) = 0.39$

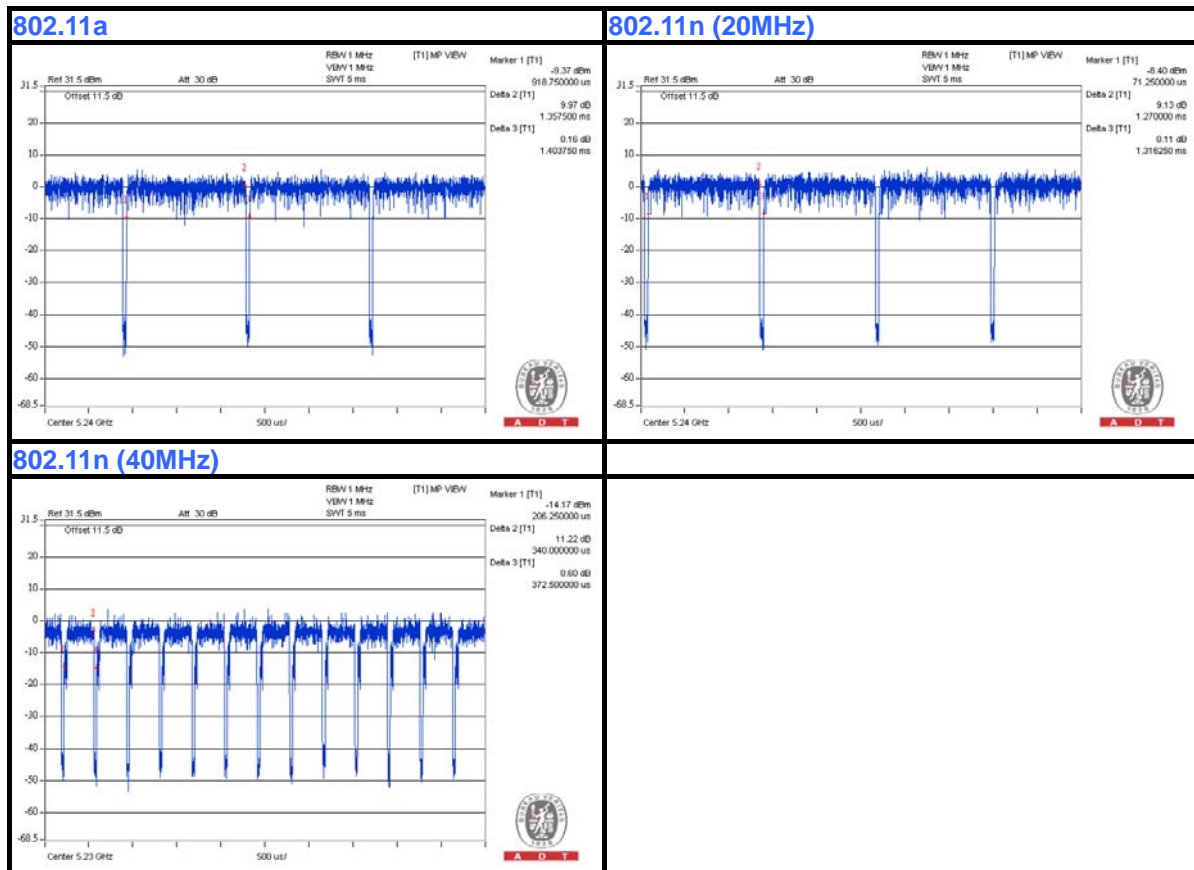

3.4 DESCRIPTION OF SUPPORT UNITS

The EUT has been tested as an independent unit together with other necessary accessories or support units. The following support units or accessories were used to form a representative test configuration during the tests.

NO.	PRODUCT	BRAND	MODEL NO.	SERIAL NO.	FCC ID
1	NOTEBOOK	DELL	E5420	33MLMQ1	FCC DoC Approved

NO.	SIGNAL CABLE DESCRIPTION OF THE ABOVE SUPPORT UNITS
1	NA

NOTE: All power cords of the above support units are non-shielded (1.8 m).

3.4.1 CONFIGURATION OF SYSTEM UNDER TEST

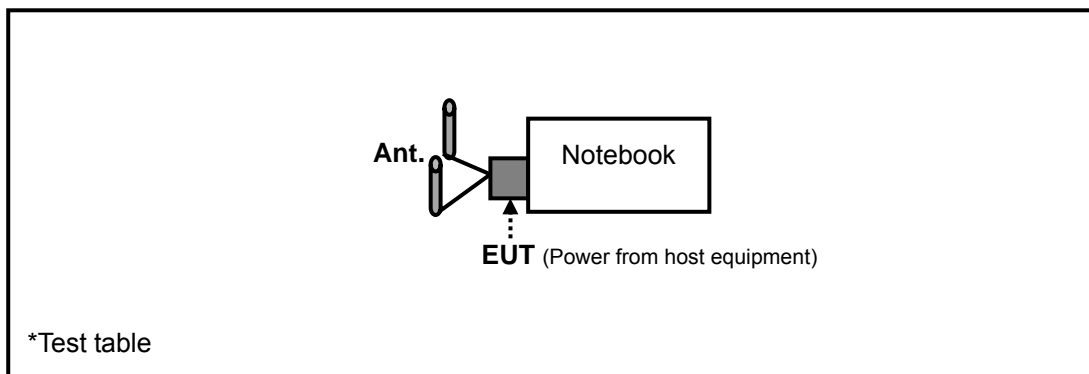

3.5 GENERAL DESCRIPTION OF APPLIED STANDARDS

The EUT is a RF Product. According to the specifications of the manufacturer, it must comply with the requirements of the following standards:

FCC Part 15, Subpart E (15.407)

789033 D01 General UNII Test Procedures v01 r02

662911 D01 Multiple Transmitter Output v01 r02

ANSI C63.10-2009

All test items have been performed and recorded as per the above standards.

NOTE: The EUT is also considered as a kind of computer peripheral, because the connection to computer is necessary for typical use. It has been verified to comply with the requirements of FCC Part 15, Subpart B, Class B (DoC). The test report has been issued separately.

4. TEST TYPES AND RESULTS

4.1 RADIATED EMISSION AND BANDEDGE MEASUREMENT

4.1.1 LIMITS OF RADIATED EMISSION AND BANDEDGE MEASUREMENT

Radiated emissions which fall in the restricted bands must comply with the radiated emission limits specified as below table:

FREQUENCIES (MHz)	FIELD STRENGTH (microvolts/meter)	MEASUREMENT DISTANCE (meters)
0.009 ~ 0.490	2400/F(kHz)	300
0.490 ~ 1.705	24000/F(kHz)	30
1.705 ~ 30.0	30	30
30 ~ 88	100	3
88 ~ 216	150	3
216 ~ 960	200	3
Above 960	500	3

NOTE:

1. The lower limit shall apply at the transition frequencies.
2. Emission level (dBuV/m) = 20 log Emission level (uV/m).
3. For frequencies above 1000MHz, the field strength limits are based on average detector, however, the peak field strength of any emission shall not exceed the maximum permitted average limits, specified above by more than 20dB under any condition of modulation.

4.1.2 LIMITS OF UNWANTED EMISSION OUT OF THE RESTRICTED BANDS

APPLICABLE TO	LIMIT	
√	FIELD STRENGTH AT 3m (dBµV/m)	
	PK	AV
	74	54
	EIRP LIMIT (dBm)	EQUIVALENT FIELD STRENGTH AT 3m (dBµV/m)
	PK	PK
	-27	68.3

NOTE: The following formula is used to convert the equipment isotropic radiated power (eirp) to field strength:

$$E = \frac{1000000\sqrt{30P}}{3} \mu\text{V/m, where P is the eirp (Watts).}$$

4.1.3 TEST INSTRUMENTS

Tested date: Mar. 11 ~ Mar. 13, 2013

DESCRIPTION & MANUFACTURER	MODEL NO.	SERIAL NO.	DATE OF CALIBRATION	DUE DATE OF CALIBRATION
Test Receiver ROHDE & SCHWARZ	ESIB7	100212	Aug. 06, 2012	Aug. 05, 2013
Spectrum Analyzer ROHDE & SCHWARZ	FSP40	100039	Jan. 31, 2013	Jan. 30, 2014
BILOG Antenna SCHWARZBECK	VULB9168	9168-160	Apr. 06, 2012	Apr. 05, 2013
HORN Antenna SCHWARZBECK	9120D	209	Sep. 03, 2012	Sep. 02, 2013
HORN Antenna SCHWARZBECK	BBHA 9170	148	Jul. 11, 2012	Jul. 10, 2013
Loop Antenna	HFH2-Z2	100070	Jan. 31, 2012	Jan. 30, 2014
Preamplifier Agilent	8447D	2944A10633	Oct. 25, 2012	Oct. 24, 2013
Preamplifier Agilent	8449B	3008A01964	Oct. 25, 2012	Oct. 24, 2013
RF signal cable HUBER+SUHNNER	SUCOFLEX 104	250723/4	Aug. 28, 2012	Aug. 27, 2013
RF signal cable HUBER+SUHNNER	SUCOFLEX 106	12738/6+309224/ 4	Aug. 28, 2012	Aug. 27, 2013
Software ADT.	ADT_Radiated_ V7.6.15.9.2	NA	NA	NA
Antenna Tower inn-co GmbH	MA 4000	013303	NA	NA
Antenna Tower Controller inn-co GmbH	CO2000	017303	NA	NA
Turn Table ADT.	TT100	TT93021703	NA	NA
Turn Table Controller ADT.	SC100	SC93021703	NA	NA
26GHz ~ 40GHz Amplifier	EM26400	815221	Oct. 25, 2012	Oct. 24, 2013
High Speed Peak Power Meter	ML2495A	0842014	Apr. 28, 2012	Apr. 27, 2013
Power Sensor	MA2411B	0738404	Apr. 28, 2012	Apr. 27, 2013

- NOTE:** 1. The calibration interval of the above test instruments is 12 months and the calibrations are traceable to NML/ROC and NIST/USA.
2. The calibration interval of the loop antenna is 24 months and the calibrations are traceable to NML/ROC and NIST/USA.
3. The test was performed in HwaYa Chamber 3.
4. The horn antenna and HP preamplifier (model: 8449B) are used only for the measurement of emission frequency above 1GHz if tested.
5. The FCC Site Registration No. is 988962.
6. The IC Site Registration No. is IC 7450F-3.



Tested date: May 09, 2013

DESCRIPTION & MANUFACTURER	MODEL NO.	SERIAL NO.	DATE OF CALIBRATION	DUE DATE OF CALIBRATION
Test Receiver ROHDE & SCHWARZ	ESIB7	100212	Aug. 06, 2012	Aug. 05, 2013
Spectrum Analyzer ROHDE & SCHWARZ	FSP40	100039	Jan. 31, 2013	Jan. 30, 2014
BILOG Antenna SCHWARZBECK	VULB9168	9168-160	Mar. 20, 2013	Mar. 19, 2014
HORN Antenna SCHWARZBECK	9120D	209	Sep. 03, 2012	Sep. 02, 2013
HORN Antenna SCHWARZBECK	BBHA 9170	148	Jul. 11, 2012	Jul. 10, 2013
Loop Antenna	HFH2-Z2	100070	Jan. 31, 2012	Jan. 30, 2014
Preamplifier Agilent	8447D	2944A10633	Oct. 25, 2012	Oct. 24, 2013
Preamplifier Agilent	8449B	3008A01964	Oct. 25, 2012	Oct. 24, 2013
RF signal cable HUBER+SUHNNER	SUCOFLEX 104	250723/4	Aug. 28, 2012	Aug. 27, 2013
RF signal cable HUBER+SUHNNER	SUCOFLEX 106	12738/6+309224/ 4	Aug. 28, 2012	Aug. 27, 2013
Software BV ADT	ADT_Radiated_ V7.6.15.9.2	NA	NA	NA
Antenna Tower inn-co GmbH	MA 4000	013303	NA	NA
Antenna Tower Controller inn-co GmbH	CO2000	017303	NA	NA
Turn Table BV ADT	TT100	TT93021703	NA	NA
Turn Table Controller BV ADT	SC100	SC93021703	NA	NA
26GHz ~ 40GHz Amplifier	EM26400	815221	Oct. 25, 2012	Oct. 24, 2013
High Speed Peak Power Meter	ML2495A	0842014	Apr. 25, 2013	Apr. 24, 2014
Power Sensor	MA2411B	0738404	Apr. 24, 2013	Apr. 23, 2014

- NOTE:**
1. The calibration interval of the above test instruments is 12 months and the calibrations are traceable to NML/ROC and NIST/USA.
 2. The calibration interval of the loop antenna is 24 months and the calibrations are traceable to NML/ROC and NIST/USA.
 3. The test was performed in HwaYa Chamber 3.
 4. The horn antenna and HP preamplifier (model: 8449B) are used only for the measurement of emission frequency above 1GHz if tested.
 5. The FCC Site Registration No. is 988962.
 6. The IC Site Registration No. is IC 7450F-3.

4.1.4 TEST PROCEDURES

- a. The EUT was placed on the top of a rotating table 0.8 meters above the ground at a 3 meter semi-anechoic chamber. The table was rotated 360 degrees to determine the position of the highest radiation.
- b. The EUT was set 3 meters away from the interference-receiving antenna, which was mounted on the top of a variable-height antenna tower.
- c. The antenna is a broadband antenna, and its height is varied from one meter to four meters above the ground to determine the maximum value of the field strength. Both horizontal and vertical polarizations of the antenna are set to make the measurement.
- d. For each suspected emission, the EUT was arranged to its worst case and then the antenna was tuned to heights from 1 meter to 4 meters and the rotatable table was turned from 0 degrees to 360 degrees to find the maximum reading.
- e. The test-receiver system was set to Peak Detect Function and Specified Bandwidth with Maximum Hold Mode.
- f. If the emission level of the EUT in peak mode was 10dB lower than the limit specified, then testing could be stopped and the peak values of the EUT would be reported. Otherwise the emissions that did not have 10dB margin would be re-tested one by one using peak, quasi-peak or average method as specified and then reported in a data sheet.

NOTE:

1. The resolution bandwidth and video bandwidth of test receiver/spectrum analyzer is 120kHz for Peak detection (PK) and Quasi-peak detection (QP) at frequency below 1GHz.
2. The resolution bandwidth of test receiver/spectrum analyzer is 1MHz and video bandwidth is 3MHz for Peak detection at frequency above 1GHz.
3. The resolution bandwidth of test receiver/spectrum analyzer is 1MHz and the video bandwidth is 1kHz for Average detection (AV) at frequency above 1GHz.
4. All modes of operation were investigated and the worst-case emissions are reported.

4.1.5 DEVIATION FROM TEST STANDARD

No deviation.

4.1.6 TEST SETUP

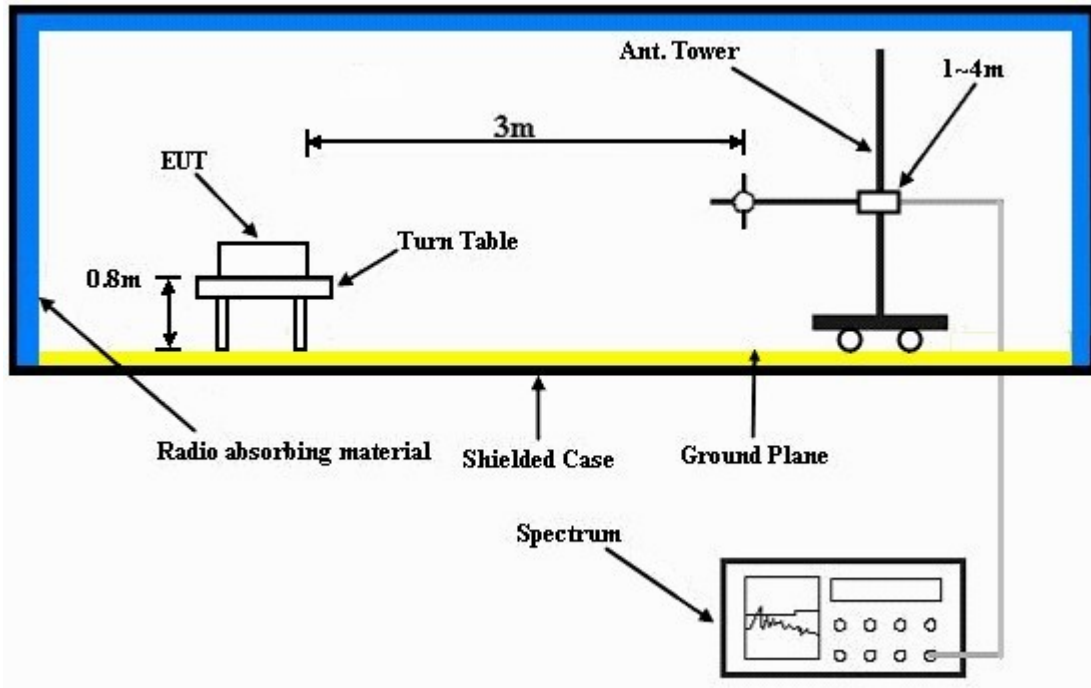

For the actual test configuration, please refer to the attached file (Test Setup Photo).

4.1.7 EUT OPERATING CONDITION

- a. Plugged the EUT into notebook and placed them on the testing table.
- b. The notebook system ran a test program (provided by manufacturer) to enable EUT under transmission condition continuously at specific channel frequency.

4.1.8 TEST RESULTS

ABOVE 1GHz WORST-CASE DATA :

802.11a

EUT TEST CONDITION		MEASUREMENT DETAIL	
CHANNEL	Channel 36	FREQUENCY RANGE	1 ~ 40GHz
INPUT POWER (SYSTEM)	120Vac, 60 Hz	DETECTOR FUNCTION	Peak (PK) Average (AV)
ENVIRONMENTAL CONDITIONS	25deg. C, 65%RH	TESTED BY	Brad Wu

ANTENNA POLARITY & TEST DISTANCE: HORIZONTAL AT 3 M								
NO.	FREQ. (MHz)	EMISSION LEVEL (dBuV/m)	LIMIT (dBuV/m)	MARGIN (dB)	ANTENNA HEIGHT (m)	TABLE ANGLE (Degree)	RAW VALUE (dBuV)	CORRECTION FACTOR (dB/m)
1	5150.00	53.3 PK	74.0	-20.7	1.00 H	0	15.60	37.70
2	5150.00	41.9 AV	54.0	-12.1	1.00 H	0	4.20	37.70
3	*5180.00	92.1 PK			1.00 H	0	54.40	37.70
4	*5180.00	82.8 AV			1.00 H	0	45.10	37.70
5	#10360.00	56.2 PK	74.0	-17.8	1.18 H	254	7.40	48.80
6	#10360.00	43.8 AV	54.0	-10.2	1.18 H	254	-5.00	48.80
ANTENNA POLARITY & TEST DISTANCE: VERTICAL AT 3 M								
NO.	FREQ. (MHz)	EMISSION LEVEL (dBuV/m)	LIMIT (dBuV/m)	MARGIN (dB)	ANTENNA HEIGHT (m)	TABLE ANGLE (Degree)	RAW VALUE (dBuV)	CORRECTION FACTOR (dB/m)
1	5150.00	57.7 PK	74.0	-16.3	1.00 V	125	20.00	37.70
2	5150.00	43.4 AV	54.0	-10.6	1.00 V	125	5.70	37.70
3	*5180.00	108.3 PK			1.00 V	125	70.60	37.70
4	*5180.00	98.6 AV			1.00 V	125	60.90	37.70
5	5360.00	58.9 PK	74.0	-15.1	1.22 V	286	20.90	38.00
6	5360.00	48.3 AV	54.0	-5.7	1.22 V	286	10.30	38.00
7	#10360.00	57.4 PK	74.0	-16.6	1.25 V	28	8.60	48.80
8	#10360.00	46.8 AV	54.0	-7.2	1.25 V	28	-2.00	48.80

REMARKS:

1. Emission level (dBuV/m) = Raw Value (dBuV) + Correction Factor (dB/m).
2. Correction Factor (dB/m) = Antenna Factor (dB/m) + Cable Factor (dB).
3. The other emission levels were very low against the limit.
4. Margin value = Emission level – Limit value.
5. " * ": Fundamental frequency.
6. "#": The radiated frequency is out the restricted band.



A D T

EUT TEST CONDITION		MEASUREMENT DETAIL	
CHANNEL	Channel 40	FREQUENCY RANGE	1 ~ 40GHz
INPUT POWER (SYSTEM)	120Vac, 60 Hz	DETECTOR FUNCTION	Peak (PK) Average (AV)
ENVIRONMENTAL CONDITIONS	25deg. C, 65%RH	TESTED BY	Brad Wu

ANTENNA POLARITY & TEST DISTANCE: HORIZONTAL AT 3 M								
NO.	FREQ. (MHz)	EMISSION LEVEL (dBuV/m)	LIMIT (dBuV/m)	MARGIN (dB)	ANTENNA HEIGHT (m)	TABLE ANGLE (Degree)	RAW VALUE (dBuV)	CORRECTION FACTOR (dB/m)
1	*5200.00	93.0 PK			1.00 H	0	55.20	37.80
2	*5200.00	83.0 AV			1.00 H	0	45.20	37.80
3	#10400.00	56.1 PK	74.0	-17.9	1.19 H	130	7.20	48.90
4	#10400.00	44.2 AV	54.0	-9.8	1.19 H	130	-4.70	48.90
ANTENNA POLARITY & TEST DISTANCE: VERTICAL AT 3 M								
NO.	FREQ. (MHz)	EMISSION LEVEL (dBuV/m)	LIMIT (dBuV/m)	MARGIN (dB)	ANTENNA HEIGHT (m)	TABLE ANGLE (Degree)	RAW VALUE (dBuV)	CORRECTION FACTOR (dB/m)
1	*5200.00	108.0 PK			1.00 V	115	70.20	37.80
2	*5200.00	98.8 AV			1.00 V	115	61.00	37.80
3	5360.00	59.1 PK	74.0	-14.9	1.22 V	280	21.10	38.00
4	5360.00	48.5 AV	54.0	-5.5	1.22 V	280	10.50	38.00
5	#10400.00	57.6 PK	74.0	-16.4	1.30 V	127	8.70	48.90
6	#10400.00	46.9 AV	54.0	-7.1	1.30 V	127	-2.00	48.90

REMARKS:

1. Emission level (dBuV/m) = Raw Value (dBuV) + Correction Factor (dB/m).
2. Correction Factor (dB/m) = Antenna Factor (dB/m) + Cable Factor (dB).
3. The other emission levels were very low against the limit.
4. Margin value = Emission level – Limit value.
5. “ * “: Fundamental frequency.
6. “#”:The radiated frequency is out the restricted band.



A D T

EUT TEST CONDITION		MEASUREMENT DETAIL	
CHANNEL	Channel 48	FREQUENCY RANGE	1 ~ 40GHz
INPUT POWER (SYSTEM)	120Vac, 60 Hz	DETECTOR FUNCTION	Peak (PK) Average (AV)
ENVIRONMENTAL CONDITIONS	25deg. C, 65%RH	TESTED BY	Brad Wu

ANTENNA POLARITY & TEST DISTANCE: HORIZONTAL AT 3 M								
NO.	FREQ. (MHz)	EMISSION LEVEL (dBuV/m)	LIMIT (dBuV/m)	MARGIN (dB)	ANTENNA HEIGHT (m)	TABLE ANGLE (Degree)	RAW VALUE (dBuV)	CORRECTION FACTOR (dB/m)
1	*5240.00	93.5 PK			1.00 H	0	55.70	37.80
2	*5240.00	83.4 AV			1.00 H	0	45.60	37.80
3	#10480.00	56.1 PK	74.0	-17.9	1.23 H	108	6.90	49.20
4	#10480.00	43.8 AV	54.0	-10.2	1.23 H	108	-5.40	49.20
ANTENNA POLARITY & TEST DISTANCE: VERTICAL AT 3 M								
NO.	FREQ. (MHz)	EMISSION LEVEL (dBuV/m)	LIMIT (dBuV/m)	MARGIN (dB)	ANTENNA HEIGHT (m)	TABLE ANGLE (Degree)	RAW VALUE (dBuV)	CORRECTION FACTOR (dB/m)
1	*5240.00	108.3 PK			1.00 V	118	70.50	37.80
2	*5240.00	99.0 AV			1.00 V	118	61.20	37.80
3	5360.00	59.4 PK	74.0	-14.6	1.26 V	277	21.40	38.00
4	5360.00	48.8 AV	54.0	-5.2	1.26 V	277	10.80	38.00
5	#10480.00	57.4 PK	74.0	-16.6	1.27 V	152	8.20	49.20
6	#10480.00	46.1 AV	54.0	-7.9	1.27 V	152	-3.10	49.20

REMARKS:

1. Emission level (dBuV/m) = Raw Value (dBuV) + Correction Factor (dB/m).
2. Correction Factor (dB/m) = Antenna Factor (dB/m) + Cable Factor (dB).
3. The other emission levels were very low against the limit.
4. Margin value = Emission level – Limit value.
5. “ * “: Fundamental frequency.
6. “#”:The radiated frequency is out the restricted band.



A D T

802.11n (20MHz)

EUT TEST CONDITION		MEASUREMENT DETAIL	
CHANNEL	Channel 36	FREQUENCY RANGE	1 ~ 40GHz
INPUT POWER (SYSTEM)	120Vac, 60 Hz	DETECTOR FUNCTION	Peak (PK) Average (AV)
ENVIRONMENTAL CONDITIONS	25deg. C, 65%RH	TESTED BY	Brad Wu

ANTENNA POLARITY & TEST DISTANCE: HORIZONTAL AT 3 M								
NO.	FREQ. (MHz)	EMISSION LEVEL (dBuV/m)	LIMIT (dBuV/m)	MARGIN (dB)	ANTENNA HEIGHT (m)	TABLE ANGLE (Degree)	RAW VALUE (dBuV)	CORRECTION FACTOR (dB/m)
1	5150.00	55.5 PK	74.0	-18.5	1.15 H	300	17.80	37.70
2	5150.00	42.2 AV	54.0	-11.8	1.15 H	300	4.50	37.70
3	*5180.00	92.2 PK			1.20 H	301	54.50	37.70
4	*5180.00	82.2 AV			1.20 H	301	44.50	37.70
5	#10360.00	58.1 PK	74.0	-15.9	1.25 H	332	9.30	48.80
6	#10360.00	46.8 AV	54.0	-7.2	1.25 H	332	-2.00	48.80

ANTENNA POLARITY & TEST DISTANCE: VERTICAL AT 3 M								
NO.	FREQ. (MHz)	EMISSION LEVEL (dBuV/m)	LIMIT (dBuV/m)	MARGIN (dB)	ANTENNA HEIGHT (m)	TABLE ANGLE (Degree)	RAW VALUE (dBuV)	CORRECTION FACTOR (dB/m)
1	5150.00	72.5 PK	74.0	-1.5	1.20 V	86	34.80	37.70
2	5150.00	52.3 AV	54.0	-1.7	1.20 V	86	14.60	37.70
3	*5180.00	109.2 PK			1.29 V	73	71.50	37.70
4	*5180.00	99.6 AV			1.29 V	73	61.90	37.70
5	#10360.00	58.0 PK	74.0	-16.0	1.28 V	52	9.20	48.80
6	#10360.00	46.8 AV	54.0	-5.8	1.28 V	52	-0.60	48.80

REMARKS:

1. Emission level (dBuV/m) = Raw Value (dBuV) + Correction Factor (dB/m).
2. Correction Factor (dB/m) = Antenna Factor (dB/m) + Cable Factor (dB).
3. The other emission levels were very low against the limit.
4. Margin value = Emission level – Limit value.
5. “ * “: Fundamental frequency.
6. “#”:The radiated frequency is out the restricted band.



A D T

EUT TEST CONDITION		MEASUREMENT DETAIL	
CHANNEL	Channel 40	FREQUENCY RANGE	1 ~ 40GHz
INPUT POWER (SYSTEM)	120Vac, 60 Hz	DETECTOR FUNCTION	Peak (PK) Average (AV)
ENVIRONMENTAL CONDITIONS	25deg. C, 65%RH	TESTED BY	Brad Wu

ANTENNA POLARITY & TEST DISTANCE: HORIZONTAL AT 3 M								
NO.	FREQ. (MHz)	EMISSION LEVEL (dBuV/m)	LIMIT (dBuV/m)	MARGIN (dB)	ANTENNA HEIGHT (m)	TABLE ANGLE (Degree)	RAW VALUE (dBuV)	CORRECTION FACTOR (dB/m)
1	*5200.00	92.4 PK			1.21 H	0	54.60	37.80
2	*5200.00	82.5 AV			1.21 H	0	44.70	37.80
3	#10400.00	57.5 PK	74.0	-16.5	1.27 H	327	8.60	48.90
4	#10400.00	46.5 AV	54.0	-7.5	1.27 H	327	-2.40	48.90

ANTENNA POLARITY & TEST DISTANCE: VERTICAL AT 3 M								
NO.	FREQ. (MHz)	EMISSION LEVEL (dBuV/m)	LIMIT (dBuV/m)	MARGIN (dB)	ANTENNA HEIGHT (m)	TABLE ANGLE (Degree)	RAW VALUE (dBuV)	CORRECTION FACTOR (dB/m)
1	*5200.00	109.5 PK			1.26 V	89	71.70	37.80
2	*5200.00	99.7 AV			1.26 V	89	61.90	37.80
3	#10400.00	57.8 PK	74.0	-16.2	1.22 V	41	8.90	48.90
4	#10400.00	48.2 AV	54.0	-5.8	1.22 V	41	-0.70	48.90

REMARKS:

1. Emission level (dBuV/m) = Raw Value (dBuV) + Correction Factor (dB/m).
2. Correction Factor (dB/m) = Antenna Factor (dB/m) + Cable Factor (dB).
3. The other emission levels were very low against the limit.
4. Margin value = Emission level – Limit value.
5. “ * “: Fundamental frequency.
6. “#”:The radiated frequency is out the restricted band.



A D T

EUT TEST CONDITION		MEASUREMENT DETAIL	
CHANNEL	Channel 48	FREQUENCY RANGE	1 ~ 40GHz
INPUT POWER (SYSTEM)	120Vac, 60 Hz	DETECTOR FUNCTION	Peak (PK) Average (AV)
ENVIRONMENTAL CONDITIONS	25deg. C, 65%RH	TESTED BY	Brad Wu

ANTENNA POLARITY & TEST DISTANCE: HORIZONTAL AT 3 M								
NO.	FREQ. (MHz)	EMISSION LEVEL (dBuV/m)	LIMIT (dBuV/m)	MARGIN (dB)	ANTENNA HEIGHT (m)	TABLE ANGLE (Degree)	RAW VALUE (dBuV)	CORRECTION FACTOR (dB/m)
1	*5240.00	92.1 PK			1.22 H	289	54.30	37.80
2	*5240.00	82.0 AV			1.22 H	289	44.20	37.80
3	5350.00	52.4 PK	74.0	-21.6	1.22 H	297	14.40	38.00
4	5350.00	43.2 AV	54.0	-10.8	1.22 H	297	5.20	38.00
5	#10480.00	57.8 PK	74.0	-16.2	1.32 H	318	8.60	49.20
6	#10480.00	46.2 AV	54.0	-7.8	1.32 H	318	-3.00	49.20
ANTENNA POLARITY & TEST DISTANCE: VERTICAL AT 3 M								
NO.	FREQ. (MHz)	EMISSION LEVEL (dBuV/m)	LIMIT (dBuV/m)	MARGIN (dB)	ANTENNA HEIGHT (m)	TABLE ANGLE (Degree)	RAW VALUE (dBuV)	CORRECTION FACTOR (dB/m)
1	*5240.00	110.2 PK			1.25 V	102	72.40	37.80
2	*5240.00	99.8 AV			1.25 V	102	62.00	37.80
3	5350.00	59.5 PK	74.0	-14.5	1.25 V	101	21.50	38.00
4	5350.00	49.7 AV	54.0	-4.3	1.25 V	101	11.70	38.00
5	#10480.00	59.5 PK	74.0	-14.5	1.32 V	48	10.30	49.20
6	#10480.00	48.6 AV	54.0	-5.4	1.32 V	48	-0.60	49.20

REMARKS:

1. Emission level (dBuV/m) = Raw Value (dBuV) + Correction Factor (dB/m).
2. Correction Factor (dB/m) = Antenna Factor (dB/m) + Cable Factor (dB).
3. The other emission levels were very low against the limit.
4. Margin value = Emission level – Limit value.
5. “ * “: Fundamental frequency.
6. “#“: The radiated frequency is out the restricted band.

802.11n (40MHz)

EUT TEST CONDITION		MEASUREMENT DETAIL	
CHANNEL	Channel 38	FREQUENCY RANGE	1 ~ 40GHz
INPUT POWER (SYSTEM)	120Vac, 60 Hz	DETECTOR FUNCTION	Peak (PK) Average (AV)
ENVIRONMENTAL CONDITIONS	25deg. C, 65%RH	TESTED BY	Brad Wu

ANTENNA POLARITY & TEST DISTANCE: HORIZONTAL AT 3 M								
NO.	FREQ. (MHz)	EMISSION LEVEL (dBuV/m)	LIMIT (dBuV/m)	MARGIN (dB)	ANTENNA HEIGHT (m)	TABLE ANGLE (Degree)	RAW VALUE (dBuV)	CORRECTION FACTOR (dB/m)
1	5150.00	49.4 PK	74.0	-24.6	1.12 H	262	11.70	37.70
2	5150.00	38.7 AV	54.0	-15.3	1.12 H	262	1.00	37.70
3	*5190.00	84.0 PK			1.14 H	259	46.30	37.70
4	*5190.00	75.2 AV			1.14 H	259	37.50	37.70
5	#10360.00	58.1 PK	74.0	-15.9	1.22 H	325	9.30	48.80
6	#10360.00	46.6 AV	54.0	-7.4	1.22 H	325	-2.2	48.80

ANTENNA POLARITY & TEST DISTANCE: VERTICAL AT 3 M								
NO.	FREQ. (MHz)	EMISSION LEVEL (dBuV/m)	LIMIT (dBuV/m)	MARGIN (dB)	ANTENNA HEIGHT (m)	TABLE ANGLE (Degree)	RAW VALUE (dBuV)	CORRECTION FACTOR (dB/m)
1	5150.00	62.0 PK	74.0	-12.0	1.21 V	79	24.30	37.70
2	5150.00	48.8 AV	54.0	-5.2	1.21 V	79	11.10	37.70
3	*5190.00	103.5 PK			1.30 V	78	65.80	37.70
4	*5190.00	93.4 AV			1.30 V	78	55.70	37.70
5	5360.00	58.8 PK	74.0	-15.2	1.17 V	105	20.80	38.00
6	5360.00	50.6 AV	54.0	-3.4	1.17 V	105	12.60	38.00
7	#10360.00	59.9 PK	74.0	-14.1	1.32 V	47	11.10	48.80
8	#10360.00	46.8 AV	54.0	-7.2	1.32 V	47	-2.00	48.80

REMARKS:

1. Emission level (dBuV/m) = Raw Value (dBuV) + Correction Factor (dB/m).
2. Correction Factor (dB/m) = Antenna Factor (dB/m) + Cable Factor (dB).
3. The other emission levels were very low against the limit.
4. Margin value = Emission level – Limit value.
5. “ * “: Fundamental frequency.
6. “#“: The radiated frequency is out the restricted band.



A D T

EUT TEST CONDITION		MEASUREMENT DETAIL	
CHANNEL	Channel 46	FREQUENCY RANGE	1 ~ 40GHz
INPUT POWER (SYSTEM)	120Vac, 60 Hz	DETECTOR FUNCTION	Peak (PK) Average (AV)
ENVIRONMENTAL CONDITIONS	25deg. C, 65%RH	TESTED BY	Brad Wu

ANTENNA POLARITY & TEST DISTANCE: HORIZONTAL AT 3 M								
NO.	FREQ. (MHz)	EMISSION LEVEL (dBuV/m)	LIMIT (dBuV/m)	MARGIN (dB)	ANTENNA HEIGHT (m)	TABLE ANGLE (Degree)	RAW VALUE (dBuV)	CORRECTION FACTOR (dB/m)
1	*5230.00	91.2 PK			1.08 H	277	53.40	37.80
2	*5230.00	82.0 AV			1.08 H	277	44.20	37.80
3	5350.00	45.8 PK	74.0	-28.2	1.08 H	272	7.80	38.00
4	5350.00	35.4 AV	54.0	-18.6	1.08 H	272	-2.60	38.00
5	#10460.00	58.4 PK	74.0	-15.6	1.23 H	341	9.30	49.10
6	#10460.00	47.5 AV	54.0	-6.5	1.23 H	341	-1.60	49.10
ANTENNA POLARITY & TEST DISTANCE: VERTICAL AT 3 M								
NO.	FREQ. (MHz)	EMISSION LEVEL (dBuV/m)	LIMIT (dBuV/m)	MARGIN (dB)	ANTENNA HEIGHT (m)	TABLE ANGLE (Degree)	RAW VALUE (dBuV)	CORRECTION FACTOR (dB/m)
1	*5230.00	110.6 PK			1.28 V	74	72.80	37.80
2	*5230.00	101.6 AV			1.28 V	74	63.80	37.80
3	5350.00	53.8 PK	74.0	-20.2	1.28 V	74	15.80	38.00
4	5350.00	41.2 AV	54.0	-12.8	1.28 V	74	3.20	38.00
5	#10460.00	58.5 PK	74.0	-15.5	1.28 V	58	9.40	49.10
6	#10460.00	49.1 AV	54.0	-4.9	1.28 V	58	0.00	49.10

REMARKS:

1. Emission level (dBuV/m) = Raw Value (dBuV) + Correction Factor (dB/m).
2. Correction Factor (dB/m) = Antenna Factor (dB/m) + Cable Factor (dB).
3. The other emission levels were very low against the limit.
4. Margin value = Emission level – Limit value.
5. “ * “: Fundamental frequency.
6. “#”:The radiated frequency is out the restricted band.

BELOW 1GHz WORST-CASE DATA : 802.11n (40MHz)

EUT TEST CONDITION		MEASUREMENT DETAIL	
CHANNEL	Channel 46	FREQUENCY RANGE	Below 1000MHz
INPUT POWER (SYSTEM)	120Vac, 60 Hz	DETECTOR FUNCTION	Quasi-Peak
ENVIRONMENTAL CONDITIONS	25deg. C, 65%RH	TESTED BY	Brad Wu

ANTENNA POLARITY & TEST DISTANCE: HORIZONTAL AT 3 M								
NO.	FREQ. (MHz)	EMISSION LEVEL (dBuV/m)	LIMIT (dBuV/m)	MARGIN (dB)	ANTENNA HEIGHT (m)	TABLE ANGLE (Degree)	RAW VALUE (dBuV)	CORRECTION FACTOR (dB/m)
1	97.95	32.4 QP	43.5	-11.1	1.00 H	10	23.40	9.00
2	142.67	33.4 QP	43.5	-10.1	1.00 H	28	19.90	13.50
3	166.00	31.1 QP	43.5	-12.4	1.25 H	191	17.40	13.70
4	300.16	28.9 QP	46.0	-17.1	1.00 H	15	13.80	15.10
5	663.74	31.2 QP	46.0	-14.8	1.50 H	105	8.00	23.20
6	696.79	31.8 QP	46.0	-14.2	2.00 H	109	8.20	23.60

ANTENNA POLARITY & TEST DISTANCE: VERTICAL AT 3 M								
NO.	FREQ. (MHz)	EMISSION LEVEL (dBuV/m)	LIMIT (dBuV/m)	MARGIN (dB)	ANTENNA HEIGHT (m)	TABLE ANGLE (Degree)	RAW VALUE (dBuV)	CORRECTION FACTOR (dB/m)
1	57.12	26.5 QP	40.0	-13.5	1.50 V	338	12.90	13.60
2	166.00	27.3 QP	43.5	-16.2	1.00 V	144	13.60	13.70
3	234.05	26.7 QP	46.0	-19.3	1.25 V	219	14.20	12.50
4	296.27	25.3 QP	46.0	-20.7	1.00 V	217	10.30	15.00
5	700.68	27.8 QP	46.0	-18.2	1.25 V	89	4.10	23.70
6	900.94	29.4 QP	46.0	-16.6	2.00 V	243	2.40	27.00

REMARKS:

1. Emission level (dBuV/m) = Raw Value (dBuV) + Correction Factor (dB/m).
2. Correction Factor (dB/m) = Antenna Factor (dB/m) + Cable Factor (dB).
3. The other emission levels were very low against the limit.
4. Margin value = Emission level – Limit value.

4.2 CONDUCTED EMISSION MEASUREMENT

4.2.1 LIMITS OF CONDUCTED EMISSION MEASUREMENT

FREQUENCY OF EMISSION (MHz)	CONDUCTED LIMIT (dB μ V)	
	Quasi-peak	Average
0.15 ~ 0.5	66 to 56	56 to 46
0.5 ~ 5	56	46
5 ~ 30	60	50

- NOTE:** 1. The lower limit shall apply at the transition frequencies.
 2. The limit decreases in line with the logarithm of the frequency in the range of 0.15 to 0.50MHz.
 3. All emanations from a class A/B digital device or system, including any network of conductors and apparatus connected thereto, shall not exceed the level of field strengths specified above.

4.2.2 TEST INSTRUMENTS

Tested date: Mar. 14, 2013

DESCRIPTION & MANUFACTURER	MODEL NO.	SERIAL NO.	DATE OF CALIBRATION	DUE DATE OF CALIBRATION
Test Receiver ROHDE & SCHWARZ	ESCS30	100289	Nov. 16, 2012	Nov. 15, 2013
RF signal cable Woken	5D-FB	Cable-HYC01-01	Dec. 28, 2012	Dec. 27, 2013
LISN ROHDE & SCHWARZ (Peripheral)	ESH3-Z5	100312	Jul. 02, 2012	Jul. 01, 2013
LISN ROHDE & SCHWARZ (EUT)	ESH3-Z5	835239/001	Feb. 04, 2013	Feb. 03, 2014
Software ADT	BV ADT_Cond_ V7.3.7.3	NA	NA	NA

- NOTE:** 1. The calibration interval of the above test instruments is 12 months and the calibrations are traceable to NML/ROC and NIST/USA.
 2. The test was performed in HwaYa Shielded Room 1.
 3. The VCCI Site Registration No. is C-2040.

4.2.3 TEST PROCEDURES

- The EUT was placed 0.4 meters from the conducting wall of the shielded room with EUT being connected to the power mains through a line impedance stabilization network (LISN). Other support units were connected to the power mains through another LISN. The two LISNs provide 50 ohm/ 50uH of coupling impedance for the measuring instrument.
- Both lines of the power mains connected to the EUT were checked for maximum conducted interference.
- The frequency range from 150kHz to 30MHz was searched. Emission levels under (Limit - 20dB) was not recorded.

NOTE: All modes of operation were investigated and the worst-case emissions are reported.

4.2.4 DEVIATION FROM TEST STANDARD

No deviation.

4.2.5 TEST SETUP

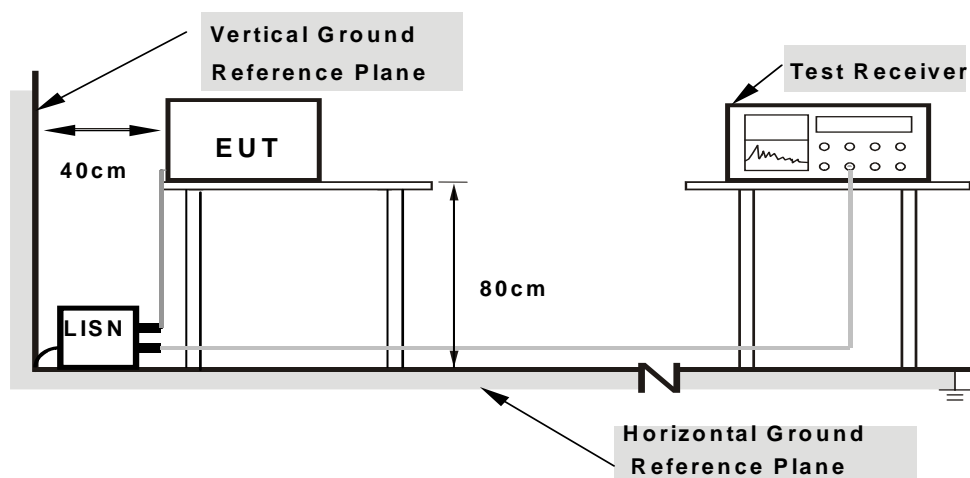

- Note:**
- Support units were connected to second LISN.
 - Both of LISNs (AMN) are 80 cm from EUT and at least 80 from other units and other metal planes

For the actual test configuration, please refer to the attached file (Test Setup Photo).

4.2.6 EUT OPERATING CONDITIONS

Same as 4.1.6.

4.2.7 TEST RESULTS

CONDUCTED WORST-CASE DATA : 802.11n (40MHz)

PHASE	Line 1	6dB BANDWIDTH	9kHz
-------	--------	---------------	------

No	Freq.	Corr. Factor	Reading Value		Emission Level		Limit		Margin	
	[MHz]		[dB (uV)]		[dB (uV)]		[dB (uV)]		(dB)	
			Q.P.	AV.	Q.P.	AV.	Q.P.	AV.	Q.P.	AV.
1	0.17605	0.19	53.37	40.43	53.56	40.62	64.67	54.67	-11.11	-14.05
2	0.49584	0.21	40.43	38.90	40.64	39.11	56.07	46.07	-15.43	-6.96
3	0.63020	0.21	38.69	32.02	38.90	32.23	56.00	46.00	-17.10	-13.77
4	0.93076	0.22	33.78	27.82	34.00	28.04	56.00	46.00	-22.00	-17.96
5	12.88878	0.68	29.26	23.92	29.94	24.60	60.00	50.00	-30.06	-25.40
6	19.66481	0.91	27.65	22.47	28.56	23.38	60.00	50.00	-31.44	-26.62

REMARKS:

1. Q.P. and AV. are abbreviations of quasi-peak and average individually.
2. The emission levels of other frequencies were very low against the limit.
3. Margin value = Emission level - Limit value
4. Correction factor = Insertion loss + Cable loss
5. Emission Level = Correction Factor + Reading Value.

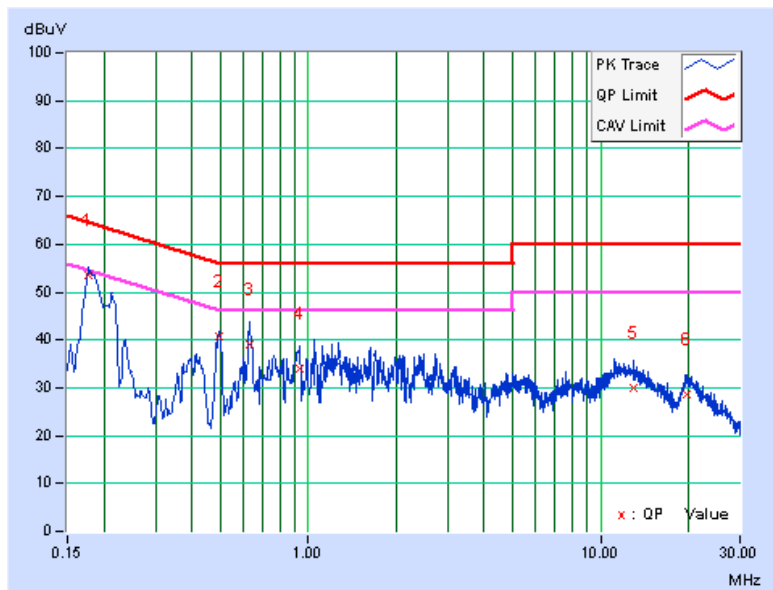



A D T

PHASE	Line 2	6dB BANDWIDTH	9kHz
--------------	--------	----------------------	------

No	Freq. [MHz]	Corr. Factor (dB)	Reading Value [dB (uV)]		Emission Level [dB (uV)]		Limit [dB (uV)]		Margin (dB)	
			Q.P.	AV.	Q.P.	AV.	Q.P.	AV.	Q.P.	AV.
			1	0.17605	0.28	53.49	40.72	53.77	41.00	64.67
2	0.49846	0.30	39.67	36.35	39.97	36.65	56.03	46.03	-16.05	-9.37
3	0.91858	0.31	33.54	27.86	33.85	28.17	56.00	46.00	-22.15	-17.83
4	2.44126	0.38	30.84	24.63	31.22	25.01	56.00	46.00	-24.78	-20.99
5	12.73238	0.76	30.09	24.63	30.85	25.39	60.00	50.00	-29.15	-24.61
6	19.86813	1.02	33.80	28.44	34.82	29.46	60.00	50.00	-25.18	-20.54

REMARKS:

1. Q.P. and AV. are abbreviations of quasi-peak and average individually.
2. The emission levels of other frequencies were very low against the limit.
3. Margin value = Emission level - Limit value
4. Correction factor = Insertion loss + Cable loss
5. Emission Level = Correction Factor + Reading Value.

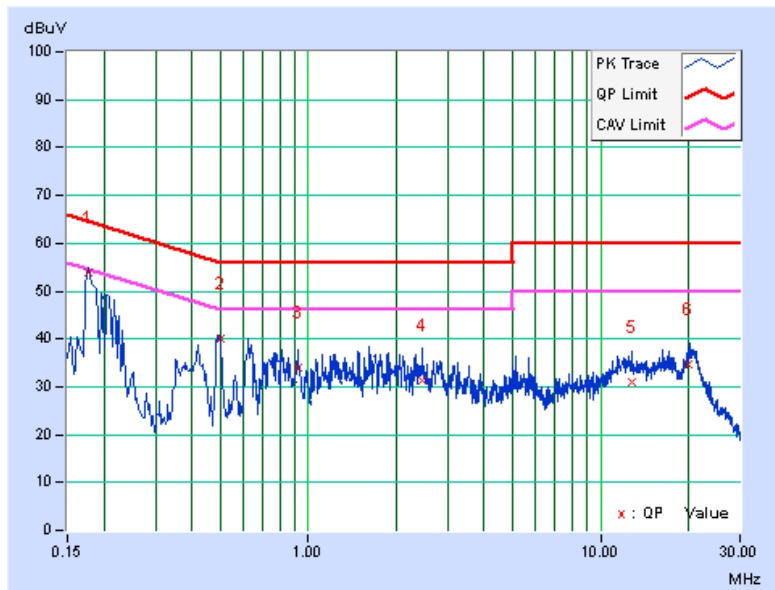

4.3 PEAK TRANSMIT POWER MEASUREMENT

4.3.1 LIMITS OF PEAK TRANSMIT POWER MEASUREMENT

FREQUENCY BAND	LIMIT
5.15 ~ 5.25GHz	The lesser of 50mW (17dBm) or 4dBm + 10logB

NOTE: Where B is the 26dB emission bandwidth in MHz.

Per KDB 662911 D01 Multiple Transmitter Output v01r02 Method of conducted output power measurement on IEEE 802.11 devices,

Array Gain = 0 dB (i.e., no array gain) for NANT ≤ 4;

Array Gain = 0 dB (i.e., no array gain) for channel widths ≥ 40 MHz for any NANT;

Array Gain = 5 log(NANT/NSS) dB or 3 dB, whichever is less for 20-MHz channel widths with NANT ≥ 5.

For power measurements on all other devices: Array Gain = 10 log(NANT/NSS) dB.

4.3.2 TEST SETUP

FOR POWER OUTPUT MEASUREMENT

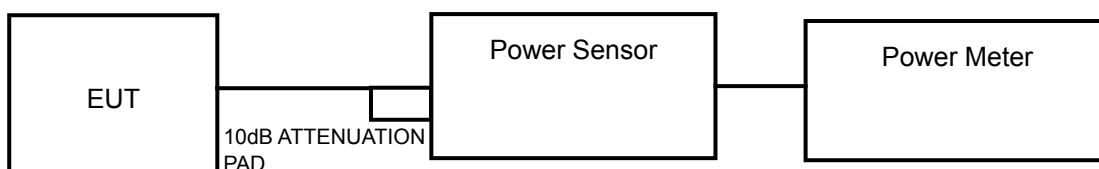

FOR 26dB BANDWIDTH

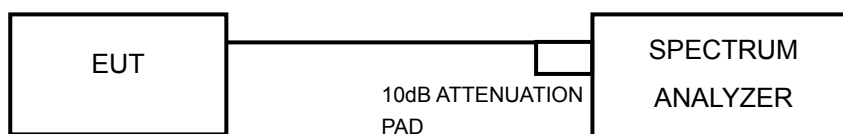

4.3.3 TEST INSTRUMENTS

Refer to section 4.1.3 to get information of above instrument.

4.3.4 TEST PROCEDURE

FOR AVERAGE POWER MEASUREMENT

Duty cycle of test signal is < 98 %. Method PM is used to perform output power measurement, trigger and gating function of wide band power meter is enabled to measure max output power of TX on burst. Duty factor is added to measured value.

FOR 26dB BANDWIDTH

- 1) Set RBW = approximately 1% of the emission bandwidth.
- 2) Set the VBW > RBW.
- 3) Detector = Peak.
- 4) Trace mode = max hold.
- 5) Measure the maximum width of the emission that is 26 dB down from the peak of the emission. Compare this with the RBW setting of the analyzer. Readjust RBW and repeat measurement as needed until the RBW/EBW ratio is approximately 1%.

4.3.5 DEVIATION FROM TEST STANDARD

No deviation.

4.3.6 EUT OPERATING CONDITIONS

The software provided by client to enable the EUT under transmission condition continuously at specific channel frequencies individually.



4.3.7 TEST RESULTS

POWER OUTPUT

802.11a

CHAN.	CHAN. FREQ. (MHz)	AVERAGE POWER (dBm)		TOTAL POWER (mW)	TOTAL POWER (dBm)	POWER LIMIT (dBm)	PASS / FAIL
		CHAIN 0	CHAIN 1				
36	5180	10.78	9.36	20.597	13.14	17	PASS
40	5200	11.01	9.65	21.844	13.39	17	PASS
48	5240	11.11	9.41	21.642	13.35	17	PASS

802.11n (20MHz)

CHAN.	CHAN. FREQ. (MHz)	AVERAGE POWER (dBm)		TOTAL POWER (mW)	TOTAL POWER (dBm)	POWER LIMIT (dBm)	PASS / FAIL
		CHAIN 0	CHAIN 1				
36	5180	12.78	10.91	31.298	14.96	17	PASS
40	5200	12.37	11.07	30.052	14.78	17	PASS
48	5240	12.48	10.72	29.504	14.70	17	PASS

802.11n (40MHz)

CHAN.	CHAN. FREQ. (MHz)	AVERAGE POWER (dBm)		TOTAL POWER (mW)	TOTAL POWER (dBm)	POWER LIMIT (dBm)	PASS / FAIL
		CHAIN 0	CHAIN 1				
38	5190	7.12	5.86	9.007	9.55	17	PASS
46	5230	14.58	12.40	46.086	16.64	17	PASS



A D T

26dB BANDWIDTH

802.11a

CHANNEL	CHANNEL FREQUENCY (MHz)	26dBc BANDWIDTH (MHz)		PASS / FAIL
		CHAIN 0	CHAIN 1	
36	5180	24.20	22.84	PASS
40	5200	22.40	21.58	PASS
48	5240	22.26	21.62	PASS

802.11n (20MHz)

CHANNEL	CHANNEL FREQUENCY (MHz)	26dBc BANDWIDTH (MHz)		PASS / FAIL
		CHAIN 0	CHAIN 1	
36	5180	24.56	22.88	PASS
40	5200	23.67	23.31	PASS
48	5240	23.84	22.48	PASS

802.11n (40MHz)

CHANNEL	CHANNEL FREQUENCY (MHz)	26dBc BANDWIDTH (MHz)		PASS / FAIL
		CHAIN 0	CHAIN 1	
38	5190	51.33	52.25	PASS
46	5230	56.68	51.63	PASS

4.4 PEAK POWER SPECTRAL DENSITY MEASUREMENT

4.4.1 LIMITS OF PEAK POWER SPECTRAL DENSITY MEASUREMENT

FREQUENCY BAND	LIMIT
5.15 ~ 5.25GHz	4dBm

4.4.2 TEST SETUP

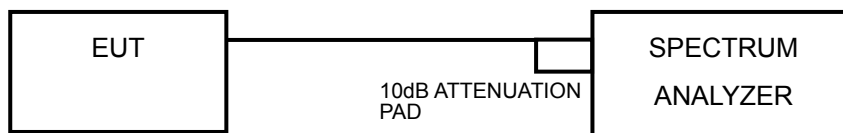

4.4.3 TEST INSTRUMENTS

Refer to section 4.1.3 to get information of above instrument.

4.4.4 TEST PROCEDURES

Using method SA-2

- 1) Set span to encompass the entire emission bandwidth (EBW) of the signal.
- 2) Set RBW = 30 KHz, Set VBW \geq 1 MHz, Detector = RMS
- 3) Set Channel power measure = 1MHz
- 4) Sweep time = auto, trigger set to "free run".
- 5) Trace average at least 100 traces in power averaging mode.
- 6) Record the max value and add 10 log (1/duty cycle)

4.4.5 DEVIATION FROM TEST STANDARD

No deviation.

4.4.6 EUT OPERATING CONDITIONS

Same as 4.3.6.

4.4.7 TEST RESULTS

802.11a

CHAN.	CHAN. FREQ. (MHz)	PSD (dBm)		TOTAL PSD W/O DUTY FACTOR (dBm)	DUTY FACTOR	TOTAL PSD WITH DUTY FACTOR (dBm)	MAX. LIMIT (dBm)	PASS / FAIL
		CHAIN 0	CHAIN 1					
36	5180	-2.31	-3.20	0.13	0.15	0.28	0.99	PASS
40	5200	-2.29	-4.91	-0.45	0.15	-0.30	0.99	PASS
48	5240	-2.46	-4.71	-0.58	0.15	-0.43	0.99	PASS

NOTE:

- Method 1 of power density measurement of KDB 662911 is using for calculating total power density. Total power density is summing entire spectra across corresponding frequency bins on the various outputs by computer.
- Directional gain = $6\text{dBi} + 10\log(2) = 9.01\text{dBi} > 6\text{dBi}$, so the power density limit shall be reduced to $4-(9.01-6) = 0.99\text{dBm}$.
- Refer to section 3.3 for duty cycle spectrum plot.

802.11n (20MHz)

CHAN.	CHAN. FREQ. (MHz)	PSD (dBm)		TOTAL PSD W/O DUTY FACTOR (dBm)	DUTY FACTOR	TOTAL PSD WITH DUTY FACTOR (dBm)	MAX. LIMIT (dBm)	PASS / FAIL
		CHAIN 0	CHAIN 1					
36	5180	-1.89	-3.99	0.05	0.15	0.20	0.99	PASS
40	5200	-1.28	-3.34	0.67	0.15	0.82	0.99	PASS
48	5240	-1.15	-3.63	0.64	0.15	0.79	0.99	PASS

NOTE:

- Method 1 of power density measurement of KDB 662911 is using for calculating total power density. Total power density is summing entire spectra across corresponding frequency bins on the various outputs by computer.
- Directional gain = $6\text{dBi} + 10\log(2) = 9.01\text{dBi} > 6\text{dBi}$, so the power density limit shall be reduced to $4-(9.01-6) = 0.99\text{dBm}$.
- Refer to section 3.3 for duty cycle spectrum plot.



802.11n (40MHz)

CHAN.	CHAN. FREQ. (MHz)	PSD (dBm)		TOTAL PSD W/O DUTY FACTOR (dBm)	DUTY FACTOR	TOTAL PSD WITH DUTY FACTOR (dBm)	MAX. LIMIT (dBm)	PASS / FAIL
		CHAIN 0	CHAIN 1					
38	5190	-9.55	-11.15	-7.66	0.39	-7.27	0.99	PASS
46	5230	-1.66	-4.67	-0.29	0.39	0.10	0.99	PASS

NOTE:

1. Method 1 of power density measurement of KDB 662911 is using for calculating total power density. Total power density is summing entire spectra across corresponding frequency bins on the various outputs by computer.
2. Directional gain = 6dBi + 10log(2) = 9.01dBi > 6dBi , so the power density limit shall be reduced to 4-(9.01-6) = 0.99dBm.
3. Refer to section 3.3 for duty cycle spectrum plot.

4.5 PEAK POWER EXCURSION MEASUREMENT

4.5.1 LIMITS OF PEAK POWER EXCURSION MEASUREMENT

Shall not exceed 13 dB

4.5.2 TEST SETUP

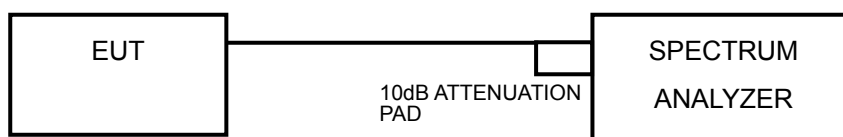

4.5.3 TEST INSTRUMENTS

Refer to section 4.1.3 to get information of above instrument.

4.5.4 TEST PROCEDURE

- 1) Set RBW = 1 MHz, VBW \geq 3 MHz, Detector = peak.
- 2) Trace mode = max-hold. Allow the sweeps to continue until the trace stabilizes.
- 3) Use the peak search function to find the peak of the spectrum.
- 4) Measure the PPSD.
- 5) Compute the ratio of the maximum of the peak-max-hold spectrum to the PPSD.

4.5.5 DEVIATION FROM TEST STANDARD

No deviation.

4.5.6 EUT OPERATING CONDITIONS

Same as 4.2.6



A D T

4.5.7 TEST RESULTS

802.11a

CHAN.	CHAN. FREQ. (MHz)	PEAK VALUE (dBm)		PPSD WITHOUT DUTY FACTOR (dBm)		PPSD WITH DUTY FACTOR (dBm)		PEAK EXCURSION (dB)		LIMIT (dB)	PASS /FAIL
		CHAIN 0	CHAIN 1	CHAIN 0	CHAIN 1	CHAIN 0	CHAIN 1	CHAIN 0	CHAIN 1		
36	5180	6.20	5.26	-2.31	-3.20	-2.16	-3.05	8.51	8.46	13	PASS
40	5200	5.80	4.57	-2.29	-4.91	-2.14	-4.76	8.09	9.48	13	PASS
48	5240	6.17	4.89	-2.46	-4.71	-2.31	-4.56	8.63	9.60	13	PASS

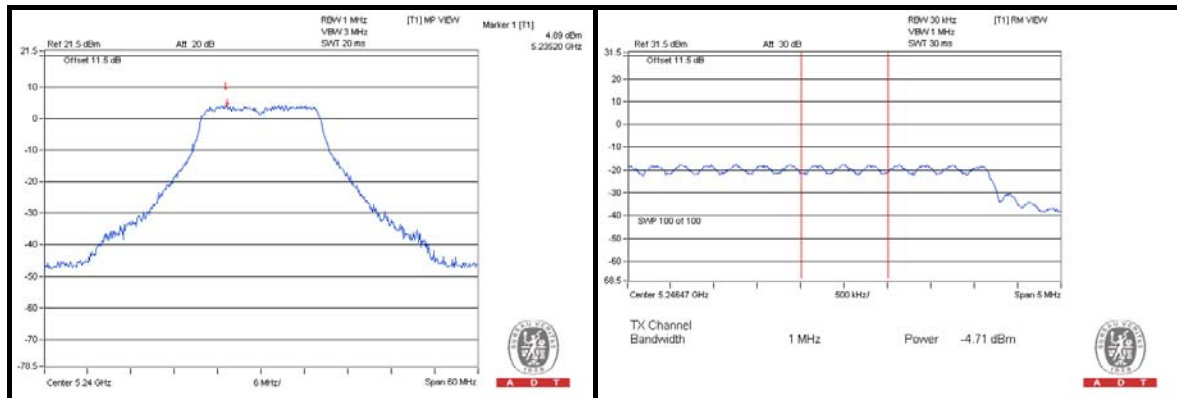



802.11n (20MHz)

CHAN.	CHAN. FREQ. (MHz)	PEAK VALUE (dBm)		PPSD WITHOUT DUTY FACTOR (dBm)		PPSD WITH DUTY FACTOR (dBm)		PEAK EXCURSION (dB)		LIMIT (dB)	PASS /FAIL
		CHAIN 0	CHAIN 1	CHAIN 0	CHAIN 1	CHAIN 0	CHAIN 1	CHAIN 0	CHAIN 1		
36	5180	6.77	4.73	-1.89	-3.99	-1.74	-3.84	8.66	8.72	13	PASS
40	5200	7.62	5.01	-1.28	-3.34	-1.13	-3.19	8.90	8.35	13	PASS
48	5240	7.22	4.73	-1.15	-3.63	-1.00	-3.48	8.37	8.36	13	PASS

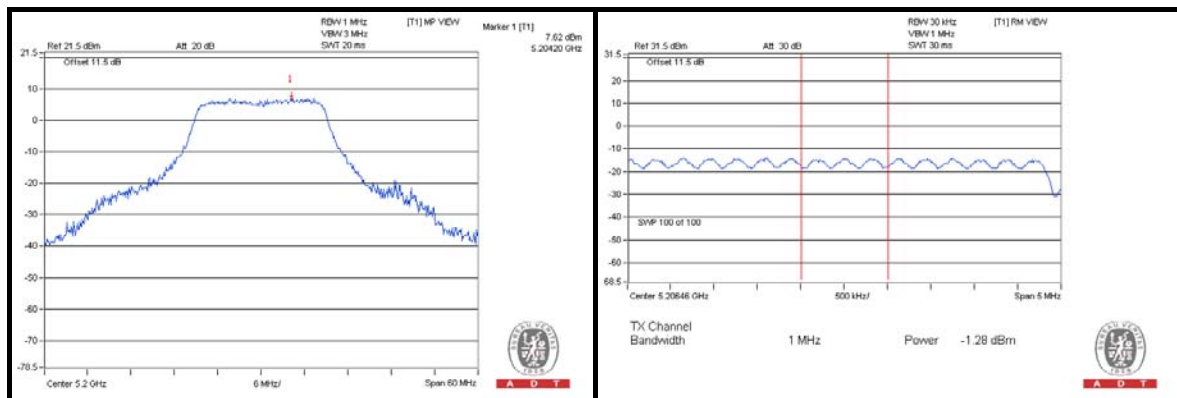

802.11n (40MHz)

CHAN.	CHAN. FREQ. (MHz)	PEAK VALUE (dBm)		PPSD WITHOUT DUTY FACTOR (dBm)		PPSD WITH DUTY FACTOR (dBm)		PEAK EXCURSION (dB)		LIMIT (dB)	PASS /FAIL
		CHAIN 0	CHAIN 1	CHAIN 0	CHAIN 1	CHAIN 0	CHAIN 1	CHAIN 0	CHAIN 1		
38	5190	-1.29	-3.24	-9.55	-11.15	-9.16	-10.76	8.26	7.91	13	PASS
46	5230	7.18	3.96	-1.66	-4.67	-1.27	-4.28	8.84	8.63	13	PASS

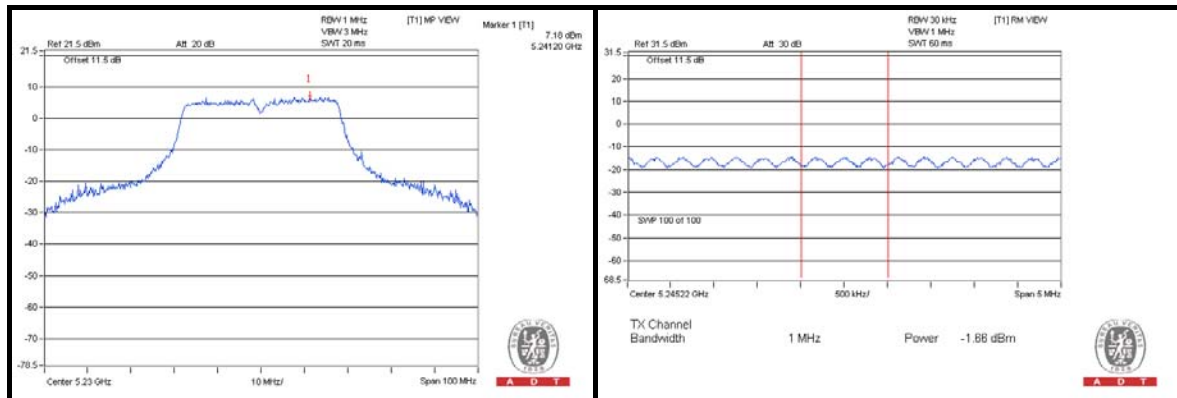

4.6 FREQUENCY STABILITY

4.6.1 LIMITS OF FREQUENCY STABILITY MEASUREMENT

The frequency of the carrier signal shall be maintained within band of operation

4.6.2 TEST SETUP

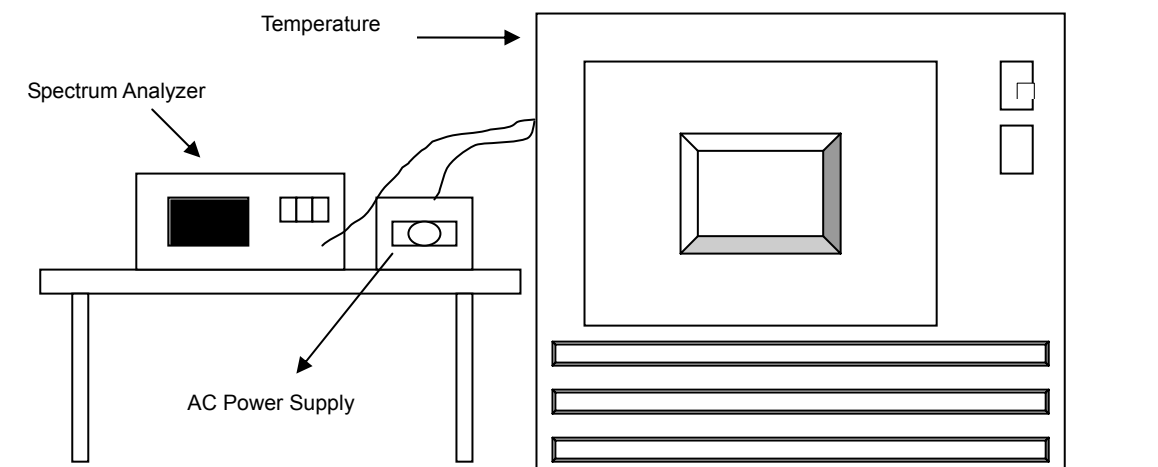

4.6.3 TEST INSTRUMENTS

Refer to section 4.1.3 to get information of above instrument.

4.6.4 TEST PROCEDURE

- a. The EUT was placed inside the environmental test chamber and powered by nominal AC voltage.
- b. Turn the EUT on and couple its output to a spectrum analyzer.
- c. Turn the EUT off and set the chamber to the highest temperature specified.
- d. Allow sufficient time (approximately 30 min) for the temperature of the chamber to stabilize, turn the EUT on and measure the operating frequency after 2, 5, and 10 minutes.
- e. Repeat step 2 and 3 with the temperature chamber set to the lowest temperature.
- f. The test chamber was allowed to stabilize at +20 degree C for a minimum of 30 minutes. The supply voltage was then adjusted on the EUT from 85% to 115% and the frequency record.

4.6.5 DEVIATION FROM TEST STANDARD

No deviation.

4.6.6 EUT OPERATING CONDITION

Set the EUT transmit at un-modulation mode to test frequency stability.

4.6.7 TEST RESULTS

FREQUENCY STABILITY VERSUS TEMP.									
OPERATING FREQUENCY: 5200MHz									
TEMP. (°C)	POWER SUPPLY (Vac)	0 MINUTE		2 MINUTE		5 MINUTE		10 MINUTE	
		Measured Frequency (MHz)	Frequency Drift (ppm)	Measured Frequency (MHz)	Frequency Drift (ppm)	Measured Frequency (MHz)	Frequency Drift (ppm)	Measured Frequency (MHz)	Frequency Drift (ppm)
60	120	5200.0187	3.5962	5199.9874	-2.4231	5200.0207	3.9808	5199.9853	-2.8269
50	120	5199.9906	-1.8077	5199.9868	-2.5385	5199.9875	-2.4038	5199.986	-2.6923
40	120	5200.015	2.8846	5200.0114	2.1923	5200.0169	3.2500	5200.0105	2.0192
30	120	5199.9951	-0.9423	5199.9921	-1.5192	5199.9922	-1.5000	5199.9983	-0.3269
20	120	5200.0173	3.3269	5200.0149	2.8654	5200.0156	3.0000	5200.0159	3.0577
10	120	5200.0081	1.5577	5200.0081	1.5577	5200.0085	1.6346	5200.0083	1.5962
0	120	5199.9757	-4.6731	5199.9708	-5.6154	5199.9699	-5.7885	5199.9797	-3.9038
-10	120	5200.0286	5.5000	5200.0274	5.2692	5200.0225	4.3269	5200.0259	4.9808
-20	120	5199.9882	-2.2692	5199.9906	-1.8077	5199.9913	-1.6731	5199.9911	-1.7115
-30	120	5200.0198	3.8077	5200.0187	3.5962	5200.0185	3.5577	5200.0162	3.1154

FREQUENCY STABILITY VERSUS VOLTAGE									
OPERATING FREQUENCY: 5200MHz									
TEMP. (°C)	POWER SUPPLY (Vac)	0 MINUTE		2 MINUTE		5 MINUTE		10 MINUTE	
		Measured Frequency (MHz)	Frequency Drift (ppm)	Measured Frequency (MHz)	Frequency Drift (ppm)	Measured Frequency (MHz)	Frequency Drift (ppm)	Measured Frequency (MHz)	Frequency Drift (ppm)
20	138	5200.0169	3.2500	5200.0132	2.5385	5200.0153	2.9423	5200.0161	3.0962
	120	5200.0173	3.3269	5200.0149	2.8654	5200.0156	3.0000	5200.0159	3.0577
	102	5200.0179	3.4423	5200.0137	2.6346	5200.0162	3.1154	5200.015	2.8846

5. PHOTOGRAPHS OF THE TEST CONFIGURATION

Please refer to the attached file (Test Setup Photo).



6. INFORMATION ON THE TESTING LABORATORIES

We, Bureau Veritas Consumer Products Services (H.K.) Ltd., Taoyuan Branch, were founded in 1988 to provide our best service in EMC, Radio, Telecom and Safety consultation. Our laboratories are accredited and approved according to ISO/IEC 17025.

If you have any comments, please feel free to contact us at the following:

Linko EMC/RF Lab:

Tel: 886-2-26052180

Fax: 886-2-26051924

Hsin Chu EMC/RF Lab:

Tel: 886-3-5935343

Fax: 886-3-5935342

Hwa Ya EMC/RF/Safety Telecom Lab:

Tel: 886-3-3183232

Fax: 886-3-3270892

Email: service.adt@tw.bureauveritas.com

Web Site: www.bureauveritas-adt.com

The address and road map of all our labs can be found in our web site also.

7. APPENDIX A - MODIFICATIONS RECORDERS FOR ENGINEERING CHANGES TO THE EUT BY THE LAB

No modifications were made to the EUT by the lab during the test.

---END---