

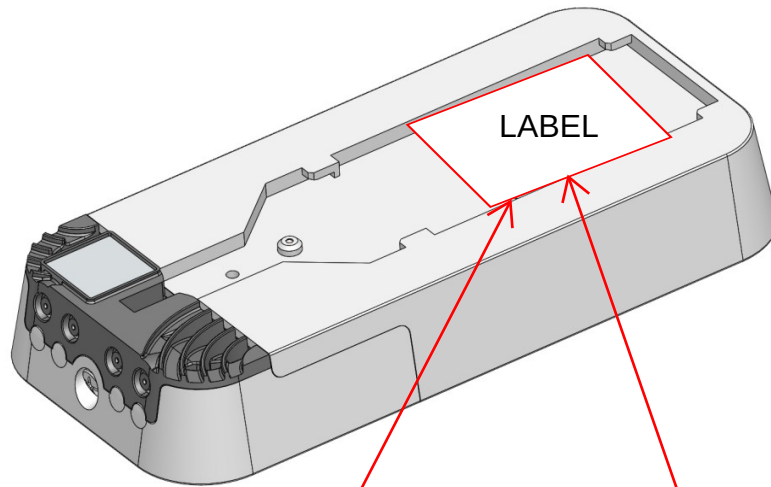

# Label location: wAPG-5HaxD2HaxD







FCC/IC LABEL

**wAP ax**  
ID: wAPG-5HaxD2HaxD-US  
FCC ID: TV7WAPGR52AX  
IC: 7442A-WAPGR52AX  
E01: 00: 00: 00: 00: 00: 00  
W01: 00: 00: 00: 00: 00: 03  
SN: 123407ABCDEF  
User: admin  
Password: PASSWORD-0000  
Wifi key: PASSWORD-0001



This device complies with Part 15 of the FCC Rules. Operation is subject to the following two conditions:  
1) this device may not cause harmful interference,  
and 2) this device must accept any interference received, including interference that may cause undesired operation.

Mikrotikls SIA, Unijas iela 2,  
Riga, Latvia, LV1039



43 mm



37 mm





CE LABEL

**wAP ax**  
ID: wAPG-5HaxD2HaxD  
FCC ID: TV7WAPGR52AX  
IC: 7442A-WAPGR52AX  
E01: 00: 00: 00: 00: 00: 00  
W01: 00: 00: 00: 00: 00: 03  
SN: 123407ABCDEF  
User: admin  
Password: PASSWORD-0000  
Wifi key: PASSWORD-0001



This device complies with Part 15 of the FCC Rules. Operation is subject to the following two conditions:  
1) this device may not cause harmful interference,  
and 2) this device must accept any interference received, including interference that may cause undesired operation.

Mikrotikls SIA, Unijas iela 2,  
Riga, Latvia, LV1039



43 mm



37 mm