

**SUBMITTAL
APPLICATION
REPORT**

**FOR
GRANT OF CERTIFICATION**

FOR

**Model: RBSXTG-2HnD
2412-2462 MHz
Broadband Digital Transmission System
FCC ID: TV7SXTG-2HND**

FOR

MIKROTIKLS SIA
Pernavas 46
Riga, Latvia LV-1009

Test Report Number: 120716

Authorized Signatory: *Scot D Rogers*
Scot D. Rogers

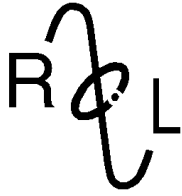

ROGERS LABS, INC.

4405 West 259th Terrace
Louisburg, KS 66053
Phone / Fax (913) 837-3214

Engineering Test Report For Grant of Certification Application

FOR
CFR 47, PART 15C - Intentional Radiators
CFR 47 Paragraph 15.247
License Exempt Intentional Radiator

For

MIKROTIKLS SIA

Pernavas 46
Riga, Latvia LV-1009

Broadband Digital Transmission System
Model: RBSXTG-2HnD
Frequency Range 2412-2462 MHz
FCC ID#: TV7SXTG-2HND

Test Date: July 16, 2012

Certifying Engineer: *Scot D. Rogers*
Scot D. Rogers
Rogers Labs, Inc.
4405 West 259th Terrace
Louisburg, KS 66053
Telephone/Facsimile: (913) 837-3214

This report shall not be reproduced except in full, without the written approval of the laboratory. This report must not be used by the client to claim product endorsement by NVLAP, NIST, or any agency of the U.S. Government.



Table Of Contents

TABLE OF CONTENTS..... 3

REVISIONS..... 4

FORWARD 5

OPINION / INTERPRETATION OF RESULTS 5

ENVIRONMENTAL CONDITIONS..... 5

EQUIPMENT TESTED 5

APPLICATION FOR CERTIFICATION..... 6

APPLICABLE STANDARDS & TEST PROCEDURES 7

EQUIPMENT FUNCTION AND CONFIGURATION..... 7

Equipment Configuration.....8

TEST SITE LOCATIONS 8

UNITS OF MEASUREMENTS 8

TEST PROCEDURES..... 9

AC Line Conducted Emission Test Procedure9

Radiated Emission Test Procedure.....9

LIST OF TEST EQUIPMENT 10

INTENTIONAL RADIATORS..... 11

Antenna Requirements11

Restricted Bands of Operation.....11

 General Radiated Emissions in Restricted Bands Data (General)12

 Harmonic Radiated Emissions in Restricted Bands Data12

Summary of Results for Radiated Emissions in Restricted Bands13



AC Line Conducted Emissions Procedure13

 Figure One AC Line Conducted Emissions Line 114

 Figure Two AC Line Conducted Emissions Line 214

 AC Line Conducted Emissions Data (Highest Emissions)15

Summary of Results for AC Line Conducted Emissions15

General Radiated Emissions Procedure16

 General Radiated Emissions from EUT Data (Highest Emissions)17

Summary of Results for General Radiated Emissions17

Operation in the Band 2400 – 2483.5 MHz18

 Figure Three Plot of Transmitter Emissions (Across Operational Band, 5 MHz Mode)19

 Figure Four Plot of Transmitter Emissions (Across Operational Band, 10 MHz Mode)19

 Figure Five Plot of Transmitter Emissions (Across Operational Band, 20 MHz Mode)20

 Figure Six Plot of Transmitter Emissions (Across Operational Band, 40 MHz Mode)20

 Figure Seven Plot of Low Band Edge21

 Figure Eight Plot of High Band Edge21

Transmitter Emissions Data22

 Calculated Transmitter Antenna Port Power22

 Transmitter Radiated Emission23

 Summary of Results for Transmitter Radiated Emissions of Intentional Radiator24

STATEMENT OF MODIFICATIONS AND DEVIATIONS 24

ANNEX 25

Annex A Measurement Uncertainty Calculations26

Annex B Rogers Labs Test Equipment List27

Annex C Rogers Qualifications28

Annex D FCC Site Registration Letter29

Annex E Industry Canada Site Registration Letter30

Revisions

Revision 1, Original Report Issued



Forward

The following information is submitted for consideration in obtaining Grant of Certification for License Exempt Digital Transmission System Intentional Radiator operating under CFR 47 Paragraph 15.247.

Name of Applicant: Mikrotiks SIA
Pernavas 46
Riga, Latvia LV-1009

Model: RBSXTG-2HnD

FCC I.D.: TV7SXTG-2HND FRN: 0014 43 1100

Frequency Range: 2412-2462 MHz (5, 10, 20 MHz channel operation), 2422-2452 MHz (40 MHz channel operation)

Operating Power: 1-Watt output power, 30 dBm

Opinion / Interpretation of Results

Tests Performed	Margin (dB)	Results
Emissions as per CFR 47 paragraphs 2 and 15.205	-1.0	Complies
Emissions as per CFR 47 paragraphs 2 and 15.207	-11.0	Complies
Emissions as per CFR 47 paragraphs 2 and 15.209	-2.6	Complies
Harmonic Emissions per CFR 47 15.247	-13.3	Complies
Peak Power Spectral Density per CFR 47 15.247	-9.9	Complies

Environmental Conditions

Ambient Temperature 24.5° C
Relative Humidity 46%
Atmospheric Pressure 1011.0 mb

Equipment Tested

<u>Equipment</u>	<u>Model</u>	<u>FCC I.D.</u>
EUT	RBSXTG-2HnD	TV7SXTG-2HND
AC Adapter	FLD181-240075-U	N/A
Dell Studio XPS	921LBN1	N/A
Rogers Labs, Inc. 4405 W. 259th Terrace Louisburg, KS 66053 Phone/Fax: (913) 837-3214 Revision 1	Mikrotiks SIA Model: RBSXTG-2HnD Test #: 120716 Test to: CFR47 (15.247) File: Mikrotiks RBSXTG2HnD TstRpt 120716	SN: 399501DD0C31 FCC ID#: TV7SXTG-2HND Date: July 31, 2012 Page 5 of 30

Application for Certification

- (1) Manufacturer: Mikrotikls SIA
Pernavas 46
Riga, Latvia LV-1009
- (2) Identification: Model: RBSXTG-2HnD
FCC I.D.: TV7SXTG-2HND
- (3) Instruction Book:
Refer to Exhibit for Instruction Manual.
- (4) Description of Circuit Functions:
Refer to Exhibit of Operational Description.
- (5) Block Diagram with Frequencies:
Refer to Exhibit of Operational Description.
- (6) Report of Measurements:
Report of measurements follows in this Report.
- (7) Photographs: Construction, Component Placement, etc.:
Refer to Exhibit for photographs of equipment.
- (8) List of Peripheral Equipment Necessary for operation. The equipment operates from power received from authorized AC/DC power adapter. The EUT offers connection ports for network interface only and requires Power Over Ethernet (POE) power for operation. During testing, the EUT was connected to CPU through network cable. The EUT received power supplied from external AC/DC supply connected to POE adapter.
- (9) Transition Provisions of CFR47 15.37 are not requested.
- (10) Not Applicable. The unit is not a scanning receiver.
- (11) Not Applicable. The EUT does not operate in the 59 – 64 GHz frequency band.
- (12) The equipment is not software defined and this section is not applicable.

Applicable Standards & Test Procedures

In accordance with the Federal Communications Code of Federal Regulations, dated October 1, 2011, Part 2, Subpart J, Paragraphs 2.907, 2.911, 2.913, 2.925, 2.926, 2.1031 through 2.1057, and applicable parts of paragraph 15, Part 15C Paragraph 15.247 the following information is submitted. Test procedures used are the established Methods of Measurement of Radio-Noise Emissions as described in the ANSI C63.4-2009 Document, FCC documents KDB 662911 and KDB 558074. Testing for the AC line-conducted emissions were performed as defined in sections 7 and 13.1.3, testing of the radiated emissions was performed as defined in sections 8 and 13.1.4 of ANSI C63.4-2009. Testing of the intentional radiated emissions was performed as defined in section 13 of ANSI C63.4-2009.

Equipment Function and Configuration

The EUT is a 2412-2462 MHz Digital Transmission System used to transmit data in applications offering broadband wireless connectivity. The equipment is marketed for use to incorporate a wireless link to exchange data information from one point to another. For testing purposes, the RBSXTG-2HnD transceiver was connected to the manufacturer supplied POE and AC/DC supply and communicating to the laptop computer through network interface. This configuration offered operational control of the transmitter and communications over the network interface between the EUT and supporting computer system. The RBSXTG-2HnD receives power from the supplied POE and AC/DC adapter connected to utility power systems. The EUT offers connection port for network interface only and requires power supplied from external source AC/DC adapter and POE, no other interfacing options are provided. For testing purposes, the RBSXTG-2HnD received powered from the AC/DC supply and configured to transmit in available data modes. The device is produced with integral antenna system only. The antenna system complies with requirements for unique antenna connection port.

Equipment Configuration

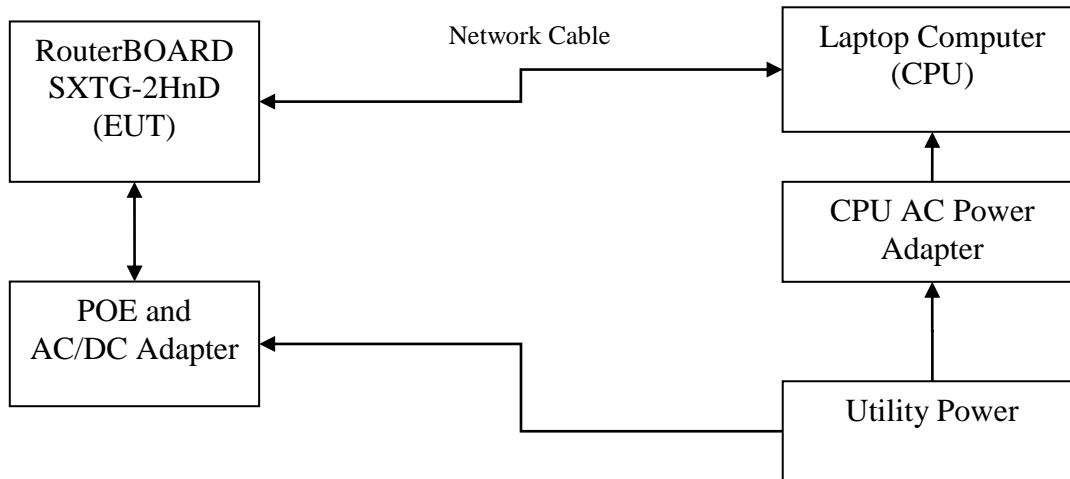

Test Site Locations

Conducted EMI The AC power line conducted emissions testing performed in a shielded screen room located at Rogers Labs, Inc., 4405 W. 259th Terrace, Louisburg, KS

Radiated EMI The radiated emissions tests were performed at the 3 meters, Open Area Test Site (OATS) located at Rogers Labs, Inc., 4405 W. 259th Terrace, Louisburg, KS

Site Registration Refer to Annex for Site Registration Letters

NVLAP Accreditation Lab code 200087-0

Units of Measurements

Conducted EMI Data is in dB μ V; dB referenced to one microvolt

Radiated EMI Data is in dB μ V/m; dB/m referenced to one microvolt per meter

Sample Calculation:

RFS = Radiated Field Strength, FSM = Field Strength Measured

A.F. = Receive antenna factor, Gain = amplification gains and/or cable losses

RFS (dB μ V/m @ 3m) = FSM (dB μ V) + A.F. (dB) - Gain (dB)

Test Procedures

AC Line Conducted Emission Test Procedure

The EUT operates from DC power only and must be connected to an approved AC/DC adapter for operation. For testing purposes, the manufacturer supplied AC/DC power adapter was used to power the EUT and system. Testing for the AC line-conducted emissions testing was performed as defined in sections 7 and 13.1.3 of ANSI C63.4-2009. The test setup including the EUT was arranged in typical equipment configurations and placed on a 1 x 1.5-meter wooden bench, 0.8 meters high located in a screen room. The power lines of the system were isolated from the power source using a standard LISN with a 50- μ Hy choke. EMI was coupled to the spectrum analyzer through a 0.1 μ F capacitor internal to the LISN. The LISN was positioned on the floor beneath the wooden bench supporting the EUT. The power lines and cables were draped over the back edge of the table.

Radiated Emission Test Procedure

The EUT was placed on a rotating 1 x 1.5-meter wooden platform, 0.8 meters above the ground plane at a distance of 3 meters from the FSM antenna. Testing for the radiated emissions was performed as required by CFR47 15 and specified in sections 8 and 13.1.4 of ANSI C63.4-2009. EMI energy was maximized by equipment placement, raising and lowering the FSM antenna, changing the antenna polarization, and by rotating the turntable. Each emission was maximized before data was taken using a spectrum analyzer. Refer to photographs in the test setup exhibits for EUT placement during testing.

List of Test Equipment

A Rohde and Schwarz ESU40 and/or Hewlett Packard 8591EM was used as the measuring device for the emissions testing of frequencies below 1 GHz. A Rohde and Schwarz ESU40 and/or Hewlett Packard 8562A Spectrum Analyzer was used as the measuring device for testing the emissions at frequencies above 1 GHz. The analyzer settings used are described in the following table. Refer to the appendix for a complete list of test equipment.

AC Line Conducted Emissions (0.150 -30 MHz)		
RBW	AVG. BW	Detector Function
9 kHz	30 kHz	Peak / Quasi Peak
Emissions (30-1000 MHz)		
RBW	AVG. BW	Detector Function
120 kHz	300 kHz	Peak / Quasi Peak
Emissions (Above 1000 MHz)		
RBW	Video BW	Detector Function
100 kHz	100 kHz	Peak
1 MHz	1 MHz	Peak / Average

<u>Equipment</u>	<u>Manufacturer</u>	<u>Model</u>	<u>Calibration Date</u>	<u>Due</u>
LISN	Comp. Design	FCC-LISN-2-MOD.CD	10/11	10/12
Antenna	ARA	BCD-235-B	10/11	10/12
Antenna	EMCO	3147	10/11	10/12
Antenna	EMCO	3147	10/11	10/12
Antenna	Com Power	AH-118	10/11	10/12
Analyzer	HP	8591EM	5/12	5/13
Analyzer	HP	8562A	5/12	5/13
Analyzer	Rohde & Schwarz	ESU40	5/12	5/13



Intentional Radiators

As per CFR47, Subpart C, paragraph 15.247 the following information is submitted.

Antenna Requirements

The EUT incorporates integral antenna system and offers no provision for connection to alternate system. The antenna connection point complies with the unique antenna connection requirements. The requirements of 15.203 are fulfilled; there are no deviations or exceptions to the specification.

Restricted Bands of Operation

Spurious emissions falling in the restricted frequency bands of operation were measured at a distance of three meters on the OATS. Measurements were made for each antenna option. Emissions other than transmitter harmonics measured similar for all configurations and are presented below. Harmonic emissions, in restricted bands, were measured for each antenna offered and recorded. The EUT utilizes frequency, determining circuitry, which generates harmonics falling in the restricted bands. Emissions were measured at the OATS, using appropriate antennas or pyramidal horns, amplification stages, and a spectrum analyzer. No other significant emission was observed which fell into the restricted bands of operation.

General Radiated Emissions in Restricted Bands Data (General)

Frequency in MHz	Horizontal Peak (dBµV/m)	Horizontal Quasi-Peak (dBµV/m)	Horizontal Average (dBµV/m)	Vertical Peak (dBµV/m)	Vertical Quasi-Peak (dBµV/m)	Vertical Average (dBµV/m)	Limit @ 3m (dBµV/m)
113.0	39.9	34.5	N/A	34.9	28.0	N/A	43.5
125.0	42.3	39.7	N/A	34.3	31.9	N/A	43.5
165.2	36.7	30.8	N/A	24.7	20.2	N/A	43.5
250.0	41.3	37.4	N/A	33.1	30.5	N/A	46.0
400.0	42.0	34.8	N/A	43.8	35.7	N/A	46.0

Other emissions present had amplitudes at least 20 dB below the limit. Peak and Quasi-Peak amplitude emissions are recorded above for frequency range of 30-1000 MHz. Peak and Average amplitude emissions are recorded above for frequency range above 1000 MHz.

Harmonic Radiated Emissions in Restricted Bands Data

Frequency in MHz	Horizontal Peak (dBµV/m)	Horizontal Quasi-Peak (dBµV/m)	Horizontal Average (dBµV/m)	Vertical Peak (dBµV/m)	Vertical Quasi-Peak (dBµV/m)	Vertical Average (dBµV/m)	Limit @ 3m (dBµV/m)
2390.0	61.1	N/A	50.2	63.4	N/A	53.0	54.0
2483.5	64.9	N/A	51.4	63.7	N/A	52.5	54.0
4824.0	50.1	N/A	37.4	50.6	N/A	37.5	54.0
4874.0	49.7	N/A	37.1	50.0	N/A	37.2	54.0
4924.0	54.0	N/A	16.6	16.1	N/A	37.3	54.0
7236.0	59.8	N/A	37.5	61.6	N/A	38.0	54.0
7311.0	59.0	N/A	36.6	59.8	N/A	36.9	54.0
7386.0	54.0	N/A	16.6	16.1	N/A	36.0	54.0
12060.0	50.2	N/A	37.4	50.3	N/A	37.4	54.0
12185.0	48.2	N/A	35.4	48.5	N/A	35.6	54.0
12310.0	49.6	N/A	35.8	48.3	N/A	35.4	54.0
14472.0	51.9	N/A	39.5	52.2	N/A	39.6	54.0

Other emissions present had amplitudes at least 20 dB below the limit. Peak and Quasi-Peak amplitude emissions are recorded above for frequency range of 30-1000 MHz. Peak and Average amplitude emissions are recorded above for frequency range above 1000 MHz.

Summary of Results for Radiated Emissions in Restricted Bands

The EUT demonstrated compliance with the radiated emissions requirements of CFR 47 Part 15C Intentional Radiators. The EUT demonstrated a minimum margin of -1.0 dB below the radiated emissions requirements in restricted frequency bands. Peak, Quasi-peak, and average amplitudes were checked for compliance with the regulations. Worst-case emissions are reported with other emissions found in the restricted frequency bands at least 20 dB below the requirements.

AC Line Conducted Emissions Procedure

The EUT was arranged in a typical equipment configuration and placed on a 1 x 1.5-meter wooden bench 80 cm above the conducting ground plane, floor of a screen room. The bench was positioned 40 cm away from the wall of the screen room. The LISN was positioned on the floor of the screen room 80-cm from the rear of the EUT. The manufacturer supplied AC power adapter for the EUT was connected to the LISN. A second LISN was positioned on the floor of the screen room 80-cm from the rear of the supporting equipment of the EUT. All power cords except the EUT were then powered from the second LISN. EMI was coupled to the spectrum analyzer through a 0.1 μ F capacitor, internal to the LISN. Power line conducted emissions testing were carried out individually for each current carrying conductor of the EUT. The excess length of lead between the system and the LISN receptacle was folded back and forth to form a bundle not exceeding 40 cm in length. The screen room, conducting ground plane, analyzer, and LISN were bonded together to the protective earth ground. Preliminary testing was performed to identify the frequency of each radio frequency emission displaying the highest amplitude. The cables were repositioned to obtain maximum amplitude of measured EMI level. Once the worst-case configuration was identified, plots were made of the EMI from 0.15 MHz to 30 MHz then the data was recorded with maximum conducted emissions levels. Refer to figures one and two for plots of the EUT powered by POE and AC/DC adapter, AC Power Line conducted emissions.

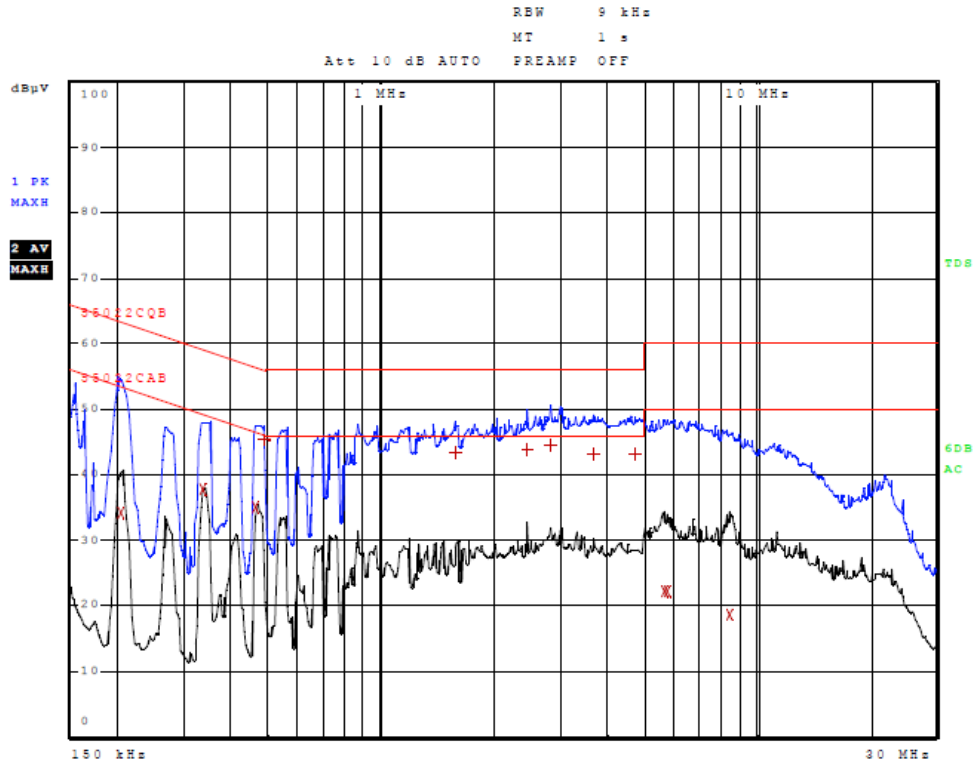

Figure One AC Line Conducted Emissions Line 1

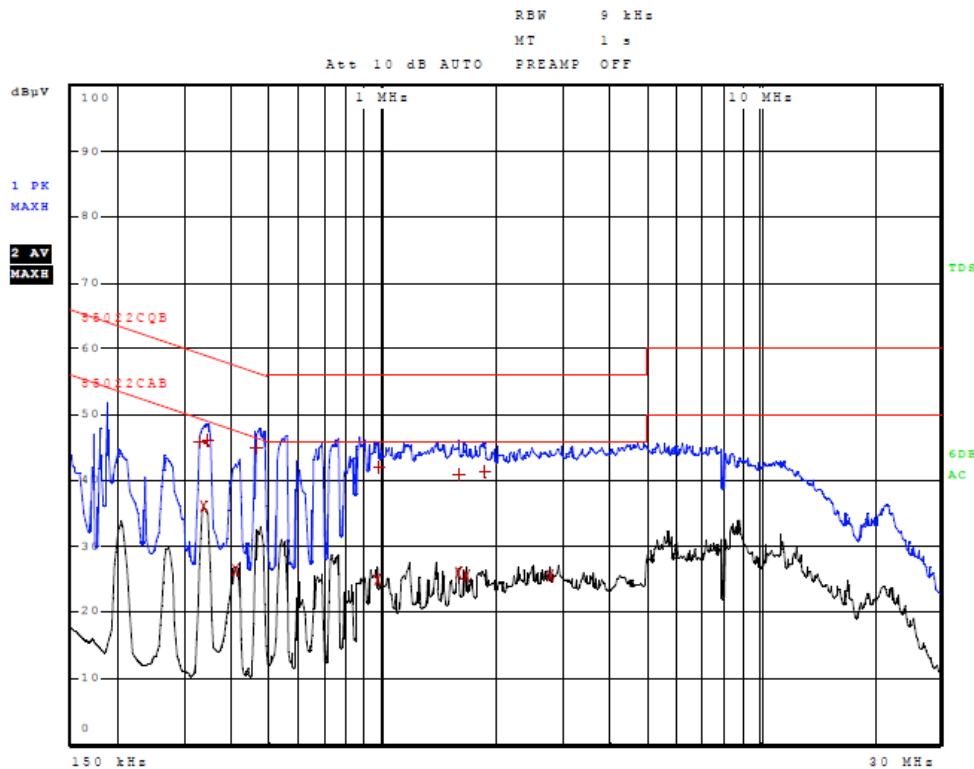

Figure Two AC Line Conducted Emissions Line 2



AC Line Conducted Emissions Data (Highest Emissions)

Line 1

Trace	Frequency	Level (dBµV)	Detector	Delta Limit/dB
2	206.000000000 kHz	34.09	Average	-19.28
2	338.000000000 kHz	37.79	Average	-11.47
2	466.000000000 kHz	35.04	Average	-11.54
1	486.000000000 kHz	45.18	Quasi Peak	-11.06
1	1.570000000 MHz	43.33	Quasi Peak	-12.67
1	2.438000000 MHz	43.72	Quasi Peak	-12.28
1	2.834000000 MHz	44.45	Quasi Peak	-11.55
1	3.690000000 MHz	43.07	Quasi Peak	-12.93
1	4.750000000 MHz	43.20	Quasi Peak	-12.80
2	5.660000000 MHz	22.15	Average	-27.85
2	5.792000000 MHz	22.11	Average	-27.89
2	8.492000000 MHz	18.69	Average	-31.31

Line 2

Trace	Frequency	Level (dBµV)	Detector	Delta Limit/dB
1	330.000000000 kHz	45.59	Quasi Peak	-13.86
2	334.000000000 kHz	35.93	Average	-13.42
1	342.000000000 kHz	46.02	Quasi Peak	-13.14
2	406.000000000 kHz	26.36	Average	-21.37
1	466.000000000 kHz	44.82	Quasi Peak	-11.77
2	970.000000000 kHz	24.90	Average	-21.10
1	974.000000000 kHz	41.85	Quasi Peak	-14.15
2	1.582000000 MHz	26.02	Average	-19.98
1	1.586000000 MHz	40.95	Quasi Peak	-15.05
2	1.666000000 MHz	25.45	Average	-20.55
1	1.870000000 MHz	41.21	Quasi Peak	-14.79
2	2.770000000 MHz	25.42	Average	-20.58

Other emissions present had amplitudes at least 20 dB below the limit.

Summary of Results for AC Line Conducted Emissions

The EUT demonstrated compliance to the conducted emissions requirements of CFR47 Part 15C equipment. The EUT demonstrated minimum margin of -111.0 dB below the limit.

Measurements were taken using the peak, quasi peak, and average, measurement function for each emissions amplitude and were below the limits stated in the specification. Other emissions were present with recorded data representing worst-case amplitudes.



General Radiated Emissions Procedure

The EUT was arranged in a typical equipment configuration and operated through all available modes with worst-case data recorded. Preliminary testing was performed in a screen room with the EUT positioned 1 meter from the FSM. Radiated emissions measurements were performed to identify the frequencies, which produced the highest emissions. Plots were made of the radiated frequency spectrum from 30 MHz to 25,000 MHz for the preliminary testing. Each radiated emission was then maximized at the OATS location before final radiated emissions measurements were performed. Final data was taken with the EUT located at the OATS at a distance of 3 meters between the EUT and the receiving antenna. The frequency spectrum from 9 kHz to 25,000 MHz was searched for general radiated emissions. Measured emission levels were maximized by EUT placement on the table, rotating the turntable through 360 degrees, varying the antenna height between 1 and 4 meters above the ground plane and changing antenna position between horizontal and vertical polarization. Antennas used were Loop from 9 kHz to 30 MHz, Broadband Biconical from 30 to 200 MHz, Biconilog from 30 to 1000 MHz, Log Periodic from 200 MHz to 1 GHz and or double Ridge or pyramidal horns and mixers from 1 GHz to 40 GHz, notch filters and appropriate amplifiers and external mixers were utilized.

General Radiated Emissions from EUT Data (Highest Emissions)

Frequency in MHz	Horizontal Peak (dBµV/m)	Horizontal Quasi-Peak (dBµV/m)	Horizontal Average (dBµV/m)	Vertical Peak (dBµV/m)	Vertical Quasi-Peak (dBµV/m)	Vertical Average (dBµV/m)	Limit @ 3m (dBµV/m)
49.2	39.8	28.8	N/A	41.7	34.5	N/A	40.0
49.5	35.3	28.6	N/A	41.7	34.5	N/A	40.0
62.5	34.1	28.5	N/A	70.5	33.8	N/A	40.0
75.5	33.4	28.2	N/A	39.9	34.5	N/A	40.0
78.4	34.3	28.4	N/A	37.7	34.8	N/A	40.0
80.4	32.3	26.5	N/A	38.1	34.9	N/A	40.0
105.3	41.4	33.7	N/A	36.3	31.6	N/A	43.5
113.0	39.9	34.5	N/A	34.9	28.0	N/A	43.5
125.0	42.3	39.7	N/A	34.3	31.9	N/A	43.5
149.4	36.1	30.6	N/A	33.7	27.9	N/A	43.5
151.8	36.8	31.2	N/A	31.2	25.7	N/A	43.5
159.0	35.8	31.2	N/A	27.1	20.7	N/A	43.5
165.2	36.7	30.8	N/A	24.7	20.2	N/A	43.5
179.0	38.3	32.1	N/A	29.0	23.7	N/A	43.5
181.1	37.5	32.0	N/A	29.1	23.6	N/A	43.5
204.0	38.0	32.8	N/A	33.5	28.9	N/A	43.5
214.9	35.6	30.9	N/A	34.4	28.7	N/A	43.5
233.6	33.9	28.1	N/A	31.7	25.6	N/A	46.0
238.6	32.2	25.5	N/A	31.1	25.4	N/A	46.0
250.0	41.3	37.4	N/A	33.1	30.5	N/A	46.0
299.3	25.7	20.2	N/A	28.7	23.2	N/A	46.0
400.0	42.0	34.8	N/A	43.8	35.7	N/A	46.0
800.0	44.6	43.4	N/A	40.6	39.3	N/A	46.0
875.0	33.2	28.1	N/A	35.4	28.4	N/A	46.0

Other emissions present had amplitudes at least 20 dB below the limit. Peak and Quasi-Peak amplitude emissions are recorded above for frequency range of 30-1000 MHz. Peak and Average amplitude emissions are recorded above for frequency range above 1000 MHz.

Summary of Results for General Radiated Emissions

The EUT demonstrated compliance with the radiated emissions requirements of CFR47 Part 15C paragraph 15.209 Intentional Radiators. The EUT demonstrated a minimum margin of -2.6 dB below the requirements. Other emissions were present with amplitudes at least 20 dB below the Limits.

Operation in the Band 2400 – 2483.5 MHz

The power output was measured at the open area test site at a three-meter distance. The EUT was placed on a wooden turntable 0.8 meters above the ground plane at a distance of 3 meters from the FSM antenna. The peak and quasi-peak amplitude of the frequencies below 1000 MHz were measured using a spectrum analyzer. The peak and average amplitude of emissions above 1000 MHz including were measured using a spectrum analyzer. Emissions data was recorded from the measurement results. Plots were made of transmitter performance for reference purposes. Refer to figures three through eight showing plots taken of the EUT performance displaying compliance with the specifications. As this product utilizes permanently attached antenna and offers no provision for antenna port measurements. Test procedures as defined in publications KDB 558074 and ANSI C63.10-2009 were utilized for compliance testing. These procedures utilize measurement of maximum field strength and conversion calculation for comparison with requirements.

1. Calculate the transmitter's peak power using the following equation:

$$P = (E * d)^2 / (30 * G)$$

Where: E = the measured maximum field strength in V/m.

G = the numeric gain of the transmitting antenna over an isotropic radiator.

d = the distance in meters from which the field strength was measured.

P = the power in watts

Setting the RBW > 6dB bandwidth of the emission or using a peak power meter

2. Emission Bandwidth was measured in compliance with KDB 558074 paragraph 5.1.1.
3. Maximum Peak Output Power was measured in compliance with KDB 558074 paragraph 5.2.1.2.
4. Maximum Power Spectral Density was measured in compliance with KDB 558074 paragraph 5.3.1.
5. Maximum Unwanted Emissions Levels were measured in compliance with KDB 558074 and CFR47 paragraph 15C at 3-meters distance located on the OATS.

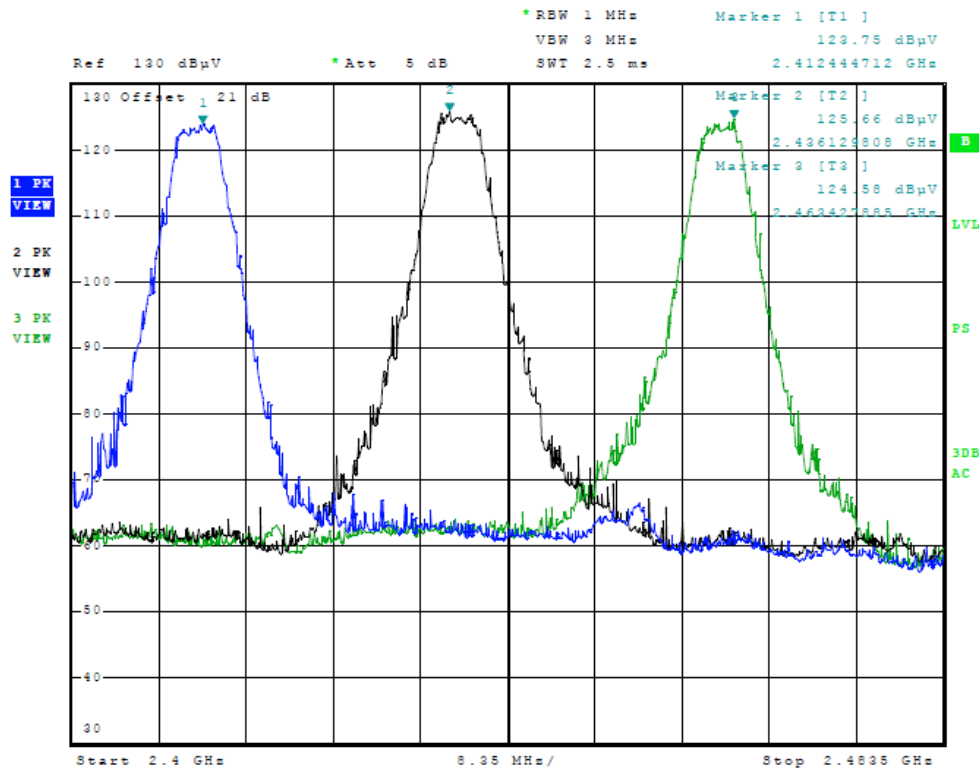

Figure Three Plot of Transmitter Emissions (Across Operational Band, 5 MHz Mode)

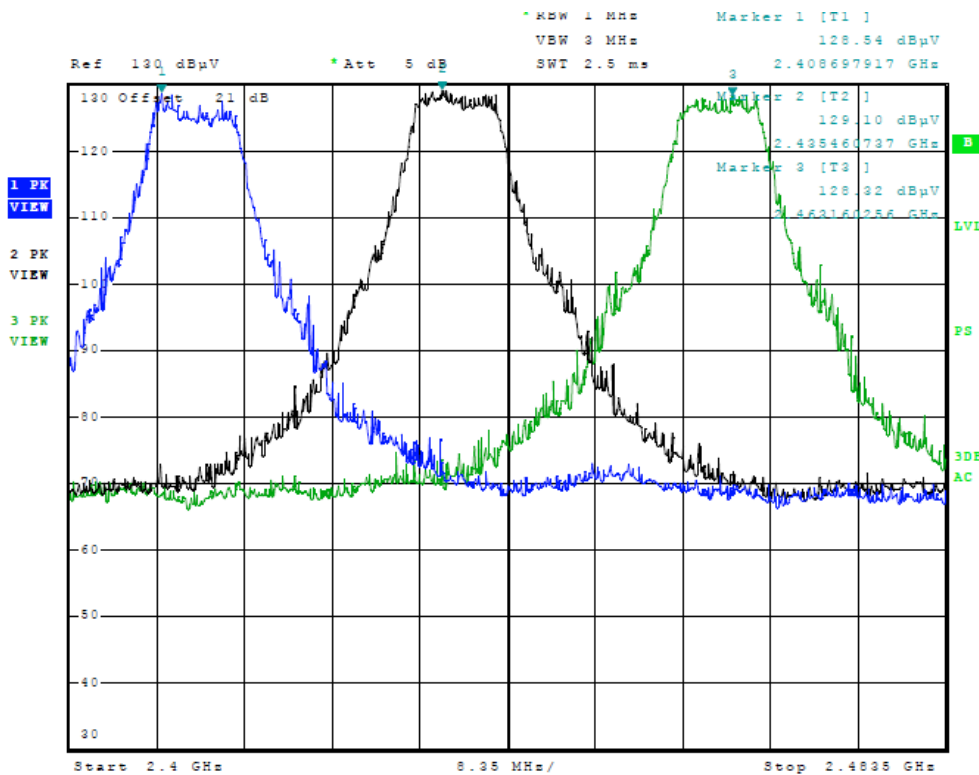

Figure Four Plot of Transmitter Emissions (Across Operational Band, 10 MHz Mode)

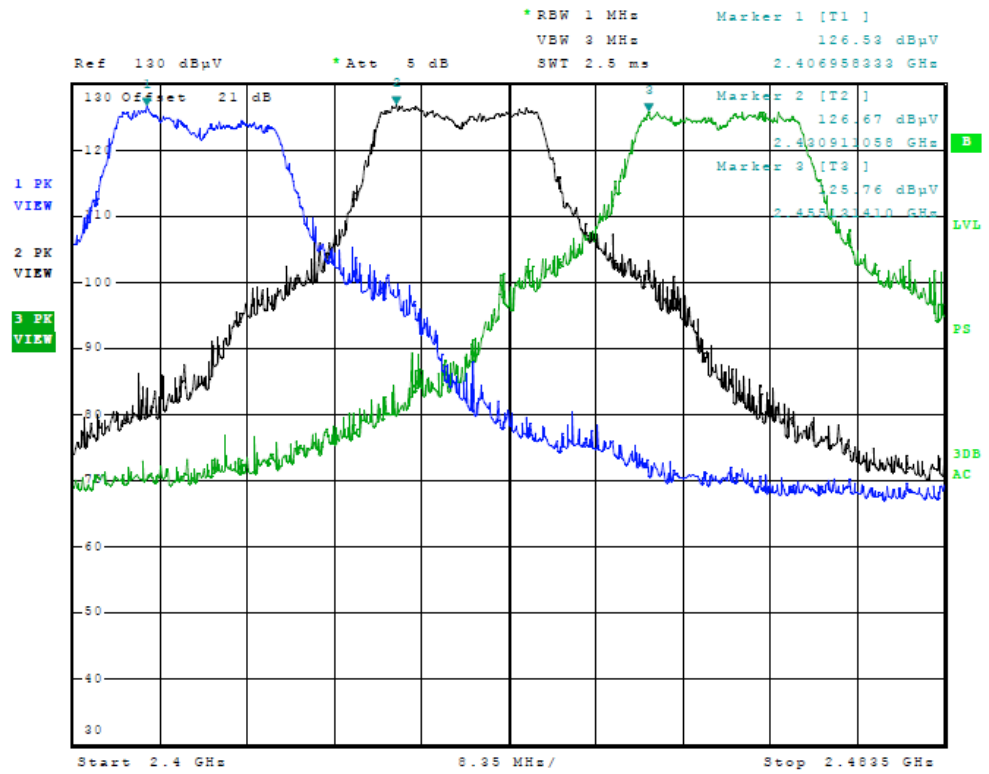

Figure Five Plot of Transmitter Emissions (Across Operational Band, 20 MHz Mode)

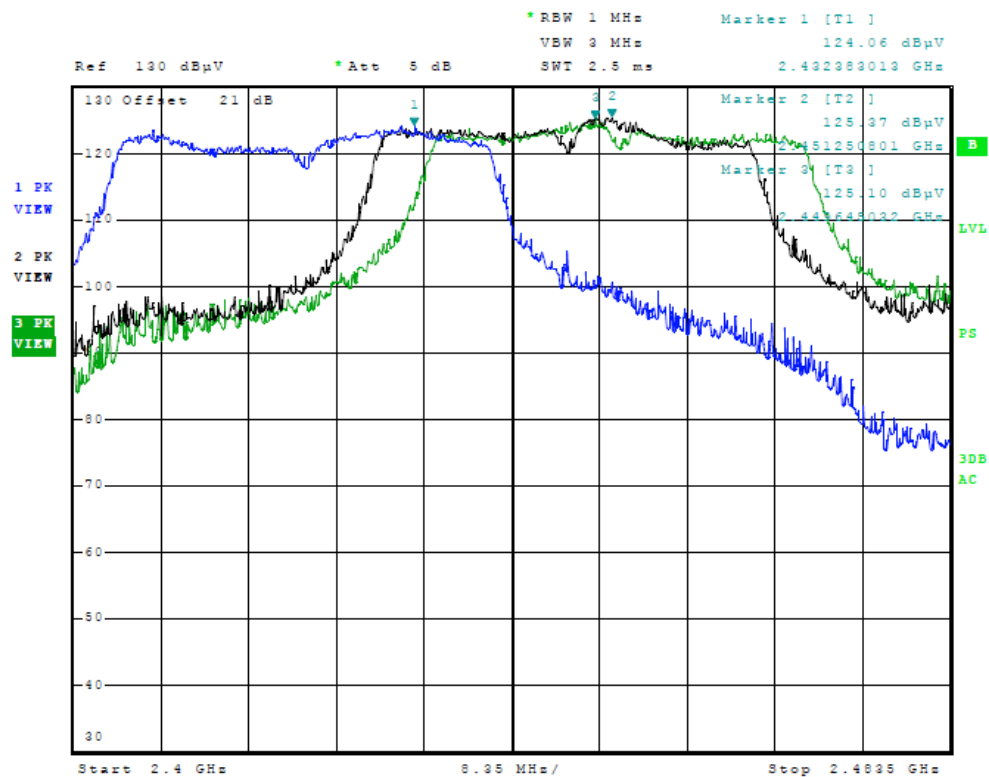

Figure Six Plot of Transmitter Emissions (Across Operational Band, 40 MHz Mode)

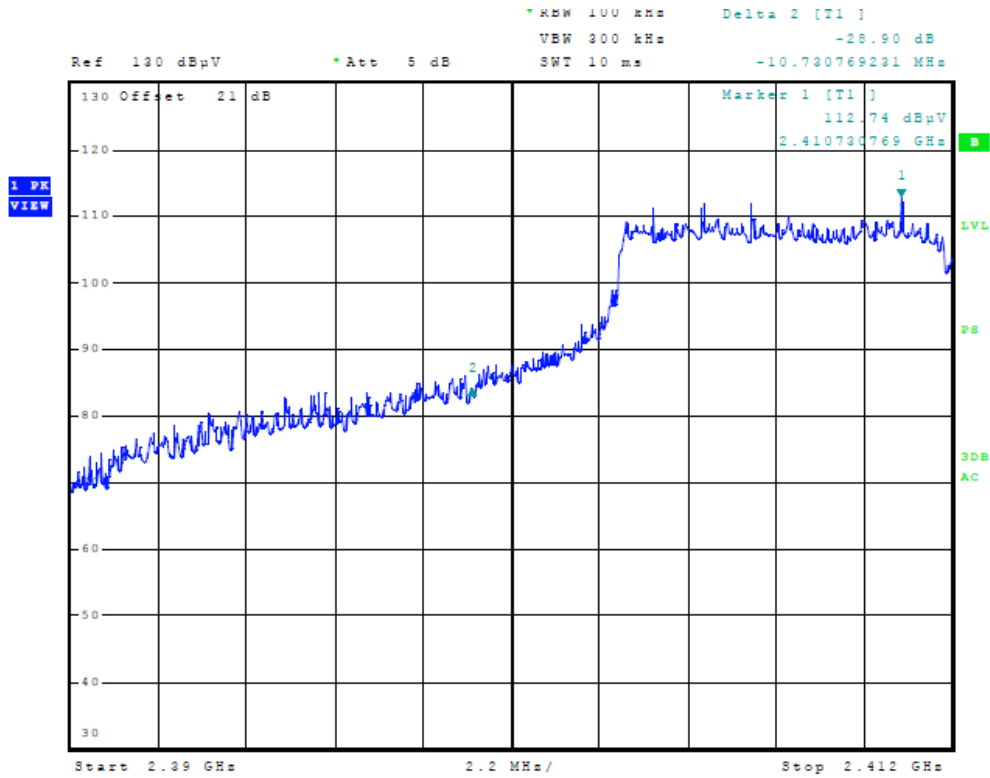

Figure Seven Plot of Low Band Edge

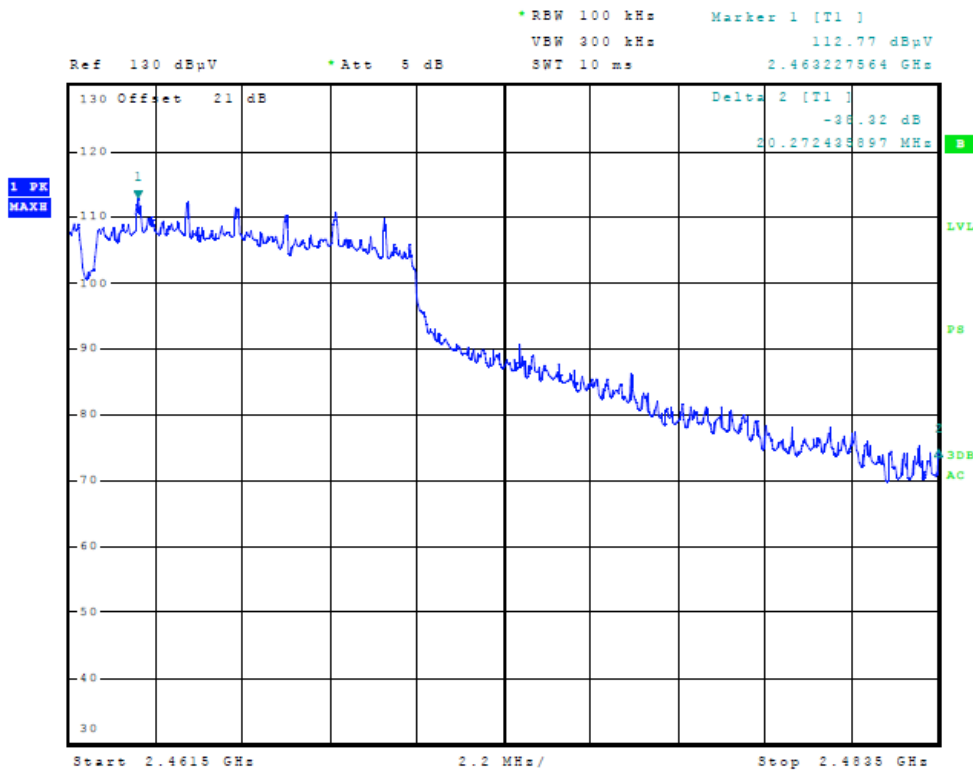

Figure Eight Plot of High Band Edge



Transmitter Emissions Data

Calculated Transmitter Antenna Port Power

Frequency MHz	Calculated Conducted Antenna Port Output Power (Watts)	Occupied Bandwidth (kHz)	Calculated Power Spectral Density (dBm)
20 MHz Channel			
2412	1.0	16,667	-1.9
2437	1.0	16,588	-2.8
2462	0.9	16,667	-2.9
40 MHz Channel			
2422	0.9	37,500	-3.5
2447	0.9	37,019	-3.7
2452	0.9	36,779	-4.3

Transmitter Radiated Emission

Frequency in MHz	Horizontal Peak (dBµV/m)	Horizontal Average (dBµV/m)	Vertical Peak (dBµV/m)	Vertical Average (dBµV/m)	Limit @ 3m (dBµV/m)
2412.0	128.2	116.4	127.0	115.0	--
4824.0	50.1	37.4	50.6	37.5	54.0
7236.0	59.8	37.5	61.6	38.0	54.0
9648.0	51.2	39.0	51.5	39.0	54.0
12060.0	50.2	37.4	50.3	37.4	54.0
14472.0	51.9	39.5	52.2	39.6	54.0
16884.0	51.2	38.7	51.3	38.7	54.0
2437.0	128.1	116.5	126.7	115.0	--
4874.0	49.7	37.1	50.0	37.2	54.0
7311.0	59.0	36.6	59.8	36.9	54.0
9748.0	50.9	38.0	50.4	37.9	54.0
12185.0	48.2	35.4	48.5	35.6	54.0
14622.0	51.3	38.7	51.4	38.8	54.0
17059.0	51.9	38.6	51.1	38.6	54.0
2462.0	128.0	114.7	126.0	115.1	--
4924.0	50.2	37.1	50.2	37.3	54.0
7386.0	58.4	35.7	59.3	36.0	54.0
9848.0	50.0	37.3	49.9	37.1	54.0
12310.0	49.6	35.8	48.3	35.4	54.0
14772.0	52.9	40.7	52.9	40.6	54.0
17234.0	53.2	40.2	53.3	40.2	54.0

Other emissions present had amplitudes at least 20 dB below the limit. Peak and Quasi-Peak amplitude emissions are recorded above for frequency range of 30-1000 MHz. Peak and Average amplitude emissions are recorded above for frequency range above 1000 MHz.



Summary of Results for Transmitter Radiated Emissions of Intentional Radiator

The EUT demonstrated compliance with the radiated emissions requirements of CFR47 Part 15.247. Calculated Antenna port conducted power of 30.0 dBm, 1.0 Watts. The peak power spectral density presented a minimum margin of -9.9 dB below the requirements. The EUT demonstrated a minimum margin of -13.3 dB below the harmonic emissions requirements. There were no other significantly measurable emissions in the restricted bands other than those recorded in this report. Other emissions were present with amplitudes at least 20 dB below the requirements. There were no other deviations or exceptions to the requirements.

Statement of Modifications and Deviations

No modifications to the EUT were required for the unit to demonstrate compliance with the CFR47 Part 15C emissions standards. There were no deviations to the specifications.



NVLAP Lab Code 200087-0

Annex

- Annex A Measurement Uncertainty Calculations
- Annex B Rogers Labs Test Equipment List
- Annex C Rogers Qualifications
- Annex D FCC Site Registration Letter
- Annex E Industry Canada Site Registration Letter

**Annex A Measurement Uncertainty Calculations**

Measurement uncertainty calculations were made for the laboratory. Result of measurement uncertainty calculations are recorded below for AC line conducted and radiated emission measurements.

Measurement Uncertainty	$U_{(E)}$	$U_{(lab)}$
3 Meter Horizontal 30-200 MHz Measurements	2.08	4.16
3 Meter Vertical 30-200 MHz Measurements	2.16	4.33
3 Meter Vertical Measurements 200-1000 MHz	2.99	5.97
10 Meter Horizontal Measurements 30-200 MHz	2.07	4.15
10 Meter Vertical Measurements 30-200 MHz	2.06	4.13
10 Meter Horizontal Measurements 200-1000 MHz	2.32	4.64
10 Meter Vertical Measurements 200-1000 MHz	2.33	4.66
3 Meter Measurements 1-6 GHz	2.57	5.14
3 Meter Measurements 6-18 GHz	2.58	5.16
AC Line Conducted	1.72	3.43



Annex B Rogers Labs Test Equipment List

The test equipment is maintained in calibration and good operating condition. Use of this calibrated equipment ensures measurements are traceable to national standards.

List of Test Equipment	Calibration Date
Spectrum Analyzer: Rohde & Schwarz ESU40	5/12
Spectrum Analyzer: HP 8562A, HP Adapters: 11518, 11519, and 11520 Mixers: 11517A, 11970A, 11970K, 11970U, 11970V, 11970W	5/12
Spectrum Analyzer: HP 8591EM	5/12
Antenna: EMCO Biconilog Model: 3143	5/12
Antenna: Sunol Biconilog Model: JB6	10/11
Antenna: EMCO Log Periodic Model: 3147	10/11
Antenna: Antenna Research Biconical Model: BCD 235	10/11
LISN: Compliance Design Model: FCC-LISN-2.Mod.cd, 50 µHy/50 ohm/0.1 µf	10/11
R.F. Preamp CPPA-102	10/11
Attenuator: HP Model: HP11509A	10/11
Attenuator: Mini Circuits Model: CAT-3	10/11
Attenuator: Mini Circuits Model: CAT-3	10/11
Cable: Belden RG-58 (L1)	10/11
Cable: Belden RG-58 (L2)	10/11
Cable: Belden 8268 (L3)	10/11
Cable: Time Microwave: 4M-750HF290-750	10/11
Cable: Time Microwave: 10M-750HF290-750	10/11
Frequency Counter: Leader LDC825	2/12
Oscilloscope Scope: Tektronix 2230	2/12
Wattmeter: Bird 43 with Load Bird 8085	2/12
Power Supplies: Sorensen SRL 20-25, SRL 40-25, DCR 150, DCR 140	2/12
R.F. Generators: HP 606A, HP 8614A, HP 8640B	2/12
R.F. Power Amp 65W Model: 470-A-1010	2/12
R.F. Power Amp 50W M185- 10-501	2/12
R.F. Power Amp A.R. Model: 10W 1010M7	2/12
R.F. Power Amp EIN Model: A301	2/12
LISN: Compliance Eng. Model 240/20	2/12
LISN: Fischer Custom Communications Model: FCC-LISN-50-16-2-08	2/12
Antenna: EMCO Dipole Set 3121C	2/12
Antenna: C.D. B-101	2/12
Antenna: Solar 9229-1 & 9230-1	2/12
Antenna: EMCO 6509	2/12
Audio Oscillator: H.P. 201CD	2/12
Peavey Power Amp Model: IPS 801	2/12
ELGAR Model: 1751	2/12
ELGAR Model: TG 704A-3D	2/12
ESD Test Set 2010i	2/12
Fast Transient Burst Generator Model: EFT/B-101	2/12
Field Intensity Meter: EFM-018	2/12
KEYTEK Ecat Surge Generator	2/12
Shielded Room 5 M x 3 M x 3.0 M	

Rogers Labs, Inc.

4405 W. 259th Terrace

Louisburg, KS 66053

Phone/Fax: (913) 837-3214

Revision 1

Mikrotikls SIA

Model: RBSXTG-2HnD

Test #: 120716

Test to: CFR47 (15.247)

File: Mikrotikls RBSXTG2HnD TstRpt 120716

SN: 399501DD0C31

FCC ID#: TV7SXTG-2HND

Date: July 31, 2012

Page 27 of 30



Annex C Rogers Qualifications

Scot D. Rogers, Engineer

Rogers Labs, Inc.

Mr. Rogers has approximately 17 years experience in the field of electronics. Engineering experience includes six years in the automated controls industry and remaining years working with the design, development and testing of radio communications and electronic equipment.

Positions Held

Systems Engineer: A/C Controls Mfg. Co., Inc. 6 Years

Electrical Engineer: Rogers Consulting Labs, Inc. 5 Years

Electrical Engineer: Rogers Labs, Inc. Current

Educational Background

- 1) Bachelor of Science Degree in Electrical Engineering from Kansas State University.
- 2) Bachelor of Science Degree in Business Administration Kansas State University.
- 3) Several Specialized Training courses and seminars pertaining to Microprocessors and Software programming.

Scot D. Rogers



NVLAP Lab Code 200087-0

Annex D FCC Site Registration Letter

FEDERAL COMMUNICATIONS COMMISSION

**Laboratory Division
7435 Oakland Mills Road
Columbia, MD 21046**

November 01, 2011

Registration Number: 90910

Rogers Labs, Inc.
4405 West 259th Terrace,
Louisburg, KS 66053

Attention: Scot Rogers,

Re: Measurement facility located at Louisburg
3 & 10 meter site
Date of Renewal: November 01, 2011

Dear Sir or Madam:

Your request for renewal of the registration of the subject measurement facility has been received. The information submitted has been placed in your file and the registration has been renewed. The name of your organization will remain on the list of facilities whose measurement data will be accepted in conjunction with applications for Certification under Parts 15 or 18 of the Commission's Rules. Please note that the file must be updated for any changes made to the facility and the registration must be renewed at least every three years.

Measurement facilities that have indicated that they are available to the public to perform measurement services on a fee basis may be found on the FCC website www.fcc.gov under E-Filing, OET Equipment Authorization Electronic Filing, Test Firms.

Sincerely,

Phyllis Parrish
Industry Analyst

Rogers Labs, Inc.
4405 W. 259th Terrace
Louisburg, KS 66053
Phone/Fax: (913) 837-3214
Revision 1

Mikrotikls SIA
Model: RBSXTG-2HnD
Test #: 120716
Test to: CFR47 (15.247)
File: Mikrotikls RBSXTG2HnD TstRpt 120716

SN: 399501DD0C31
FCC ID#: TV7SXTG-2HND
Date: July 31, 2012
Page 29 of 30



NVLAP Lab Code 200087-0

Annex E Industry Canada Site Registration Letter



December 28, 2011

OUR FILE: 46405-3041
Submission No: 152685

Rogers Labs Inc.
4405 West 259th Terrance
Louisburg, KS, 66053
USA

Attention: Mr. Scot D. Rogers

Dear Sir/Madame:

The Bureau has received your application for the renewal of 3/10m OATS. Be advised that the information received was satisfactory to Industry Canada. The following number(s) is now associated to the site(s) for which registration / renewal was sought (**Site# 3041A-1**). Please reference the appropriate site number in the body of test reports containing measurements performed on the site. In addition, please keep for your records the following information;

- The company address code associated to the site(s) located at the above address is: **3041A**

Furthermore, to obtain or renew a unique site number, the applicant shall demonstrate that the site has been accredited to ANSI C63.4-2003 or later. A scope of accreditation indicating the accreditation by a recognized accreditation body to ANSI C63.4-2003 or later shall be accepted. Please indicate in a letter the previous assigned site number if applicable and the type of site (example: 3 metre OATS or 3 metre chamber). If the test facility is not accredited to ANSI C63.4-2003 or later, the test facility shall submit test data demonstrating full compliance with the ANSI standard. The Bureau will evaluate the filing to determine if recognition shall be granted.

The frequency for re-validation of the test site and the information that is required to be filed or retained by the testing party shall comply with the requirements established by the accrediting organization. However, in all cases, test site re-validation shall occur on an interval not to **exceed three years**. There is no fee or form associated with an OATS filing. OATS submissions are encouraged to be submitted electronically to the Bureau using the following URL;
http://strategis.ic.gc.ca/epic/internet/inceb-bhst.nsf/en/h_tt00052e.html.

If you have any questions, you may contact the Bureau by e-mail at certification.bureau@ic.gc.ca Please reference our file and submission number above for all correspondence.

Yours sincerely,

Dalwinder Gill
For: Wireless Laboratory Manager
Certification and Engineering Bureau
3701 Carling Ave., Building 94
P.O. Box 11490, Station "H"
Ottawa, Ontario K2H 8S2
Email: dalwinder.gill@ic.gc.ca
Tel. No. (613) 998-8363
Fax. No. (613) 990-4752

Rogers Labs, Inc.
4405 W. 259th Terrace
Louisburg, KS 66053
Phone/Fax: (913) 837-3214
Revision 1

Mikrotikls SIA
Model: RBSXTG-2HnD
Test #: 120716
Test to: CFR47 (15.247)
File: Mikrotikls RBSXTG2HnD TstRpt 120716

SN: 399501DD0C31
FCC ID#: TV7SXTG-2HND
Date: July 31, 2012
Page 30 of 30