

**SUBMITTAL
APPLICATION
REPORT**

**FOR
GRANT OF CERTIFICATION**

FOR

**Model: SXT-5D
5740-5830MHz
Broadband Digital Transmission System**

FOR

MIKROTIKLS SIA
Pernavas 46
Riga, Latvia LV-1009

Test Report Number: 101119

Authorized Signatory: *Scot D Rogers*
Scot D. Rogers

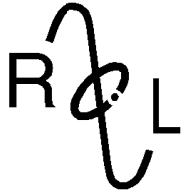

ROGERS LABS, INC.

4405 West 259th Terrace
 Louisburg, KS 66053
 Phone / Fax (913) 837-3214

**Engineering Test Report
 For Application of
 Grant of Certification**

FOR
 CFR 47, PART 15C - Intentional Radiators
 CFR 47 Paragraph 15.247
 License Exempt Intentional Radiator

For

MIKROTIKLS SIA

Pernavas 46
 Riga, Latvia LV-1009

Broadband Digital Transmission System
 Model: SXT-5D
 Frequency Range 5740-5830 MHz
 FCC ID#: TV7SXT-5D

Test Date: November 19, 2010

Certifying Engineer: *Scot D. Rogers*
 Scot D. Rogers
 Rogers Labs, Inc.
 4405 West 259th Terrace
 Louisburg, KS 66053
 Telephone/Facsimile: (913) 837-3214

This report shall not be reproduced except in full, without the written approval of the laboratory. This report must not be used by the client to claim product endorsement by NVLAP, NIST, or any agency of the U.S. Government.



Table Of Contents

TABLE OF CONTENTS..... 3

FORWARD 6

OPINION / INTERPRETATION OF RESULTS 6

ENVIRONMENTAL CONDITIONS..... 6

EQUIPMENT TESTED..... 6

2.1033(B) APPLICATION FOR CERTIFICATION..... 7

APPLICABLE STANDARDS & TEST PROCEDURES 8

EQUIPMENT FUNCTION AND CONFIGURATION..... 8

Equipment Configuration.....9

TEST SITE LOCATIONS 9

UNITS OF MEASUREMENTS 9

EQUIPMENT CABLE CONFIGURATION AND TEST PROCEDURES 10

AC Line Conducted Emission Test Procedure10

Radiated Emission Test Procedure.....10

LIST OF TEST EQUIPMENT 11

SUBPART C - INTENTIONAL RADIATORS 12

15.203 Antenna Requirements12

15.205 Restricted Bands of Operation.....12

 Radiated Emissions in Restricted Bands Data (worst-case) 15.205 13

Summary of Results for Radiated Emissions in Restricted Bands 15.20513

Statement of Modifications and Deviations13

15.207 AC Line Conducted Emissions Procedure14

 Figure One AC Line Conducted Emissions Line 1..... 15



Figure Two AC Line Conducted Emissions Line 2 15

AC Line Conducted Emissions Data (7 Highest Emissions) 15.207 16

Summary of Results for AC Line Conducted Emissions 15.207 16

15.209 Radiated Emissions Procedure..... 17

Figure Three General Radiated Emissions taken at 1 meter in screen room 18

Figure Four General Radiated Emissions taken at 1 meter in screen room 18

Figure Five General Radiated Emissions taken at 1 meter in screen room..... 19

Figure Six General Radiated Emissions taken at 1 meter in screen room 19

Figure Seven General Radiated Emissions taken at 1 meter in screen room 20

Figure Eight General Radiated Emissions taken at 1 meter in screen room 20

Figure Nine General Radiated Emissions taken at 1 meter in screen room 21

Figure Ten General Radiated Emissions taken at 1 meter in screen room 21

Figure Eleven General Radiated Emissions taken at 1 meter in screen room 22

Radiated Emissions from EUT Data (Highest Emissions) 15.209 23

Summary of Results for General Radiated Emissions 15.209 23

Statement of Modifications and Deviations 23

15.247 Operation in the Band 5725 – 5850 MHz 24

Figure Twelve Plot of Radiated Emissions (Transmitter Operation in band, 5GHz Mode) 24

Figure Thirteen Plot of Radiated Emissions (Transmitter Operation in band, a/n Mode) 25

Figure Fourteen Plot of Radiated Emissions (Transmitter Operation in band, N Mode) 25

Figure Fifteen Plot of Radiated Emissions (Transmitter Operation in band, 5-MHz Mode) 26

Figure Sixteen Plot of Radiated Emissions (Transmitter Operation in band, 10-MHz Mode) 26

Figure Seventeen Plot of 6dB Band width (5GHz Mode, 5745 MHz) 27

Figure Eighteen Plot of 6dB Band width (5GHz Mode, 5785 MHz) 27

Figure Nineteen Plot of 6dB Band width (5GHz Mode, 5825 MHz) 28

Figure Twenty Plot of 6dB Band width (a/n Mode, 5745 MHz) 28

Figure Twenty-one Plot of 6dB Band width (a/n Mode, 5785 MHz) 29

Figure Twenty-two Plot of 6dB Band width (a/n Mode, 5825 MHz) 29

Figure Twenty-three Plot of 6dB Band width (n Mode, 5745 MHz) 30

Figure Twenty-four Plot of 6dB Band width (n Mode, 5785 MHz) 30

Figure Twenty-five Plot of 6dB Band width (n Mode, 5825 MHz) 31

Figure Twenty-six Plot of 6dB Band width (5 MHz Mode, 5740 MHz) 31

Figure Twenty-seven Plot of 6dB Band width (5 MHz Mode, 5785 MHz) 32

Figure Twenty-eight Plot of 6dB Band width (5 MHz Mode, 5830 MHz) 32



Figure Twenty-nine Plot of 6dB Band width (10 MHz Mode, 5740 MHz).....33

Figure Thirty Plot of 6dB Band width (10 MHz Mode, 5785 MHz).....33

Figure Thirty-one Plot of 6dB Band width (10 MHz Mode, 5830 MHz)34

Figure Thirty-two Plot of Power Spectral Density (5GHz Mode, 5745 MHz)34

Figure Thirty-three Plot of Power Spectral Density (5GHz Mode, 5785 MHz)35

Figure Thirty-four Plot of Power Spectral Density (5GHz Mode, 5825 MHz)35

Figure Thirty-five Plot of Power Spectral Density (a/n Mode, 5745 MHz).....36

Figure Thirty-six Plot of Power Spectral Density (a/n Mode, 5785 MHz)36

Figure Thirty-seven Plot of Power Spectral Density (a/n Mode, 5825 MHz).....37

Figure Thirty-eight Plot of Power Spectral Density (n Mode, 5745 MHz).....37

Figure Thirty-nine Plot of Power Spectral Density (n Mode, 5785 MHz).....38

Figure Forty Plot of Power Spectral Density (n Mode, 5825 MHz).....38

Figure Forty-one Plot of Power Spectral Density (5 MHz Mode, 5740 MHz).....39

Figure Forty-two Plot of Power Spectral Density (5 MHz Mode, 5785 MHz)39

Figure Forty-three Plot of Power Spectral Density (5 MHz Mode, 5830 MHz).....40

Figure Forty-four Plot of Power Spectral Density (10 MHz Mode, 5740 MHz).....40

Figure Forty-five Plot of Power Spectral Density (10 MHz Mode, 5785 MHz)41

Figure Forty-six Plot of Power Spectral Density (10 MHz Mode, 5830 MHz).....41

Transmitter Radiated Emissions Data42

 Transmitter Radiated Emission (Worst-Case)42

 Summary of Results for Radiated Emissions of Intentional Radiator 15.24743

Statement of Modifications and Deviations43

ANNEX..... 44

Annex A Measurement Uncertainty Calculations.....45

Annex B Rogers Labs Test Equipment List.....47

Annex C Rogers Qualifications48

Annex D FCC Site Registration Letter.....49

Annex E Industry Canada Site Registration Letter50



Forward

The following information is submitted for consideration in obtaining Grant of Certification for License Exempt Digital Transmission System Intentional Radiator operating under CFR 47 Paragraph 15.247.

Name of Applicant:
MIKROTIKLS SIA
Pernavas 46
Riga, Latvia LV-1009

Model: SXT-5D

FCC I.D.: TV7SXT-5D FRN: 0014 43 1100
Frequency Range: 5740-5830 MHz
Operating Power: 126.8 dBµV/m at 3-meters radiated emissions taken on OATS

Opinion / Interpretation of Results

Tests Performed	Margin (dB)	Results
Emissions as per CFR 47 paragraphs 2 and 15.205	-4.9	Complies
Emissions as per CFR 47 paragraphs 2 and 15.207	-14.2	Complies
Emissions as per CFR 47 paragraphs 2 and 15.209	-2.3	Complies
Emissions as per CFR 47 paragraphs 2 and 15.247	-10.8	Complies

Environmental Conditions

Ambient Temperature 22.4° C
Relative Humidity 26%
Atmospheric Pressure 1028.1 mb

Equipment Tested

<u>Equipment</u>	<u>Model</u>	<u>FCC I.D.</u>
EUT	SXT-5D	TV7SXT-5D
CPU	Dell Studio XPS	921LBN1

2.1033(b) Application for Certification

- (1) Manufacturer: MIKROTIKLS SIA
Pernavas 46
Riga, Latvia LV-1009
- (2) Identification: Model: SXT-5D

FCC I.D.: TV7SXT-5D
- (3) Instruction Book:

Refer to Exhibit for Instruction Manual.
- (4) Description of Circuit Functions:

Refer to Exhibit of Operational Description.
- (5) Block Diagram with Frequencies:

Refer to Exhibit of Operational Description.
- (6) Report of Measurements:

Report of measurements follows in this Report.
- (7) Photographs: Construction, Component Placement, etc.:

Refer to Exhibit for photographs of equipment.
- (8) List of Peripheral Equipment Necessary for operation. The equipment operates from power received from the authorized AC power adapter and POE (Power Over Ethernet) and was interfaced through network cable to laptop computer during testing.
- (9) Transition Provisions of 15.37 are not being requested.
- (10) Not Applicable. The unit is not a scanning receiver.
- (11) Not Applicable. The EUT does not operate in the 59 – 64 GHz frequency band.
- (12) The equipment is not software defined and this section is not applicable.

Applicable Standards & Test Procedures

In accordance with the Federal Communications Code of Federal Regulations, dated October 1, 2009, Part 2, Subpart J, Paragraphs 2.907, 2.911, 2.913, 2.925, 2.926, 2.1031 through 2.1057, and applicable parts of paragraph 15, Part 15C Paragraph 15.247 the following information is submitted.

Test procedures used are the established Methods of Measurement of Radio-Noise Emissions as described in the ANSI C63.4-2009 Document FCC, documents DA00-1407 and DA00-705 and/or TIA/EIA 603-1. Testing for the AC line-conducted emissions were performed as defined in sections 7 and 13.1.3, testing of the radiated emissions was performed as defined in sections 8 and 13.1.4 of ANSI C63.4-2009. Testing of the intentional radiated emissions was performed as defined in section 13 of ANSI C63.4-2009.

Equipment Function and Configuration

The EUT is a 5740-5830 MHz Digital Transmission System transmitter used to transmit data in applications offering broadband wireless connectivity. The equipment is marketed for use to incorporate a wireless link to exchange data information from one point to another. For testing purposes the SXT-5D transceiver was connected to the manufacturer supplied POE/AC power adapter and communicating to the laptop computer allowing for operational control of the transmitter and communications over the network interface between the EUT and supporting computer system. The SXT-5D receives power from the supplied POE/AC power adapter connected to utility power systems. The EUT offers connection ports for network only and requires power supplied from POE, no other interfacing options are provided on the design. For testing purposes the SXT-5D and support equipment were powered from the POE/AC power adapter and set to transmit in available data modes. The device is marketed for professionally installed use and complies with the unique antenna connection requirements.

Equipment Configuration

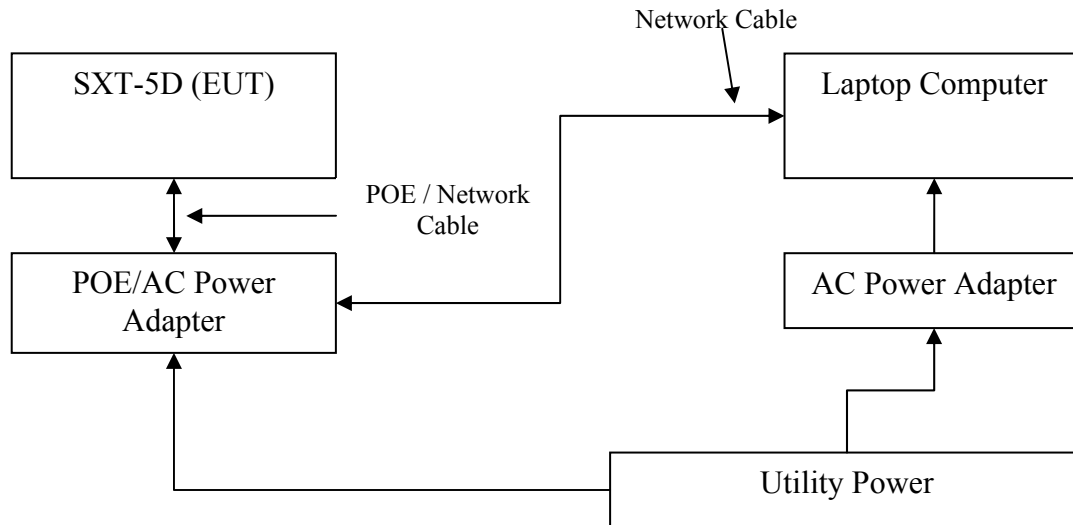

Test Site Locations

Conducted EMI The AC power line conducted emissions testing performed in a shielded screen room located at Rogers Labs, Inc., 4405 W. 259th Terrace, Louisburg, KS

Radiated EMI The radiated emissions tests were performed at the 3 meters, Open Area Test Site (OATS) located at Rogers Labs, Inc., 4405 W. 259th Terrace, Louisburg, KS

Site Registration Refer to Annex for Site Registration Letters

NVLAP Accreditation Lab code 200087-0

Units of Measurements

Conducted EMI Data is in dB μ V; dB referenced to one microvolt

Radiated EMI Data is in dB μ V/m; dB/m referenced to one microvolt per meter

Sample Calculation:

RFS = Radiated Field Strength, FSM = Field Strength Measured

A.F. = Receive antenna factor, Gain = amplification gains and/or cable losses

$RFS (dB\mu V/m @ 3m) = FSM (dB\mu V) + A.F. (dB) - Gain (dB)$

Equipment Cable Configuration and Test Procedures

AC Line Conducted Emission Test Procedure

The EUT operates from DC power only and must be connected to an approved POE/AC adapter for operation. For testing purposes, the manufacturer supplied POE/AC power adapter was used to power the EUT and system. Testing for the AC line-conducted emissions testing was performed as defined in sections 7 and 13.1.3 of ANSI C63.4-2009. The test setup including the EUT was arranged in typical equipment configurations and placed on a 1 x 1.5-meter wooden bench, 0.8 meters high located in a screen room. The power lines of the system were isolated from the power source using a standard LISN with a 50 μ Hy choke. EMI was coupled to the spectrum analyzer through a 0.1 μ F capacitor internal to the LISN. The LISN was positioned on the floor beneath the wooden bench supporting the EUT. The power lines and cables were draped over the back edge of the table.

Radiated Emission Test Procedure

The EUT was placed on a rotating 1 x 1.5-meter wooden platform, 0.8 meters above the ground plane at a distance of 3 meters from the FSM antenna. Testing for the radiated emissions was performed as defined in sections 8 and 13.1.4 of ANSI C63.4-2009. EMI energy was maximized by equipment placement, raising and lowering the FSM antenna, changing the antenna polarization, and by rotating the turntable. Each emission was maximized before data was taken using a spectrum analyzer. Refer to photographs in the test setup exhibits for EUT placement during testing.

List of Test Equipment

A Rohde and Schwarz ESU40 and/or Hewlett Packard 8591EM was used as the measuring device for the emissions testing of frequencies below 1 GHz. A Rohde and Schwarz ESU40 and/or Hewlett Packard 8562A Spectrum Analyzer was used as the measuring device for testing the emissions at frequencies above 1 GHz. The analyzer settings used are described in the following table. Refer to the appendix for a complete list of test equipment.

HP 8591 EM Analyzer Settings		
Conducted Emissions		
RBW	AVG. BW	Detector Function
9 kHz	30 kHz	Peak / Quasi Peak
Radiated Emissions		
RBW	AVG. BW	Detector Function
120 kHz	300 kHz	Peak / Quasi Peak
HP 8562A Analyzer Settings		
RBW	Video BW	Detector Function
100 kHz	100 kHz	Peak
1 MHz	1 MHz	Peak / Average

<u>Equipment</u>	<u>Manufacturer</u>	<u>Model</u>	<u>Calibration Date</u>	<u>Due</u>
LISN	Comp. Design	FCC-LISN-2-MOD.CD	10/10	10/11
Antenna	ARA	BCD-235-B	10/10	10/11
Antenna	EMCO	3147	10/10	10/11
Antenna	EMCO	3143	5/10	5/11
Analyzer	HP	8591EM	5/10	5/11
Analyzer	HP	8562A	5/10	5/11
Analyzer	Rohde & Schwarz	ESU40	5/10	5/11

Subpart C - Intentional Radiators

As per CFR47, Subpart C, paragraph 15.247 the following information is submitted.

15.203 Antenna Requirements

The EUT is produced with integrated antenna system and offers no provision for alternate antenna systems. The design is marketed for professional installation and use as described in accompanying documentation. The antenna connection point complies with the unique antenna connection requirements. The requirements of 15.203 are fulfilled and there are no deviations or exceptions to the specification.

15.205 Restricted Bands of Operation

Spurious emissions falling in the restricted frequency bands of operation were measured at a distance of three meters at the OATS. The EUT utilizes frequency, determining circuitry, which generates harmonics falling in the restricted bands. Emissions were measured at the OATS, using appropriate antennas or pyramidal horns, amplification stages, and a spectrum analyzer. No other significant emission was observed which fell into the restricted bands of operation.

Radiated Emissions in Restricted Bands Data (worst-case) 15.205

Frequency in MHz	FSM Horz. (dBµV)	FSM Vert. (dBµV)	A.F. (dB/m)	Amp. Gain (dB)	RFS Horz. @ 3m (dBµV/m)	RFS Vert. @ 3m (dBµV/m)	FCC Class B Limit @ 3m (dBµV/m)
General Emissions							
74.6	49.2	57.1	8.0	30	27.2	35.1	40.0
137.0	36.5	49.1	13.5	30	20.0	32.6	43.5
137.2	39.7	49.7	13.5	30	23.2	33.2	43.5
173.2	34.5	47.3	11.9	30	16.4	29.2	43.5
250.0	43.8	46.7	12.1	30	25.9	28.8	46.0
276.6	38.7	41.5	13.7	30	22.4	25.2	46.0
280.6	38.3	46.6	13.7	30	22.0	30.3	46.0
1599.5	12.8	13.8	27.2	25	15.0	16.0	54.0
Harmonics Emissions							
11490.0	20.2	20.2	39.9	25.0	35.1	35.1	54.0
11570.0	21.5	21.4	39.9	25.0	36.4	36.3	54.0
11650.0	22.3	21.9	39.9	25.0	16.6	36.8	54.0
22980.0	9.0	9.3	37.2	25.0	21.2	21.5	54.0

Other emissions present had amplitudes at least 20 dB below the limit.

Summary of Results for Radiated Emissions in Restricted Bands 15.205

The EUT demonstrated compliance with the radiated emissions requirements of CFR 47 Part 15C Intentional Radiators. The EUT demonstrated a minimum margin of 4.9 dB below the requirements. Peak, Quasi-peak, and average amplitudes were checked for compliance with the regulations. Worst-case emissions are reported with other emissions found in the restricted frequency bands at least 20 dB below the requirements.

Statement of Modifications and Deviations

No modifications to the EUT were required for the unit to demonstrate compliance with the CFR47 Part 15C paragraph 15.205 emissions requirements. There were no deviations or exceptions to the specifications.

15.207 AC Line Conducted Emissions Procedure

The EUT was arranged in a typical equipment configuration and placed on a 1 x 1.5-meter wooden bench 80 cm above the conducting ground plane, floor of a screen room. The bench was positioned 40 cm away from the wall of the screen room. The LISN was positioned on the floor of the screen room 80-cm from the rear of the EUT. The manufacturer supplied POE/AC power adapter for the EUT was connected to the LISN. A second LISN was positioned on the floor of the screen room 80-cm from the rear of the supporting equipment of the EUT. All power cords except the EUT were then powered from the second LISN. EMI was coupled to the spectrum analyzer through a 0.1 μ F capacitor, internal to the LISN. Power line conducted emissions testing were carried out individually for each current carrying conductor of the EUT. The excess length of lead between the system and the LISN receptacle was folded back and forth to form a bundle not exceeding 40 cm in length. The screen room, conducting ground plane, analyzer, and LISN were bonded together to the protective earth ground. Preliminary testing was performed to identify the frequency of each radio frequency emission displaying the highest amplitude. The cables were repositioned to obtain maximum amplitude of measured EMI level. Once the worst-case configuration was identified, plots were made of the EMI from 0.15 MHz to 30 MHz then the data was recorded with maximum conducted emissions levels. Refer to figures one and two for plots of the EUT POE/AC Power Line conducted emissions.

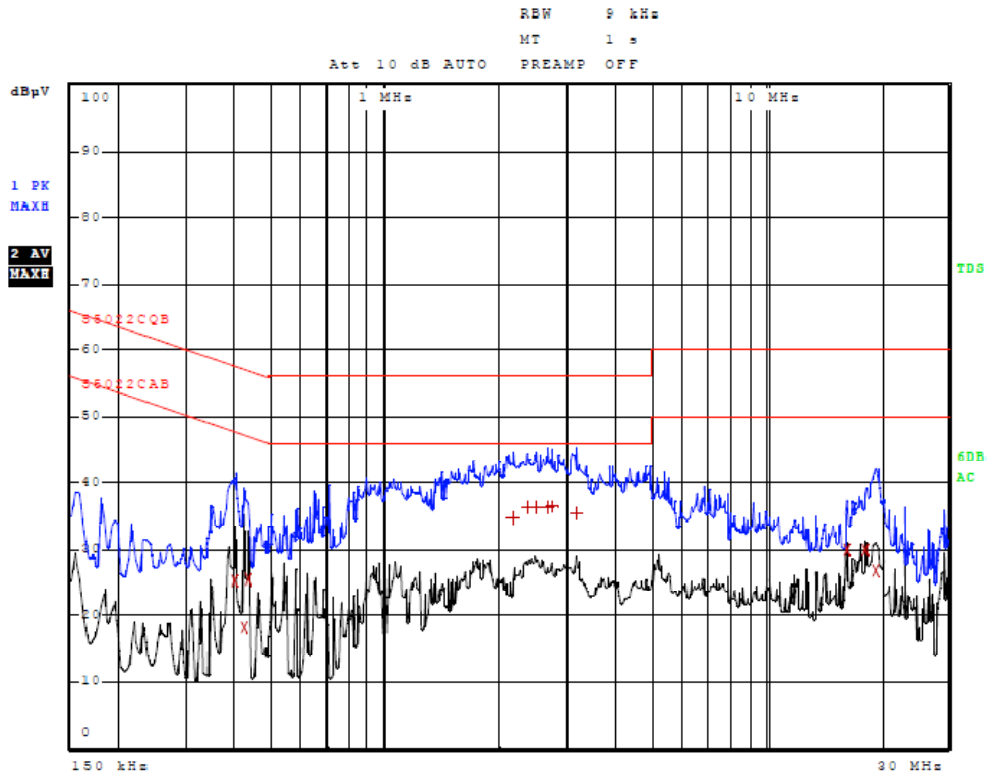

Figure One AC Line Conducted Emissions Line 1

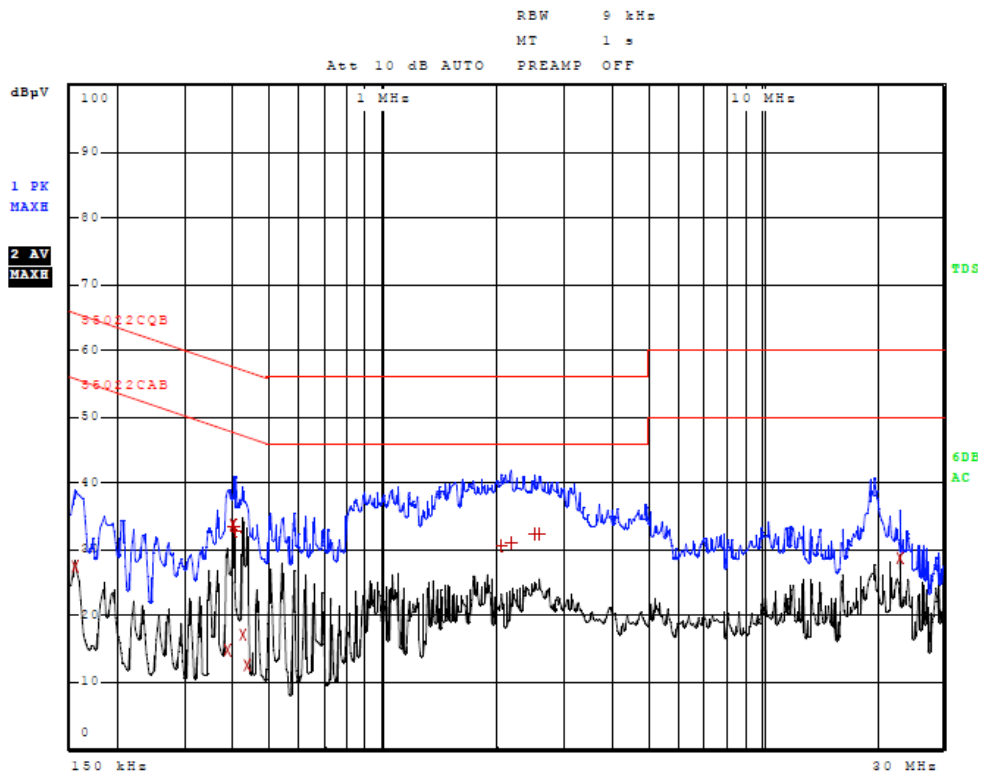

Figure Two AC Line Conducted Emissions Line 2

AC Line Conducted Emissions Data (7 Highest Emissions) 15.207

Line 1

Trace	Frequency	Level (dBµV)	Detector	Delta Limit/dB
2	398.000000000 kHz	25.31	Average	-22.58
2	422.000000000 kHz	18.14	Average	-29.27
2	434.000000000 kHz	25.43	Average	-21.74
1	2.162000000 MHz	34.70	Quasi Peak	-21.30
1	2.338000000 MHz	36.15	Quasi Peak	-19.85
1	2.494000000 MHz	36.25	Quasi Peak	-19.75
1	2.662000000 MHz	36.17	Quasi Peak	-19.83
1	2.726000000 MHz	36.43	Quasi Peak	-19.57
1	3.158000000 MHz	35.38	Quasi Peak	-20.62
2	16.228000000 MHz	29.92	Average	-20.08
2	18.244000000 MHz	29.84	Average	-20.16
2	19.224000000 MHz	26.88	Average	-23.12

Line 2

Trace	Frequency	Level (dBµV)	Detector	Delta Limit/dB
2	154.000000000 kHz	27.40	Average	-28.38
2	386.000000000 kHz	14.91	Average	-33.24
1	398.000000000 kHz	33.42	Quasi Peak	-24.47
2	398.000000000 kHz	33.70	Average	-14.20
1	406.000000000 kHz	32.66	Quasi Peak	-25.07
2	422.000000000 kHz	17.18	Average	-30.23
2	434.000000000 kHz	12.55	Average	-34.62
1	2.038000000 MHz	30.62	Quasi Peak	-25.38
1	2.174000000 MHz	30.95	Quasi Peak	-25.05
1	2.502000000 MHz	32.18	Quasi Peak	-23.82
1	2.566000000 MHz	32.18	Quasi Peak	-23.82
2	23.128000000 MHz	28.59	Average	-21.41

Other emissions present had amplitudes at least 20 dB below the limit.

Summary of Results for AC Line Conducted Emissions 15.207

The EUT demonstrated compliance with the conducted emissions requirements of CFR47 Part 15C equipment. The EUT demonstrated minimum margin of 14.2 dB below the limit.

Measurements were taken using the peak, quasi peak, and average, measurement function for each emissions amplitude and were below the limits stated in the specification. Other emissions were present with recorded data representing worst-case amplitudes.

15.209 Radiated Emissions Procedure

The EUT was arranged in a typical equipment configuration and operated through all available modes with worst-case data recorded. Preliminary testing was performed in a screen room with the EUT positioned 1 meter from the FSM. Radiated emissions measurements were performed to identify the frequencies, which produced the highest emissions. Plots were made of the radiated frequency spectrum from 30 MHz to 40,000 MHz for the preliminary testing. Refer to figures three through eleven for plots of the general radiated emissions spectrum taken in a screen room. Each radiated emission was then maximized at the OATS location before final radiated emissions measurements were performed. Final data was taken with the EUT located at the OATS at a distance of 3 meters between the EUT and the receiving antenna. The frequency spectrum from 30 MHz to 60,000 MHz was searched for general radiated emissions. Measured emission levels were maximized by EUT placement on the table, rotating the turntable through 360 degrees, varying the antenna height between 1 and 4 meters above the ground plane and changing antenna position between horizontal and vertical polarization. Antennas used were Broadband Biconical from 30 to 200 MHz, Biconilog from 30 to 6000 MHz, Log Periodic from 200 MHz to 5 GHz and or double Ridge or pyramidal horns and mixers from 4 GHz to 60 GHz, notch filters and appropriate amplifiers and external mixers were utilized.

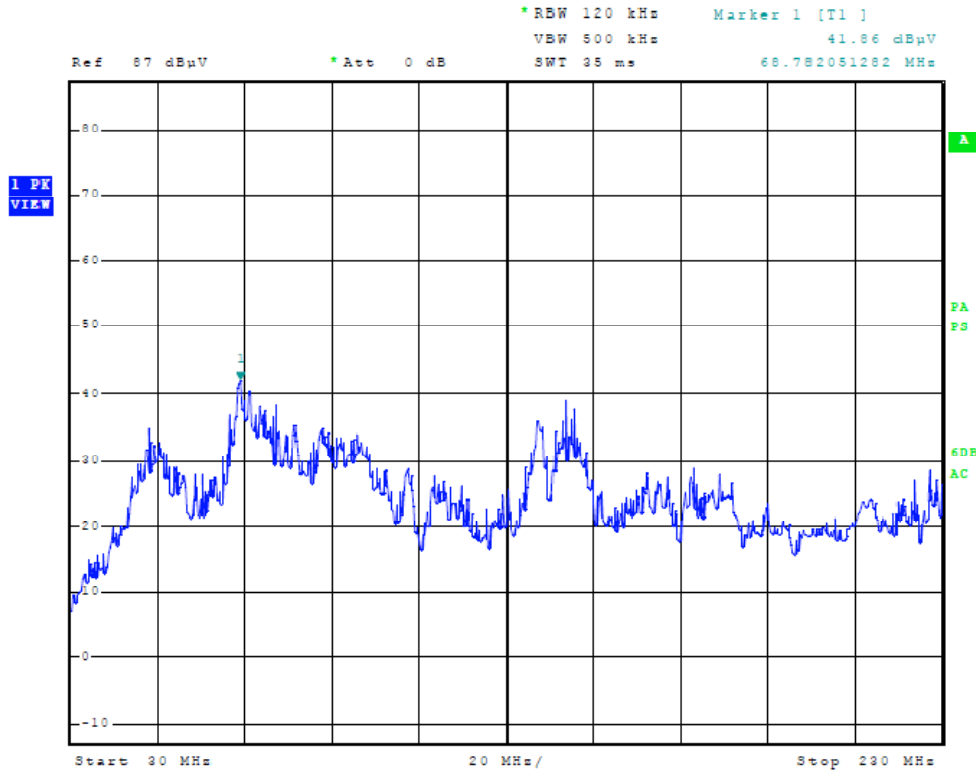

Figure Three General Radiated Emissions taken at 1 meter in screen room

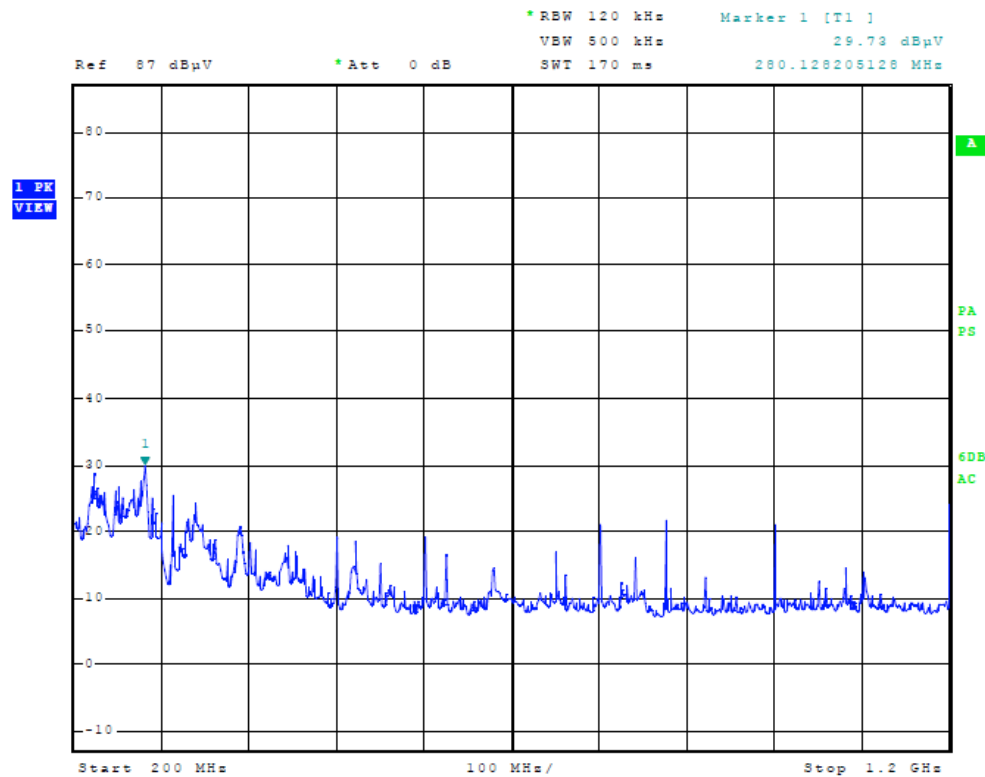

Figure Four General Radiated Emissions taken at 1 meter in screen room

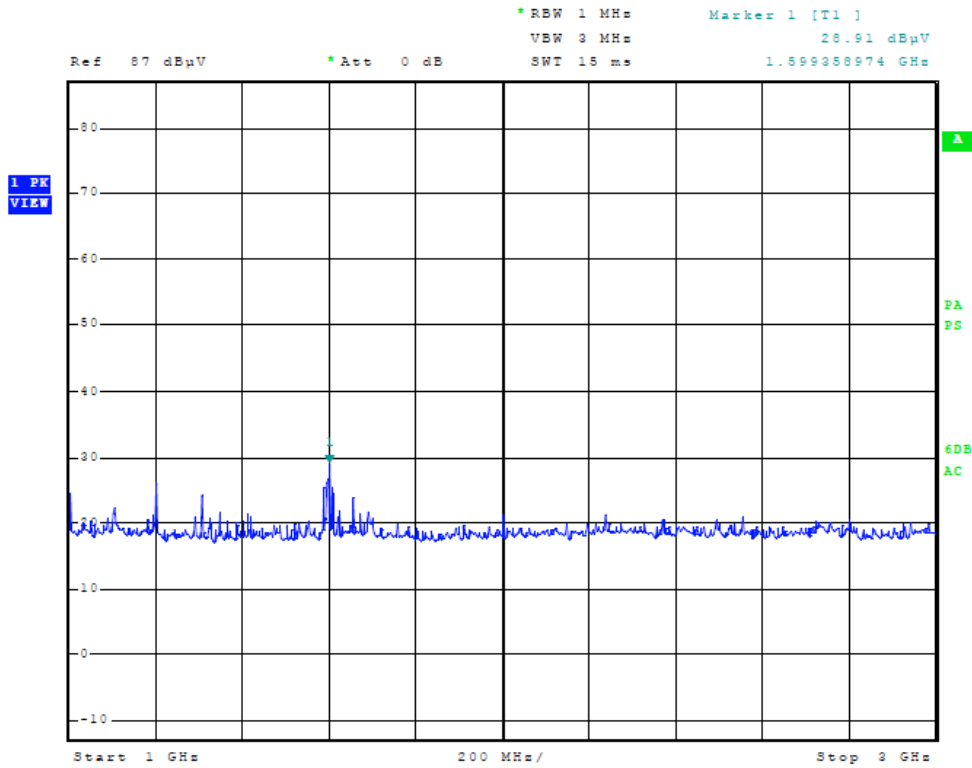

Figure Five General Radiated Emissions taken at 1 meter in screen room

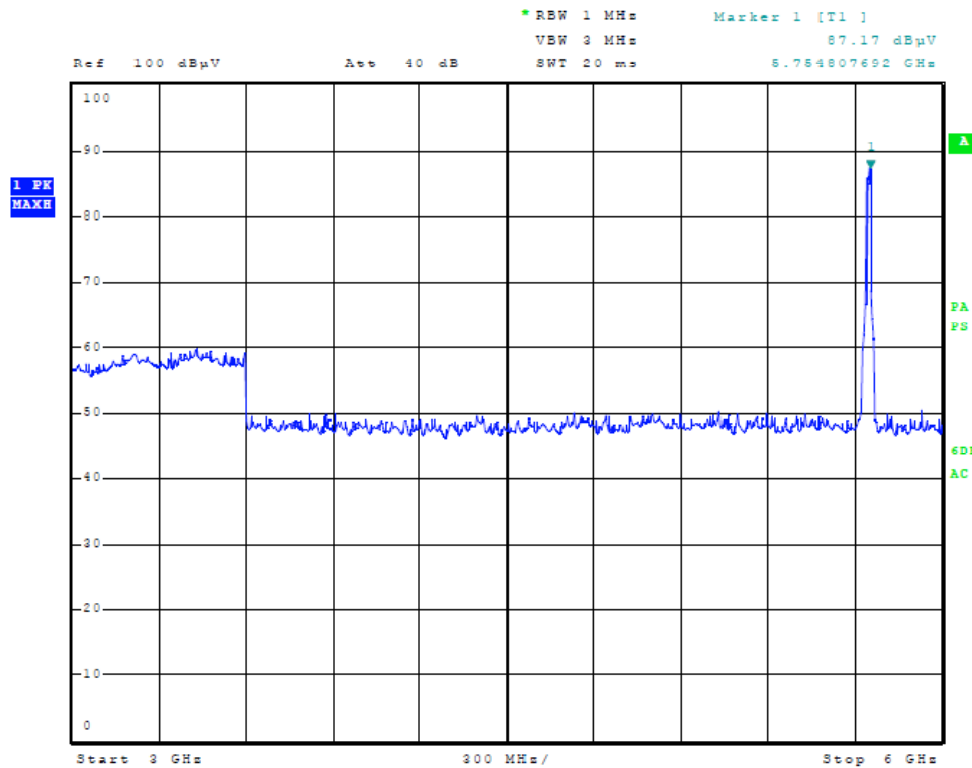

Figure Six General Radiated Emissions taken at 1 meter in screen room

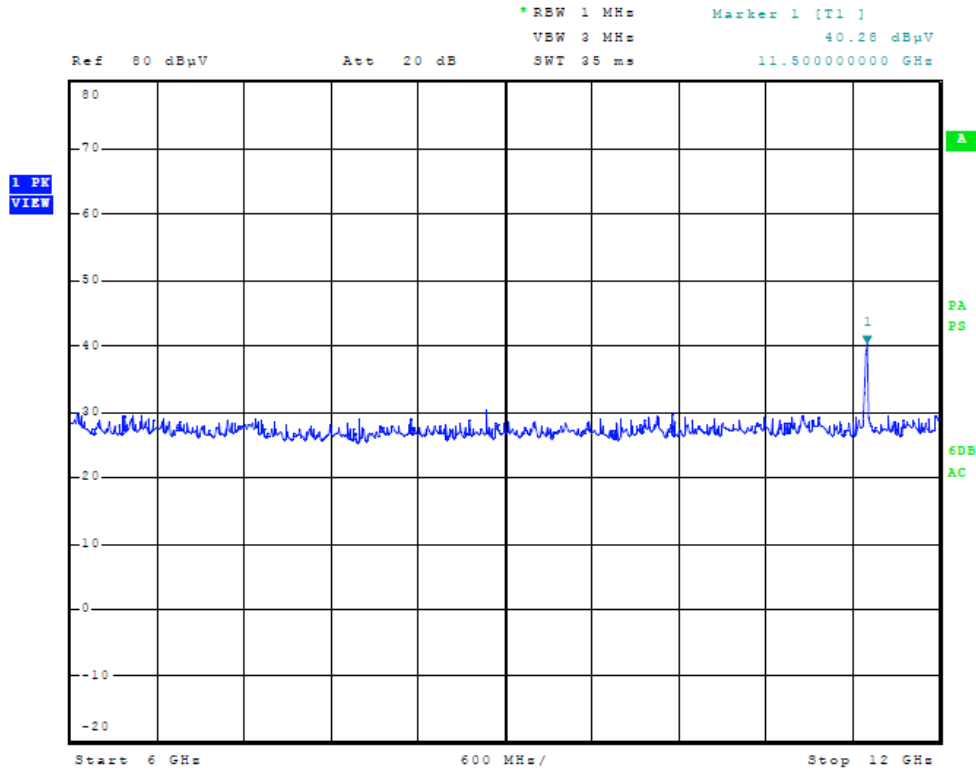

Figure Seven General Radiated Emissions taken at 1 meter in screen room

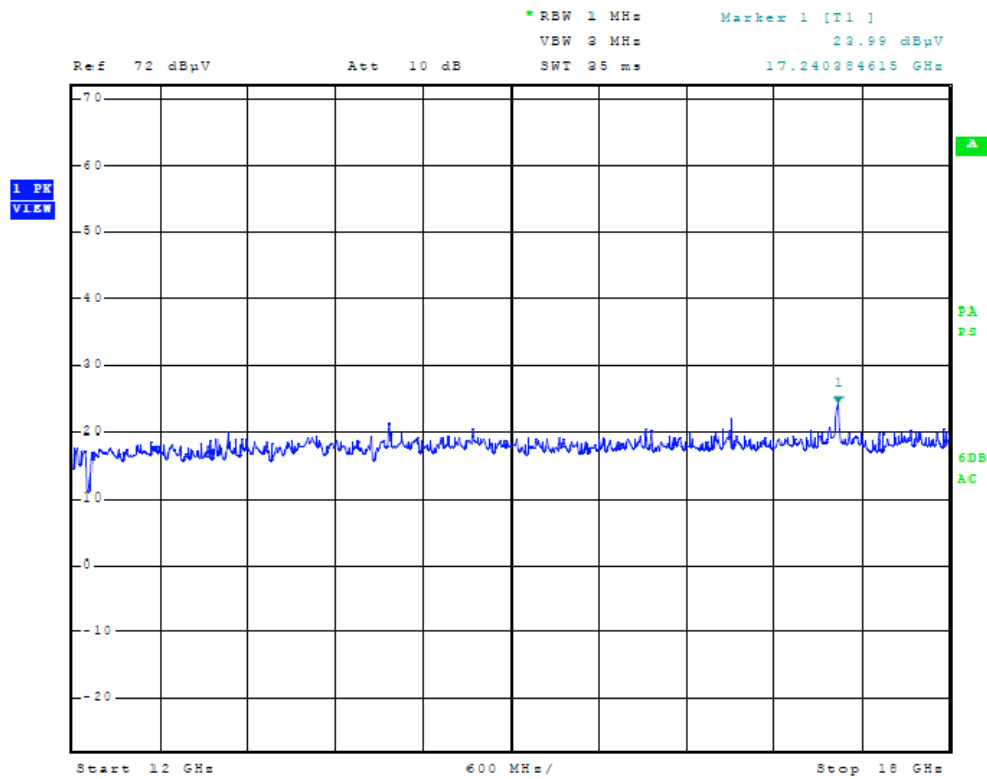

Figure Eight General Radiated Emissions taken at 1 meter in screen room

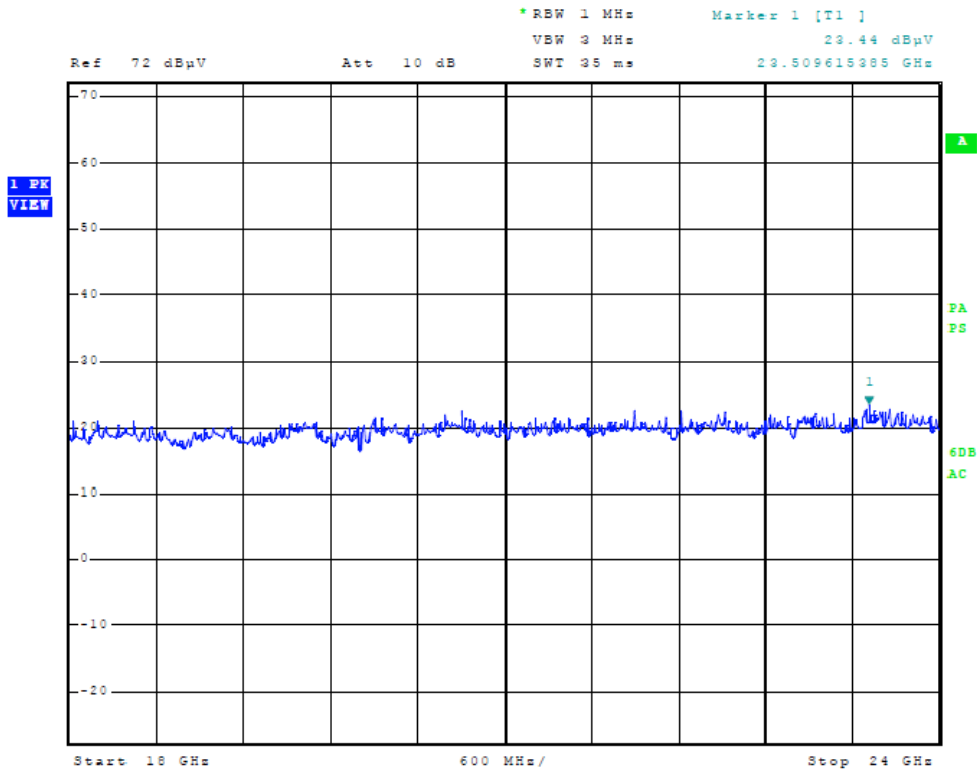

Figure Nine General Radiated Emissions taken at 1 meter in screen room

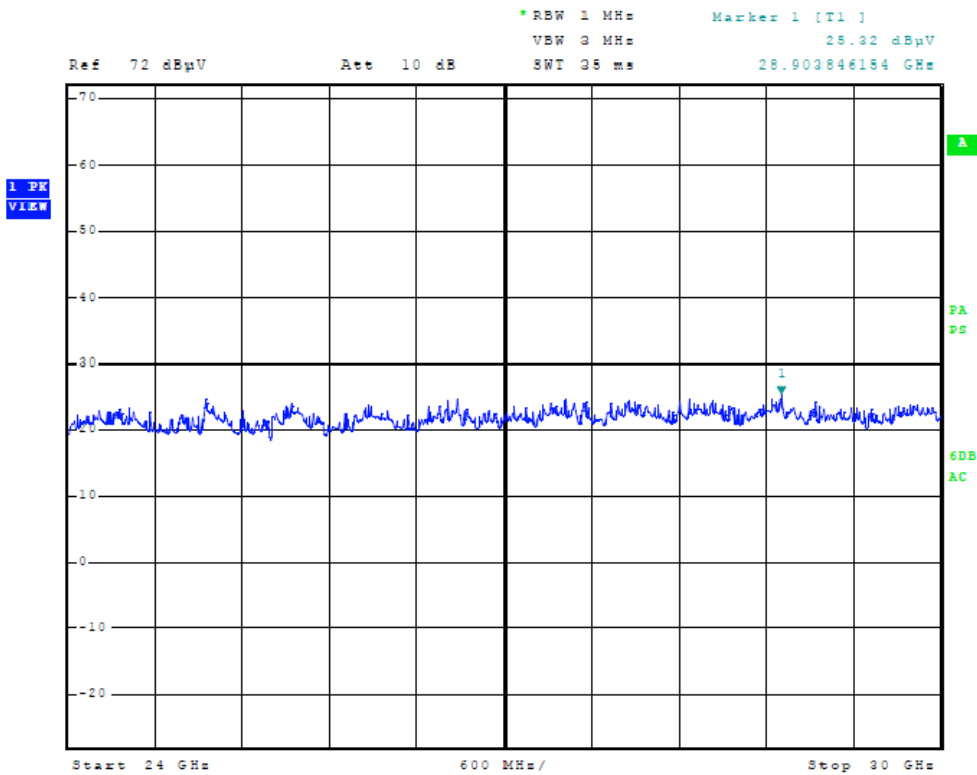

Figure Ten General Radiated Emissions taken at 1 meter in screen room

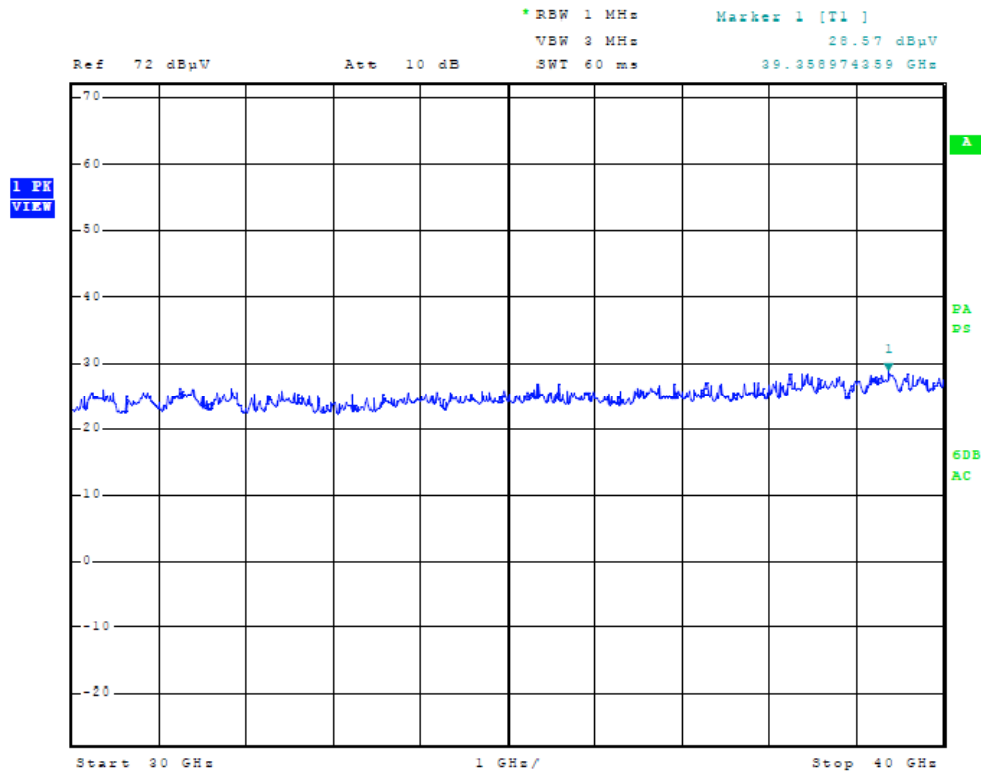

Figure Eleven General Radiated Emissions taken at 1 meter in screen room

Radiated Emissions from EUT Data (Highest Emissions) 15.209

Frequency in MHz	FSM Horz. (dBµV)	FSM Vert. (dBµV)	A.F. (dB/m)	Amp. Gain (dB)	RFS Horz. @ 3m (dBµV/m)	RFS Vert. @ 3m (dBµV/m)	Limit @ 3m (dBµV/m)
68.5	50.2	57.1	8.1	30	28.3	35.2	40.0
69.0	50.4	57.2	8.1	30	28.5	35.3	40.0
71.2	46.8	57.6	8.1	30	24.9	35.7	40.0
74.6	49.2	57.1	8.0	30	27.2	35.1	40.0
77.2	49.4	58.8	8.0	30	27.4	36.8	40.0
137.0	36.5	49.1	13.5	30	20.0	32.6	43.5
137.2	39.7	49.7	13.5	30	23.2	33.2	43.5
142.7	46.1	57.1	13.2	30	29.3	40.3	43.5
143.3	46.4	58.0	13.1	30	29.5	41.1	43.5
143.9	43.5	55.1	13.1	30	26.6	38.2	43.5
144.7	45.3	57.5	13.1	30	28.4	40.6	43.5
145.3	45.1	58.1	13.1	30	28.2	41.2	43.5
173.2	34.5	47.3	11.9	30	16.4	29.2	43.5
223.5	41.2	46.1	12.9	30	24.1	29.0	46.0
250.0	43.8	46.7	12.1	30	25.9	28.8	46.0
276.6	38.7	41.5	13.7	30	22.4	25.2	46.0
280.6	38.3	46.6	13.7	30	22.0	30.3	46.0
1599.5	12.8	13.8	27.2	25	28.3	16.0	54.0

Other emissions present had amplitudes at least 20 dB below the limit.

Summary of Results for General Radiated Emissions 15.209

The EUT demonstrated compliance with the radiated emissions requirements of CFR47 Part 15C paragraph 15.209 Intentional Radiators. The EUT demonstrated a minimum margin of 2.3 dB below the requirements. Other emissions were present with amplitudes at least 20 dB below the Limits.

Statement of Modifications and Deviations

No modifications to the EUT were required for the equipment to demonstrate compliance with the CISPR 22 or CFR47 emissions requirements. There were no deviations or exceptions to the specifications.

15.247 Operation in the Band 5725 – 5850 MHz

The power output was measured at the open area test site at a three-meter distance. The EUT was placed on a wooden turntable 0.8 meters above the ground plane at a distance of 3 meters from the FSM antenna. The peak and quasi-peak amplitude of the frequencies below 1000 MHz were measured using a spectrum analyzer. The peak and average amplitude of emissions above 1000 MHz including were measured using a spectrum analyzer and data recorded from the analyzer measurement result. Plots were made of transmitter performance taken in a screen room for reference purposes. Refer to figures twelve through forty-six showing plots taken of the EUT performance displaying compliance with the specifications.

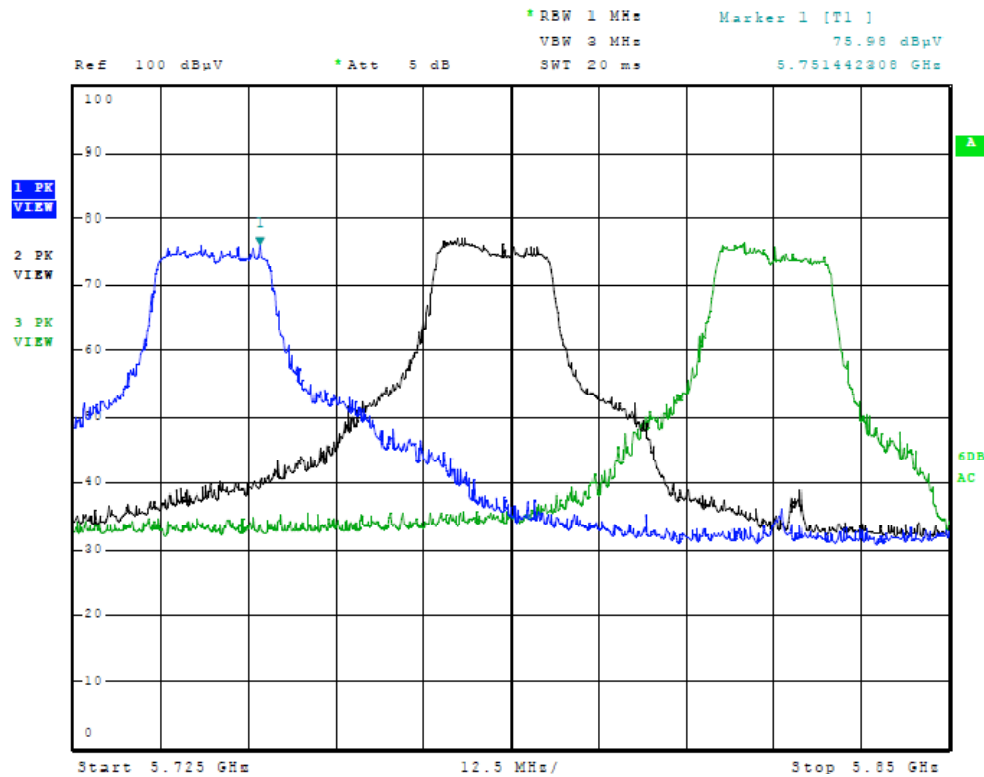

Figure Twelve Plot of Radiated Emissions (Transmitter Operation in band, 5GHz Mode)

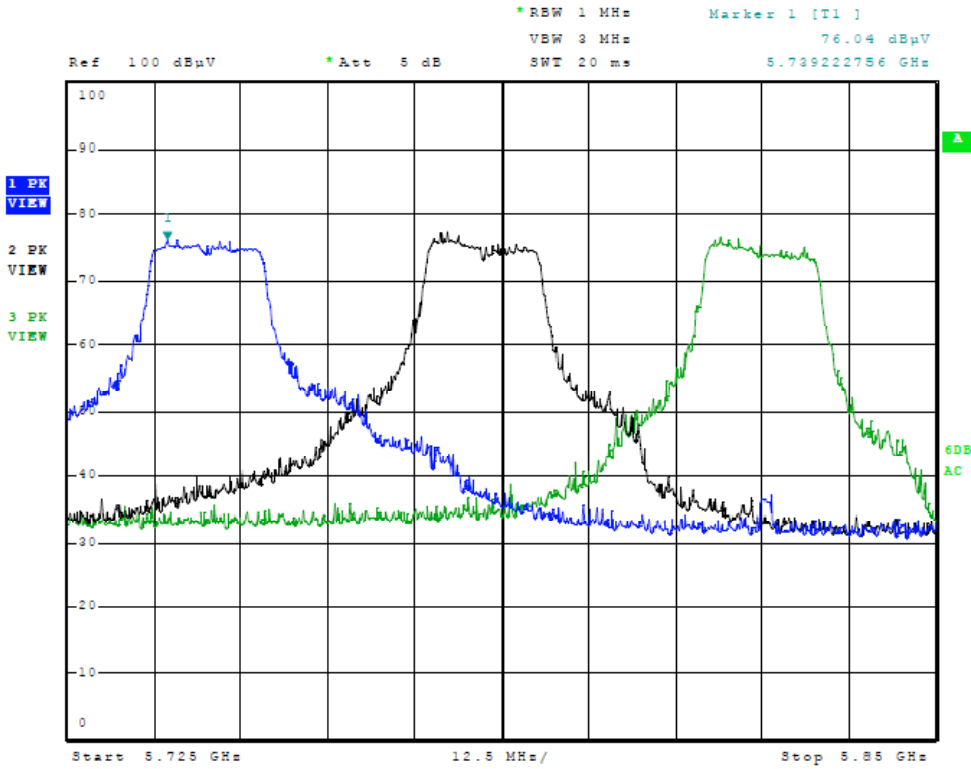

Figure Thirteen Plot of Radiated Emissions (Transmitter Operation in band, a/n Mode)

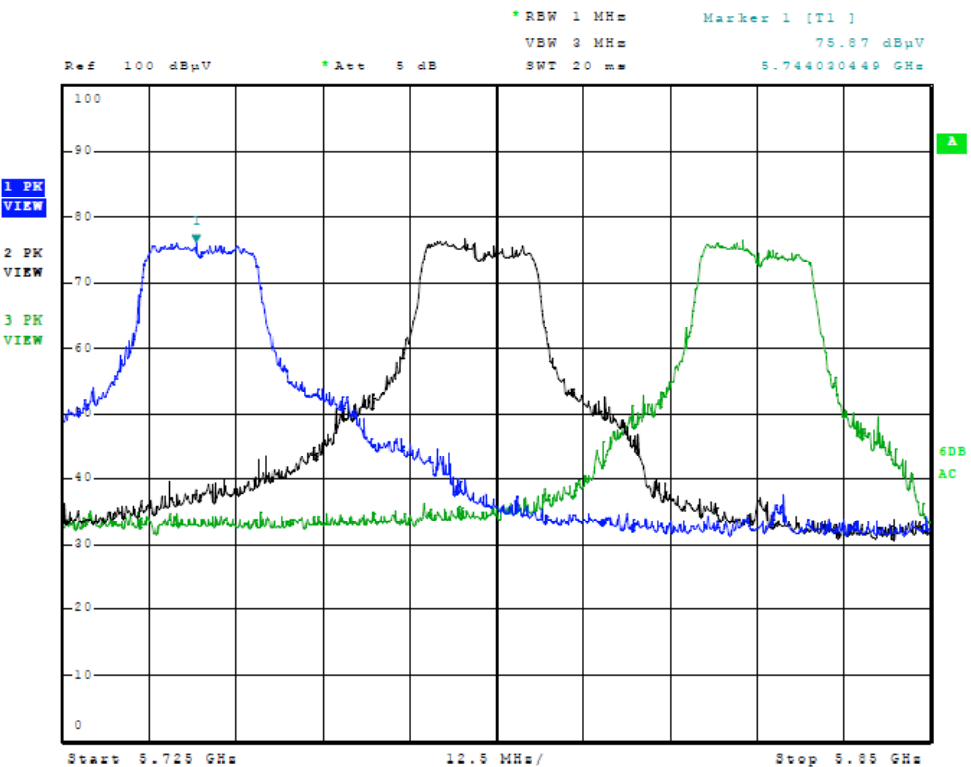

Figure Fourteen Plot of Radiated Emissions (Transmitter Operation in band, N Mode)

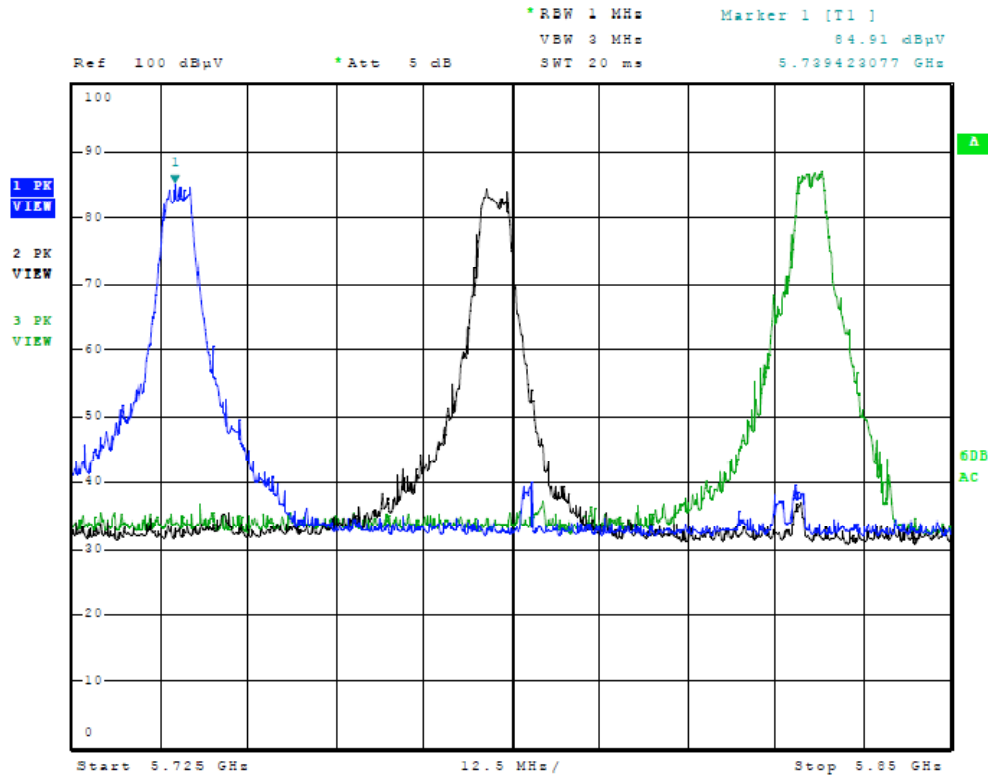

Figure Fifteen Plot of Radiated Emissions (Transmitter Operation in band, 5-MHz Mode)

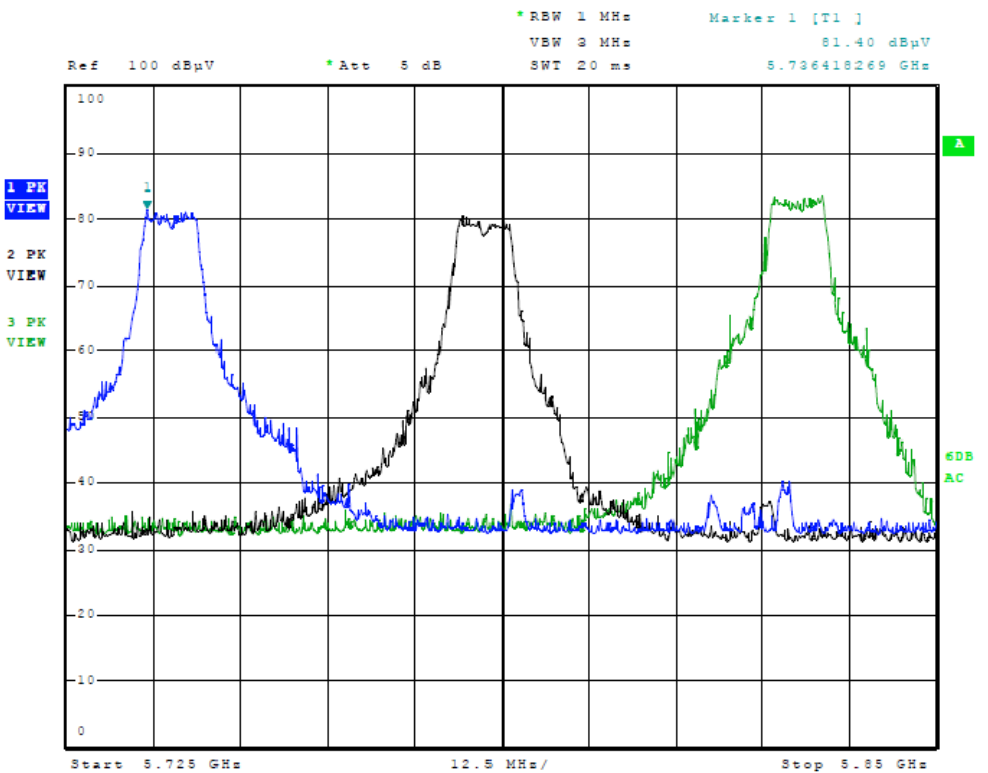

Figure Sixteen Plot of Radiated Emissions (Transmitter Operation in band, 10-MHz Mode)

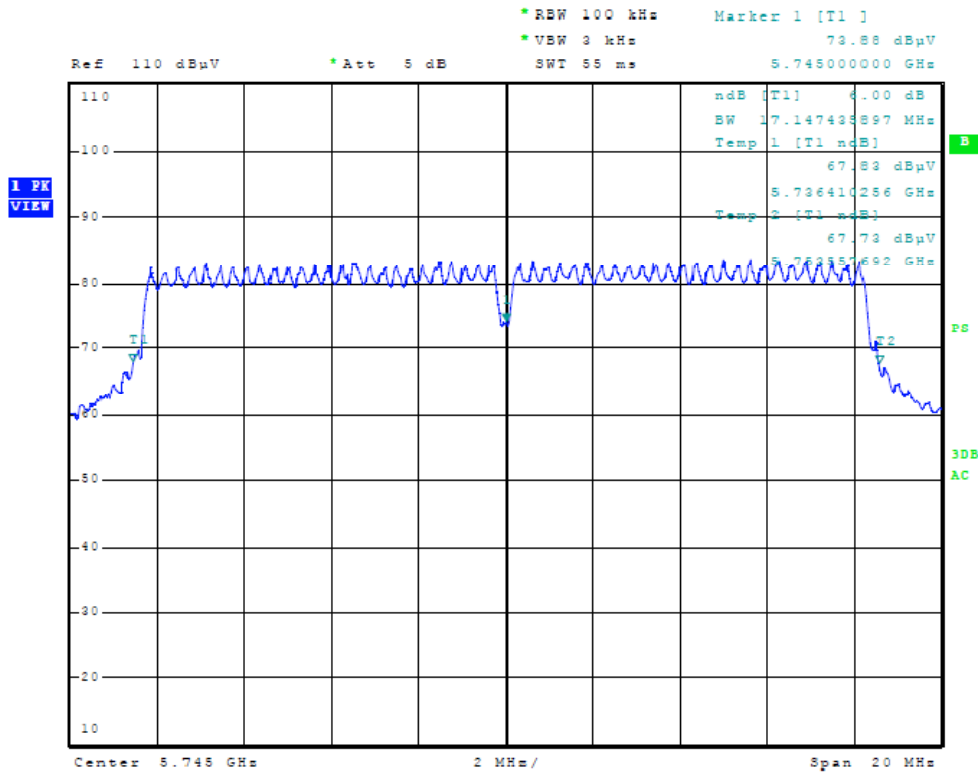

Figure Seventeen Plot of 6dB Band width (5GHz Mode, 5745 MHz)

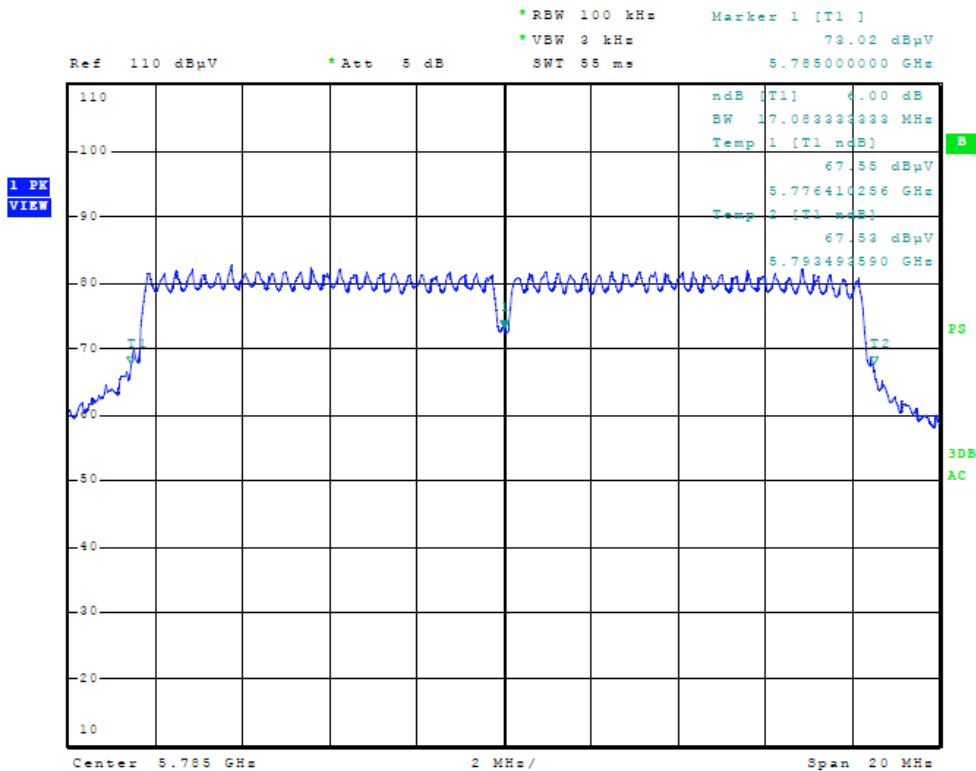

Figure Eighteen Plot of 6dB Band width (5GHz Mode, 5785 MHz)

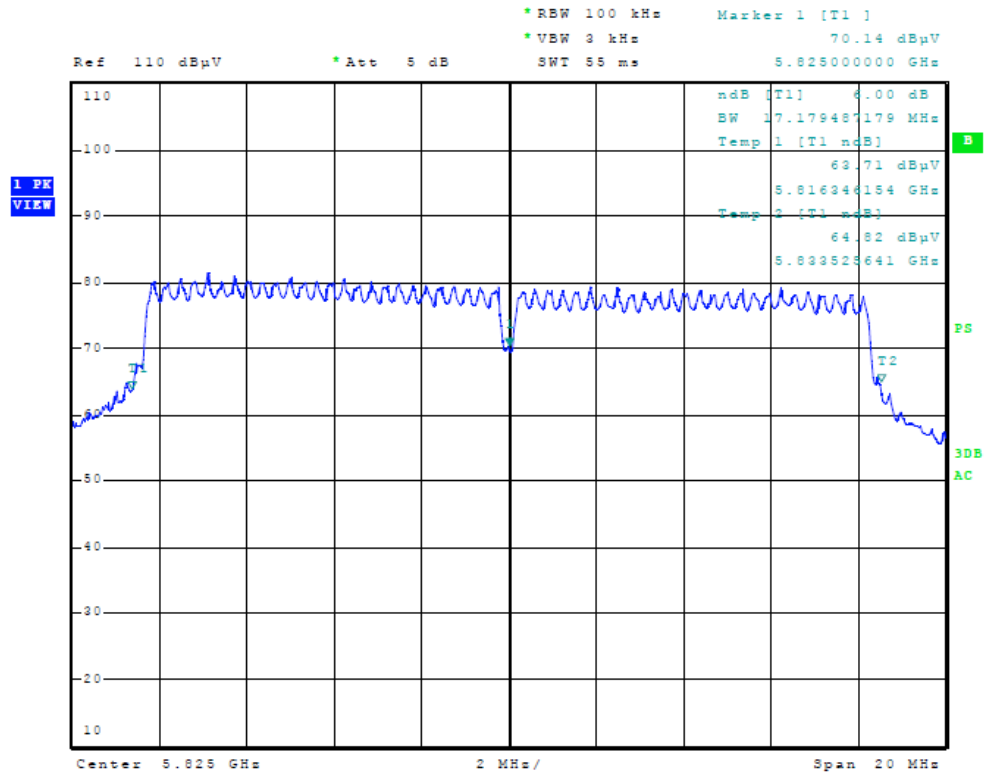

Figure Nineteen Plot of 6dB Band width (5GHz Mode, 5825 MHz)

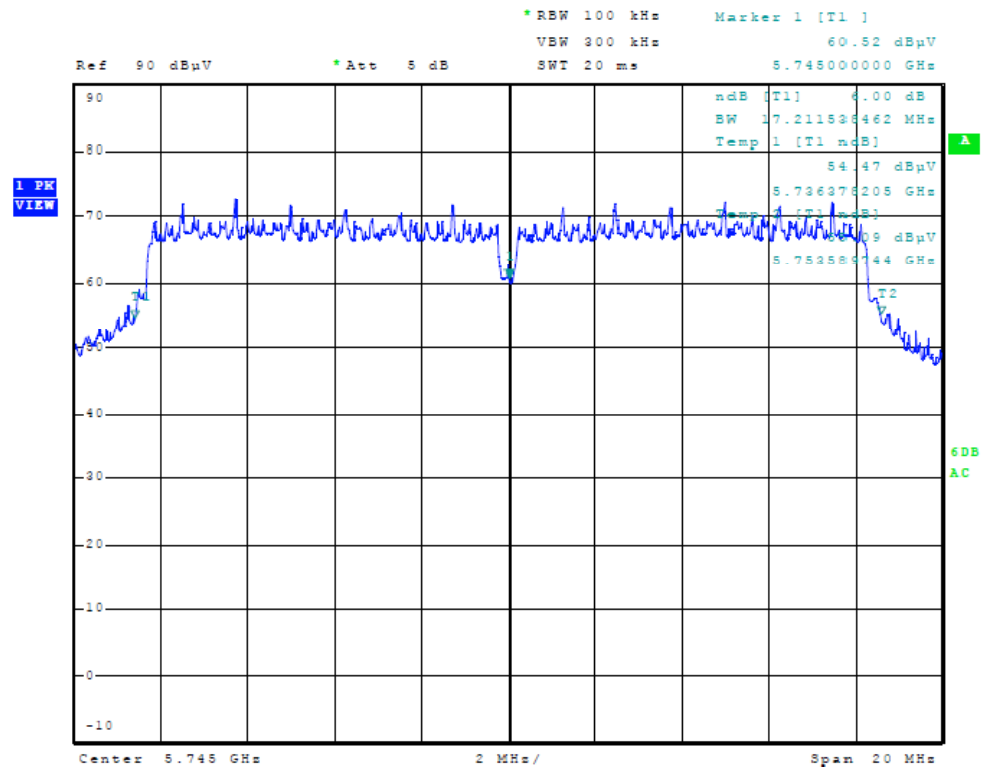

Figure Twenty Plot of 6dB Band width (a/n Mode, 5745 MHz)

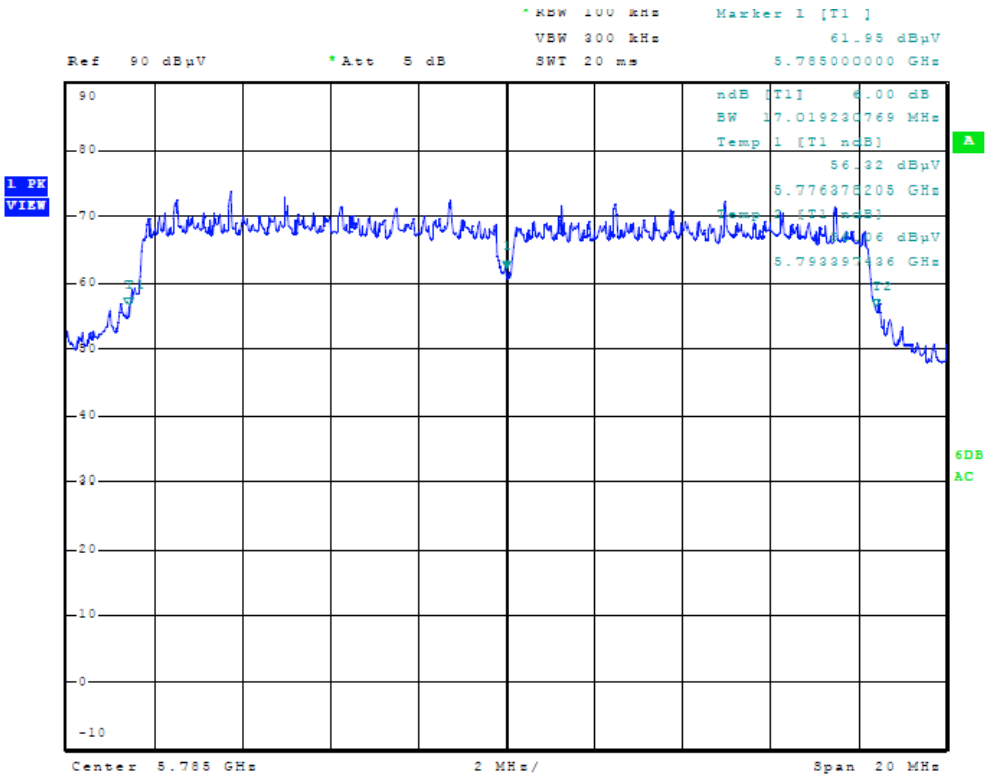

Figure Twenty-one Plot of 6dB Band width (a/n Mode, 5785 MHz)

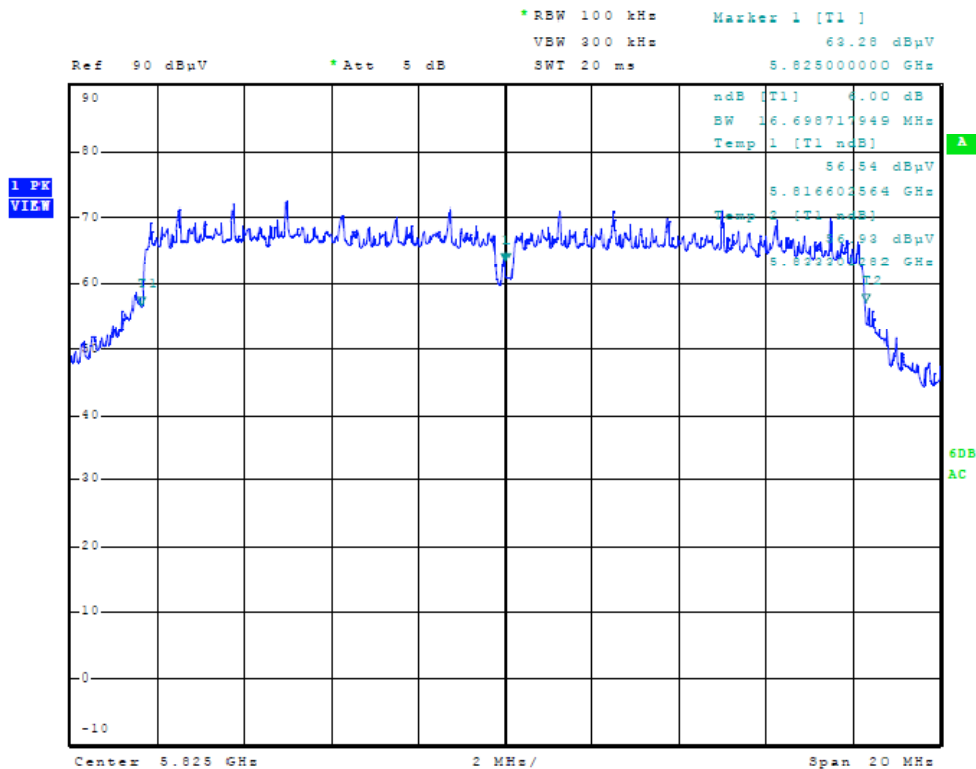

Figure Twenty-two Plot of 6dB Band width (a/n Mode, 5825 MHz)

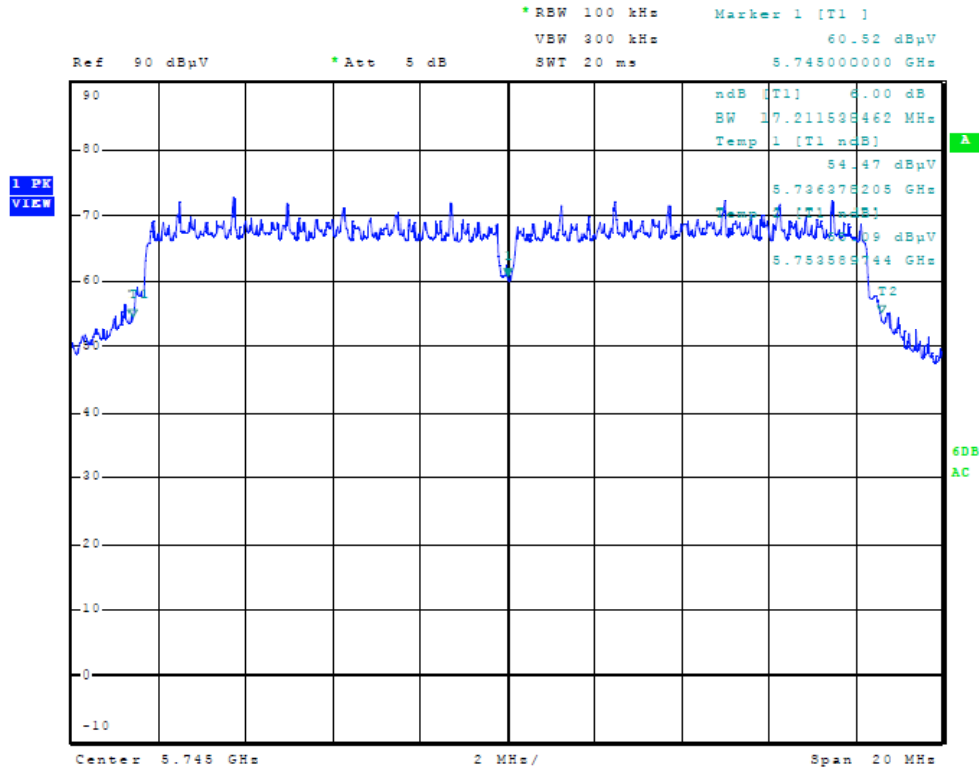

Figure Twenty-three Plot of 6dB Band width (n Mode, 5745 MHz)

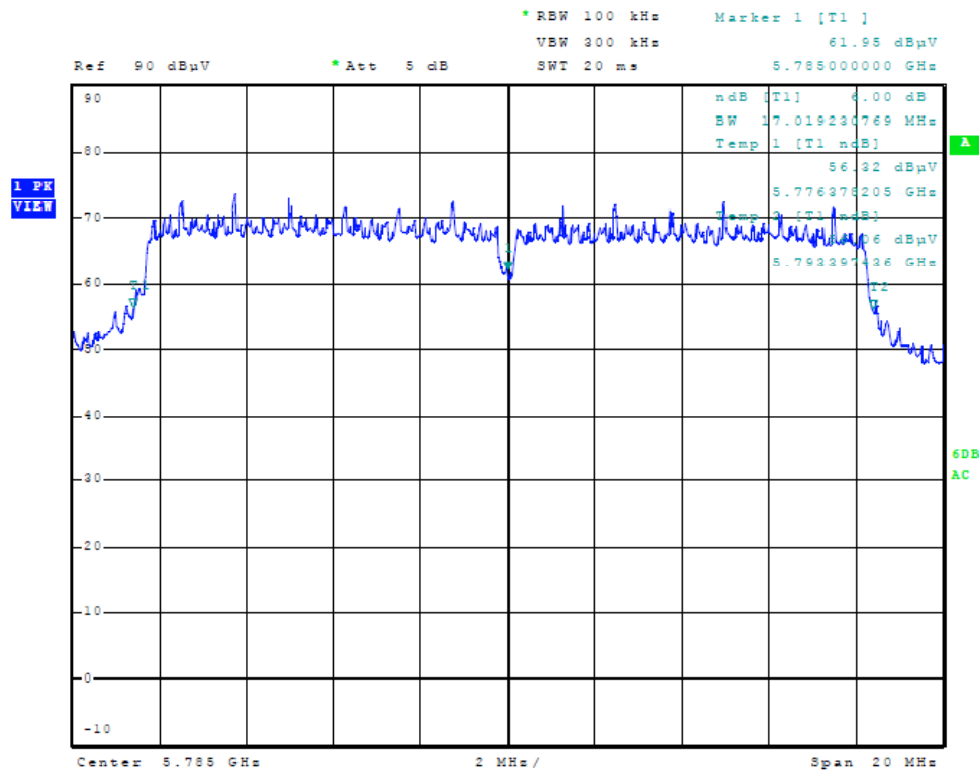

Figure Twenty-four Plot of 6dB Band width (n Mode, 5785 MHz)

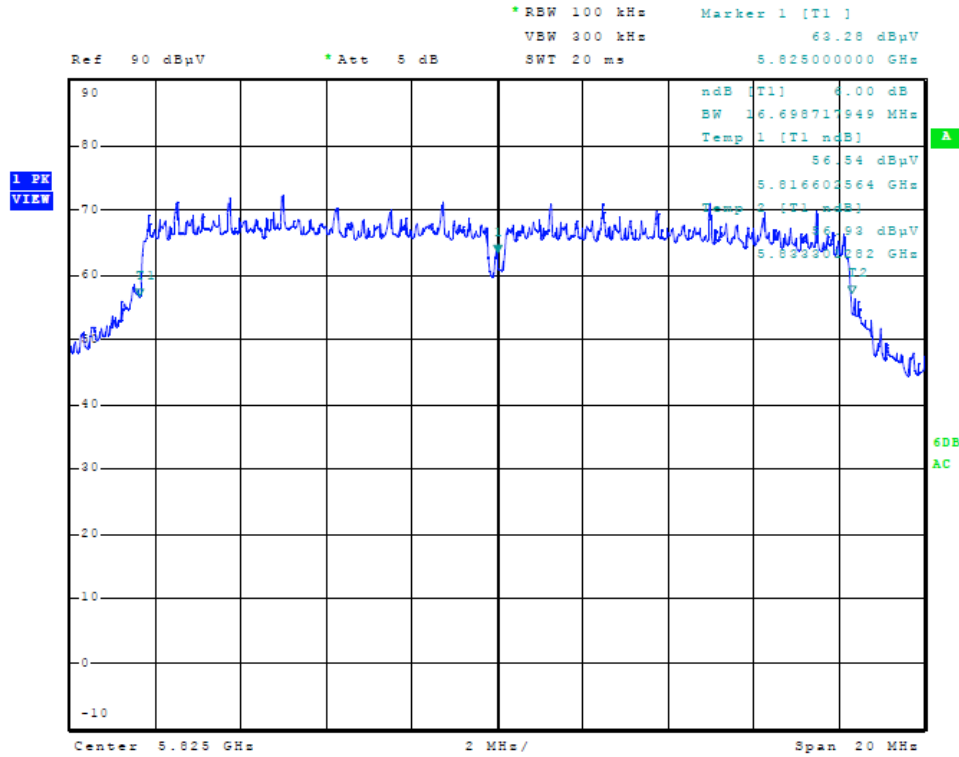

Figure Twenty-five Plot of 6dB Band width (n Mode, 5825 MHz)

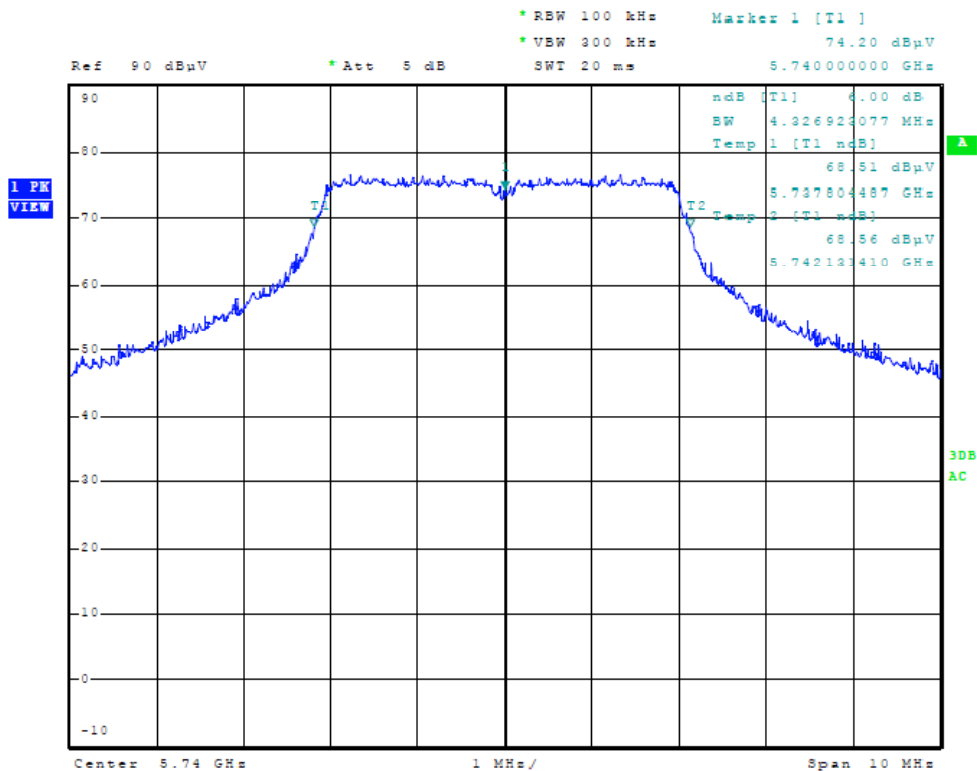

Figure Twenty-six Plot of 6dB Band width (5 MHz Mode, 5740 MHz)

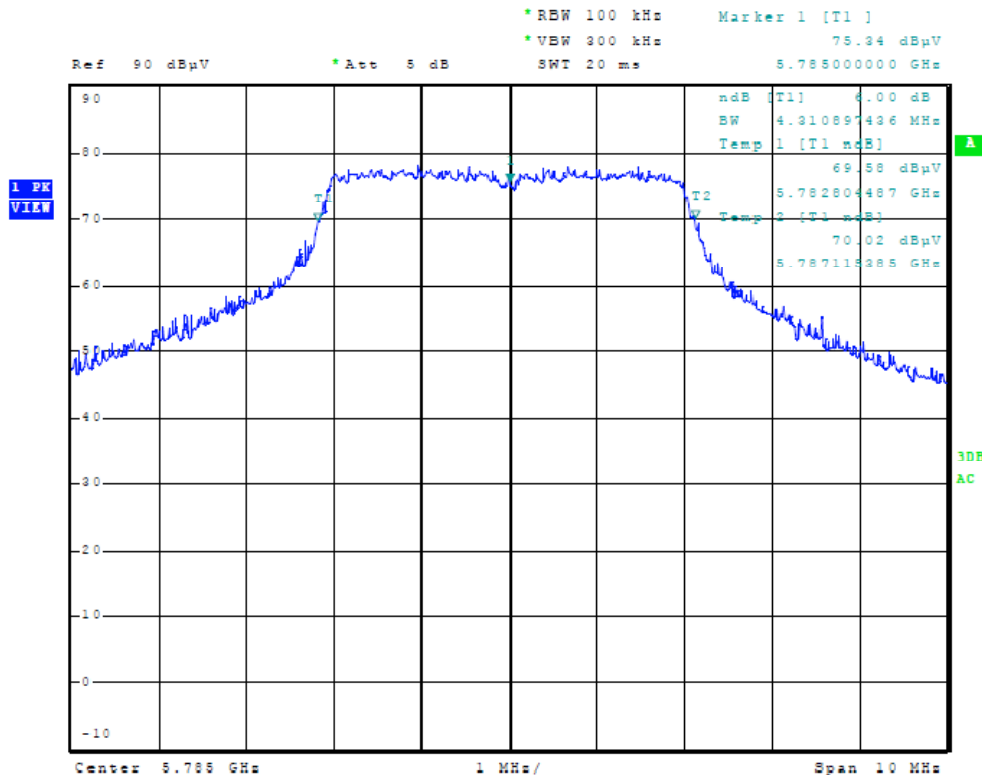

Figure Twenty-seven Plot of 6dB Band width (5 MHz Mode, 5785 MHz)

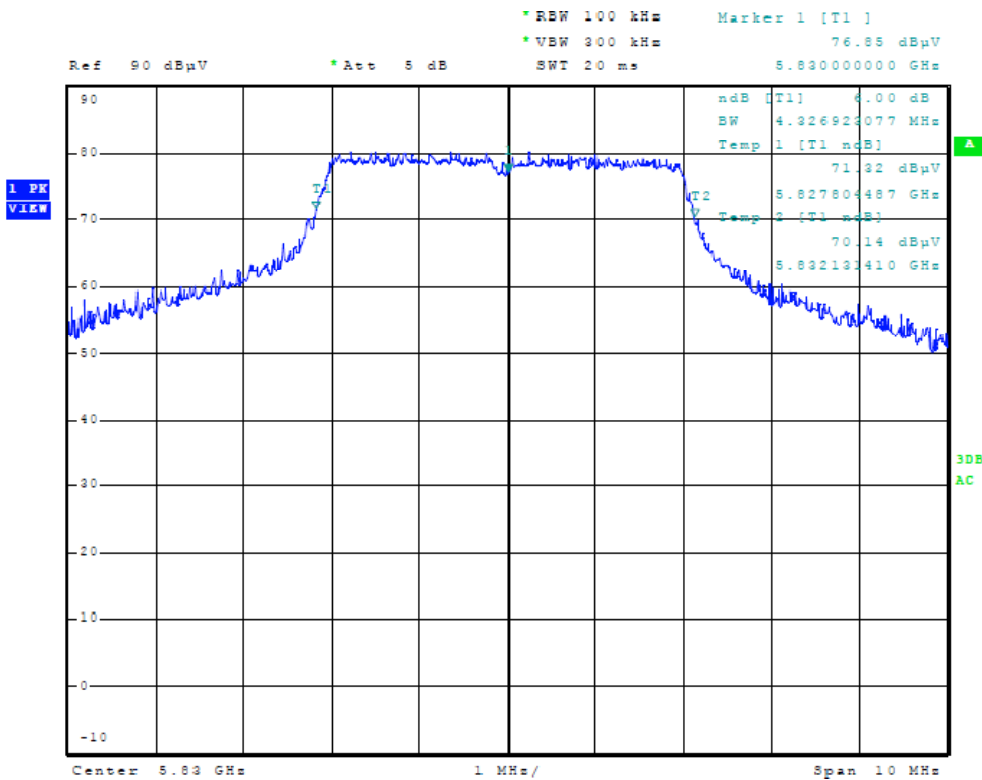

Figure Twenty-eight Plot of 6dB Band width (5 MHz Mode, 5830 MHz)

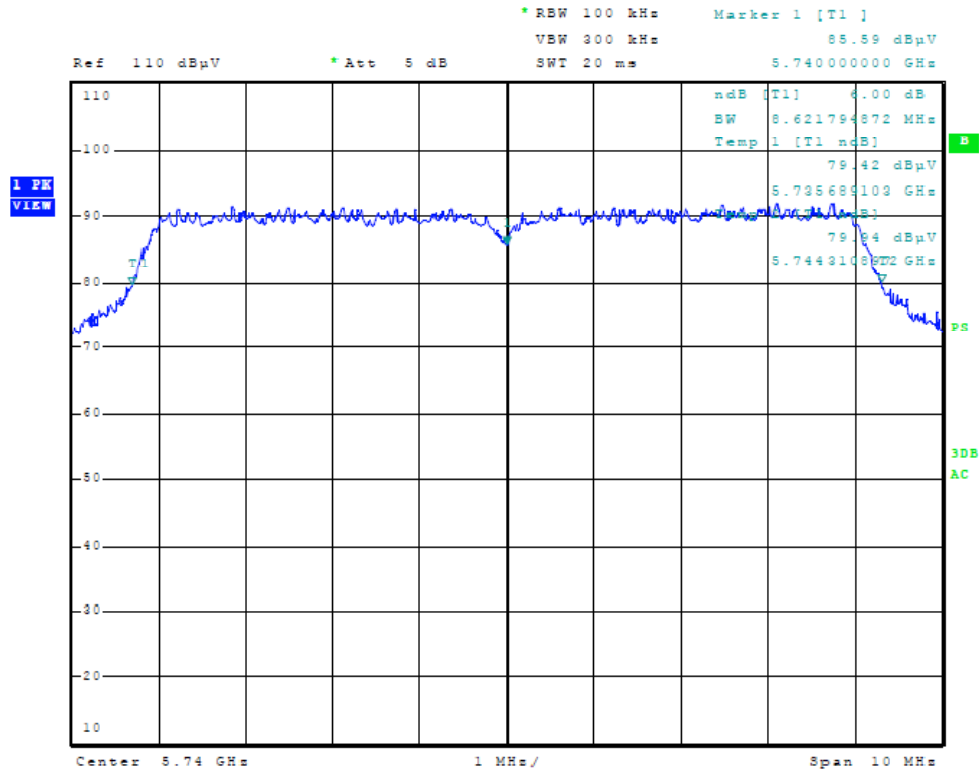

Figure Twenty-nine Plot of 6dB Band width (10 MHz Mode, 5740 MHz)

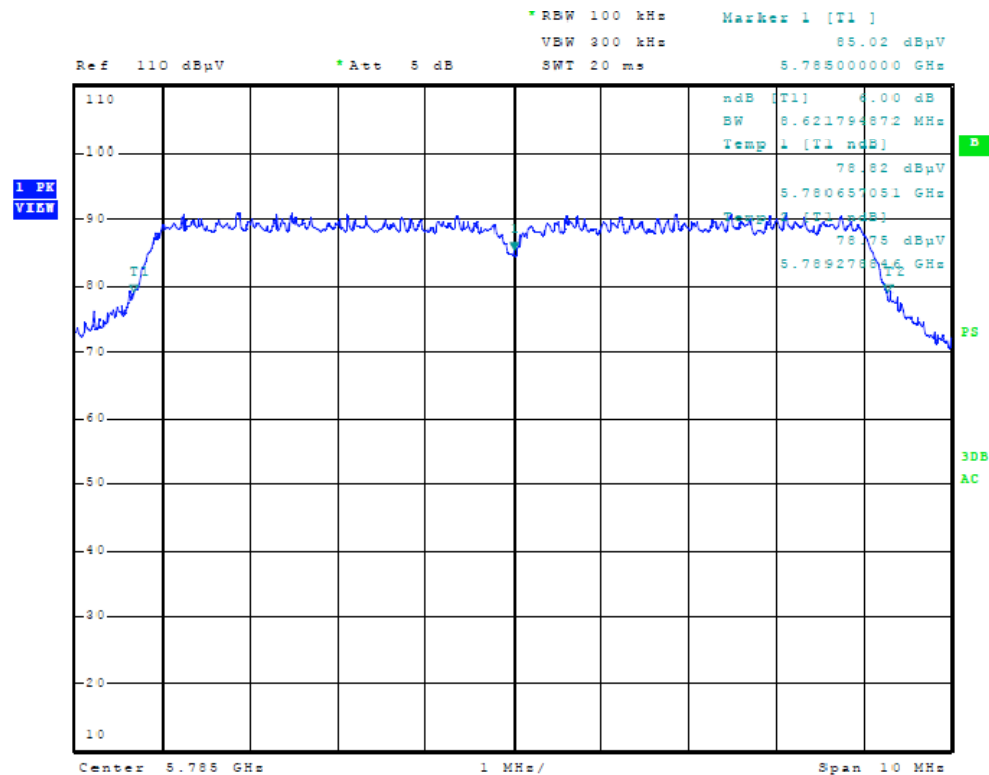

Figure Thirty Plot of 6dB Band width (10 MHz Mode, 5785 MHz)

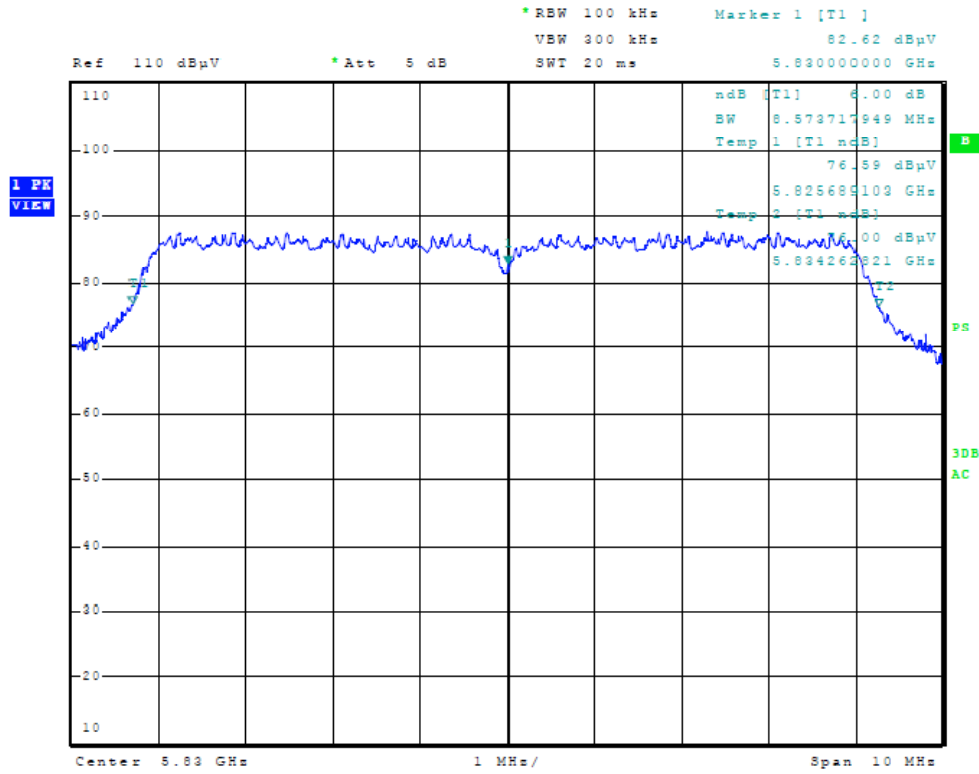

Figure Thirty-one Plot of 6dB Band width (10 MHz Mode, 5830 MHz)

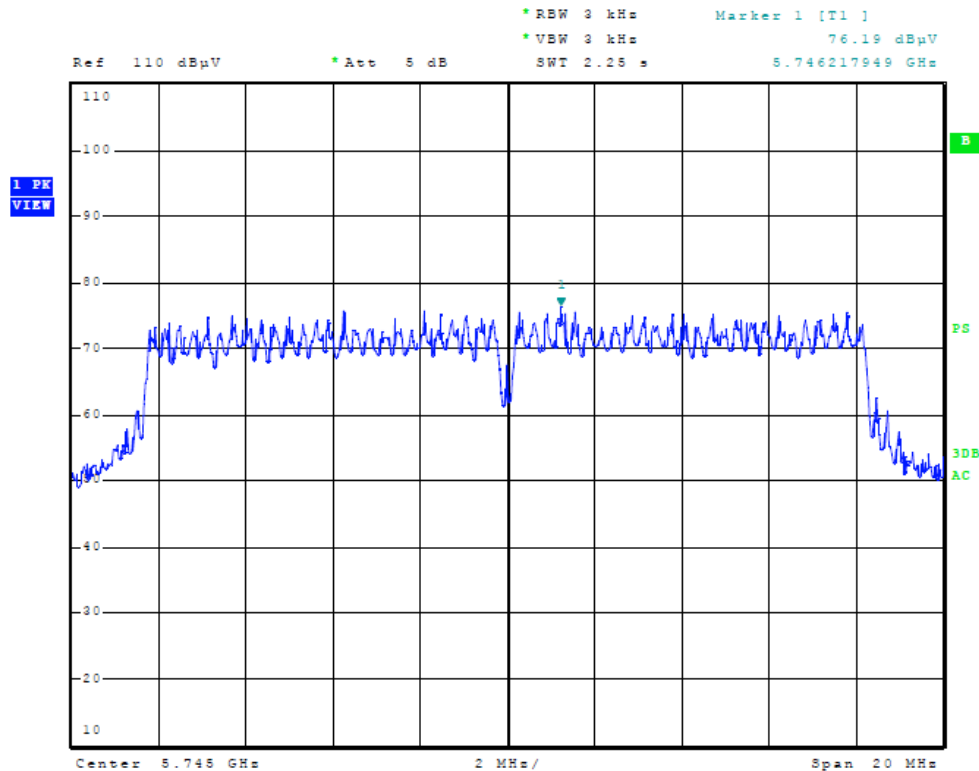

Figure Thirty-two Plot of Power Spectral Density (5GHz Mode, 5745 MHz)

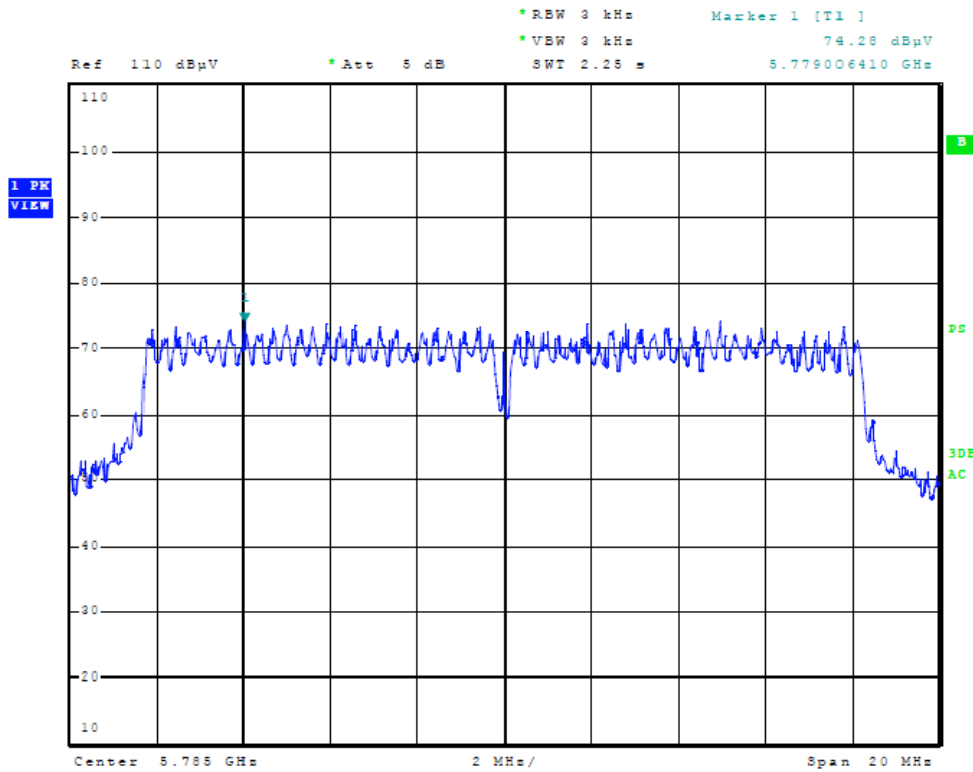

Figure Thirty-three Plot of Power Spectral Density (5GHz Mode, 5785 MHz)

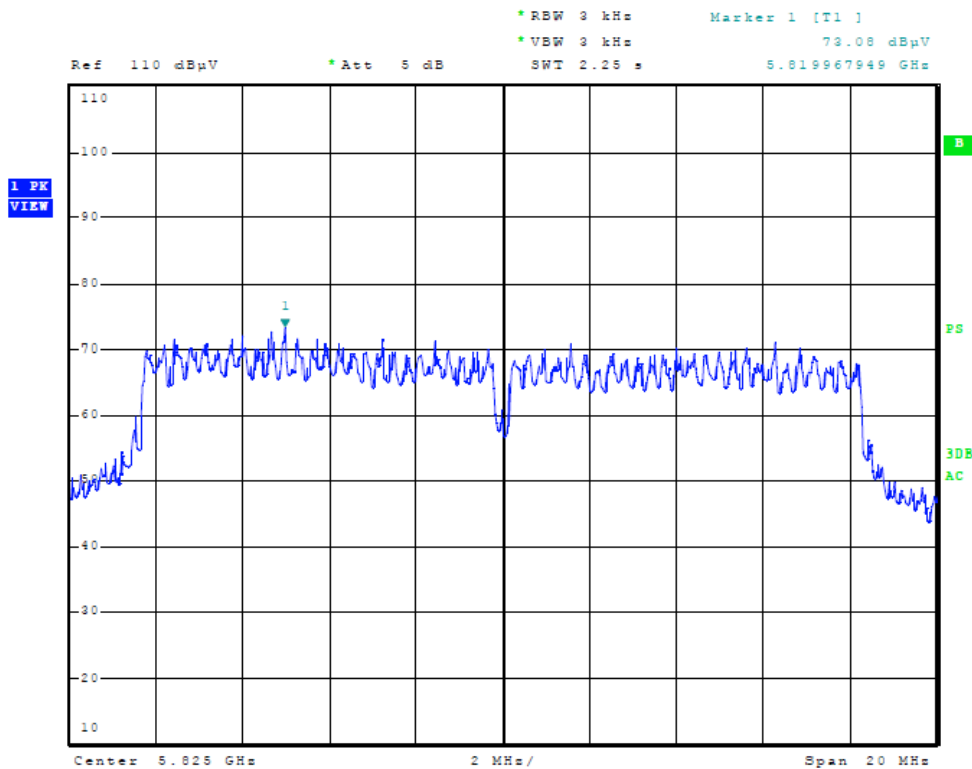

Figure Thirty-four Plot of Power Spectral Density (5GHz Mode, 5825 MHz)

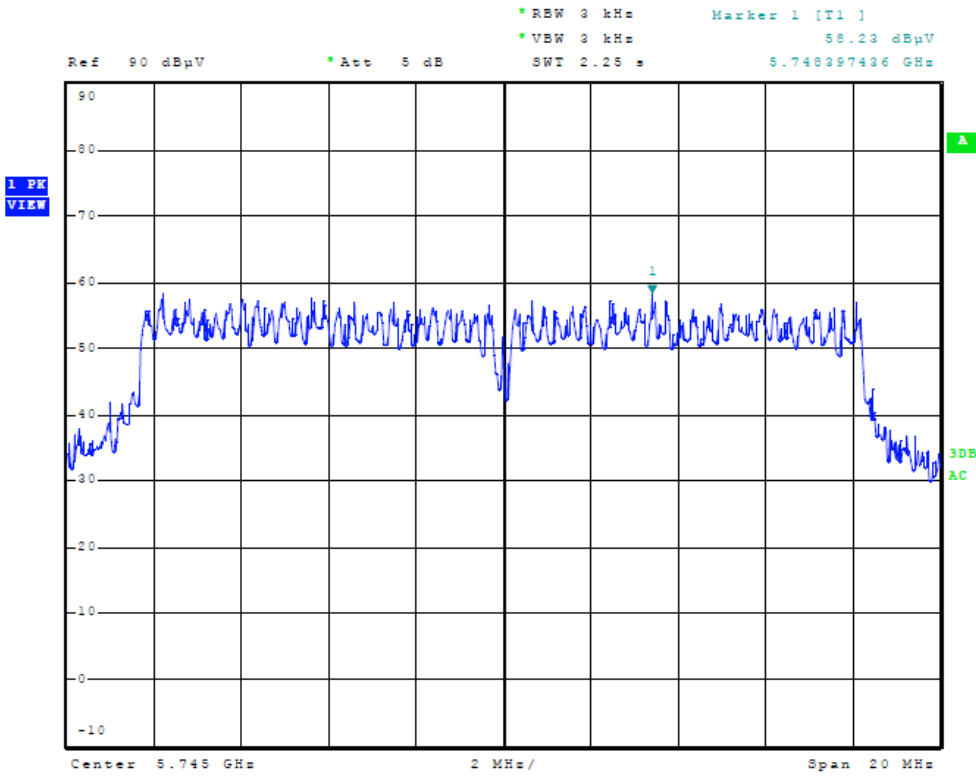

Figure Thirty-five Plot of Power Spectral Density (a/n Mode, 5745 MHz)

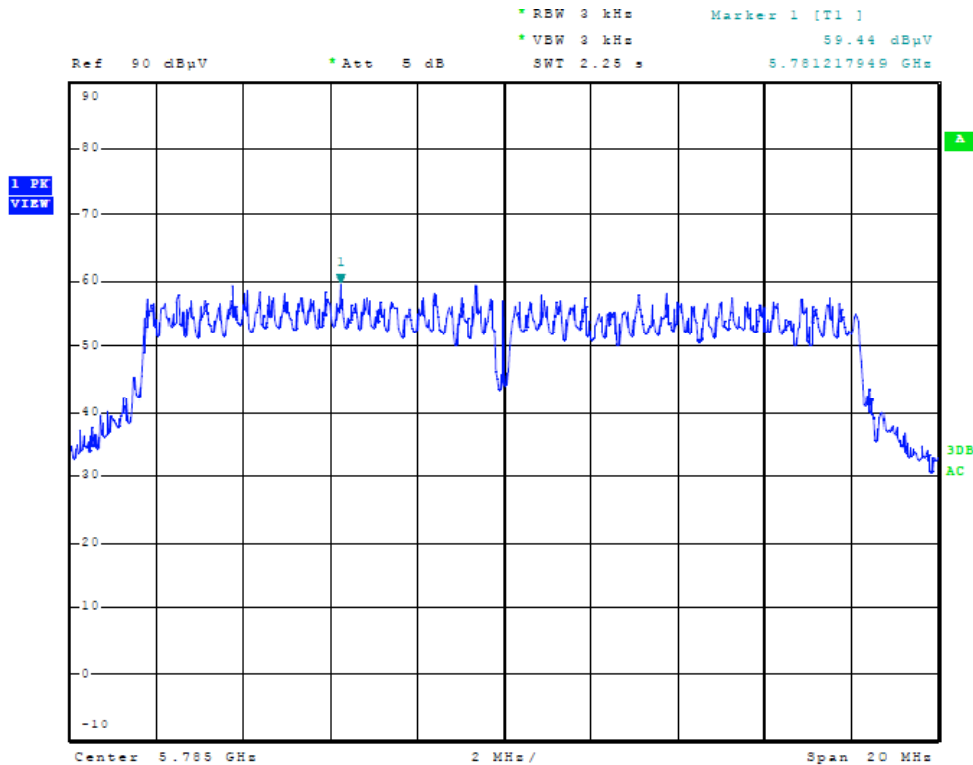

Figure Thirty-six Plot of Power Spectral Density (a/n Mode, 5785 MHz)

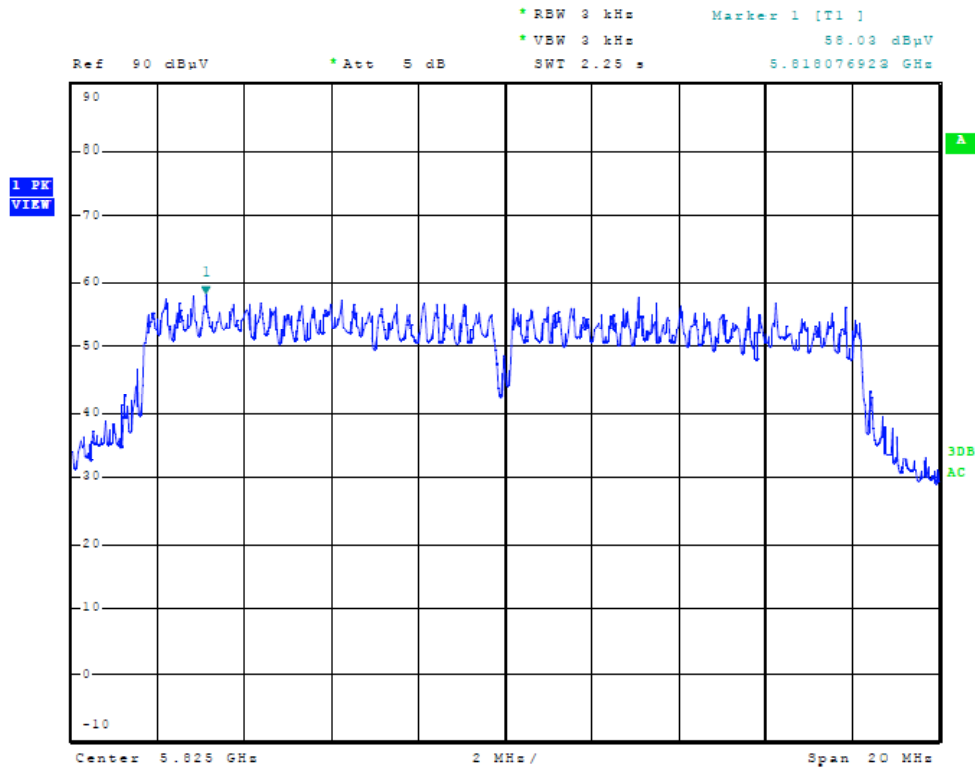

Figure Thirty-seven Plot of Power Spectral Density (a/n Mode, 5825 MHz)

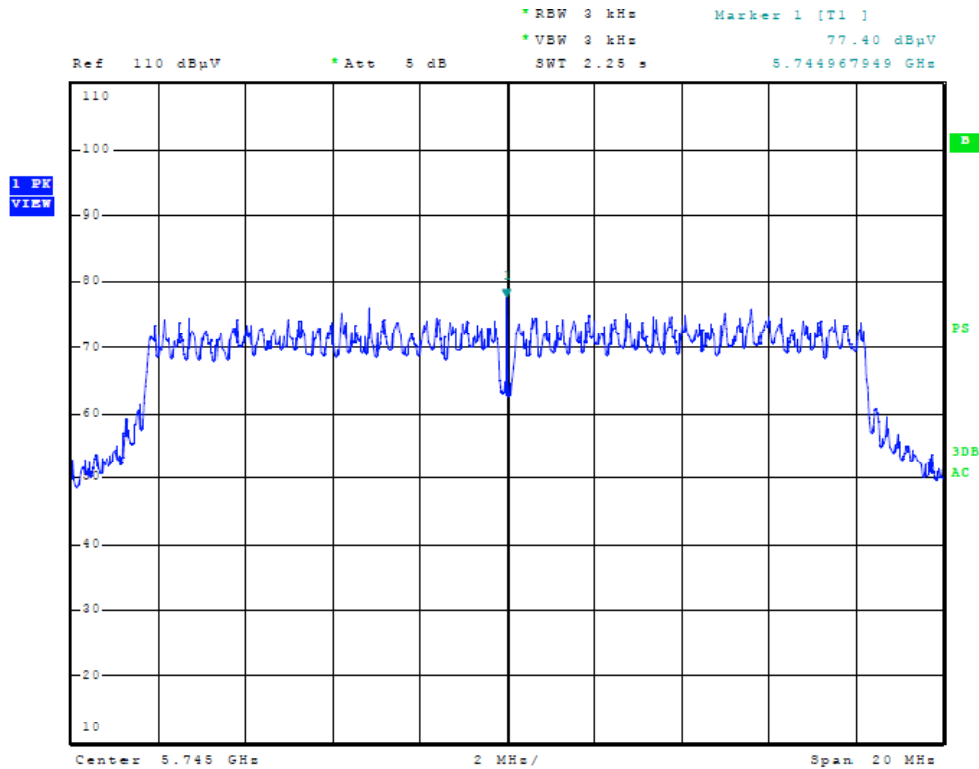

Figure Thirty-eight Plot of Power Spectral Density (n Mode, 5745 MHz)

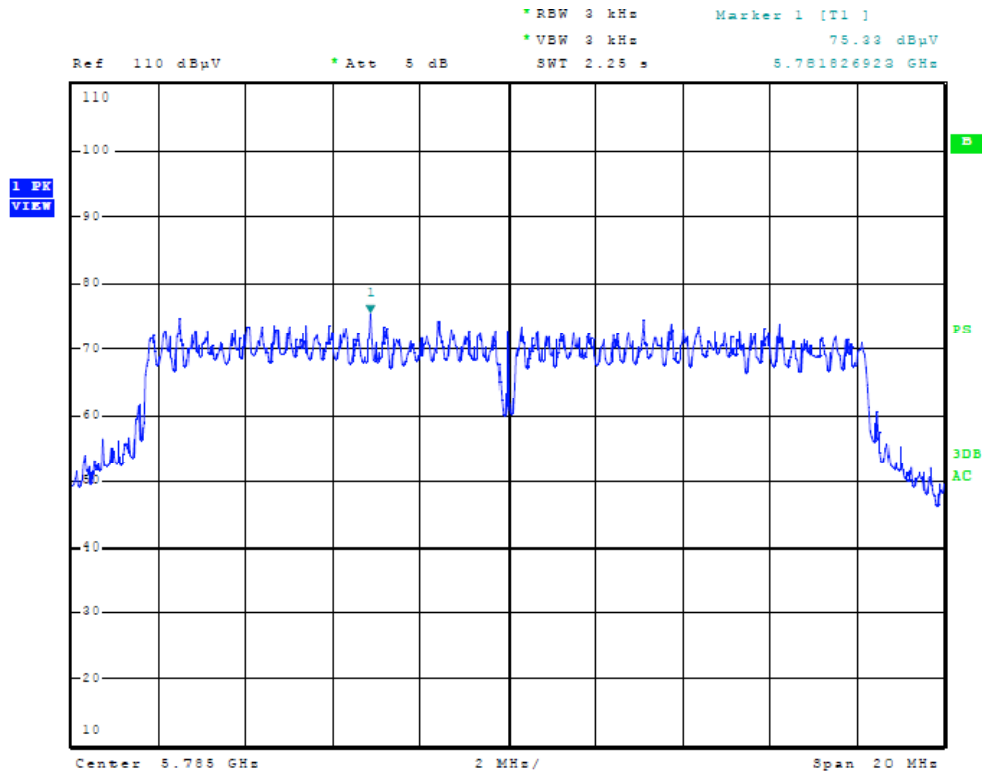

Figure Thirty-nine Plot of Power Spectral Density (n Mode, 5785 MHz)

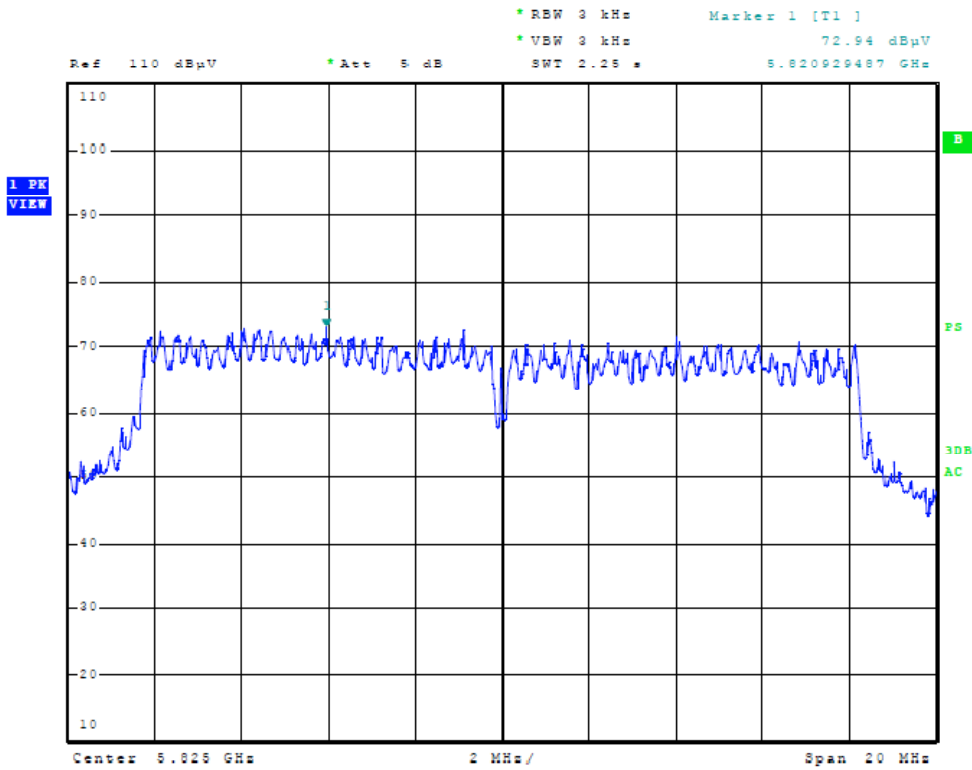

Figure Forty Plot of Power Spectral Density (n Mode, 5825 MHz)

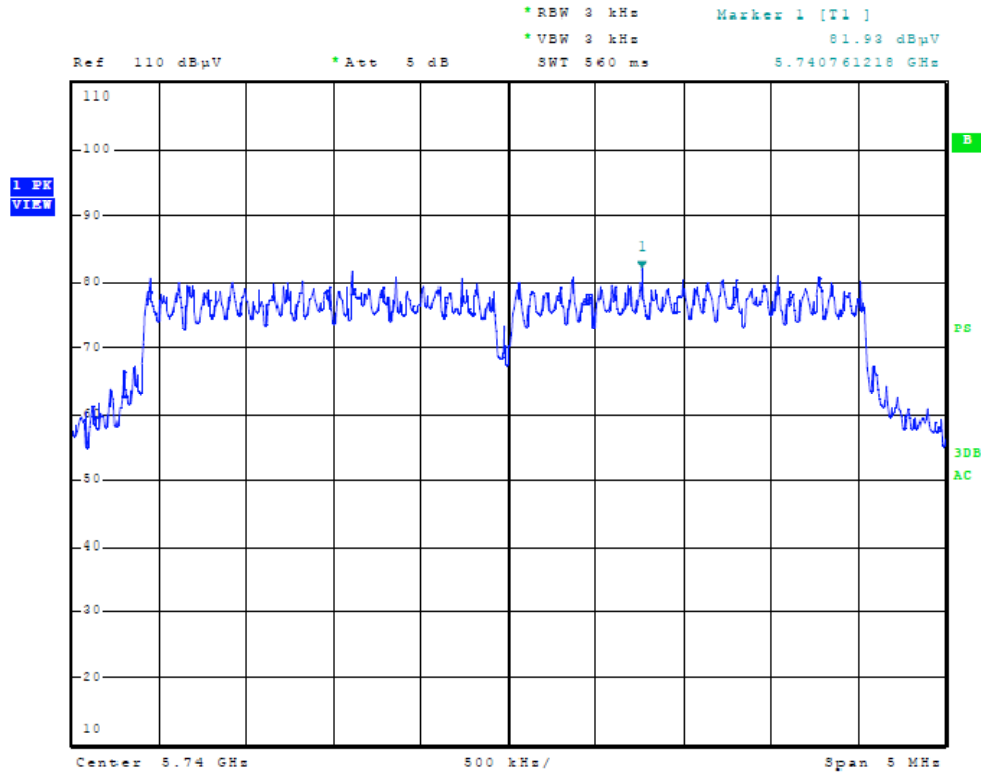

Figure Forty-one Plot of Power Spectral Density (5 MHz Mode, 5740 MHz)

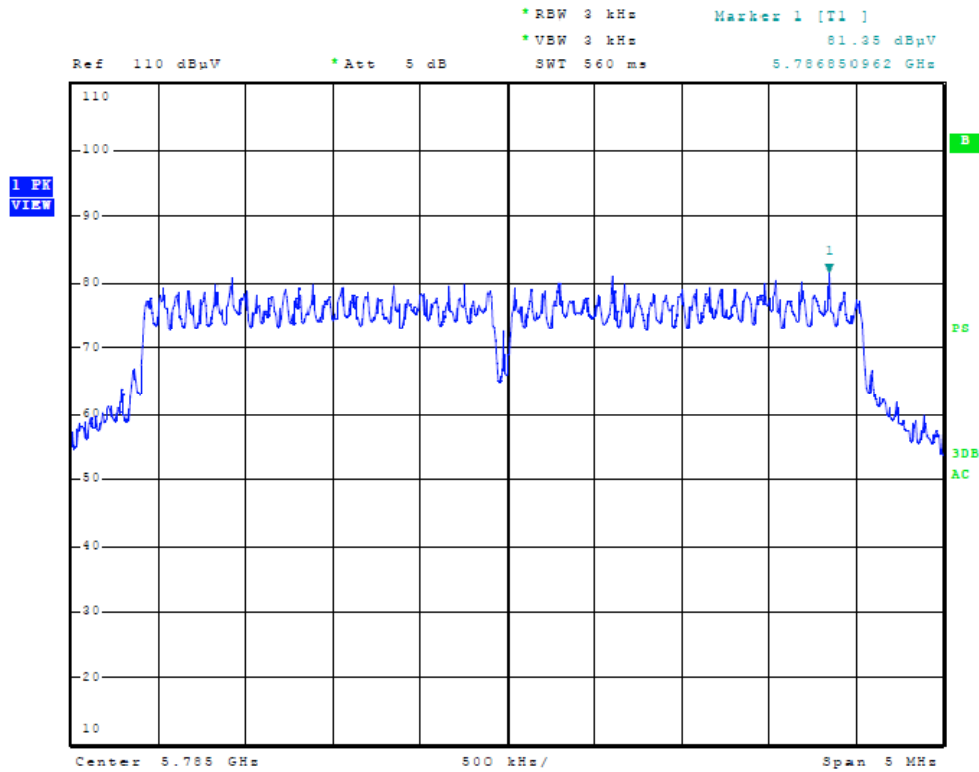

Figure Forty-two Plot of Power Spectral Density (5 MHz Mode, 5785 MHz)

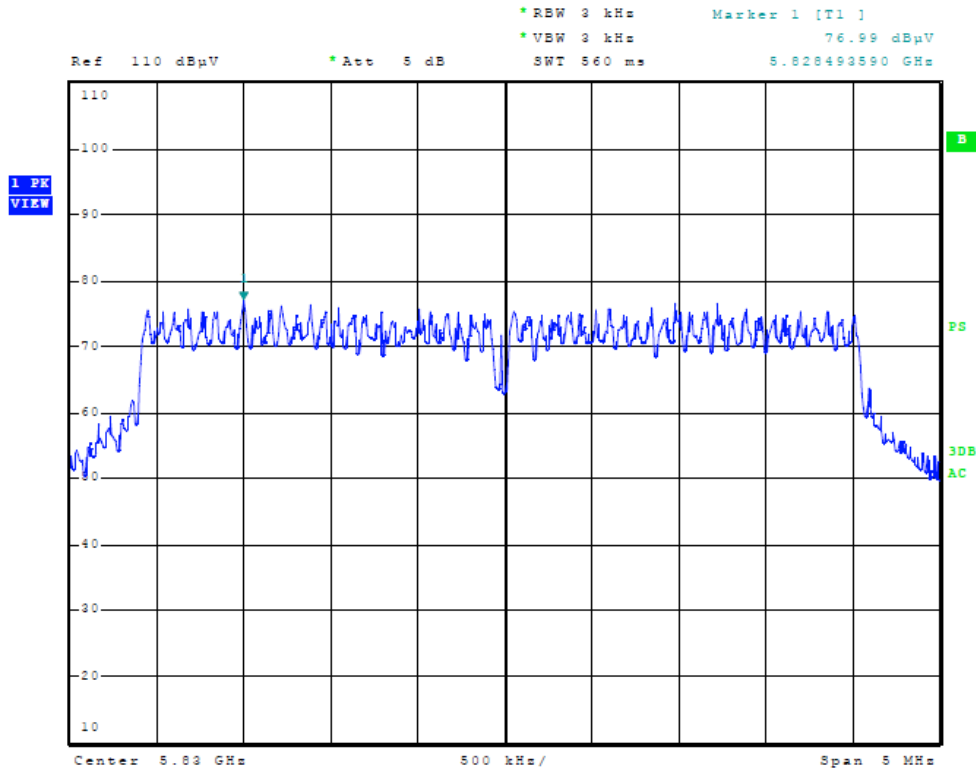

Figure Forty-three Plot of Power Spectral Density (5 MHz Mode, 5830 MHz)

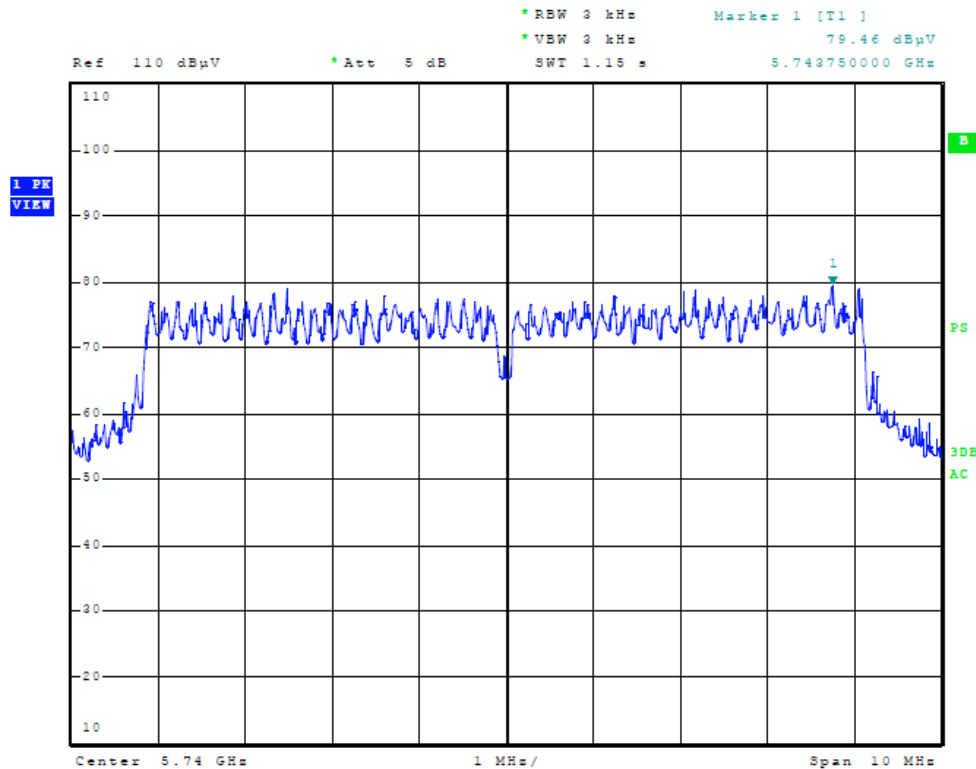

Figure Forty-four Plot of Power Spectral Density (10 MHz Mode, 5740 MHz)

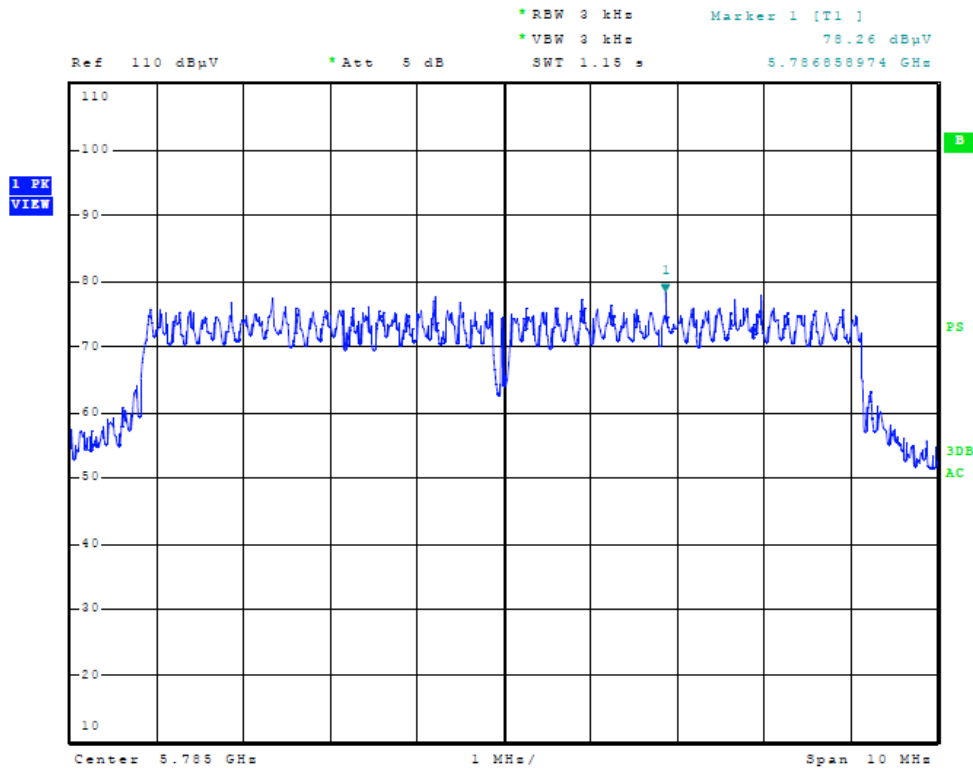

Figure Forty-five Plot of Power Spectral Density (10 MHz Mode, 5785 MHz)

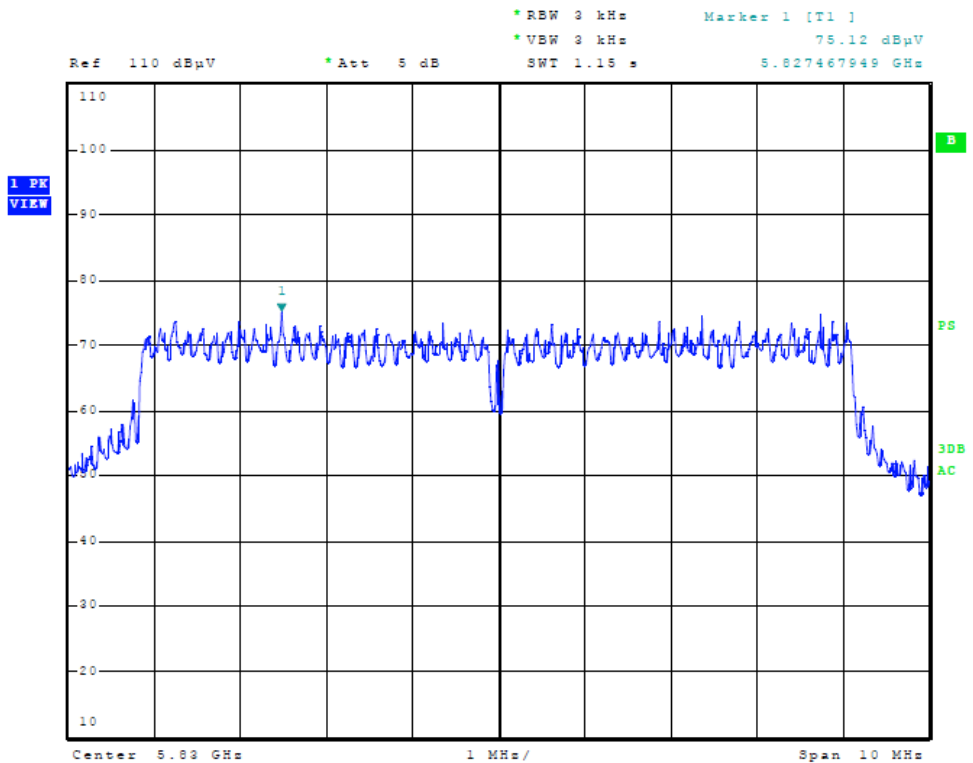

Figure Forty-six Plot of Power Spectral Density (10 MHz Mode, 5830 MHz)

Transmitter Radiated Emissions Data

Transmitter Radiated Emission (Worst-Case)

Frequency in MHz	FSM Horz. (dBµV)	FSM Vert. (dBµV)	A.F. (dB/m)	Amp. Gain (dB)	RFS Horz. @ 3m (dBµV/m)	RFS Vert. @ 3m (dBµV/m)	Limit @ 3m (dBµV/m)
5740.0	87.2	73.4	39.6	0	126.8	113.0	--
11480.0	20.4	20.3	39.9	25	35.3	35.2	54.0
17220.0	19.9	19.8	45.1	25	40.0	39.9	54.0
22960.0	12.1	11.2	37.2	25	24.3	23.4	54.0
28700.0	10.8	11.0	41.9	25	27.7	27.9	54.0
5785.0	86.4	72.8	39.3	0	125.7	112.1	--
11570.0	21.3	20.5	39.9	25	36.2	35.4	54.0
17355.0	20.1	19.5	45.1	25	40.2	39.6	54.0
23140.0	11.1	10.1	37.0	25	23.1	22.1	54.0
28925.0	10.0	9.9	37.2	25	22.2	22.1	54.0
5830.0	86.2	71.5	39.4	0	125.6	110.9	--
11660.0	21.3	20.9	39.9	25	36.2	35.8	54.0
17490.0	20.5	19.3	47.5	25	43.0	41.8	54.0
23320.0	10.8	10.0	36.8	25	22.6	21.8	54.0
29150.0	10.1	9.5	37.1	25	22.2	21.6	54.0
5745.0	83.2	67.2	39.6	0	122.8	106.8	--
11490.0	20.2	20.2	39.9	25	35.1	35.1	54.0
17235.0	19.8	19.7	45.1	25	39.9	39.8	54.0
22980.0	9.0	9.3	37.2	25	21.2	21.5	54.0
28725.0	10.2	11.1	41.9	25	27.1	28.0	54.0
5785.0	82.6	66.7	39.3	0	121.9	106.0	--
11570.0	21.5	21.4	39.9	25	36.4	36.3	54.0
17355.0	20.7	20.7	45.1	25	40.8	40.8	54.0
23140.0	8.0	8.0	37.0	25	20.0	20.0	54.0
28925.0	10.1	9.8	37.2	25	22.3	22.0	54.0
5825.0	82.2	65.3	39.4	0	121.6	104.7	--
11650.0	22.3	21.9	39.9	25	37.2	36.8	54.0
17475.0	20.7	20.5	47.5	25	43.2	43.0	54.0
23300.0	8.1	8.0	36.8	25	19.9	19.8	54.0
29125.0	10.0	9.3	37.1	25	22.1	21.4	54.0

Other emissions present had amplitudes at least 20 dB below the limit.

Summary of Results for Radiated Emissions of Intentional Radiator 15.247

The EUT demonstrated compliance with the radiated emissions requirements of CFR47 Part 15.247 with highest emission level measured of 126.8 dB μ V/m. The EUT demonstrated a minimum margin of 10.8 dB below the harmonic emissions requirements. The EUT demonstrated compliance with the radiated emissions requirements for CFR47 Part 15.247 Intentional Radiators. There are no other significantly measurable emissions in the restricted bands other than those recorded in this report. Other emissions were present with amplitudes at least 20 dB below the requirements. The specifications of 15.247 were met; there are no deviations or exceptions to the requirements.

Statement of Modifications and Deviations

No modifications to the EUT were required for the unit to demonstrate compliance with the CFR47 Part 15C emissions standards. There were no deviations to the specifications.



NVLAP Lab Code 200087-0

Annex

- Annex A Measurement Uncertainty Calculations
- Annex B Rogers Labs Test Equipment List
- Annex C Rogers Qualifications
- Annex D FCC Site Registration Letter
- Annex E Industry Canada Site Registration Letter

Annex A Measurement Uncertainty Calculations

Radiated Emissions Measurement Uncertainty Calculation

Measurement of vertically polarized radiated field strength over the frequency range 30 MHz to 1 GHz on an open area test site at 3m and 10m includes following uncertainty:

Contribution	Probability Distribution	Uncertainty (dB)
Antenna factor calibration	normal (k = 2)	±0.58
Cable loss calibration	normal (k = 2)	±0.2
Receiver specification	rectangular	±1.0
Antenna directivity	rectangular	±0.1
Antenna factor variation with height	rectangular	±2.0
Antenna factor frequency interpolation	rectangular	±0.1
Measurement distance variation	rectangular	±0.2
Site Imperfections	rectangular	±1.5
Combined standard uncertainty $u_c(y)$ is		

$$U_c(y) = \pm \sqrt{\left[\frac{1.0}{2}\right]^2 + \left[\frac{0.2}{2}\right]^2 + \left[\frac{1.0^2 + 0.1^2 + 2.0^2 + 0.1^2 + 0.2^2 + 1.5^2}{3}\right]}$$

$$U_c(y) = \pm 1.6 \text{ dB}$$

It is probable that $u_c(y) / s(q_k) > 3$, where $s(q_k)$ is estimated standard deviation from a sample of n readings unless the repeatability of the EUT is particularly poor, and a coverage factor of $k = 2$ will ensure that the level of confidence will be approximately 95%, therefore:

$$s(q_k) = \sqrt{\frac{1}{(n-1)} \sum_{k=1}^n (q_k - \bar{q})^2}$$

$$U = 2 U_c(y) = 2 \times \pm 1.6 \text{ dB} = \pm 3.2 \text{ dB}$$

Notes:

- 1.1 Uncertainties for the antenna and cable were estimated, based on a normal probability distribution with $k = 2$.
- 1.2 The receiver uncertainty was obtained from the manufacturer's specification for which a rectangular distribution was assumed.
- 1.3 The antenna factor uncertainty does not take account of antenna directivity.
- 1.4 The antenna factor varies with height and since the height was not always the same in use as when the antenna was calibrated an additional uncertainty is added.
- 1.5 The uncertainty in the measurement distance is relatively small but has some effect on the received signal strength. The increase in measurement distance as the antenna height is increased is an inevitable consequence of the test method and is therefore not considered a contribution to uncertainty.
- 1.6 Site imperfections are difficult to quantify but may include the following contributions:
 - Unwanted reflections from adjacent objects.
 - Ground plane imperfections: reflection coefficient, flatness, and edge effects.
 - Losses or reflections from "transparent" cabins for the EUT or site coverings.
 - Earth currents in antenna cable (mainly effect Biconical antennas).

The specified limits for the difference between measured site attenuation and the theoretical value (± 4 dB) were not included in total since the measurement of site attenuation includes uncertainty contributions already allowed for in this budget, such as antenna factor.

Conducted Measurements Uncertainty Calculation

Measurement of conducted emissions over the frequency range 9 kHz to 30 MHz includes following uncertainty:

Contribution	Probability Distribution	Uncertainty (dB)
Receiver specification	rectangular	± 1.5
LISN coupling specification	rectangular	± 1.5
Cable and input attenuator calibration	normal (k=2)	± 0.5
Combined standard uncertainty $u_c(y)$ is		

$$U_c(y) = \pm \sqrt{\left[\frac{0.5}{2}\right]^2 + \frac{1.5^2 + 1.5^2}{3}}$$

$$U_c(y) = \pm 1.2 \text{ dB}$$

As with radiated field strength uncertainty, it is probable that $u_c(y) / s(q_k) > 3$ and a coverage factor of $k = 2$ will suffice, therefore:

$$U = 2 U_c(y) = 2 \times \pm 1.2 \text{ dB} = \pm 2.4 \text{ dB}$$



Annex B Rogers Labs Test Equipment List

The test equipment used is maintained in calibration and good operating condition. Use of this calibrated equipment ensures measurements are traceable to national standards.

List of Test Equipment	Date of Calibration
Oscilloscope Scope: Tektronix 2230	2/10
Wattmeter: Bird 43 with Load Bird 8085	2/10
Power Supplies: Sorensen SRL 20-25, SRL 40-25, DCR 150, DCR 140	2/10
H/V Power Supply: Fluke Model: 408B (SN: 573)	2/10
R.F. Generator: HP 606A	2/10
R.F. Generator: HP 8614A	2/10
R.F. Generator: HP 8640B	2/10
Spectrum Analyzer: Rohde & Schwarz ESU40	5/10
Spectrum Analyzer: HP 8562A,	5/10
Mixers: 11517A, 11970A, 11970K, 11970U, 11970V, 11970W	
HP Adapters: 11518, 11519, 11520	
Spectrum Analyzer: HP 8591EM	5/10
Frequency Counter: Leader LDC825	2/10
Antenna: EMCO Biconilog Model: 3143	5/10
Antenna: EMCO Log Periodic Model: 3147	10/10
Antenna: Antenna Research Biconical Model: BCD 235	10/10
Antenna: EMCO Dipole Set 3121C	2/10
Antenna: C.D. B-101	2/10
Antenna: Solar 9229-1 & 9230-1	2/10
Antenna: EMCO 6509	2/10
Audio Oscillator: H.P. 201CD	2/10
R.F. Power Amp 65W Model: 470-A-1010	2/10
R.F. Power Amp 50W M185- 10-501	2/10
R.F. Preamp CPPA-102	2/10
LISN 50 μ Hy/50 ohm/0.1 μ f	10/10
LISN Compliance Eng. 240/20	2/10
LISN Fischer Custom Communications FCC-LISN-50-16-2-08	2/10
Peavey Power Amp Model: IPS 801	2/10
Power Amp A.R. Model: 10W 1010M7	2/10
Power Amp EIN Model: A301	2/10
ELGAR Model: 1751	2/10
ELGAR Model: TG 704A-3D	2/10
ESD Test Set 2010i	2/10
Fast Transient Burst Generator Model: EFT/B-101	2/10
Current Probe: Singer CP-105	2/10
Current Probe: Solar 9108-1N	2/10
Field Intensity Meter: EFM-018	2/10
KEYTEK Ecat Surge Generator	2/10
Shielded Room 5 M x 3 M x 3.0 M	



Annex C Rogers Qualifications

Scot D. Rogers, Engineer

Rogers Labs, Inc.

Mr. Rogers has approximately 17 years experience in the field of electronics. Engineering experience includes six years in the automated controls industry and remaining years working with the design, development and testing of radio communications and electronic equipment.

Positions Held

Systems Engineer: A/C Controls Mfg. Co., Inc. 6 Years

Electrical Engineer: Rogers Consulting Labs, Inc. 5 Years

Electrical Engineer: Rogers Labs, Inc. Current

Educational Background

- 1) Bachelor of Science Degree in Electrical Engineering from Kansas State University.
- 2) Bachelor of Science Degree in Business Administration Kansas State University.
- 3) Several Specialized Training courses and seminars pertaining to Microprocessors and Software programming.

Scot D. Rogers



NVLAP Lab Code 200087-0

Annex D FCC Site Registration Letter

FEDERAL COMMUNICATIONS COMMISSION

**Laboratory Division
7435 Oakland Mills Road
Columbia, MD 21046**

May 18, 2010

Registration Number: 90910

Rogers Labs, Inc.
4405 West 259th Terrace,
Louisburg, KS 66053

Attention: Scot Rogers,

Re: Measurement facility located at Louisburg
~~3 & 10 meter site~~
Date of Renewal: May 18, 2010

Dear Sir or Madam:

Your request for renewal of the registration of the subject measurement facility has been received. The information submitted has been placed in your file and the registration has been renewed. The name of your organization will remain on the list of facilities whose measurement data will be accepted in conjunction with applications for Certification under Parts 15 or 18 of the Commission's Rules. Please note that the file must be updated for any changes made to the facility and the registration must be renewed at least every three years.

Measurement facilities that have indicated that they are available to the public to perform measurement services on a fee basis may be found on the FCC website www.fcc.gov under E-Filing, OET Equipment Authorization Electronic Filing, Test Firms.

Sincerely,

Phyllis Farrish
Industry Analyst



NVLAP Lab Code 200087-0

Annex E Industry Canada Site Registration Letter



May 26, 2010

OUR FILE: 46405-3041
Submission No: 140719

Rogers Labs Inc.

4405 West 259th Terrace
Louisburg, KY, 66053
USA

Attention: Mr. Scot D. Rogers

Dear Sir/Madame:

The Bureau has received your application for the renewal of a 3/10m OATS. Be advised that the information received was satisfactory to Industry Canada. The following number(s) is now associated to the site(s) for which registration / renewal was sought (**3041A-1**). Please reference the appropriate site number in the body of test reports containing measurements performed on the site. In addition, please keep for your records the following information;

- Your primary code is: **3041**
- The company number associated to the site(s) located at the above address is: **3041A**

Furthermore, to obtain or renew a unique site number, the applicant shall demonstrate that the site has been accredited to ANSI C63.4-2003 or later. A scope of accreditation indicating the accreditation by a recognized accreditation body to ANSI C63.4-2003 or later shall be accepted. Please indicate in a letter the previous assigned site number if applicable and the type of site (example: 3 metre OATS or 3 metre chamber). If the test facility is not accredited to ANSI C63.4-2003 or later, the test facility shall submit test data demonstrating full compliance with the ANSI standard. The Bureau will evaluate the filing to determine if recognition shall be granted.

The frequency for re-validation of the test site and the information that is required to be filed or retained by the testing party shall comply with the requirements established by the accrediting organization. However, in all cases, test site re-validation shall occur on an interval not to exceed two years. There is no fee or form associated with an OATS filing. OATS submissions are encouraged to be submitted electronically to the Bureau using the following URL;

http://strategis.ic.gc.ca/epic/internet/inceb-bhst.nsf/en/h_tt00052e.html.

If you have any questions, you may contact the Bureau by e-mail at certification.bureau@ic.gc.ca Please reference our file and submission number above for all correspondence.

Yours sincerely,

Dalwinder Gill
For: Wireless Laboratory Manager
Certification and Engineering Bureau
3701 Carling Ave., Building 94
P.O. Box 11490, Station "H"
Ottawa, Ontario K2H 8S2
Email: dalwinder.gill@ic.gc.ca
Tel. No. (613) 998-3363
Fax. No. (613) 990-4752

Rogers Labs, Inc.
4405 W. 259th Terrace
Louisburg, KS 66053
Phone/Fax: (913) 837-3214
Revision 1

Mikrotikls SIA
Model: SXT-5D
Test #: 101119
Test to: CFR47 (15.247)
File: Mikrotikls SXT-5DTestRpt

SN: 290E015C58D7/042
FCC ID#: TV7SXT-5D
Date: January 5, 2011
Page 50 of 50