

ROGERS LABS, INC.

4405 West 259th Terrace
Louisburg, KS 66053
Phone / Fax (913) 837-3214

**47 CFR, PART 15E - Part 15E 15.407 (New Rules)
Unlicensed National Information Infrastructure (U-NII)
and Industry Canada RSS-247 Issue 2
License-Exempt Local Area Network (LE-LAN) Devices
Application For Grant of Certification**

Model: RBD53GR-5HacD2HnD-US&R11e-LTE6
License-Exempt U-NII-1 and U-NII-3 Local Area Network equipment

FCC ID: TV7RBD53-5ACD2ND

IC: 7442A-D53AC

Mikrotikls SIA

Brivibas gatve 214i
Riga Latvia LV-1039

FCC Site Registration: US5305
IC Test Site Registration: 3041A-1

Test Report Number: 200115

Test Date: January 15, 2020

Authorized Signatory: *Scot D Rogers*
Scot D. Rogers

This report shall not be reproduced except in full, without the written approval of the laboratory.
This report must not be used by the client to claim product certification, approval, or
endorsement by NVLAP, NIST, or any agency of the U.S. Government.

Table of Contents

TABLE OF CONTENTS.....	2
REVISIONS.....	8
FOREWORD.....	9
OPINION / INTERPRETATION OF RESULTS	10
EQUIPMENT TESTED.....	16
Equipment Function and Configuration.....	17
Equipment Configuration.....	18
APPLICANT COMPANY INFORMATION	19
EQUIPMENT INFORMATION.....	19
Accessories	19
Product Details	20
Table for Filed Antennas	21
Antenna	21
Table for Carrier Frequencies	22
Table for Test Modes	23
APPLICATION FOR CERTIFICATION.....	25
APPLICABLE STANDARDS & TEST PROCEDURES	26
TESTING PROCEDURES	26
AC Line Conducted Emission Test Procedure	26
Radiated Emission Test Procedure.....	27
Antenna Port Conducted Emission Test Procedure.....	27
Diagram 1 Test arrangement for Conducted emissions	28
Diagram 2 Test arrangement for radiated emissions of tabletop equipment.....	29

Diagram 3 Test arrangement for radiated emissions tested on Open Area Test Site (OATS)30

Diagram 4 Test arrangement for Antenna Port Conducted emissions31

TEST SITE LOCATIONS 31

UNITS OF MEASUREMENTS 32

ENVIRONMENTAL CONDITIONS..... 32

STATEMENT OF MODIFICATIONS AND DEVIATIONS 32

INTENTIONAL RADIATORS..... 33

Antenna Requirements33

Restricted Bands of Operation.....33

Table 1 Radiated Harmonic Emissions in Restricted Bands Data Mode 5 (802.11a).....34

Table 2 Radiated Harmonic Emissions in Restricted Bands Data Mode 6 (802.11n)35

Table 3 Radiated Harmonic Emissions in Restricted Bands Data Mode 7 (802.11n40)36

Table 4 Radiated Harmonic Emissions in Restricted Bands Data Mode 8 (802.11ac).....36

Table 5 Radiated Harmonic Emissions in Restricted Bands Data Mode 9 (802.11a).....37

Table 6 Radiated Harmonic Emissions in Restricted Bands Data Mode 10 (802.11n)37

Table 7 Radiated Harmonic Emissions in Restricted Bands Data Mode 11 (802.11n40)38

Table 8 Radiated Harmonic Emissions in Restricted Bands Data Mode 12 (802.11ac).....38

Summary of Results for Radiated Emissions in Restricted Bands38

AC Line Conducted Emissions Procedure39

Figure 1 AC Line Conducted Emissions Line 140

Figure 2 AC Line Conducted Emissions Line 241

Table 9 AC Line Conducted Emissions Data (Highest Emissions Line L1)42

Table 10 AC Line Conducted Emissions Data (Highest Emissions Line L2)42

Summary of Results for AC Line Conducted Emissions43

General Radiated Emissions Procedure.....43

Table 11 General Radiated Emissions from EUT Data (Highest Emissions)44

Summary of Results for General Radiated Emissions44

Operation in the 5150-5250 and 5725-5850 MHz Frequency U-NII-1 and U-NII-3 Bands45

Figure 3 Plot of Transmitter Emissions (Across 5150-5250 MHz Band, Chain 0, 802.11a).....47

Figure 4 Plot of Transmitter Emissions (Across 5150-5250 MHz Band, Chain 1, 802.11a).....48

Figure 5 Plot of Transmitter Emissions (Across 5150-5250 MHz Band, Chain 0, 802.11n)49

Figure 6 Plot of Transmitter Emissions (Across 5150-5250 MHz Band, Chain 1, 802.11n)50

Figure 7 Plot of Transmitter Emissions (Across 5150-5250 MHz Band, Chain 0, 802.11n40)51

Figure 8 Plot of Transmitter Emissions (Across 5150-5250 MHz Band, Chain 1, 802.11n40)52

Figure 9 Plot of Transmitter Emissions (Across 5150-5250 MHz Band, Chain 0, 802.11ac).....53

Figure 10 Plot of Transmitter Emissions (Across 5150-5250 MHz Band, Chain 1, 802.11ac).....54

Figure 11 Plot of Transmitter Low Band Edge (5150-5250 MHz Band, Chain 0, 802.11a)55

Figure 12 Plot of Transmitter Low Band Edge (5150-5250 MHz Band, Chain 1, 802.11a)56

Figure 13 Plot of Transmitter Low Band Edge (5150-5250 MHz Band, Chain 0, 802.11n).....57

Figure 14 Plot of Transmitter Low Band Edge (5150-5250 MHz Band, Chain 1, 802.11n).....58

Figure 15 Plot of Transmitter Low Band Edge (5150-5250 MHz Band, Chain 0, 802.11n40).....59

Figure 16 Plot of Transmitter Low Band Edge (5150-5250 MHz Band, Chain 1, 802.11n40).....60

Figure 17 Plot of Transmitter Low Band Edge (5150-5250 MHz Band, Chain 0, 802.11ac)61

Figure 18 Plot of Transmitter Low Band Edge (5150-5250 MHz Band, Chain 1, 802.11ac)62

Figure 19 Plot of Transmitter High Band Edge (5150-5250 MHz Band, Chain 0, 802.11a).....63

Figure 20 Plot of Transmitter High Band Edge (5150-5250 MHz Band, Chain 1, 802.11a).....64

Figure 21 Plot of Transmitter High Band Edge (5150-5250 MHz Band, Chain 0, 802.11n)65

Figure 22 Plot of Transmitter High Band Edge (5150-5250 MHz Band, Chain 1, 802.11n)66

Figure 23 Plot of Transmitter High Band Edge (5150-5250 MHz Band, Chain 0, 802.11n40)67

Figure 24 Plot of Transmitter High Band Edge (5150-5250 MHz Band, Chain 1, 802.11n40)68

Figure 25 Plot of Transmitter High Band Edge (5150-5250 MHz Band, Chain 0, 802.11ac).....69

Figure 26 Plot of Transmitter High Band Edge (5150-5250 MHz Band, Chain 1, 802.11ac).....70

Figure 27 Plot of Transmitter Emissions (5150-5250 MHz Band, 802.11a, Chain 0, 99% OBW)71

Figure 28 Plot of Transmitter Emissions (5150-5250 MHz Band, 802.11a, Chain 1, 99% OBW)72

Figure 29 Plot of Transmitter Emissions (5150-5250 MHz Band, 802.11a, Chain 0, 26 dB OBW).....73

Figure 30 Plot of Transmitter Emissions (5150-5250 MHz Band, 802.11a, Chain 1, 26 dB OBW).....74

Figure 31 Plot of Transmitter Emissions (5150-5250 MHz Band, 802.11n, Chain 0, 99% OBW).....75

Figure 32 Plot of Transmitter Emissions (5150-5250 MHz Band, 802.11n, Chain 1, 99% OBW).....76

Figure 33 Plot of Transmitter Emissions (5150-5250 MHz Band, 802.11n, Chain 0, 26 dB OBW).....77

Figure 34 Plot of Transmitter Emissions (5150-5250 MHz Band, 802.11n, Chain 1, 26 dB OBW).....78

Figure 35 Plot of Transmitter Emissions (5150-5250 MHz Band, 802.11n40, Chain 0, 99% OBW).....79

Figure 36 Plot of Transmitter Emissions (5150-5250 MHz Band, 802.11n40, Chain 1, 99% OBW).....80

Figure 37 Plot of Transmitter Emissions (5150-5250 MHz Band, 802.11n40, Chain 0, 26 dB OBW).....81

Figure 38 Plot of Transmitter Emissions (5150-5250 MHz Band, 802.11n40, Chain 1, 26 dB OBW).....82

Figure 39 Plot of Transmitter Emissions (5150-5250 MHz Band, 802.11ac, Chain 0, 99% OBW)83

Figure 40 Plot of Transmitter Emissions (5150-5250 MHz Band, 802.11ac, Chain 1, 99% OBW)84

Figure 41 Plot of Transmitter Emissions (5150-5250 MHz Band, 802.11ac, Chain 0, 26 dB OBW)85

Figure 42 Plot of Transmitter Emissions (5150-5250 MHz Band, 802.11ac, Chain 1, 26 dB OBW)86

Figure 43 Plot of Transmitter Emissions (Across 5725-5850 MHz Band, Chain 0, 802.11a).....87

Figure 44 Plot of Transmitter Emissions (Across 5725-5850 MHz Band, Chain 1, 802.11a).....88

Figure 45 Plot of Transmitter Emissions (Across 5725-5850 MHz Band, Chain 0, 802.11n)89

Figure 46 Plot of Transmitter Emissions (Across 5725-5850 MHz Band, Chain 1, 802.11n)90

Figure 47 Plot of Transmitter Emissions (Across 5725-5850 MHz Band, Chain 0, 802.11n40)91

Figure 48 Plot of Transmitter Emissions (Across 5725-5850 MHz Band, Chain 1, 802.11n40)92

Figure 49 Plot of Transmitter Emissions (Across 5725-5850 MHz Band, Chain 0, 802.11ac).....93

Figure 50 Plot of Transmitter Emissions (Across 5725-5850 MHz Band, Chain 1, 802.11ac).....94

Figure 51 Plot of Transmitter Low Band Edge (5725-5850 MHz Band, Chain 0, 802.11a)95

Figure 52 Plot of Transmitter Low Band Edge (5725-5850 MHz Band, Chain 1, 802.11a)96

Figure 53 Plot of Transmitter Low Band Edge (5725-5850 MHz Band, Chain 0, 802.11n).....97

Figure 54 Plot of Transmitter Low Band Edge (5725-5850 MHz Band, Chain 1, 802.11n).....98

Figure 55 Plot of Transmitter Low Band Edge (5725-5850 MHz Band, Chain 0, 802.11n40).....99

Figure 56 Plot of Transmitter Low Band Edge (5725-5850 MHz Band, Chain 1, 802.11n40).....100

Figure 57 Plot of Transmitter Low Band Edge (5725-5850 MHz Band, Chain 0, 802.11ac)101

Figure 58 Plot of Transmitter Low Band Edge (5725-5850 MHz Band, Chain 1, 802.11ac)102

Figure 59 Plot of Transmitter High Band Edge (5725-5850 MHz Band, Chain 0, 802.11a).....103

Figure 60 Plot of Transmitter High Band Edge (5725-5850 MHz Band, Chain 1, 802.11a).....104

Figure 61 Plot of Transmitter High Band Edge (5725-5850 MHz Band, Chain 0, 802.11n)105

Figure 62 Plot of Transmitter High Band Edge (5725-5850 MHz Band, Chain 1, 802.11n)106

Figure 63 Plot of Transmitter High Band Edge (5725-5850 MHz Band, Chain 0, 802.11n40)107

Figure 64 Plot of Transmitter High Band Edge (5725-5850 MHz Band, Chain 1, 802.11n40)108

Figure 65 Plot of Transmitter High Band Edge (5725-5850 MHz Band, Chain 0, 802.11ac).....109

Figure 66 Plot of Transmitter High Band Edge (5725-5850 MHz Band, Chain 1, 802.11ac).....110

Figure 67 Plot of Transmitter Emissions (5725-5850 MHz Band, 802.11a, Chain 0, 99% OBW)111

Figure 68 Plot of Transmitter Emissions (5725-5850 MHz Band, 802.11a, Chain 1, 99% OBW)112

Figure 69 Plot of Transmitter Emissions (5725-5850 MHz Band, 802.11a, Chain 0, 6-dB OBW)113

Figure 70 Plot of Transmitter Emissions (5725-5850 MHz Band, 802.11a, Chain 1, 6-dB OBW)114

Figure 71 Plot of Transmitter Emissions (5725-5850 MHz Band, 802.11n, Chain 0, 99% OBW).....115

Figure 72 Plot of Transmitter Emissions (5725-5850 MHz Band, 802.11n, Chain 1, 99% OBW).....116

Figure 73 Plot of Transmitter Emissions (5725-5850 MHz Band, 802.11n, Chain 0, 6-dB OBW)117

Figure 74 Plot of Transmitter Emissions (5725-5850 MHz Band, 802.11n, Chain 1, 6-dB OBW)118

Figure 75 Plot of Transmitter Emissions (5725-5850 MHz Band, 802.11n40, Chain 0, 99% OBW)119

Figure 76 Plot of Transmitter Emissions (5725-5850 MHz Band, 802.11n40, Chain 1, 99% OBW)120

Figure 77 Plot of Transmitter Emissions (5725-5850 MHz Band, 802.11n40, Chain 0, 6-dB OBW)121

Figure 78 Plot of Transmitter Emissions (5725-5850 MHz Band, 802.11n40, Chain 1, 6-dB OBW)122

Figure 79 Plot of Transmitter Emissions (5725-5850 MHz Band, 802.11ac, Chain 0, 99% OBW)123

Figure 80 Plot of Transmitter Emissions (5725-5850 MHz Band, 802.11ac, Chain 1, 99% OBW)124

Figure 81 Plot of Transmitter Emissions (5725-5850 MHz Band, 802.11ac, Chain 0, 6-dB OBW).....125

Figure 82 Plot of Transmitter Emissions (5725-5850 MHz Band, 802.11ac, Chain 1, 6-dB OBW).....126

Transmitter Emissions Data.....127

Table 12 Transmitter Worst-case Radiated Emission (802.11a, 5150-5250 MHz Band).....127

Table 13 Transmitter Worst-case Radiated Emission (802.11n, 5150-5250 MHz Band)128

Table 14 Transmitter Worst-case Radiated Emission (802.11n40, 5150-5250 MHz Band).....129

Table 15 Transmitter Worst-case Radiated Emission (802.11ac, 5150-5250 MHz Band).....130

Table 16 Transmitter Radiated Emission (802.11a, 5725-5850 MHz Band).....131

Table 17 Transmitter Radiated Emission (802.11n, 5725-5850 MHz Band)132

Table 18 Transmitter Radiated Emission (802.11n40, 5725-5850 MHz Band)133

Table 19 Transmitter Radiated Emission (802.11ac, 5725-5850 MHz Band).....134

Table 20 FCC U-NII-1, EIRP Output Power, OBW, and PSD (Chain 0)135

Table 21 FCC U-NII-1, EIRP Output Power, OBW, and PSD (Chain 1)136

Table 22 ISSED U-NII-1, EIRP Output Power, OBW, and PSD (Chain 0)137

Table 23 ISSED U-NII-1, EIRP Output Power, OBW, and PSD (Chain 1)138

Table 24 U-NII-3, EIRP Output Power, OBW, and PSD (Chain 0)139

Table 25 U-NII-3, EIRP Output Power, OBW, and PSD (Chain 1)140

Table 26 FCC U-NII-1, EIRP Output Power and PSD (All Chains)141

Table 27 ISSED U-NII-1, EIRP Output Power and PSD (All Chains)142

Table 28 U-NII-3, EIRP Output Power and PSD (All Chains)143

Summary of Results for Transmitter Radiated Emissions of Intentional Radiator144

ANNEX..... 145

Annex A Measurement Uncertainty Calculations146

Annex B Test Equipment.....147

Annex C Rogers Qualifications149

Annex D Laboratory Certificate of Accreditation.....150

Revisions

Revision 3 Issued April 7, 2020 – updated table headings (tables 20-28) pages 135 through 143, and headings and reference for tables on pages 9 (FCC) and 10 (ISED)

Revision 2 Issued April 6, 2020 – updated table headings pages 9, 135,136,137,138,139 & 140, added reference to KDB and calculations page 45, updated country Code specific transmitter power information pages 10 and 16, added ISED data and tables 22, 23, & 27 (pages 137, 138, & 142)

Revision 1 Issued March 31, 2020

Foreword

The following information is submitted for consideration in obtaining Grants of Certification for License Exempt, Unlicensed National Information Infrastructure (U-NII) Intentional Radiator operating under 47CFR Paragraph 15E (15.407), U-NII-1 and U-NII-3, 5180-5240, and 5745-5825 MHz bands, Industry Canada RSS-247 Issue 2, LE-LAN transmitter and RSS-GEN Issue 5.

Name of Applicant: Mikrotikls SIA FRN: 0013617048
Brivibas gatve 214i
Riga Latvia LV-1039

Model: RBD53GR-5HacD2HnD-US&R11e-LTE6

FCC ID: TV7RBD53-5ACD2ND IC: 7442A-D53AC

Frequency Range: 5180-5240 MHz and 5745-5825 MHz (U-NII-1 and U-NII-3),
802.11a (20 MHz), 802.11n (20 MHz), 802.11n40 (40 MHz), and 802.11ac (80 MHz)
Authorized Antennas non-replaceable incorporated in design: Planar Inverted F Antennas (PIFA)

United States Operational modes (FCC), (Data from tables 26 and 28, pages 142 and 144)

United States Operational Mode	Total Sum EIRP Output Power (Watts)	99% OBW (kHz)
Mode 5, U-NII-1a, 20 MHz	0.330	16,538.5
Mode 6, U-NII-1n , 20 MHz	0.311	16,538.5
Mode 7, U-NII-1n40, 40 MHz	0.304	36,217.9
Mode 8, U-NII-1ac, 80 MHz	0.213	76,602.6
Mode 9, U-NII-3a, 20 MHz	0.342	16,538.5
Mode 10, U-NII-3n, 20 MHz	0.350	16,538.5
Mode 11, U-NII-3n40, 40 MHz	0.341	36,217.9
Mode 12, U-NII-3ac, 80 MHz	0.201	77,884.6

Canada Operational modes (ISED) (Data from table 27 and 28, pages 143 and 144)

Canada Operational Mode	Total Sum EIRP Output Power (Watts)	99% OBW (kHz)
Mode 5, U-NII-1a, 20 MHz	0.190	16,538.5
Mode 6, U-NII-1n , 20 MHz	0.187	16,538.5
Mode 7, U-NII-1n40, 40 MHz	0.183	36,217.9
Mode 8, U-NII-1ac, 80 MHz	0.155	76,602.6
Mode 9, U-NII-3a, 20 MHz	0.342	16,538.5
Mode 10, U-NII-3n, 20 MHz	0.350	16,538.5
Mode 11, U-NII-3n40, 40 MHz	0.341	36,217.9
Mode 12, U-NII-3ac, 80 MHz	0.201	77,884.6

This report addresses EUT Operations as Unlicensed National Information Infrastructure (U NII) transceiver using the following Transmitter modulations: and IEEE 802.11a,n,n40,ac

Opinion / Interpretation of Results

Tests Performed	Margin (dB)	Results
Restricted Frequency Bands 15.205, RSS-GEN 8.10	-0.6	Complies
AC Line Conducted 15.207, RSS-GEN 7.2.4	-11.4	Complies
Radiated Emissions 15.209, RSS-GEN 7.2.5	-3.8	Complies
Harmonic Emissions per 15.407, RSS-247	-12.6	Complies
Power Spectral Density per 15.407, RS-247	-3.8	Complies

Tests performed include

47CFR

§15.407 General technical requirements.

(a) *Power limits:*

(1) For the band 5.15-5.25 GHz.

(i) For an outdoor access point operating in the band 5.15-5.25 GHz, the maximum conducted output power over the frequency band of operation shall not exceed 1 W provided the maximum antenna gain does not exceed 6 dBi. In addition, the maximum power spectral density shall not exceed 17 dBm in any 1 megahertz band. If transmitting antennas of directional gain greater than 6 dBi are

Rogers Labs, Inc.

4405 W. 259th Terrace

Louisburg, KS 66053

Phone/Fax: (913) 837-3214

Revision 3

Mikrotikls SIA

Model: RBD53GR-5HacD2HnD-US&R11e-LTE6

Test: 200115

Test to: 47CFR, 15.407, RSS-247

File: Mikrotikls D53AC NII TstRpt 200115 r3

S/N: C65F0B82560C/002, C65F0B9B0890/002

IC: 7442A-D53AC

FCC ID: TV7RBD53-5ACD2ND

Date: April 7, 2020

Page 10 of 150

used, both the maximum conducted output power and the maximum power spectral density shall be reduced by the amount in dB that the directional gain of the antenna exceeds 6 dBi. The maximum e.i.r.p. at any elevation angle above 30 degrees as measured from the horizon must not exceed 125 mW (21 dBm).

(ii) For an indoor access point operating in the band 5.15-5.25 GHz, the maximum conducted output power over the frequency band of operation shall not exceed 1 W provided the maximum antenna gain does not exceed 6 dBi. In addition, the maximum power spectral density shall not exceed 17 dBm in any 1 megahertz band. If transmitting antennas of directional gain greater than 6 dBi are used, both the maximum conducted output power and the maximum power spectral density shall be reduced by the amount in dB that the directional gain of the antenna exceeds 6 dBi.

(iii) For fixed point-to-point access points operating in the band 5.15-5.25 GHz, the maximum conducted output power over the frequency band of operation shall not exceed 1 W. In addition, the maximum power spectral density shall not exceed 17 dBm in any 1 megahertz band. Fixed point-to-point U-NII devices may employ antennas with directional gain up to 23 dBi without any corresponding reduction in the maximum conducted output power or maximum power spectral density. For fixed point-to-point transmitters that employ a directional antenna gain greater than 23 dBi, a 1 dB reduction in maximum conducted output power and maximum power spectral density is required for each 1 dB of antenna gain in excess of 23 dBi. Fixed, point-to-point operations exclude the use of point-to-multipoint systems, omnidirectional applications, and multiple collocated transmitters transmitting the same information. The operator of the U-NII device, or if the equipment is professionally installed, the installer, is responsible for ensuring that systems employing high gain directional antennas are used exclusively for fixed, point-to-point operations.

(iv) For client devices in the 5.15-5.25 GHz band, the maximum conducted output power over the frequency band of operation shall not exceed 250 mW provided the maximum antenna gain does not exceed 6 dBi. In addition, the maximum power spectral density shall not exceed 11 dBm in any 1 megahertz band. If transmitting antennas of directional gain greater than 6 dBi are used, both the maximum conducted output power and the maximum power spectral density shall be reduced by the amount in dB that the directional gain of the antenna exceeds 6 dBi.

(2) For the 5.25-5.35 GHz and 5.47-5.725 GHz bands, the maximum conducted output power over the frequency bands of operation shall not exceed the lesser of 250 mW or $11 \text{ dBm} + 10 \log B$, where B is the 26 dB emission bandwidth in megahertz. In addition, the maximum power spectral density shall not exceed 11 dBm in any 1 megahertz band. If transmitting antennas of directional gain greater than 6 dBi are used, both the maximum conducted output power and the maximum power spectral density shall be reduced by the amount in dB that the directional gain of the antenna exceeds 6 dBi.

(3) For the band 5.725-5.85 GHz, the maximum conducted output power over the frequency band of operation shall not exceed 1 W. In addition, the maximum power spectral density shall not exceed 30 dBm in any 500-kHz band. If transmitting antennas of directional gain greater than 6 dBi are used, both the maximum conducted output power and the maximum power spectral density shall be reduced by the amount in dB that the directional gain of the antenna exceeds 6 dBi. However, fixed point-to-point U-NII devices operating in this band may employ transmitting antennas with directional gain greater than 6 dBi without any corresponding reduction in transmitter conducted power. Fixed, point-to-point operations exclude the use of point-to-multipoint systems, omnidirectional applications, and multiple collocated transmitters transmitting the same information. The operator of the U-NII device, or if the equipment is professionally installed, the installer, is responsible for ensuring that systems employing high gain directional antennas are used exclusively for fixed, point-to-point operations.

NOTE TO PARAGRAPH (a)(3): The Commission strongly recommends that parties employing U-NII devices to provide critical communications services should determine if there are any nearby Government radar systems that could affect their operation.

(4) The maximum conducted output power must be measured over any interval of continuous transmission using instrumentation calibrated in terms of an rms-equivalent voltage.

(5) The maximum power spectral density is measured as a conducted emission by direct connection of a calibrated test instrument to the equipment under test. If the device cannot be connected directly, alternative techniques acceptable to the Commission may be used. Measurements in the 5.725-5.85 GHz band are made over a reference bandwidth of 500 kHz or the 26 dB emission bandwidth of the device, whichever is less. Measurements in the 5.15-5.25 GHz, 5.25-5.35 GHz, and the 5.47-5.725 GHz bands are made over a bandwidth of 1 MHz or the 26 dB emission bandwidth of the device, whichever is less. A narrower resolution bandwidth can be used, provided that the measured power is integrated over the full reference bandwidth.

(b) *Undesirable emission limits.* Except as shown in paragraph (b)(7) of this section, the maximum emissions outside of the frequency bands of operation shall be attenuated in accordance with the following limits:

(1) For transmitters operating in the 5.15-5.25 GHz band: All emissions outside of the 5.15-5.35 GHz band shall not exceed an e.i.r.p. of -27 dBm/MHz.

(2) For transmitters operating in the 5.25-5.35 GHz band: All emissions outside of the 5.15-5.35 GHz band shall not exceed an e.i.r.p. of -27 dBm/MHz.

(3) For transmitters operating in the 5.47-5.725 GHz band: All emissions outside of the 5.47-5.725 GHz band shall not exceed an e.i.r.p. of -27 dBm/MHz.

(4) For transmitters operating in the 5.725-5.85 GHz band:

(i) All emissions shall be limited to a level of -27 dBm/MHz at 75 MHz or more above or below the band edge increasing linearly to 10 dBm/MHz at 25 MHz above or below the band edge, and from 25 MHz above or below the band edge increasing linearly to a level of 15.6 dBm/MHz at 5 MHz above or below the band edge, and from 5 MHz above or below the band edge increasing linearly to a level of 27 dBm/MHz at the band edge.

(ii) Devices certified before March 2, 2017 with antenna gain greater than 10 dBi may demonstrate compliance with the emission limits in §15.247(d), but manufacturing, marketing and importing of devices certified under this alternative must cease by March 2, 2018. Devices certified before March 2, 2018 with antenna gain of 10 dBi or less may demonstrate compliance with the emission limits in §15.247(d), but manufacturing, marketing and importing of devices certified under this alternative must cease before March 2, 2020.

(5) The emission measurements shall be performed using a minimum resolution bandwidth of 1 MHz. A lower resolution bandwidth may be employed near the band edge, when necessary, provided the measured energy is integrated to show the total power over 1 MHz.

(6) Unwanted emissions below 1 GHz must comply with the general field strength limits set forth in §15.209. Further, any U-NII devices using an AC power line are required to comply also with the conducted limits set forth in §15.207.

(7) The provisions of §15.205 apply to intentional radiators operating under this section.

(8) When measuring the emission limits, the nominal carrier frequency shall be adjusted as close to the upper and lower frequency band edges as the design of the equipment permits.

(c) The device shall automatically discontinue transmission in case of either absence of information to transmit or operational failure. These provisions are not intended to preclude the transmission of control or signalling information or the use of repetitive codes used by certain digital technologies to complete frame or burst intervals. Applicants shall include in their application for equipment authorization a description of how this requirement is met.

(d) [Reserved]

(e) Within the 5.725-5.85 GHz band, the minimum 6 dB bandwidth of U-NII devices shall be at least 500 kHz.

(f) U-NII devices are subject to the radio frequency radiation exposure requirements specified in §1.1307(b), §2.1091 and §2.1093 of this chapter, as appropriate. All equipment shall be considered to operate in a "general population/uncontrolled" environment. Applications for equipment authorization of devices operating under this section must contain a statement confirming compliance with these requirements for both fundamental emissions and unwanted emissions. Technical information showing the basis for this statement must be submitted to the Commission upon request.

- (g) Manufacturers of U-NII devices are responsible for ensuring frequency stability such that an emission is maintained within the band of operation under all conditions of normal operation as specified in the users manual.
- (h) Transmit Power Control (TPC) and Dynamic Frequency Selection (DFS).
- (1) Transmit power control (TPC). U-NII devices operating in the 5.25-5.35 GHz band and the 5.47-5.725 GHz band shall employ a TPC mechanism. The U-NII device is required to have the capability to operate at least 6 dB below the mean EIRP value of 30 dBm. A TPC mechanism is not required for systems with an e.i.r.p. of less than 500 mW.
- (2) Radar Detection Function of Dynamic Frequency Selection (DFS). U-NII devices operating with any part of its 26 dB emission bandwidth in the 5.25-5.35 GHz and 5.47-5.725 GHz bands shall employ a DFS radar detection mechanism to detect the presence of radar systems and to avoid co-channel operation with radar systems. Operators shall only use equipment with a DFS mechanism that is turned on when operating in these bands. The device must sense for radar signals at 100 percent of its emission bandwidth. The minimum DFS detection threshold for devices with a maximum e.i.r.p. of 200 mW to 1 W is -64 dBm. For devices that operate with less than 200 mW e.i.r.p. and a power spectral density of less than 10 dBm in a 1 MHz band, the minimum detection threshold is -62 dBm. The detection threshold is the received power averaged over 1 microsecond referenced to a 0 dBi antenna. For the initial channel setting, the manufacturers shall be permitted to provide for either random channel selection or manual channel selection.
- (i) Operational Modes. The DFS requirement applies to the following operational modes:
- (A) The requirement for channel availability check time applies in the master operational mode.
- (B) The requirement for channel move time applies in both the master and slave operational modes.
- (ii) Channel Availability Check Time. A U-NII device shall check if there is a radar system already operating on the channel before it can initiate a transmission on a channel and when it has to move to a new channel. The U-NII device may start using the channel if no radar signal with a power level greater than the interference threshold values listed in paragraph (h)(2) of this section, is detected within 60 seconds.
- (iii) Channel Move Time. After a radar's presence is detected, all transmissions shall cease on the operating channel within 10 seconds. Transmissions during this period shall consist of normal traffic for a maximum of 200 ms after detection of the radar signal. In addition, intermittent management and control signals can be sent during the remaining time to facilitate vacating the operating channel.
- (iv) Non-occupancy Period. A channel that has been flagged as containing a radar system, either by a channel availability check or in-service monitoring, is subject to a non-occupancy period of at least 30 minutes. The non-occupancy period starts at the time when the radar system is detected.
- (i) *Device Security*. All U-NII devices must contain security features to protect against modification of software by unauthorized parties.
- (1) Manufacturers must implement security features in any digitally modulated devices capable of operating in any of the U-NII bands, so that third parties are not able to reprogram the device to operate outside the parameters for which the device was certified. The software must prevent the user from operating the transmitter with operating frequencies, output power, modulation types or other radio frequency parameters outside those that were approved for the device. Manufacturers may use means including, but not limited to the use of a private network that allows only authenticated users to download software, electronic signatures in software or coding in hardware that is decoded by software to verify that new software can be legally loaded into a device to meet these requirements and must describe the methods in their application for equipment authorization.
- (2) Manufacturers must take steps to ensure that DFS functionality cannot be disabled by the operator of the U-NII device.
- (j) *Operator Filing Requirement*: Before deploying an aggregate total of more than one thousand outdoor access points within the 5.15-5.25 GHz band, parties must submit a letter to the Commission acknowledging that, should harmful interference to licensed services in this band occur, they will be required to take corrective action. Corrective actions may include reducing power, turning off devices, changing frequency bands, and/or further reducing power radiated in the vertical

direction. This material shall be submitted to Laboratory Division, Office of Engineering and Technology, Federal Communications Commission, 7435 Oakland Mills Road, Columbia, MD 21046. Attn: U-NII Coordination, or via Web site at <https://www.fcc.gov/labhelp> with the SUBJECT LINE: "U-NII-1 Filing".

RSS-247 Issue 2

6. Technical requirements for licence-exempt local area network devices and digital transmission systems operating in the 5 GHz band

This section provides standards for Licence-Exempt Local Area Network (LE-LAN) devices operating in the bands 5150-5250 MHz, 5250-5350 MHz, 5470-5600 MHz, 5650-5725 MHz and 5725-5850 MHz and for DTSs operating in the band 5725-5850 MHz that employ digital modulation technology, but are not designed for LE-LAN operation.

Devices with occupied bandwidths which overlap different bands shall comply with all operational requirements for each band.

6.1 Types of modulation

Equipment shall employ digital modulation.

6.2 Power and unwanted emissions limits

The output power and e.i.r.p. of the equipment wanted emission shall be measured in terms of average value.

The power and e.i.r.p. of the equipment unwanted emission shall be measured in peak value.

However, the equipment is required to comply with the provisions in RSS-Gen with respect to emissions falling within restricted frequency bands which are listed in the same standard.

If the transmission is in bursts, the provisions of RSS-Gen for pulsed operation shall apply.

The outermost carrier frequencies or channels shall be used when measuring unwanted emissions.

Such carrier or channel centre frequencies are to be indicated in the test report.

6.2.1 Frequency band 5150-5250 MHz

LE-LAN devices are restricted to indoor operation only in the band 5150-5250 MHz. However, original equipment manufacturer (OEM) devices, which are installed in vehicles by vehicle manufacturers, are permitted.

6.2.1.1 Power limits

For OEM devices installed in vehicles, the maximum e.i.r.p. shall not exceed 30 mW or $1.76 + 10 \log_{10} B$, dBm, whichever is less. Devices shall implement transmitter power control (TPC) in order to have the capability to operate at least 3 dB below the maximum permitted e.i.r.p. of 30 mW.

For other devices, the maximum e.i.r.p. shall not exceed 200 mW or $10 + 10 \log_{10} B$, dBm, whichever power is less. B is the 99% emission bandwidth in megahertz. The e.i.r.p. spectral density shall not exceed 10 dBm in any 1.0 MHz band.

6.2.1.2 Unwanted emission limits

For transmitters with operating frequencies in the band 5150-5250 MHz, all emissions outside the band 5150-5350 MHz shall not exceed -27 dBm/MHz e.i.r.p. Any unwanted emissions that fall into the band 5250-5350 MHz shall be attenuated below the channel power by at least 26 dB, when measured using a resolution bandwidth between 1 and 5% of the occupied bandwidth (i.e. 99% bandwidth), above 5250 MHz. The 26 dB bandwidth may fall into the 5250-5350 MHz band; however, if the occupied bandwidth also falls within the 5250-5350 MHz band, the transmission is considered as intentional and the devices shall comply with all requirements in the band 5250-5350 MHz including implementing dynamic frequency selection (DFS) and TPC, on the portion of the emission that resides in the 5250-5350 MHz band.

6.2.4 Frequency band 5725-5850 MHz

6.2.4.1 Power limits

For equipment operating in the band 5725-5850 MHz, the minimum 6 dB bandwidth shall be at least 500 kHz.

The maximum conducted output power shall not exceed 1 W. The output power spectral density shall not exceed 30 dBm in any 500 kHz band. If transmitting antennas of directional gain greater than 6 dBi are used, both the maximum conducted output power and the output power spectral density shall be reduced by the amount in dB that the directional gain of the antenna exceeds 6 dBi. However, fixed point-to-point devices operating in this band may employ transmitting antennas with directional gain greater than 6 dBi without any corresponding reduction in transmitter conducted power. Fixed point-to-point operations exclude the use of point-to-multipoint systems, omnidirectional applications and multiple collocated transmitters transmitting the same information.

6.2.4.2 Unwanted emission limits

Devices operating in the band 5725-5850 MHz with antenna gain greater than 10 dBi can have unwanted emissions that comply with either the limits in this section or in section 5.5 until six (6) months after the publication date of this standard for certification. Certified devices that do not comply with emission limits in this section shall not be manufactured, imported, distributed, leased, offered for sale or sold after April 1, 2018.

Devices operating in the band 5725-5850 MHz with antenna gain of 10 dBi or less can have unwanted emissions that comply with either the limits in this section or in section 5.5 until April 1, 2018 for certification. Certified devices that do not comply with emission limits in this section shall not be manufactured, imported, distributed, leased, offered for sale or sold after April 1, 2020.

Devices operating in the band 5725-5850 MHz shall have e.i.r.p. of unwanted emissions comply with the following:

- a) 27 dBm/MHz at frequencies from the band edges decreasing linearly to 15.6 dBm/MHz at 5 MHz above or below the band edges;
- b) 15.6 dBm/MHz at 5 MHz above or below the band edges decreasing linearly to 10 dBm/MHz at 25 MHz above or below the band edges;
- c) 10 dBm/MHz at 25 MHz above or below the band edges decreasing linearly to -27 dBm/MHz at 75 MHz above or below the band edges; and
- d) -27 dBm/MHz at frequencies more than 75 MHz above or below the band edges.

Equipment Tested

<u>Equipment</u>	<u>Model</u>	<u>Serial Number</u>
EUT	RBD53GR-5HacD2HnD-US&R11e-LTE6	C65F0B82560C/002
EUT #2	RBD53GR-5HacD2HnD-US&R11e-LTE6	C65F0B9B0890/002
AC Adapter	SAW30-240-1200U R2A	N/A
Computer	Dell Latitude E6520	6CB35Q1

Test results in this report relate only to the items tested

Operational communication modes

Mode	Transmitter Operation
1	802.11b (DSSS)
2	802.11g (OFDM)
3	802.11n (MCS)
4	802.11n40 (MCS32)
5	5180-5240 MHz, 802.11a (OFDM)
6	5180-5240 MHz, 802.11n (MCS7)
7	5190-5243 MHz, 802.11n40 (MCS32)
8	5210 MHz, 802.11ac (QAM)
9	5745-5825 MHz, 802.11a (OFDM)
10	5745-5825 MHz, 802.11n (MCS7)
11	5755-5795 MHz, 802.11n40 (MCS32)
12	5775 MHz, 802.11ac (QAM)

Software Version: 6.47/beta 18

Power setting: modes 1-4 (16 dBm each chain), modes 5-12 (19 dBm each chain FCC), modes 5-8 (16 dBm each chain ISED) modes 9-12 (19 dBm each chain ISED) country Code specific

Antennas: 2.4 GHz 3-dBi, 5GHz 5.5-dBi Planar Inverted F Antennas (PIFA)

This report addresses EUT 5 GHz U-NII transmitter operation in modes 5 through 12. Test results in this report relate only to the items tested.

Equipment Function and Configuration

The EUT is a 2.4 GHz and 5 GHz IEEE 802.11 Digital Transceiver system. The design provides 802.11b/g/n/n40 operational capabilities across the 2412-2462 MHz band as Digital Transmissions System, 802.11a/n/n4/ac 5150-5250 MHz U-NII-1, and 802.11a/n/n4/ac 5725-5850 MHz U-NII-3. The system provides wireless communications with compatible equipment operating on the 2.4 and 5 GHz bands using DSSS, OFDM, Modulation and Coding Schemes (MCS), and Quadrature amplitude modulation (QAM) modulations. The EUT offers broadband wireless connectivity to transmit and receive data. The device contains a certified LTE transceiver module (FCC ID: TV7R11ELTE6, IC: 7442A-R11ELTE6). The design utilizes integral PIFA antenna systems as documented in this filing. The EUT requires direct current power supplied from Direct Current supply (AC/DC adapter). The design incorporates a micro SIM card port, USB port and five RJ45 network ports for communications and interfacing. For testing purposes, the EUT was configured as directed by the manufacturer and communicating with the laptop computer through a network interface port. Manufacturer provided test software was installed on the computer which provided control of the transmitter functions. This configuration provided operational control of the EUT and communication interface between the EUT and supporting computer system. The test software enabled near 100% transmit duty cycle for testing purposes. The design provides no other interfacing options than those presented in this report. Two samples were provided for testing, one as production equipment and the second modified by replacing the integral antenna systems with radio frequency connectors (SMA RF connector). The RF connector allowed testing of transmitter performance at the transmitter antenna port. For testing purposes, the RBD53GR-5HacD2HnD-US&R11e-LTE6 test sample was configured to transmit in available data modes receiving power from the manufacturer provided AC/DC power adapter as presented below. As requested by the manufacturer the equipment was tested for emissions compliance using the available configurations with the worst-case data presented. Test results in this report relate only to the products described in this report.

Equipment Configuration

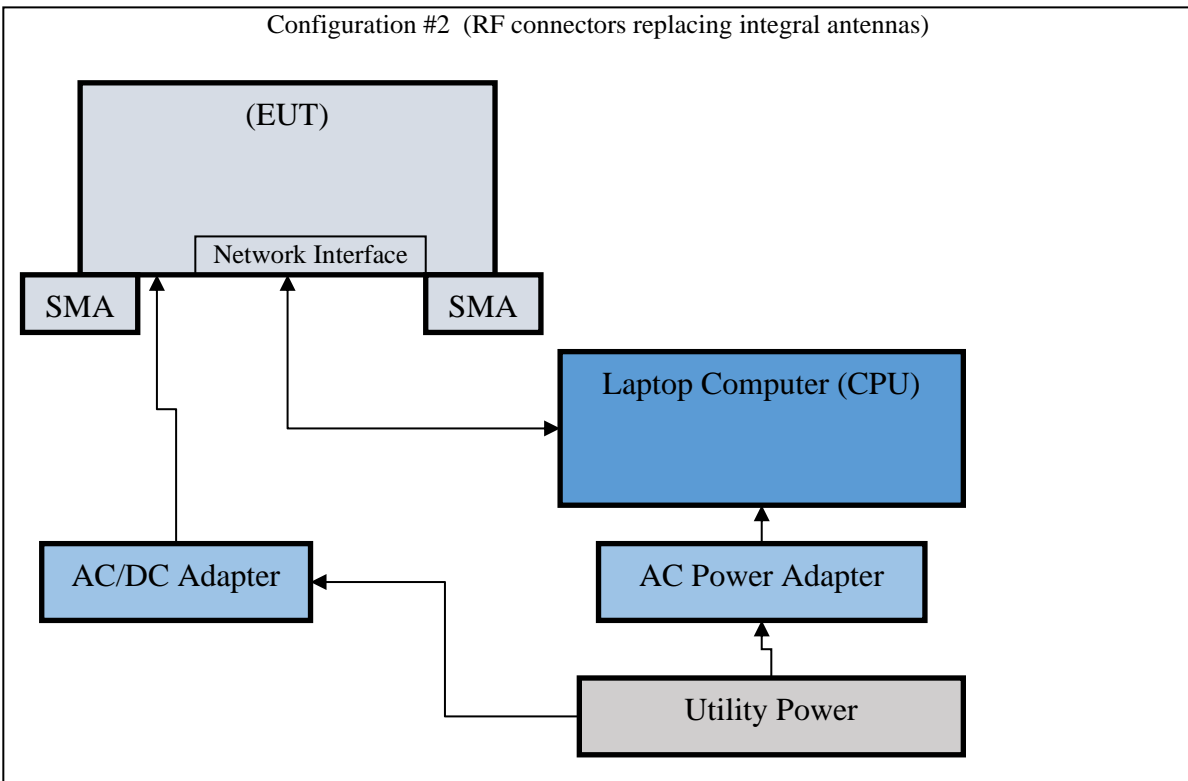
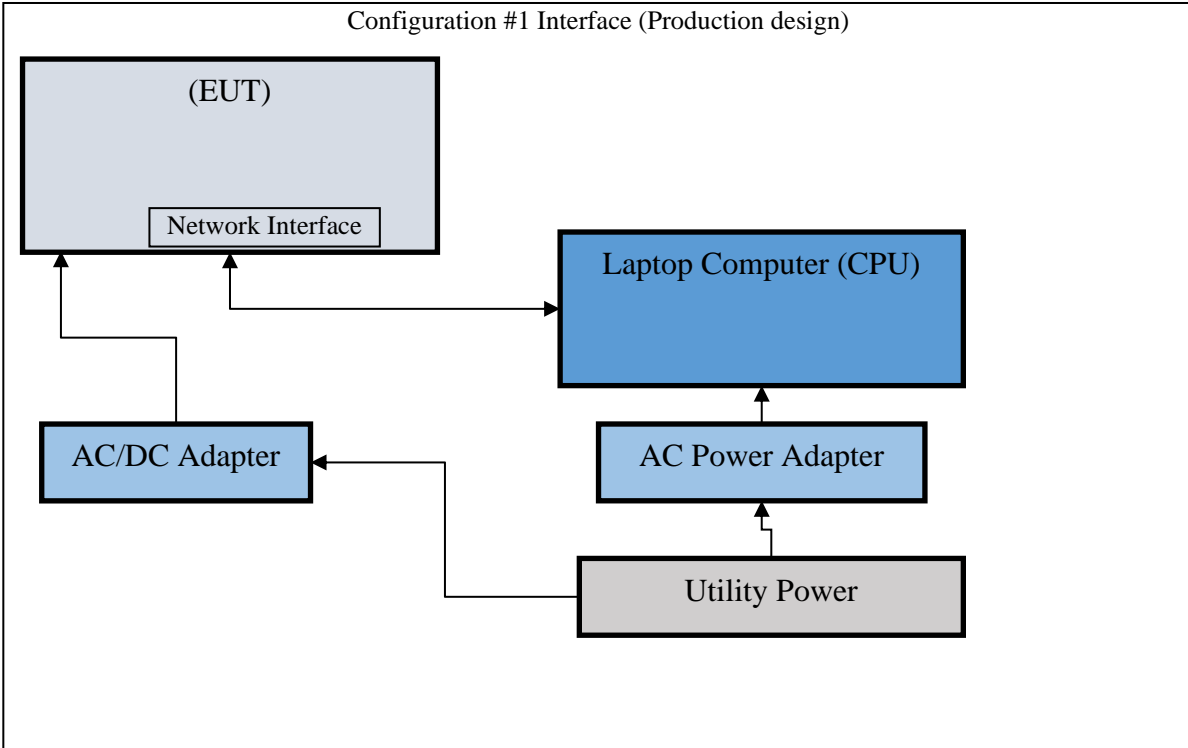

Applicant Company information

Applicants Company	MikroTik (“Mikrotīkls, SIA”)
Applicants Address	Brivibas gatve 214i, Riga Latvia LV-1039
FCC Identifier	TV7RBD53-5ACD2ND
Industry Canada Identifier	7442A-D53AC
Manufacturer Company	MikroTik (“Mikrotīkls, SIA”)
Manufacturer Address	Brivibas gatve 214i, Riga Latvia LV-1039

Equipment information

Product Marketing Name (PMN): The PMN is the name or model number under which the product will be marketed/offered for sale in Canada. If the product has PMN, it must be provided.	RBD53GR-5HacD2HnD-US&R11e-LTE6
Unique Product Number (UPN): The applicant made up of a maximum of 11 alphanumeric characters (A-Z, 0-9), assigns the UPN.	D53AC
Hardware Version Identification Number (HVIN): The HVIN identifies hardware specifications of a product version. The HVIN replaces the ISED Model Number in the legacy E-filing System. An HVIN is required for all products for certification applications.	D53AC
Host Marketing Name (HMN) (if applicable): The HMN is the name or model number of a final product, which contains a certified radio module.	
Brand Name	
Model Number	RBD53GR-5HacD2HnD-US&R11e-LTE6
Test Rule Part(s)	47CFR 15E, 15.407, RSS-247
Test Frequency Range	5.15-5.25 and 5.725-5.85 GHz
Project Number	200115
Submission Type	Certification

Accessories

AC Power Adapter	SAW30-240-1200U R2A
------------------	---------------------

Product Details

Items	Description
Product Type	2.4 GHz WLAN and 5 GHz U-NII
Radio Type	Transceiver
Power Type	External Power Supply
Data Modulation	IEEE 802.11 b: DSSS IEEE 802.11 g/n/n40: OFDM (QPSK/MCS) IEEE 802.11 a/n/n40: OFDM (QPSK/MCS) IEEE 802.11ac: (MCS/16QAM/64QAM/1024QAM)
Frequency Range	2412-2462 MHz, 5150-5250 MHz, and 5725-5850 MHz
Number of Channels	802.11b: 11, (bandwidths include 20 MHz) 802.11g/n/n40: up to 11, (bandwidths include 20 and 40 MHz) 802.11a/n/n40: up to 15, (bandwidths include 20 and 40 MHz) 802.11 ac: up to 2, (bandwidth 80 MHz)
Carrier Frequencies	Please refer to Table for Carrier Frequencies
Antenna	1) 2.4 GHz antenna: Integral 3-dBi gain 2) 5 GHz antenna: – Integral 5.5-dBi gain 3) No External antenna options.
Communication Mode	Device operates as a dual channel input / output, 2.4 GHz and 5 GHz Transmission System
Beamforming Function	Without beamforming

Table for Filed Antennas

Ant.	Brand	Model Name	P/N	Antenna Type	Connector	Gain (dBi)	
						2.4 GHz	5 GHz
1	Mikrotikls		N/A	Integral Planar Inverted F Antenna (PIFA)	N/A	3	5.5

Antenna

Antenna	TX chains		
Bandwidth Mode	20 MHz	40 MHz	80 MHz
2.4 GHz 802.11b/g/n/n40			
IEEE 802.11b	1 from above list		
IEEE 802.11g	1 from above list		
IEEE 802.11n (HT20)	1 from above list		
IEEE 802.11n40 (HT40)		1 from above list	
5 GHz U-NII-1, U-NII-3			
IEEE 802.11a	1 from above list		
IEEE 802.11n (HT20)	1 from above list		
IEEE 802.n40 (HT40)		1 from above list	
IEEE 802.11ac			1 from above list

Table for Carrier Frequencies

For 20MHz bandwidth systems, use Channel 1,6,11, 36, 40, 44, 48, 149, 153, 157, 161, 165.

For 40MHz bandwidth systems, use Channel 38, 46, 151, 159.

For 80MHz bandwidth systems, use Channel 42, 155.

Frequency Band	Channel No.	Frequency	Channel No.	Frequency
2400-2483.5MHz	1	2412 MHz	3	2422 MHz
	6	2437 MHz	8	2447 MHz
	11	2462 MHz	9	2452 MHz
5150-5250MHz U-NII-1	36	5180 MHz	44	5220 MHz
	38	5190 MHz	46	5230 MHz
	40	5200 MHz	48	5240 MHz
	42	5210 MHz		
5725-5850MHz U-NII-3	149	5745 MHz	157	5785 MHz
	151	5755 MHz	159	5795 MHz
	153	5765 MHz	161	5805 MHz
	155	5775 MHz	165	5825 MHz

Table for Test Modes

Preliminary tests were performed in different data rates to define the worst radiated emission. The data rate shown in the table below is the worst-case rate with respect to the specific test item. Investigation has been done on all possible configurations while searching the worst cases. The following table is a list of the test modes investigated for this report.

Test Items	Mode	Channel	Chain(s)
Max. Conducted Output Power	802.11b	1,6,11	1,2
	802.11g	1,6,11	1,2
	802.11n HT20	1,6,11	1,2
	802.11n HT40	3,8,9	1,2
	11 a BPSK	36/40/48/149/157/165	1,2
	11a/n HT20	36/40/48/149/157/165	1,2
	11a/n HT40	38/46/151/159	1,2
	11ac VHT80	42,155	1,2
Power Spectral Density	802.11b	1,6,11	1,2
	802.11g	1,6,11	1,2
	802.11n HT20	1,6,11	1,2
	802.11n HT40	3,8,9	1,2
	11a BPSK	36//40/48/149/157/165	1,2
	11a/n HT20	36/40/48/149/157/165	1,2
	11a/n HT40	38/46/151/159	1,2
	11ac VHT80	42,155	1,2
99% Occupied Bandwidth Measurement	802.11b	1,6,11	1,2
	802.11g	1,6,11	1,2
	802.11n HT20	1,6,11	1,2
	802.11n HT40	3,8,9	1,2
	11a BPSK	36/40/48/149/157/165	1,2
	11a/n HT20	36/40/48/149/157/165	1,2
	11a/n HT40	38/46/151/159	1,2
	11ac VHT80	42,155	1,2

6dB Spectrum Bandwidth Measurement	802.11b		1,6,11	1,2
	802.11g		1,6,11	1,2
	802.11n HT20		1,6,11	1,2
	802.11n HT40		3,8,9	1,2
	802.11a BPSK		149/157/165	1,2
	802.11a/n HT20		149/157/165	1,2
	802.11a/n HT40		151/159	1,2
	802.11ac VHT80		42,155	1,2
Radiated Emission Below 1GHz			-	1,2
Radiated Emission Above 1GHz	802.11b		1,6,11	1,2
	802.11g		1,6,11	1,2
	802.11n HT20		1,6,11	1,2
	802.11n HT40		3,8,9	1,2
	11a BPSK		36/40/48/149/157/165	1,2
	802.11a/n HT20		36/40/48/149/157/165	1,2
	802.11a/n HT40		38/46/151/159	1,2
	802.11ac VHT80		42,155	1,2
Band Edge Emission	802.11b		1,6,11	1,2
	802.11g		1,6,11	1,2
	802.11n HT20		1,6,11	1,2
	802.11n HT40		3,8,9	1,2
	11a BPSK		36/40/48/149/157/165	1,2
	802.11a/n HT20		36/40/48/149/157/165	1,2
	802.11a/n HT40		38/46/151/159	1,2
	802.11ac VHT80		42,155	1,2
Frequency Stability	20MHz	Band 1&3	40/157	1,2
	40MHz	Band 1&3	38/151	1,2
	80MHz	Band 1&3	42,155	1,2

Application for Certification

- (1) Manufacturer: Mikrotikls SIA
Brivibas gatve 214i
Riga Latvia LV-1039
- (2) Identification: Model: RBD53GR-5HacD2HnD-US&R11e-LTE6
FCC ID: TV7RBD53-5ACD2ND IC: 7442A-D53AC
- (3) Instruction Book:
Refer to Exhibit for Instruction Manual.
- (4) Description of Circuit Functions:
Refer to Exhibit of Operational Description.
- (5) Block Diagram with Frequencies:
Refer to Exhibit of Operational Description.
- (6) Report of Measurements:
Report of measurements follows in this Report.
- (7) Photographs: Construction, Component Placement, etc.:
Refer to Exhibit for photographs of equipment.
- (8) List of Peripheral Equipment Necessary for operation. The equipment operates from power received from authorized AC/DC power adapter. The EUT provides five Ethernet ports for communications, USB port, and micro SIM Card reader. During testing, the EUT was powered from the AC/DC power supply and connected to CPU through the network interface.
- (9) Transition Provisions of 47CFR 15.37 are not requested
- (10) Not Applicable. The unit is not a scanning receiver.
- (11) Not Applicable. The EUT does not operate in the 59 – 64 GHz frequency band.
- (12) The equipment is not software defined and this section is not applicable.
- (13) Applications for certification of U-NII devices in the 5.15-5.35 GHz and the 5.47-5.85 GHz bands must include a high-level operational description of the security procedures that control the radio frequency operating parameters and ensure that unauthorized modifications cannot be made. The required information has been provided in Operational Description Exhibit filed with the application.
- (14) Contain at least one drawing or photograph showing the test set-up for each of the required types of tests applicable to the device for which certification is requested. These drawings or photographs must show enough detail to confirm other information contained in the test report. Any photographs used must be focused originals without glare or dark spots and must clearly show the test configuration used. This information is provided in this report and Test Setup Exhibits provided with the application filing.

Applicable Standards & Test Procedures

The following information is submitted in accordance with e-CFR dated January 15, 2020, Part 2, Subpart J, Part 15, Subpart 15E, KDB 662911 D01 Multiple Transmitter Output v02r01, Industry Canada RSS-GEN Issue 5, and RSS-247 Issue 2. Test procedures used are the established Methods of Measurement of Radio-Noise Emissions as described in ANSI C63.10-2013, KDB 789033 D02 General UNII Test Procedures New Rules v02r01, KDB 926956 v02, RSS-247 Issue 2, and RSS-GEN Issue 5.

Testing Procedures

AC Line Conducted Emission Test Procedure

Testing for the AC line-conducted emissions was performed as defined in ANSI C63.10-2013. The test setup, including the Host device and EUT, was arranged in the test configuration as presented above. The test configuration was placed on a 1 x 1.5-meter wooden bench, 0.8 meters high located in a screen room. The power lines of the system were isolated from the power source using a standard LISN with a 50- μ Hy choke. EMI was coupled to the spectrum analyzer through a 0.1 μ F capacitor internal to the LISN. The LISN was positioned on the floor beneath the wooden bench supporting the EUT. The power lines and cables were draped over the back edge of the table. Refer to diagram one showing typical test arrangement and photographs in exhibits for EUT placement used during testing.

Radiated Emission Test Procedure

Radiated emissions testing was performed as required in 47 CFR 15C, RSS-247 Issue 2 and specified in ANSI C63.10-2013. The EUT was placed on a rotating 0.9 x 1.2-meter platform, elevated as required above the ground plane at a distance of 3 meters from the FSM antenna. EMI energy was maximized by equipment placement permitting orientation in three orthogonal axes, raising and lowering the FSM antenna, changing the antenna polarization, and by rotating the turntable. Each emission was maximized before data was taken and recorded. The frequency spectrum from 9 kHz to 25,000 MHz was searched for emissions during preliminary investigation. Refer to diagrams one and two showing typical test setup. Refer to photographs in the test setup exhibits for specific EUT placement during testing.

Antenna Port Conducted Emission Test Procedure

The EUT test sample #2 was assembled as required for operation and placed on a benchtop located in a screen room. This configuration provided the ability to connect test equipment to the manufacturer provided antenna ports. Antenna Port conducted emissions testing was performed as required in the regulations and specified in ANSI C63.10-2013. Testing was completed on a laboratory bench in a shielded room. The active antenna port of the unlicensed wireless device was connected to appropriate attenuation and the spectrum analyzer or power meter. Refer to diagram four showing typical test arrangement and photographs in the test setup exhibits for specific EUT placement during testing.

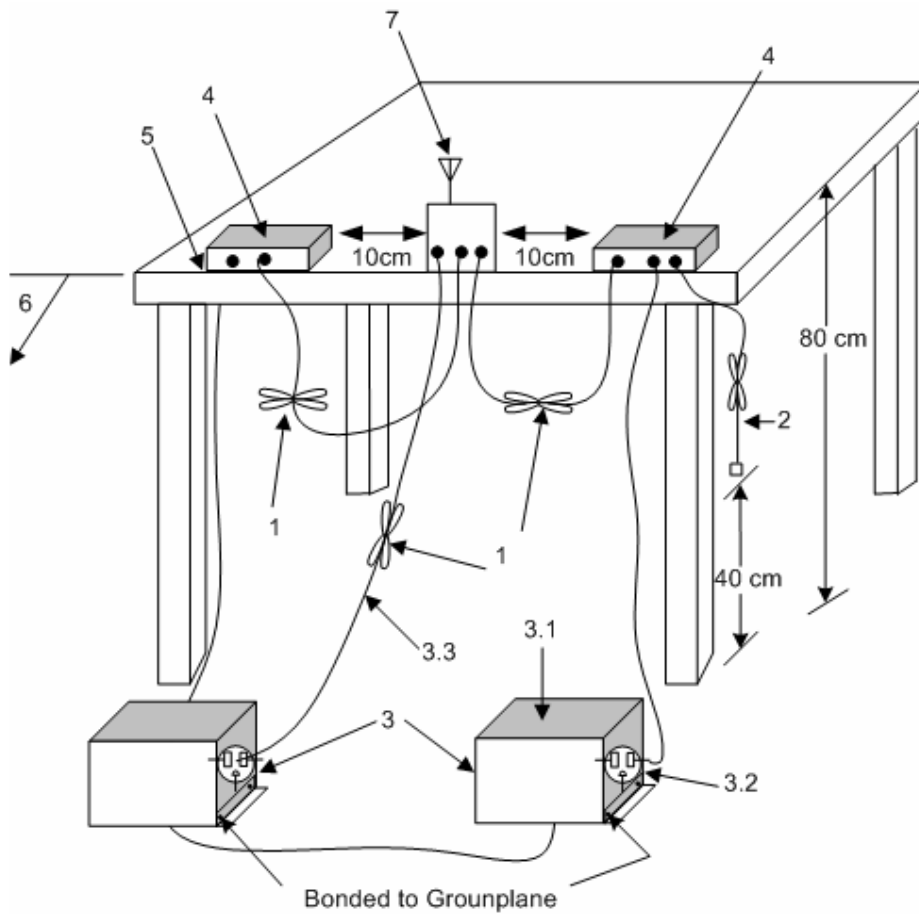

1. Interconnecting cables that hang closer than 40 cm to the ground plane shall be folded back and forth in the center forming a bundle 30 cm to 40 cm long see (see 6.2.3.2).
2. The I/O cables that are not connected to an accessory shall be bundled in the center. The end of the cable may be terminated, if required, using the correct terminating impedance. The overall length shall not exceed 1 m (see 6.2.2).
3. EUT connected to one LISN. Unused LISN measuring port connectors shall be terminated in 50 Ω loads. LISN may be placed on top of, or immediately beneath, reference ground plane (see 6.2.2 and 6.2.3).
 - 3.1 All other equipment powered from additional LISN(s).
 - 3.2 Multiple-outlet strip can be used for multiple power cords of non-EUT equipment.
 - 3.3 LISN at least 80 cm from nearest part of EUT chassis
4. Non-EUT components of EUT system being tested
5. Rear of EUT, including peripherals, shall all be aligned and flush with edge of tabletop (see 6.2.3.2).
6. Edge of tabletop shall be 40 cm removed from a vertical conducting plane that is bonded to the ground plane (see 6.2.2 for options).
7. Antenna may be integral or detachable. If detachable, the antenna shall be attached for this test.

Diagram 1 Test arrangement for Conducted emissions

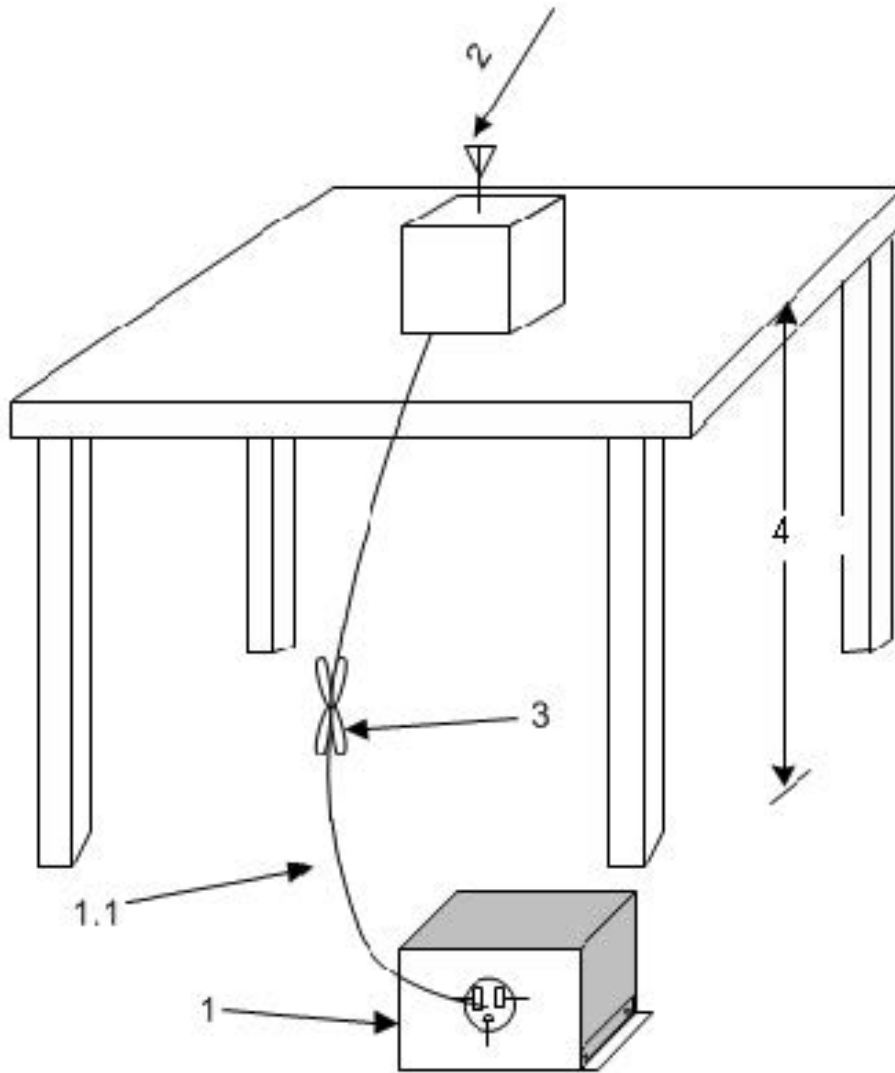

1. A LISN is optional for radiated measurements between 30 MHz and 1000 MHz but not allowed for measurements below 30 MHz and above 1000 MHz (see 6.3.1). If used, then connect EUT to one LISN. Unused LISN measuring port connectors shall be terminated in 50 Ω loads. The LISN may be placed on top of, or immediately beneath, the reference ground plane (see 6.2.2 and 6.2.3.2).
 - 1.1 LISN spaced at least 80 cm from nearest part of EUT chassis.
2. Antenna can be integral or detachable, depending on the EUT (see 6.3.1).
3. Interconnecting cables that hang closer than 40 cm to the ground plane shall be folded back and forth in the center forming a bundle 30 cm to 40 cm long (see 6.3.1).
4. For emission measurements at or below 1 GHz, the table height shall be 80 cm. For emission measurements above 1 GHz, the table height shall be 1.5 m for measurements, except as otherwise specified (see 6.3.1 and 6.6.3.1).

Diagram 2 Test arrangement for radiated emissions of tabletop equipment

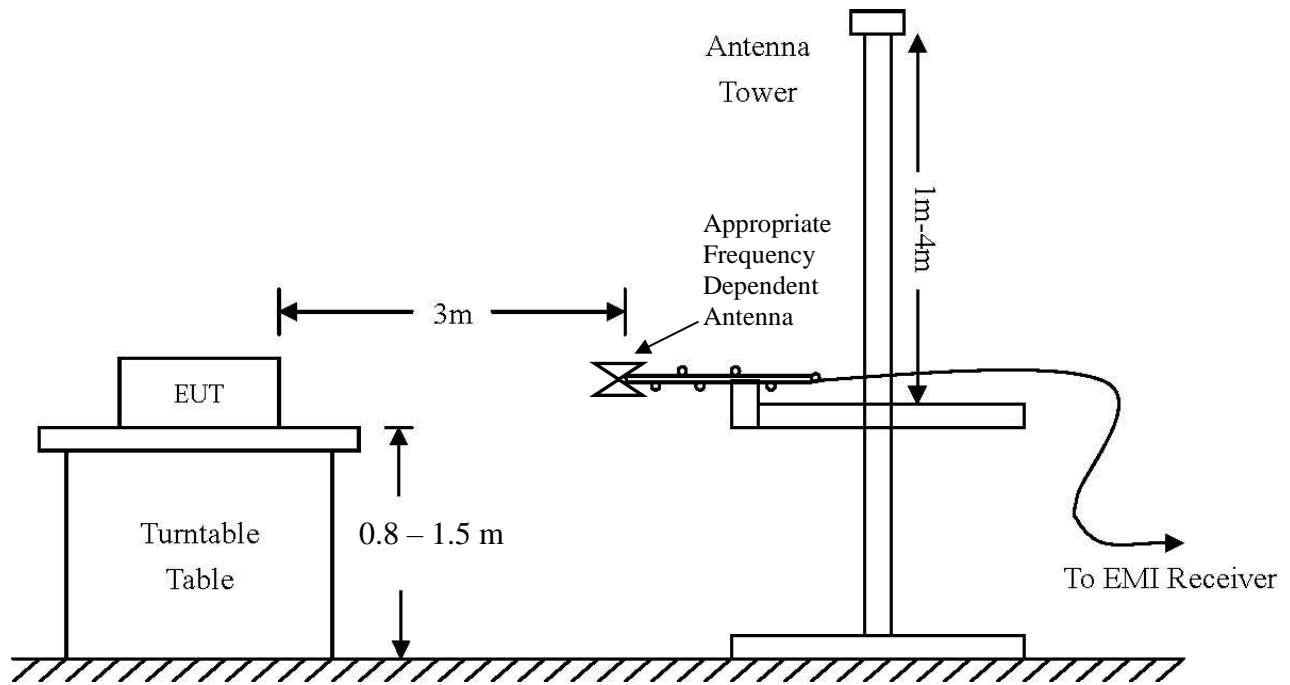

Frequency: 9 kHz-30 MHz	Frequency: 30 MHz- 1 GHz	Frequency: Above 1 GHz
Loop Antenna	Broadband Biconilog	Horn
RBW = 9 kHz	RBW = 120 kHz	RBW = 1 MHz
VBW = 30 kHz	VBW = 120 kHz	VBW = 1 MHz
Sweep time = Auto	Sweep time = Auto	Sweep time = Auto
Detector = PK, QP	Detector = PK, QP	Detector = PK, AV
Antenna Height 1m	Antenna Height 1-4m	Antenna Height 1-4m

Diagram 3 Test arrangement for radiated emissions tested on Open Area Test Site (OATS)

Spectrum Analyzer

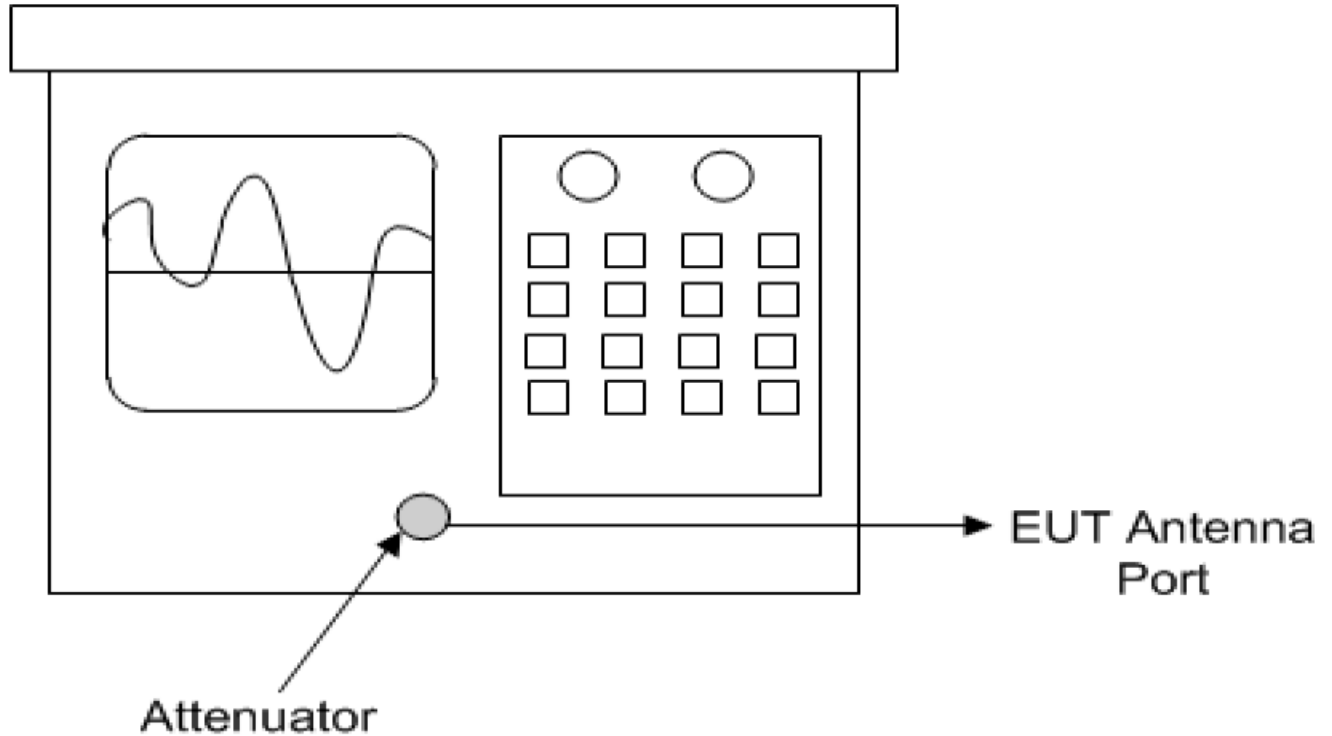

Diagram 4 Test arrangement for Antenna Port Conducted emissions

Test Site Locations

Conducted EMI AC line conducted emissions testing performed in a shielded screen room located at Rogers Labs, Inc., 4405 West 259th Terrace, Louisburg, KS

Antenna port Antenna port conducted emissions testing was performed in a shielded screen room located at Rogers Labs, Inc., 4405 West 259th Terrace, Louisburg, KS

Radiated EMI The radiated emissions tests were performed at the 3 meters, Open Area Test Site (OATS) located at Rogers Labs, Inc., 4405 West 259th Terrace, Louisburg, KS

Registered Site information: FCC Site: US5305, ISED: 3041A, CAB Identifier: US0096

NVLAP Accreditation Lab code 200087-0

Units of Measurements

Conducted EMI Data presented in dB μ V; dB referenced to one microvolt

Antenna port Conducted Data is in dBm; dB referenced to one milliwatt

Radiated EMI Data presented in dB μ V/m; dB referenced to one microvolt per meter

Note: The limit is expressed for a measurement in dB μ V/m when the measurement is taken at a distance of 3 or 10 meters. Data taken for this report was taken at distance of 3 meters. Sample calculation demonstrates corrected field strength reading for Open Area Test Site using the measurement reading and correcting for receive antenna factor, cable losses, and amplifier gains.

Sample Calculation:

RFS = Radiated Field Strength, FSM = Field Strength Measured

A.F. = Receive antenna factor, Losses = attenuators/cable losses, Gain = amplification gains

RFS (dB μ V/m @ 3m) = FSM (dB μ V) + A.F. (dB/m) + Losses (dB) - Gain (dB)

Environmental Conditions

Ambient Temperature 21.1° C

Relative Humidity 40 %

Atmospheric Pressure 1023.4 mb

Statement of Modifications and Deviations

No modifications to the EUT were required for the unit to demonstrate compliance with the 47CFR Part 15E and Industry Canada RSS-247 Issue 2 emissions requirements. There were no deviations or modifications to the specifications.

Intentional Radiators

As per 47CFR subpart E and Industry Canada RSS-247 Issue 2, the following information is submitted for consideration and demonstration of compliance with regulations and standards.

Antenna Requirements

The EUT utilizes integral antenna system and offers no provision for antenna replacement. The antenna system complies with the unique antenna connection requirements. The requirements of 15.203 are fulfilled there are no deviations or exceptions to the specification.

Restricted Bands of Operation

Spurious emissions falling in the restricted frequency bands of operation were measured on the OATS. The EUT utilizes frequency, determining circuitry, which generates harmonics falling in restricted bands. Emissions were investigated while the EUT was located on the OATS using appropriate antennas or pyramidal horns, amplification stages, and spectrum analyzer receiver. Peak and average amplitudes of frequencies above 1000 MHz were compared to the required limits with worst-case data presented below. Test procedures of ANSI C63.10-2013 were used during testing. No other significant emission was observed which fell into the restricted bands of operation. Computed radiated emission values consider the measured radiated field strength, receive antenna correction factor, amplifier gain stage, and test system cable losses.

Table 1 Radiated Harmonic Emissions in Restricted Bands Data Mode 5 (802.11a)

Frequency in MHz	Horizontal Peak (dBμV/m)	Horizontal Average (dBμV/m)	Vertical Peak (dBμV/m)	Vertical Average (dBμV/m)	Limit @ 3m (dBμV/m)	Horizontal Margin (dB)	Vertical Margin (dB)
U-NII-1 Operation Worst-case							
5150.0	67.4	52.7	56.2	39.4	54.0	-1.3	-14.6
5350.0	55.9	39.8	52.1	39.3	54.0	-14.2	-14.7
15540.0	63.3	50.2	63.1	50.3	54.0	-3.8	-3.7
15600.0	63.1	50.1	62.9	50.1	54.0	-3.9	-3.9
15720.0	64.0	50.7	63.5	50.9	54.0	-3.3	-3.1
20720.0	64.9	51.7	64.6	51.7	54.0	-2.3	-2.3
20800.0	63.9	51.2	64.4	51.1	54.0	-2.8	-2.9
20960.0	64.3	51.2	64.2	51.2	54.0	-2.8	-2.8

Other emissions present had amplitudes at least 20 dB below the limit. Peak and Quasi-Peak amplitude emissions are recorded above for frequency range below 1000 MHz. Peak and Average amplitude emissions are recorded above for frequency range above 1000 MHz.

Table 2 Radiated Harmonic Emissions in Restricted Bands Data Mode 6 (802.11n)

Frequency in MHz	Horizontal Peak (dB μ V/m)	Horizontal Average (dB μ V/m)	Vertical Peak (dB μ V/m)	Vertical Average (dB μ V/m)	Limit @ 3m (dB μ V/m)	Horizontal Margin (dB)	Vertical Margin (dB)
U-NII-1 Operation Worst-case							
5150.0	67.0	49.9	56.8	40.1	54.0	-4.1	-13.9
5350.0	55.0	39.5	52.4	39.0	54.0	-14.5	-15.0
15540.0	62.4	48.5	61.7	49.2	54.0	-5.5	-4.8
15600.0	61.9	48.3	61.8	49.0	54.0	-5.7	-5.0
15720.0	62.9	49.1	62.5	49.6	54.0	-4.9	-4.4
20720.0	64.6	51.9	64.7	51.9	54.0	-2.1	-2.1
20800.0	64.8	51.6	64.3	51.5	54.0	-2.4	-2.5
20960.0	64.7	51.4	64.4	51.3	54.0	-2.6	-2.7

Other emissions present had amplitudes at least 20 dB below the limit. Peak and Quasi-Peak amplitude emissions are recorded above for frequency range below 1000 MHz. Peak and Average amplitude emissions are recorded above for frequency range above 1000 MHz.

Table 3 Radiated Harmonic Emissions in Restricted Bands Data Mode 7 (802.11n40)

Frequency in MHz	Horizontal Peak (dBμV/m)	Horizontal Average (dBμV/m)	Vertical Peak (dBμV/m)	Vertical Average (dBμV/m)	Limit @ 3m (dBμV/m)	Horizontal Margin (dB)	Vertical Margin (dB)
U-NII-1 Operation Worst-case							
5150.0	72.2	53.4	64.8	47.7	54.0	-0.6	-6.3
5350.0	54.2	39.6	51.0	38.1	54.0	-14.4	-15.9
15570.0	62.3	49.4	64.5	50.9	54.0	-4.6	-3.1
15690.0	63.6	50.5	63.2	50.5	54.0	-3.5	-3.5
20760.0	64.2	51.3	64.1	51.2	54.0	-2.7	-2.8
20920.0	64.5	51.2	64.1	51.1	54.0	-2.8	-2.9

Other emissions present had amplitudes at least 20 dB below the limit. Peak and Quasi-Peak amplitude emissions are recorded above for frequency range below 1000 MHz. Peak and Average amplitude emissions are recorded above for frequency range above 1000 MHz.

Table 4 Radiated Harmonic Emissions in Restricted Bands Data Mode 8 (802.11ac)

Frequency in MHz	Horizontal Peak (dBμV/m)	Horizontal Average (dBμV/m)	Vertical Peak (dBμV/m)	Vertical Average (dBμV/m)	Limit @ 3m (dBμV/m)	Horizontal Margin (dB)	Vertical Margin (dB)
U-NII-1 Operation Worst-case							
5150.0	66.5	46.0	67.5	47.2	54.0	-8.0	-6.8
5350.0	51.5	37.8	50.8	37.4	54.0	-16.2	-16.6
15630.0	56.6	43.9	57.6	44.0	54.0	-10.1	-10.0
20840.0	64.0	51.2	64.5	51.2	54.0	-2.8	-2.8

Other emissions present had amplitudes at least 20 dB below the limit. Peak and Quasi-Peak amplitude emissions are recorded above for frequency range below 1000 MHz. Peak and Average amplitude emissions are recorded above for frequency range above 1000 MHz.

Table 5 Radiated Harmonic Emissions in Restricted Bands Data Mode 9 (802.11a)

Frequency in MHz	Horizontal Peak (dB μ V/m)	Horizontal Average (dB μ V/m)	Vertical Peak (dB μ V/m)	Vertical Average (dB μ V/m)	Limit @ 3m (dB μ V/m)	Horizontal Margin (dB)	Vertical Margin (dB)
U-NII-3 Operation Worst-case							
11490.0	58.7	45.8	58.5	45.8	54.0	-8.2	-8.2
11570.0	58.7	45.8	59.4	45.9	54.0	-8.2	-8.1
11650.0	59.3	46.2	59.5	46.3	54.0	-7.8	-7.7
22980.0	65.7	52.0	65.4	52.0	54.0	-2.0	-2.0

Other emissions present had amplitudes at least 20 dB below the limit. Peak and Quasi-Peak amplitude emissions are recorded above for frequency range below 1000 MHz. Peak and Average amplitude emissions are recorded above for frequency range above 1000 MHz.

Table 6 Radiated Harmonic Emissions in Restricted Bands Data Mode 10 (802.11n)

Frequency in MHz	Horizontal Peak (dB μ V/m)	Horizontal Average (dB μ V/m)	Vertical Peak (dB μ V/m)	Vertical Average (dB μ V/m)	Limit @ 3m (dB μ V/m)	Horizontal Margin (dB)	Vertical Margin (dB)
U-NII-3 Operation Worst-case							
11490.0	57.5	43.3	57.1	44.1	54.0	-10.7	-9.9
11570.0	57.1	44.1	57.6	44.7	54.0	-9.9	-9.3
11650.0	57.5	44.4	57.6	44.9	54.0	-9.6	-9.1
22980.0	64.7	52.2	65.1	52.2	54.0	-1.8	-1.8

Other emissions present had amplitudes at least 20 dB below the limit. Peak and Quasi-Peak amplitude emissions are recorded above for frequency range below 1000 MHz. Peak and Average amplitude emissions are recorded above for frequency range above 1000 MHz.

Table 7 Radiated Harmonic Emissions in Restricted Bands Data Mode 11 (802.11n40)

Frequency in MHz	Horizontal Peak (dB μ V/m)	Horizontal Average (dB μ V/m)	Vertical Peak (dB μ V/m)	Vertical Average (dB μ V/m)	Limit @ 3m (dB μ V/m)	Horizontal Margin (dB)	Vertical Margin (dB)
U-NII-3 Operation Worst-case							
11510.0	58.5	45.5	58.7	45.6	54.0	-8.5	-8.4
11590.0	58.3	45.8	58.9	46.0	54.0	-8.2	-8.0
23020.0	65.4	51.9	65.2	52.0	54.0	-2.1	-2.0

Other emissions present had amplitudes at least 20 dB below the limit. Peak and Quasi-Peak amplitude emissions are recorded above for frequency range below 1000 MHz. Peak and Average amplitude emissions are recorded above for frequency range above 1000 MHz.

Table 8 Radiated Harmonic Emissions in Restricted Bands Data Mode 12 (802.11ac)

Frequency in MHz	Horizontal Peak (dB μ V/m)	Horizontal Average (dB μ V/m)	Vertical Peak (dB μ V/m)	Vertical Average (dB μ V/m)	Limit @ 3m (dB μ V/m)	Horizontal Margin (dB)	Vertical Margin (dB)
U-NII-3 Operation Worst-case							
11550.0	57.6	44.7	58.2	45.5	54.0	-9.3	-8.5
23100.0	64.9	52.0	64.7	52.1	54.0	-2.0	-1.9

Other emissions present had amplitudes at least 20 dB below the limit. Peak and Quasi-Peak amplitude emissions are recorded above for frequency range below 1000 MHz. Peak and Average amplitude emissions are recorded above for frequency range above 1000 MHz.

Summary of Results for Radiated Emissions in Restricted Bands

The EUT demonstrated compliance with the emissions requirements of 47CFR 15.205, RSS-GEN Issue 5, and RSS-247 Issue 2. The EUT provided a worst-case minimum margin of -0.6 dB below the emissions requirements in restricted frequency bands. Peak, Quasi-peak, and average amplitudes were checked for compliance with the regulations. Worst-case emissions are reported with other emissions found in the restricted frequency bands at least 20 dB below the requirements.

AC Line Conducted Emissions Procedure

The EUT and support host was arranged in a typical equipment configuration and placed on a 1 x 1.5-meter wooden bench 80 cm above the conducting ground plane, floor of a screen room. The bench was positioned 40 cm away from the wall of the screen room. The LISN was positioned on the floor of the screen room 80-cm from the rear of the EUT. The manufacturer supplied AC/DC adapter was connected to the LISN and provided direct current power to the host and powered the test sample. A second LISN was positioned on the floor of the screen room 80-cm from the rear of the supporting equipment of the EUT. All power cords except the EUT were then powered from the second LISN. EMI was coupled to the spectrum analyzer through a 0.1 µf capacitor, internal to the LISN. Power line conducted emissions testing were carried out individually for each current carrying conductor of the host system for the EUT. The excess length of lead between the system and the LISN receptacle was folded back and forth to form a bundle not exceeding 40 cm in length. The screen room, conducting ground plane, analyzer, and LISN were bonded together to the protective earth ground. Preliminary testing was performed to identify the frequency of each emission displaying the highest amplitude. The cables were repositioned to obtain maximum amplitude of measured EMI level. Once the worst-case configuration was identified, plots were made of the EMI from 0.15 MHz to 30 MHz then the data was recorded with maximum conducted emissions levels.

Refer to figures one and two for plots of the EUT and host system AC Line Conducted emissions.

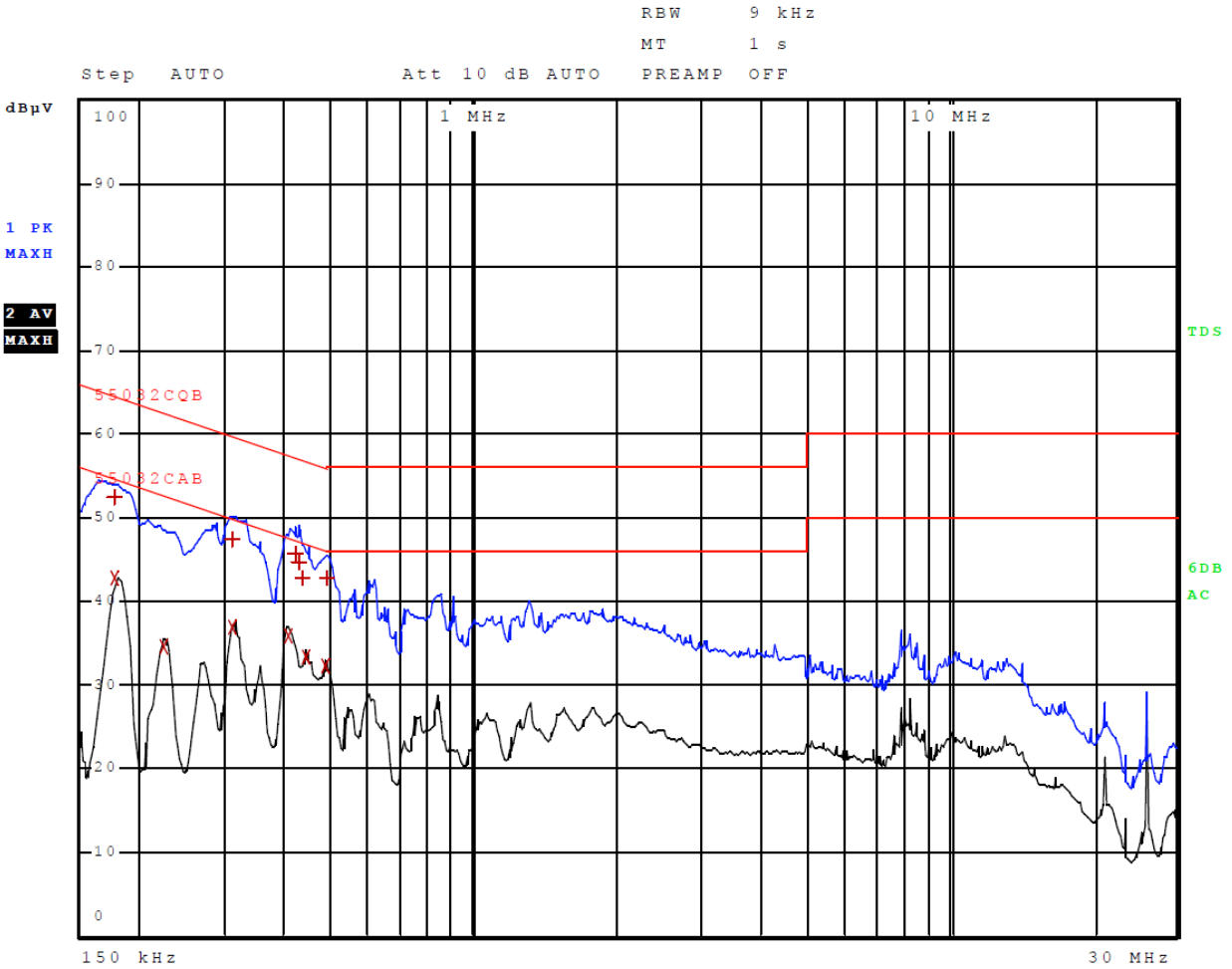

Figure 1 AC Line Conducted Emissions Line 1

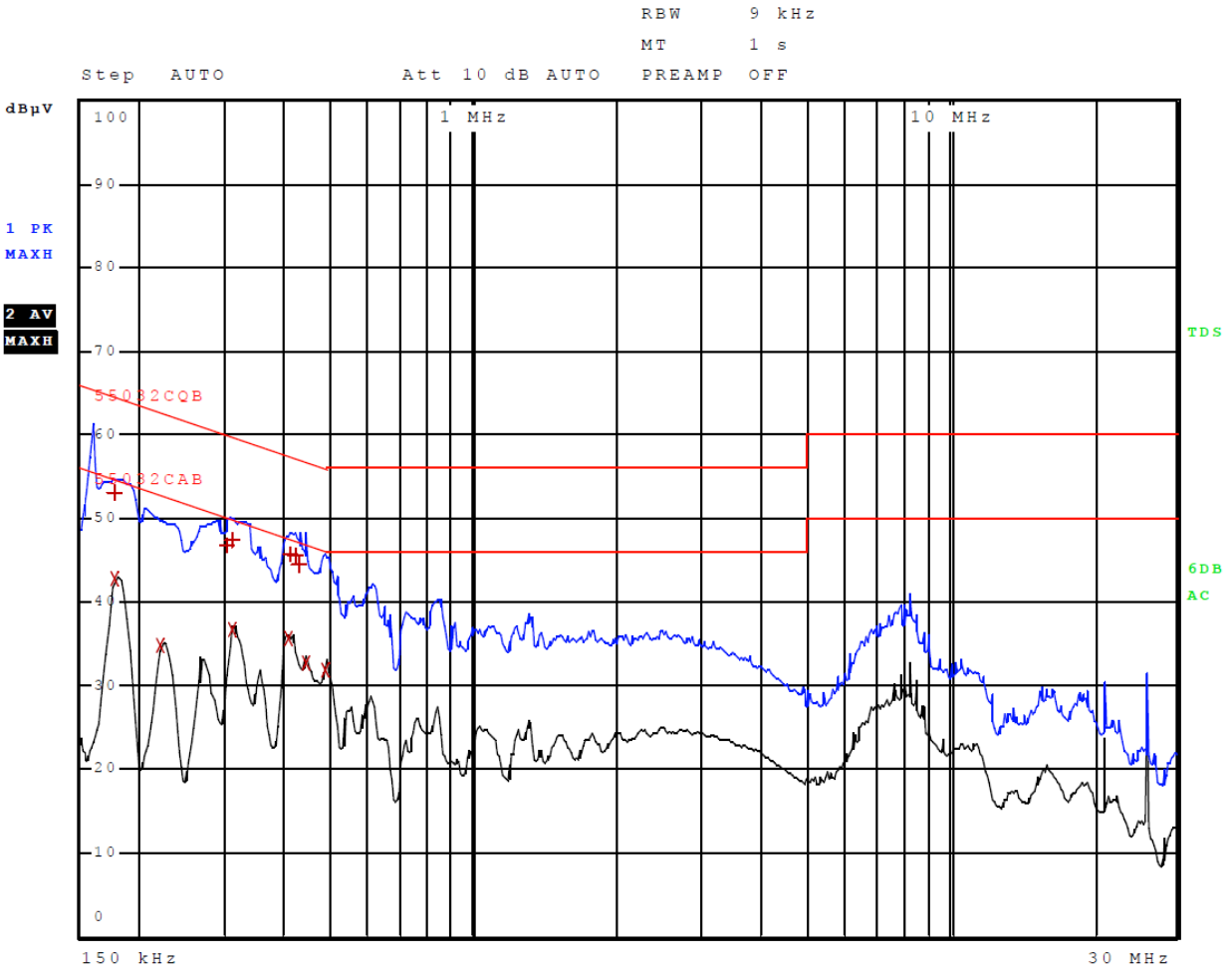

Figure 2 AC Line Conducted Emissions Line 2

Table 9 AC Line Conducted Emissions Data (Highest Emissions Line L1)

Trace	Frequency	Level (dBµV)	Detector	Delta Limit/dB
2	178.000000000 kHz	42.76	Average	-11.82
1	178.000000000 kHz	52.40	Quasi Peak	-12.18
2	226.000000000 kHz	34.54	Average	-18.06
2	314.000000000 kHz	36.85	Average	-13.02
1	314.000000000 kHz	47.43	Quasi Peak	-12.43
2	406.000000000 kHz	35.88	Average	-11.85
1	418.000000000 kHz	45.69	Quasi Peak	-11.80
1	426.000000000 kHz	44.56	Quasi Peak	-12.77
1	434.000000000 kHz	42.73	Quasi Peak	-14.45
2	442.000000000 kHz	33.22	Average	-13.80
2	486.000000000 kHz	32.19	Average	-14.05
1	490.000000000 kHz	42.73	Quasi Peak	-13.44

Other emissions present had amplitudes at least 20 dB below the limit.

Table 10 AC Line Conducted Emissions Data (Highest Emissions Line L2)

Trace	Frequency	Level (dBµV)	Detector	Delta Limit/dB
1	178.000000000 kHz	53.11	Quasi Peak	-11.47
2	178.000000000 kHz	42.84	Average	-11.73
2	222.000000000 kHz	34.79	Average	-17.95
1	306.000000000 kHz	46.69	Quasi Peak	-13.39
2	314.000000000 kHz	36.73	Average	-13.13
1	314.000000000 kHz	47.28	Quasi Peak	-12.58
2	406.000000000 kHz	35.52	Average	-12.21
1	410.000000000 kHz	45.79	Quasi Peak	-11.86
1	418.000000000 kHz	45.54	Quasi Peak	-11.95
1	426.000000000 kHz	44.34	Quasi Peak	-12.99
2	442.000000000 kHz	32.60	Average	-14.42
2	486.000000000 kHz	31.85	Average	-14.39

Other emissions present had amplitudes at least 20 dB below the limit.

Summary of Results for AC Line Conducted Emissions

The EUT test system demonstrated compliance to the conducted emissions requirements of 47CFR 15.207, RSS-247 Issue 2 and RSS-GEN. The EUT and host support system demonstrated minimum margin of -11.4 dB below the limit. Measurements were taken using the peak, quasi peak, and average, measurement function for each emissions amplitude and were below the limits stated in the specification. Other emissions were present with recorded data representing worst-case amplitudes.

General Radiated Emissions Procedure

The EUT was arranged in a typical equipment configuration and operated through all available modes with worst-case data recorded. Preliminary testing was performed in a screen room with the EUT positioned 1 meter from the FSM. Radiated emissions measurements were performed to identify the frequencies, which produced the highest emissions. Each radiated emission was then maximized at the OATS location before final radiated emissions measurements were performed. Final data was taken with the EUT located at the OATS at a 3 meters distance between the EUT and the receiving antenna. The frequency spectrum from 9 kHz to 60,000 MHz was searched for general radiated emissions. Measured emission levels were maximized by EUT placement on the table, rotating the turntable through 360 degrees, varying the antenna height between 1 and 4 meters above the ground plane and changing antenna position between horizontal and vertical polarization. Antennas used were Loop from 9 kHz to 30 MHz, Broadband Biconical from 30 to 200 MHz, Biconilog from 30 to 1000 MHz, Log Periodic from 200 MHz to 1 GHz and or Double Ridge or pyramidal horns and mixers above 1 GHz, notch filters, and appropriate amplifiers and external mixers were utilized.

Table 11 General Radiated Emissions from EUT Data (Highest Emissions)

Frequency (MHz)	Horizontal Peak (dB μ V/m)	Horizontal Quasi-Peak (dB μ V/m)	Vertical Peak (dB μ V/m)	Vertical Quasi-Peak (dB μ V/m)	Limit @ 3m (dB μ V/m)	Horizontal Margin (dBm)	Vertical Margin (dBm)
75.6	31.4	25.1	34.4	27.0	40.0	-14.9	-13.0
125.0	43.2	36.7	44.0	39.5	43.5	-6.8	-3.8
148.2	37.7	30.6	37.3	31.2	43.5	-12.9	-12.3
164.7	33.2	27.5	37.4	32.2	43.5	-16.0	-11.3
202.9	33.2	27.0	28.1	22.6	43.5	-16.5	-20.9
250.0	37.2	34.0	36.4	31.0	46.0	-12.0	-15.0
500.0	34.3	30.2	35.4	32.3	46.0	-15.8	-13.7
960.0	39.8	37.1	40.1	36.8	46.0	-8.9	-9.2

Other emissions present had amplitudes at least 20 dB below the limit. Peak and Quasi-Peak amplitude emissions are recorded for frequency range below 1000 MHz. Peak and Average amplitude emissions are recorded for frequency range above 1000 MHz.

Summary of Results for General Radiated Emissions

The EUT demonstrated compliance with the radiated emissions requirements of 47CFR part 15 and Industry Canada RSS-247 Issue 2 Intentional Radiators. The EUT demonstrated a minimum margin of -3.8 dB below the requirements. Other emissions were present with amplitudes at least 20 dB below the Limits.

Operation in the 5150-5250 and 5725-5850 MHz Frequency U-NII-1 and U-NII-3 Bands

Testing followed FCC 789033 D02 General U-NII Test Procedures New Rules v02r01.

A power meter was used to measure fundamental transmitter output power. A spectrum analyzer / receiver was used to produce plots and make other antenna port conducted measurements for compliance testing. Test software (Winbox version 3.18) was used to operate the transmitter. This software provided the ability to set test channel, operational mode, and modulation scheme. The software was configured using 0-dBi gain antenna during antenna port conducted testing and antenna gain information was entered during radiated emissions testing. Each antenna port was connected to coaxial cable with 50-ohm attenuator, receiver, spectrum analyzer, or power meter during testing. Radiated emissions testing was performed on the Open Area Test Site (OATS) with all transmitters operating. The test sample was placed on a turntable elevated as required above the ground plane as required at a 3 meters distance from the FSM antenna located on the OATS for testing radiated emissions. The peak and quasi-peak amplitude of the frequencies below 1000 MHz were measured using a spectrum analyzer. The peak and average amplitude of emissions above 1000 MHz were measured using a spectrum analyzer. Emissions data was recorded from the measurement results. Data presented reflects measurement result corrected to account for measurement system gains and losses. Plots were made of transmitter performance for reference and demonstration of compliance. In addition, all Manufacturers of U-NII devices are responsible for ensuring frequency stability such that the emissions are maintained within the band of operation under all conditions of normal operation as specified in the user's manual. The manufacturer has attested the equipment operates within the required frequency spectrum under normal operational conditions. This report documents emissions governed under the U-NII-1 and U-NII-3 bands operating in the 5180-5240 and 5745-5825 MHz frequency bands.

Directional correlated antenna calculation (antenna gain 3 and 5.9 dBi, and 2 chains). Per KDB 662911 D01 Multiple Transmitter Output v02r01, the directional gain for correlated emissions in-band may be calculated using the following formula:

$$\text{Directional gain} = G_{\text{ANT}} + 10 \log (N_{\text{ANT}}) \text{ dBi}$$

$$\text{Directional gain} = 5.5 + 10 \log (2) \text{ dBi} = 8.5 \text{ dBi}$$

Note: The power of the transmitter has been adjusted for the gain exceeding 6dBi.

Per 15.407 Technical Requirements

(a) power limitations

(1) For the Band 5.15-5.25 GHz

- (i) For an outdoor access point operating in the band 5.15-5.25 GHz, the maximum conducted output power over the frequency band of operation shall not exceed 1 W provided the maximum antenna gain does not exceed 6 dBi. In addition, the maximum power spectral density shall not exceed 17 dBm in any 1 megahertz band. If transmitting antennas of directional gain greater than 6 dBi are used, both the maximum conducted output power and the maximum power spectral density shall be reduced by the amount in dB that the directional gain of the antenna exceeds 6 dBi. The maximum e.i.r.p. at any elevation angle above 30 degrees as measured from the horizon must not exceed 125 mW (21 dBm).

Per RSS-247 Issue 2

6. Technical requirements for license-exempt local area network devices and digital transmission systems operating in the 5 GHz band

This section provides standards for License-Exempt Local Area Network (LE-LAN) devices operating in the bands 5150-5250 MHz, 5250-5350 MHz, 5470-5600 MHz, 5650-5725 MHz and 5725-5850 MHz and for DTSs operating in the band 5725-5850 MHz that employ digital modulation technology but are not designed for LE-LAN operation.

Devices with occupied bandwidths which overlap different bands shall comply with all operational requirements for each band.

6.2.1 Frequency band 5150-5250 MHz

LE-LAN devices are restricted to indoor operation only in the band 5150-5250 MHz. However, original equipment manufacturer (OEM) devices, which are installed in vehicles by vehicle manufacturers, are permitted.

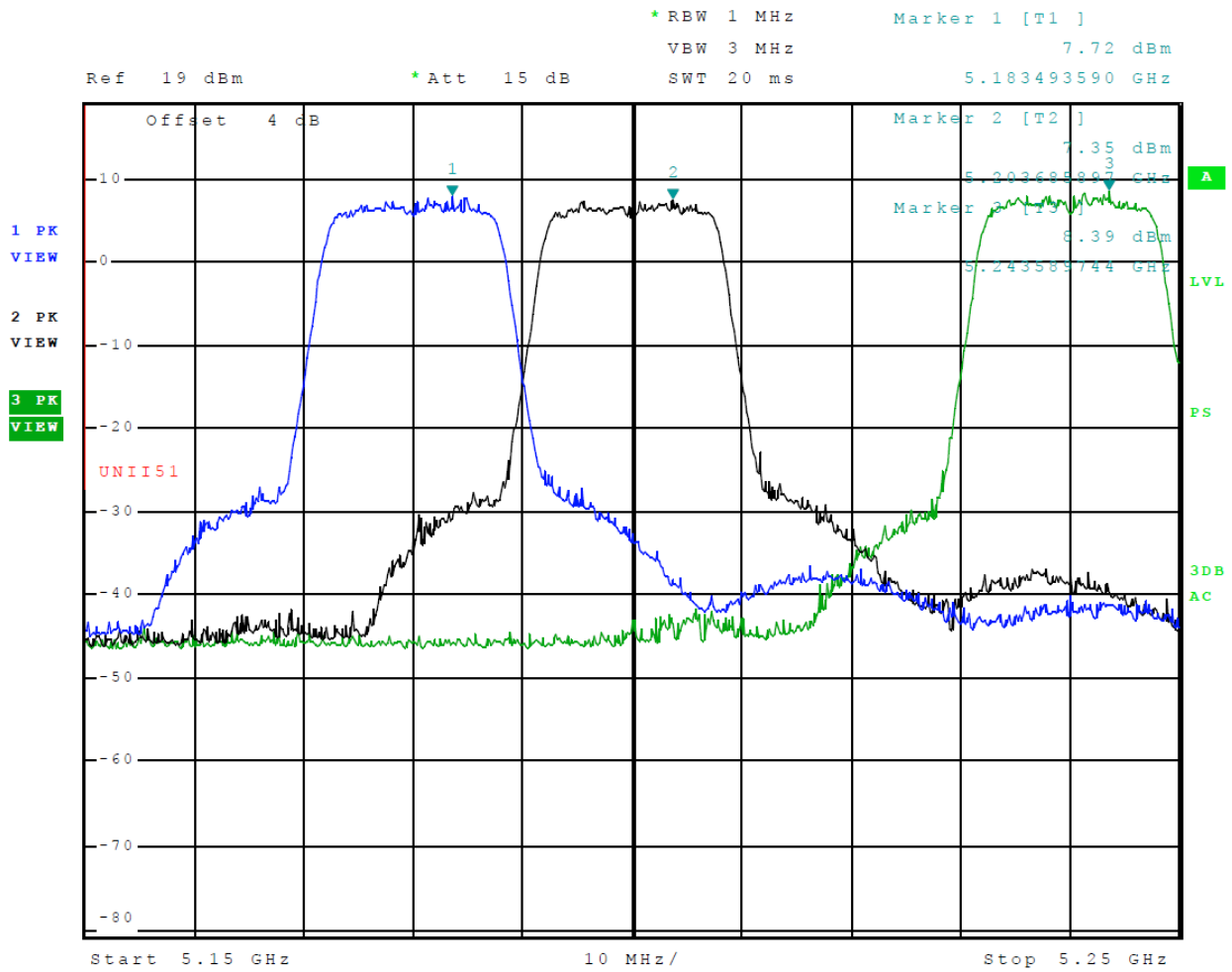

Figure 3 Plot of Transmitter Emissions (Across 5150-5250 MHz Band, Chain 0, 802.11a)

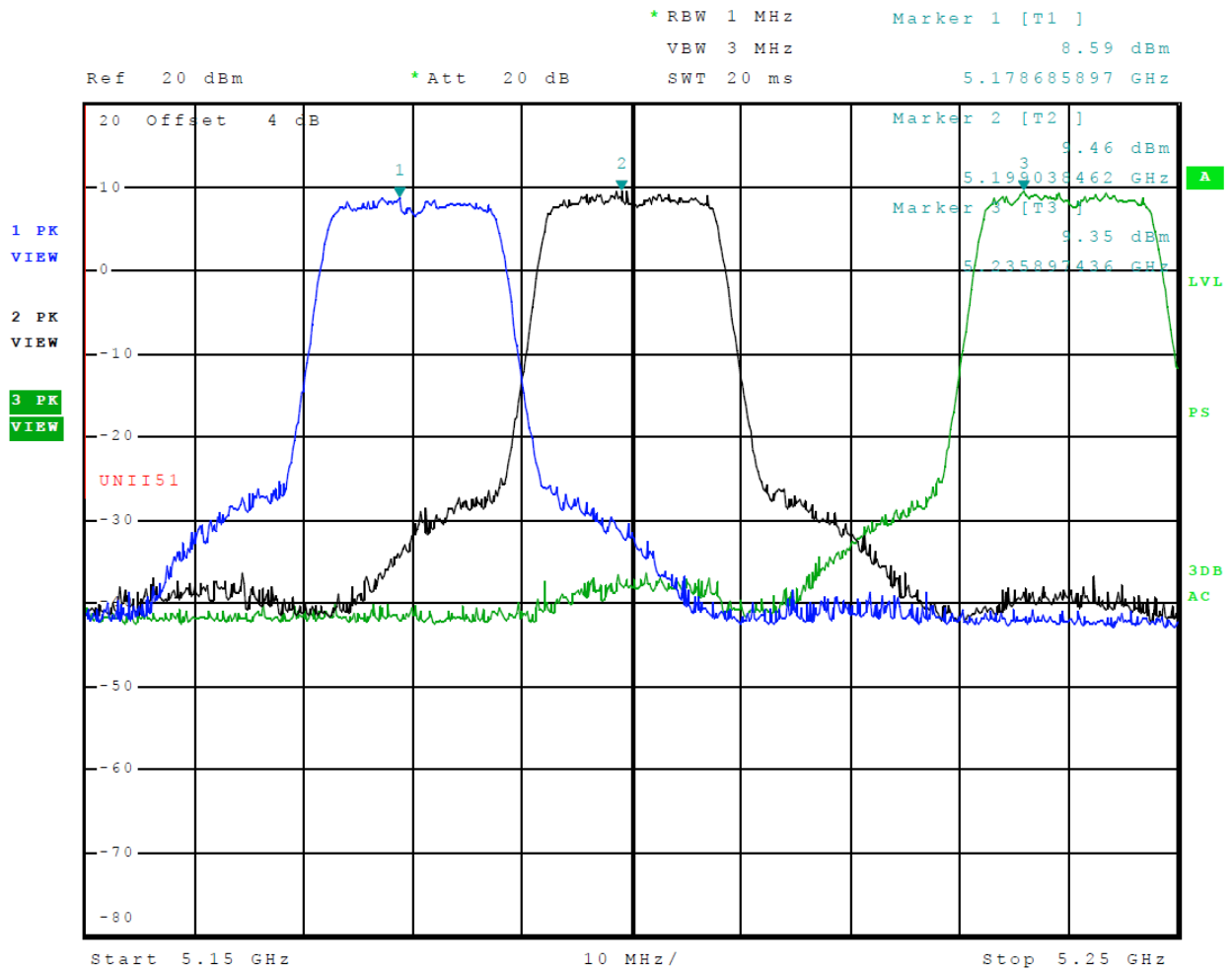

Figure 4 Plot of Transmitter Emissions (Across 5150-5250 MHz Band, Chain 1, 802.11a)

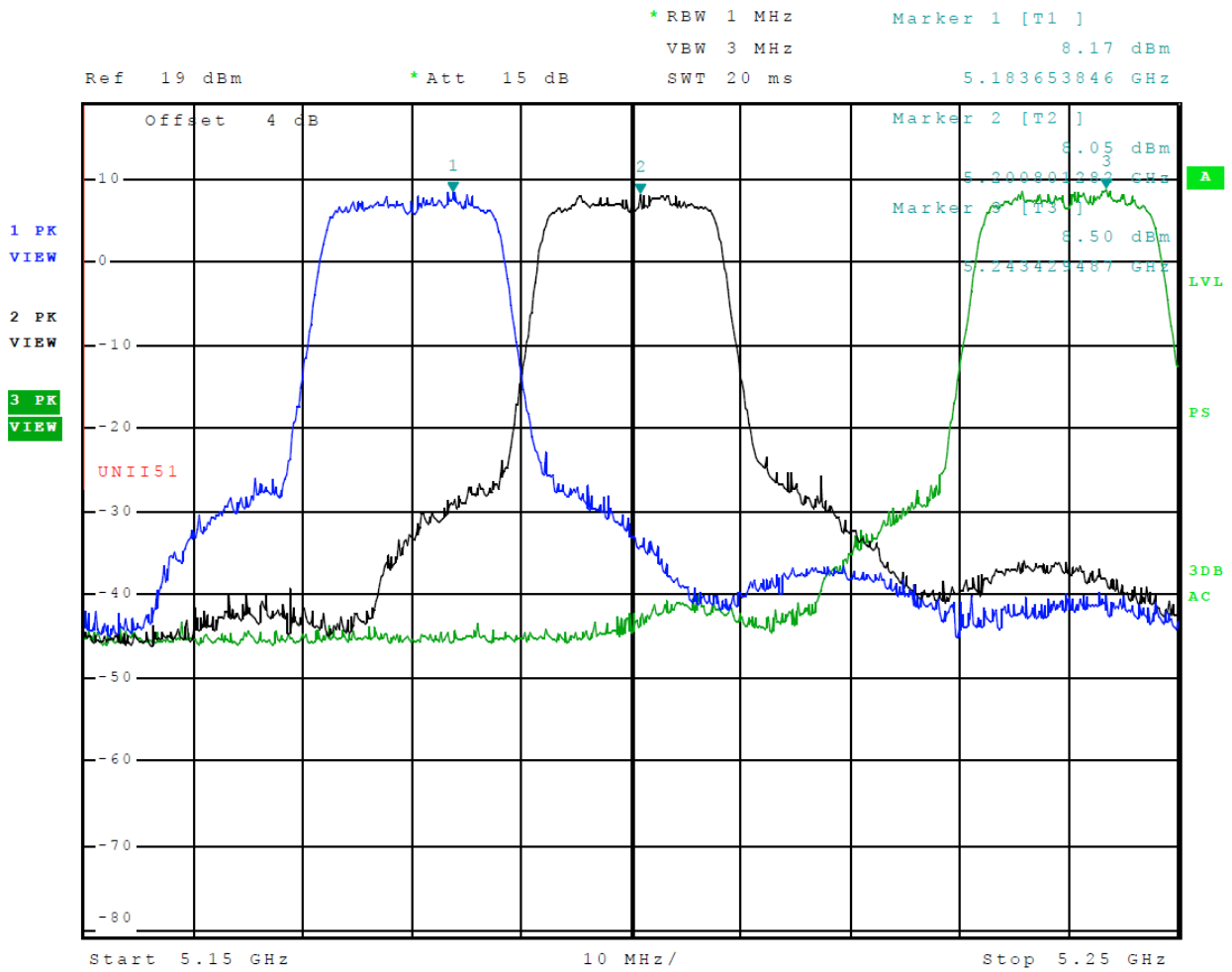

Figure 5 Plot of Transmitter Emissions (Across 5150-5250 MHz Band, Chain 0, 802.11n)

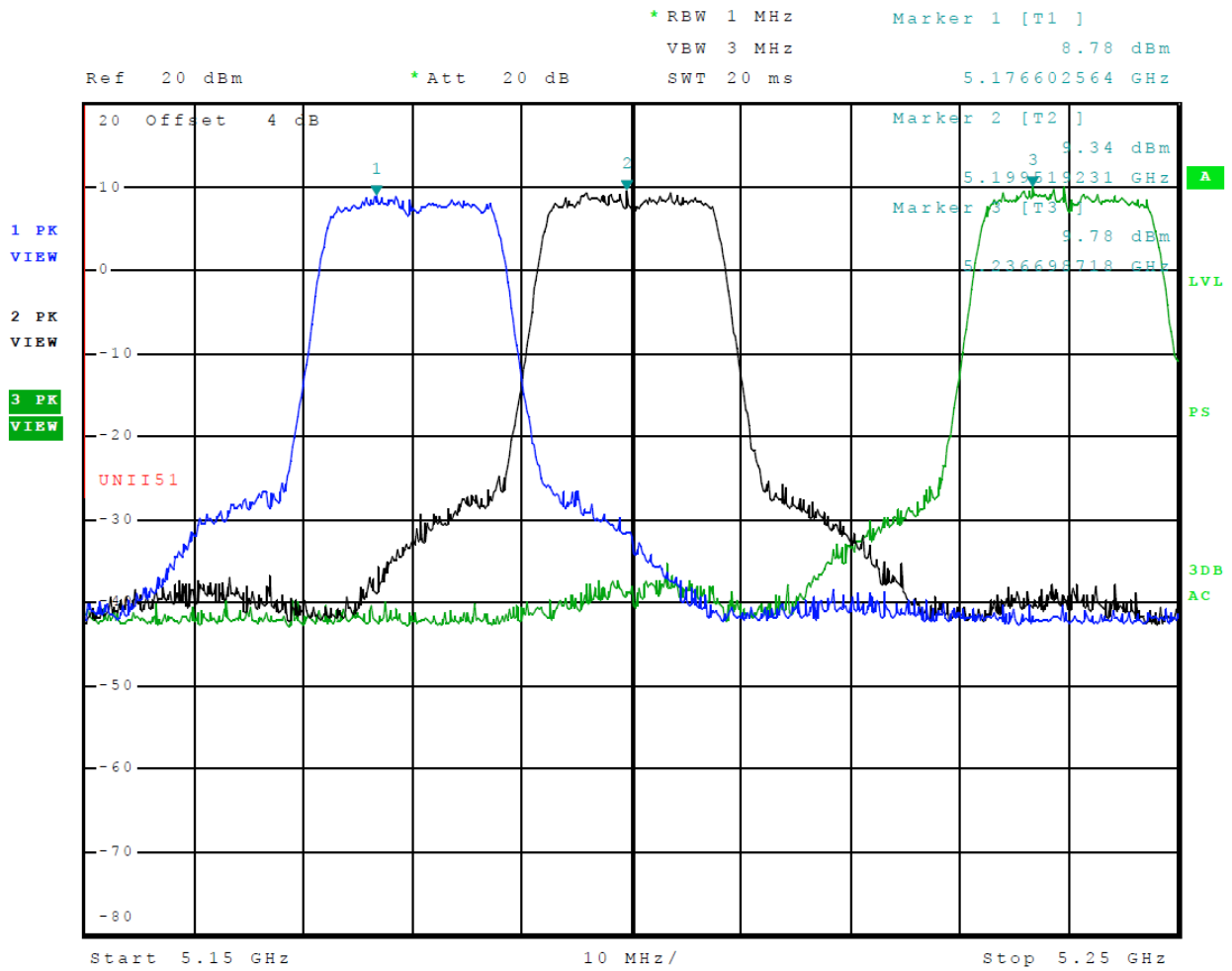

Figure 6 Plot of Transmitter Emissions (Across 5150-5250 MHz Band, Chain 1, 802.11n)

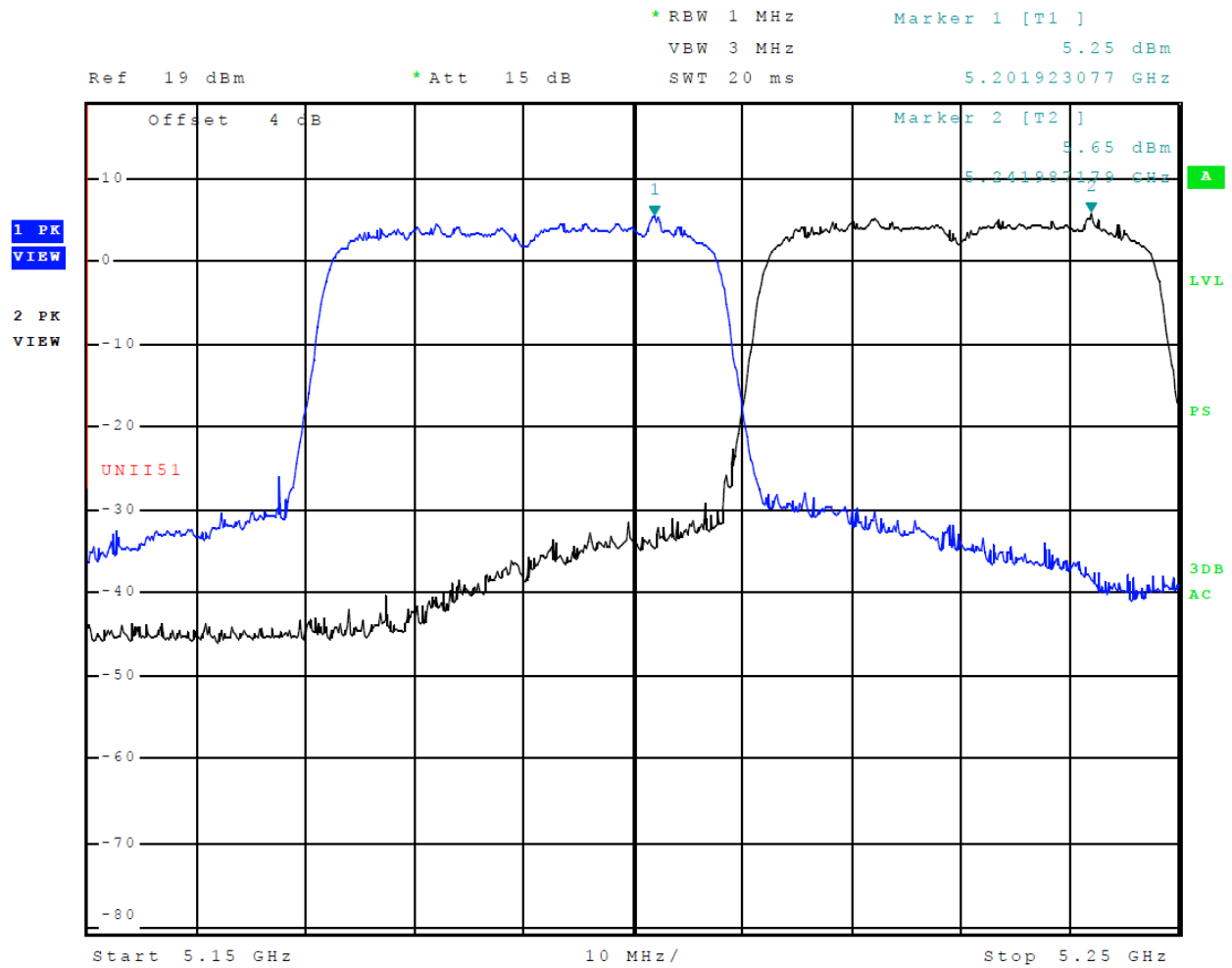

Figure 7 Plot of Transmitter Emissions (Across 5150-5250 MHz Band, Chain 0, 802.11n40)

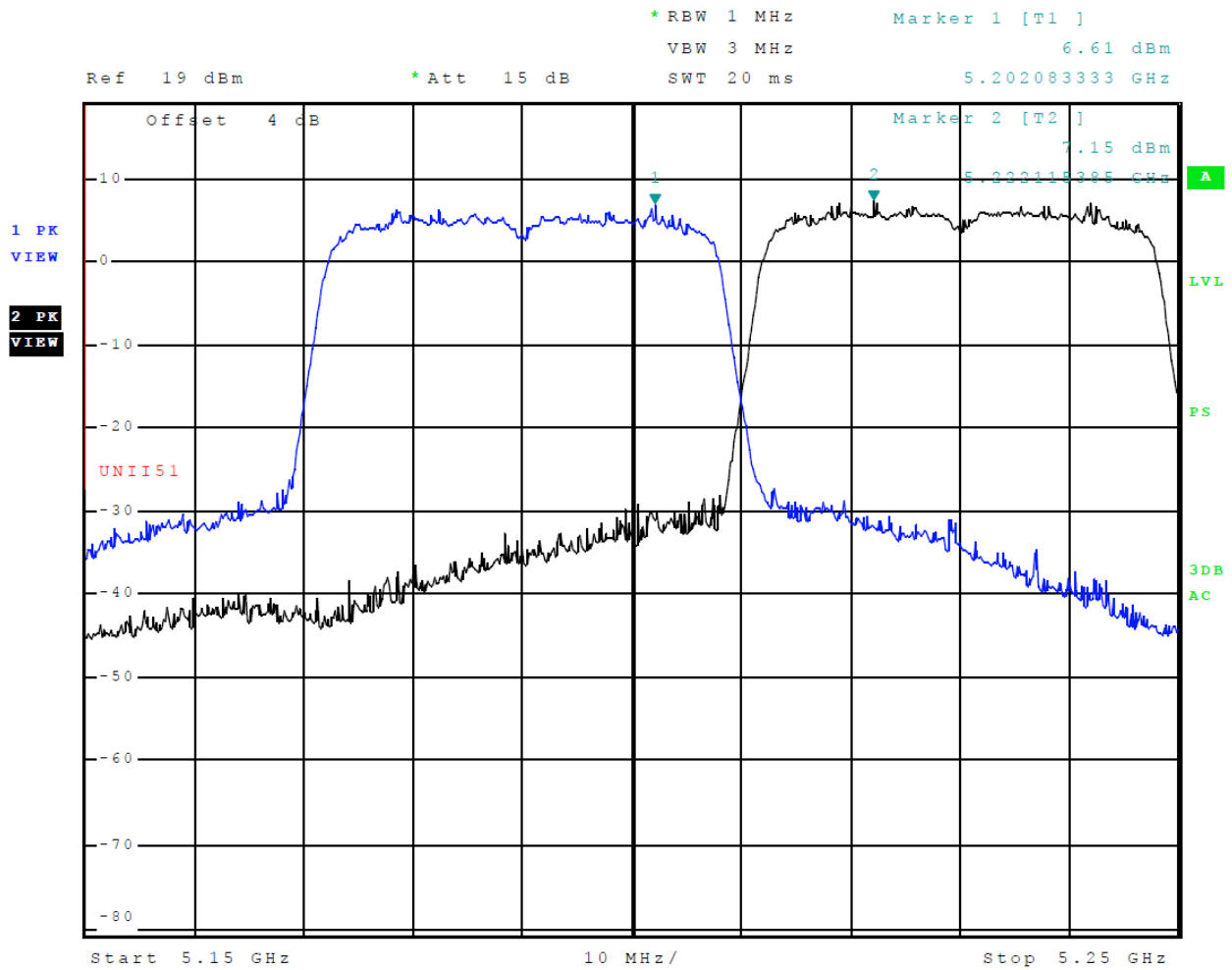

Figure 8 Plot of Transmitter Emissions (Across 5150-5250 MHz Band, Chain 1, 802.11n40)

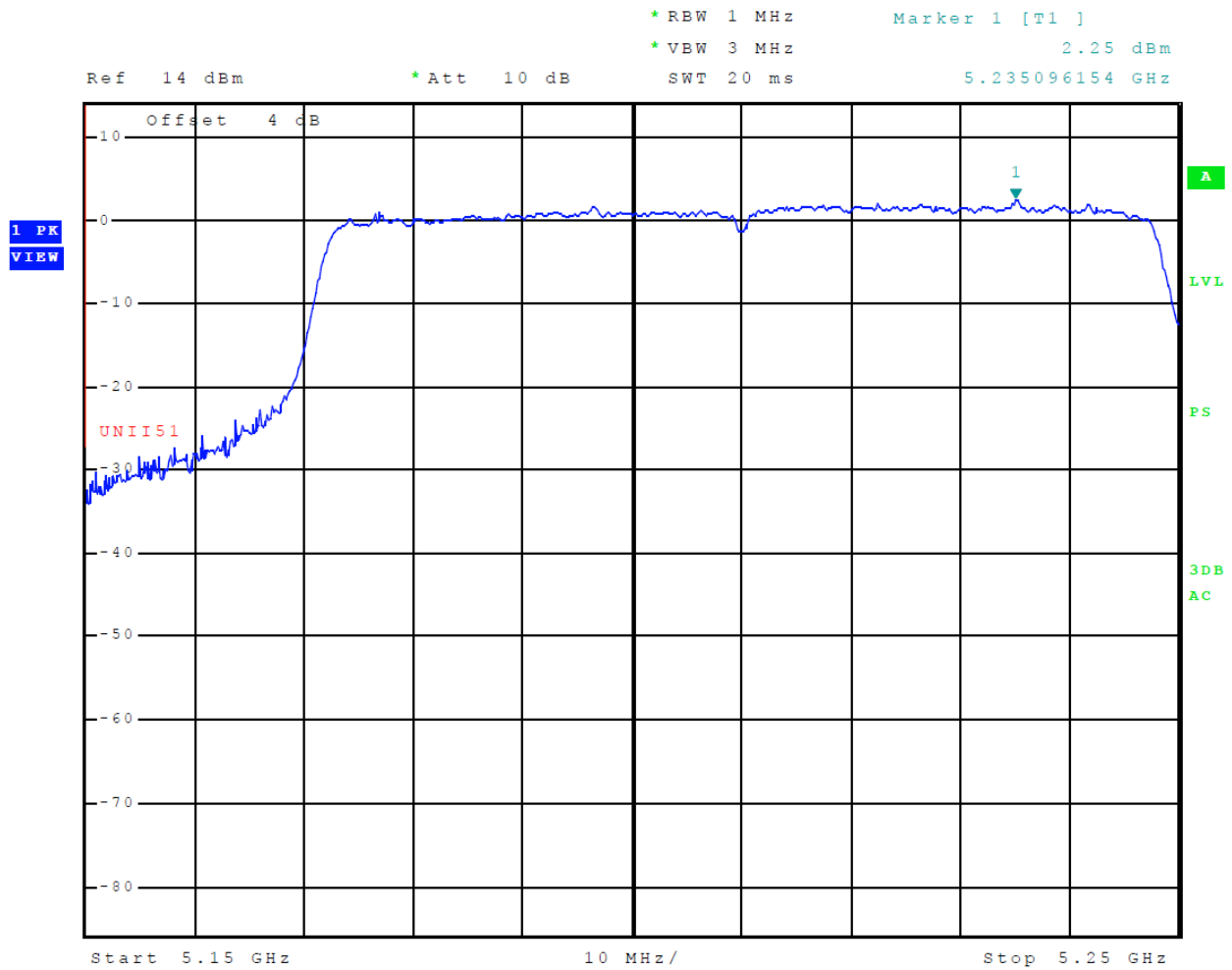

Figure 9 Plot of Transmitter Emissions (Across 5150-5250 MHz Band, Chain 0, 802.11ac)

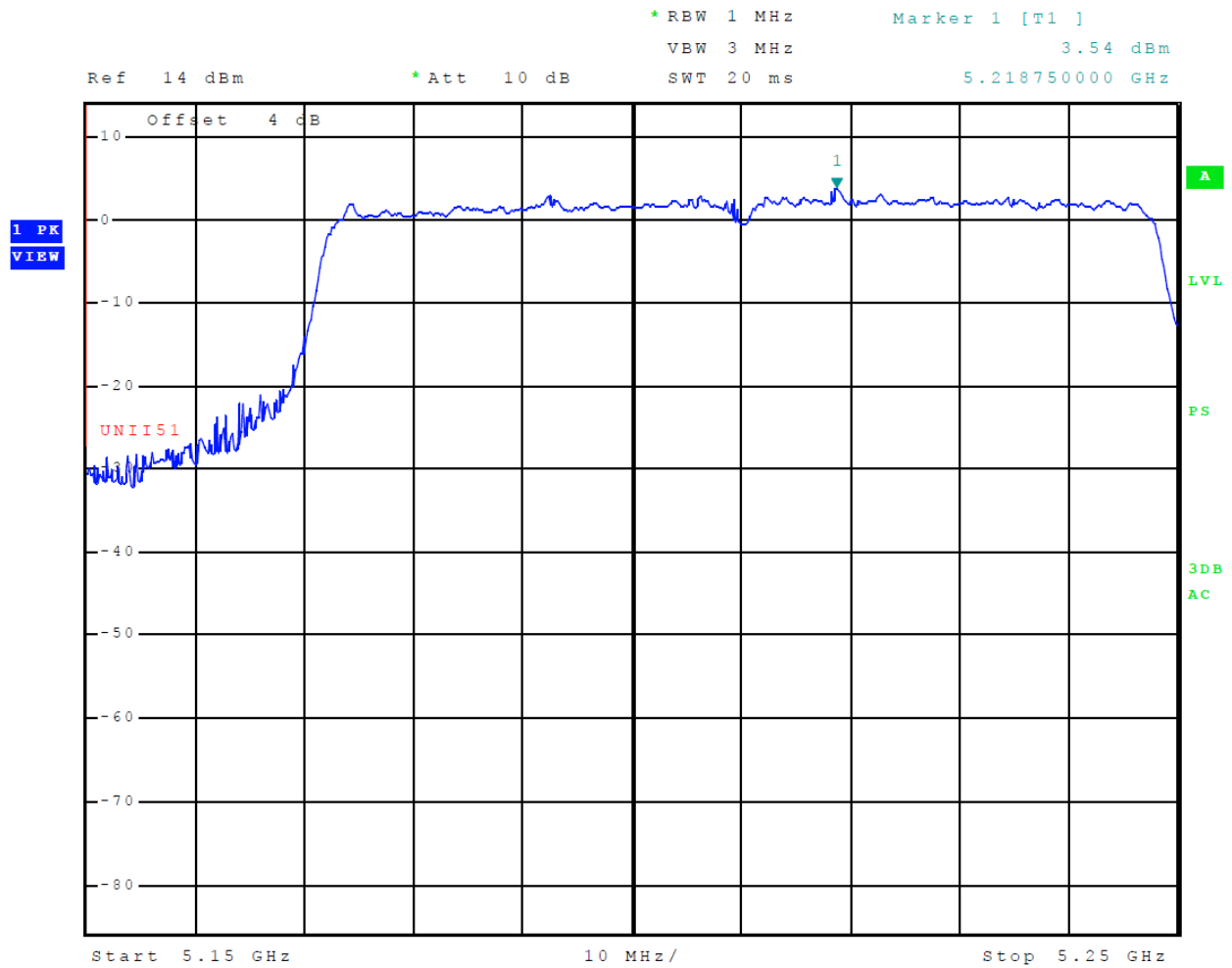

Figure 410 Plot of Transmitter Emissions (Across 5150-5250 MHz Band, Chain 1, 802.11ac)

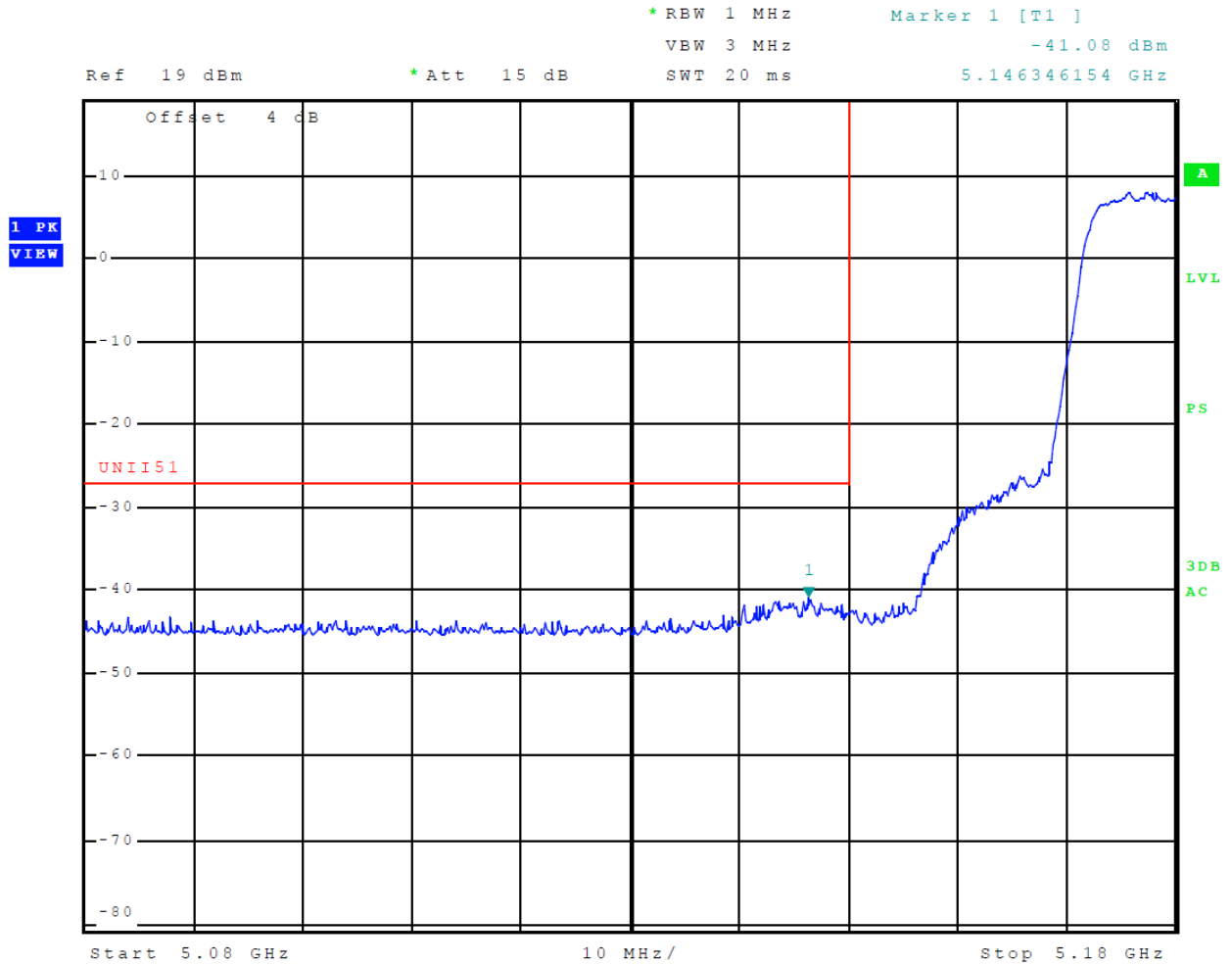

Figure 11 Plot of Transmitter Low Band Edge (5150-5250 MHz Band, Chain 0, 802.11a)

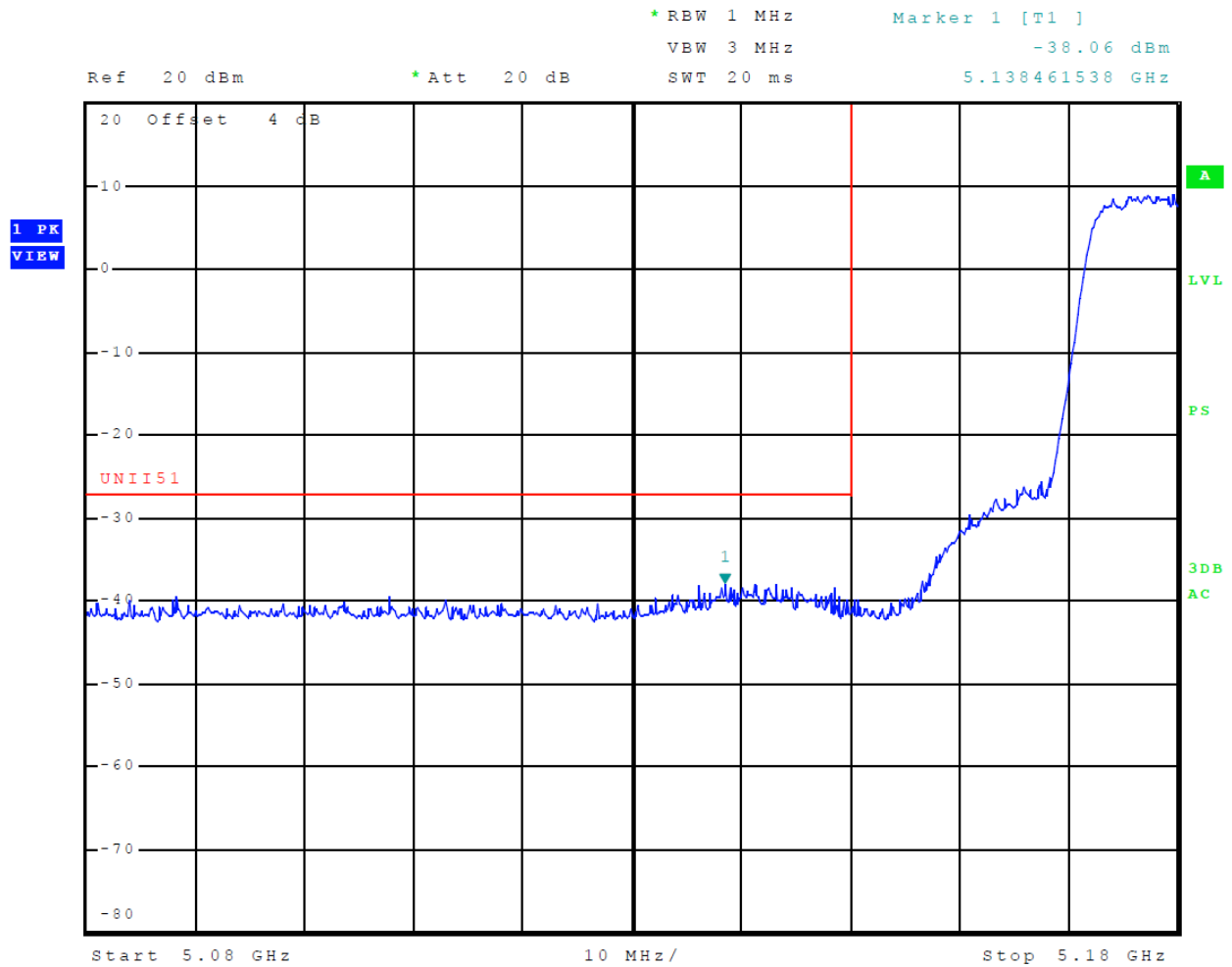

Figure 12 Plot of Transmitter Low Band Edge (5150-5250 MHz Band, Chain 1, 802.11a)

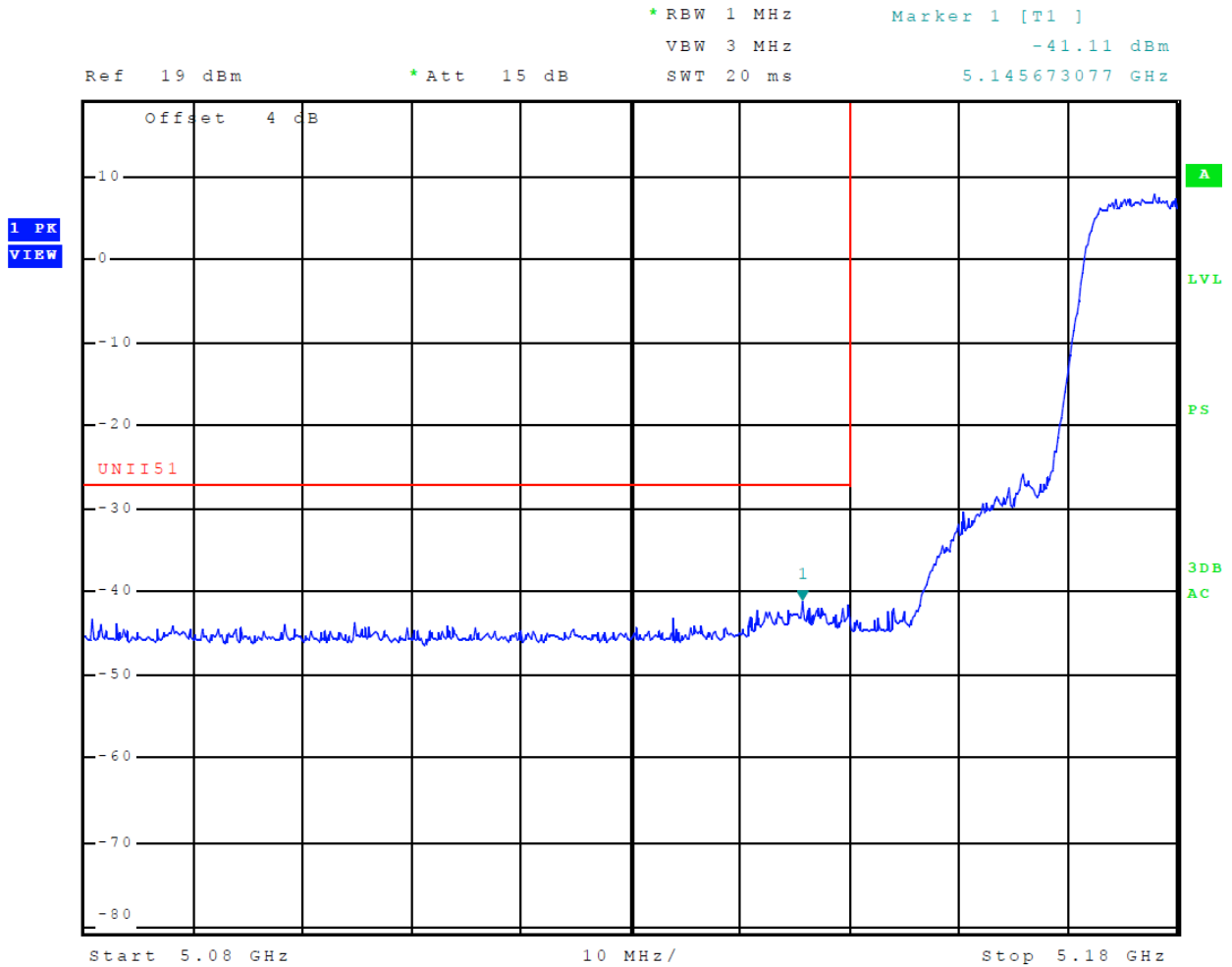

Figure 13 Plot of Transmitter Low Band Edge (5150-5250 MHz Band, Chain 0, 802.11n)

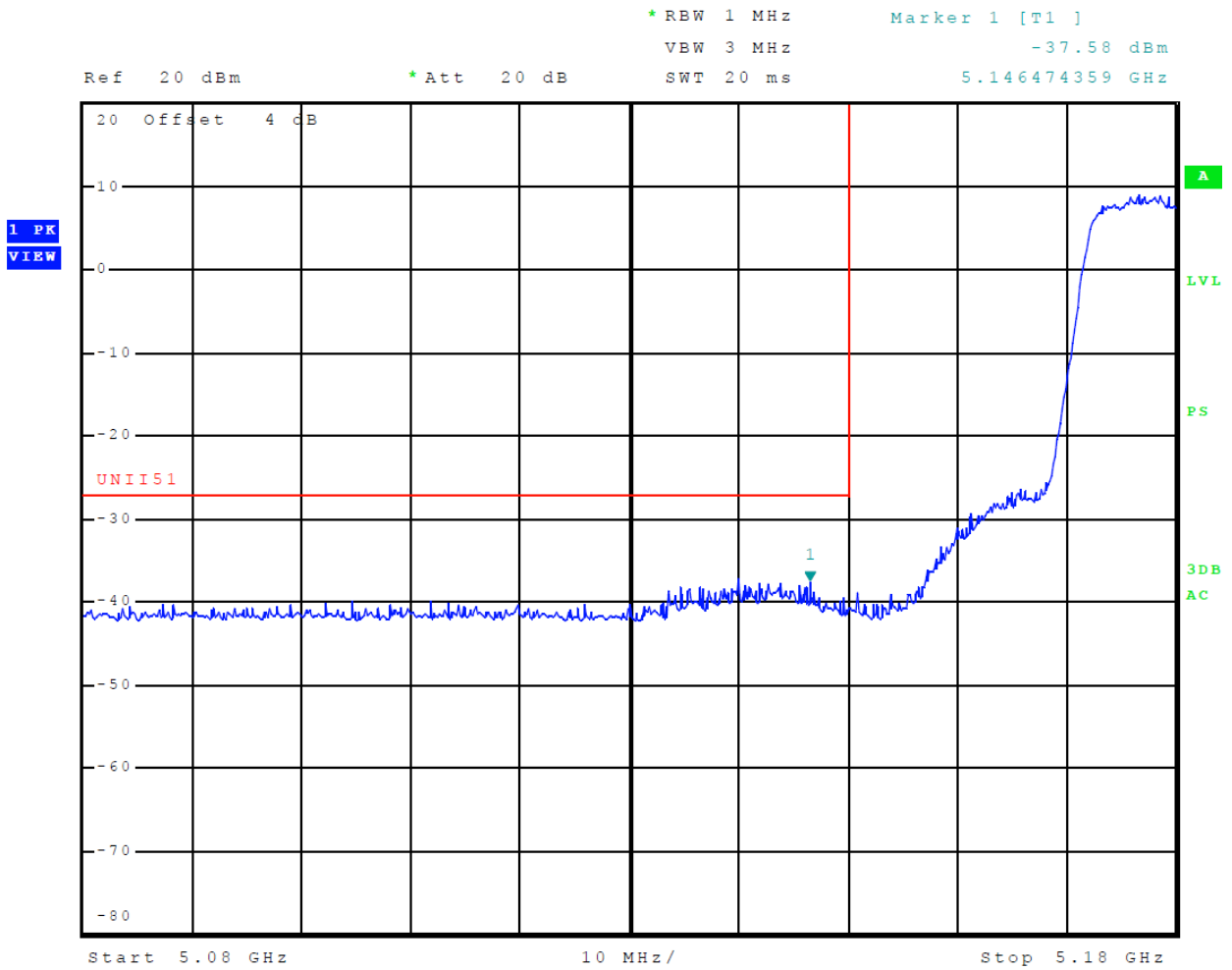

Figure 14 Plot of Transmitter Low Band Edge (5150-5250 MHz Band, Chain 1, 802.11n)

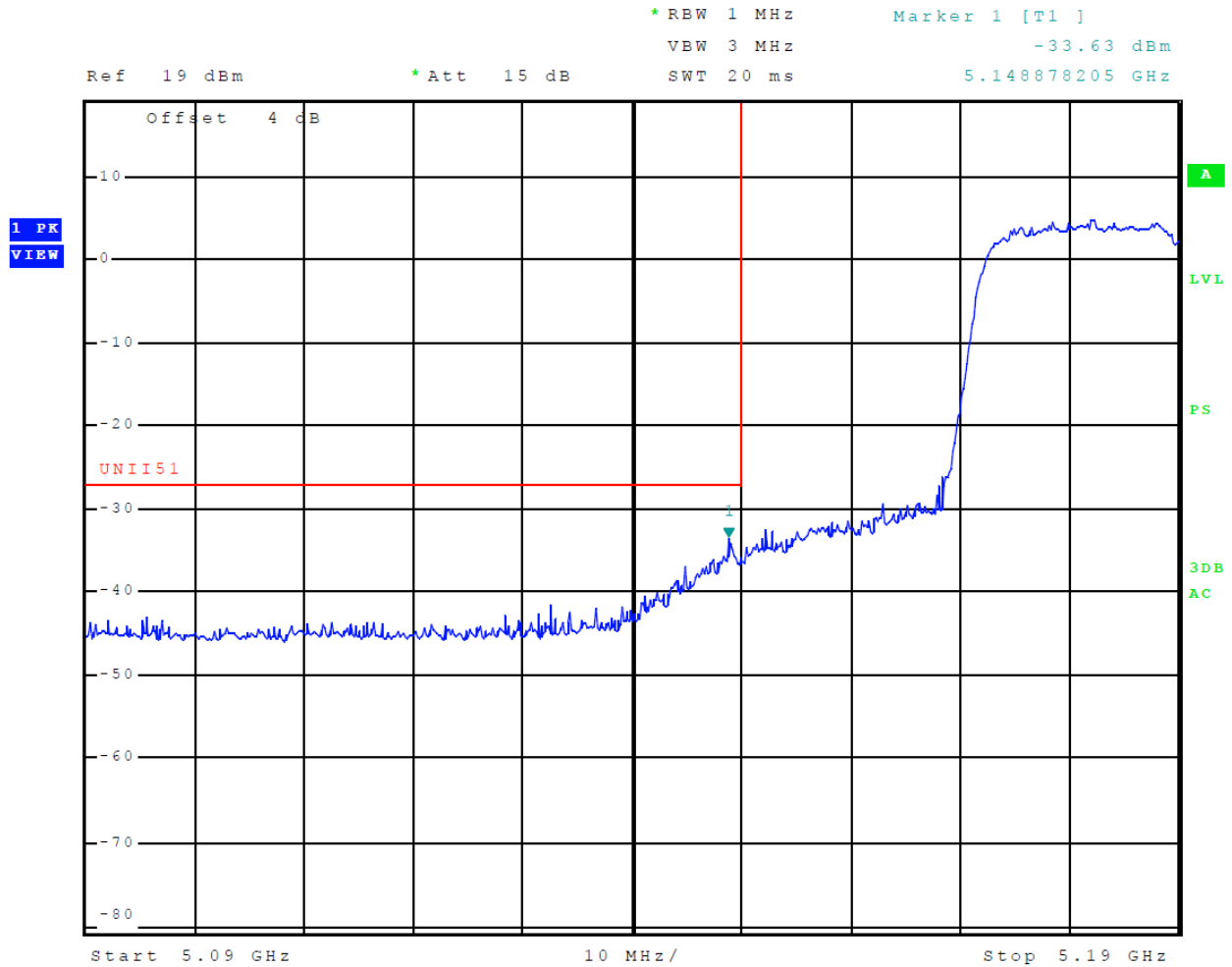

Figure 15 Plot of Transmitter Low Band Edge (5150-5250 MHz Band, Chain 0, 802.11n40)

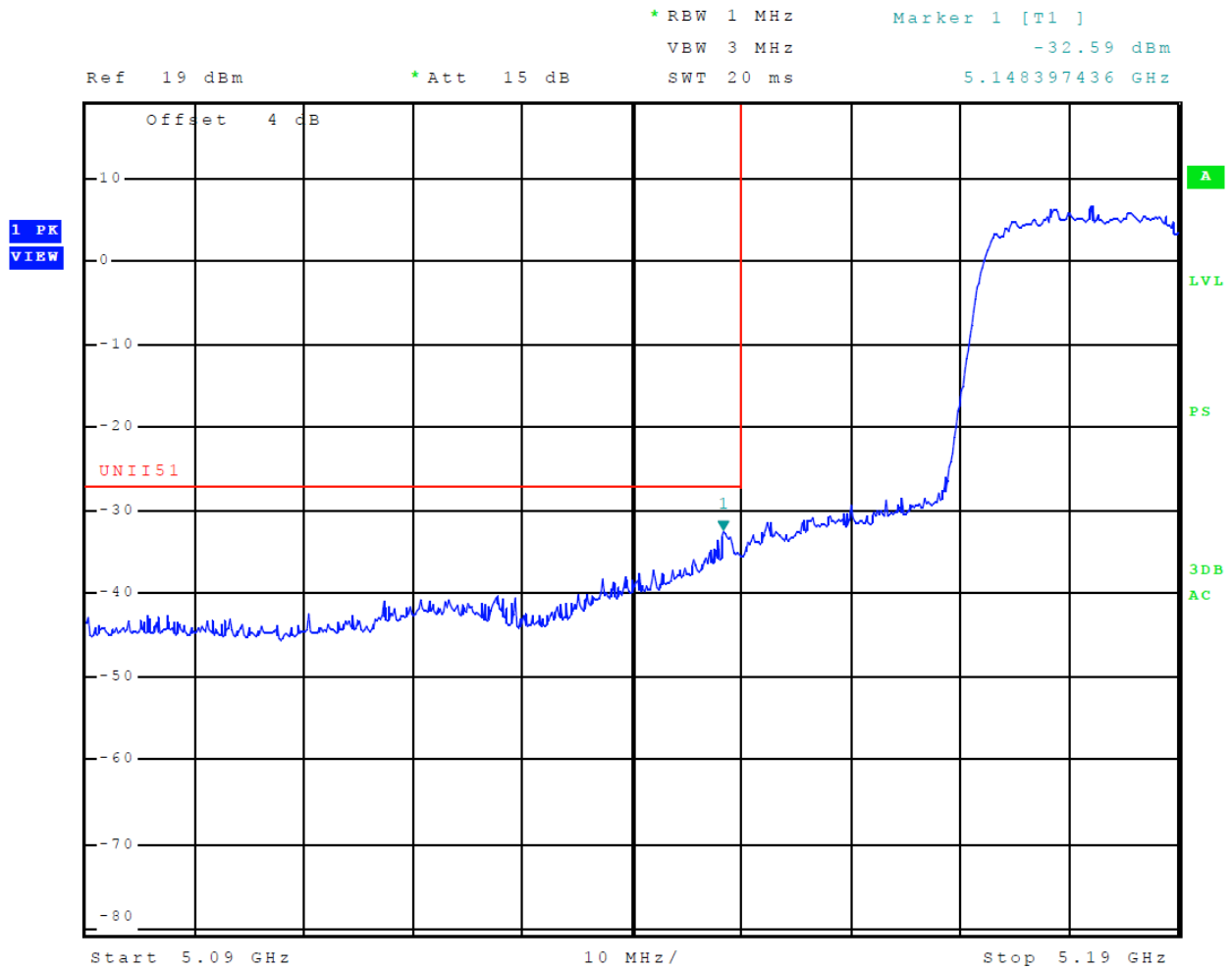

Figure 16 Plot of Transmitter Low Band Edge (5150-5250 MHz Band, Chain 1, 802.11n40)

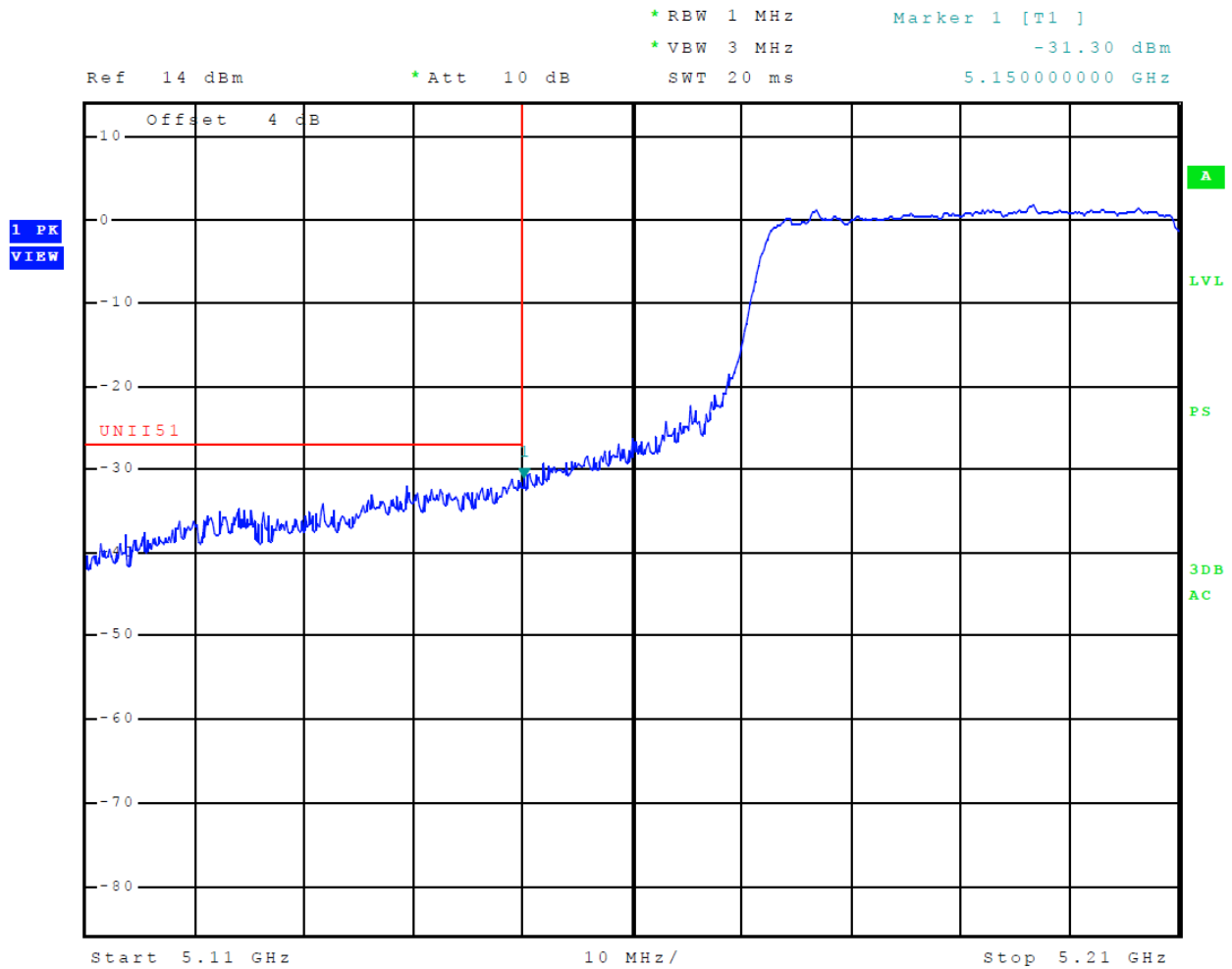

Figure 17 Plot of Transmitter Low Band Edge (5150-5250 MHz Band, Chain 0, 802.11ac)

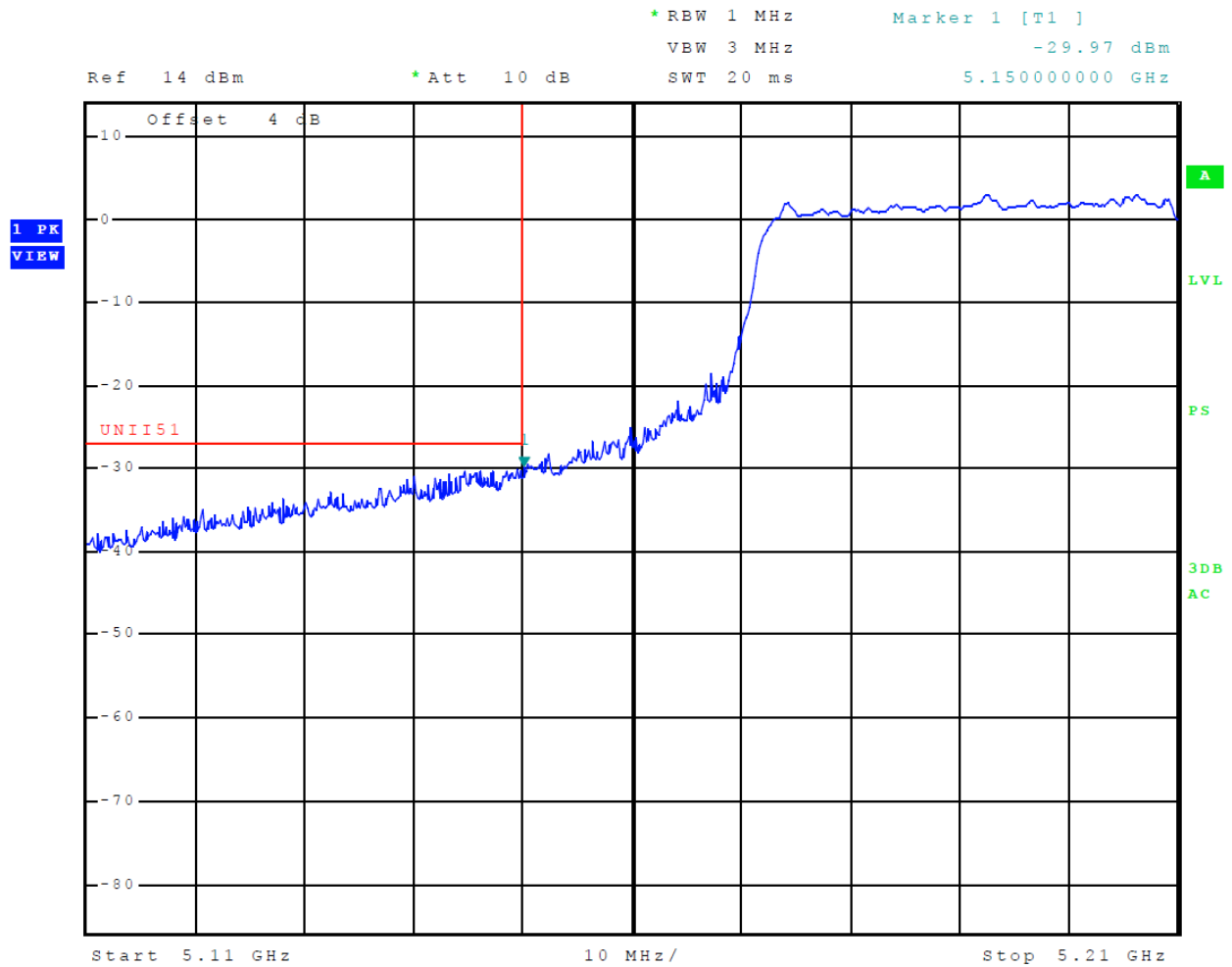

Figure 18 Plot of Transmitter Low Band Edge (5150-5250 MHz Band, Chain 1, 802.11ac)

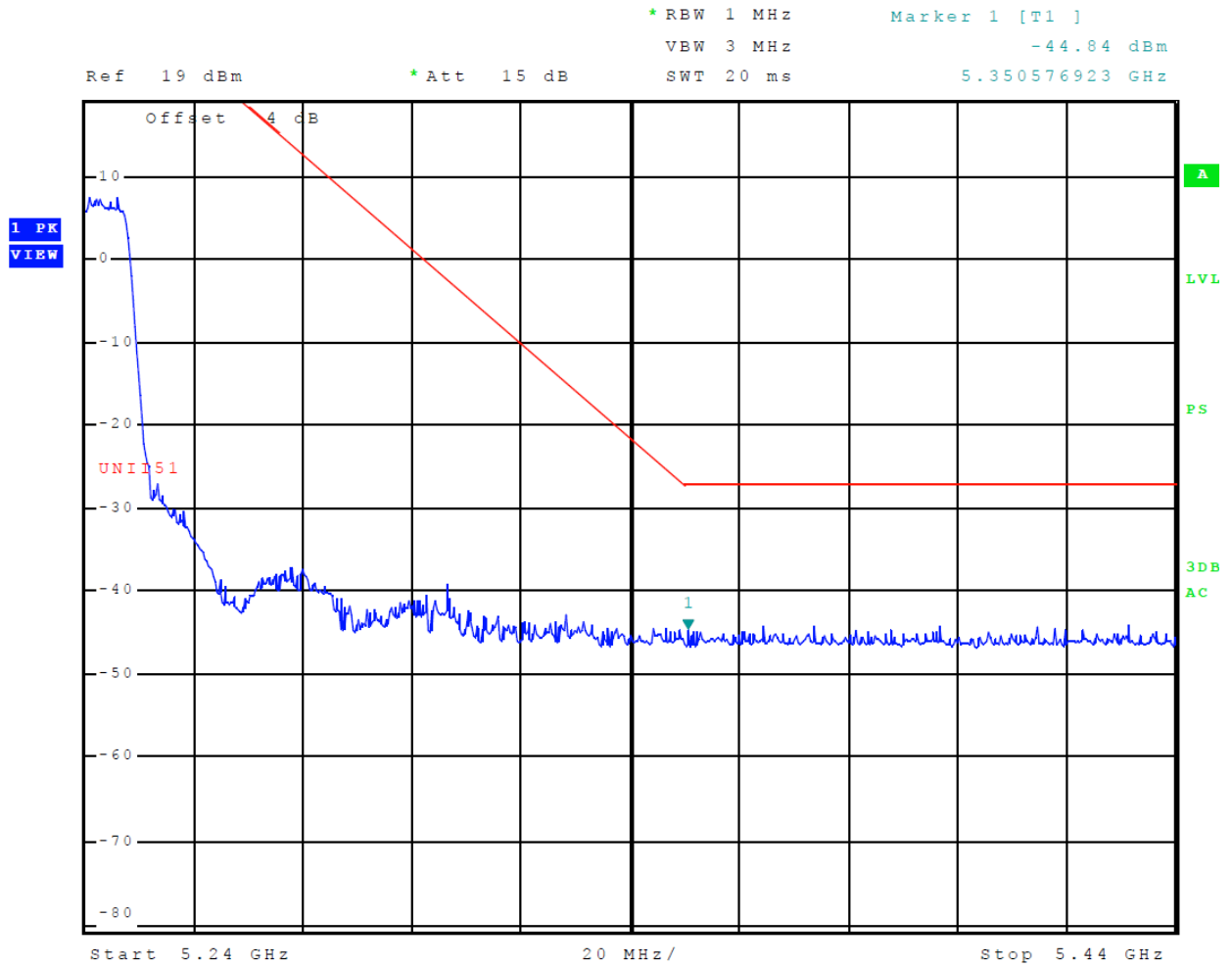

Figure 19 Plot of Transmitter High Band Edge (5150-5250 MHz Band, Chain 0, 802.11a)

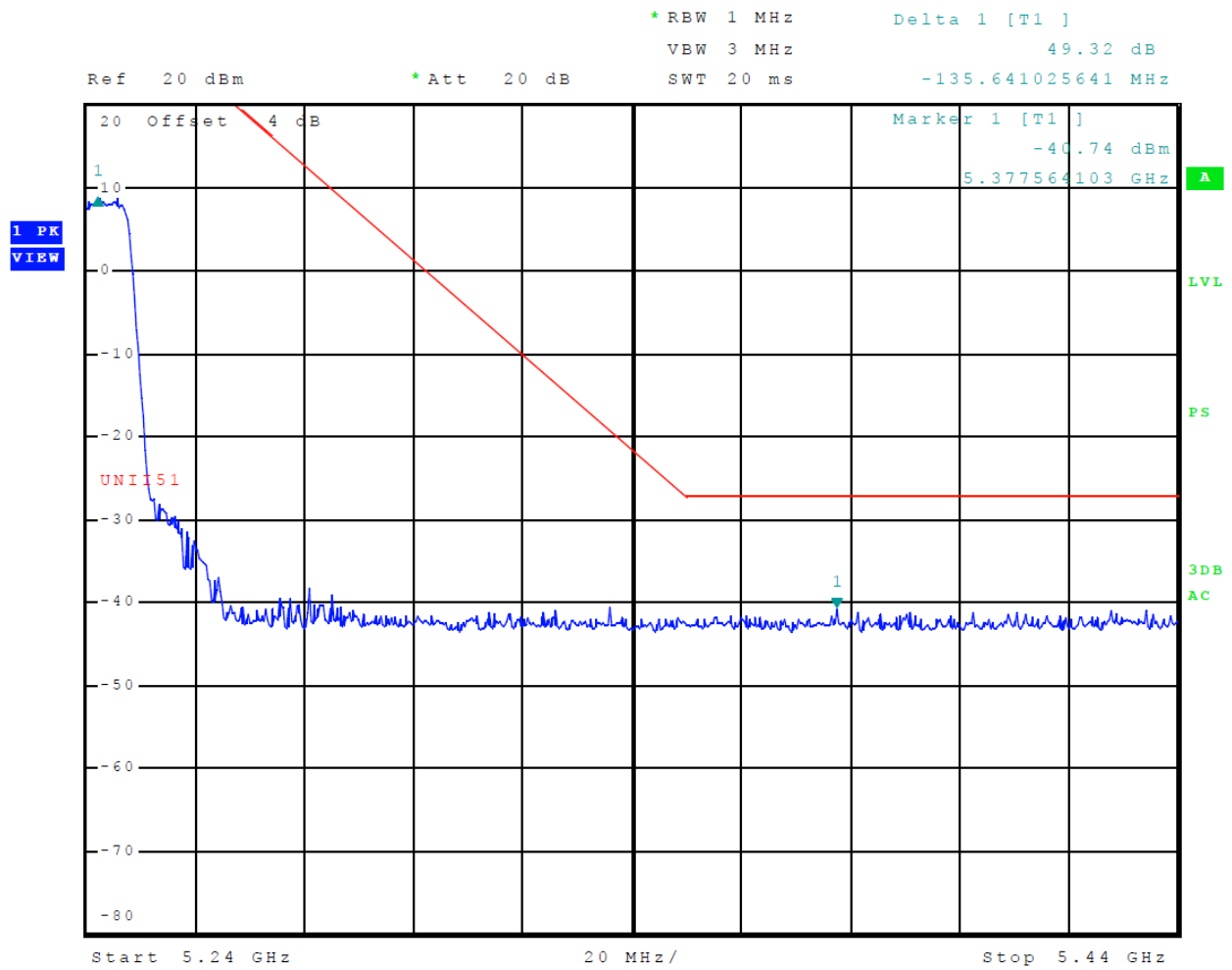

Figure 20 Plot of Transmitter High Band Edge (5150-5250 MHz Band, Chain 1, 802.11a)

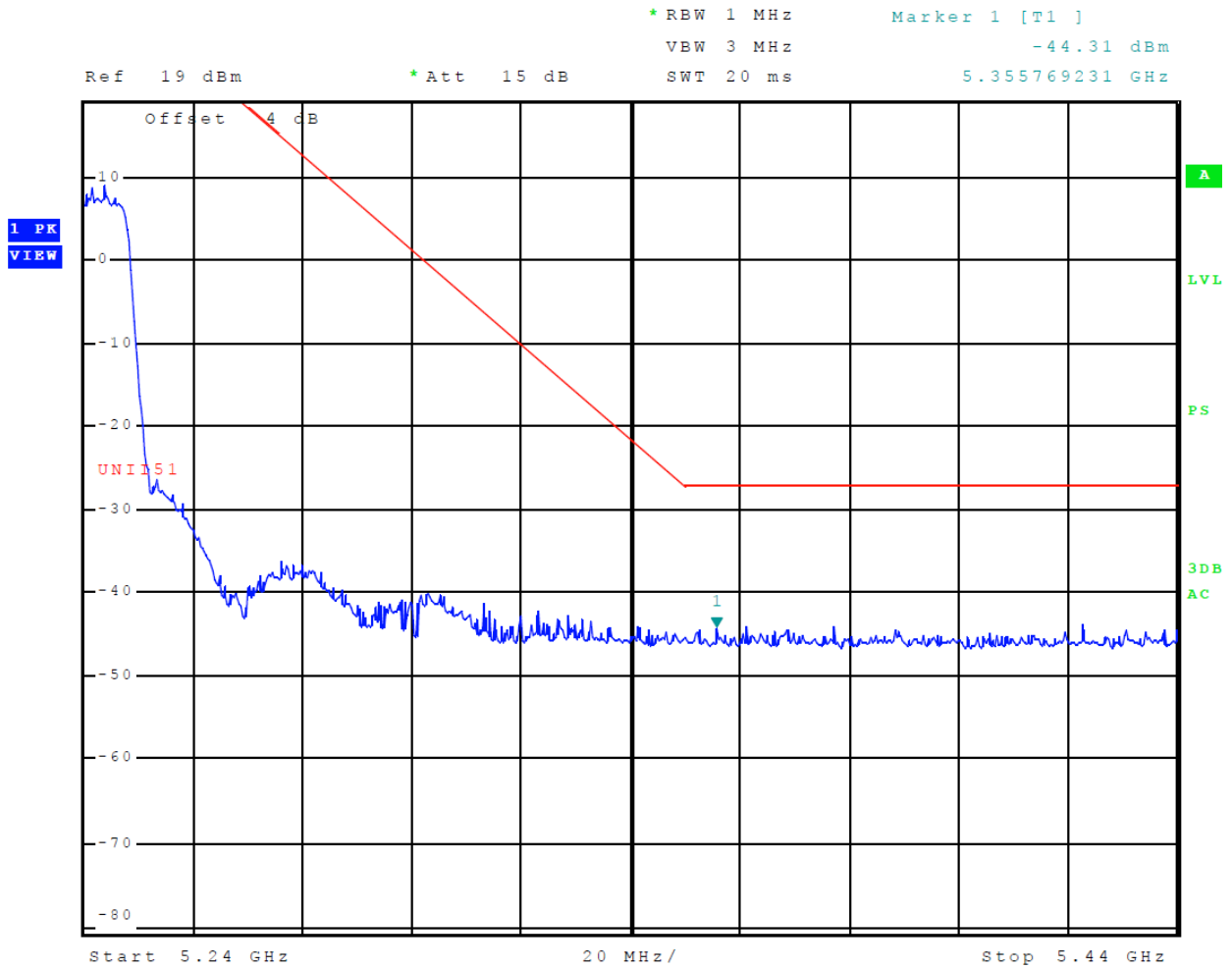

Figure 21 Plot of Transmitter High Band Edge (5150-5250 MHz Band, Chain 0, 802.11n)

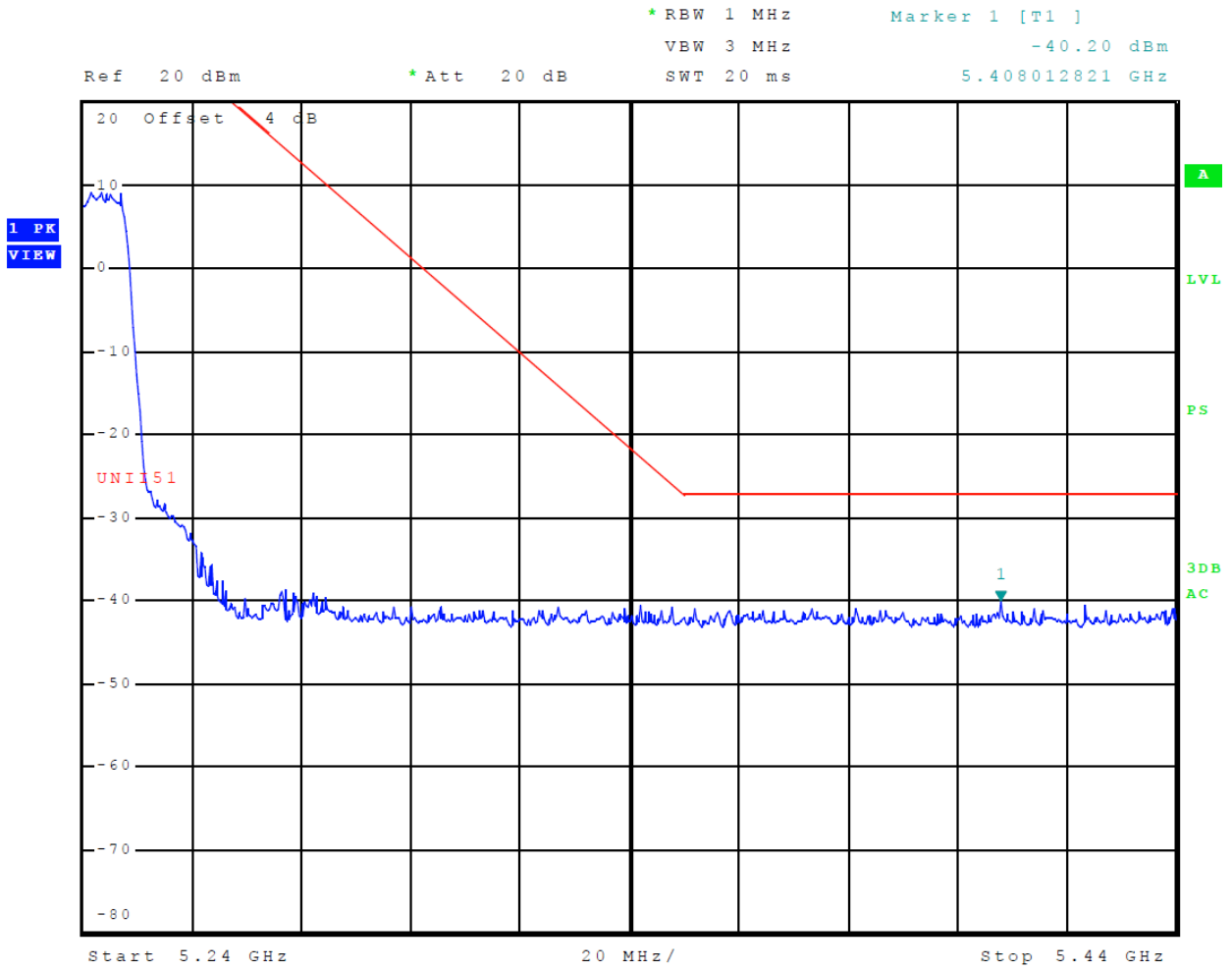

Figure 22 Plot of Transmitter High Band Edge (5150-5250 MHz Band, Chain 1, 802.11n)

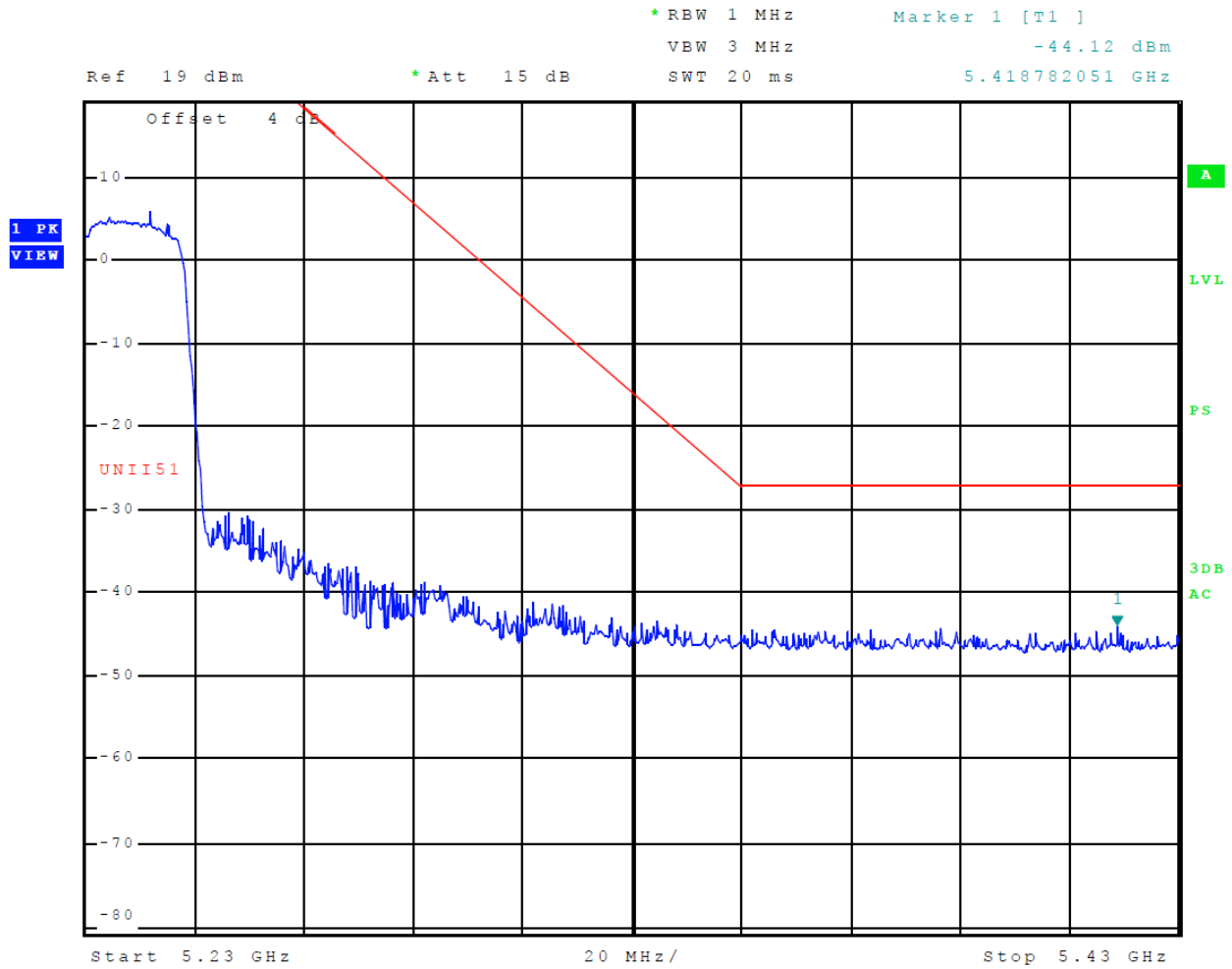

Figure 23 Plot of Transmitter High Band Edge (5150-5250 MHz Band, Chain 0, 802.11n40)

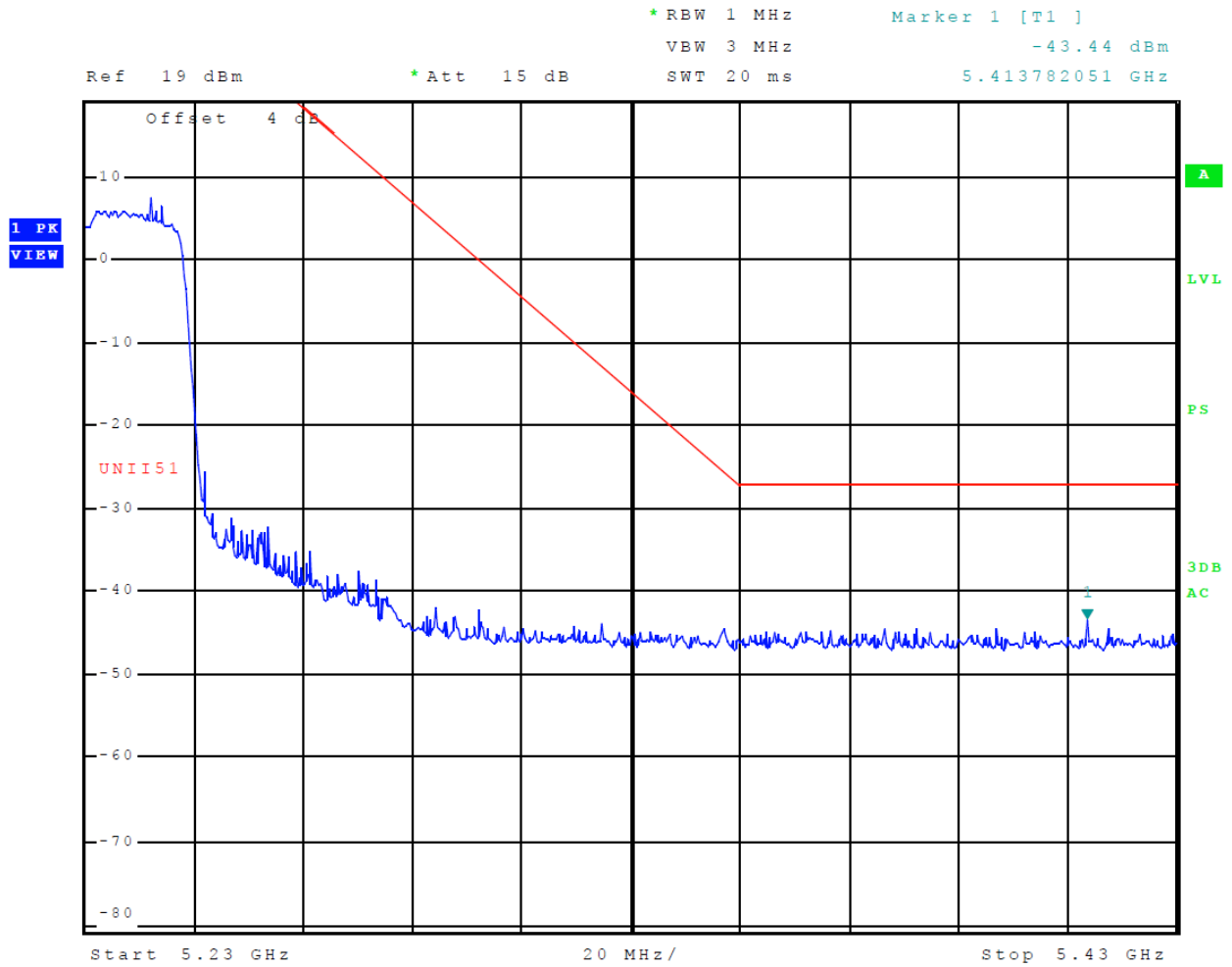

Figure 24 Plot of Transmitter High Band Edge (5150-5250 MHz Band, Chain 1, 802.11n40)

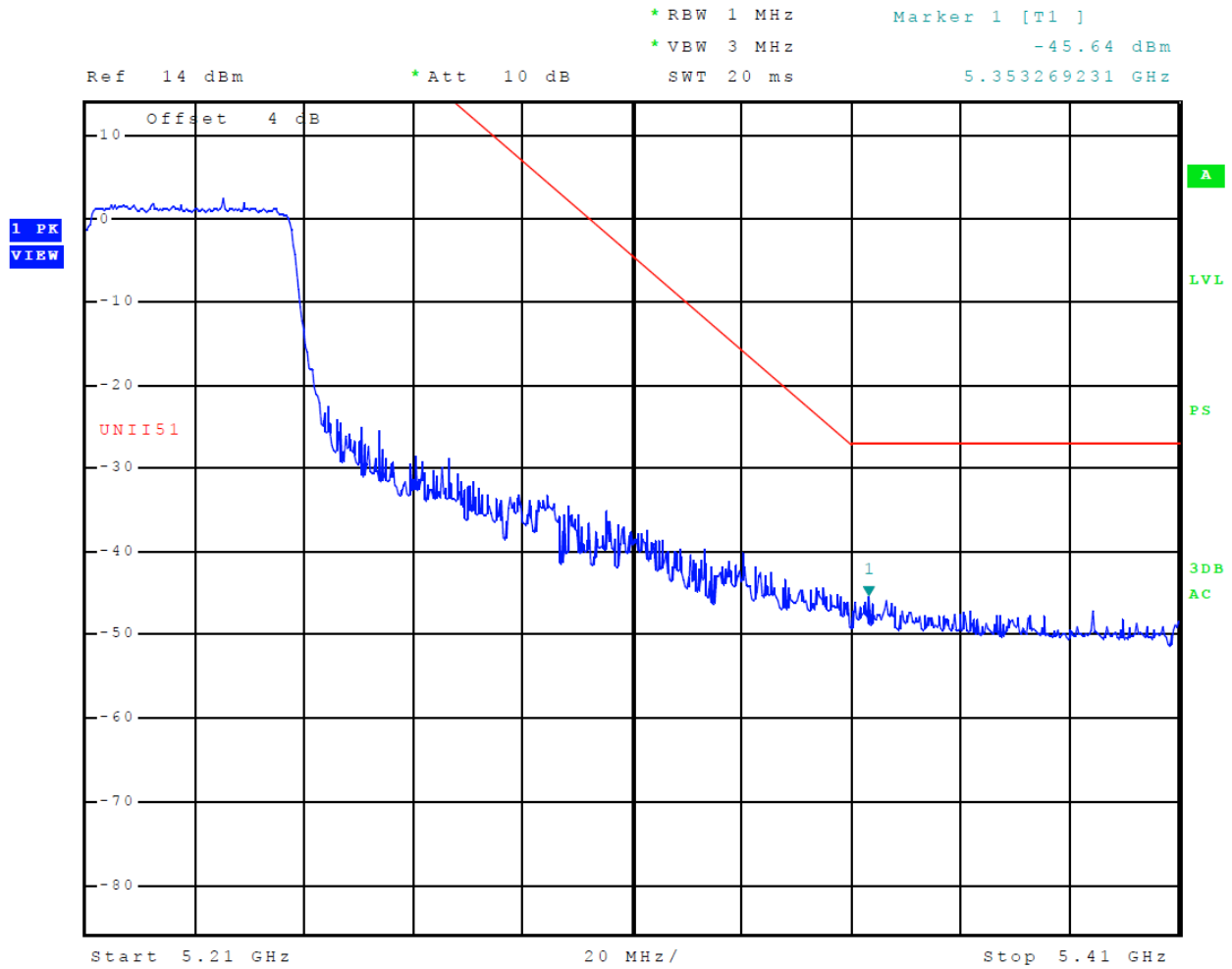

Figure 25 Plot of Transmitter High Band Edge (5150-5250 MHz Band, Chain 0, 802.11ac)

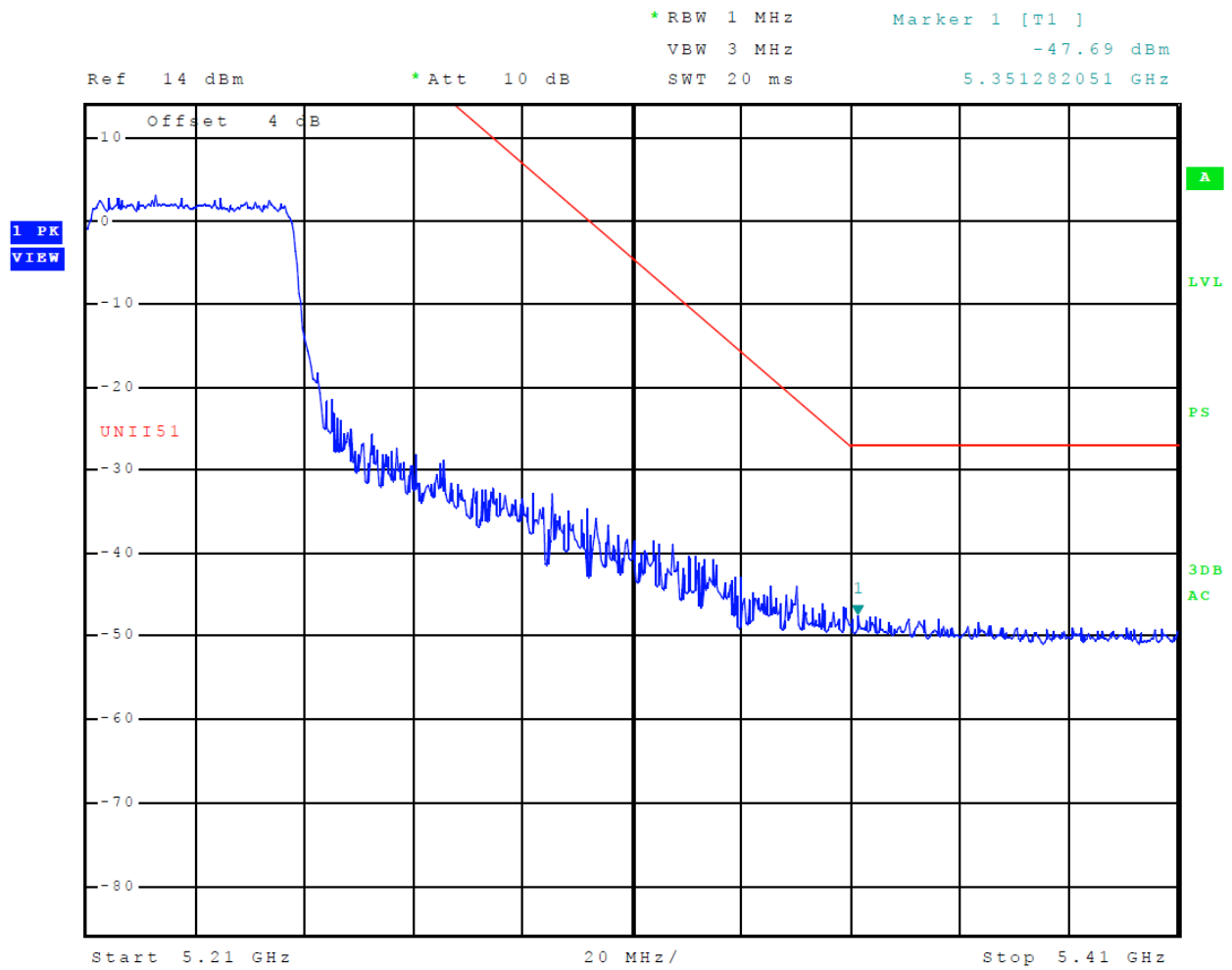

Figure 26 Plot of Transmitter High Band Edge (5150-5250 MHz Band, Chain 1, 802.11ac)

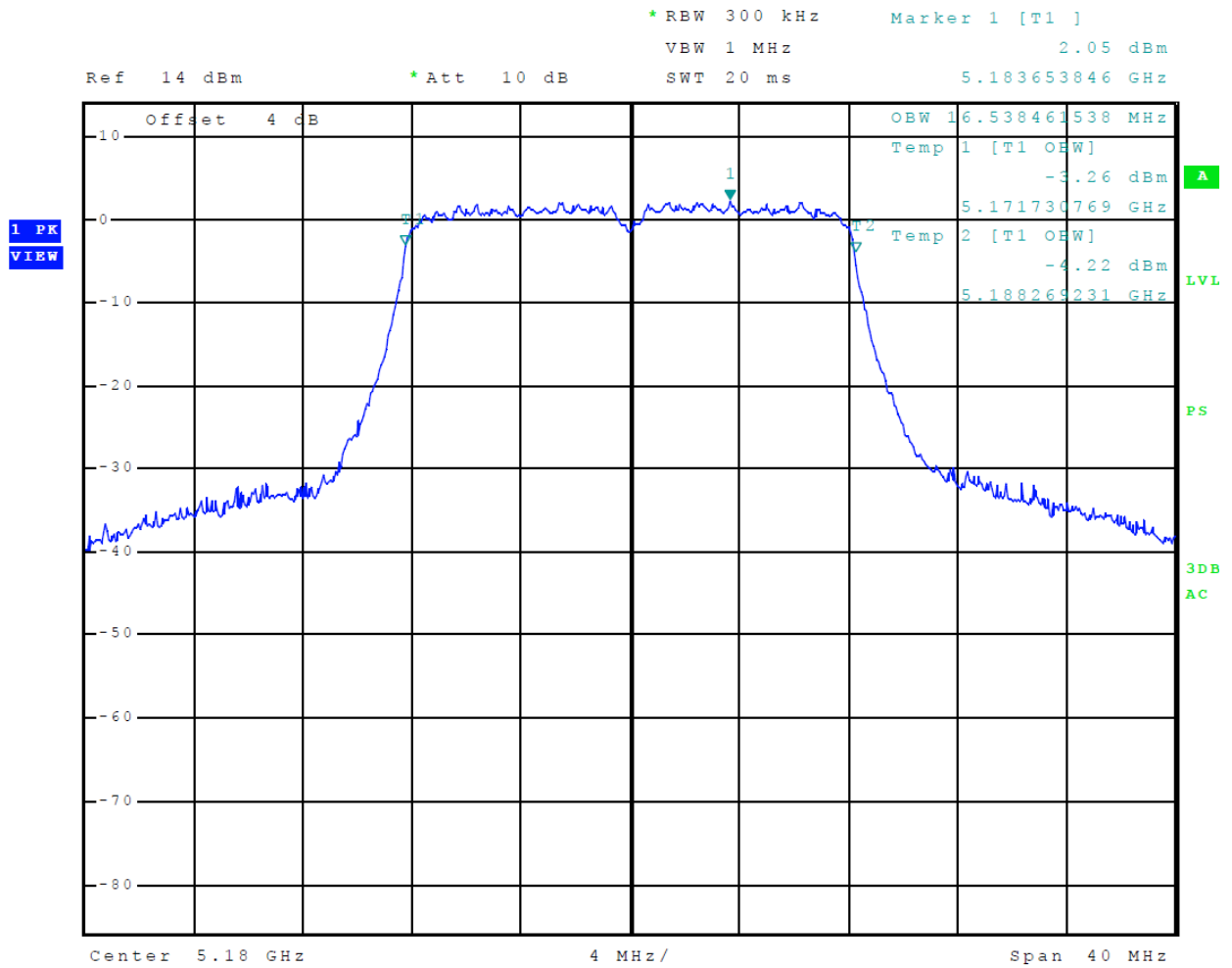

Figure 27 Plot of Transmitter Emissions (5150-5250 MHz Band, 802.11a, Chain 0, 99% OBW)

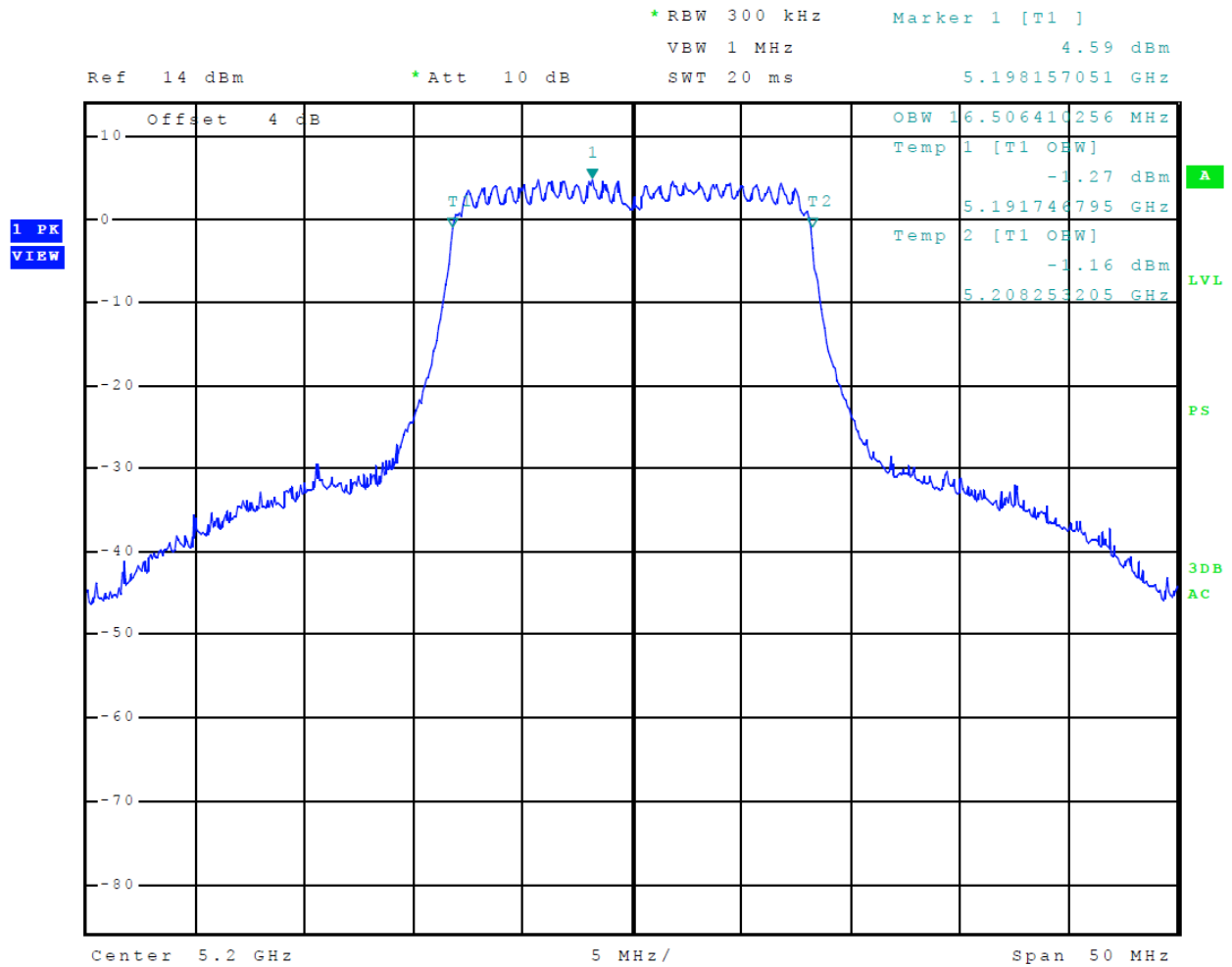

Figure 28 Plot of Transmitter Emissions (5150-5250 MHz Band, 802.11a, Chain 1, 99% OBW)

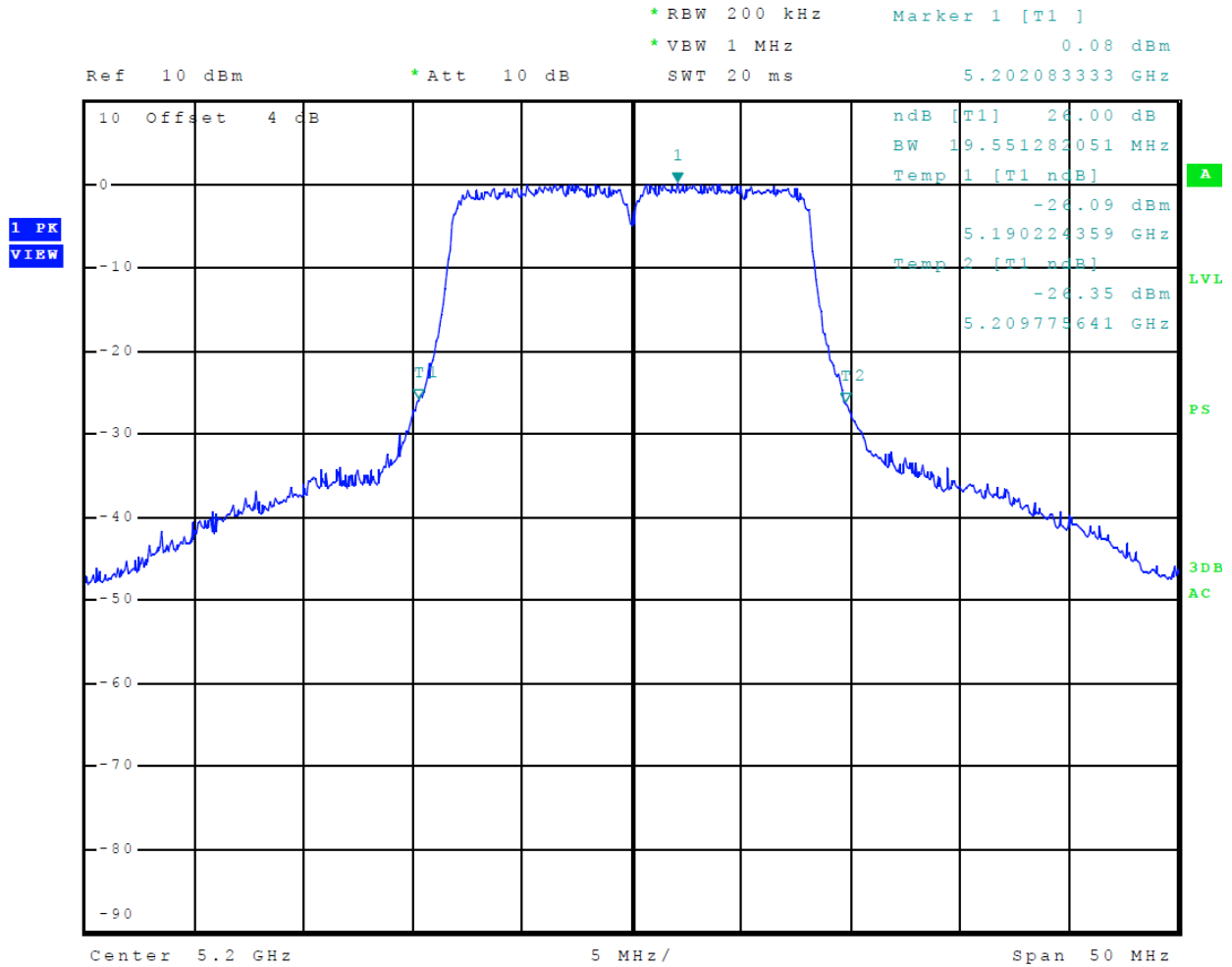

Figure 29 Plot of Transmitter Emissions (5150-5250 MHz Band, 802.11a, Chain 0, 26 dB OBW)

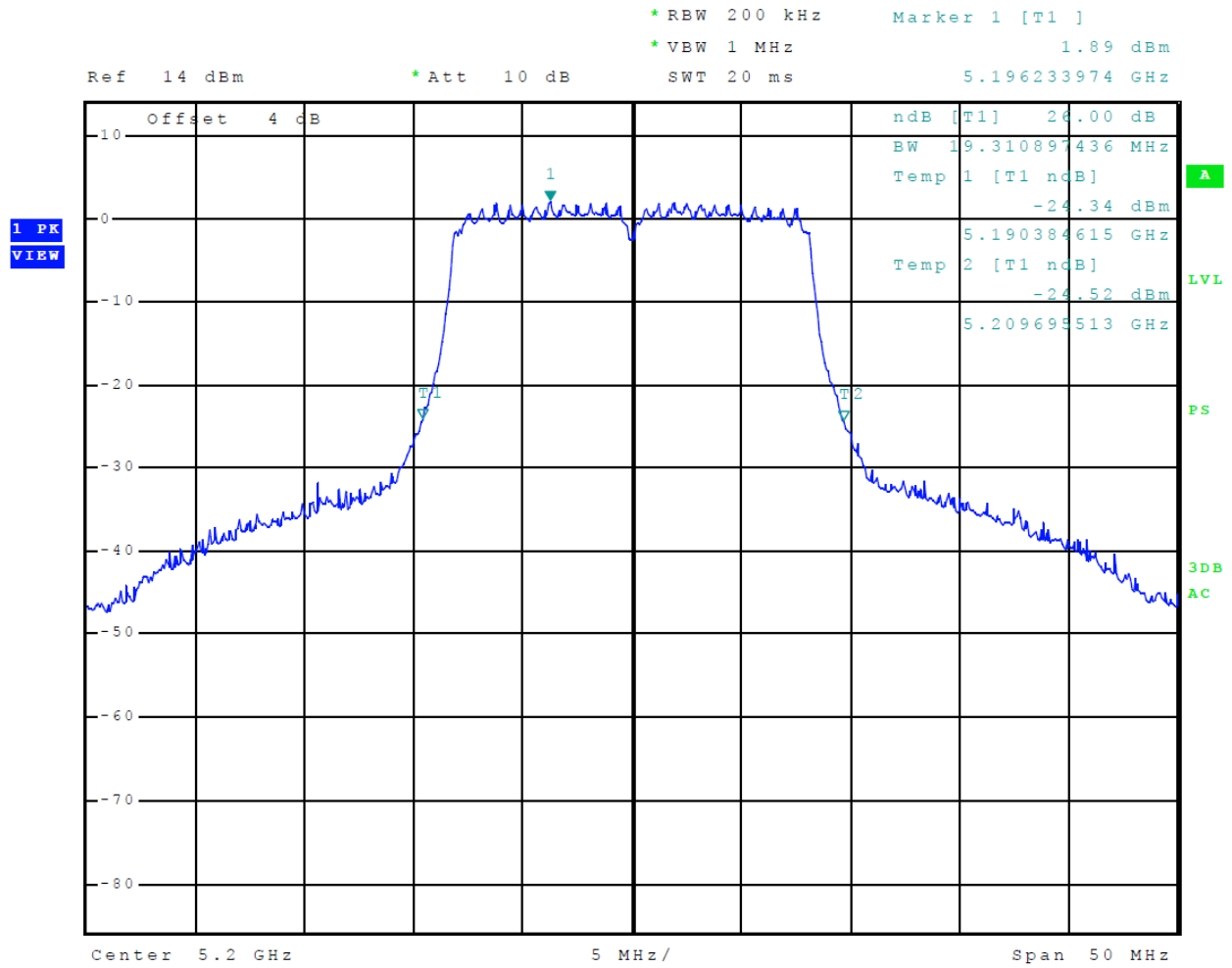

Figure 30 Plot of Transmitter Emissions (5150-5250 MHz Band, 802.11a, Chain 1, 26 dB OBW)

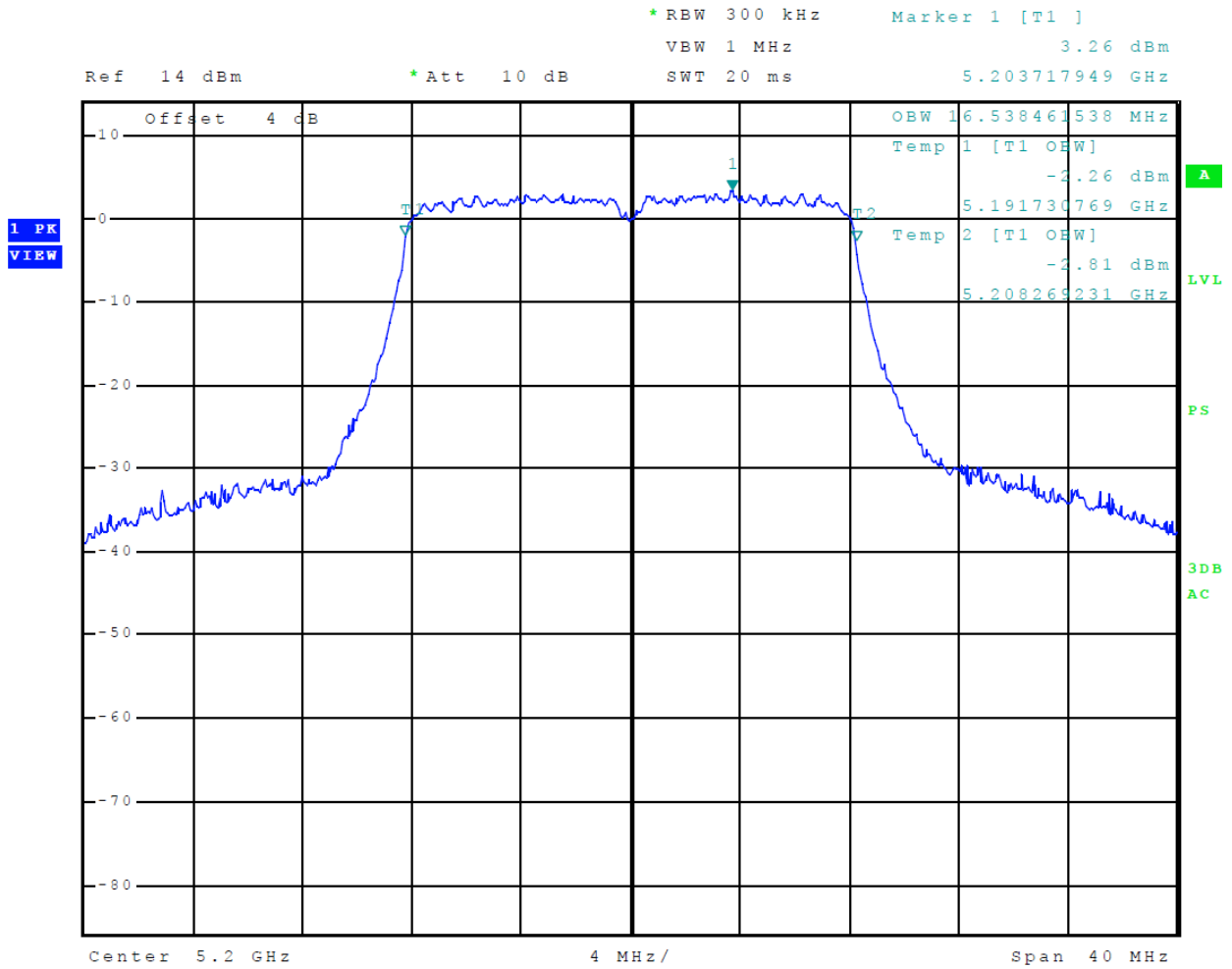

Figure 31 Plot of Transmitter Emissions (5150-5250 MHz Band, 802.11n, Chain 0, 99% OBW)

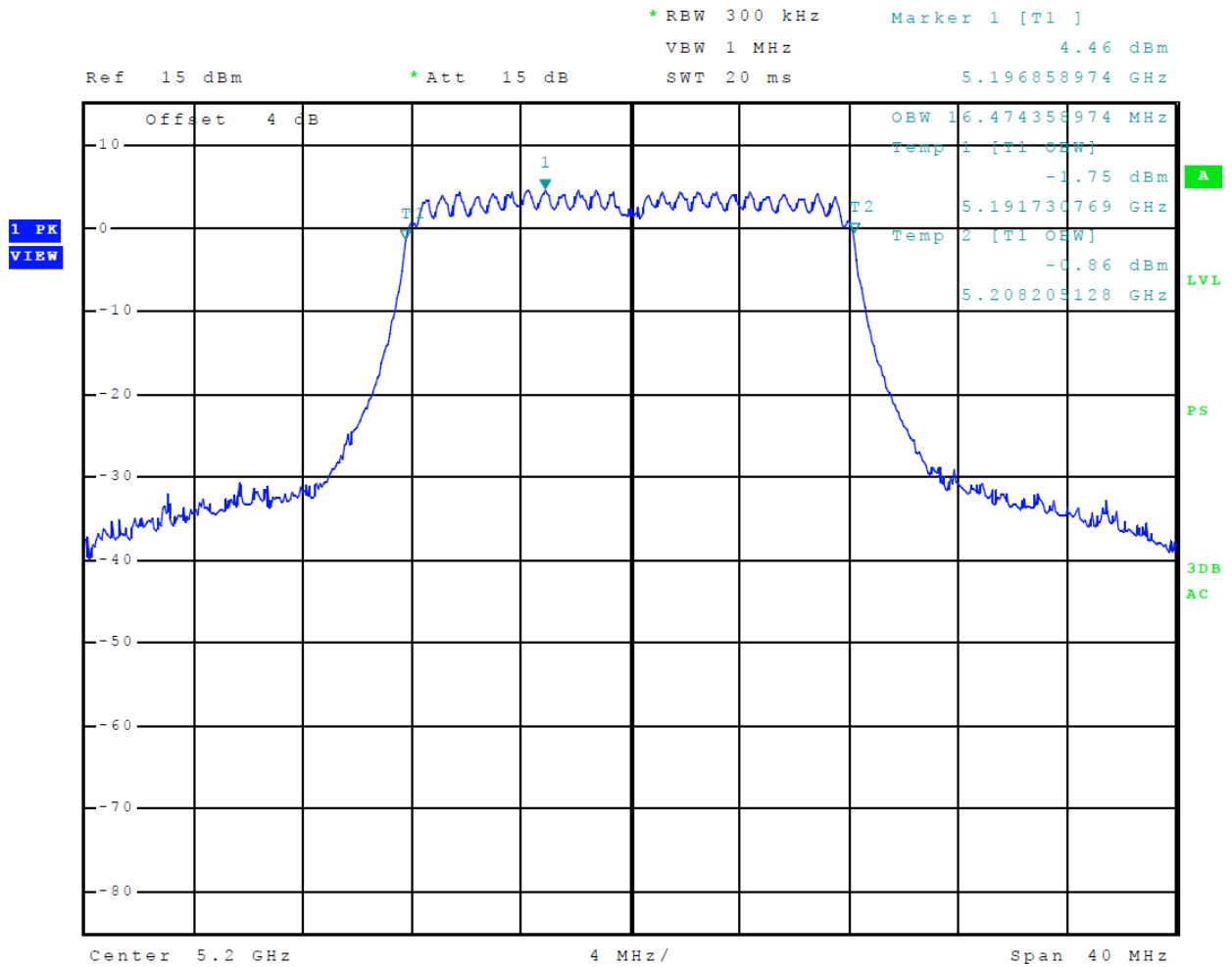

Figure 32 Plot of Transmitter Emissions (5150-5250 MHz Band, 802.11n, Chain 1, 99% OBW)

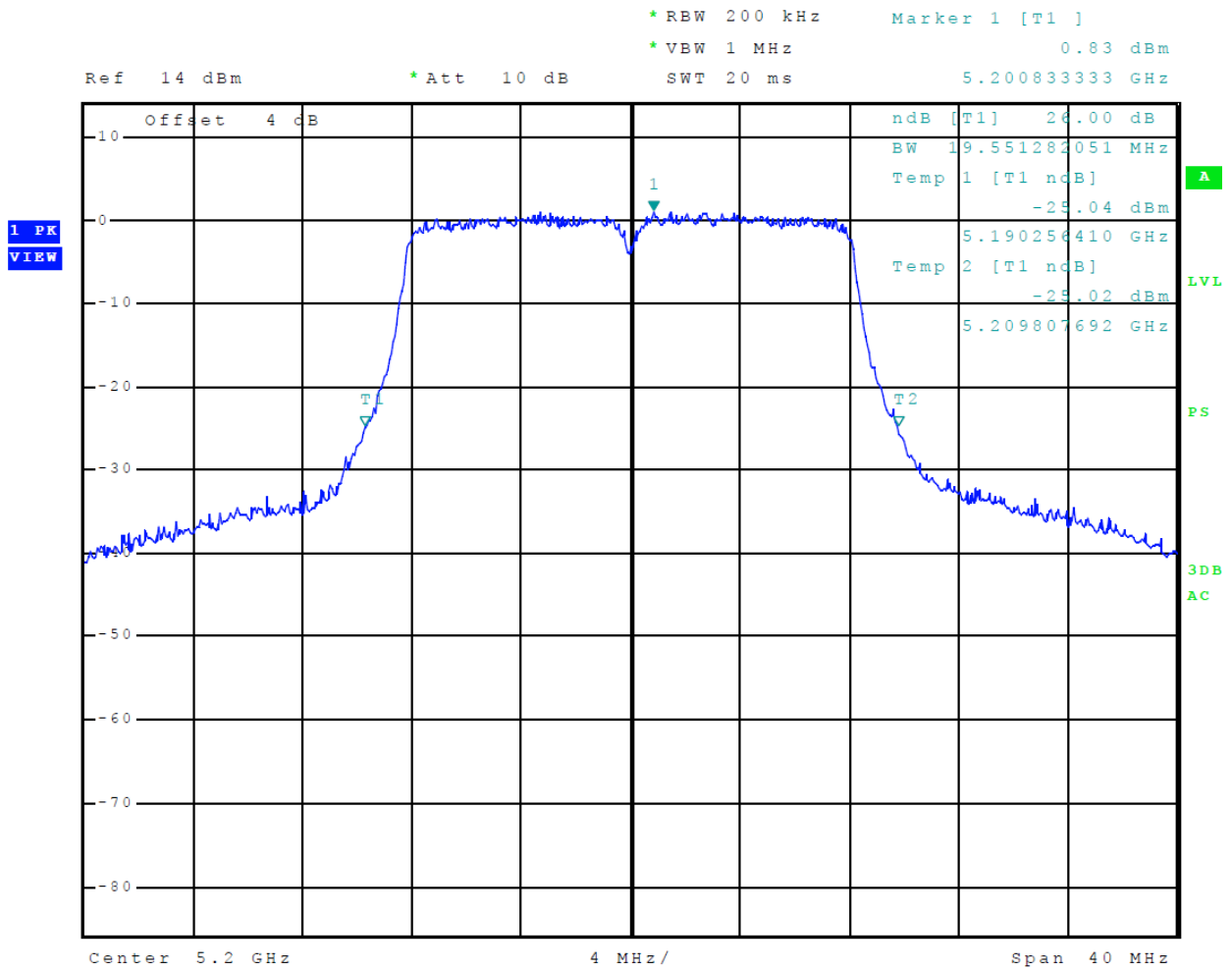

Figure 33 Plot of Transmitter Emissions (5150-5250 MHz Band, 802.11n, Chain 0, 26 dB OBW)

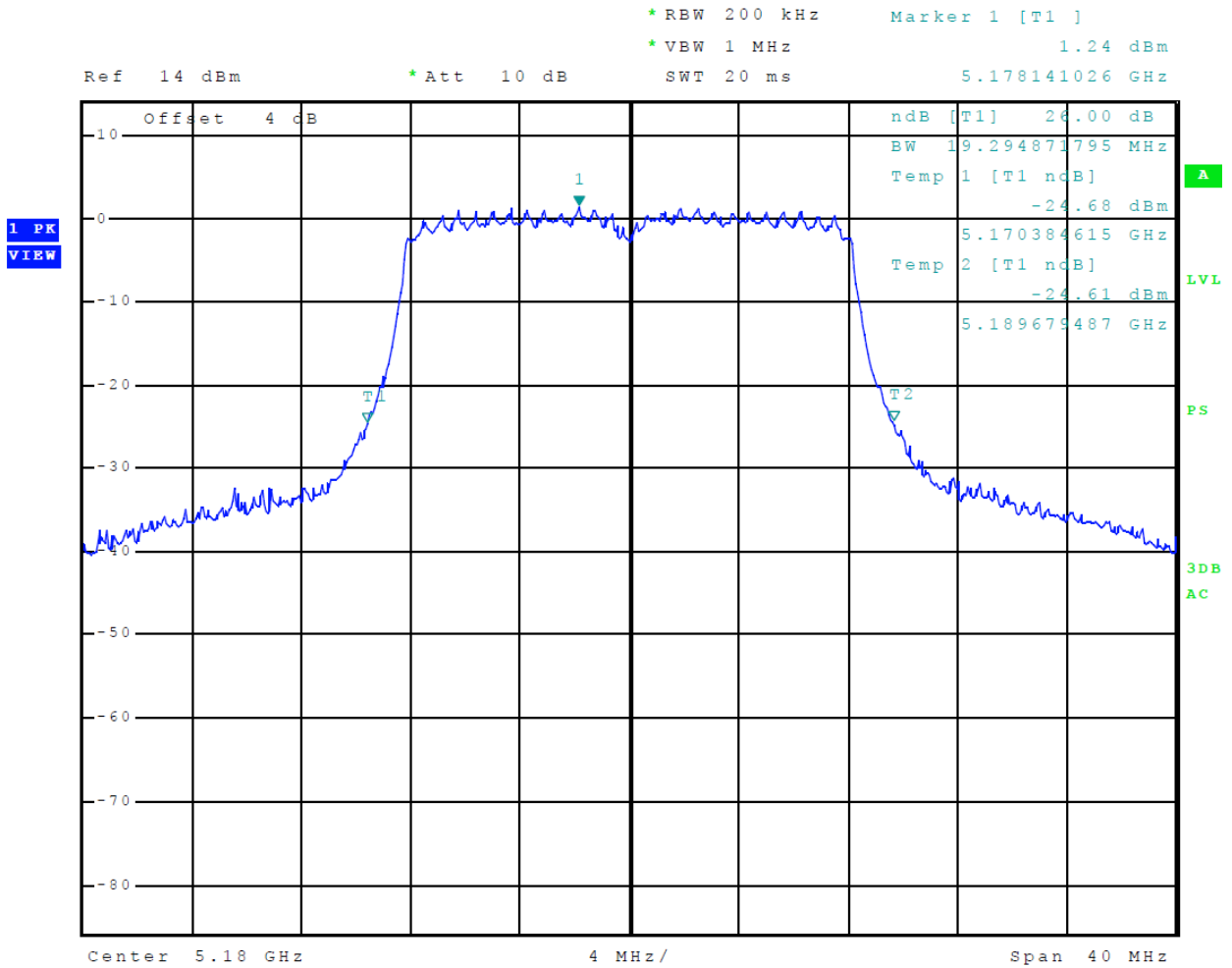

Figure 34 Plot of Transmitter Emissions (5150-5250 MHz Band, 802.11n, Chain 1, 26 dB OBW)

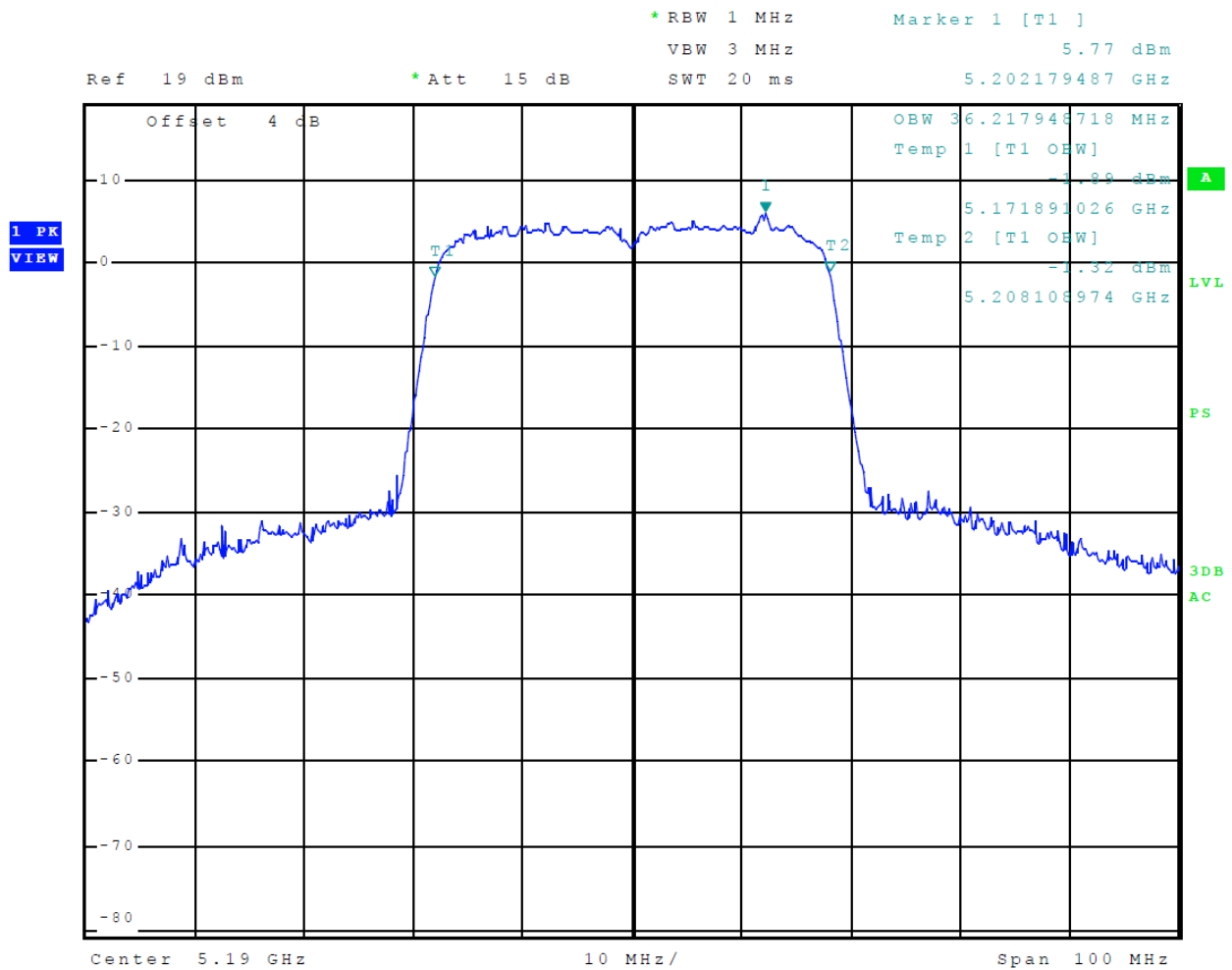

Figure 35 Plot of Transmitter Emissions (5150-5250 MHz Band, 802.11n40, Chain 0, 99% OBW)

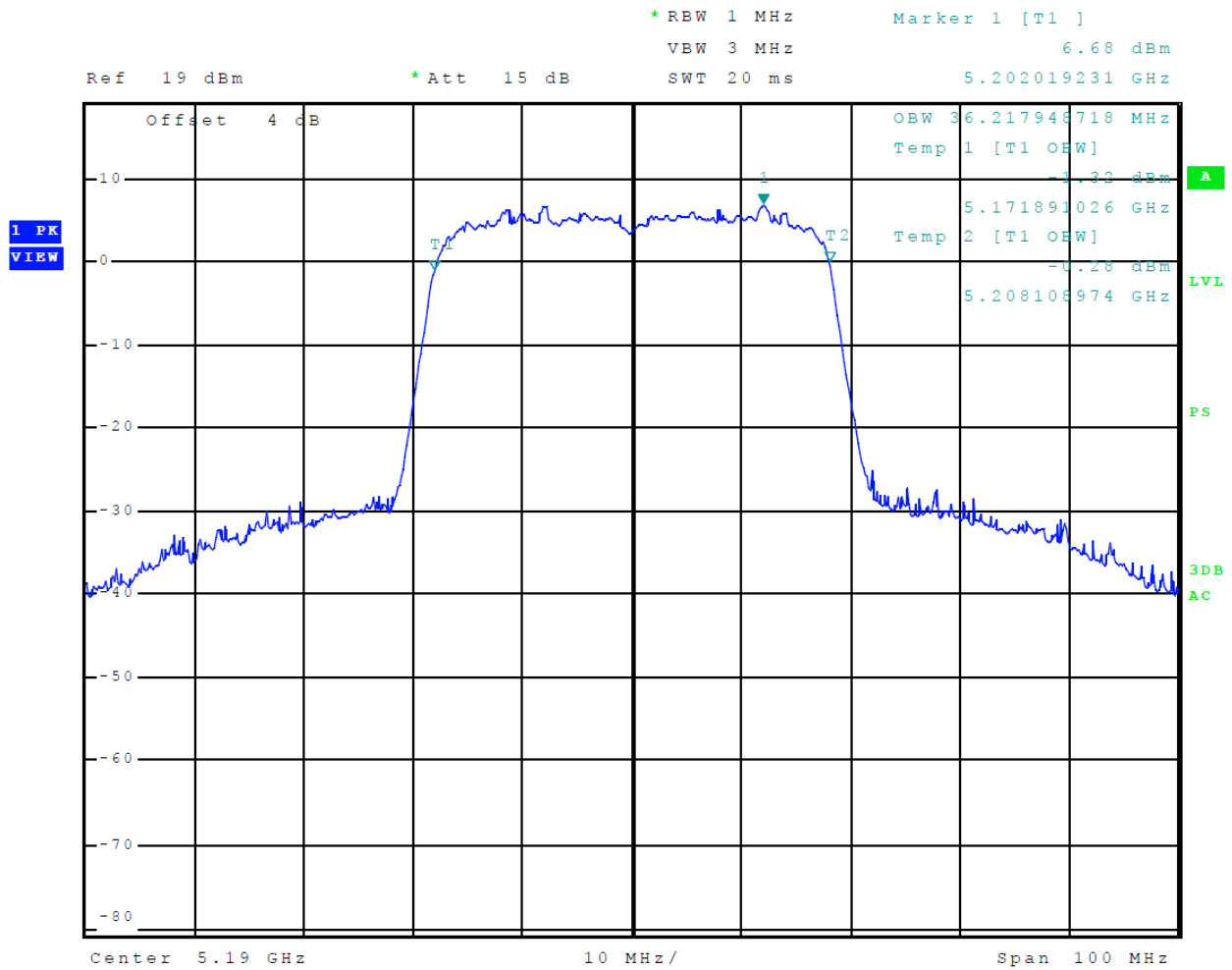

Figure 36 Plot of Transmitter Emissions (5150-5250 MHz Band, 802.11n40, Chain 1, 99% OBW)

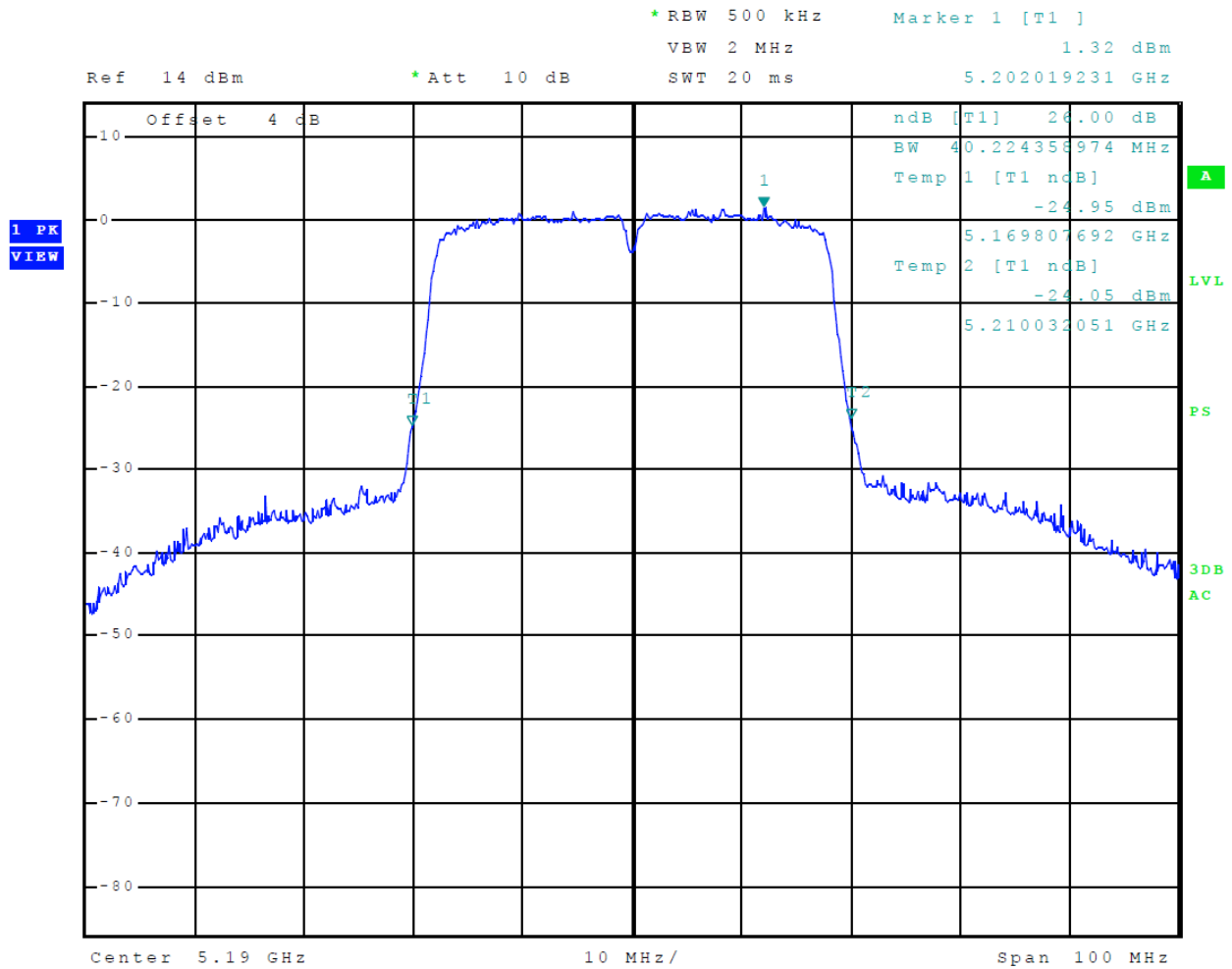

Figure 37 Plot of Transmitter Emissions (5150-5250 MHz Band, 802.11n40, Chain 0, 26 dB OBW)

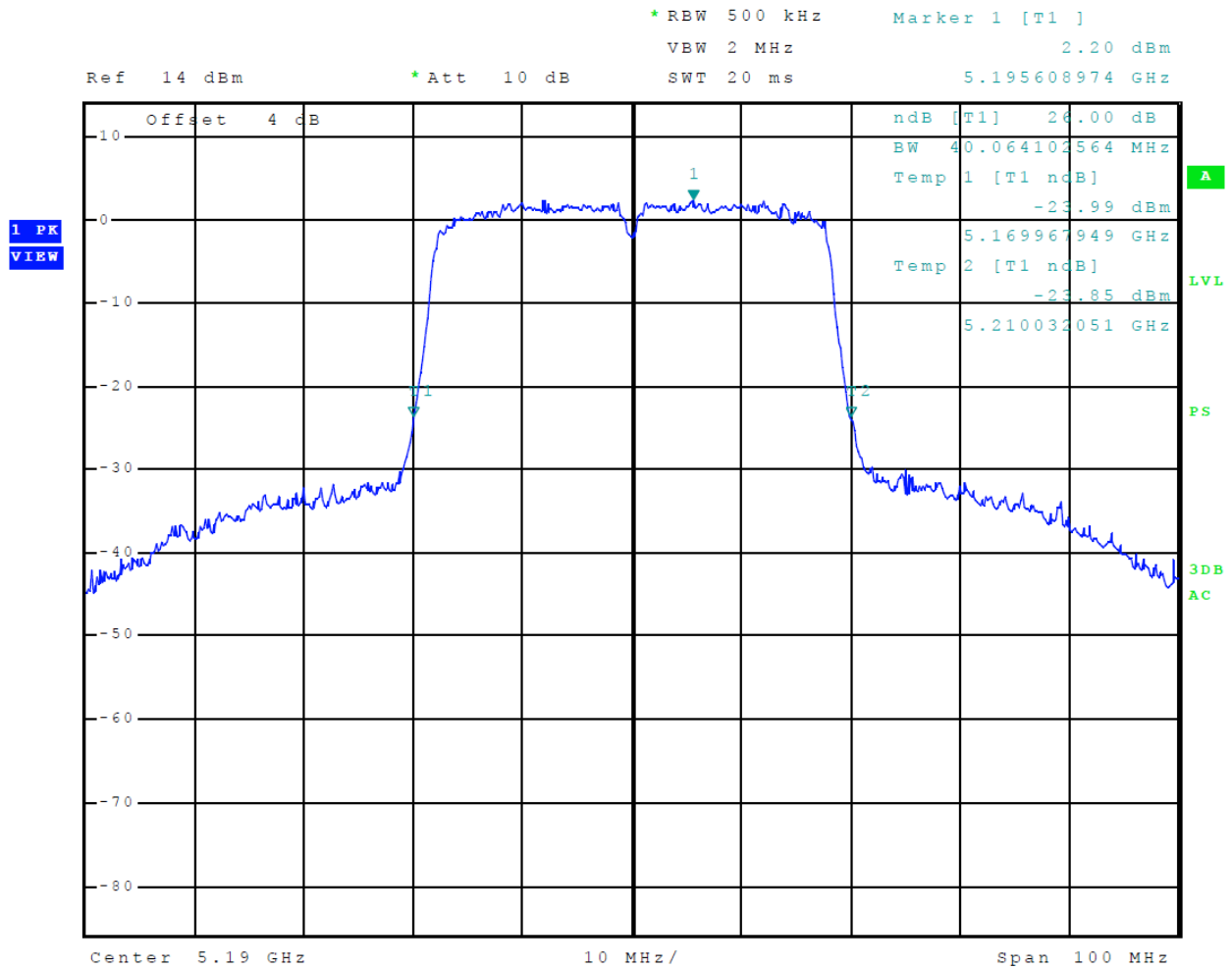

Figure 38 Plot of Transmitter Emissions (5150-5250 MHz Band, 802.11n40, Chain 1, 26 dB OBW)

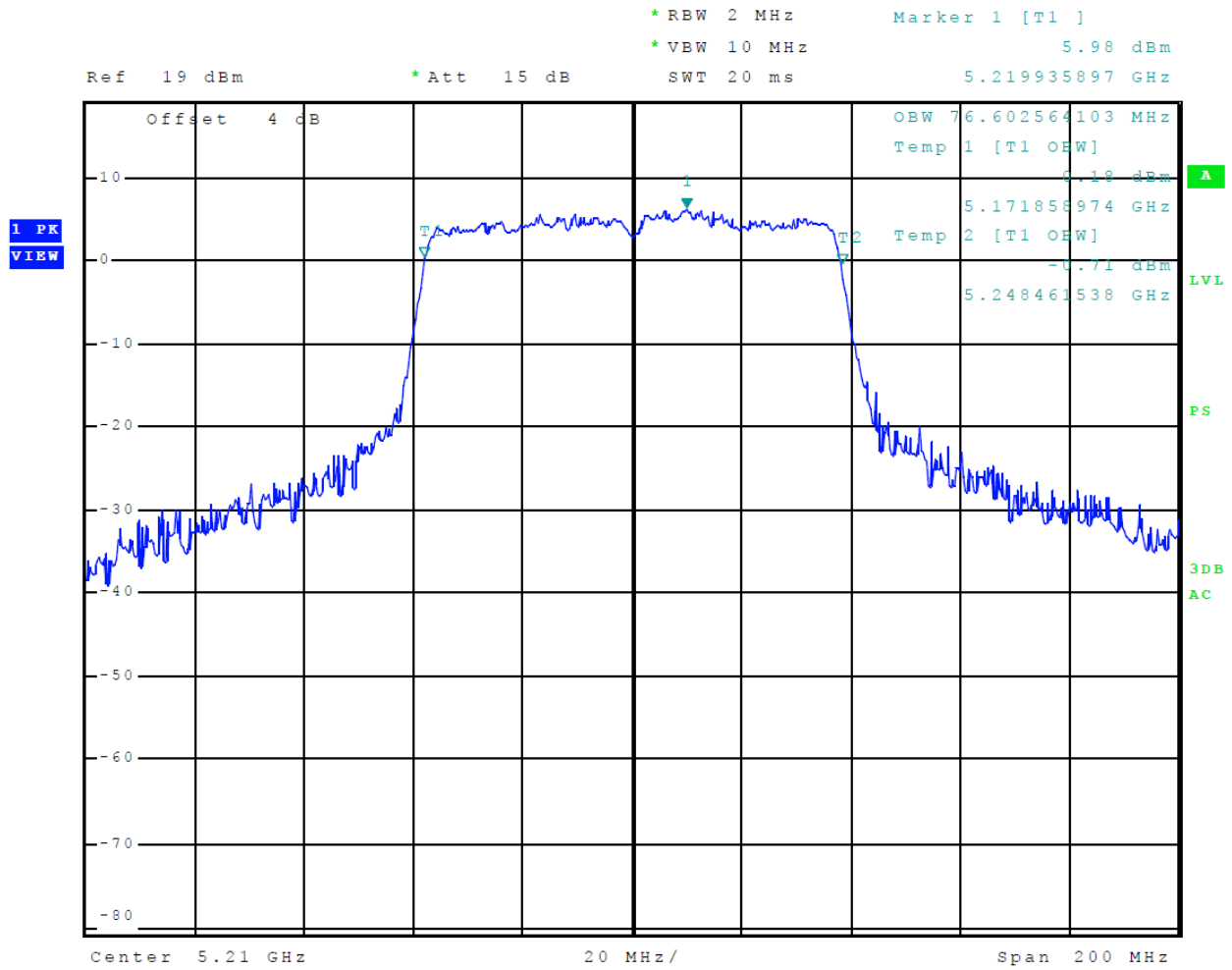

Figure 39 Plot of Transmitter Emissions (5150-5250 MHz Band, 802.11ac, Chain 0, 99% OBW)

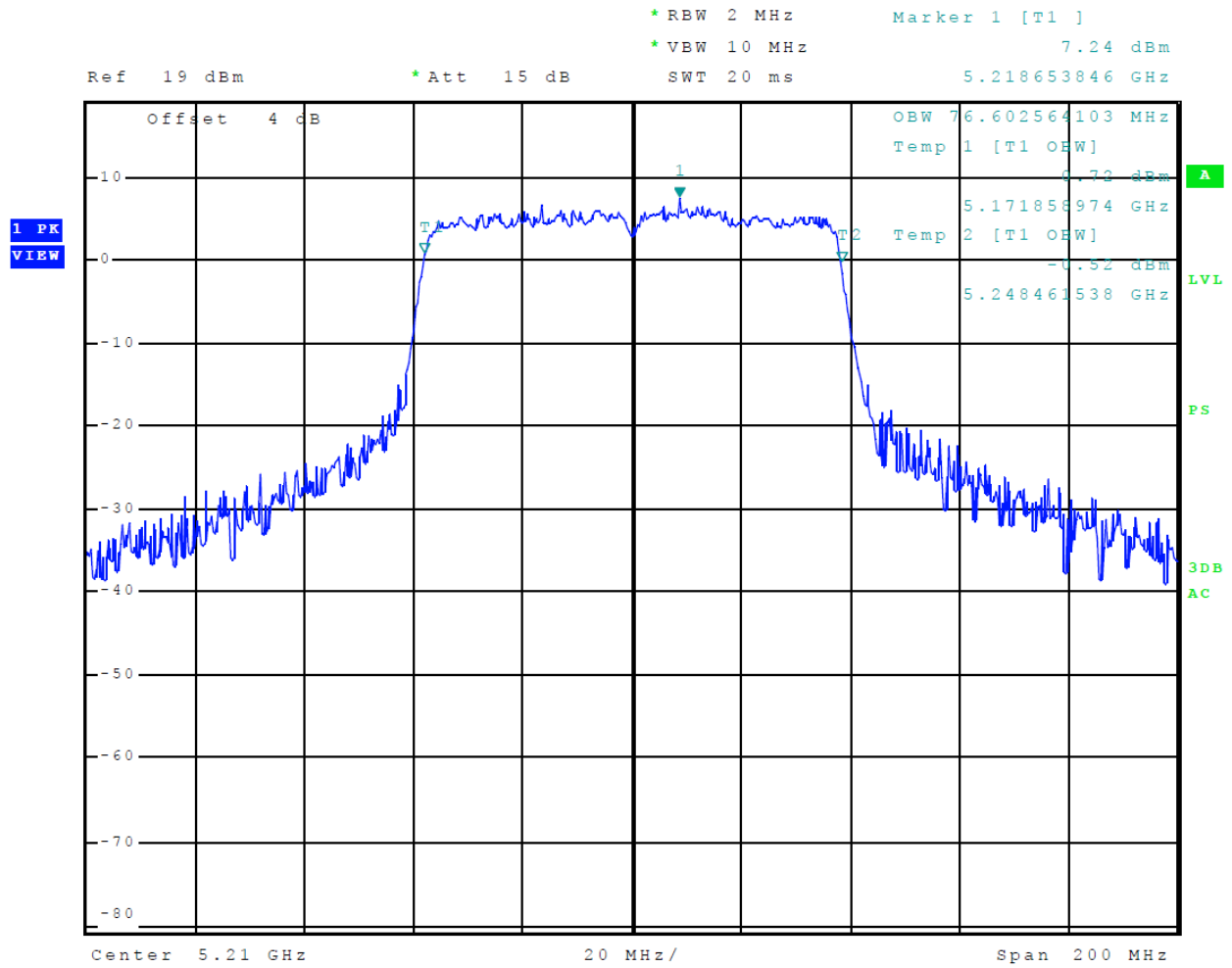

Figure 40 Plot of Transmitter Emissions (5150-5250 MHz Band, 802.11ac, Chain 1, 99% OBW)

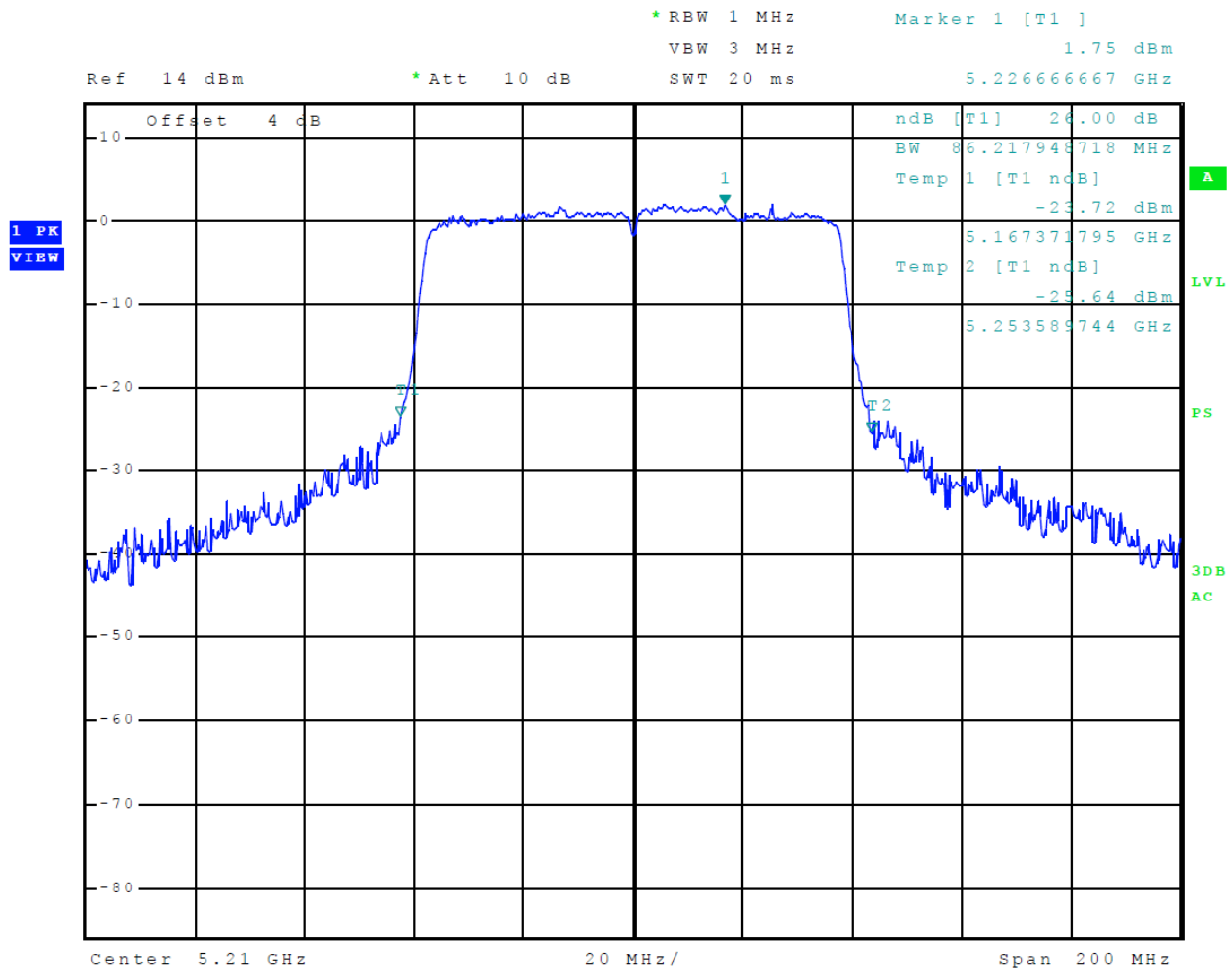

Figure 41 Plot of Transmitter Emissions (5150-5250 MHz Band, 802.11ac, Chain 0, 26 dB OBW)

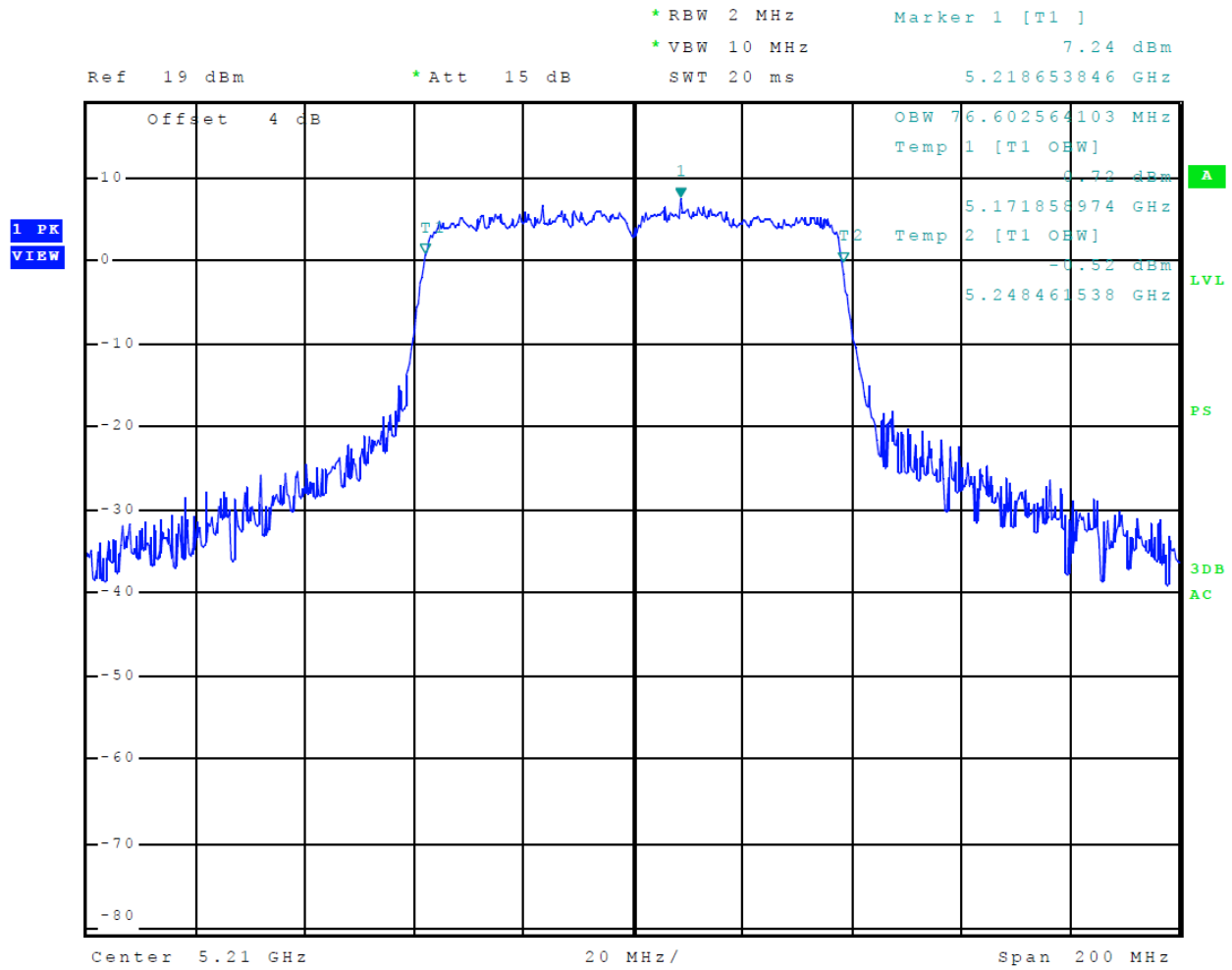

Figure 42 Plot of Transmitter Emissions (5150-5250 MHz Band, 802.11ac, Chain 1, 26 dB OBW)

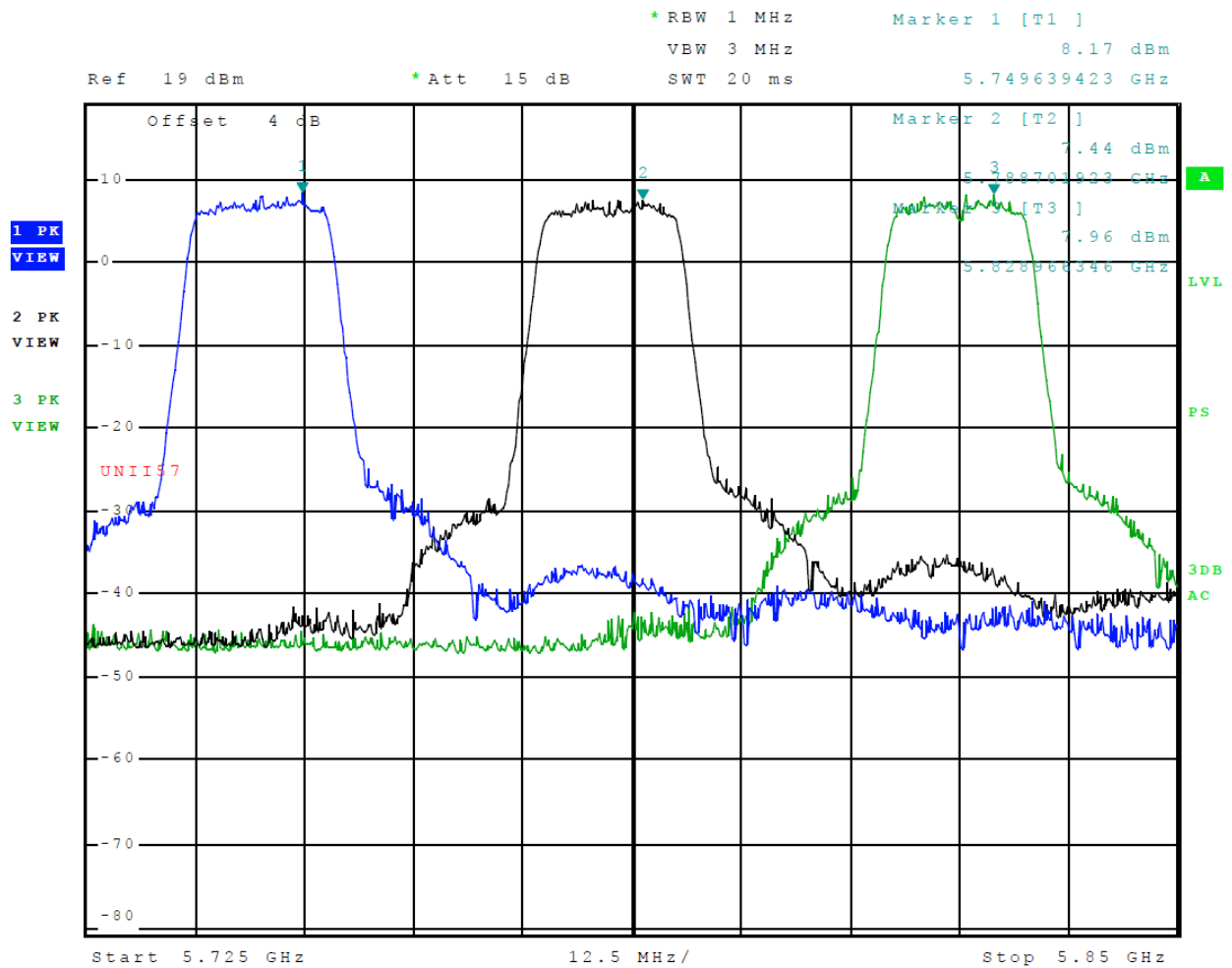

Figure 43 Plot of Transmitter Emissions (Across 5725-5850 MHz Band, Chain 0, 802.11a)

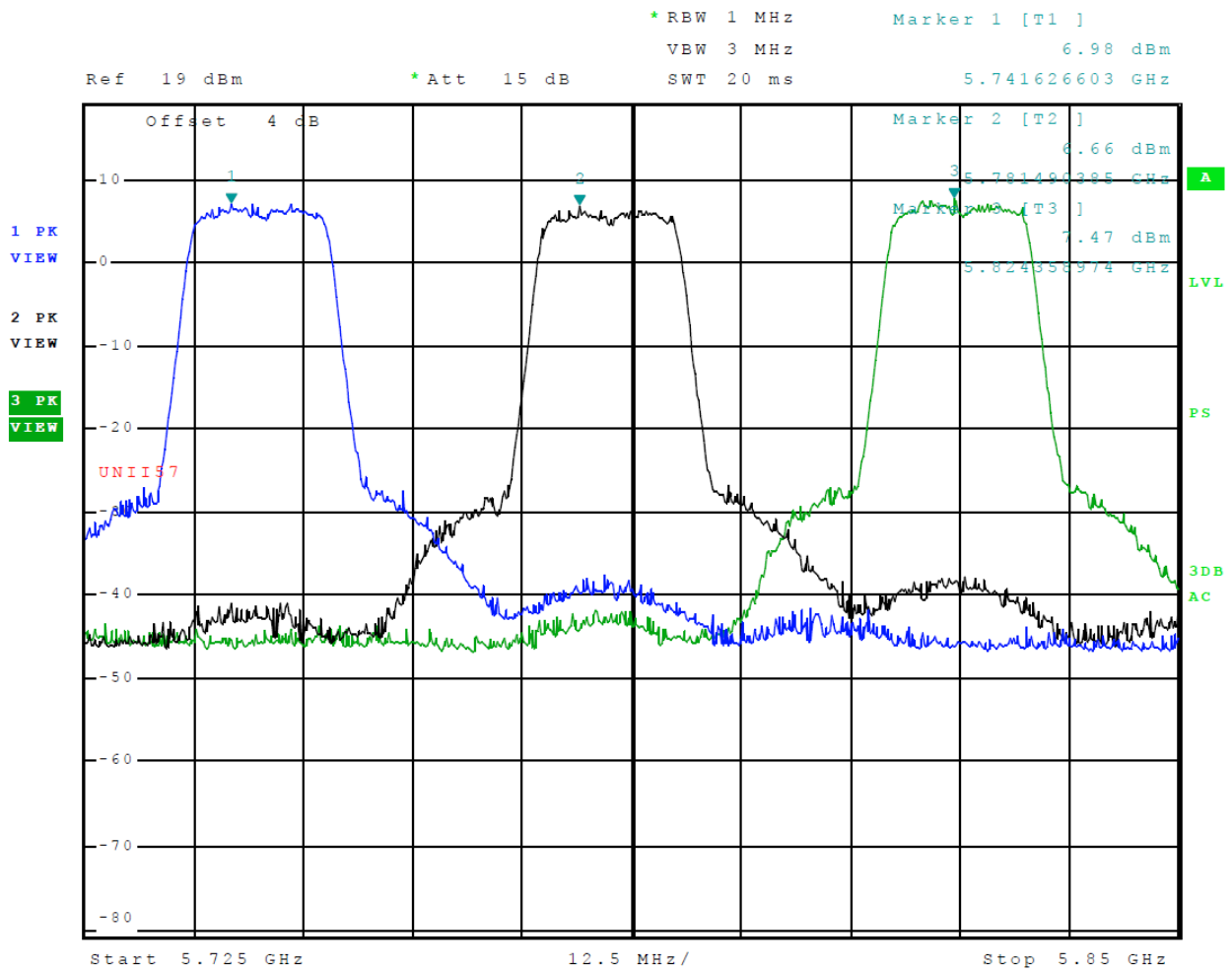

Figure 44 Plot of Transmitter Emissions (Across 5725-5850 MHz Band, Chain 1, 802.11a)

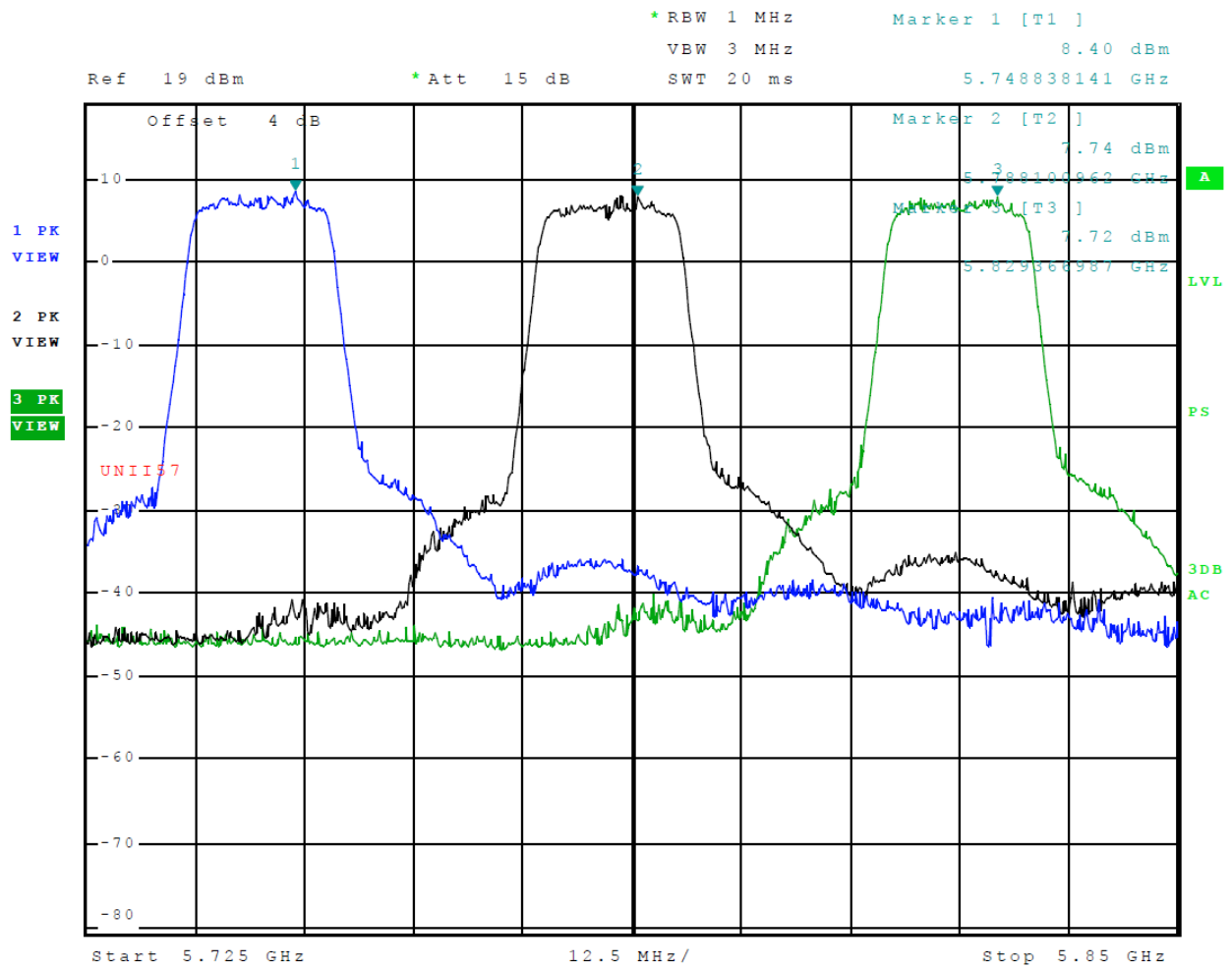

Figure 45 Plot of Transmitter Emissions (Across 5725-5850 MHz Band, Chain 0, 802.11n)

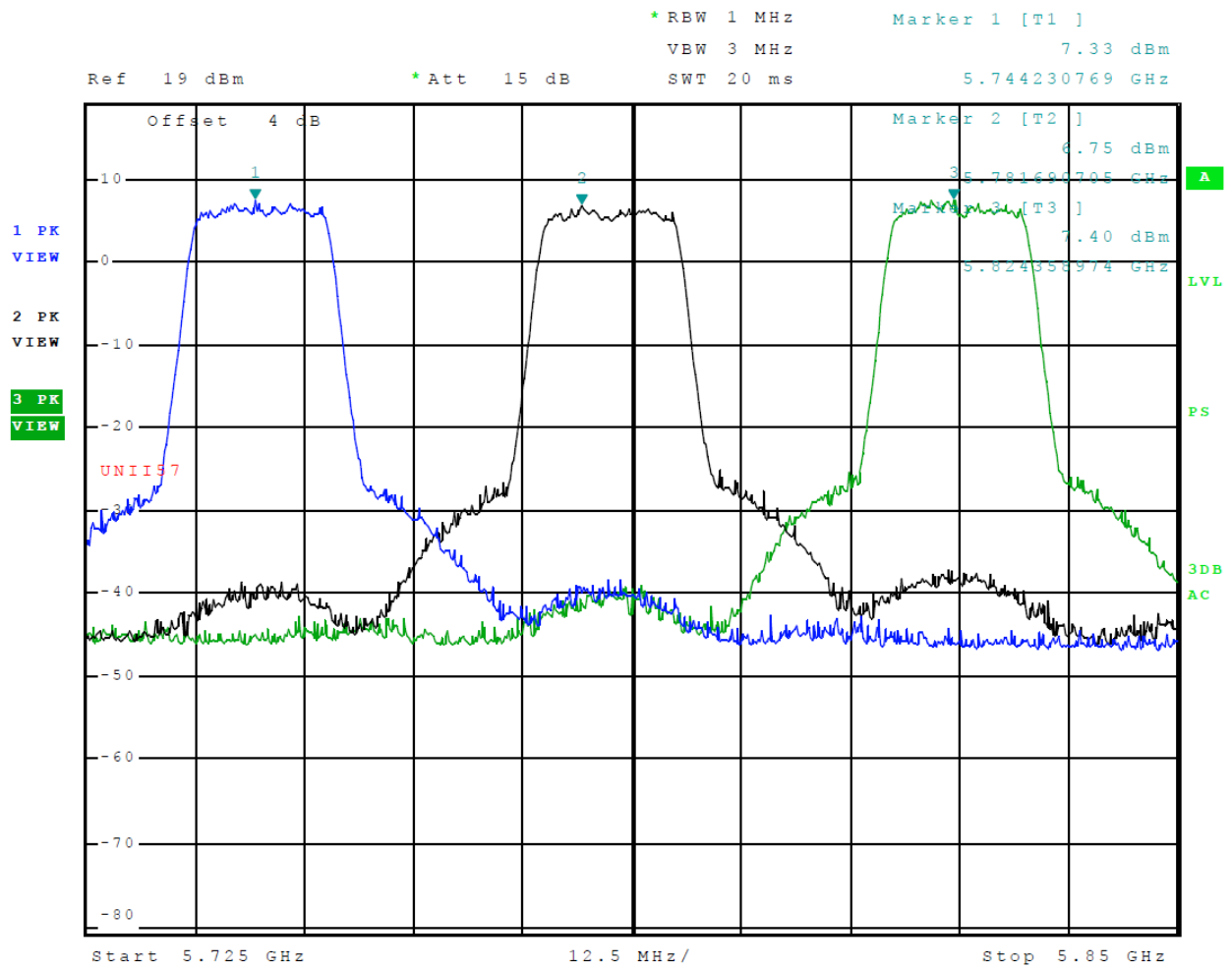

Figure 46 Plot of Transmitter Emissions (Across 5725-5850 MHz Band, Chain 1, 802.11n)

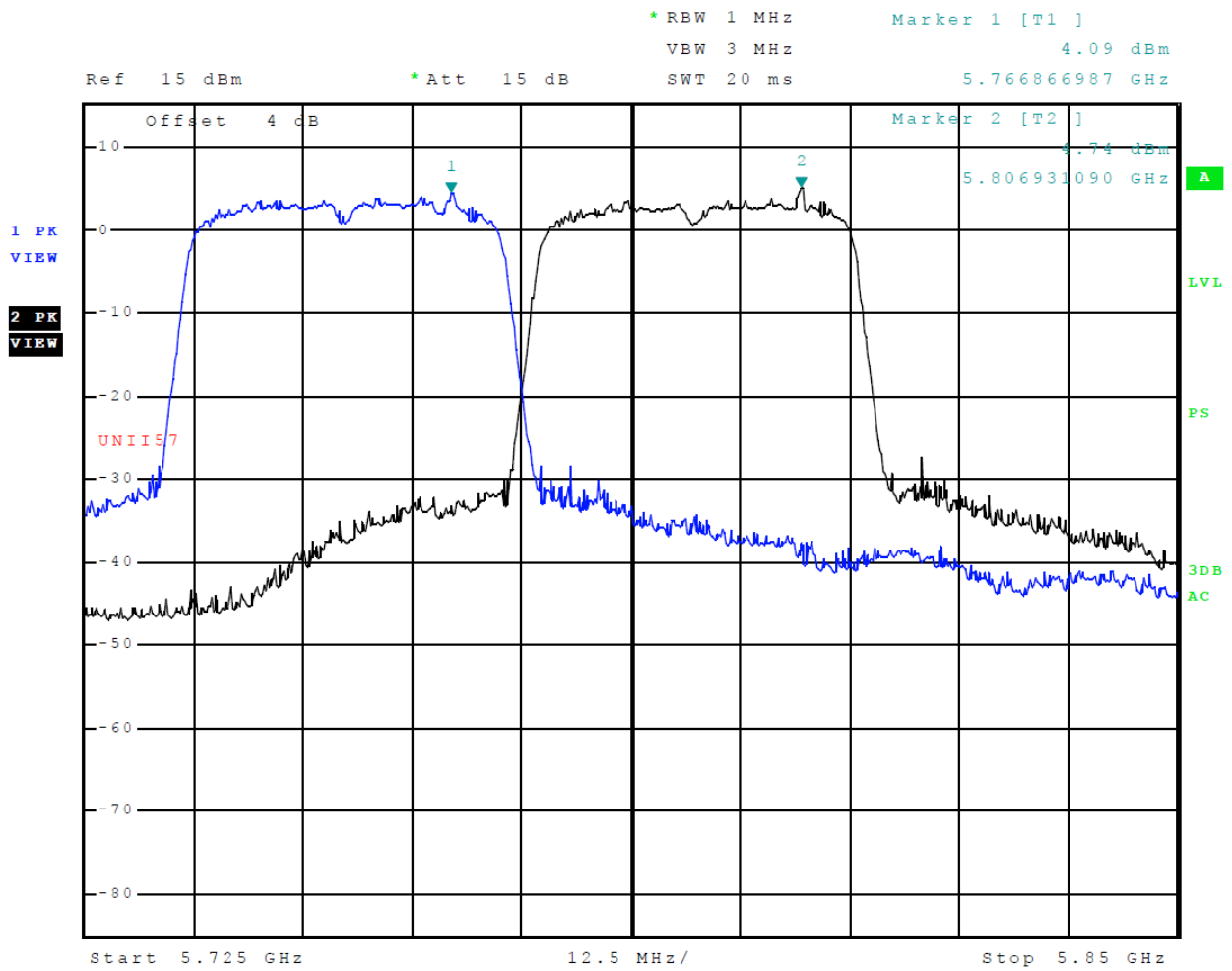

Figure 47 Plot of Transmitter Emissions (Across 5725-5850 MHz Band, Chain 0, 802.11n40)

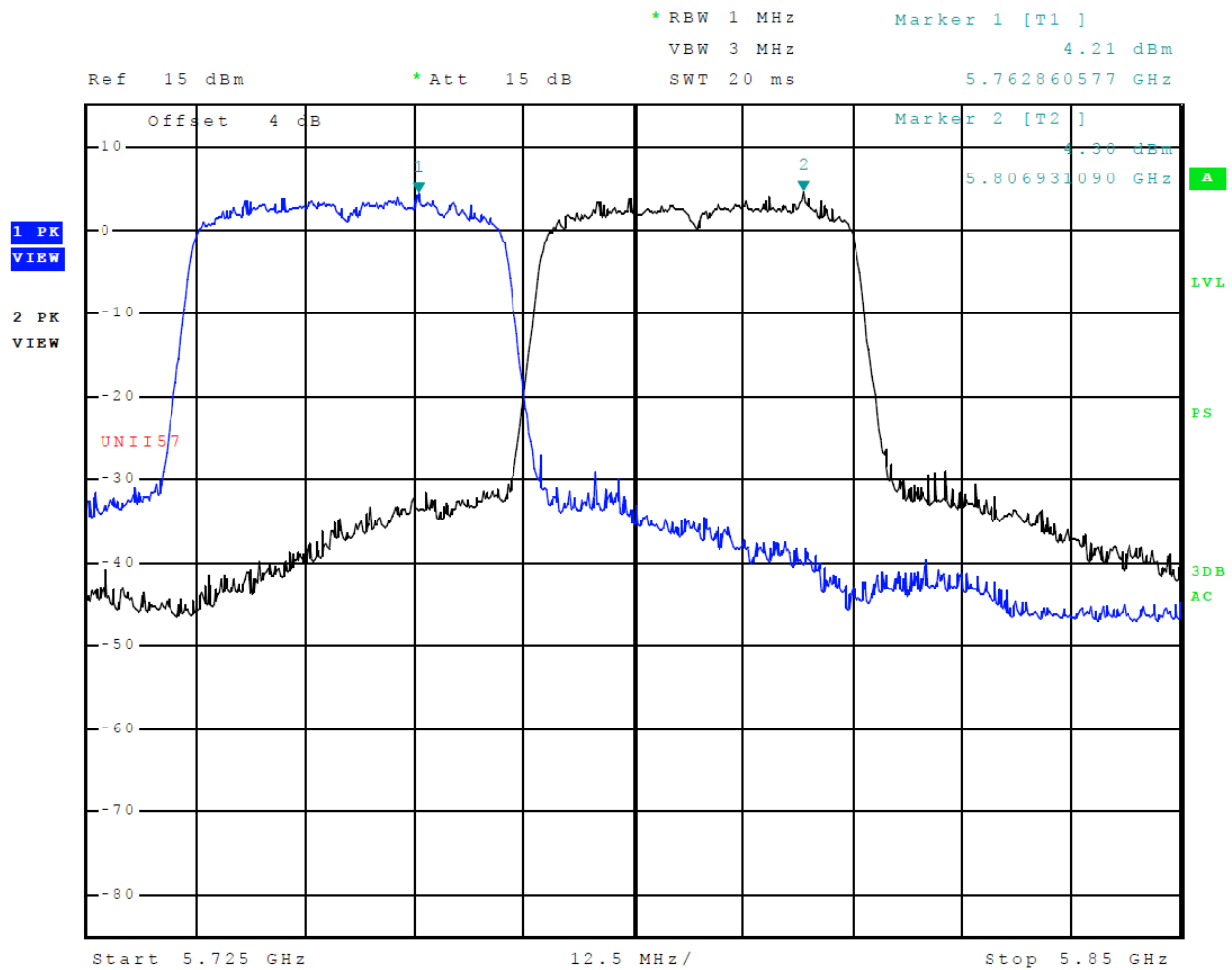

Figure 48 Plot of Transmitter Emissions (Across 5725-5850 MHz Band, Chain 1, 802.11n40)

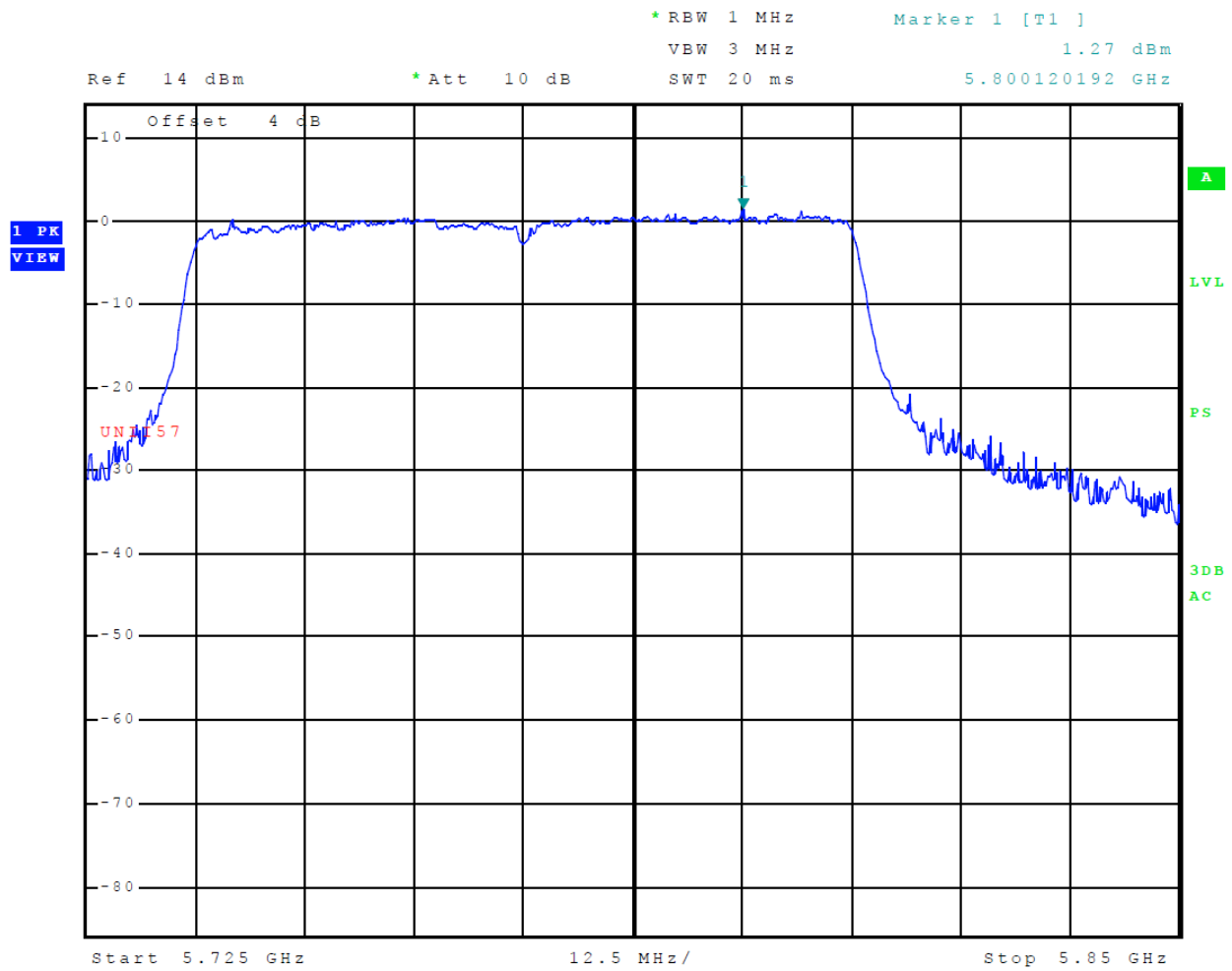

Figure 49 Plot of Transmitter Emissions (Across 5725-5850 MHz Band, Chain 0, 802.11ac)

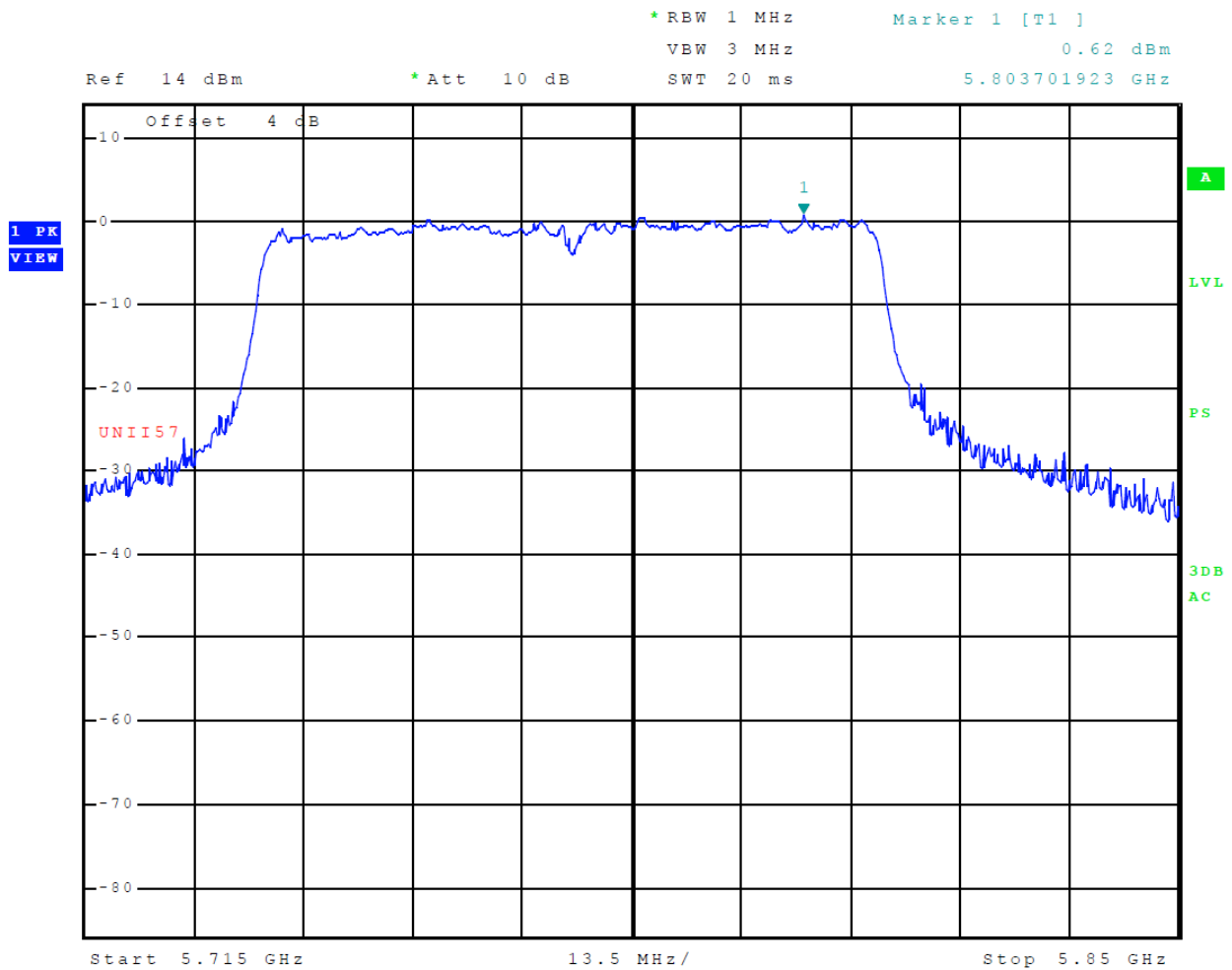

Figure 50 Plot of Transmitter Emissions (Across 5725-5850 MHz Band, Chain 1, 802.11ac)

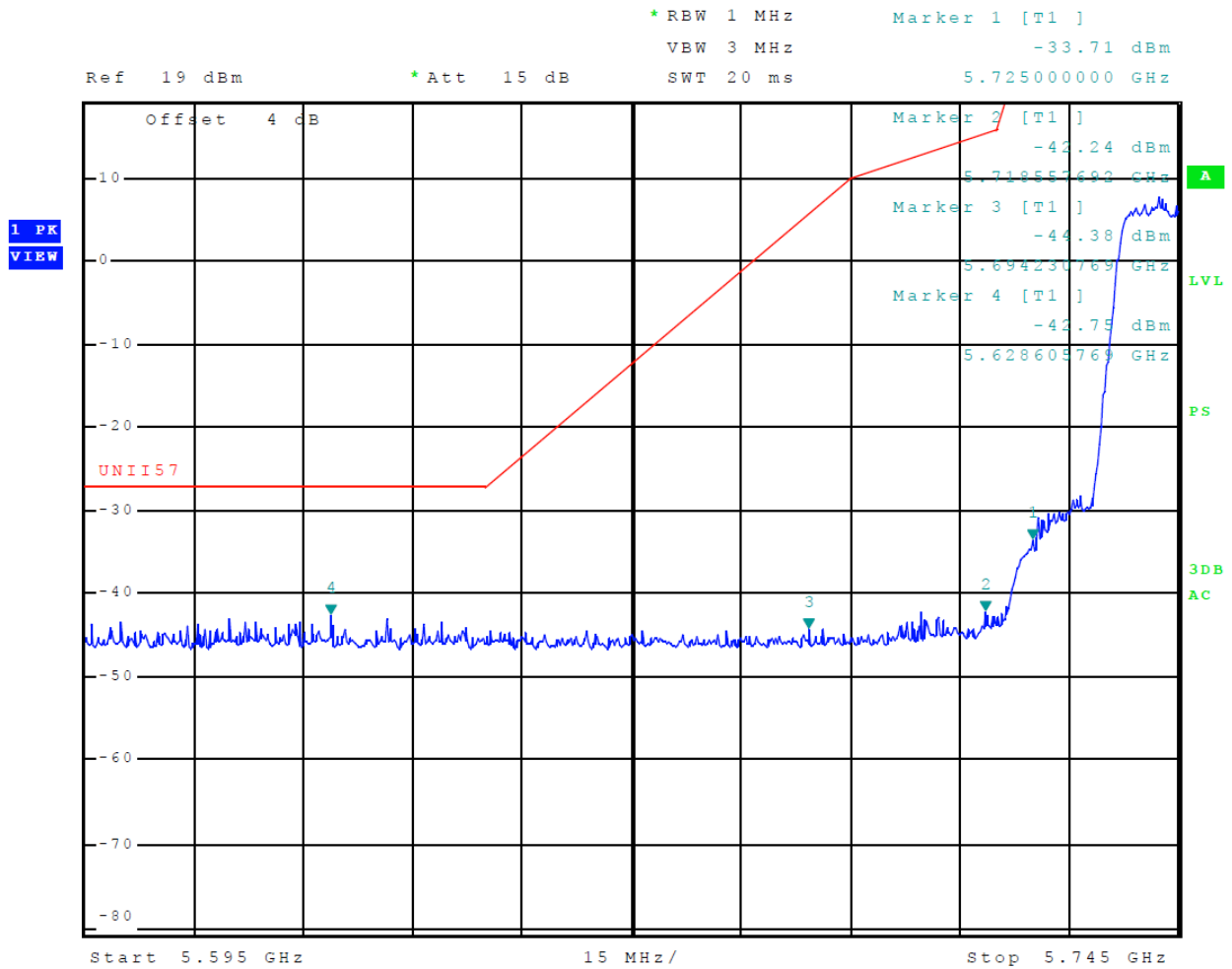

Figure 51 Plot of Transmitter Low Band Edge (5725-5850 MHz Band, Chain 0, 802.11a)

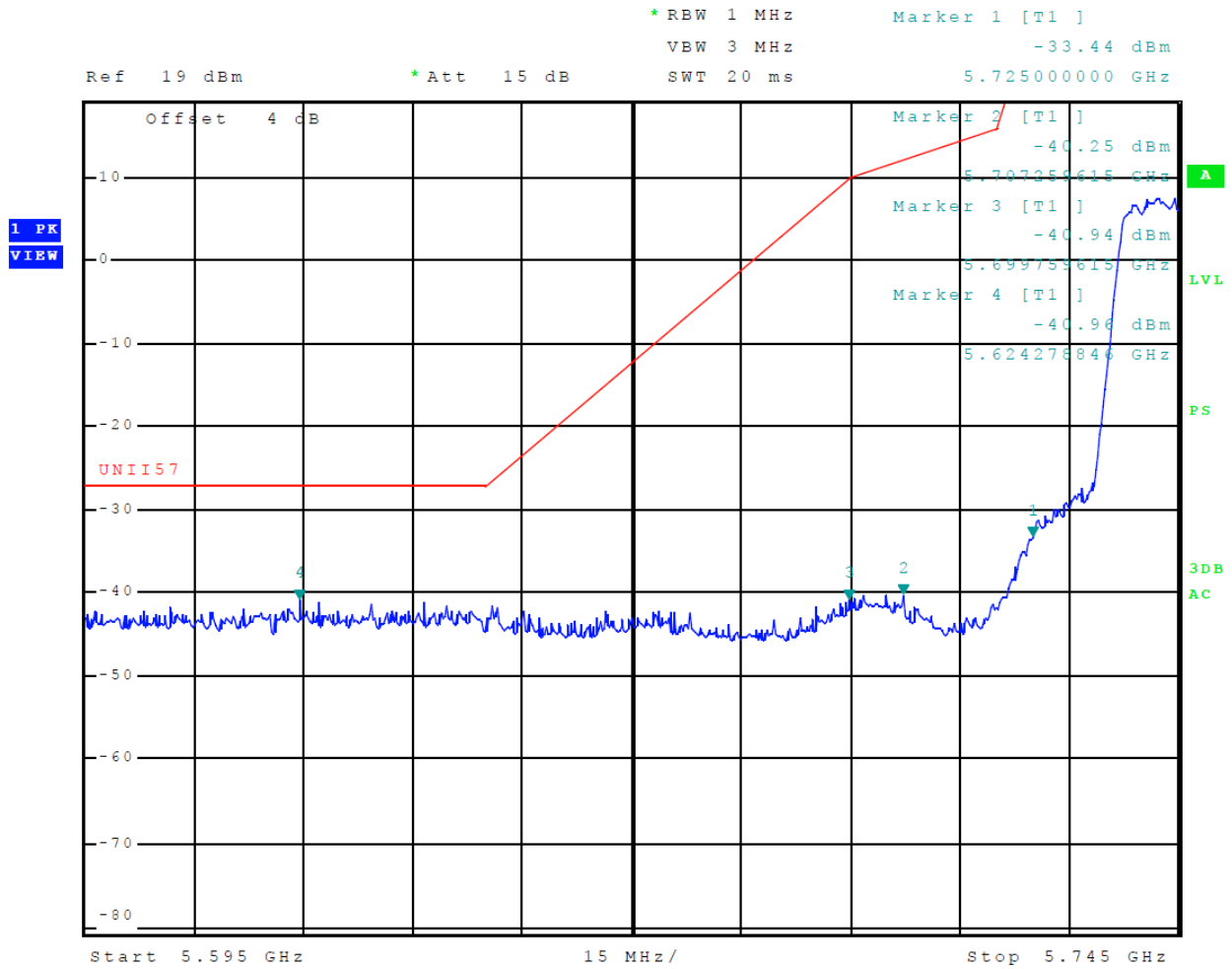

Figure 52 Plot of Transmitter Low Band Edge (5725-5850 MHz Band, Chain 1, 802.11a)

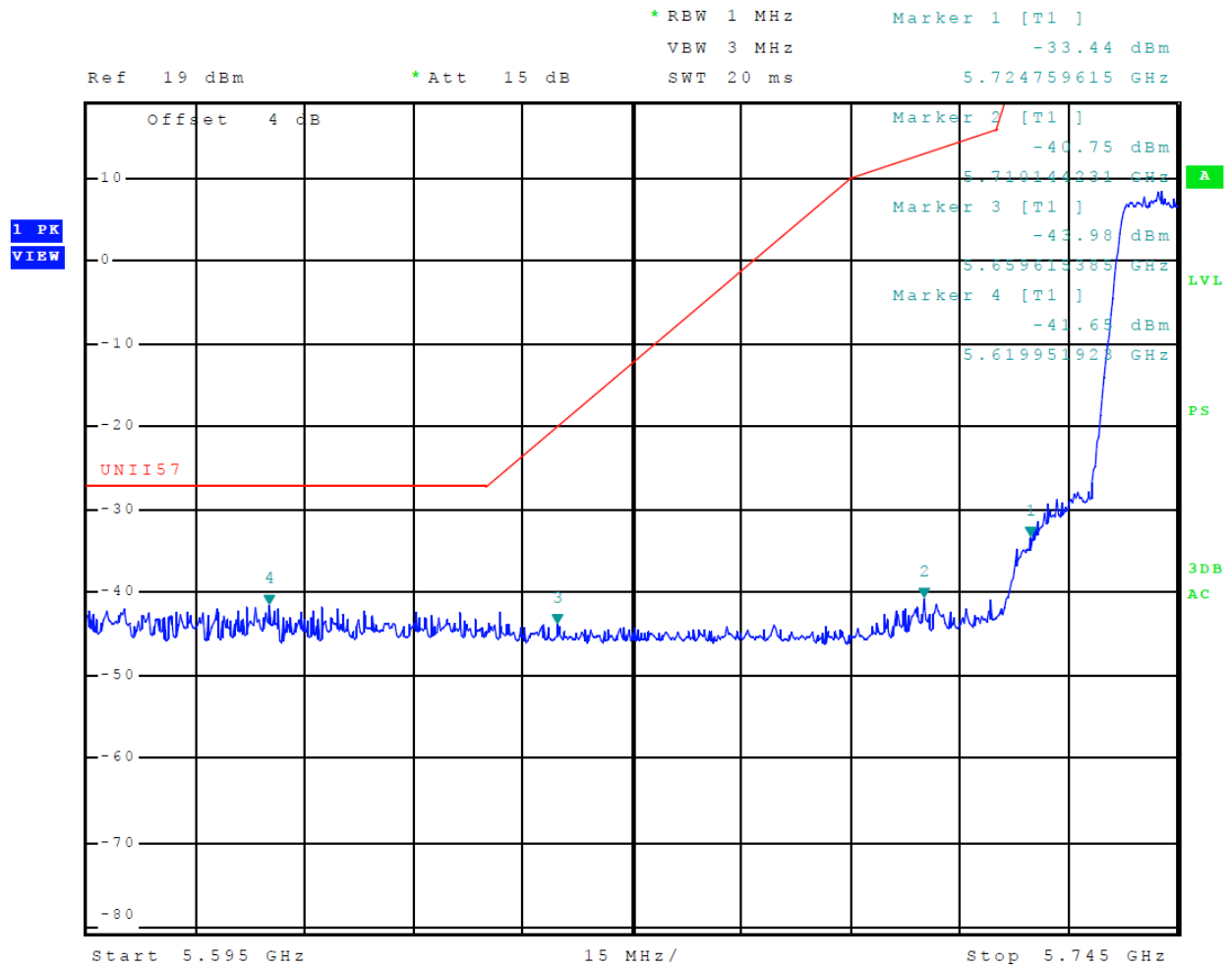

Figure 53 Plot of Transmitter Low Band Edge (5725-5850 MHz Band, Chain 0, 802.11n)

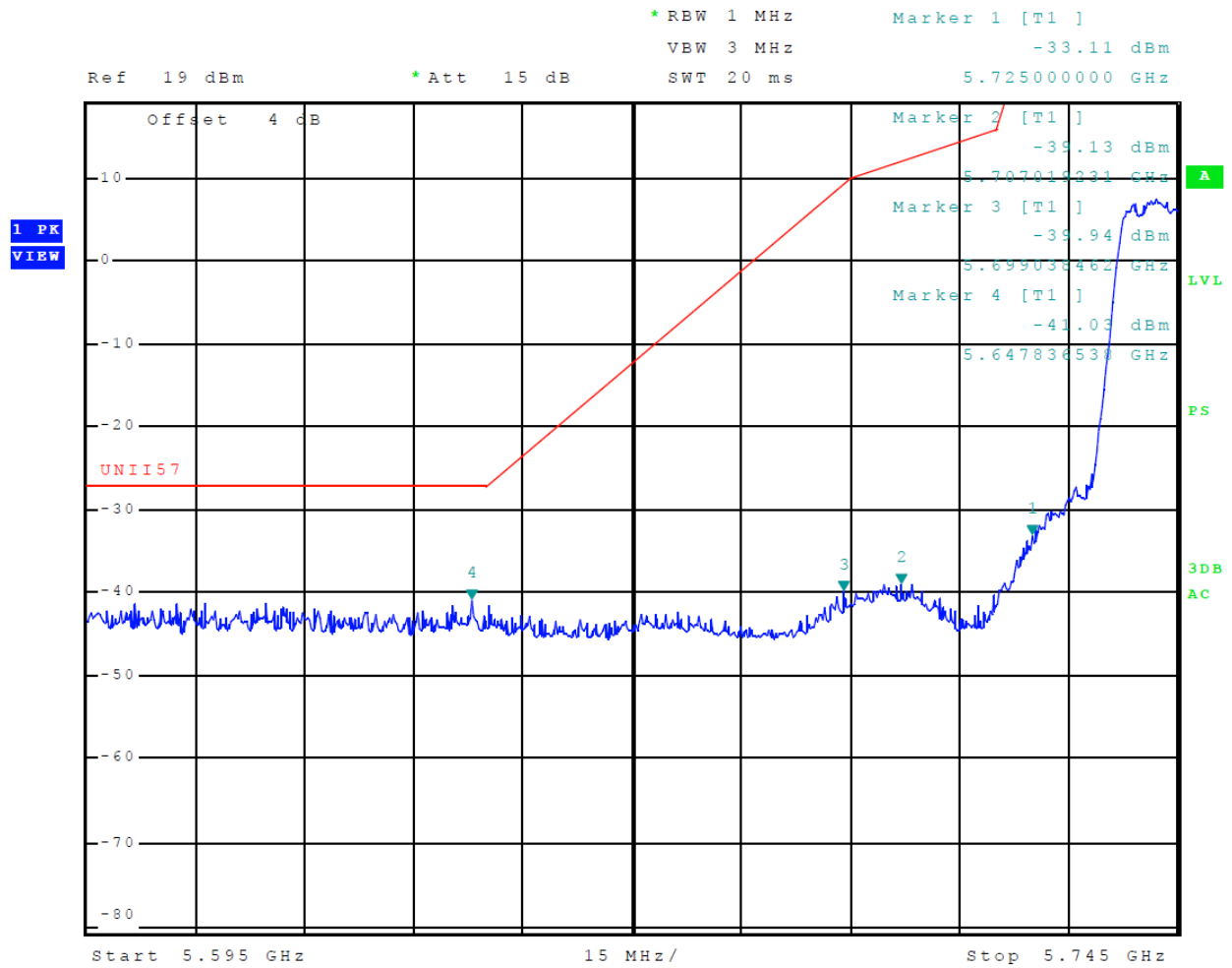

Figure 54 Plot of Transmitter Low Band Edge (5725-5850 MHz Band, Chain 1, 802.11n)

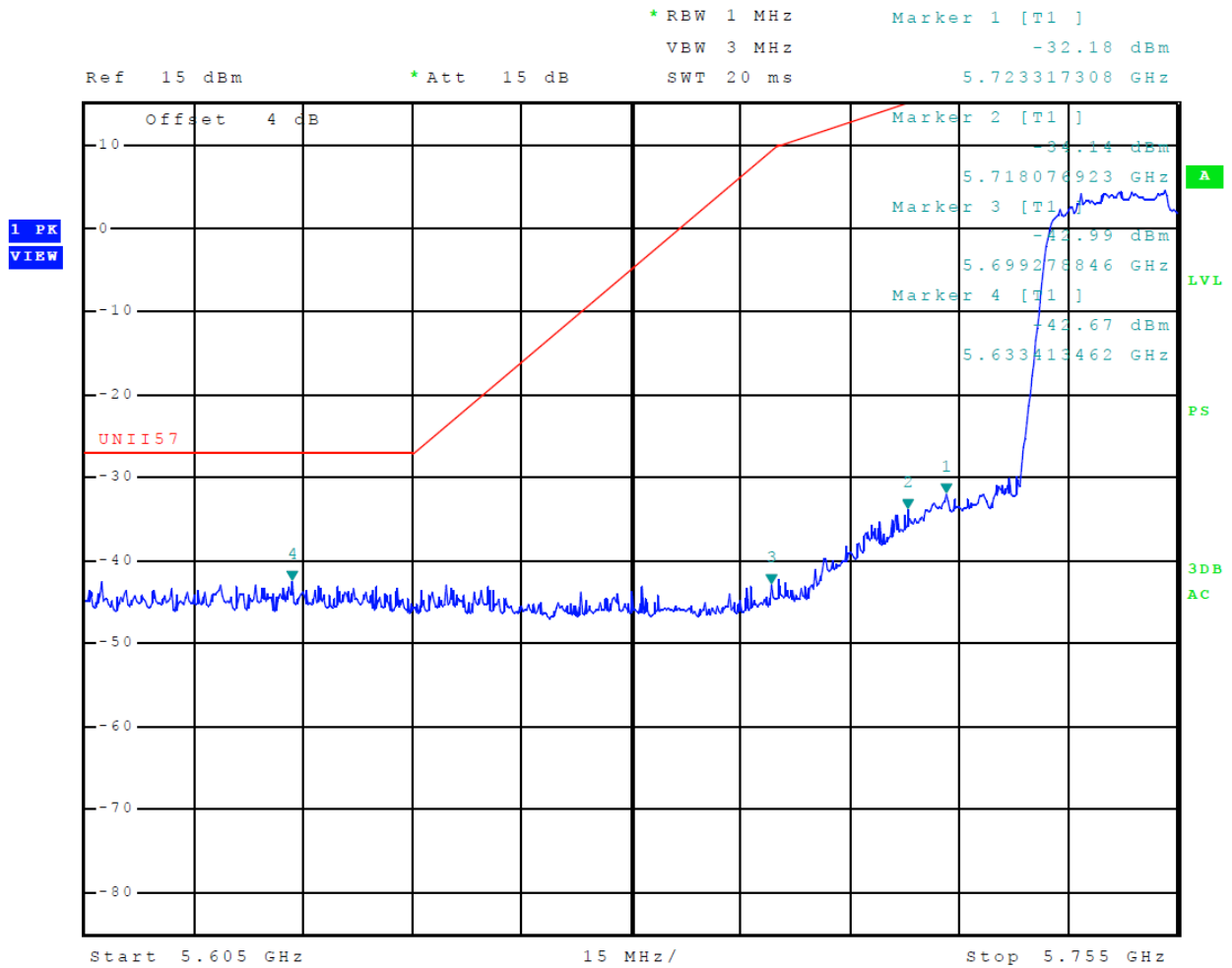

Figure 55 Plot of Transmitter Low Band Edge (5725-5850 MHz Band, Chain 0, 802.11n40)

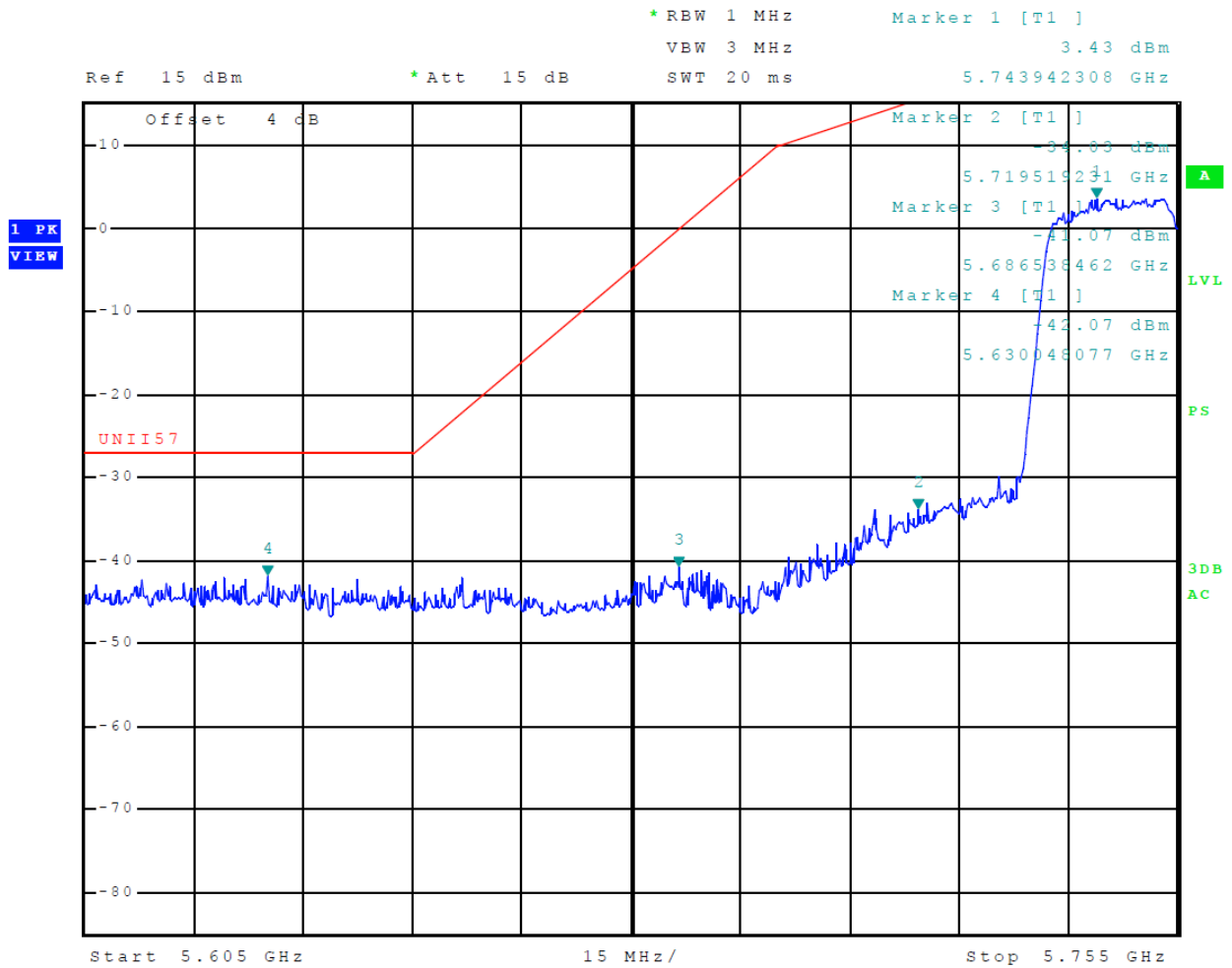

Figure 56 Plot of Transmitter Low Band Edge (5725-5850 MHz Band, Chain 1, 802.11n40)

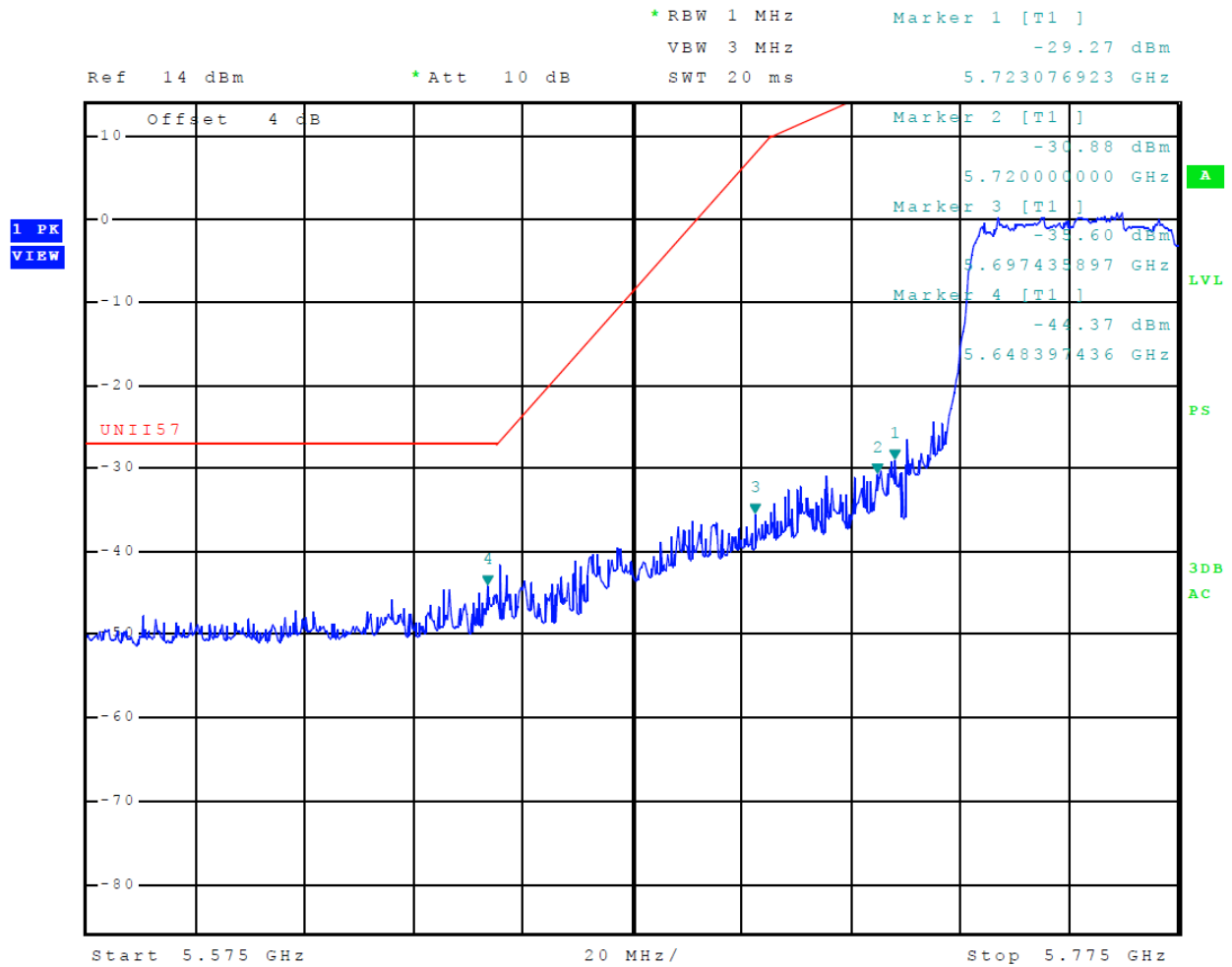

Figure 57 Plot of Transmitter Low Band Edge (5725-5850 MHz Band, Chain 0, 802.11ac)

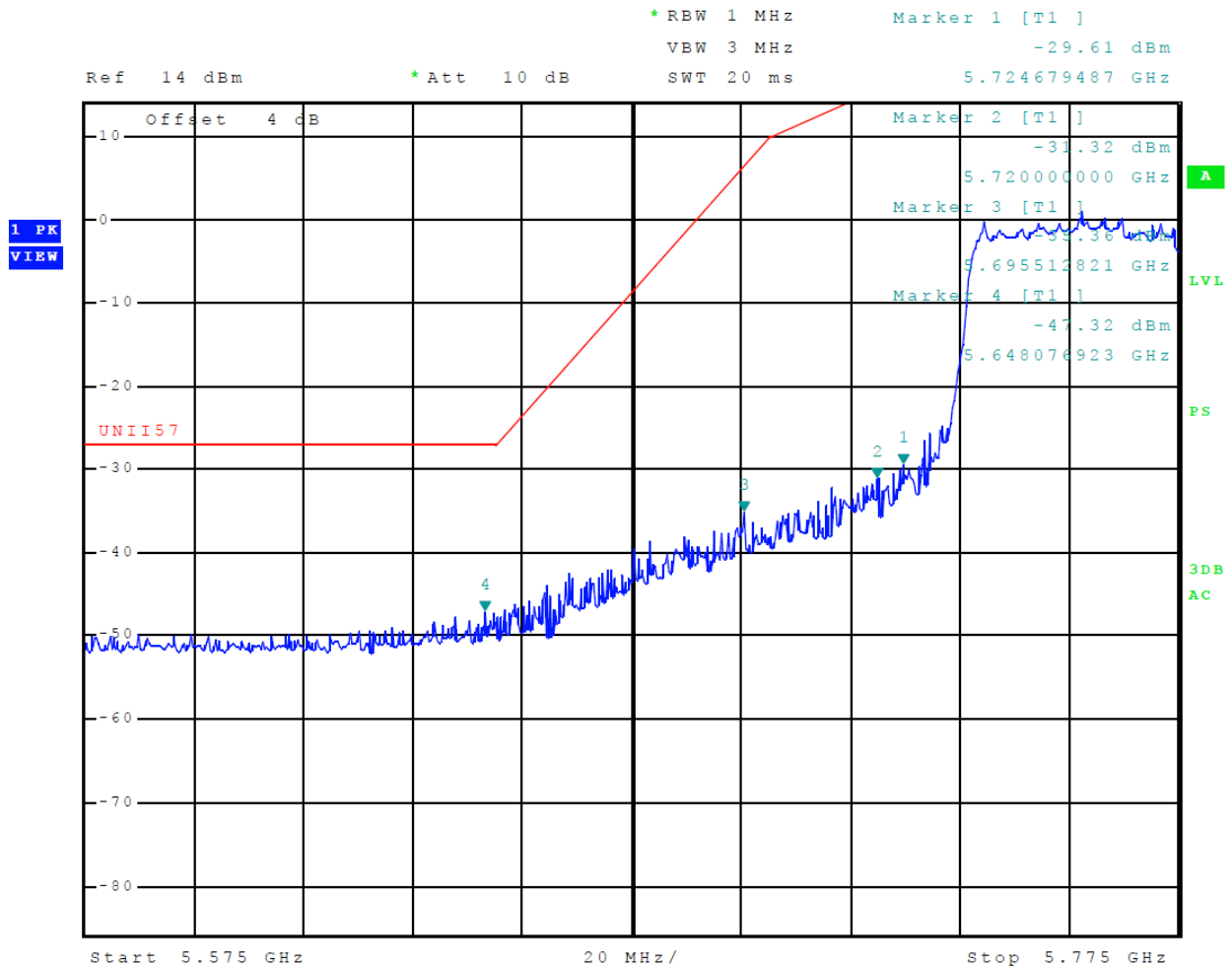

Figure 58 Plot of Transmitter Low Band Edge (5725-5850 MHz Band, Chain 1, 802.11ac)

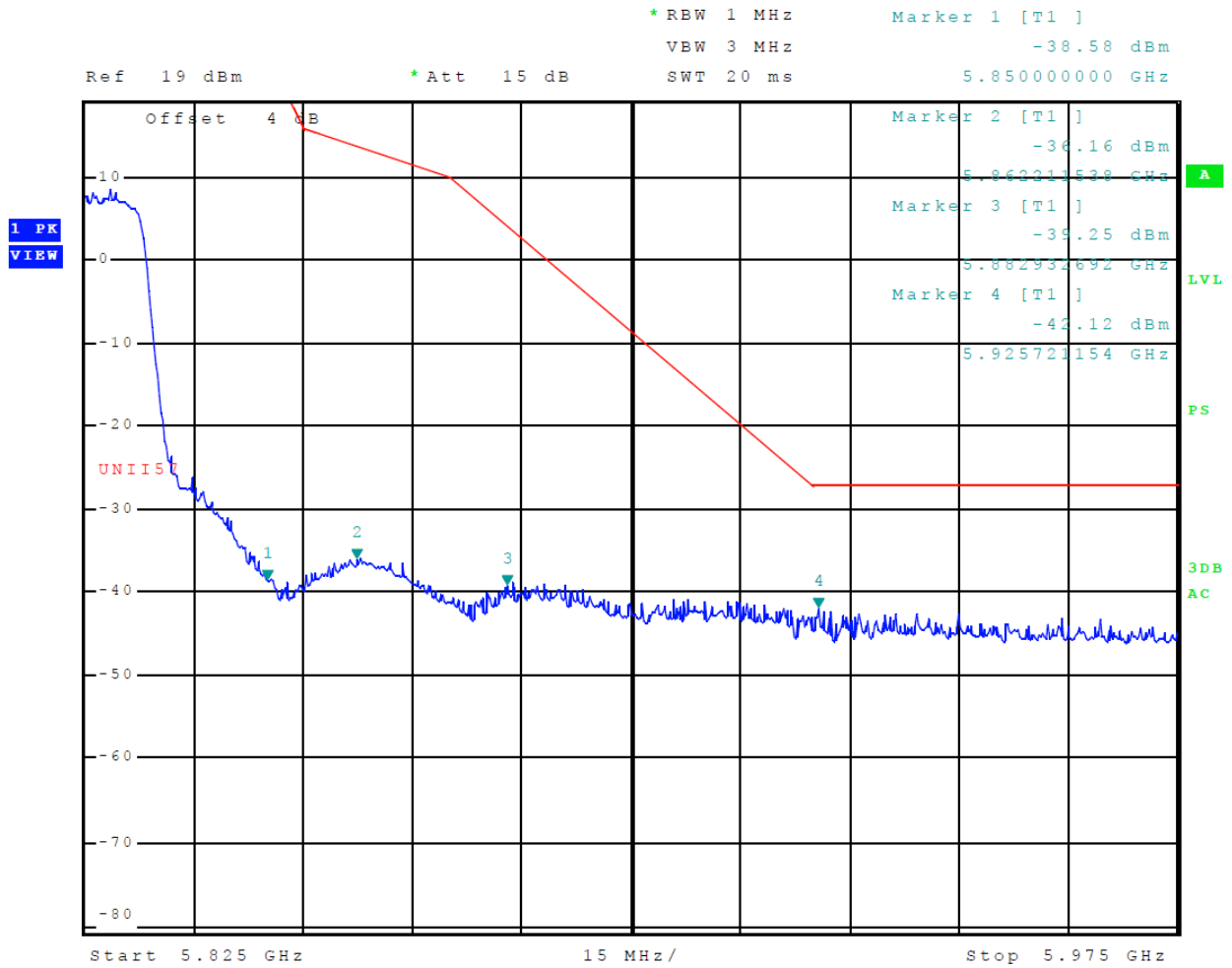

Figure 59 Plot of Transmitter High Band Edge (5725-5850 MHz Band, Chain 0, 802.11a)

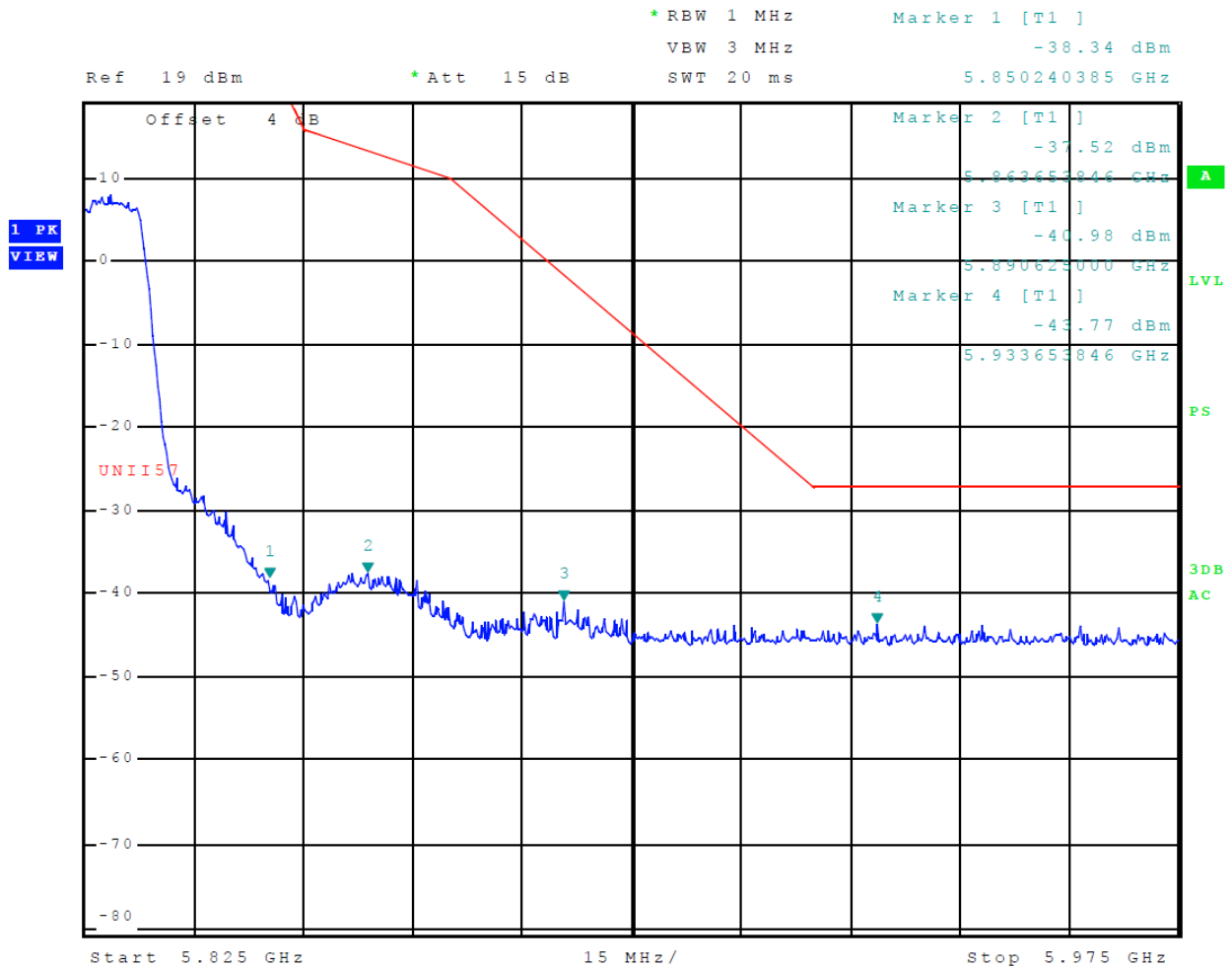

Figure 60 Plot of Transmitter High Band Edge (5725-5850 MHz Band, Chain 1, 802.11a)

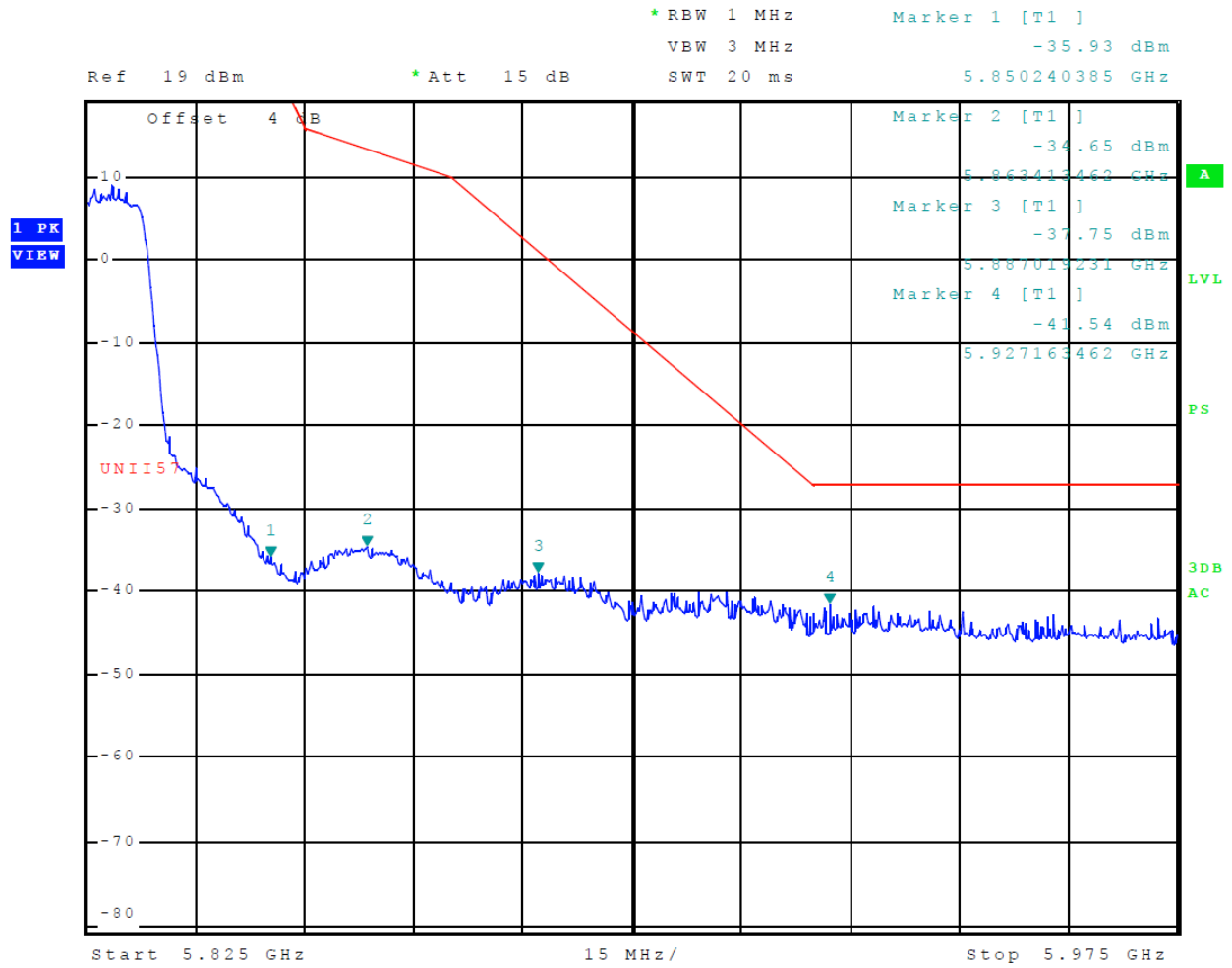

Figure 61 Plot of Transmitter High Band Edge (5725-5850 MHz Band, Chain 0, 802.11n)

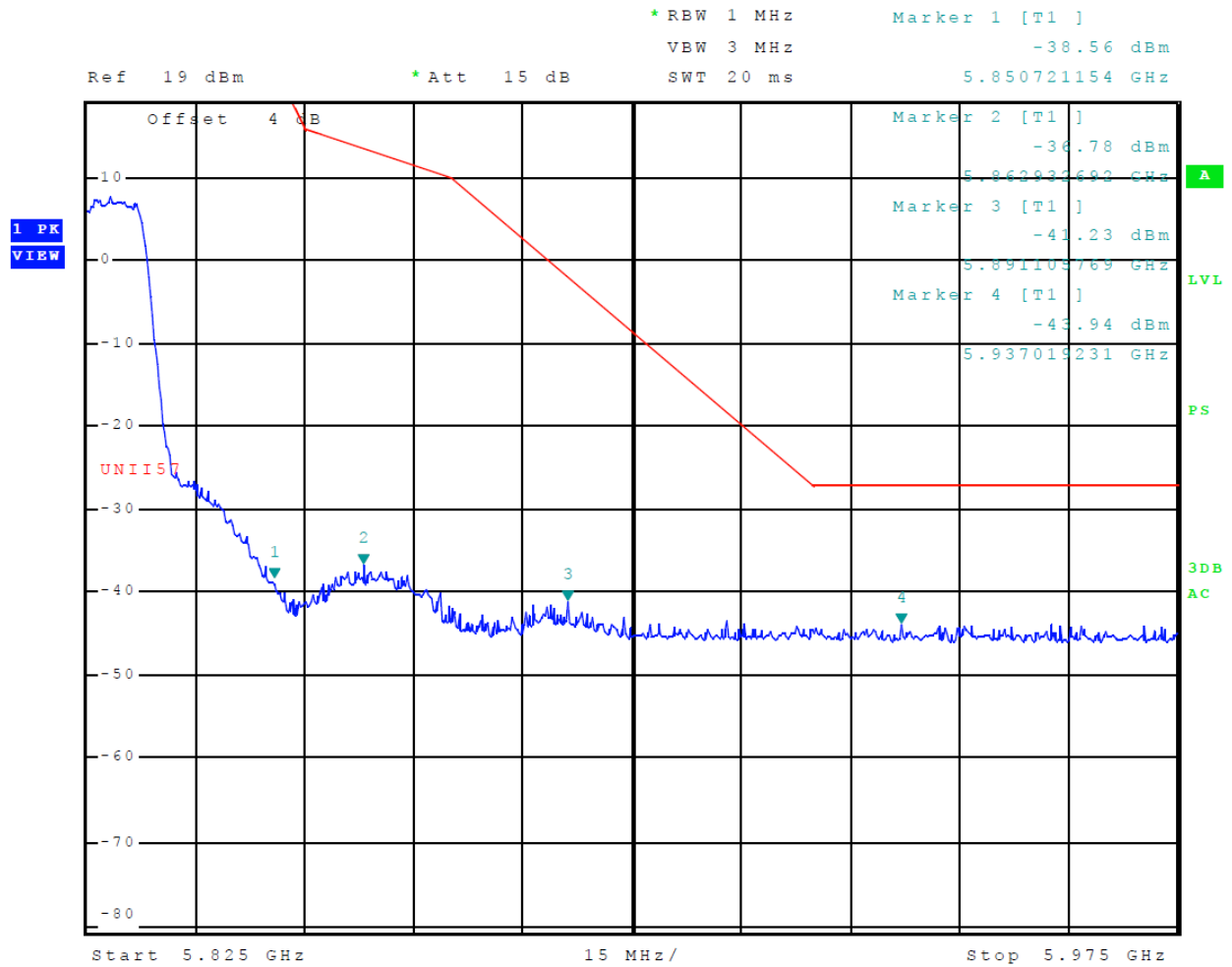

Figure 62 Plot of Transmitter High Band Edge (5725-5850 MHz Band, Chain 1, 802.11n)

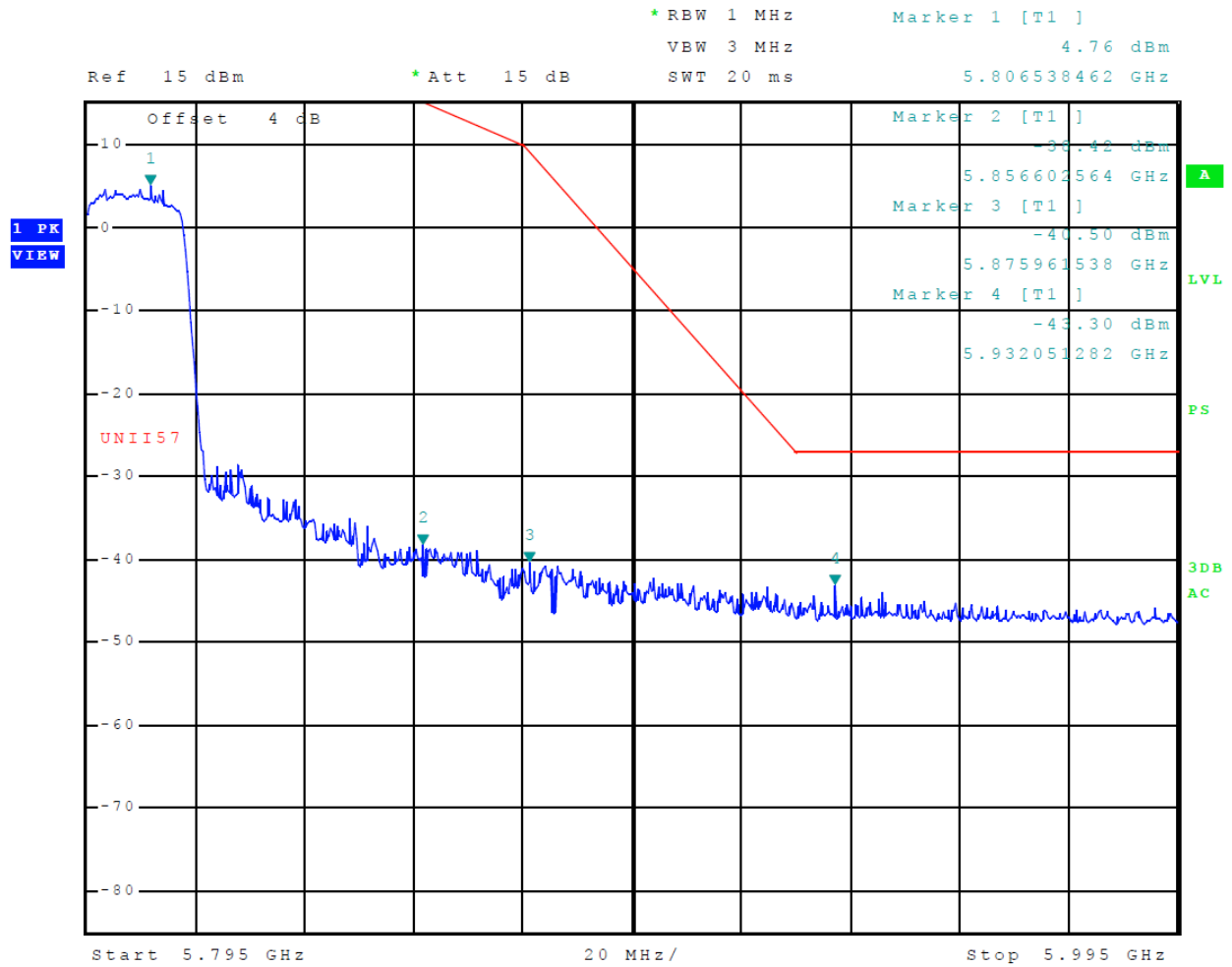

Figure 63 Plot of Transmitter High Band Edge (5725-5850 MHz Band, Chain 0, 802.11n40)

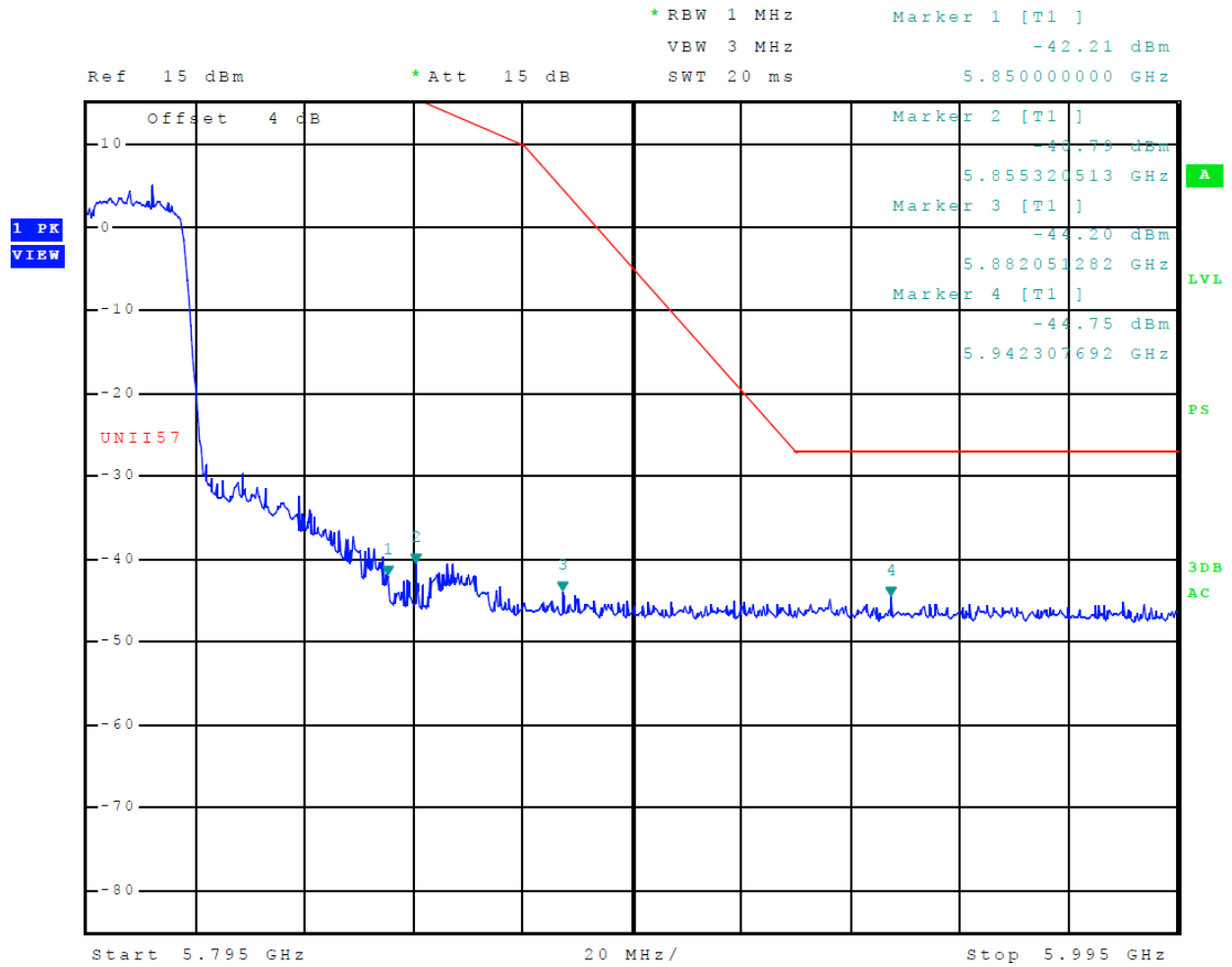

Figure 64 Plot of Transmitter High Band Edge (5725-5850 MHz Band, Chain 1, 802.11n40)

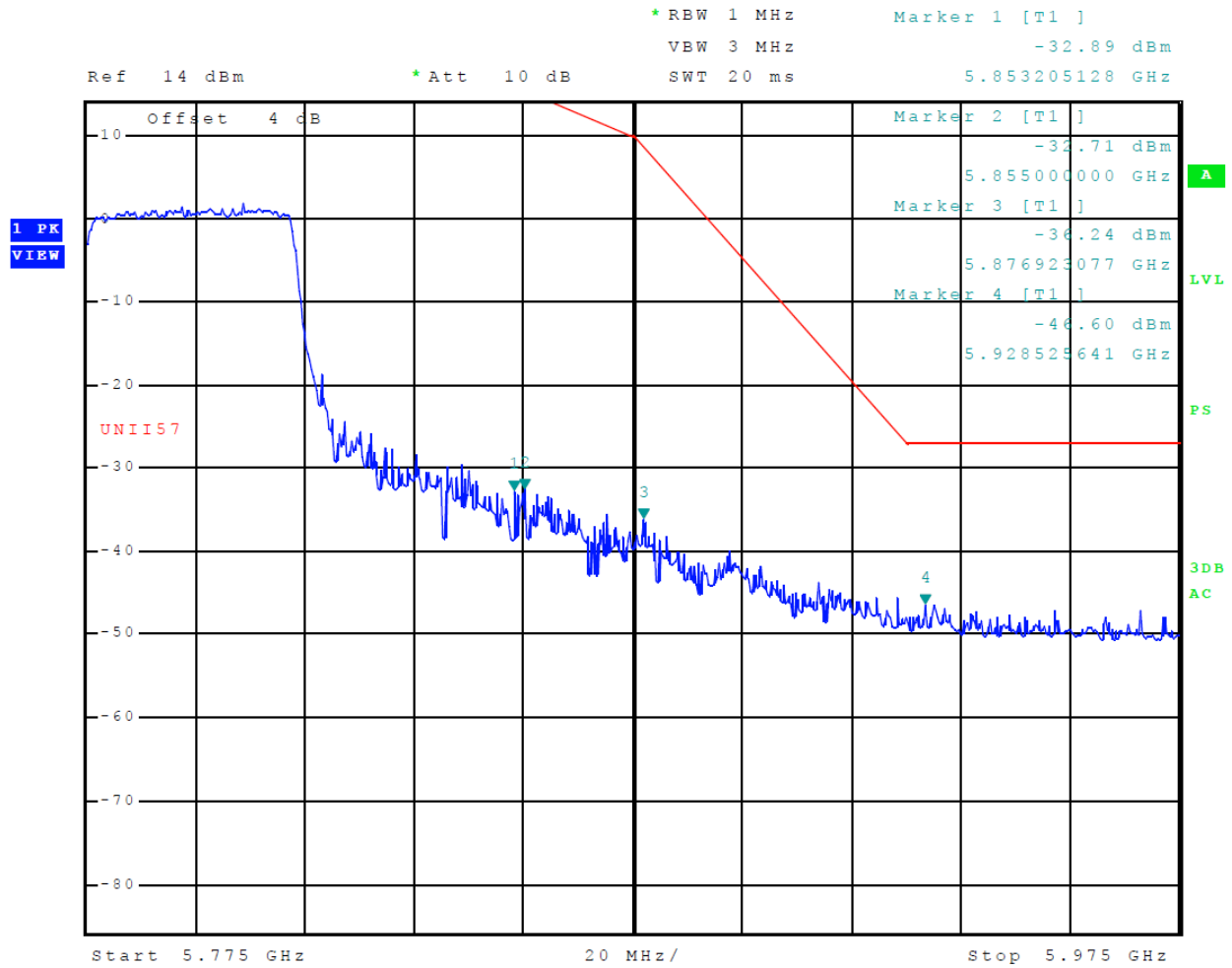

Figure 65 Plot of Transmitter High Band Edge (5725-5850 MHz Band, Chain 0, 802.11ac)

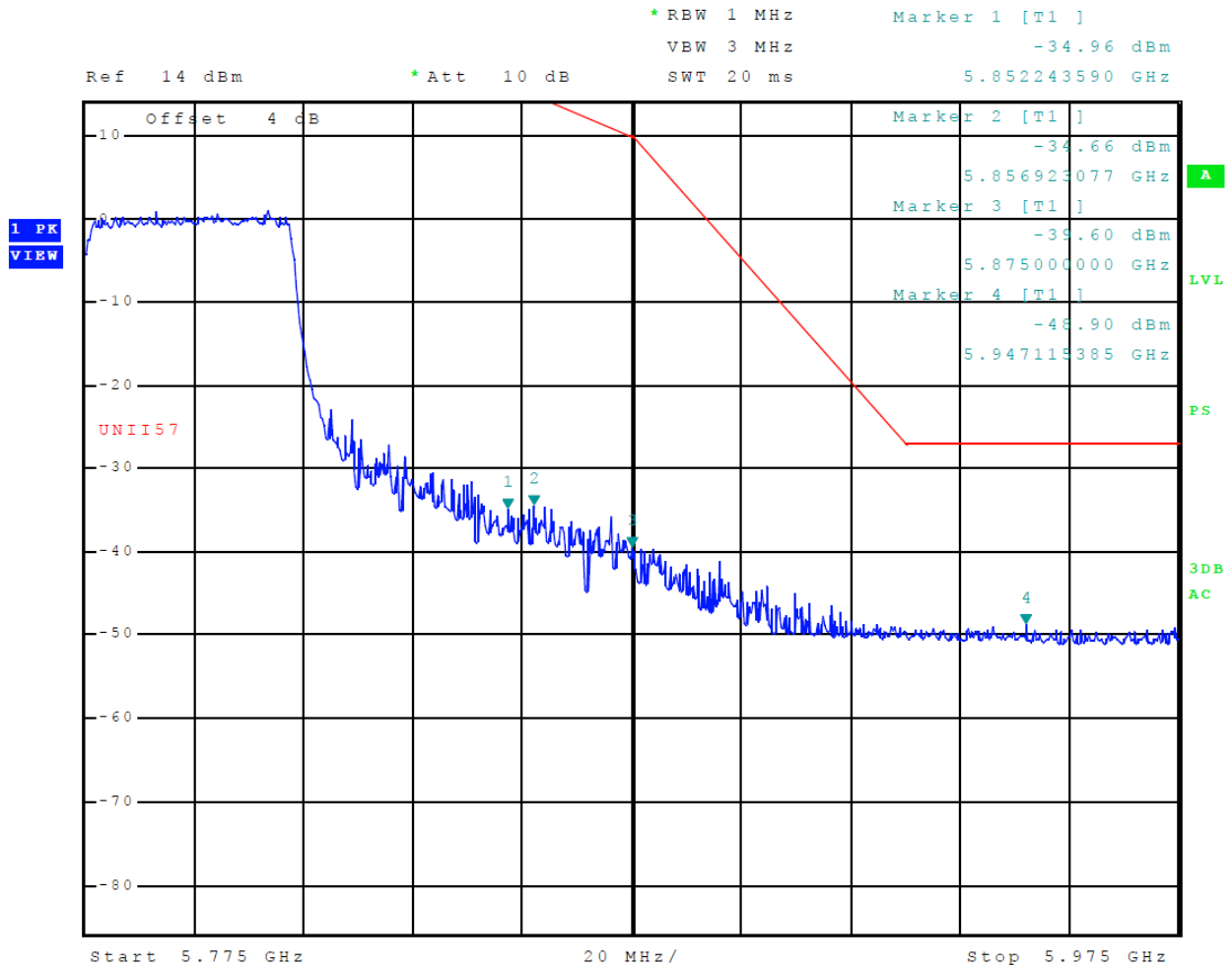

Figure 66 Plot of Transmitter High Band Edge (5725-5850 MHz Band, Chain 1, 802.11ac)

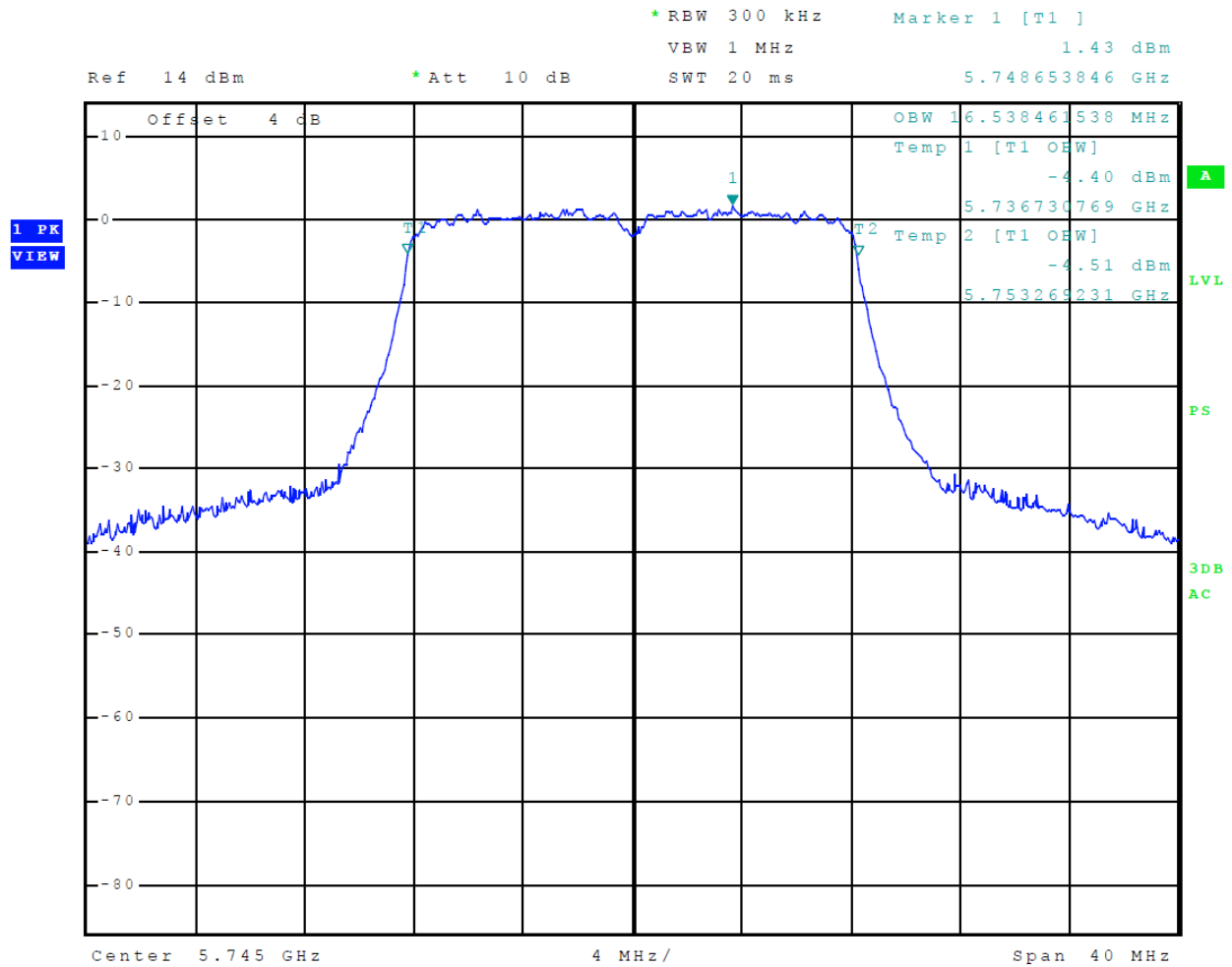

Figure 67 Plot of Transmitter Emissions (5725-5850 MHz Band, 802.11a, Chain 0, 99% OBW)

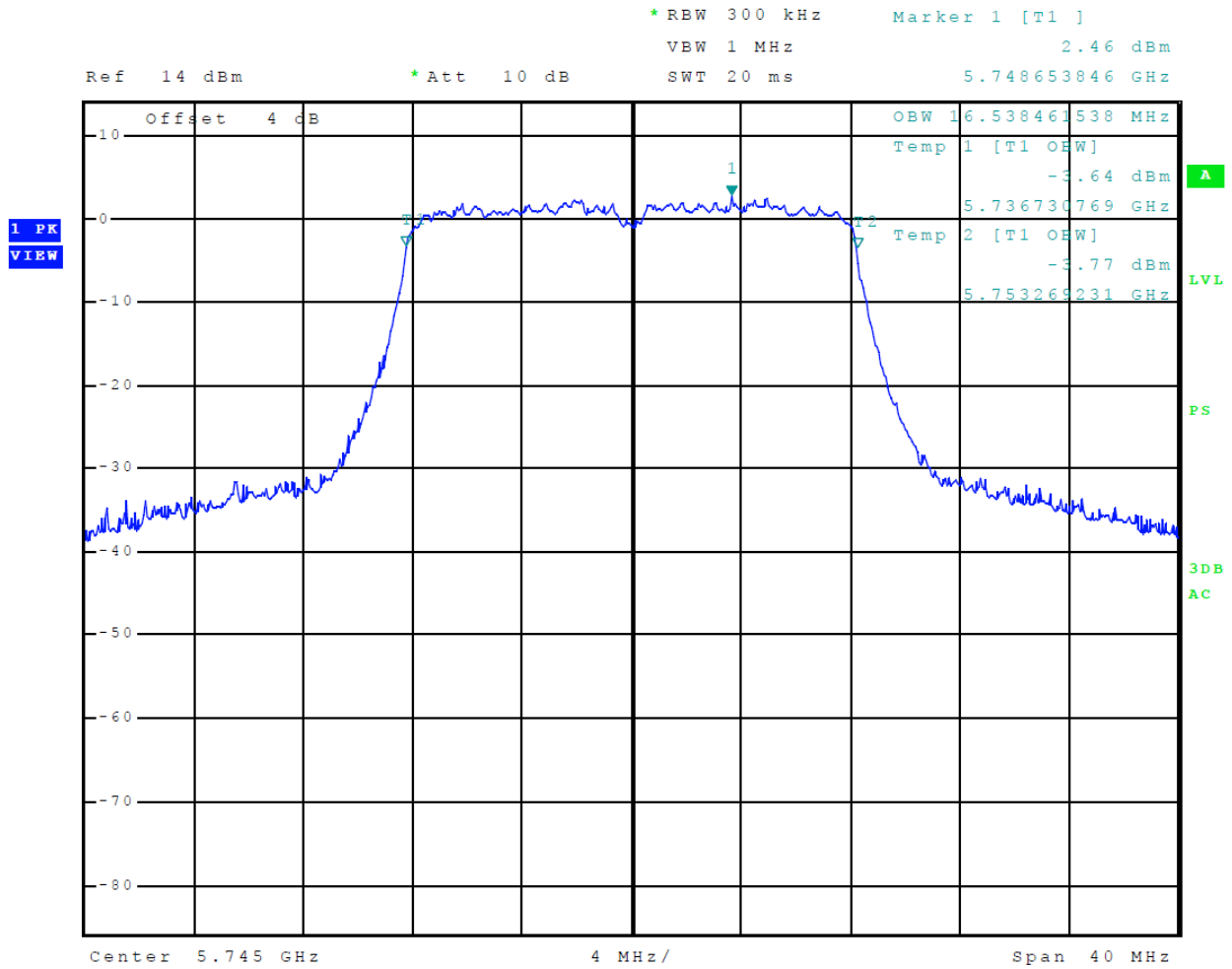

Figure 68 Plot of Transmitter Emissions (5725-5850 MHz Band, 802.11a, Chain 1, 99% OBW)

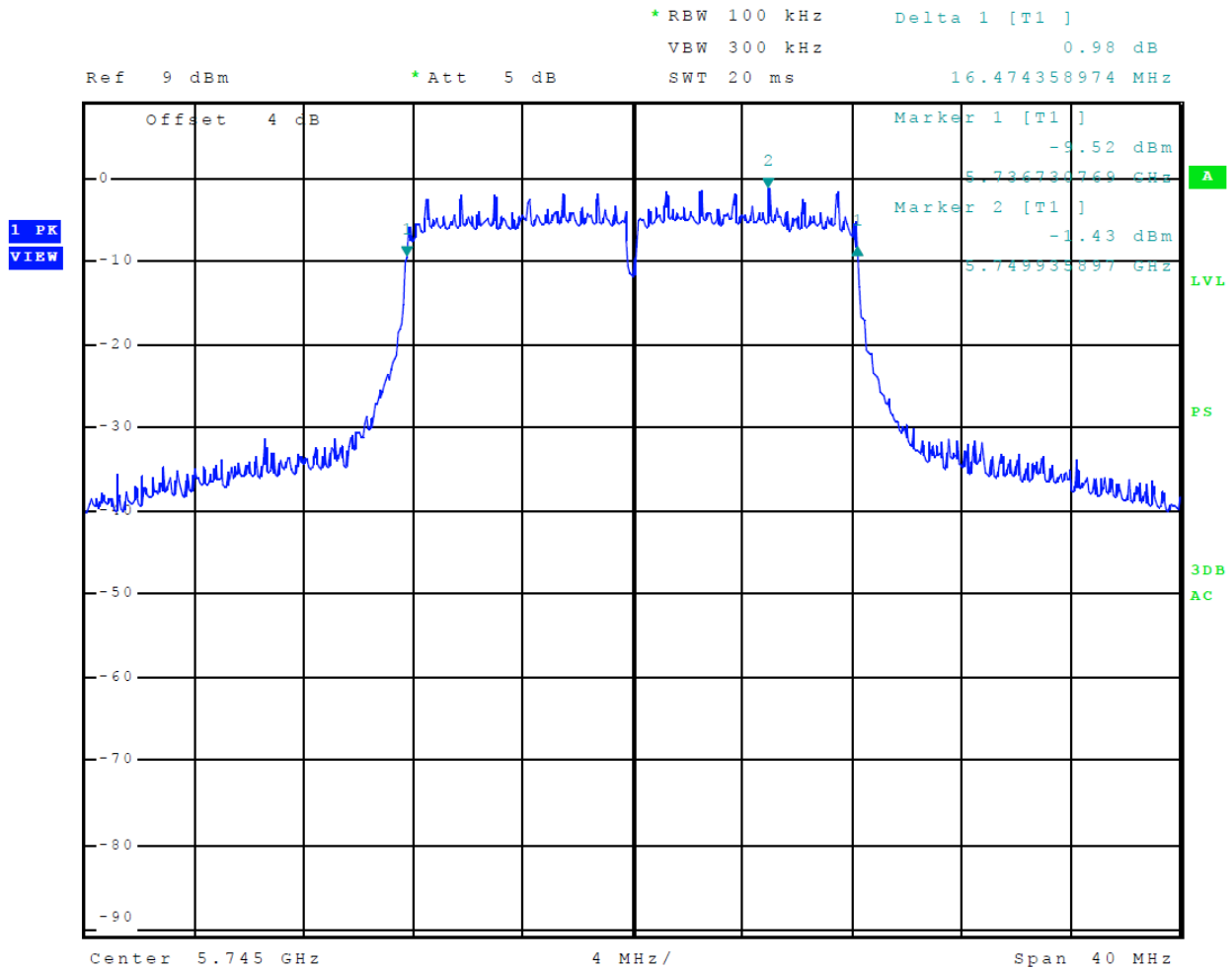

Figure 69 Plot of Transmitter Emissions (5725-5850 MHz Band, 802.11a, Chain 0, 6-dB OBW)

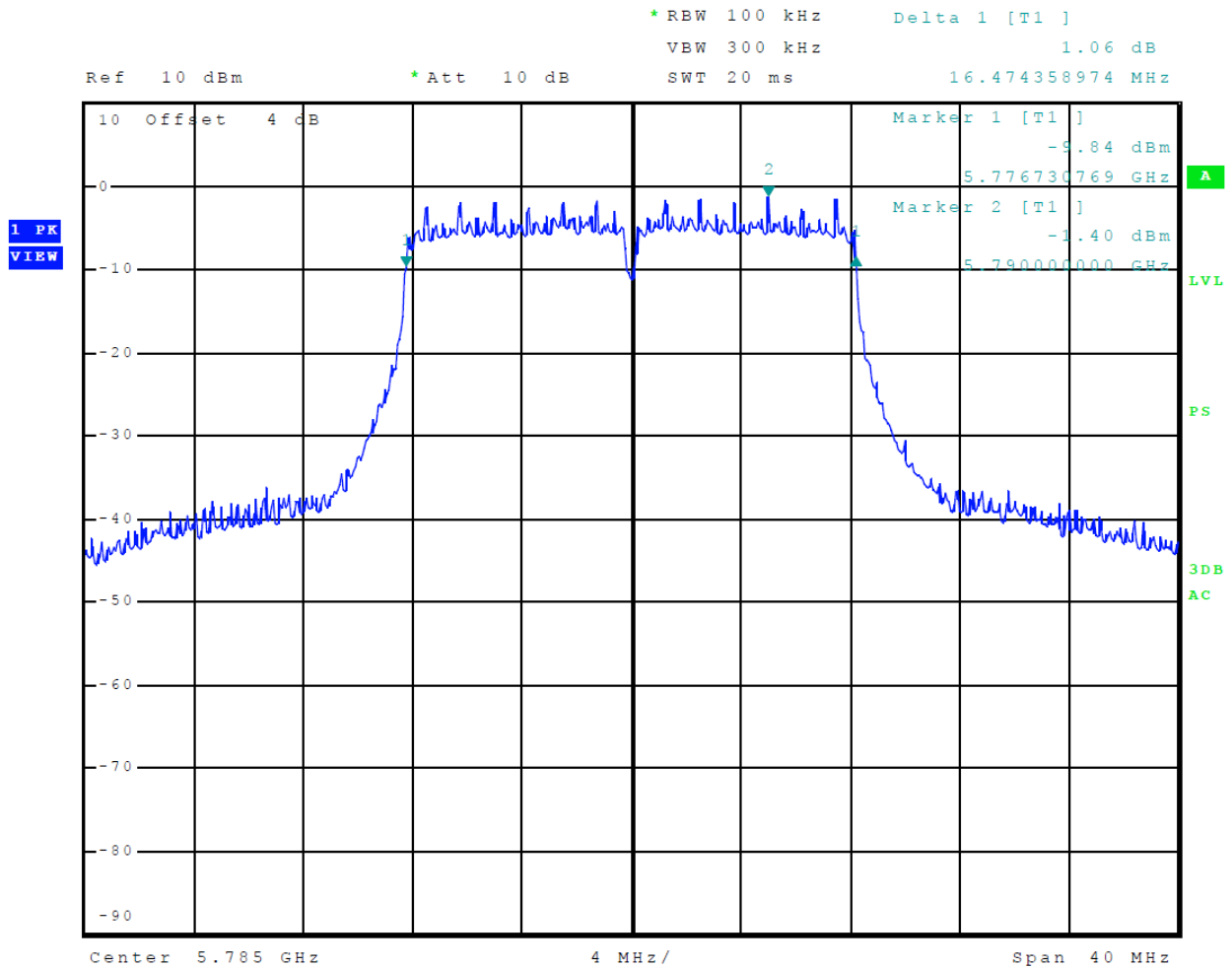

Figure 70 Plot of Transmitter Emissions (5725-5850 MHz Band, 802.11a, Chain 1, 6-dB OBW)

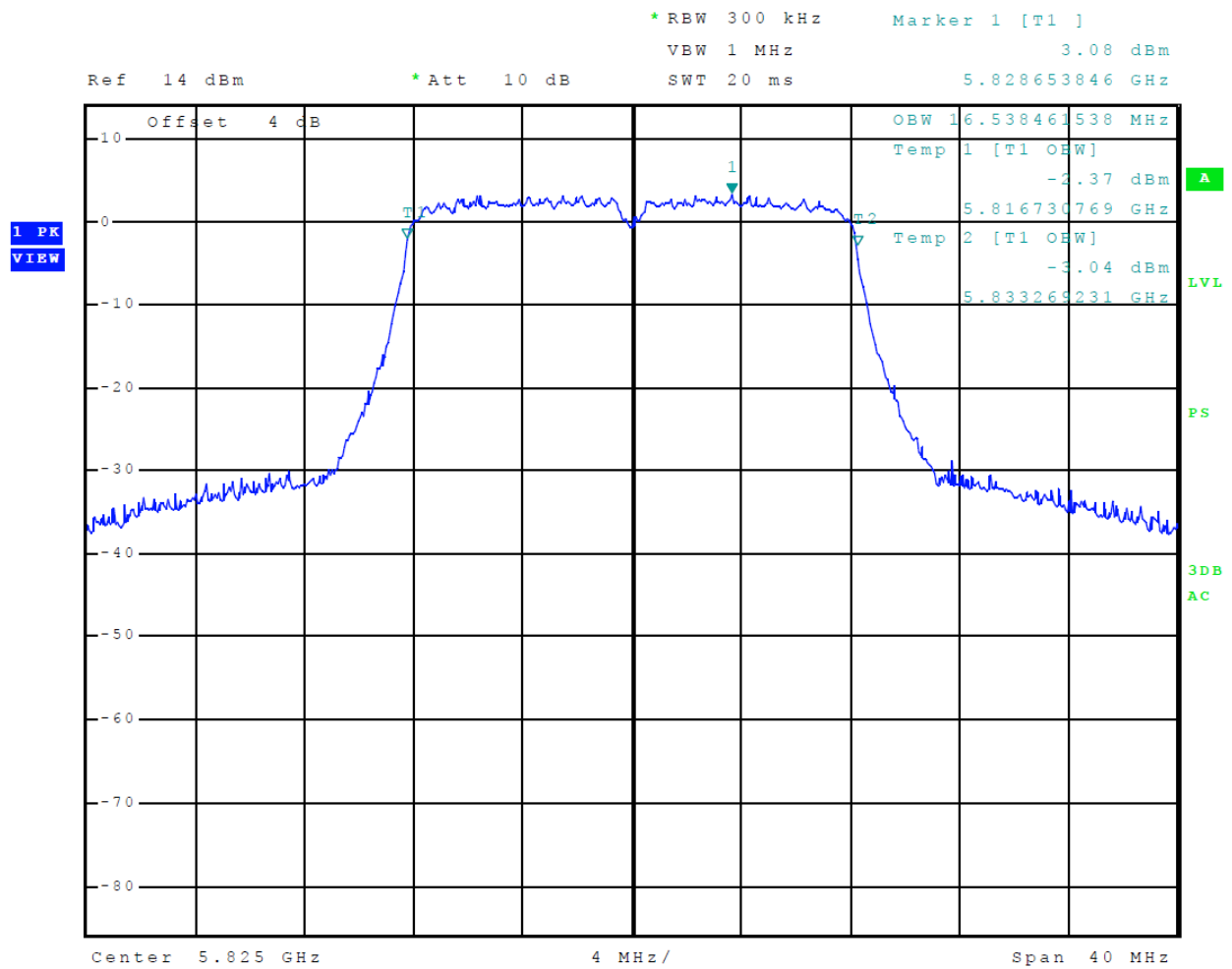

Figure 71 Plot of Transmitter Emissions (5725-5850 MHz Band, 802.11n, Chain 0, 99% OBW)

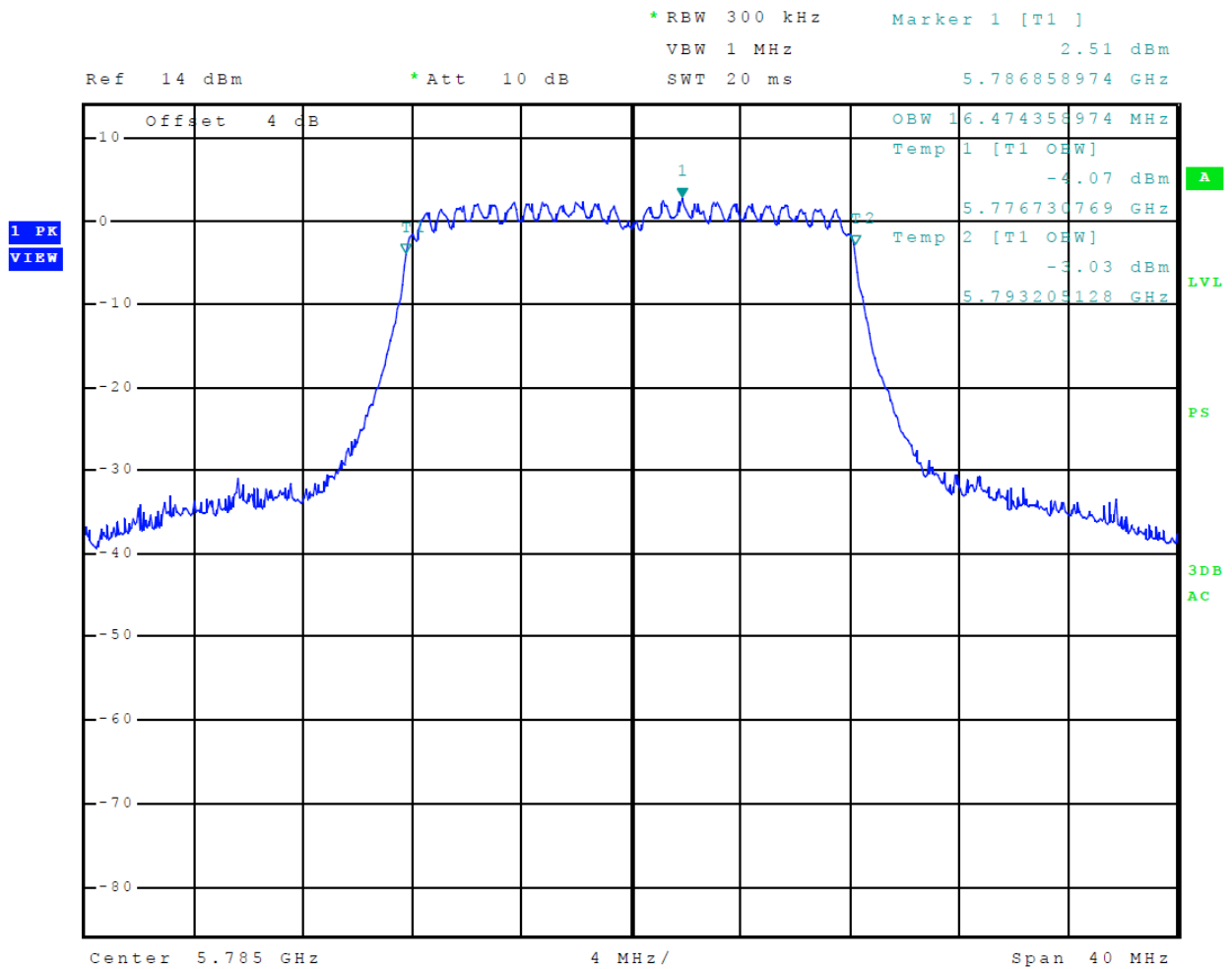

Figure 72 Plot of Transmitter Emissions (5725-5850 MHz Band, 802.11n, Chain 1, 99% OBW)

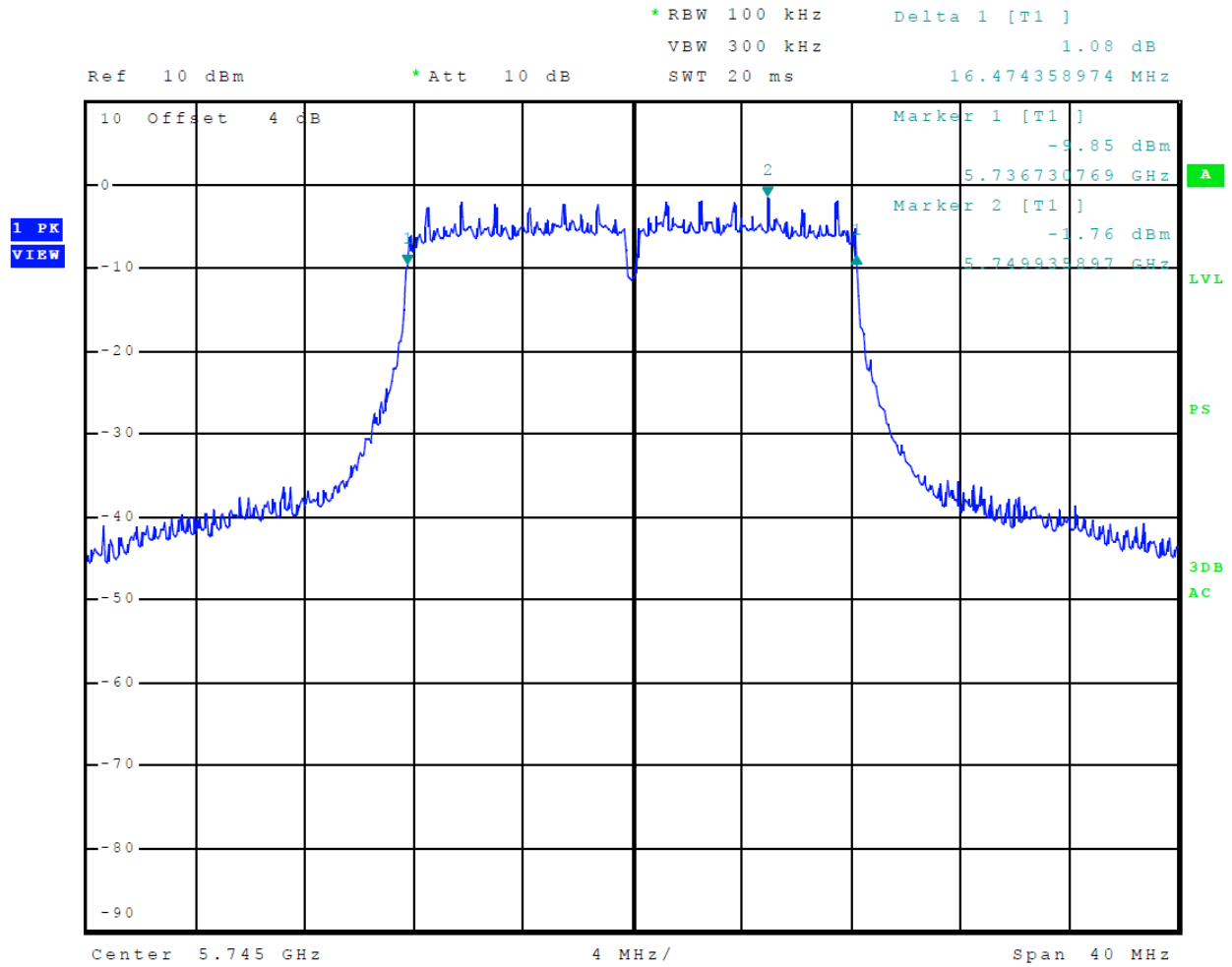

Figure 73 Plot of Transmitter Emissions (5725-5850 MHz Band, 802.11n, Chain 0, 6-dB OBW)

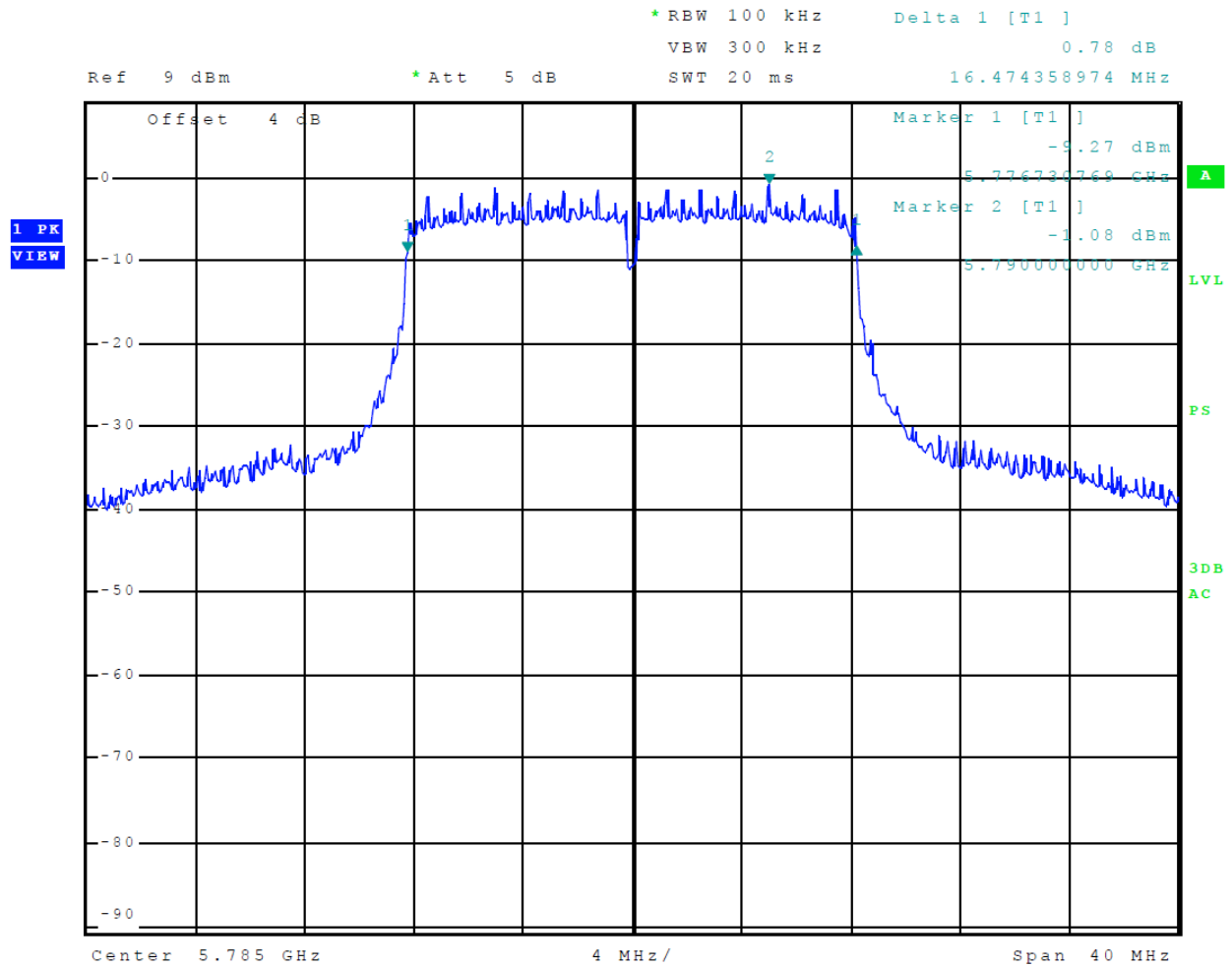

Figure 74 Plot of Transmitter Emissions (5725-5850 MHz Band, 802.11n, Chain 1, 6-dB OBW)

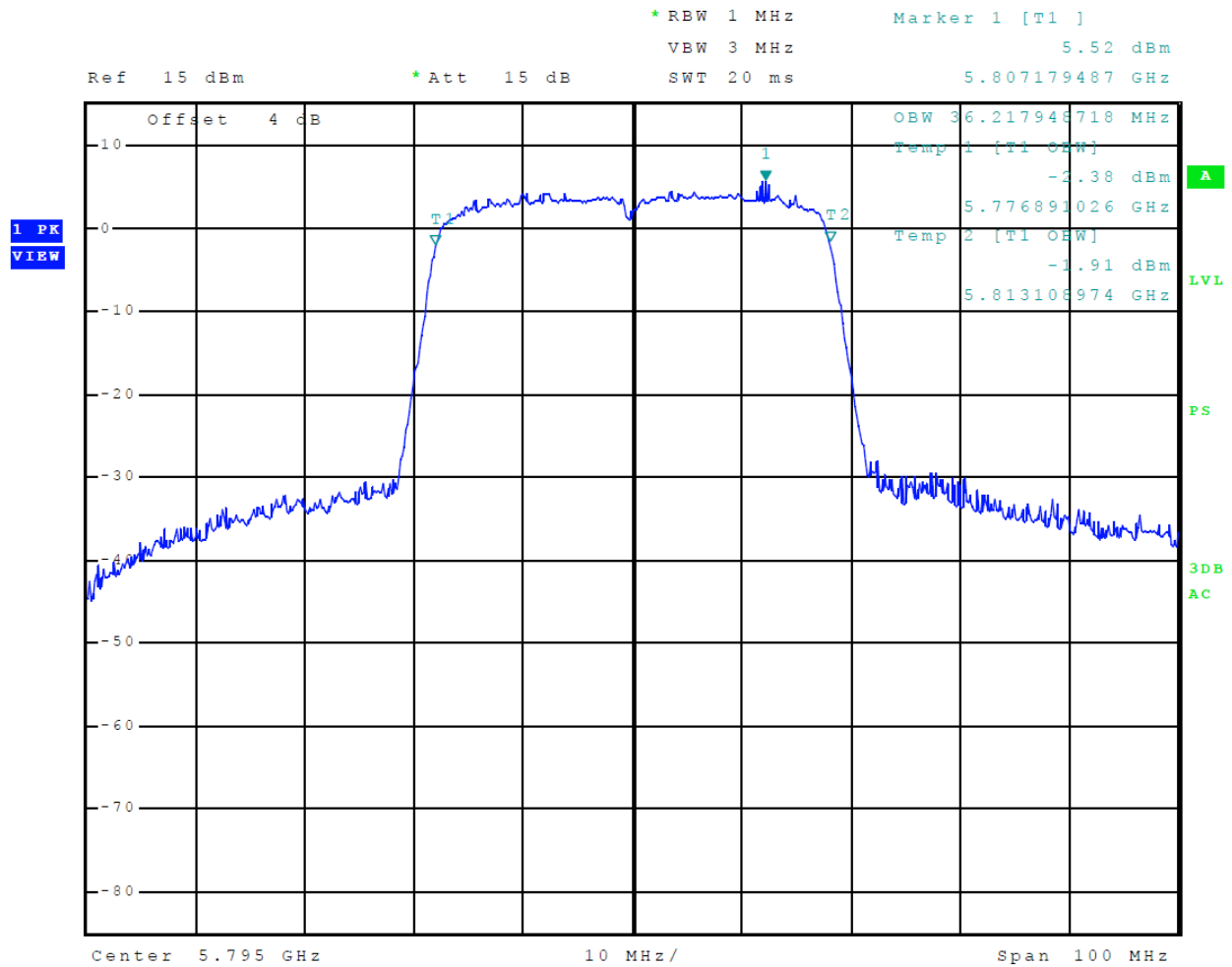

Figure 75 Plot of Transmitter Emissions (5725-5850 MHz Band, 802.11n40, Chain 0, 99% OBW)

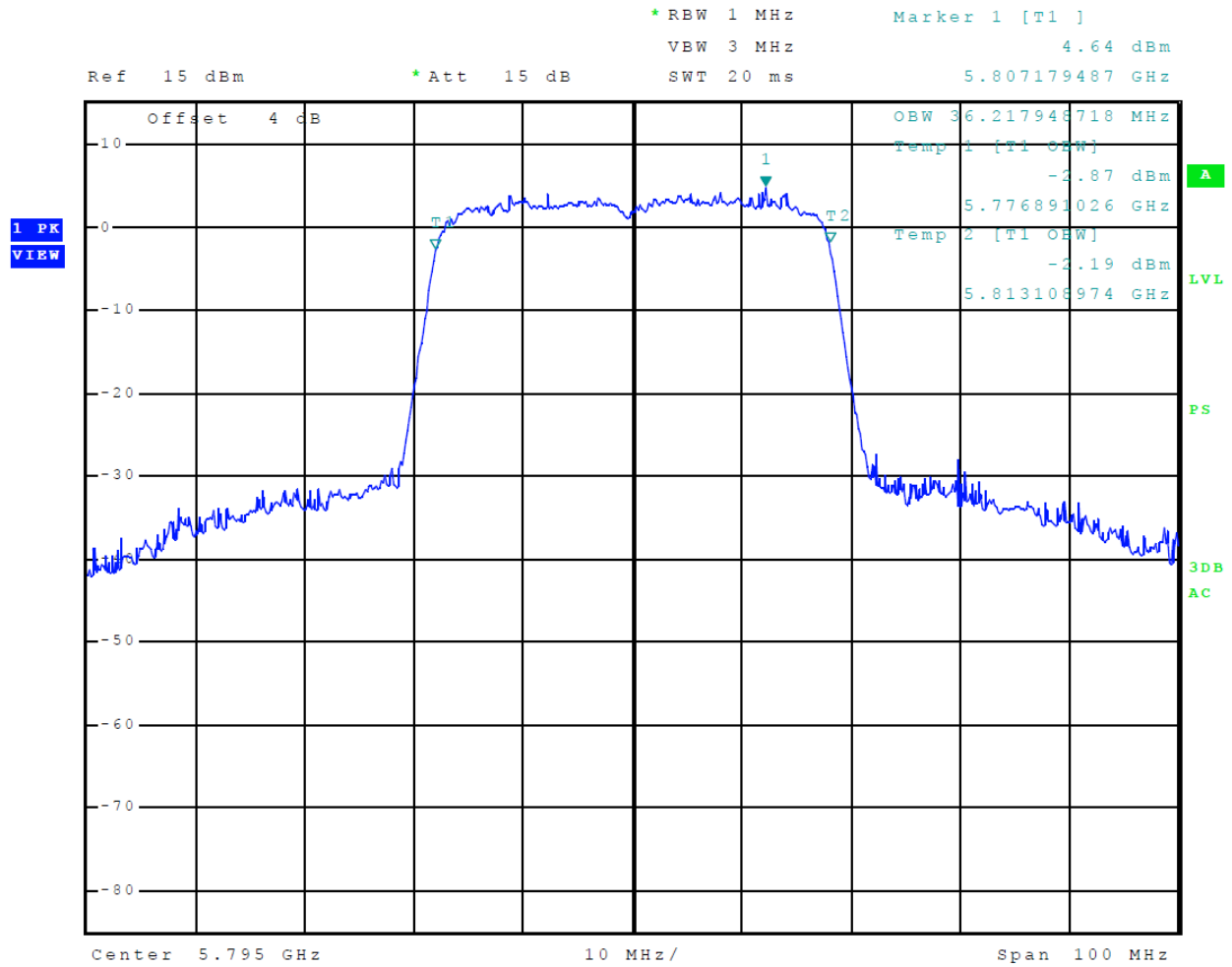

Figure 76 Plot of Transmitter Emissions (5725-5850 MHz Band, 802.11n40, Chain 1, 99% OBW)

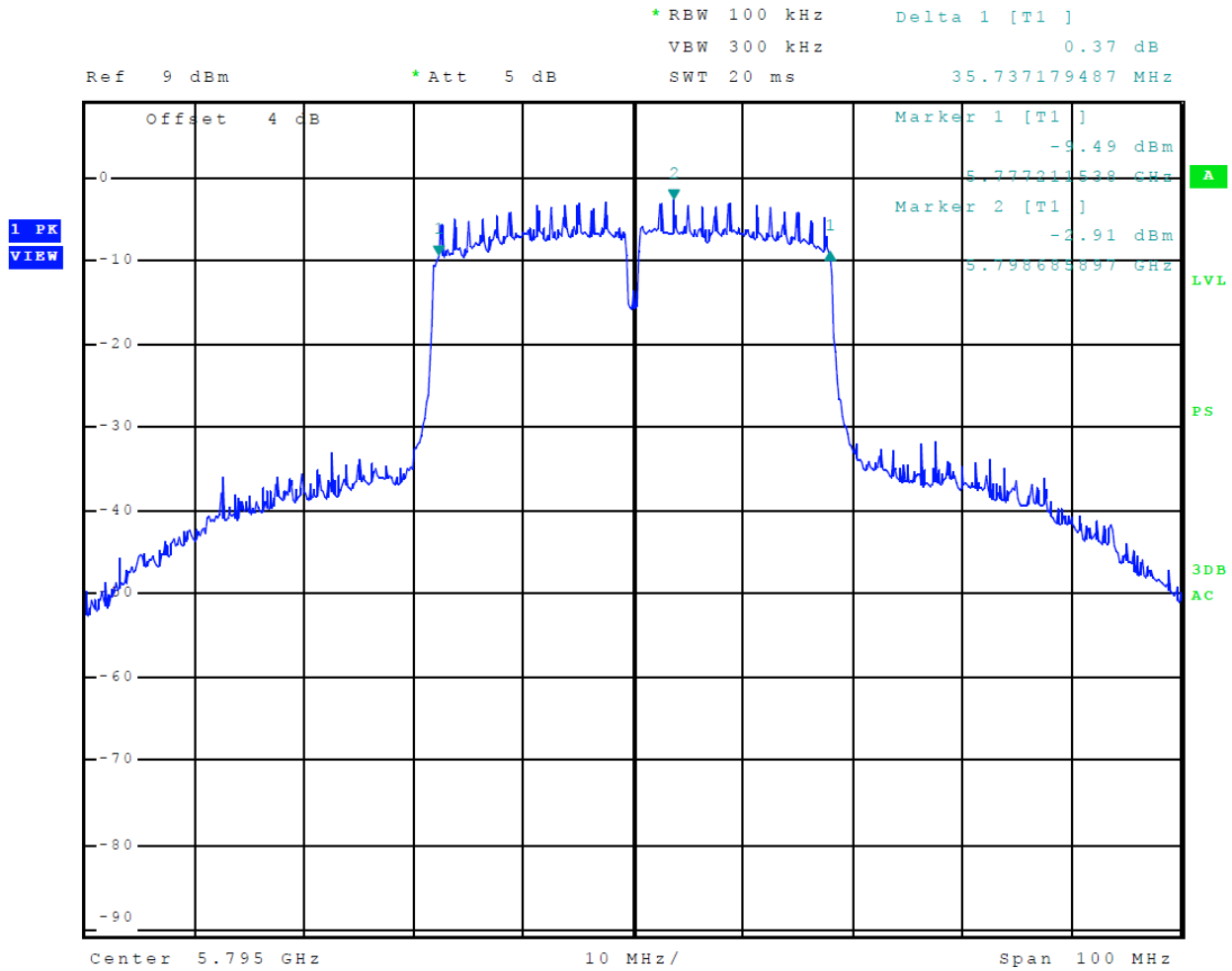

Figure 77 Plot of Transmitter Emissions (5725-5850 MHz Band, 802.11n40, Chain 0, 6-dB OBW)

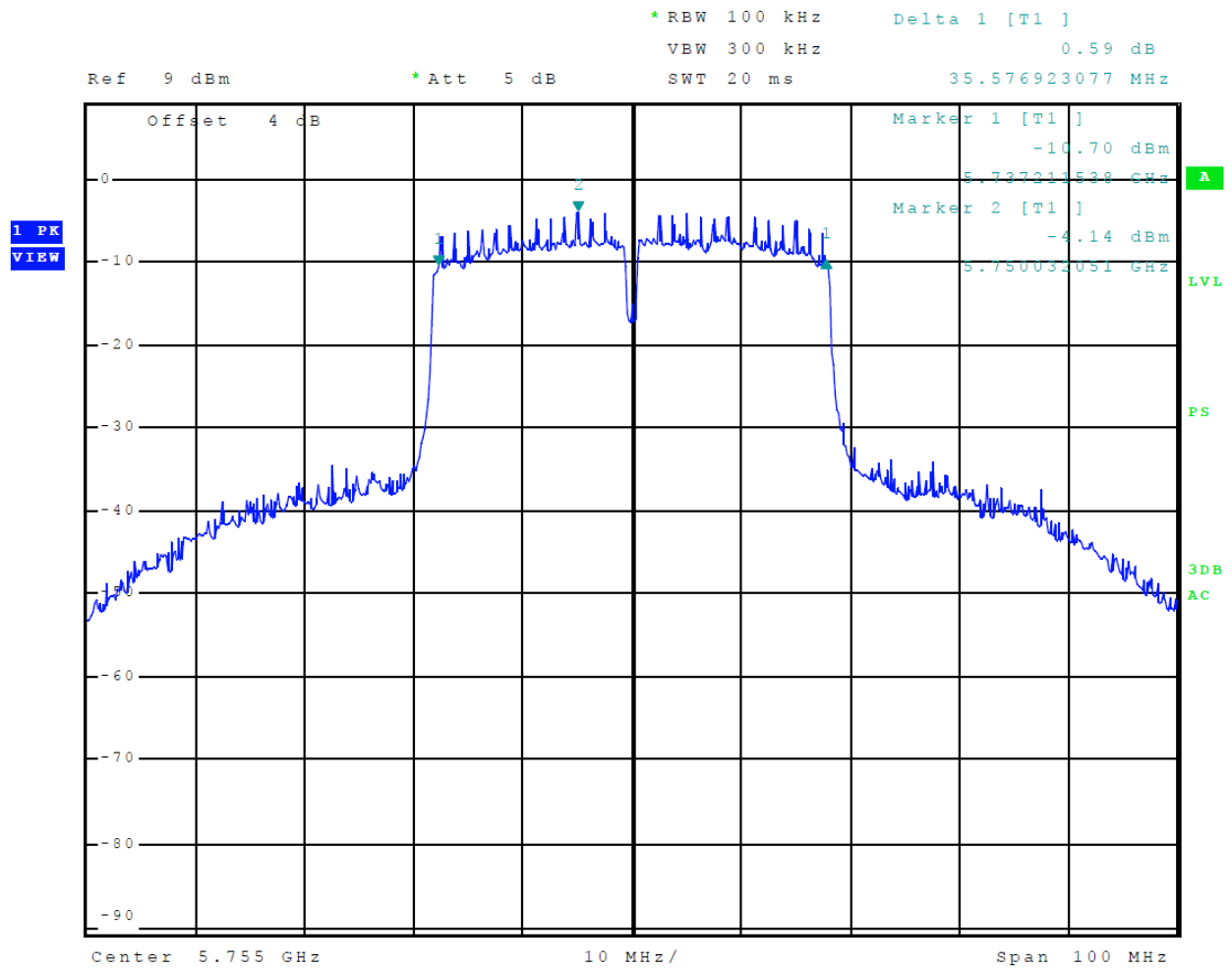

Figure 78 Plot of Transmitter Emissions (5725-5850 MHz Band, 802.11n40, Chain 1, 6-dB OBW)

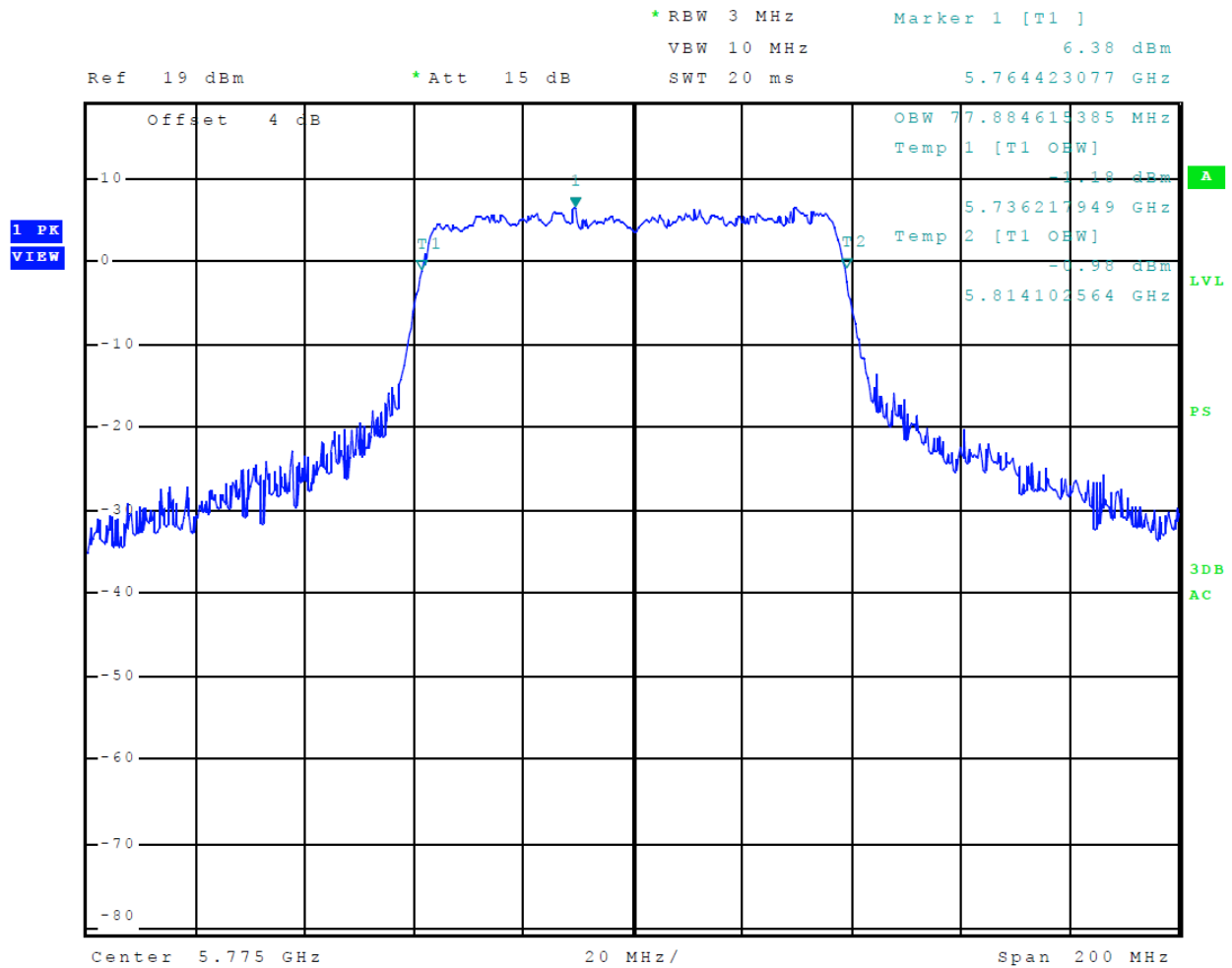

Figure 79 Plot of Transmitter Emissions (5725-5850 MHz Band, 802.11ac, Chain 0, 99% OBW)

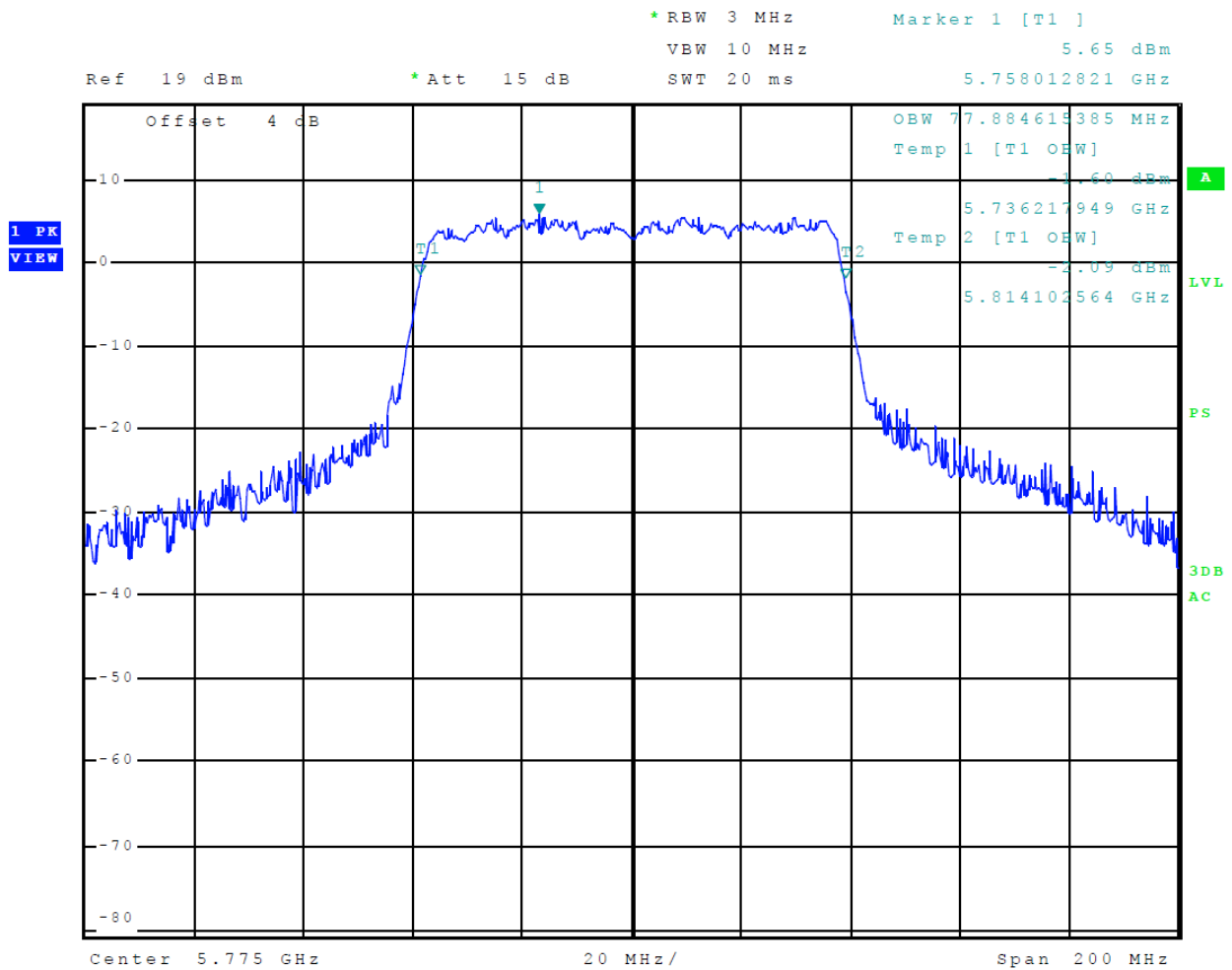

Figure 80 Plot of Transmitter Emissions (5725-5850 MHz Band, 802.11ac, Chain 1, 99% OBW)

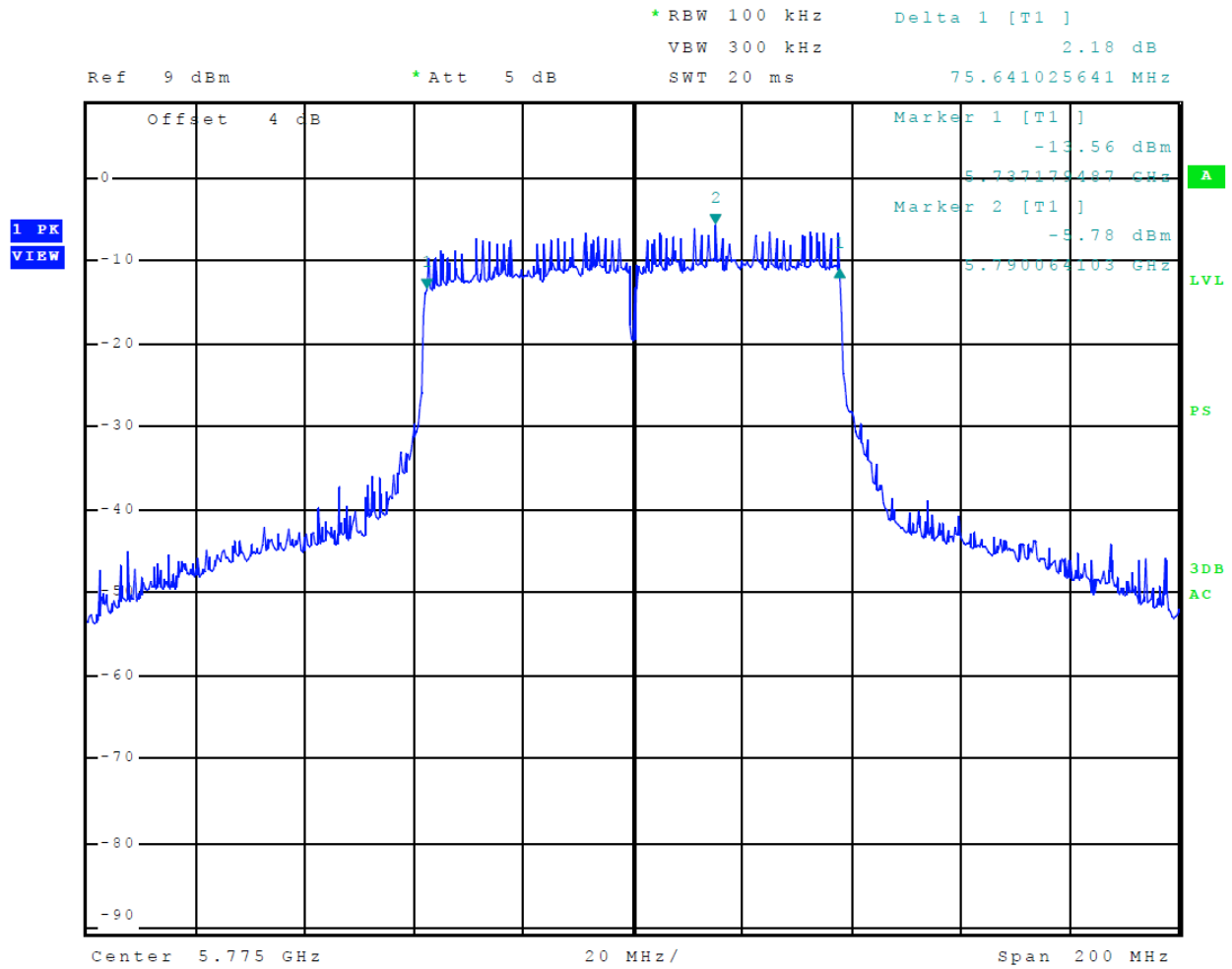

Figure 81 Plot of Transmitter Emissions (5725-5850 MHz Band, 802.11ac, Chain 0, 6-dB OBW)

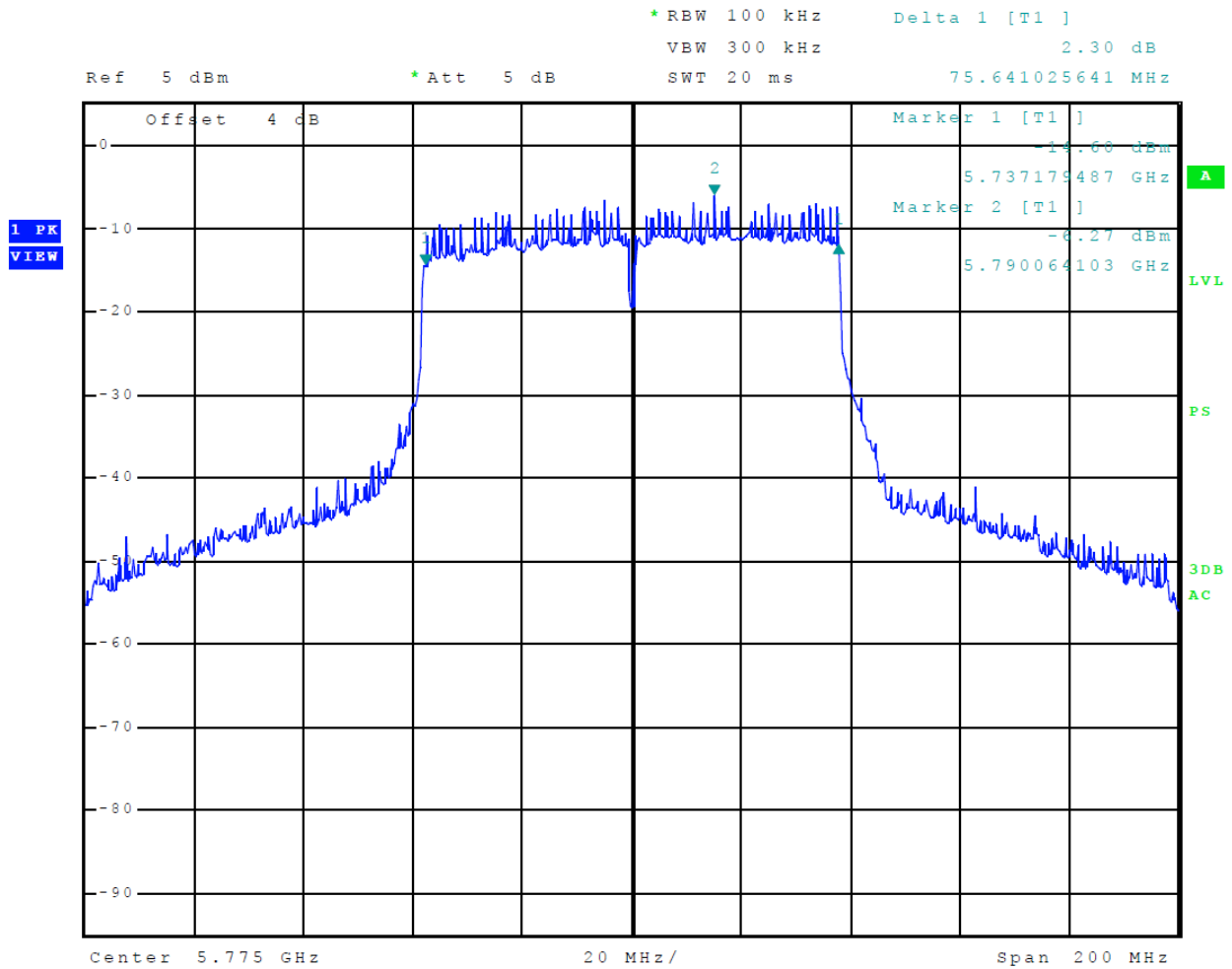

Figure 82 Plot of Transmitter Emissions (5725-5850 MHz Band, 802.11ac, Chain 1, 6-dB OBW)

Transmitter Emissions Data

Table 12 Transmitter Worst-case Radiated Emission (802.11a, 5150-5250 MHz Band)

Frequency in MHz	Horizontal Peak (dB μ V/m)	Horizontal Average (dB μ V/m)	Vertical Peak (dB μ V/m)	Vertical Average (dB μ V/m)	Limit @ 3m (dB μ V/m)	Horizontal Margin (dB)	Vertical Margin (dB)
U-NII-1, 802.11a, 20 MHz Channel							
5180.0	--	--	--	--	--	--	--
10360.0	58.0	44.7	58.5	44.7	68.3	-23.6	-23.6
15540.0	63.3	50.2	63.1	50.3	68.3	-18.1	-18.0
20720.0	64.9	51.7	64.6	51.7	68.3	-16.6	-16.6
25900.0	66.7	53.1	66.2	53.1	68.3	-15.2	-15.2
5200.0	--	--	--	--	--	--	--
10400.0	58.3	45.0	57.8	45.0	68.3	-23.3	-23.3
15600.0	63.1	50.1	62.9	50.1	68.3	-18.2	-18.2
20800.0	63.9	51.2	64.4	51.1	68.3	-17.1	-17.2
26000.0	65.3	52.6	65.5	52.6	68.3	-15.7	-15.7
5240.0	--	--	--	--	--	--	--
10480.0	58.6	45.2	58.3	45.4	68.3	-23.1	-22.9
15720.0	64.0	50.7	63.5	50.9	68.3	-17.6	-17.4
20960.0	64.3	51.2	64.2	51.2	68.3	-17.1	-17.1
26200.0	65.7	52.5	65.8	52.5	68.3	-15.8	-15.8
Band Edges							
5150.0	67.4	52.7	56.2	39.4	54.0	-1.3	-14.6
5250.0	84.5	64.1	83.2	64.3	68.3	-4.2	-4.0

Other emissions present had amplitudes at least 20 dB below the limit. Peak and Quasi-Peak amplitude emissions are recorded for frequency below 1000 MHz. Peak and Average amplitude emissions are recorded for frequency range above 1000 MHz.

Table 13 Transmitter Worst-case Radiated Emission (802.11n, 5150-5250 MHz Band)

Frequency in MHz	Horizontal Peak (dB μ V/m)	Horizontal Average (dB μ V/m)	Vertical Peak (dB μ V/m)	Vertical Average (dB μ V/m)	Limit @ 3m (dB μ V/m)	Horizontal Margin (dB)	Vertical Margin (dB)
U-NII-1, 802.11n, 20 MHz Channel							
5180.0	--	--	--	--	--	--	--
10360.0	56.5	42.6	56.7	43.5	68.3	-25.7	-24.8
15540.0	62.4	48.5	61.7	49.2	68.3	-19.8	-19.1
20720.0	64.6	51.9	64.7	51.9	68.3	-16.4	-16.4
25900.0	67.1	53.3	66.3	53.3	68.3	-15.0	-15.0
5200.0	--	--	--	--	--	--	--
10400.0	56.6	43.2	57.3	43.7	68.3	-25.1	-24.6
15600.0	61.9	48.3	61.8	49.0	68.3	-20.0	-19.3
20800.0	64.8	51.6	64.3	51.5	68.3	-16.7	-16.8
26000.0	65.4	52.8	65.7	52.8	68.3	-15.5	-15.5
5240.0	--	--	--	--	--	--	--
10480.0	57.1	43.7	57.1	44.1	68.3	-24.6	-24.2
15720.0	62.9	49.1	62.5	49.6	68.3	-19.2	-18.7
20960.0	64.7	51.4	64.4	51.3	68.3	-16.9	-17.0
26200.0	65.2	52.7	65.7	52.7	68.3	-15.6	-15.6
Band Edges							
5150.0	67.0	49.9	56.8	40.1	54.0	-4.1	-13.9
5250.0	84.2	64.4	82.7	64.1	68.0	-3.6	-3.9

Other emissions present had amplitudes at least 20 dB below the limit. Peak and Quasi-Peak amplitude emissions are recorded for frequency below 1000 MHz. Peak and Average amplitude emissions are recorded for frequency range above 1000 MHz.

Table 14 Transmitter Worst-case Radiated Emission (802.11n40, 5150-5250 MHz Band)

Frequency in MHz	Horizontal Peak (dB μ V/m)	Horizontal Average (dB μ V/m)	Vertical Peak (dB μ V/m)	Vertical Average (dB μ V/m)	Limit @ 3m (dB μ V/m)	Horizontal Margin (dB)	Vertical Margin (dB)
U-NII-1, 802.11n40, 40 MHz Channel							
5190.0	--	--	--	--	--	--	--
10380.0	58.3	45.3	57.9	44.9	68.3	-23.0	-23.4
15570.0	62.3	49.4	64.5	50.9	68.3	-18.9	-17.4
20760.0	64.2	51.3	64.1	51.2	68.3	-17.0	-17.1
25950.0	66.0	53.0	66.4	53.0	68.3	-15.3	-15.3
5230.0	--	--	--	--	--	--	--
10460.0	57.9	45.5	58.3	45.5	68.3	-22.8	-22.8
15690.0	63.6	50.5	63.2	50.5	68.3	-17.8	-17.8
20920.0	64.5	51.2	64.1	51.1	68.3	-17.1	-17.2
26150.0	65.3	52.1	65.7	52.1	68.3	-16.2	-16.2
Band Edges							
5150.0	72.2	53.4	64.8	47.7	54.0	-0.6	-6.3
5250.0	76.7	56.8	77.4	59.3	68.0	-11.2	-8.7

Other emissions present had amplitudes at least 20 dB below the limit. Peak and Quasi-Peak amplitude emissions are recorded for frequency below 1000 MHz. Peak and Average amplitude emissions are recorded for frequency range above 1000 MHz.

Table 15 Transmitter Worst-case Radiated Emission (802.11ac, 5150-5250 MHz Band)

Frequency in MHz	Horizontal Peak (dBµV/m)	Horizontal Average (dBµV/m)	Vertical Peak (dBµV/m)	Vertical Average (dBµV/m)	Limit @ 3m (dBµV/m)	Horizontal Margin (dB)	Vertical Margin (dB)
U-NII-1, 802.11ac, 80 MHz Channel							
5210.0	--	--	--	--	--	--	--
10420.0	58.2	45.2	58.2	45.3	68.3	-23.1	-23.0
15630.0	56.6	43.9	57.6	44.0	68.3	-24.4	-24.3
20840.0	64.0	51.2	64.5	51.2	68.3	-17.1	-17.1
26050.0	66.4	53.1	66.1	53.1	68.3	-15.2	-15.2
Band Edges							
5150.0	66.5	46.0	67.5	47.2	54.0	-8.0	-6.8
5250.0	83.1	67.2	82.3	65.9	68.0	-0.8	-2.1

Other emissions present had amplitudes at least 20 dB below the limit. Peak and Quasi-Peak amplitude emissions are recorded for frequency below 1000 MHz. Peak and Average amplitude emissions are recorded for frequency range above 1000 MHz.

Table 16 Transmitter Radiated Emission (802.11a, 5725-5850 MHz Band)

Frequency in MHz	Horizontal Peak (dBµV/m)	Horizontal Average (dBµV/m)	Vertical Peak (dBµV/m)	Vertical Average (dBµV/m)	Limit @ 3m (dBµV/m)	Horizontal Margin (dB)	Vertical Margin (dB)
U-NII-3, 802.11a, 20 MHz Channel							
5745.0	--	--	--	--	--	--	--
11490.0	58.7	45.8	58.5	45.8	68.3	-22.5	-22.5
17235.0	64.3	51.2	63.6	51.2	68.3	-17.1	-17.1
22980.0	65.7	52.0	65.4	52.0	68.3	-16.3	-16.3
28725.0	68.9	55.4	68.4	55.4	68.3	-12.9	-12.9
5785.0	--	--	--	--	--	--	--
11570.0	58.7	45.8	59.4	45.9	68.3	-22.5	-22.4
17355.0	64.8	51.8	65.3	51.8	68.3	-16.5	-16.5
23140.0	65.0	52.0	64.9	51.9	68.3	-16.3	-16.4
28925.0	68.7	55.6	68.5	55.5	68.3	-12.7	-12.8
5825.0	--	--	--	--	--	--	--
11650.0	59.3	46.2	59.5	46.3	68.3	-22.1	-22.0
17475.0	63.1	51.3	63.2	51.5	68.3	-17.0	-16.8
23300.0	64.5	51.8	65.5	51.9	68.3	-16.5	-16.4
29125.0	68.6	55.5	68.5	55.5	68.3	-12.8	-12.8
Band Edges							
5725.0	70.6	54.0	68.2	49.6	78.2	-24.2	-28.6
5850.0	67.3	50.8	61.4	41.7	78.2	-27.4	-36.5

Other emissions present had amplitudes at least 20 dB below the limit. Peak and Quasi-Peak amplitude emissions are recorded for frequency below 1000 MHz. Peak and Average amplitude emissions are recorded for frequency range above 1000 MHz.

Table 17 Transmitter Radiated Emission (802.11n, 5725-5850 MHz Band)

Frequency in MHz	Horizontal Peak (dB μ V/m)	Horizontal Average (dB μ V/m)	Vertical Peak (dB μ V/m)	Vertical Average (dB μ V/m)	Limit @ 3m (dB μ V/m)	Horizontal Margin (dB)	Vertical Margin (dB)
U-NII-3, 802.11n, 20 MHz Channel							
5745.0	--	--	--	--	--	--	--
11490.0	57.5	43.3	57.1	44.1	68.3	-25.0	-24.2
17235.0	62.4	48.7	62.6	49.5	68.3	-19.6	-18.8
22980.0	64.7	52.2	65.1	52.2	68.3	-16.1	-16.1
28725.0	68.3	55.5	68.3	55.5	68.3	-12.8	-12.8
5785.0	--	--	--	--	--	--	--
11570.0	57.1	44.1	57.6	44.7	68.3	-24.2	-23.6
17355.0	63.4	49.9	63.9	50.6	68.3	-18.4	-17.7
23140.0	65.2	52.1	64.8	52.1	68.3	-16.2	-16.2
28925.0	68.4	55.7	68.6	55.7	68.3	-12.6	-12.6
5825.0	--	--	--	--	--	--	--
11650.0	57.5	44.4	57.6	44.9	68.3	-23.9	-23.4
17475.0	63.8	50.2	64.2	51.1	68.3	-18.1	-17.2
23300.0	65.5	51.9	65.0	51.9	68.3	-16.4	-16.4
29125.0	69.0	55.5	68.7	55.4	68.3	-12.8	-12.9
Band Edges							
5725.0	70.9	52.2	69.1	50.3	78.2	-26.0	-27.9
5850.0	67.5	50.5	61.8	41.2	78.2	-27.7	-37.0

Other emissions present had amplitudes at least 20 dB below the limit. Peak and Quasi-Peak amplitude emissions are recorded for frequency below 1000 MHz. Peak and Average amplitude emissions are recorded for frequency range above 1000 MHz.

Table 18 Transmitter Radiated Emission (802.11n40, 5725-5850 MHz Band)

Frequency in MHz	Horizontal Peak (dB μ V/m)	Horizontal Average (dB μ V/m)	Vertical Peak (dB μ V/m)	Vertical Average (dB μ V/m)	Limit @ 3m (dB μ V/m)	Horizontal Margin (dB)	Vertical Margin (dB)
U-NII-3, 802.11n40, 40 MHz Channel							
5755.0	--	--	--	--	--	--	--
11510.0	58.5	45.5	58.7	45.6	68.3	-22.8	-22.7
17265.0	64.4	51.0	64.5	51.1	68.3	-17.3	-17.2
23020.0	65.4	51.9	65.2	52.0	68.3	-16.4	-16.3
28775.0	68.6	55.3	69.2	55.3	68.3	-13.0	-13.0
5795.0	--	--	--	--	--	--	--
11590.0	58.3	45.8	58.9	46.0	68.3	-22.5	-22.3
17385.0	64.5	51.6	64.3	51.7	68.3	-16.7	-16.6
23180.0	64.9	51.9	65.2	51.9	68.3	-16.4	-16.4
28975.0	68.4	55.4	68.7	55.4	68.3	-12.9	-12.9
Band Edges							
5725.0	73.8	57.8	63.5	42.9	78.2	-20.4	-35.3
5850.0	63.0	43.5	59.5	40.2	78.2	-34.7	-38.0

Other emissions present had amplitudes at least 20 dB below the limit. Peak and Quasi-Peak amplitude emissions are recorded for frequency below 1000 MHz. Peak and Average amplitude emissions are recorded for frequency range above 1000 MHz.

Table 19 Transmitter Radiated Emission (802.11ac, 5725-5850 MHz Band)

Frequency in MHz	Horizontal Peak (dB μ V/m)	Horizontal Average (dB μ V/m)	Vertical Peak (dB μ V/m)	Vertical Average (dB μ V/m)	Limit @ 3m (dB μ V/m)	Horizontal Margin (dB)	Vertical Margin (dB)
U-NII-3, 802.11ac, 80 MHz Channel							
5775.0	--	--	--	--	--	--	--
11550.0	57.6	44.7	58.2	45.5	68.3	-23.6	-22.8
17325.0	64.2	50.8	39.8	51.0	68.3	-17.5	-17.3
23100.0	64.9	52.0	64.7	52.1	68.3	-16.3	-16.2
28875.0	68.1	55.4	68.2	55.3	68.3	-12.9	-13.0
Band Edges							
5725.0	71.6	49.3	69.7	45.4	78.2	-28.9	-32.8
5850.0	69.4	44.7	65.1	42.4	78.2	-33.5	-35.8

Other emissions present had amplitudes at least 20 dB below the limit. Peak and Quasi-Peak amplitude emissions are recorded for frequency below 1000 MHz. Peak and Average amplitude emissions are recorded for frequency range above 1000 MHz.

Table 20 FCC U-NII-1, EIRP Output Power, OBW, and PSD (Chain 0)

Frequency MHz	EIRP Output Power (Watts)	99 Occupied Bandwidth (kHz)	Peak Power Spectral Density (dBm/MHz)
U-NII-1, 802.11a, 20 MHz Channel			
5180	0.156	16,538.5	8.5
5200	0.161	16,538.5	9.8
5240	0.143	16,538.5	9.1
U-NII-1, 802.11n, 20 Channel			
5180	0.145	16,538.5	8.9
5200	0.144	16,538.5	9.6
5240	0.152	16,538.5	9.4
U-NII-1, 802.11n40, 40 MHz Channel			
5190	0.143	36,217.9	6.0
5230	0.145	36,217.9	6.6
U-NII-1, 802.11ac, 80 MHz Channel			
5210	0.097	76,602.6	1.9

Table 21 FCC U-NII-1, EIRP Output Power, OBW, and PSD (Chain 1)

Frequency MHz	EIRP Output Power (Watts)	99 Occupied Bandwidth (kHz)	Peak Power Spectral Density (dBm/MHz)
U-NII-1, 802.11a, 20 MHz Channel			
5180	0.162	16,506.4	9.1
5200	0.169	16,506.4	10.4
5240	0.158	16,426.3	10.3
U-NII-1, 802.11n, 20 Channel			
5180	0.164	16,474.4	9.1
5200	0.153	16,474.4	10.3
5240	0.159	16,474.4	10.3
U-NII-1, 802.11n40, 40 MHz Channel			
5190	0.162	36,217.9	6.9
5230	0.160	36,217.9	7.5
U-NII-1, 802.11ac, 80 MHz Channel			
5210	0.116	76,602.6	3.5

Table 22 ISED U-NII-1, EIRP Output Power, OBW, and PSD (Chain 0)

Frequency MHz	EIRP Output Power (Watts)	99 Occupied Bandwidth (kHz)	Peak Power Spectral Density (dBm/MHz)
U-NII-1, 802.11a, 20 MHz Channel			
5180	0.090	16,538.5	5.5
5200	0.093	16,538.5	6.8
5240	0.082	16,538.5	6.1
U-NII-1, 802.11n, 20 Channel			
5180	0.087	16,538.5	5.9
5200	0.086	16,538.5	6.6
5240	0.092	16,538.5	6.3
U-NII-1, 802.11n40, 40 MHz Channel			
5190	0.086	36,217.9	4.0
5230	0.087	36,217.9	4.6
U-NII-1, 802.11ac, 80 MHz Channel			
5210	0.070	76,602.6	1.4

Table 23 ISED U-NII-1, EIRP Output Power, OBW, and PSD (Chain 1)

Frequency MHz	EIRP Output Power (Watts)	99 Occupied Bandwidth (kHz)	Peak Power Spectral Density (dBm/MHz)
U-NII-1, 802.11a, 20 MHz Channel			
5180	0.093	16,506.4	5.1
5200	0.097	16,506.4	6.4
5240	0.091	16,426.3	7.3
U-NII-1, 802.11n, 20 Channel			
5180	0.099	16,474.4	6.1
5200	0.092	16,474.4	7.3
5240	0.096	16,474.4	7.3
U-NII-1, 802.11n40, 40 MHz Channel			
5190	0.097	36,217.9	4.9
5230	0.096	36,217.9	5.5
U-NII-1, 802.11ac, 80 MHz Channel			
5210	0.084	76,602.6	3.0

Table 24 U-NII-3, EIRP Output Power, OBW, and PSD (Chain 0)

Frequency MHz	EIRP Output Power (Watts)	99% Occupied Bandwidth (kHz)	6-dB Occupied Bandwidth (kHz)	Peak Power Spectral Density (dBm/500kHz)
U-NII-3, 802.11a, 20 MHz Channel				
5745	0.182	16,538.5	16,474.4	7.3
5785	0.166	16,538.5	16,474.4	8.0
5825	0.182	16,538.5	16,474.4	7.8
U-NII-3, 802.11n, 20 MHz Channel				
5745	0.182	16,538.5	16,474.4	7.2
5785	0.189	16,538.5	16,474.4	7.5
5825	0.182	16,538.5	16,474.4	8.0
U-NII-3, 802.11n40, 40 MHz Channel				
5755	0.199	36,217.9	35,576.9	4.0
5795	0.187	36,217.9	35,737.2	4.7
U-NII-3, 802.11ac, 80 MHz Channel				
5775	0.110	77,884.6	75,641.0	2.7

Table 25 U-NII-3, EIRP Output Power, OBW, and PSD (Chain 1)

Frequency MHz	EIRP Output Power (Watts)	99% Occupied Bandwidth (kHz)	6-dB Occupied Bandwidth (kHz)	Peak Power Spectral Density (dBm/500kHz)
U-NII-3, 802.11a, 20 MHz Channel				
5745	0.151	16,474.4	16,410.3	7.5
5785	0.143	16,410.3	16,474.4	7.9
5825	0.160	16,410.3	16,474.4	8.6
U-NII-3, 802.11n, 20 MHz Channel				
5745	0.168	16,474.4	16,474.4	7.5
5785	0.159	16,474.4	16,474.4	8.0
5825	0.163	16,474.4	16,474.4	8.6
U-NII-3, 802.11n40, 40 MHz Channel				
5755	0.142	36,057.7	35,576.9	3.4
5795	0.149	36,217.9	35,576.9	3.8
U-NII-3, 802.11ac, 80 MHz Channel				
5775	0.091	77,884.6	75,641.0	1.3

Table 26 FCC U-NII-1, EIRP Output Power and PSD (All Chains)

Frequency MHz	Total Sum EIRP Output Power (Watts)	Total Peak Power Spectral Density (dBm/MHz)
U-NII-1, 802.11a, 20 MHz Channel		
5180	0.317	11.8
5200	0.330	13.2
5240	0.301	12.7
U-NII-1, 802.11n, 20 MHz Channel		
5180	0.309	12.0
5200	0.297	13.0
5240	0.311	12.9
U-NII-1, 802.11n40, 40 MHz Channel		
5190	0.304	9.5
5230	0.304	10.1
U-NII-1, 802.11ac, 80 MHz Channel		
5210	0.213	5.8

Table 27 ISED U-NII-1, EIRP Output Power and PSD (All Chains)

Frequency MHz	Total Sum EIRP Output Power (Watts)	Total Peak Power Spectral Density (dBm/MHz)
U-NII-1, 802.11a, 20 MHz Channel		
5180	0.183	6.8
5200	0.190	9.2
5240	0.173	9.4
U-NII-1, 802.11n, 20 MHz Channel		
5180	0.186	9.0
5200	0.179	9.8
5240	0.187	9.9
U-NII-1, 802.11n40, 40 MHz Channel		
5190	0.183	7.5
5230	0.183	8.1
U-NII-1, 802.11ac, 80 MHz Channel		
5210	0.155	3.0

Table 28 U-NII-3, EIRP Output Power and PSD (All Chains)

Frequency MHz	Total Sum EIRP Output Power (Watts)	Total Peak Power Spectral Density (dBm/500kHz)
U-NII-3, 802.11a, 20 MHz Channel		
5745	0.333	10.4
5785	0.310	10.9
5825	0.342	11.2
U-NII-3, 802.11n, 20 MHz Channel		
5745	0.350	10.3
5785	0.348	10.7
5825	0.345	11.3
U-NII-3, 802.11n40, 40 MHz Channel		
5755	0.341	6.7
5795	0.336	7.3
U-NII-3, 802.11ac, 80 MHz Channel		
5775	0.201	5.1

Summary of Results for Transmitter Radiated Emissions of Intentional Radiator

The EUT demonstrated compliance with the radiated emissions requirements of 47CFR Part 15.407 and Industry Canada RSS-247 Issue 2. The maximum measured average power delivered to all antennas for FCC operation was 0.330-Watts in the U-NII-1 band and 0.350-Watts in the U-NII-3. The maximum measured average power delivered to all antennas for ISED operation was 0.190-Watts in the U-NII-1 band and 0.350-Watts in the U-NII-3. The minimum radiated harmonic emission provided -12.6 dB margin below requirements. The minimum Power Spectral Density provided -3.8 dB margin below requirements. There were no other significantly measurable emissions in the restricted bands other than those presented in this report. Other emissions were present with amplitudes at least 20 dB below the requirements. There were no other deviations or exceptions to the requirements.

Annex

- Annex A Measurement Uncertainty Calculations
- Annex B Test Equipment
- Annex C Rogers Qualifications
- Annex D Laboratory Certificate of Accreditation

Annex A Measurement Uncertainty Calculations

The measurement uncertainty was calculated for all measurements listed in this test report according to CISPR 16-4. Result of measurement uncertainty calculations are recorded below. Component and process variability of production devices similar to those tested may result in additional deviations. The manufacturer has the sole responsibility of continued compliance.

Measurement	Expanded Measurement Uncertainty $U_{(lab)}$
3 Meter Horizontal 0.009-1000 MHz Measurements	4.16
3 Meter Vertical 0.009-1000 MHz Measurements	4.33
3 Meter Measurements 1-18 GHz	5.14
3 Meter Measurements 18-40 GHz	5.16
10 Meter Horizontal Measurements 0.009-1000 MHz	4.15
10 Meter Vertical Measurements 0.009-1000 MHz	4.32
AC Line Conducted	1.75
Antenna Port Conducted power	1.17
Frequency Stability	1.00E-11
Temperature	1.6°C
Humidity	3%

Annex B Test Equipment

Equipment	Manufacturer	Model (SN)	Band	Cal Date(m/d/y)	Due
<input checked="" type="checkbox"/> LISN	FCC	FCC-LISN-50-25-10(1PA) (160611)	.15-30MHz	4/18/2019	4/18/2020
<input checked="" type="checkbox"/> LISN	Compliance Design	FCC-LISN-2.Mod.cd,(126)	.15-30MHz	10/14/2019	10/14/2020
<input checked="" type="checkbox"/> Cable	Huber & Suhner Inc.	Sucoflex102ea(L10M)(303073)	9kHz-40 GHz	10/14/2019	10/14/2020
<input checked="" type="checkbox"/> Cable	Huber & Suhner Inc.	Sucoflex102ea(1.5M)(303069)	9kHz-40 GHz	10/14/2019	10/14/2020
<input checked="" type="checkbox"/> Cable	Huber & Suhner Inc.	Sucoflex102ea(1.5M)(303071)	9kHz-40 GHz	10/14/2019	10/14/2020
<input checked="" type="checkbox"/> Cable	Belden	RG-58 (L1-CAT3-11509)	9kHz-30 MHz	10/14/2019	10/14/2020
<input checked="" type="checkbox"/> Cable	Belden	RG-58 (L2-CAT3-11509)	9kHz-30 MHz	10/14/2019	10/14/2020
<input checked="" type="checkbox"/> Antenna	Com Power	AL-130 (121055)	.001-30 MHz	10/14/2019	10/14/2020
<input type="checkbox"/> Antenna:	EMCO	6509	.001-30 MHz	10/16/2018	10/16/2020
<input type="checkbox"/> Antenna	ARA	BCD-235-B (169)	20-350MHz	10/14/2019	10/14/2020
<input type="checkbox"/> Antenna:	Schwarzbeck Model:	BBA 9106/VHBB 9124 (9124-627)		4/18/2019	4/18/2021
<input checked="" type="checkbox"/> Antenna	Sunol	JB-6 (A100709)	30-1000 MHz	10/14/2019	10/14/2020
<input type="checkbox"/> Antenna	ETS-Lindgren	3147 (40582)	200-1000MHz	10/14/2019	10/14/2020
<input type="checkbox"/> Antenna:	Schwarzbeck Model:	VULP 9118 A (VULP 9118 A-534)		4/18/2019	4/18/2021
<input checked="" type="checkbox"/> Antenna	ETS-Lindgren	3117 (200389)	1-18 GHz	5/02/2019	5/2/2020
<input type="checkbox"/> Antenna	Com Power	AH-118 (10110)	1-18 GHz	10/14/2018	10/14/2020
<input checked="" type="checkbox"/> Antenna	Com Power	AH-840 (101046)	18-40 GHz	4/18/2019	4/18/2021
<input checked="" type="checkbox"/> Analyzer	Rohde & Schwarz	ESU40 (100108)	20Hz-40GHz	4/18/2019	4/18/2020
<input checked="" type="checkbox"/> Analyzer	Rohde & Schwarz	ESW44 (101534)	20Hz-44GHz	1/31/2019	1/31/2020
<input type="checkbox"/> Analyzer	Rohde & Schwarz	FS-Z60, 90, 140, and 220	40GHz-220GHz	12/22/2017	12/22/2027
<input checked="" type="checkbox"/> Amplifier	Com-Power	PA-010 (171003)	100Hz-30MHz	10/14/2019	10/14/2020
<input checked="" type="checkbox"/> Amplifier	Com-Power	CPPA-102 (01254)	1-1000 MHz	10/14/2019	10/14/2020
<input checked="" type="checkbox"/> Amplifier	Com-Power	PAM-118A (551014)	0.5-18 GHz	10/14/2019	10/14/2020
<input checked="" type="checkbox"/> Amplifier	Com-Power	PAM-840A (461328)	18-40 GHz	10/14/2019	10/14/2020
<input checked="" type="checkbox"/> Power Meter	Agilent	N1911A with N1921A	0.05-40 GHz	4/18/2019	4/18/2020
<input type="checkbox"/> Generator	Rohde & Schwarz	SMB100A6 (100150)	20Hz-6 GHz	4/18/2019	4/18/2020
<input type="checkbox"/> Generator	Rohde & Schwarz	SMBV100A6 (260771)	20Hz-6 GHz	4/18/2019	4/18/2020
<input type="checkbox"/> RF Filter	Micro-Tronics	BRC50722 (009).9G notch	30-18000 MHz	4/18/2019	4/18/2020
<input type="checkbox"/> RF Filter	Micro-Tronics	HPM50114 (017)1.5G HPF	30-18000 MHz	4/18/2019	4/18/2020
<input type="checkbox"/> RF Filter	Micro-Tronics	HPM50117 (063) 3G HPF	30-18000 MHz	4/18/2019	4/18/2020
<input type="checkbox"/> RF Filter	Micro-Tronics	HPM50105 (059) 6G HPF	30-18000 MHz	4/18/2019	4/18/2020
<input type="checkbox"/> RF Filter	Micro-Tronics	BRM50702 (172) 2G notch	30-18000 MHz	4/18/2019	4/18/2020
<input checked="" type="checkbox"/> RF Filter	Micro-Tronics	BRC50703 (G102) 5G notch	30-18000 MHz	4/18/2019	4/18/2020
<input type="checkbox"/> RF Filter	Micro-Tronics	BRC50705 (024) 5G notch	30-18000 MHz	4/18/2019	4/18/2020
<input type="checkbox"/> Attenuator	Fairview	SA6NFNF100W-40 (1625)	30-18000 MHz	4/18/2019	4/18/2020
<input checked="" type="checkbox"/> Attenuator	Mini-Circuits	VAT-3W2+ (1436)	30-6000 MHz	4/18/2019	4/18/2020
<input checked="" type="checkbox"/> Attenuator	Mini-Circuits	VAT-3W2+ (1445)	30-6000 MHz	4/18/2019	4/18/2020
<input type="checkbox"/> Attenuator	Mini-Circuits	VAT-3W2+ (1735)	30-6000 MHz	4/18/2019	4/18/2020
<input type="checkbox"/> Attenuator	Mini-Circuits	VAT-6W2+ (1438)	30-6000 MHz	4/18/2019	4/18/2020
<input type="checkbox"/> Attenuator	Mini-Circuits	VAT-6W2+ (1736)	30-6000 MHz	4/18/2019	4/18/2020
<input checked="" type="checkbox"/> Weather station	Davis	6312 (A81120N075)		10/26/2018	10/26/2019

List of Test Equipment	Calibration	Date (m/d/y)	Due
<input type="checkbox"/> Frequency Counter: Leader LDC-825 (8060153)		4/18/2019	4/18/2021
<input type="checkbox"/> LISN: Fischer Custom Communications Model: FCC-LISN-50-16-2-08		4/18/2019	4/18/2020
<input type="checkbox"/> Cable Huber & Suhner Inc. Sucoflex102ea(1.5M)(303070) 9kHz-40 GHz		10/14/2019	10/14/2020
<input type="checkbox"/> Cable Huber & Suhner Inc. Sucoflex102ea(1.5M)(303072) 9kHz-40 GHz		10/14/2019	10/14/2020
<input type="checkbox"/> Cable Huber & Suhner Inc. Sucoflex102ea(L4M)(281184) 9kHz-40 GHz		10/14/2019	10/14/2020
<input type="checkbox"/> Cable Huber & Suhner Inc. Sucoflex102ea(L10M)(317546)9kHz-40 GHz		10/14/2019	10/14/2020
<input type="checkbox"/> Cable Time Microwave 4M-750HF290-750 (4M) 9kHz-24 GHz		10/14/2019	10/14/2020
<input type="checkbox"/> RF Filter Micro-Tronics BRC17663 (001) 9.3-9.5 notch 30-1800 MHz		4/18/2019	4/18/2020
<input type="checkbox"/> RF Filter Micro-Tronics BRC19565 (001) 9.2-9.6 notch 30-1800 MHz		10/16/2018	4/18/2020
<input type="checkbox"/> Attenuator Mini-Circuits VAT-3W2+ (1735) 30-6000 MHz		4/18/2019	4/18/2020
<input type="checkbox"/> Analyzer HP 8562A (3051A05950) 9kHz-125GHz		4/18/2019	4/18/2020
<input type="checkbox"/> Analyzer HP External Mixers11571, 11970 25GHz-110GHz		4/18/2015	4/18/2025
<input type="checkbox"/> Analyzer HP 8591EM (3628A00871)		5/2/2018	5/2/2020
<input type="checkbox"/> Antenna: Solar 9229-1 & 9230-1		2/22/2019	2/22/2020
<input type="checkbox"/> R.F. Generator: SMB100A6 s/n 100623		4/18/2019	4/18/2020
<input type="checkbox"/> R.F. Generator: SBMBV100A s/n: 260771		4/18/2019	4/18/2020
<input type="checkbox"/> CDN: Com-Power Model CDN325E		10/14/2019	10/14/2020
<input type="checkbox"/> Injection Clamp Luthi Model EM101		10/14/2019	10/14/2020
<input type="checkbox"/> R.F. Power Amp ACS 230-50W		10/14/2019	10/14/2020
<input type="checkbox"/> R.F. Power Amp EIN Model: A301		2/22/2019	2/22/2020
<input type="checkbox"/> R.F. Power Amp A.R. Model: 10W 1010M7		2/22/2019	2/22/2020
<input type="checkbox"/> LISN: Com-Power Model LI-550C		10/14/2019	10/14/2020
<input type="checkbox"/> LISN: Compliance Eng. Model 240/20		4/18/2019	4/18/2020
<input type="checkbox"/> LISN: Fischer Custom Communications Model: FCC-LISN-50-16-2-08		4/18/2019	4/18/2020
<input type="checkbox"/> Oscilloscope Scope: Tektronix MDO 4104		2/22/2019	2/22/2020
<input type="checkbox"/> EMC Transient Generator HVT TR 3000		2/22/2019	2/22/2020
<input type="checkbox"/> AC Power Source (Ametech, California Instruments)		2/22/2019	2/22/2020
<input type="checkbox"/> Field Intensity Meter: EFM-018		2/22/2019	2/22/2020
<input type="checkbox"/> ESD Simulator: MZ-15		2/22/2019	2/22/2020
<input checked="" type="checkbox"/> Shielded Room not required			

Annex C Rogers Qualifications

Scot D. Rogers, Engineer

Rogers Labs, Inc.

Mr. Rogers has approximately 33 years' experience in the field of electronics. Engineering experience includes six years in the automated controls industry and remaining years working with the design, development and testing of radio communications and electronic equipment.

Positions Held

Systems Engineer: A/C Controls Mfg. Co., Inc. 6 Years

Electrical Engineer: Rogers Consulting Labs, Inc. 5 Years

Electrical Engineer: Rogers Labs, Inc. Current

Educational Background

- 1) Bachelor of Science Degree in Electrical Engineering from Kansas State University.
- 2) Bachelor of Science Degree in Business Administration Kansas State University.
- 3) Several Specialized Training courses and seminars pertaining to Microprocessors and Software programming.

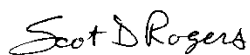

Scot D. Rogers

Annex D Laboratory Certificate of Accreditation

United States Department of Commerce
National Institute of Standards and Technology



Certificate of Accreditation to ISO/IEC 17025:2017

NVLAP LAB CODE: 200087-0

Rogers Labs, Inc.
Louisburg, KS

*is accredited by the National Voluntary Laboratory Accreditation Program for specific services,
listed on the Scope of Accreditation, for:*

Electromagnetic Compatibility & Telecommunications

*This laboratory is accredited in accordance with the recognized International Standard ISO/IEC 17025:2017.
This accreditation demonstrates technical competence for a defined scope and the operation of a laboratory quality
management system (refer to joint ISO-ILAC-IAF Communiqué dated January 2009).*

2019-11-07 through 2020-03-31
Effective Dates

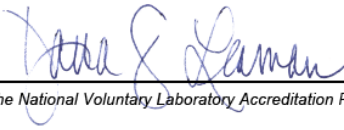

For the National Voluntary Laboratory Accreditation Program