

# Submittal Application Report

FOR  
GRANT OF CERTIFICATION

FOR

Model: RBGrooveA 52HPn  
2412-2462 and 5745-5825 MHz  
Dual Band 802.11b/g/n and 802.11a/n  
Broadband Digital Transmission System  
FCC ID: TV7GRV-A52HPN

FOR

**MIKROTIKLS SIA**

Pernavas 46  
Riga, Latvia LV-1009

Test Report Number: 130318

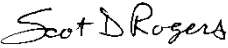
Authorized Signatory:   
Scot D. Rogers

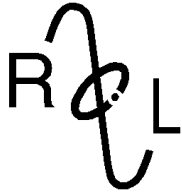

**ROGERS LABS, INC.**

4405 West 259<sup>th</sup> Terrace  
 Louisburg, KS 66053  
 Phone / Fax (913) 837-3214

**Engineering Test Report for  
 Grant of Certification Application**

FOR  
 CFR 47, PART 15C - Intentional Radiators  
 CFR 47 Paragraph 15.247  
 License Exempt Intentional Radiator

For

**MIKROTIKLS SIA**

Pernavas 46  
 Riga, Latvia LV-1009

Dual Band Broadband Digital Transmission System

Model: RBGrooveA 52HPn  
 Frequency Range 2412-2462 and 5745-5825 MHz  
 FCC ID#: TV7GRV-A52HPN

Test Date: March 18, 2013

Certifying Engineer: *Scot D. Rogers*  
 Scot D. Rogers  
 Rogers Labs, Inc.  
 4405 West 259<sup>th</sup> Terrace  
 Louisburg, KS 66053  
 Telephone/Facsimile: (913) 837-3214

This report shall not be reproduced except in full, without the written approval of the laboratory.  
 This report must not be used by the client to claim product certification, approval or endorsement  
 by NVLAP, NIST, or any agency of the Federal Government.



# Table Of Contents

**TABLE OF CONTENTS..... 3**

**REVISIONS..... 5**

**FORWARD ..... 6**

**OPINION / INTERPRETATION OF RESULTS ..... 6**

**EQUIPMENT TESTED..... 6**

**APPLICATION FOR CERTIFICATION..... 7**

**EQUIPMENT FUNCTION AND CONFIGURATION..... 8**

**Equipment Configuration.....8**

**APPLICABLE STANDARDS & TEST PROCEDURES ..... 9**

**EQUIPMENT TESTING PROCEDURES ..... 9**

**AC Line Conducted Emission Test Procedure .....9**

        Diagram 1 Test arrangement for Conducted emissions .....10

**Radiated Emission Test Procedure.....11**

        Diagram 2 Test arrangement for radiated emissions of tabletop equipment.....11

        Diagram 3 Test arrangement for radiated emissions tested on Open Area Test Site (OATS).....12

**TEST SITE LOCATIONS ..... 13**

**UNITS OF MEASUREMENTS ..... 13**

**ENVIRONMENTAL CONDITIONS..... 13**

**LIST OF TEST EQUIPMENT ..... 14**

**INTENTIONAL RADIATORS..... 15**

**Antenna Requirements .....15**

**Restricted Bands of Operation.....15**

        Table 1 General Radiated Emissions in Restricted Bands Data .....16



Table 2 Harmonic Radiated Emissions in Restricted Bands Data (ODH 24-13).....17

Table 3 Harmonic Radiated Emissions in Restricted Bands Data (WLO-2450-15).....18

Table 4 Harmonic Radiated Emissions in Restricted Bands Data (SA 24-90-17-WB) .....19

Table 5 Harmonic Radiated Emissions in Restricted Bands Data (WLP-2450-20).....20

Table 6 Harmonic Radiated Emissions in Restricted Bands Data (24-HD-PFIP) .....21

Table 7 Harmonic Radiated Emissions in Restricted Bands Data (MT-482016/N/A) .....21

Table 8 Harmonic Radiated Emissions in Restricted Bands Data (PA58-24-ANT).....22

Table 9 Harmonic Radiated Emissions in Restricted Bands Data (HDDA5W-32-DP2).....22

**Summary of Results for Radiated Emissions in Restricted Bands .....22**

**AC Line Conducted Emissions Procedure .....23**

Figure 1 AC Line Conducted Emissions Line 1 .....24

Figure 2 AC Line Conducted Emissions Line 2 .....24

Table 10 AC Line Conducted Emissions Data (Highest Emissions Line L1) .....25

Table 11 AC Line Conducted Emissions Data (Highest Emissions Line L2) .....25

**Summary of Results for AC Line Conducted Emissions .....25**

**General Radiated Emissions Procedure.....26**

Table 12 General Radiated Emissions from EUT Data (Highest Emissions) .....27

**Summary of Results for General Radiated Emissions .....28**

**Operation in the Band 2400 – 2483.5 and 5725-5850 MHz.....28**

Figure 3 Plot of Transmitter Emissions (Across Operational Band, 2.4 GHz b/g/n).....29

Figure 4 Plot of Low Band Edge (2.4 GHz b/g/n Mode).....29

Figure 5 Plot of High Band Edge (2.4 GHz b/g/n Mode) .....30

Figure 6 Plot of Transmitter Emissions (Across Operational Band, 5 GHz a/n) .....30

Figure 7 Plot of Low Band Edge (5 GHz a/n) .....31

Figure 8 Plot of High Band Edge (5 GHz a/n).....31

**Transmitter Emissions Data.....32**

Table 13 Transmitter Antenna Conducted Emissions Data .....32

Table 14 Transmitter Radiated Emission (ODH 24-13) .....33

Table 15 Transmitter Radiated Emission (WLO-2450-15) .....34

Table 16 Transmitter Radiated Emission (SA 24-90-17-WB).....35

Table 17 Transmitter Radiated Emission (WLP-2450-20) .....36



Table 18 Transmitter Radiated Emission (24-HD-PFIP).....37

Table 19 Transmitter Radiated Emission (MT-482016/N/A) .....38

Table 20 Transmitter Radiated Emission (PA58-24-ANT) .....39

Table 21 Transmitter Radiated Emission (HDDA5W-32-DP2) .....40

Summary of Results for Transmitter Radiated Emissions of Intentional Radiator .....41

**STATEMENT OF MODIFICATIONS AND DEVIATIONS ..... 41**

**ANNEX..... 42**

**Annex A Measurement Uncertainty Calculations.....43**

**Annex B Rogers Labs Test Equipment List.....44**

**Annex C Rogers Qualifications .....45**

**Annex D FCC Site Registration Letter .....46**

**Annex E Industry Canada Site Registration Letter .....47**

## Revisions

Revision 1 Issued September 4, 2013

Revision 2 Issued September 9, 2013 – added OBW information to Table 13



## Forward

The following information is submitted for consideration in obtaining Grant of Certification for License Exempt Digital Transmission System Intentional Radiator operating under CFR 47 Paragraph 15.247.

Name of Applicant: Mikrotiks SIA  
 Pernavas 46  
 Riga, Latvia LV-1009

Model: RBGrooveA 52HPn FCC ID: TV7GRV-A52HPN FRN: 0014 43 1100

Frequency Range: 2412-2462, and 5745-5825 MHz (802.11a/b/g mode operation), 2422-2452 MHz, 5755-5815 MHz (802.11n 40 MHz channel operation)

Total Operating Power: 0.53 watts (2412-2462 MHz), 0.52 watts (5745-5825 MHz)

## Opinion / Interpretation of Results

Tests Performed	Margin (dB)	Results
Emissions as per CFR 47 paragraphs 2 and 15.205	-2.5	Complies
Emissions as per CFR 47 paragraphs 2 and 15.207	-13.0	Complies
Emissions as per CFR 47 paragraphs 2 and 15.209	-2.2	Complies
Harmonic Emissions per CFR 47 15.247	-2.6	Complies
Peak Power Spectral Density per CFR 47 15.247	-3.6	Complies

## Equipment Tested

<u>Equipment</u>	<u>Model</u>	<u>FCC I.D.</u>
EUT	RBGrooveA 52HPn	TV7GRV-A52HPN
AC Adapter	FLD181-240075-U	14655
Dell Studio XPS	921LBN1	N/A

<u>Antenna/Type</u>	<u>Model</u>	<u>Gain</u>
Omni Directional (2.4 GHz)	WLO-2450-15	15 dBi
Omni Directional HP (2.4 GHz)	ODH 24-13	13 dBi
Panel (2.4 GHz)	WLP-2450-20	20 dBi
Sector (2.4 GHz)	SA 24-90-17-WB	17 dBi
Dish (2.4 GHz)	DC 24-HD-PFIP	24 dBi
Omni Directional (5 GHz)	MT-482016/N/A	8.5 dBi
Panel Antenna (5 GHz)	PA58-24-ANT	24 dBi
Dish Antenna (5 GHz)	HDDA5W-32-DP2	32 dBi

## Application for Certification

- (1) Manufacturer: Mikrotikls SIA  
Pernavas 46  
Riga, Latvia LV-1009
- (2) Identification: Model: RBGrooveA 52HPn  
  
FCC I.D.: TV7GRV-A52HPN
- (3) Instruction Book:  
  
Refer to Exhibit for Instruction Manual.
- (4) Description of Circuit Functions:  
  
Refer to Exhibit of Operational Description.
- (5) Block Diagram with Frequencies:  
  
Refer to Exhibit of Operational Description.
- (6) Report of Measurements:  
  
Report of measurements follows in this Report.
- (7) Photographs: Construction, Component Placement, etc.:  
  
Refer to Exhibit for photographs of equipment.
- (8) List of Peripheral Equipment Necessary for operation. The equipment requires direct current power received over the Power Over Ethernet (POE) connection from authorized AC/DC power adapter. The EUT offers single Ethernet network connection port and n-connector for antenna connection. During testing, the EUT was connected to power and laptop computer through network cable. The EUT received power supplied from external AC/DC supply.
- (9) Transition Provisions of CFR47 15.37 are not requested.
- (10) Not Applicable. The unit is not a scanning receiver.
- (11) Not Applicable. The EUT does not operate in the 59 – 64 GHz frequency band.
- (12) The equipment is not software defined and this section is not applicable.

## Equipment Function and Configuration

The EUT is a 2412-2462, and 5745-5825 MHz Dual Band Digital Transmission System used to transmit data in applications offering broadband wireless connectivity. The design utilizes n-connector for use with authorized antenna systems and requires professional installation. The design requires power supplied from AC/DC adapter and POE. The equipment is marketed for use to incorporate a wireless link to exchange data information from one point to another. For testing purposes, the RBGrooveA 52HPn transceiver was connected to the manufacturer supplied POE and AC/DC supply and communicating to the laptop computer through Ethernet network interface. Installation software was used to configure and control the transmitter during testing. The software provides reduction of transmitter output power levels as required to accommodate antennas with gains exceeding 6 dBi where required. This configuration offered operational control of the transmitter and communications over the network interface between the EUT and supporting computer system. No other interfacing options are provided.

### Equipment Configuration

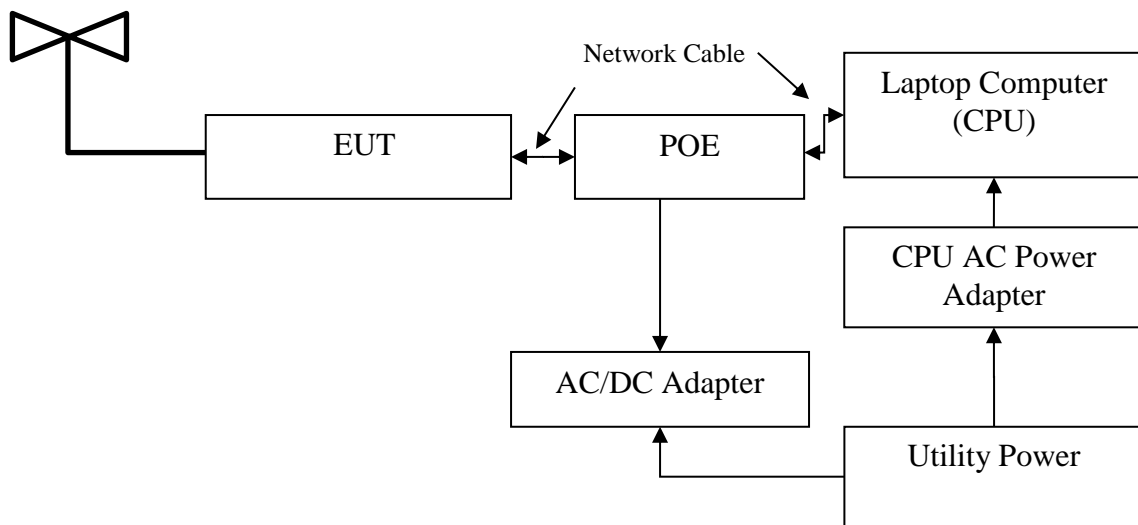



## Applicable Standards & Test Procedures

In accordance with the Federal Communications Code of Federal Regulations, dated October 1, 2012, Part 2, Subpart J, Paragraphs 2.907, 2.911, 2.913, 2.925, 2.926, 2.1031 through 2.1057, and applicable parts of paragraph 15, Part 15C Paragraph 15.247 the following information is submitted. Test procedures used are the established Methods of Measurement of Radio-Noise Emissions as described in ANSI C63.4-2009, ANSI C63.10-2009, FCC KDB documents KDB 558074 D01 v03r1 and KDB 913591. Testing for the AC line-conducted emissions were performed as defined in sections 7 and 13.1.3, testing of the radiated emissions was performed as defined in sections 8 and 13.1.4 of ANSI C63.4-2009. Testing of the radiated emissions was performed as required including procedures in section 13 of ANSI C63.4-2009.

## Equipment Testing Procedures

### *AC Line Conducted Emission Test Procedure*

For testing purposes, the manufacturer supplied AC/DC power adapter was used to power the EUT. Testing for the AC line-conducted emissions testing was performed as defined in sections 7 and 13.1.3 of ANSI C63.4-2009. The test setup including the EUT was arranged in typical equipment configurations and placed on a 1 x 1.5-meter wooden bench, 0.8 meters high located in a screen room. The power lines of the system were isolated from the power source using a standard LISN with a 50- $\mu$ Hy choke. EMI was coupled to the spectrum analyzer through a 0.1  $\mu$ F capacitor internal to the LISN. The LISN was positioned on the floor beneath the wooden bench supporting the EUT. The power lines and cables were draped over the back edge of the table. Refer to diagram 1 showing typical test arrangement and photographs in the test setup exhibits for specific EUT placement during testing. Refer to photographs in the test setup exhibits for EUT placement during testing.

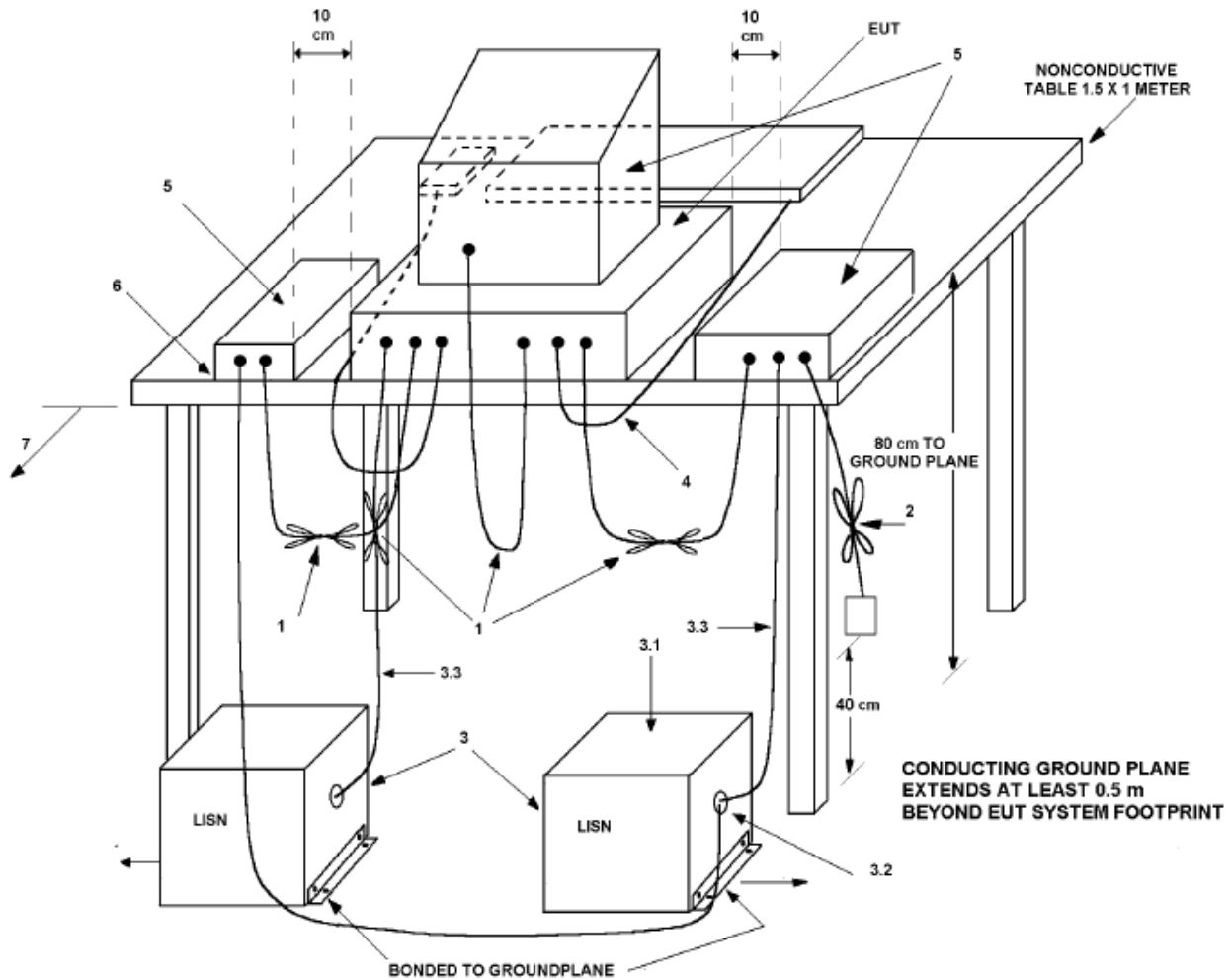
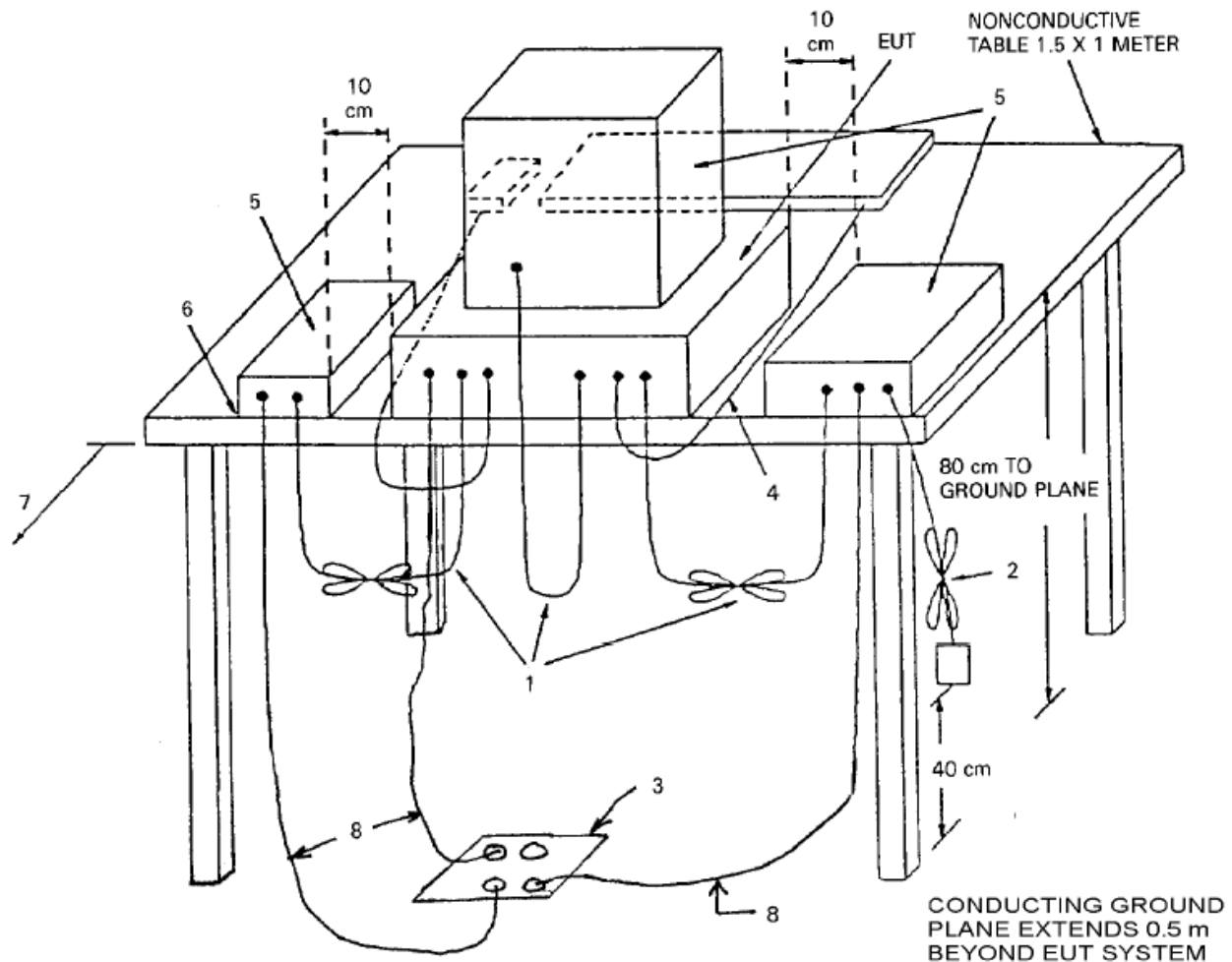

**Diagram 1 Test arrangement for Conducted emissions**

1. Interconnecting cables that hang closer than 40 cm to the ground plane were folded back and forth in the center forming a bundle 30 cm to 40 cm long.
2. Input/output (I/O) cables that are not connected to a peripheral shall be bundled in the center. The end of the cable may be terminated, if required, using the correct terminating impedance. The overall length shall not exceed 1 m.
3. EUT connected to one LISN. Unused LISN measuring port connectors are terminated into 50  $\Omega$  loads. LISN is placed on top of and bonded to reference ground plane.
  - 3.1 All other equipment powered from additional LISN(s).
  - 3.2 Multiple outlet strips can be used for multiple power cords of non-EUT equipment.
  - 3.3 LISN is positioned at least 80 cm from nearest part of EUT chassis.
4. Cables of hand-operated devices, such as keyboards, mice, and so on, shall be placed as for normal use.
5. Non-EUT components of EUT system being tested.
6. Rear of EUT, including peripherals, shall all be aligned and flush with rear of tabletop.
7. Rear of tabletop shall be 40 cm removed from a vertical conducting plane that is bonded to the ground plane (see 5.2.2 for options).

### Radiated Emission Test Procedure

The EUT was placed on a rotating 1 x 1.5-meter wooden platform, 0.8 meters above the ground plane at a distance of 3 meters from the FSM antenna. Radiated emissions testing was performed as required in CFR47 15, RSS-210 and specified in sections 8 and 13.1.4 of ANSI C63.4-2009. EMI energy was maximized by equipment placement, raising and lowering the FSM antenna, changing the antenna polarization, and by rotating the turntable. Each emission was maximized before data was taken using a spectrum analyzer. The frequency spectrum from 9 kHz to 25,000 MHz was searched for during preliminary investigation. Refer to diagrams 2 and 3 showing typical test arrangement and photographs in the test setup exhibits for specific EUT placement during testing.



**Diagram 2 Test arrangement for radiated emissions of tabletop equipment**

1. Interconnecting cables that hang closer than 40 cm to the ground plane shall be folded back and forth in the center, forming a bundle 30 cm to 40 cm long.

2. I/O cables that are not connected to a peripheral shall be bundled in the center. The end of the cable may be terminated if required using the correct terminating impedance. The total length shall not exceed 1 m.
3. If LISNs are kept in the test setup for radiated emissions, it is preferred that they be installed under the ground plane with the receptacle flush with the ground plane.
4. Cables of hand-operated devices, such as keyboards, mice, and so on, shall be placed as for normal use.
5. Non-EUT components of EUT system being tested.
6. Rear of EUT, including peripherals, shall all be aligned and flush with rear of tabletop (possibly center of table for transmitter equipment).
7. No vertical conducting plane used.
8. Power cords drape to the floor and are routed over to receptacle.

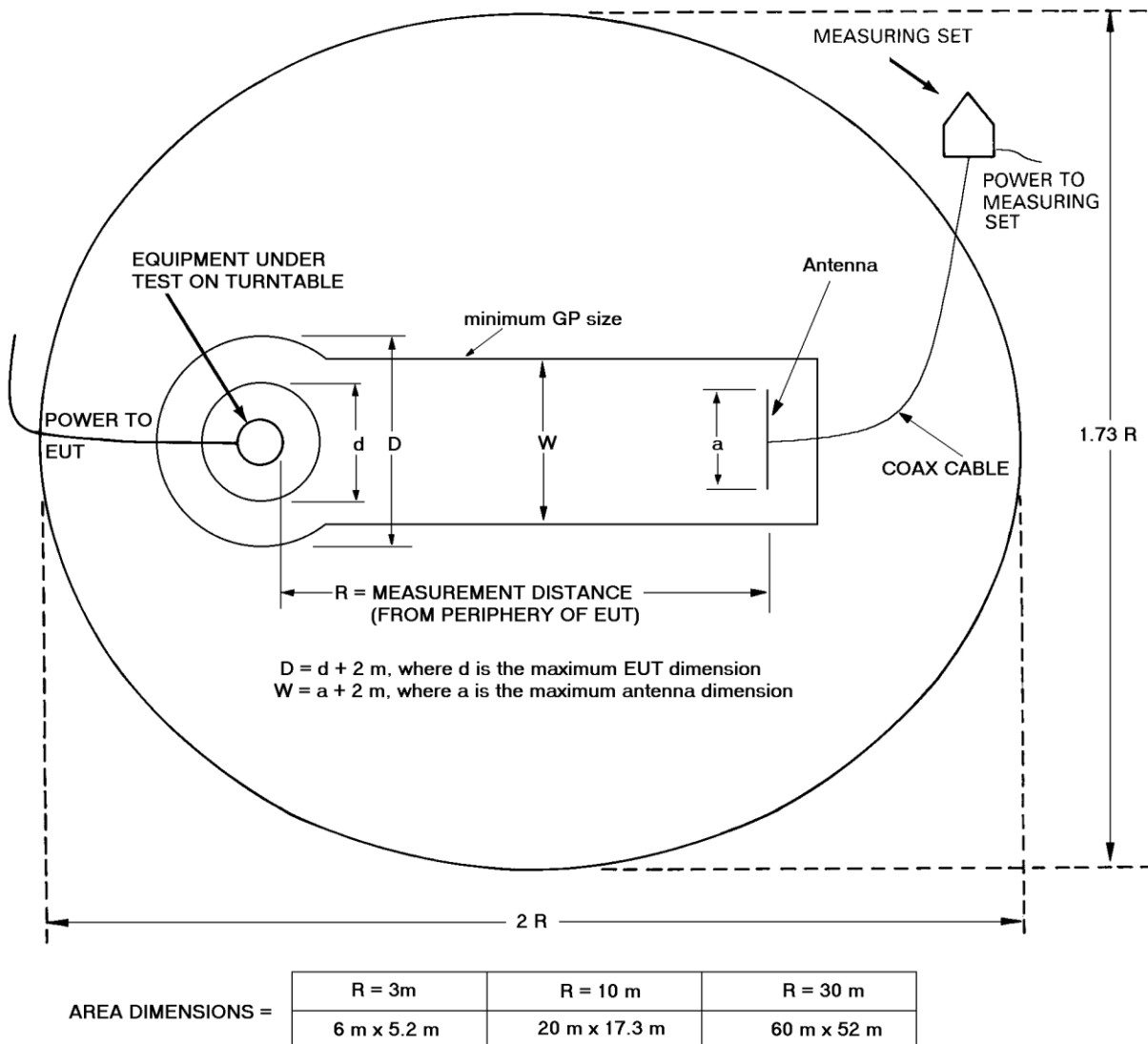

**Diagram 3 Test arrangement for radiated emissions tested on Open Area Test Site (OATS)**



## Test Site Locations

Conducted EMI      The AC power line conducted emissions testing performed in a shielded screen room located at Rogers Labs, Inc., 4405 W. 259<sup>th</sup> Terrace, Louisburg, KS

Radiated EMI      The radiated emissions tests were performed at the 3 meters, Open Area Test Site (OATS) located at Rogers Labs, Inc., 4405 W. 259<sup>th</sup> Terrace, Louisburg, KS

Site Registration      Refer to Annex for Site Registration Letters

NVLAP Accreditation      Lab code 200087-0

## Units of Measurements

Conducted EMI      Data is in dB $\mu$ V; dB referenced to one microvolt

Radiated EMI      Data is in dB $\mu$ V/m; dB/m referenced to one microvolt per meter

Sample Calculation:

RFS = Radiated Field Strength, FSM = Field Strength Measured

A.F. = Receive antenna factor, Gain = amplification gains and/or cable losses

$RFS (dB\mu V/m @ 3m) = FSM (dB\mu V) + A.F. (dB) - Gain (dB)$

## Environmental Conditions

Ambient Temperature      21.6° C

Relative Humidity      26%

Atmospheric Pressure      1024.0 mb

## List of Test Equipment

A Rohde and Schwarz ESU40 and/or Hewlett Packard 8591EM was used as the measuring device for the emissions testing of frequencies below 1 GHz. A Rohde and Schwarz ESU40 and/or Hewlett Packard 8562A Spectrum Analyzer was used as the measuring device for testing the emissions at frequencies above 1 GHz. The analyzer settings used are described in the following table. Refer to the appendix for a complete list of test equipment.

AC Line Conducted Emissions (0.150 -30 MHz)		
RBW	AVG. BW	Detector Function
9 kHz	30 kHz	Peak / Quasi Peak
Emissions (30-1000 MHz)		
RBW	AVG. BW	Detector Function
120 kHz	300 kHz	Peak / Quasi Peak
Emissions (Above 1000 MHz)		
RBW	Video BW	Detector Function
100 kHz	100 kHz	Peak
1 MHz	1 MHz	Peak / Average

<u>Equipment</u>	<u>Manufacturer</u>	<u>Model</u>	<u>Band</u>	<u>Cal Date</u>	<u>Due</u>
<input checked="" type="checkbox"/> LISN	Comp. Design	FCC-LISN-2-MOD.CD	.15-30MHz	10/12	10/13
<input type="checkbox"/> Antenna	ARA	BCD-235-B	20-350MHz	10/12	10/13
<input type="checkbox"/> Antenna	EMCO	3147	200-1000MHz	10/12	10/13
<input checked="" type="checkbox"/> Antenna	Com Power	AH-118	1-18 GHz	10/12	10/13
<input checked="" type="checkbox"/> Antenna	Com Power	AH-840	18-40 GHz	10/12	10/13
<input checked="" type="checkbox"/> Antenna	EMCO	6509	.001-30 MHz	10/12	10/13
<input checked="" type="checkbox"/> Antenna	Sunol	JB-6	30-1000 MHz	10/12	10/13
<input checked="" type="checkbox"/> Antenna	Standard	FXRY638A	10-18 GHz	3/12	5/13
<input type="checkbox"/> Antenna	EMCO	3143	20-1200 MHz	5/12	5/13
<input type="checkbox"/> Analyzer	HP	8591EM	9kHz-1.8GHz	5/12	5/13
<input type="checkbox"/> Analyzer	HP	8562A	9kHz-110GHz	5/12	5/13
<input checked="" type="checkbox"/> Analyzer	Rohde & Schwarz	ESU40	20Hz-40GHz	5/12	5/13
<input checked="" type="checkbox"/> Amplifier	Com-Power	PA-010	100Hz-30MHz	10/12	10/13
<input checked="" type="checkbox"/> Amplifier	Com-Power	CPPA-102	1-1000 MHz	10/12	10/13
<input checked="" type="checkbox"/> Amplifier	Com-Power	PA-122	0.5-22 GHz	10/12	10/13



## **Intentional Radiators**

As per CFR47, Subpart C, paragraph 15.247 the following information is submitted.

### ***Antenna Requirements***

The EUT is produced with N-connector for connection to authorized external antenna systems. The design is marketed for professional installation and use as described in accompanying documentation. The antenna connection point complies with the unique antenna connection requirements. The requirements of unique antenna connection are fulfilled; there are no deviations or exceptions to the specification.

### ***Restricted Bands of Operation***

Spurious emissions falling in the restricted frequency bands of operation were measured at the OATS. The EUT utilizes frequency, determining circuitry, which generates harmonics falling in the restricted bands. Emissions were investigated at the OATS, using appropriate antennas or pyramidal horns, amplification stages, and a spectrum analyzer. Peak and average amplitudes of frequencies above 1000 MHz were compared to the required limits with worst-case data presented below. Test procedures of ANSI C63.4-2009 paragraphs 13.1 and 8.3.1.2 and KDB 558074 paragraph 10.2 were used during testing. No other significant emission was observed which fell into the restricted bands of operation. Computed emission values take into account the received radiated field strength, receive antenna correction factor, amplifier gain stage, and test system cable losses.

**Table 1 General Radiated Emissions in Restricted Bands Data**

Frequency in MHz	Horizontal Peak (dBµV/m)	Horizontal Quasi-Peak (dBµV/m)	Horizontal Average (dBµV/m)	Vertical Peak (dBµV/m)	Vertical Quasi-Peak (dBµV/m)	Vertical Average (dBµV/m)	Limit @ 3m (dBµV/m)
125.0	39.8	38.3	N/A	40.0	38.0	N/A	43.5
132.3	26.9	21.3	N/A	27.6	22.6	N/A	43.5
132.9	29.9	23.0	N/A	31.8	27.7	N/A	43.5
134.4	32.7	27.9	N/A	36.3	33.5	N/A	43.5
135.8	32.6	29.1	N/A	35.9	32.6	N/A	43.5
136.9	42.3	38.3	N/A	36.4	32.1	N/A	43.5
137.2	33.5	30.2	N/A	35.4	32.2	N/A	43.5
400.0	43.0	40.6	N/A	38.6	35.4	N/A	46.0

Other emissions present had amplitudes at least 20 dB below the limit. Peak and Quasi-Peak amplitude emissions are recorded above for frequency range below 1000 MHz. Peak and Average amplitude emissions are recorded above for frequency range above 1000 MHz.



**Table 2 Harmonic Radiated Emissions in Restricted Bands Data (ODH 24-13)**

Frequency in MHz	Horizontal Peak (dBµV/m)	Horizontal Quasi-Peak (dBµV/m)	Horizontal Average (dBµV/m)	Vertical Peak (dBµV/m)	Vertical Quasi-Peak (dBµV/m)	Vertical Average (dBµV/m)	Limit @ 3m (dBµV/m)
2390.0	67.5	N/A	49.6	43.2	N/A	30.6	54.0
2483.5	62.6	N/A	49.4	43.4	N/A	31.5	54.0
4824.0	55.3	N/A	47.5	47.9	N/A	34.6	54.0
4874.0	49.0	N/A	39.4	47.2	N/A	34.5	54.0
4924.0	54.0	N/A	16.6	16.1	N/A	33.7	54.0
7236.0	48.9	N/A	36.3	50.2	N/A	37.1	54.0
7311.0	51.3	N/A	39.3	49.3	N/A	36.7	54.0
7386.0	54.0	N/A	16.6	16.1	N/A	33.8	54.0
12060.0	49.0	N/A	36.2	48.5	N/A	36.0	54.0
12185.0	48.3	N/A	36.1	49.4	N/A	36.5	54.0
12310.0	47.6	N/A	35.2	47.6	N/A	34.7	54.0
14472.0	51.3	N/A	38.5	50.5	N/A	38.4	54.0

Other emissions present had amplitudes at least 20 dB below the limit. Peak and Quasi-Peak amplitude emissions are recorded above for frequency range below 1000 MHz. Peak and Average amplitude emissions are recorded above for frequency range above 1000 MHz.



**Table 3 Harmonic Radiated Emissions in Restricted Bands Data (WLO-2450-15)**

Frequency in MHz	Horizontal Peak (dBµV/m)	Horizontal Quasi-Peak (dBµV/m)	Horizontal Average (dBµV/m)	Vertical Peak (dBµV/m)	Vertical Quasi-Peak (dBµV/m)	Vertical Average (dBµV/m)	Limit @ 3m (dBµV/m)
2390.0	42.3	N/A	29.5	62.0	N/A	47.9	54.0
2483.5	49.5	N/A	32.5	60.3	N/A	49.7	54.0
4824.0	50.9	N/A	42.5	50.7	N/A	41.8	54.0
4874.0	48.6	N/A	37.4	52.1	N/A	45.7	54.0
4924.0	54.0	N/A	16.6	16.1	N/A	41.1	54.0
7236.0	46.1	N/A	33.3	48.9	N/A	37.3	54.0
7311.0	49.0	N/A	36.3	49.9	N/A	37.3	54.0
7386.0	54.0	N/A	16.6	16.1	N/A	36.9	54.0
12060.0	49.6	N/A	36.2	49.0	N/A	36.1	54.0
12185.0	48.9	N/A	36.0	48.6	N/A	35.7	54.0
12310.0	47.6	N/A	35.2	47.3	N/A	34.7	54.0
14472.0	51.1	N/A	38.1	51.1	N/A	38.2	54.0

Other emissions present had amplitudes at least 20 dB below the limit. Peak and Quasi-Peak amplitude emissions are recorded above for frequency range below 1000 MHz. Peak and Average amplitude emissions are recorded above for frequency range above 1000 MHz.



**Table 4 Harmonic Radiated Emissions in Restricted Bands Data (SA 24-90-17-WB)**

Frequency in MHz	Horizontal Peak (dBµV/m)	Horizontal Quasi-Peak (dBµV/m)	Horizontal Average (dBµV/m)	Vertical Peak (dBµV/m)	Vertical Quasi-Peak (dBµV/m)	Vertical Average (dBµV/m)	Limit @ 3m (dBµV/m)
2390.0	48.0	N/A	33.3	56.6	N/A	49.8	54.0
2483.5	50.9	N/A	37.3	67.1	N/A	50.8	54.0
4824.0	48.3	N/A	37.1	51.9	N/A	44.9	54.0
4874.0	50.7	N/A	43.5	54.0	N/A	49.2	54.0
4924.0	54.0	N/A	16.6	16.1	N/A	44.6	54.0
7236.0	49.6	N/A	36.4	50.7	N/A	38.0	54.0
7311.0	49.4	N/A	36.1	52.5	N/A	41.3	54.0
7386.0	54.0	N/A	16.6	16.1	N/A	40.9	54.0
12060.0	49.1	N/A	36.0	48.7	N/A	36.0	54.0
12185.0	48.9	N/A	36.1	49.1	N/A	35.7	54.0
12310.0	47.8	N/A	35.1	47.3	N/A	34.5	54.0
14472.0	51.3	N/A	38.3	51.7	N/A	38.3	54.0

Other emissions present had amplitudes at least 20 dB below the limit. Peak and Quasi-Peak amplitude emissions are recorded above for frequency range below 1000 MHz. Peak and Average amplitude emissions are recorded above for frequency range above 1000 MHz.

**Table 5 Harmonic Radiated Emissions in Restricted Bands Data (WLP-2450-20)**

Frequency in MHz	Horizontal Peak (dB $\mu$ V/m)	Horizontal Quasi-Peak (dB $\mu$ V/m)	Horizontal Average (dB $\mu$ V/m)	Vertical Peak (dB $\mu$ V/m)	Vertical Quasi-Peak (dB $\mu$ V/m)	Vertical Average (dB $\mu$ V/m)	Limit @ 3m (dB $\mu$ V/m)
2390.0	69.0	N/A	49.0	55.2	N/A	44.2	54.0
2483.5	61.4	N/A	51.0	57.6	N/A	44.5	54.0
4824.0	48.2	N/A	34.6	47.6	N/A	36.2	54.0
4874.0	48.5	N/A	38.2	47.3	N/A	34.8	54.0
4924.0	54.0	N/A	16.6	16.1	N/A	35.1	54.0
7236.0	47.4	N/A	35.9	44.4	N/A	31.8	54.0
7311.0	50.7	N/A	40.8	44.5	N/A	32.1	54.0
7386.0	54.0	N/A	16.6	16.1	N/A	36.6	54.0
12060.0	48.4	N/A	36.0	49.0	N/A	36.1	54.0
12185.0	49.4	N/A	36.0	48.4	N/A	35.6	54.0
12310.0	47.7	N/A	34.9	47.9	N/A	35.5	54.0
14472.0	50.9	N/A	38.4	51.3	N/A	38.4	54.0

Other emissions present had amplitudes at least 20 dB below the limit. Peak and Quasi-Peak amplitude emissions are recorded above for frequency range below 1000 MHz. Peak and Average amplitude emissions are recorded above for frequency range above 1000 MHz.

**Table 6 Harmonic Radiated Emissions in Restricted Bands Data (24-HD-PFIP)**

Frequency in MHz	Horizontal Peak (dBµV/m)	Horizontal Quasi-Peak (dBµV/m)	Horizontal Average (dBµV/m)	Vertical Peak (dBµV/m)	Vertical Quasi-Peak (dBµV/m)	Vertical Average (dBµV/m)	Limit @ 3m (dBµV/m)
2390.0	48.0	N/A	33.3	56.6	N/A	49.8	54.0
2483.5	50.9	N/A	37.3	67.1	N/A	50.8	54.0
4824.0	48.3	N/A	37.1	51.9	N/A	44.9	54.0
4874.0	50.7	N/A	43.5	54.0	N/A	49.2	54.0
4924.0	54.0	N/A	16.6	16.1	N/A	44.6	54.0
7236.0	49.6	N/A	36.4	50.7	N/A	38.0	54.0
7311.0	49.4	N/A	36.1	52.5	N/A	41.3	54.0
7386.0	54.0	N/A	16.6	16.1	N/A	40.9	54.0
12060.0	49.1	N/A	36.0	48.7	N/A	36.0	54.0
12185.0	48.9	N/A	36.1	49.1	N/A	35.7	54.0
12310.0	47.8	N/A	35.1	47.3	N/A	34.5	54.0
14472.0	51.3	N/A	38.3	51.7	N/A	38.3	54.0

Other emissions present had amplitudes at least 20 dB below the limit. Peak and Quasi-Peak amplitude emissions are recorded above for frequency range below 1000 MHz. Peak and Average amplitude emissions are recorded above for frequency range above 1000 MHz.

**Table 7 Harmonic Radiated Emissions in Restricted Bands Data (MT-482016/N/A)**

Frequency in MHz	Horizontal Peak (dBµV/m)	Horizontal Quasi-Peak (dBµV/m)	Horizontal Average (dBµV/m)	Vertical Peak (dBµV/m)	Vertical Quasi-Peak (dBµV/m)	Vertical Average (dBµV/m)	Limit @ 3m (dBµV/m)
11490.0	50.1	N/A	36.4	48.2	N/A	36.0	54.0
11570.0	50.1	N/A	37.4	49.1	N/A	36.5	54.0
11650.0	49.8	N/A	37.4	49.8	N/A	37.0	54.0
22980.0	43.0	N/A	30.3	43.3	N/A	30.4	54.0

Other emissions present had amplitudes at least 20 dB below the limit. Peak and Quasi-Peak amplitude emissions are recorded above for frequency range below 1000 MHz. Peak and Average amplitude emissions are recorded above for frequency range above 1000 MHz.

**Table 8 Harmonic Radiated Emissions in Restricted Bands Data (PA58-24-ANT)**

Frequency in MHz	Horizontal Peak (dB $\mu$ V/m)	Horizontal Quasi-Peak (dB $\mu$ V/m)	Horizontal Average (dB $\mu$ V/m)	Vertical Peak (dB $\mu$ V/m)	Vertical Quasi-Peak (dB $\mu$ V/m)	Vertical Average (dB $\mu$ V/m)	Limit @ 3m (dB $\mu$ V/m)
11490.0	48.3	N/A	35.6	48.6	N/A	35.7	54.0
11570.0	48.8	N/A	36.0	49.5	N/A	36.9	54.0
11650.0	51.0	N/A	38.0	51.5	N/A	38.5	54.0
22980.0	42.2	N/A	29.9	42.2	N/A	29.9	54.0

Other emissions present had amplitudes at least 20 dB below the limit. Peak and Quasi-Peak amplitude emissions are recorded above for frequency range below 1000 MHz. Peak and Average amplitude emissions are recorded above for frequency range above 1000 MHz.

**Table 9 Harmonic Radiated Emissions in Restricted Bands Data (HDDA5W-32-DP2)**

Frequency in MHz	Horizontal Peak (dB $\mu$ V/m)	Horizontal Quasi-Peak (dB $\mu$ V/m)	Horizontal Average (dB $\mu$ V/m)	Vertical Peak (dB $\mu$ V/m)	Vertical Quasi-Peak (dB $\mu$ V/m)	Vertical Average (dB $\mu$ V/m)	Limit @ 3m (dB $\mu$ V/m)
11490.0	59.0	N/A	44.8	63.5	N/A	49.5	54.0
11570.0	56.6	N/A	43.6	63.8	N/A	45.7	54.0
11650.0	54.7	N/A	40.0	68.1	N/A	50.9	54.0
22980.0	43.7	N/A	30.9	44.3	N/A	31.4	54.0

Other emissions present had amplitudes at least 20 dB below the limit. Peak and Quasi-Peak amplitude emissions are recorded above for frequency range below 1000 MHz. Peak and Average amplitude emissions are recorded above for frequency range above 1000 MHz.

**Summary of Results for Radiated Emissions in Restricted Bands**

The EUT demonstrated compliance with the radiated emissions requirements of CFR 47 Part 15C Intentional Radiators. The EUT demonstrated a worst-case minimum margin of -2.5 dB below the radiated emissions requirements in restricted frequency bands. Peak, Quasi-peak, and average amplitudes were checked for compliance with the regulations. Worst-case emissions are reported with other emissions found in the restricted frequency bands at least 20 dB below the requirements.

**AC Line Conducted Emissions Procedure**

The EUT was arranged in a typical equipment configuration and placed on a 1 x 1.5-meter wooden bench 80 cm above the conducting ground plane, floor of a screen room. The bench was positioned 40 cm away from the wall of the screen room. The LISN was positioned on the floor of the screen room 80-cm from the rear of the EUT. The manufacturer supplied AC power adapter for the EUT was connected to the LISN. A second LISN was positioned on the floor of the screen room 80-cm from the rear of the supporting equipment of the EUT. All power cords except the EUT were then powered from the second LISN. EMI was coupled to the spectrum analyzer through a 0.1  $\mu$ F capacitor, internal to the LISN. Power line conducted emissions testing were carried out individually for each current carrying conductor of the EUT. The excess length of lead between the system and the LISN receptacle was folded back and forth to form a bundle not exceeding 40 cm in length. The screen room, conducting ground plane, analyzer, and LISN were bonded together to the protective earth ground. Preliminary testing was performed to identify the frequency of each radio frequency emission displaying the highest amplitude. The cables were repositioned to obtain maximum amplitude of measured EMI level. Once the worst-case configuration was identified, plots were made of the EMI from 0.15 MHz to 30 MHz then the data was recorded with maximum conducted emissions levels. Refer to figures one and two for plots of the EUT powered by manufacturer supplied AC/DC adapter, AC Power Line conducted emissions.

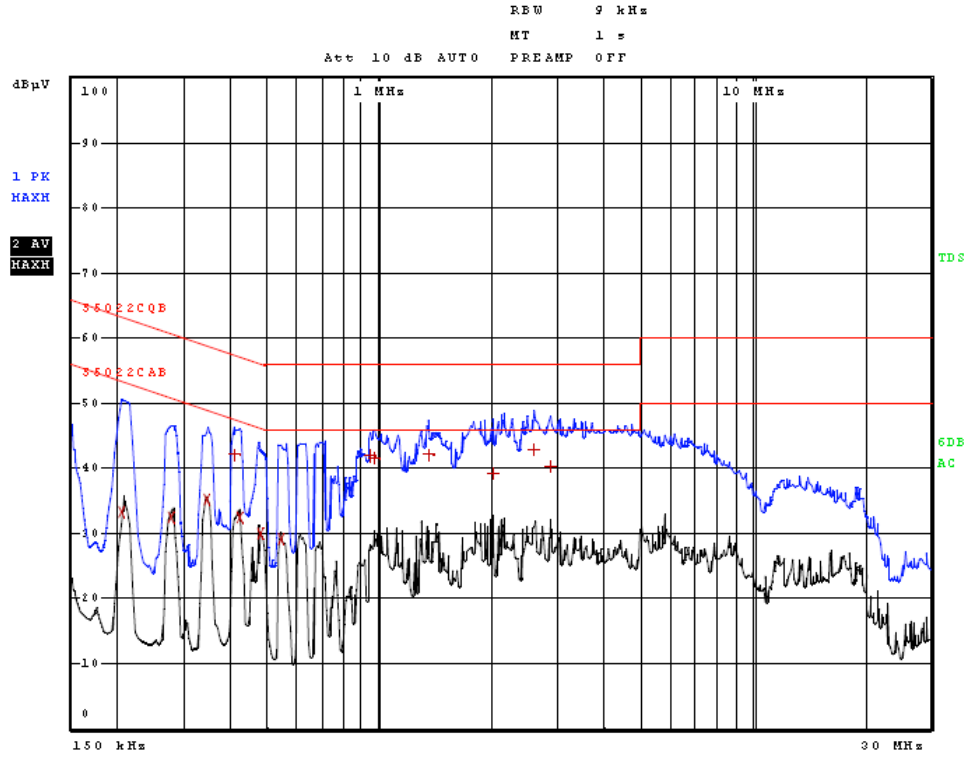

Figure 1 AC Line Conducted Emissions Line 1

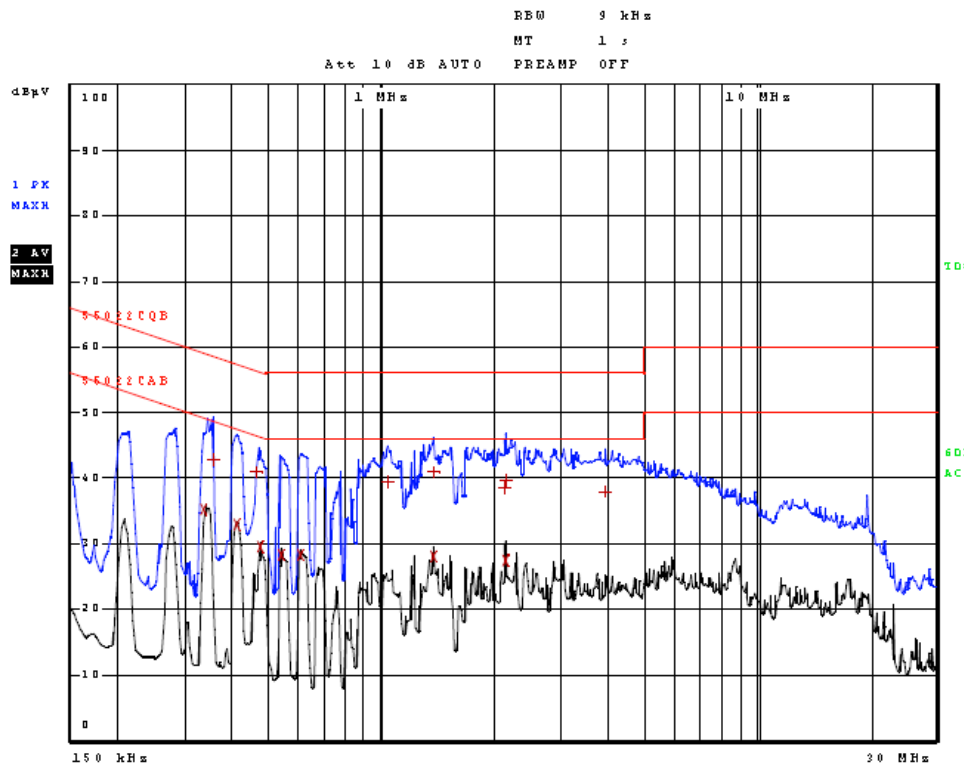

Figure 2 AC Line Conducted Emissions Line 2



**Table 10 AC Line Conducted Emissions Data (Highest Emissions Line L1)**

Trace	Frequency	Level (dBµV)	Detector	Delta Limit/dB
2	206.000000000 kHz	33.21	Average	-20.16
2	278.000000000 kHz	32.55	Average	-18.32
2	342.000000000 kHz	35.19	Average	-13.96
1	406.000000000 kHz	42.03	Quasi Peak	-15.70
2	418.000000000 kHz	32.55	Average	-14.94
2	478.000000000 kHz	29.87	Average	-16.50
2	542.000000000 kHz	29.20	Average	-16.80
1	942.000000000 kHz	42.01	Quasi Peak	-13.99
1	970.000000000 kHz	41.57	Quasi Peak	-14.43
1	1.346000000 MHz	42.18	Quasi Peak	-13.82
1	2.006000000 MHz	39.28	Quasi Peak	-16.72
1	2.594000000 MHz	42.93	Quasi Peak	-13.07
1	2.870000000 MHz	40.31	Quasi Peak	-15.69

Other emissions present had amplitudes at least 20 dB below the limit.

**Table 11 AC Line Conducted Emissions Data (Highest Emissions Line L2)**

Trace	Frequency	Level (dBµV)	Detector	Delta Limit/dB
2	338.000000000 kHz	35.26	Average	-13.99
1	354.000000000 kHz	42.79	Quasi Peak	-16.08
2	410.000000000 kHz	32.91	Average	-14.74
1	466.000000000 kHz	40.96	Quasi Peak	-15.63
2	474.000000000 kHz	29.54	Average	-16.91
2	538.000000000 kHz	28.28	Average	-17.72
2	606.000000000 kHz	28.21	Average	-17.79
1	1.034000000 MHz	39.49	Quasi Peak	-16.51
2	1.366000000 MHz	28.13	Average	-17.87
1	1.366000000 MHz	40.94	Quasi Peak	-15.06
1	2.118000000 MHz	38.58	Quasi Peak	-17.42
2	2.134000000 MHz	27.32	Average	-18.68
1	2.138000000 MHz	39.70	Quasi Peak	-16.30
1	3.954000000 MHz	37.89	Quasi Peak	-18.11

Other emissions present had amplitudes at least 20 dB below the limit.

**Summary of Results for AC Line Conducted Emissions**

The EUT demonstrated compliance to the conducted emissions requirements of CFR47 Part 15C equipment. The EUT demonstrated minimum margin of -13.0 dB below the limit.

Measurements were taken using the peak, quasi peak, and average, measurement function for each emissions amplitude and were below the limits stated in the specification. Other emissions were present with recorded data representing worst-case amplitudes.



### **General Radiated Emissions Procedure**

The EUT was arranged in a typical equipment configuration and operated through all available modes with worst-case data recorded. Preliminary testing was performed in a screen room with the EUT positioned 1 meter from the FSM. Radiated emissions measurements were performed to identify the frequencies, which produced the highest emissions. Each radiated emission was then maximized at the OATS location before final radiated emissions measurements were performed. Final data was taken with the EUT located at the OATS at a distance of 3 meters between the EUT and the receiving antenna. The frequency spectrum from 9 kHz to 60,000 MHz was searched for general radiated emissions. Measured emission levels were maximized by EUT placement on the table, rotating the turntable through 360 degrees, varying the antenna height between 1 and 4 meters above the ground plane and changing antenna position between horizontal and vertical polarization. Antennas used were Loop from 9 kHz to 30 MHz, Broadband Biconical from 30 to 200 MHz, Biconilog from 30 to 1000 MHz, Log Periodic from 200 MHz to 1 GHz and or Double Ridge or pyramidal horns and mixers from 1 GHz to 60 GHz, notch filters and appropriate amplifiers and external mixers were utilized.

**Table 12 General Radiated Emissions from EUT Data (Highest Emissions)**

Frequency in MHz	Horizontal Peak (dBµV/m)	Horizontal Quasi-Peak (dBµV/m)	Horizontal Average (dBµV/m)	Vertical Peak (dBµV/m)	Vertical Quasi-Peak (dBµV/m)	Vertical Average (dBµV/m)	Limit @ 3m (dBµV/m)
64.8	34.4	31.1	N/A	37.6	33.9	N/A	40.0
125.0	39.8	38.3	N/A	40.0	38.0	N/A	43.5
132.3	26.9	21.3	N/A	27.6	22.6	N/A	43.5
132.9	29.9	23.0	N/A	31.8	27.7	N/A	43.5
134.4	32.7	27.9	N/A	36.3	33.5	N/A	43.5
135.8	32.6	29.1	N/A	35.9	32.6	N/A	43.5
136.9	42.3	38.3	N/A	36.4	32.1	N/A	43.5
137.2	33.5	30.2	N/A	35.4	32.2	N/A	43.5
143.3	42.4	38.4	N/A	34.4	29.8	N/A	43.5
145.3	39.2	36.0	N/A	32.0	28.1	N/A	43.5
145.8	29.9	26.1	N/A	30.1	26.0	N/A	43.5
250.0	40.0	38.0	N/A	37.8	35.4	N/A	46.0
275.0	35.0	32.6	N/A	34.2	31.1	N/A	46.0
300.0	36.6	33.8	N/A	29.0	25.0	N/A	46.0
350.0	38.1	36.3	N/A	34.1	31.4	N/A	46.0
400.0	43.0	40.6	N/A	38.6	35.4	N/A	46.0
500.0	38.9	37.2	N/A	40.1	38.9	N/A	46.0
575.0	43.2	42.8	N/A	43.3	43.0	N/A	46.0
600.0	45.9	42.8	N/A	46.6	43.8	N/A	46.0
675.0	35.8	33.6	N/A	32.0	28.8	N/A	46.0
875.0	34.5	32.6	N/A	32.6	28.8	N/A	46.0

Other emissions present had amplitudes at least 20 dB below the limit. Peak and Quasi-Peak amplitude emissions are recorded above for frequency range below 1000 MHz. Peak and Average amplitude emissions are recorded above for frequency range above 1000 MHz.



### **Summary of Results for General Radiated Emissions**

The EUT demonstrated compliance with the radiated emissions requirements of CFR47 Part 15C paragraph 15.209 Intentional Radiators. The EUT demonstrated a minimum margin of -2.2 dB below the requirements. Other emissions were present with amplitudes at least 20 dB below the Limits.

### **Operation in the Band 2400 – 2483.5 and 5725-5850 MHz**

The power output was measured at the antenna port and the open area test site at a three-meter distance. The EUT was placed on a wooden turntable 0.8 meters above the ground plane at a distance of 3 meters from the FSM antenna. The peak and quasi-peak amplitude of the frequencies below 1000 MHz were measured using a spectrum analyzer. The peak and average amplitude of emissions above 1000 MHz including were measured using a spectrum analyzer. Emissions data was recorded from the measurement results. Plots were made of transmitter performance for reference purposes. Refer to figures three through eight showing plots of the EUT performance displaying compliance with the specifications (worst-case band edge plots are presented and test data for each presented in tables 2 through 9).

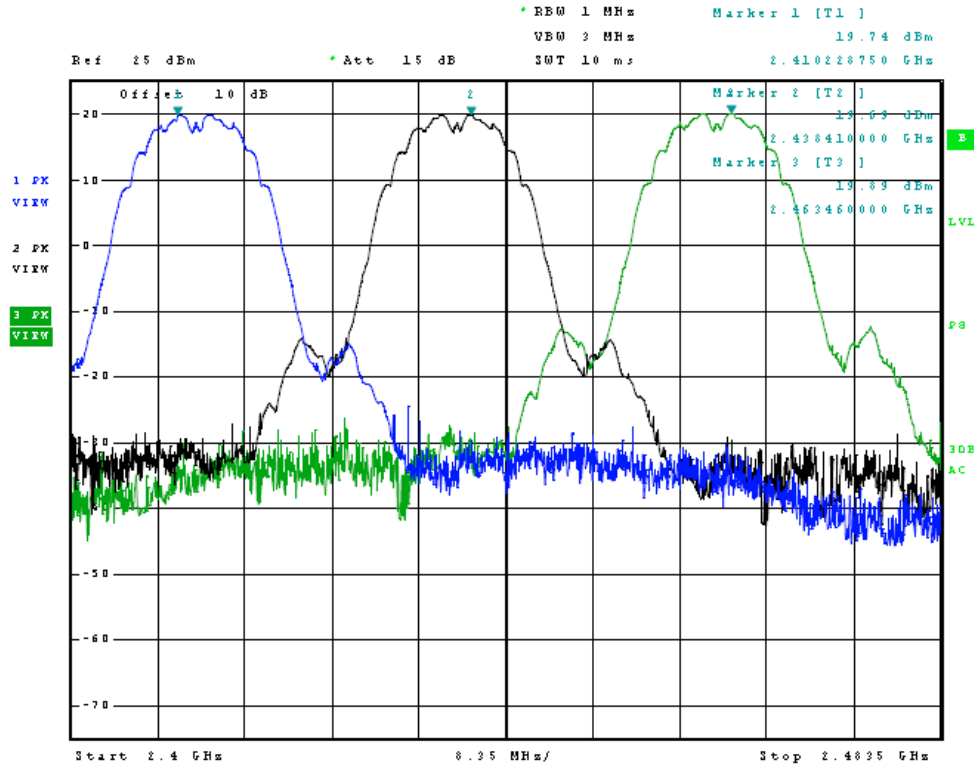

Figure 3 Plot of Transmitter Emissions (Across Operational Band, 2.4 GHz b/g/n)

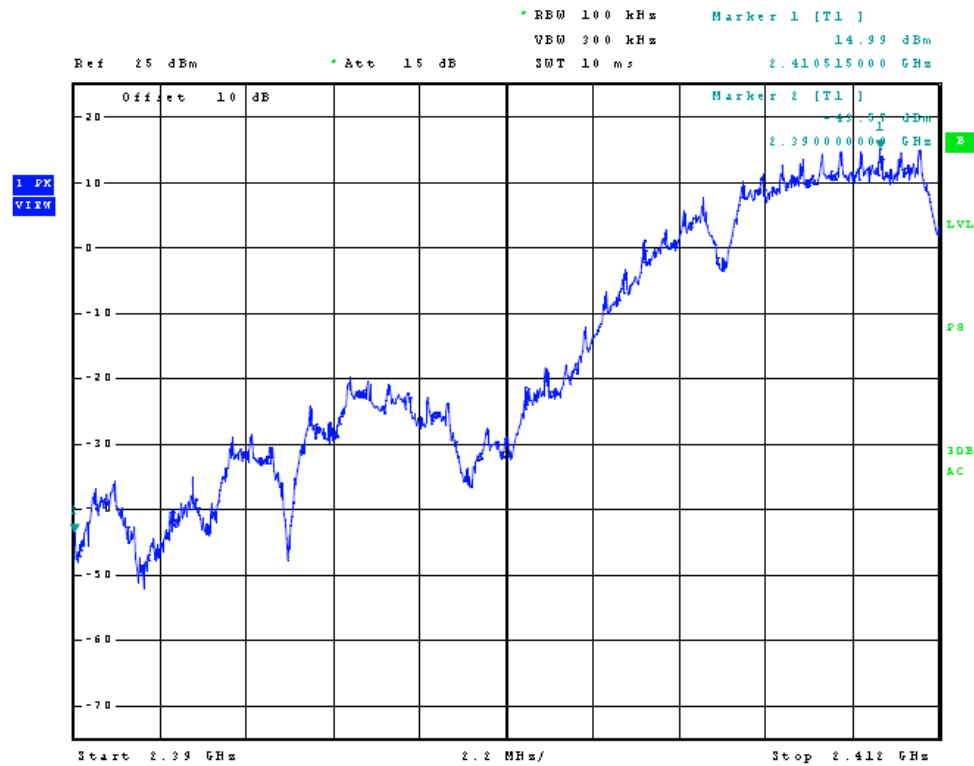

Figure 4 Plot of Low Band Edge (2.4 GHz b/g/n Mode)

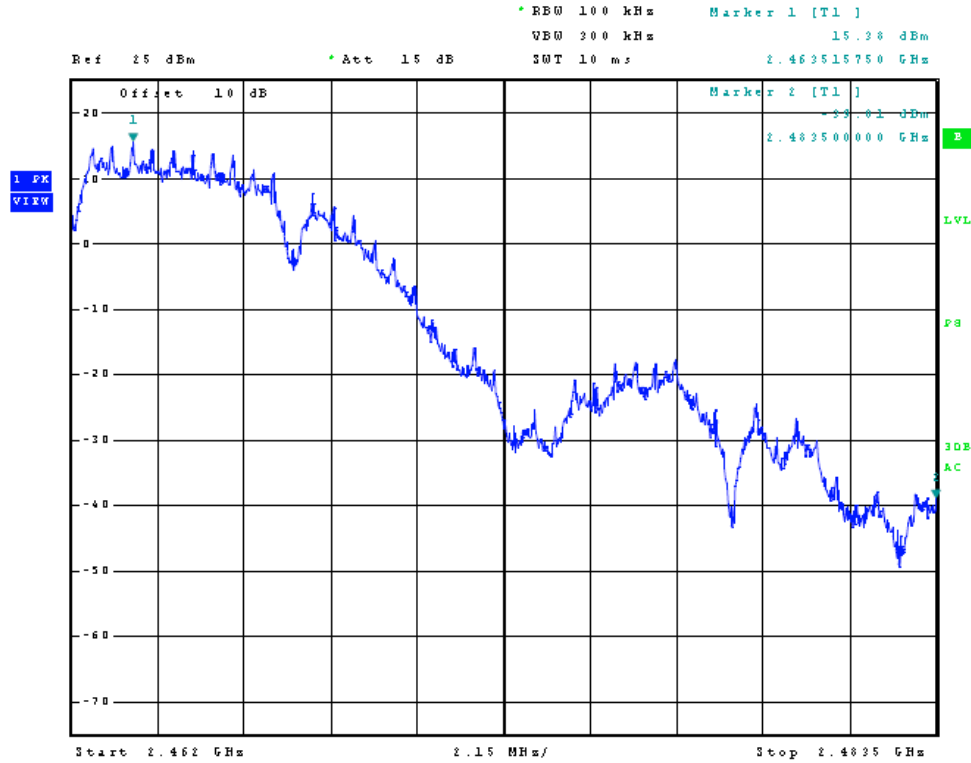

Figure 5 Plot of High Band Edge (2.4 GHz b/g/n Mode)

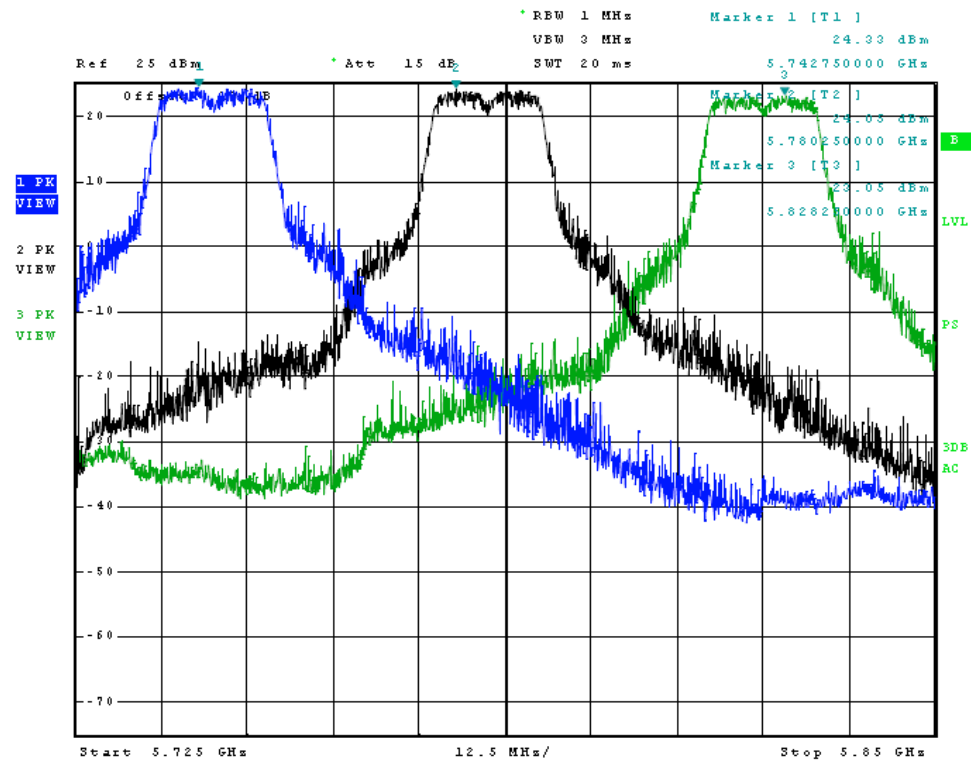

Figure 6 Plot of Transmitter Emissions (Across Operational Band, 5 GHz a/n)

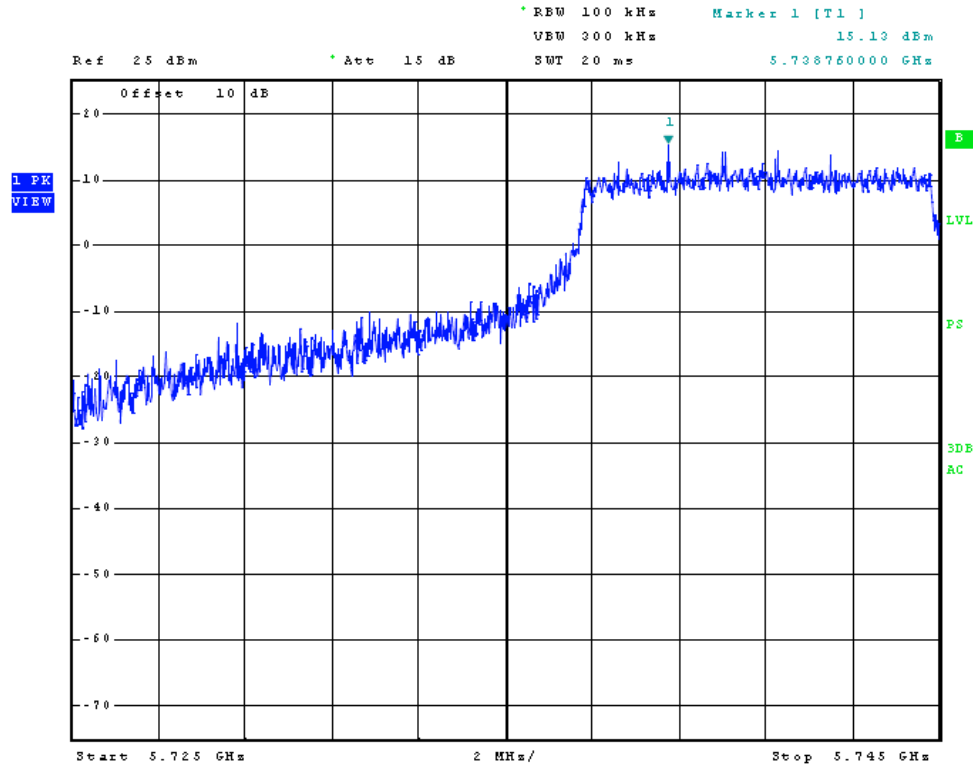

Figure 7 Plot of Low Band Edge (5 GHz a/n)

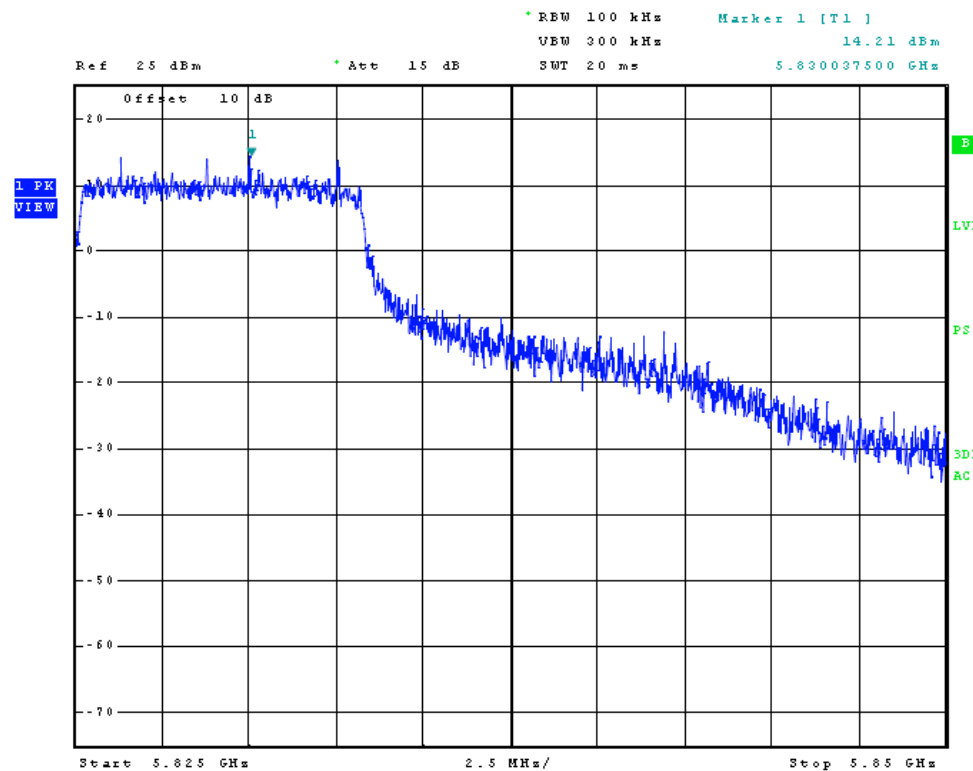

Figure 8 Plot of High Band Edge (5 GHz a/n)

**Transmitter Emissions Data**

**Table 13 Transmitter Antenna Conducted Emissions Data**

Frequency MHz	Antenna Conducted Output Power dBm	OBW (a)	OBW (b)	OBW (g)	OBW (n)	PSD dBm
2412.0	27.21	-	10,440	16,045	-	3.00
2437.0	26.99	-	10,450	16,060	-	2.66
2462.0	27.27	-	10,440	16,045	-	3.33
2422.0	27.01	-	-	-	36,045	1.89
2437.0	26.89	-	-	-	36,060	1.65
2452.0	27.07	-	-	-	36,045	2.13
5745.0	27.13	16500	-	-	-	3.39
5785.0	27.07	16500	-	-	-	4.34
5825.0	27.18	16475	-	-	-	2.41
5755.0	27.13	-	-	-	37,220	2.15
5785.0	27.07	-	-	-	37,140	3.12
5815.0	27.18	-	-	-	37,220	1.56

OBW - Occupied Bandwidth kHz (operational mode)



**Table 14 Transmitter Radiated Emission (ODH 24-13)**

Frequency in MHz	Horizontal Peak (dBµV/m)	Horizontal Average (dBµV/m)	Vertical Peak (dBµV/m)	Vertical Average (dBµV/m)	Limit @ 3m (dBµV/m)
2412.0	--	--	--	--	--
4824.0	55.3	47.5	47.9	34.6	54.0
7236.0	48.9	36.3	50.2	37.1	54.0
9648.0	51.0	38.5	52.0	41.0	54.0
12060.0	49.0	36.2	48.5	36.0	54.0
14472.0	51.3	38.5	50.5	38.4	54.0
16884.0	48.6	36.2	48.4	36.2	54.0
2437.0	--	--	--	--	--
4874.0	49.0	39.4	47.2	34.5	54.0
7311.0	51.3	39.3	49.3	36.7	54.0
9748.0	51.9	39.5	54.0	44.3	54.0
12185.0	48.3	36.1	49.4	36.5	54.0
14622.0	50.7	38.3	51.6	38.7	54.0
17059.0	50.6	38.2	50.9	38.2	54.0
2462.0	--	--	--	--	--
4924.0	49.1	41.4	45.8	33.7	54.0
7386.0	46.2	33.4	46.5	33.8	54.0
9848.0	51.3	38.6	53.0	42.7	54.0
12310.0	47.6	35.2	47.6	34.7	54.0
14772.0	52.5	39.9	52.4	39.8	54.0
17234.0	52.0	39.1	51.9	39.1	54.0

Other emissions present had amplitudes at least 20 dB below the limit. Peak and Quasi-Peak amplitude emissions are recorded above for frequency range below 1000 MHz. Peak and Average amplitude emissions are recorded above for frequency range above 1000 MHz.

**Table 15 Transmitter Radiated Emission (WLO-2450-15)**

Frequency in MHz	Horizontal Peak (dBµV/m)	Horizontal Average (dBµV/m)	Vertical Peak (dBµV/m)	Vertical Average (dBµV/m)	Limit @ 3m (dBµV/m)
2412.0	--	--	--	--	--
4824.0	50.9	42.5	50.7	41.8	54.0
7236.0	46.1	33.3	48.9	37.3	54.0
9648.0	52.7	40.4	52.2	40.4	54.0
12060.0	49.6	36.2	49.0	36.1	54.0
14472.0	51.1	38.1	51.1	38.2	54.0
16884.0	48.2	35.9	48.6	36.0	54.0
2437.0	--	--	--	--	--
4874.0	48.6	37.4	52.1	45.7	54.0
7311.0	49.0	36.3	49.9	37.3	54.0
9748.0	50.3	39.0	50.5	39.6	54.0
12185.0	48.9	36.0	48.6	35.7	54.0
14622.0	51.0	38.4	50.6	38.2	54.0
17059.0	50.1	37.8	50.7	37.9	54.0
2462.0	--	--	--	--	--
4924.0	47.4	35.5	49.4	41.1	54.0
7386.0	49.1	36.6	49.9	36.9	54.0
9848.0	50.8	38.4	50.2	37.9	54.0
12310.0	47.6	35.2	47.3	34.7	54.0
14772.0	52.2	39.9	52.4	39.8	54.0
17234.0	51.6	39.0	52.0	39.0	54.0

Other emissions present had amplitudes at least 20 dB below the limit. Peak and Quasi-Peak amplitude emissions are recorded above for frequency range below 1000 MHz. Peak and Average amplitude emissions are recorded above for frequency range above 1000 MHz.

**Table 16 Transmitter Radiated Emission (SA 24-90-17-WB)**

Frequency in MHz	Horizontal Peak (dBµV/m)	Horizontal Average (dBµV/m)	Vertical Peak (dBµV/m)	Vertical Average (dBµV/m)	Limit @ 3m (dBµV/m)
2412.0	--	--	--	--	--
4824.0	48.3	37.1	51.9	44.9	54.0
7236.0	49.6	36.4	50.7	38.0	54.0
9648.0	51.1	37.8	51.4	38.7	54.0
12060.0	49.1	36.0	48.7	36.0	54.0
14472.0	51.3	38.3	51.7	38.3	54.0
16884.0	48.9	36.3	49.3	36.3	54.0
2437.0	--	--	--	--	--
4874.0	50.7	43.5	54.0	49.2	54.0
7311.0	49.4	36.1	52.5	41.3	54.0
9748.0	50.9	38.5	51.3	38.4	54.0
12185.0	48.9	36.1	49.1	35.7	54.0
14622.0	51.9	38.5	51.0	38.2	54.0
17059.0	50.8	38.2	50.8	38.3	54.0
2462.0	--	--	--	--	--
4924.0	48.5	36.2	51.5	44.6	54.0
7386.0	49.2	36.8	52.4	40.9	54.0
9848.0	50.5	38.1	51.5	37.9	54.0
12310.0	47.8	35.1	47.3	34.5	54.0
14772.0	52.1	39.9	52.4	39.8	54.0
17234.0	51.8	39.1	51.7	39.0	54.0

Other emissions present had amplitudes at least 20 dB below the limit. Peak and Quasi-Peak amplitude emissions are recorded above for frequency range below 1000 MHz. Peak and Average amplitude emissions are recorded above for frequency range above 1000 MHz.

**Table 17 Transmitter Radiated Emission (WLP-2450-20)**

Frequency in MHz	Horizontal Peak (dBµV/m)	Horizontal Average (dBµV/m)	Vertical Peak (dBµV/m)	Vertical Average (dBµV/m)	Limit @ 3m (dBµV/m)
2412.0	--	--	--	--	--
4824.0	48.2	34.6	47.6	36.2	54.0
7236.0	47.4	35.9	44.4	31.8	54.0
9648.0	50.6	37.8	50.3	37.9	54.0
12060.0	48.4	36.0	49.0	36.1	54.0
14472.0	50.9	38.4	51.3	38.4	54.0
16884.0	49.3	36.4	48.9	36.4	54.0
2437.0	--	--	--	--	--
4874.0	48.5	38.2	47.3	34.8	54.0
7311.0	50.7	40.8	44.5	32.1	54.0
9748.0	50.8	38.2	52.0	38.3	54.0
12185.0	49.4	36.0	48.4	35.6	54.0
14622.0	51.4	38.5	51.5	38.2	54.0
17059.0	51.1	38.1	51.1	38.2	54.0
2462.0	--	--	--	--	--
4924.0	46.9	34.7	47.1	35.1	54.0
7386.0	56.7	46.1	49.6	36.6	54.0
9848.0	50.9	38.1	50.8	38.3	54.0
12310.0	47.7	34.9	47.9	35.5	54.0
14772.0	52.1	39.8	52.2	39.9	54.0
17234.0	51.9	39.2	51.8	39.2	54.0

Other emissions present had amplitudes at least 20 dB below the limit. Peak and Quasi-Peak amplitude emissions are recorded above for frequency range below 1000 MHz. Peak and Average amplitude emissions are recorded above for frequency range above 1000 MHz.

**Table 18 Transmitter Radiated Emission (24-HD-PFIP)**

Frequency in MHz	Horizontal Peak (dBµV/m)	Horizontal Average (dBµV/m)	Vertical Peak (dBµV/m)	Vertical Average (dBµV/m)	Limit @ 3m (dBµV/m)
2412.0	--	--	--	--	--
4824.0	49.6	40.5	67.8	51.4	54.0
7236.0	50.0	37.5	52.5	40.8	54.0
9648.0	52.3	40.4	52.3	41.0	54.0
12060.0	48.7	36.0	48.9	36.0	54.0
14472.0	51.8	38.3	51.0	38.3	54.0
16884.0	49.0	36.6	49.4	36.5	54.0
2437.0	--	--	--	--	--
4874.0	48.4	37.1	62.9	51.0	54.0
7311.0	51.2	39.3	61.2	49.5	54.0
9748.0	51.8	39.9	52.8	41.7	54.0
12185.0	49.4	36.0	49.4	35.7	54.0
14622.0	51.8	38.5	50.5	38.2	54.0
17059.0	51.4	38.2	51.7	38.3	54.0
2462.0	--	--	--	--	--
4924.0	51.0	44.8	61.0	51.0	54.0
7386.0	51.8	39.8	60.1	50.4	54.0
9848.0	50.7	38.5	51.4	39.0	54.0
12310.0	47.2	34.6	48.0	35.1	54.0
14772.0	52.2	39.8	52.6	39.9	54.0
17234.0	51.9	39.1	52.2	39.1	54.0

Other emissions present had amplitudes at least 20 dB below the limit. Peak and Quasi-Peak amplitude emissions are recorded above for frequency range below 1000 MHz. Peak and Average amplitude emissions are recorded above for frequency range above 1000 MHz.

**Table 19 Transmitter Radiated Emission (MT-482016/N/A)**

Frequency in MHz	Horizontal Peak (dBµV/m)	Horizontal Average (dBµV/m)	Vertical Peak (dBµV/m)	Vertical Average (dBµV/m)	Limit @ 3m (dBµV/m)
5745.0	--	--	--	--	--
11490.0	50.1	36.4	48.2	36.0	54.0
17235.0	54.4	41.7	54.3	41.5	54.0
22980.0	43.0	30.3	43.3	30.4	54.0
28725.0	39.5	27.1	39.5	27.1	54.0
5785.0	--	--	--	--	--
11570.0	50.1	37.4	49.1	36.5	54.0
17355.0	55.5	42.6	55.2	42.7	54.0
23140.0	43.0	30.6	43.3	30.6	54.0
28925.0	39.3	26.8	40.0	26.8	54.0
5825.0	--	--	--	--	--
11650.0	49.8	37.4	49.8	37.0	54.0
17475.0	55.6	42.9	56.6	43.2	54.0
23300.0	42.3	29.6	42.4	29.6	54.0
29125.0	39.2	26.4	39.9	26.4	54.0

Other emissions present had amplitudes at least 20 dB below the limit. Peak and Quasi-Peak amplitude emissions are recorded above for frequency range below 1000 MHz. Peak and Average amplitude emissions are recorded above for frequency range above 1000 MHz.

**Table 20 Transmitter Radiated Emission (PA58-24-ANT)**

Frequency in MHz	Horizontal Peak (dBμV/m)	Horizontal Average (dBμV/m)	Vertical Peak (dBμV/m)	Vertical Average (dBμV/m)	Limit @ 3m (dBμV/m)
5745.0	--	--	--	--	--
11490.0	48.3	35.6	48.6	35.7	54.0
17235.0	54.9	42.2	55.3	42.3	54.0
22980.0	42.2	29.9	42.2	29.9	54.0
28725.0	39.9	27.2	39.8	27.2	54.0
5785.0	--	--	--	--	--
11570.0	48.8	36.0	49.5	36.9	54.0
17355.0	55.4	43.1	56.5	43.3	54.0
23140.0	42.5	29.7	42.1	29.9	54.0
28925.0	39.4	26.8	39.6	27.0	54.0
5825.0	--	--	--	--	--
11650.0	51.0	38.0	51.5	38.5	54.0
17475.0	55.8	43.2	58.4	44.4	54.0
23300.0	42.7	29.7	42.8	29.9	54.0
29125.0	38.9	26.4	39.8	26.5	54.0

Other emissions present had amplitudes at least 20 dB below the limit. Peak and Quasi-Peak amplitude emissions are recorded above for frequency range below 1000 MHz. Peak and Average amplitude emissions are recorded above for frequency range above 1000 MHz.

**Table 21 Transmitter Radiated Emission (HDDA5W-32-DP2)**

Frequency in MHz	Horizontal Peak (dBμV/m)	Horizontal Average (dBμV/m)	Vertical Peak (dBμV/m)	Vertical Average (dBμV/m)	Limit @ 3m (dBμV/m)
5745.0	--	--	--	--	--
11490.0	59.0	44.8	63.5	49.5	54.0
17235.0	62.5	46.2	66.3	50.5	54.0
22980.0	43.7	30.9	44.3	31.4	54.0
28725.0	40.8	27.2	40.5	27.3	54.0
5785.0	--	--	--	--	--
11570.0	56.6	43.6	63.8	45.7	54.0
17355.0	55.9	42.9	63.2	46.6	54.0
23140.0	44.0	31.0	43.9	31.2	54.0
28925.0	39.4	26.8	39.7	26.8	54.0
5825.0	--	--	--	--	--
11650.0	54.7	40.0	68.1	50.9	54.0
17475.0	58.4	51.4	70.8	50.3	54.0
23300.0	41.9	29.5	49.5	36.5	54.0
29125.0	39.9	26.4	46.6	32.2	54.0

Other emissions present had amplitudes at least 20 dB below the limit. Peak and Quasi-Peak amplitude emissions are recorded above for frequency range below 1000 MHz. Peak and Average amplitude emissions are recorded above for frequency range above 1000 MHz.





## **Summary of Results for Transmitter Radiated Emissions of Intentional Radiator**

The EUT demonstrated compliance with the radiated emissions requirements of CFR47 Part 15.247. Peak antenna port conducted power of 0.533 watts. The peak power spectral density presented a minimum margin of -3.6 dB below the requirements. The EUT demonstrated a minimum margin of -2.6 dB below the harmonic emissions requirements. Band edge compliance was tested for each operational mode and antenna with worst case data presented in this report. There were no other significantly measurable emissions in the restricted bands other than those recorded in this report. Other emissions were present with amplitudes at least 20 dB below the requirements. There were no other deviations or exceptions to the requirements.

## **Statement of Modifications and Deviations**

No modifications to the EUT were required for the unit to demonstrate compliance with the CFR47 Part 15C emissions standards. There were no deviations or modifications to the specifications.



NVLAP Lab Code 200087-0

## Annex

- Annex A Measurement Uncertainty Calculations
- Annex B Rogers Labs Test Equipment List
- Annex C Rogers Qualifications
- Annex D FCC Site Registration Letter
- Annex E Industry Canada Site Registration Letter

**Annex A Measurement Uncertainty Calculations**

Measurement uncertainty calculations were made for the laboratory. Result of measurement uncertainty calculations are recorded below for AC line conducted and radiated emission measurements.

Measurement Uncertainty	$U_{(E)}$	$U_{(lab)}$
3 Meter Horizontal 30-200 MHz Measurements	2.08	4.16
3 Meter Vertical 30-200 MHz Measurements	2.16	4.33
3 Meter Vertical Measurements 200-1000 MHz	2.99	5.97
10 Meter Horizontal Measurements 30-200 MHz	2.07	4.15
10 Meter Vertical Measurements 30-200 MHz	2.06	4.13
10 Meter Horizontal Measurements 200-1000 MHz	2.32	4.64
10 Meter Vertical Measurements 200-1000 MHz	2.33	4.66
3 Meter Measurements 1-6 GHz	2.57	5.14
3 Meter Measurements 6-18 GHz	2.58	5.16
AC Line Conducted	1.72	3.43



**Annex B Rogers Labs Test Equipment List**

<u>Equipment</u>	<u>Calibration Date</u>
Spectrum Analyzer: Rohde & Schwarz ESU40	5/12
Spectrum Analyzer: HP 8562A, HP Adapters: 11518, 11519, and 11520 Mixers: 11517A, 11970A, 11970K, 11970U, 11970V, 11970W	5/12
Spectrum Analyzer: HP 8591EM	5/12
Antenna: EMCO Biconilog Model: 3143	5/12
Antenna: Sunol Biconilog Model: JB6	10/12
Antenna: EMCO Log Periodic Model: 3147	10/12
Antenna: Antenna Research Biconical Model: BCD 235	10/12
LISN: Compliance Design Model: FCC-LISN-2.Mod.cd, 50 µHy/50 ohm/0.1 µf	10/12
R.F. Preamp PA-010	10/12
R.F. Preamp CPPA-102	10/12
R.F. Preamp PA-122	10/12
Cable assembly: (L1) consisting of Belden RG-58, HP11509A, CAT-3	10/12
Cable assembly: (L2) consisting of Belden RG-58, HP11509A, CAT-3	10/12
Cable: (L3) Belden 8268	10/12
Cable: Time Microwave: 4M-750HF290-750	10/12
Cable: Time Microwave: 10M-750HF290-750	10/12
Antenna: EMCO 6509	10/12
Frequency Counter: Leader LDC825	2/13
Oscilloscope Scope: Tektronix 2230	2/13
Wattmeter: Bird 43 with 50 Ohm Load 8085	2/13
Power Supplies: Sorensen SRL 20-25, SRL 40-25, DCR 150, DCR 140	2/13
R.F. Generators: HP 606A, HP 8614A, HP 8640B	2/13
R.F. Power Amp 65W Model: 470-A-1010	2/13
R.F. Power Amp 50W M185- 10-501	2/13
R.F. Power Amp A.R. Model: 10W 1010M7	2/13
R.F. Power Amp EIN Model: A301	2/13
LISN: Compliance Eng. Model 240/20	2/13
LISN: Fischer Custom Communications Model: FCC-LISN-50-16-2-08	2/13
Antenna: EMCO Dipole Set 3121C	2/13
Antenna: Compliance Design B-101	2/13
Antenna: Solar 9229-1 & 9230-1	2/13
Audio Oscillator: HP 201CD	2/13
Peavey Power Amp Model: IPS 801	2/13
ELGAR Model: 1751	2/13
ELGAR Model: TG 704A-3D	2/13
ESD Test Set 2010i	2/13
Fast Transient Burst Generator Model: EFT/B-101	2/13
Field Intensity Meter: EFM-018	2/13
KEYTEK Ecat Surge Generator	2/13
Shielded Room 5 M x 3 M x 3.0 M	



## **Annex C Rogers Qualifications**

***Scot D. Rogers, Engineer***

### **Rogers Labs, Inc.**

Mr. Rogers has approximately 17 years experience in the field of electronics. Engineering experience includes six years in the automated controls industry and remaining years working with the design, development and testing of radio communications and electronic equipment.

#### Positions Held

Systems Engineer: A/C Controls Mfg. Co., Inc. 6 Years

Electrical Engineer: Rogers Consulting Labs, Inc. 5 Years

Electrical Engineer: Rogers Labs, Inc. Current

#### Educational Background

- 1) Bachelor of Science Degree in Electrical Engineering from Kansas State University.
- 2) Bachelor of Science Degree in Business Administration Kansas State University.
- 3) Several Specialized Training courses and seminars pertaining to Microprocessors and Software programming.

Scot D. Rogers



NVLAP Lab Code 200087-0

**Annex D FCC Site Registration Letter**

**FEDERAL COMMUNICATIONS COMMISSION**

**Laboratory Division  
7435 Oakland Mills Road  
Columbia, MD 21046**

November 01, 2011

Registration Number: 90910

Rogers Labs, Inc.  
4405 West 259th Terrace,  
Louisburg, KS 66053

Attention: Scot Rogers,

Re: Measurement facility located at Louisburg  
3 & 10 meter site  
Date of Renewal: November 01, 2011

Dear Sir or Madam:

Your request for renewal of the registration of the subject measurement facility has been received. The information submitted has been placed in your file and the registration has been renewed. The name of your organization will remain on the list of facilities whose measurement data will be accepted in conjunction with applications for Certification under Parts 15 or 18 of the Commission's Rules. Please note that the file must be updated for any changes made to the facility and the registration must be renewed at least every three years.

Measurement facilities that have indicated that they are available to the public to perform measurement services on a fee basis may be found on the FCC website [www.fcc.gov](http://www.fcc.gov) under E-Filing, OET Equipment Authorization Electronic Filing, Test Firms.

Sincerely,

Phyllis Parrish  
Industry Analyst

Rogers Labs, Inc.  
4405 W. 259th Terrace  
Louisburg, KS 66053  
Phone/Fax: (913) 837-3214  
Revision 2

Mikrotikls SIA  
Model: RBGrooveA 52HPn  
Test #: 130318  
Test to: CFR47 (15.247)  
File: Mikrotikls RBGrooveA52 TstRpt 130318 r2

SN: 2BAB015524CB  
FCC ID#: TV7GRV-A52HPN  
Date: September 9, 2013  
Page 46 of 47



NVLAP Lab Code 200087-0

## Annex E Industry Canada Site Registration Letter



December 28, 2011

OUR FILE: 46405-3041  
Submission No: 152685

Rogers Labs Inc.  
4405 West 259th Terrance  
Louisburg, KS, 66053  
USA

**Attention:** Mr. Scot D. Rogers

Dear Sir/Madame:

The Bureau has received your application for the renewal of 3/10m OATS. Be advised that the information received was satisfactory to Industry Canada. The following number(s) is now associated to the site(s) for which registration / renewal was sought ( **Site# 3041A-1** ). Please reference the appropriate site number in the body of test reports containing measurements performed on the site. In addition, please keep for your records the following information;

- The company address code associated to the site(s) located at the above address is: **3041A**

Furthermore, to obtain or renew a unique site number, the applicant shall demonstrate that the site has been accredited to ANSI C63.4-2003 or later. A scope of accreditation indicating the accreditation by a recognized accreditation body to ANSI C63.4-2003 or later shall be accepted. Please indicate in a letter the previous assigned site number if applicable and the type of site (example: 3 metre OATS or 3 metre chamber). If the test facility is not accredited to ANSI C63.4-2003 or later, the test facility shall submit test data demonstrating full compliance with the ANSI standard. The Bureau will evaluate the filing to determine if recognition shall be granted.

The frequency for re-validation of the test site and the information that is required to be filed or retained by the testing party shall comply with the requirements established by the accrediting organization. However, in all cases, test site re-validation shall occur on an interval not to **exceed three years**. There is no fee or form associated with an OATS filing. OATS submissions are encouraged to be submitted electronically to the Bureau using the following URL;  
[http://strategis.ic.gc.ca/epic/internet/inceb-bhst.nsf/en/h\\_tt00052e.html](http://strategis.ic.gc.ca/epic/internet/inceb-bhst.nsf/en/h_tt00052e.html).

If you have any questions, you may contact the Bureau by e-mail at [certification.bureau@ic.gc.ca](mailto:certification.bureau@ic.gc.ca) Please reference our file and submission number above for all correspondence.

Yours sincerely,

Dalwinder Gill  
For: Wireless Laboratory Manager  
**Certification and Engineering Bureau**  
3701 Carling Ave., Building 94  
P.O. Box 11490, Station "H"  
Ottawa, Ontario K2H 8S2  
Email: [dalwinder.gill@ic.gc.ca](mailto:dalwinder.gill@ic.gc.ca)  
Tel. No. (613) 998-8363  
Fax. No. (613) 990-4752

Rogers Labs, Inc.  
4405 W. 259th Terrace  
Louisburg, KS 66053  
Phone/Fax: (913) 837-3214  
Revision 2

Mikrotikls SIA  
Model: RBGrooveA 52HPn  
Test #: 130318  
Test to: CFR47 (15.247)  
File: Mikrotikls RBGrooveA52 TstRpt 130318 r2

SN: 2BAB015524CB  
FCC ID#: TV7GRV-A52HPN  
Date: September 9, 2013  
Page 47 of 47