

Submittal Application Report

FOR
Grant of Certification

FOR

Model: RBcAP2nD
2412-2462 MHz
Broadband Digital Transmission System
FCC ID: TV7RBCM2ND
IC: 7442A-CM2ND

FOR

Mikrotikls SIA
Pernavas 46 Str.
Riga LV-1009 Latvia

Test Report Number: 160714
IC Test Site Registration: 3041A-1

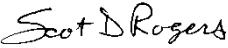
Authorized Signatory: 
Scot D. Rogers

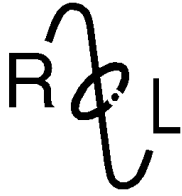

ROGERS LABS, INC.

4405 West 259th Terrace
Louisburg, KS 66053
Phone / Fax (913) 837-3214

Engineering Test Report for
Grant of Certification Application
FOR
Broadband Digital Transmission System
CFR 47, PART 15C - Paragraph 15.247
Industry Canada RSS-247 Issue1
License Exempt Intentional Radiator
For

Mikrotikls SIA

Pernavas 46 Str.
Riga LV-1009 Latvia

Broadband Digital Transmission System

Model: RBcAP2nD
Frequency Range 2412-2462 MHz
FCC ID#: TV7RBCM2ND
IC: 7442A-CM2ND

Test Date: July 14, 2016

Certifying Engineer: *Scot D. Rogers*
Scot D. Rogers
Rogers Labs, Inc.
4405 West 259th Terrace
Louisburg, KS 66053
Telephone/Facsimile: (913) 837-3214

This report shall not be reproduced except in full, without the written approval of the laboratory.
This report must not be used by the client to claim product certification, approval, or endorsement by
NVLAP, NIST, or any agency of the Federal Government.

Rogers Labs, Inc.
4405 W. 259th Terrace
Louisburg, KS 66053
Phone/Fax: (913) 837-3214
Revision 1

Mikrotikls SIA
Model: RBcAP2nD
Test #: 160714
Test to: 47CFR 15.247, RSS-247
File: Mikrotikls RBcAP2nD TstRpt 160714 r2

S/N: 69FE01DC4C2C/611
FCC ID#: TV7RBCM2ND
IC: 7442A-CM2ND
Date: August 8, 2016
Page 2 of 53



NVLAP Lab Code 200087-0

Table Of Contents

TABLE OF CONTENTS..... 3

REVISIONS..... 5

FORWARD 6

OPINION / INTERPRETATION OF RESULTS 6

EQUIPMENT TESTED..... 6

EQUIPMENT FUNCTION AND CONFIGURATION..... 7

Equipment Configuration.....7

APPLICANT COMPANY INFORMATION 8

Equipment information8

Product Details9

Accessories9

Table for Filed Antennas10

Table for Carrier Frequencies10

Table for Test Modes11

Test Result of Occupied Bandwidth12

APPLICATION FOR CERTIFICATION..... 13

APPLICABLE STANDARDS & TEST PROCEDURES 14

EQUIPMENT TESTING PROCEDURES 14

AC Line Conducted Emission Test Procedure14

Radiated Emission Test Procedure.....14

 Diagram 1 Test arrangement for Conducted emissions 15

 Diagram 2 Test arrangement for radiated emissions of tabletop equipment..... 16

 Diagram 3 Test arrangement for radiated emissions tested on Open Area Test Site (OATS) 17

TEST SITE LOCATIONS 17

LIST OF TEST EQUIPMENT 18

UNITS OF MEASUREMENTS 19

Rogers Labs, Inc.
4405 W. 259th Terrace
Louisburg, KS 66053
Phone/Fax: (913) 837-3214
Revision 1

Mikrotikls SIA
Model: RBcAP2nD
Test #: 160714
Test to: 47CFR 15.247, RSS-247
File: Mikrotikls RBcAP2nD TstRpt 160714 r2

S/N: 69FE01DC4C2C/611
FCC ID#: TV7RBCM2ND
IC: 7442A-CM2ND
Date: August 8, 2016
Page 3 of 53

ENVIRONMENTAL CONDITIONS..... 19

INTENTIONAL RADIATORS..... 19

Antenna Requirements19

Restricted Bands of Operation.....19

Table 1 General Radiated Emissions in Restricted Bands Data (20 MHz Channel, worst-case)20

Table 2 General Radiated Emissions in Restricted Bands Data (40 MHz Channel, worst-case)21

Summary of Results for Radiated Emissions in Restricted Bands21

AC Line Conducted Emissions Procedure22

Figure 1 AC Line Conducted Emissions Line 123

Figure 2 AC Line Conducted Emissions Line 223

Table 3 AC Line Conducted Emissions Data (Highest Emissions Line L1)24

Table 4 AC Line Conducted Emissions Data (Highest Emissions Line L2)24

Summary of Results for AC Line Conducted Emissions24

General Radiated Emissions Procedure.....25

Table 5 General Radiated Emissions from EUT Data (Highest Emissions)26

Summary of Results for General Radiated Emissions26

Operation in the 2400-2483.5 MHz Frequency Band.....27

Figure 3 Plot of Transmitter Emissions (Across Operational Band 802.11b, Chain 0)28

Figure 4 Plot of Transmitter Emissions (Across Operational Band, 802.11g, Chain 0)28

Figure 5 Plot of Transmitter Emissions (Across Operational Band, 802.11n (20), Chain 0)29

Figure 6 Plot of Transmitter Emissions (Across Operational Band, 802.11n (40), Chain 0)29

Figure 7 Plot of Transmitter Low Band Edge (802.11b, Chain 0).....30

Figure 8 Plot of Transmitter Low Band Edge (802.11g, Chain 0).....30

Figure 9 Plot of Transmitter Low Band Edge (802.11n (20), Chain 0)31

Figure 10 Plot of Transmitter Low Band Edge (802.11n (40), Chain 0)31

Figure 11 Plot of Transmitter High Band Edge (802.11b, Chain 0)32

Figure 12 Plot of Transmitter High Band Edge (802.11g, Chain 0)32

Figure 13 Plot of Transmitter High Band Edge (802.11n (20), Chain 0)33

Figure 14 Plot of Transmitter High Band Edge (802.11n (40), Chain 0)33

Figure 15 Plot of Transmitter 6-dB Occupied Band Width (802.11b, Chain 0)34

Figure 16 Plot of Transmitter 6-dB Occupied Band Width (802.11g, Chain 0)34

Figure 17 Plot of Transmitter 6-dB Occupied Band Width (802.11n (20), Chain 0)35

Figure 18 Plot of Transmitter 6-dB Occupied Band Width (802.11n (40), Chain 0)35

Figure 19 Plot of Transmitter Emissions (Across Operational Band 802.11b, Chain 1)36

Figure 20 Plot of Transmitter Emissions (Across Operational Band, 802.11g, Chain 0136

Figure 21 Plot of Transmitter Emissions (Across Operational Band, 802.11n (20), Chain 1)37

Figure 22 Plot of Transmitter Emissions (Across Operational Band, 802.11n (40), Chain 1)37

Figure 23 Plot of Transmitter Low Band Edge (802.11b, Chain 1).....38

Figure 24 Plot of Transmitter Low Band Edge (802.11g, Chain 1).....38

Figure 25 Plot of Transmitter Low Band Edge (802.11n (20), Chain 1) 39

Figure 26 Plot of Transmitter Low Band Edge (802.11n (40), Chain 1) 39

Figure 27 Plot of Transmitter High Band Edge (802.11b, Chain 1) 40

Figure 28 Plot of Transmitter High Band Edge (802.11g, Chain 1) 40

Figure 29 Plot of Transmitter High Band Edge (802.11n (20), Chain 1) 41

Figure 30 Plot of Transmitter High Band Edge (802.11n (40), Chain 1) 41

Figure 31 Plot of Transmitter 6-dB Occupied Band Width (802.11b, Chain 1) 42

Figure 32 Plot of Transmitter 6-dB Occupied Band Width (802.11g, Chain 1) 42

Figure 33 Plot of Transmitter 6-dB Occupied Band Width (802.11n (20), Chain 1) 43

Figure 34 Plot of Transmitter 6-dB Occupied Band Width (802.11n (40), Chain 1) 43

Transmitter Emissions Data..... 44

Table 6 Transmitter Power and Emissions 44

Table 7 Transmitter Radiated Emissions (20 MHz Channel, Worst-case) 45

Table 8 Transmitter Radiated Emissions (40 MHz Channel, Worst-case) 46

Summary of Results for Transmitter Radiated Emissions of Intentional Radiator 47

STATEMENT OF MODIFICATIONS AND DEVIATIONS 47

ANNEX..... 48

Annex A Measurement Uncertainty Calculations..... 49

Annex B Rogers Labs Test Equipment List..... 50

Annex C Rogers Qualifications 51

Annex D FCC Site Registration Letter..... 52

Annex E Industry Canada Site Registration Letter 53

Revisions

Revision 2 Issued August 8, 2016 – corrected KDB reference, added MiMo information page 9

Revision 1 Issued August 3, 2016

Forward

The following information is submitted for consideration in obtaining Grant of Certification for License Exempt Digital Transmission System Intentional Radiator operating under 47CFR Paragraph 15.247 and RSS-247 Issue 1 Digital Modulation transmitter operation in the 2412-2462 MHz band.

Name of Applicant: Mikrotiks SIA FRN: 0014 43 1100
 Pernavas 46 Str.
 Riga LV-1009 Latvia

Model: RBcAP2nD

FCC ID: TV7RBCM2ND IC: 7442A-CM2ND

Frequency Range: 2412-2462 MHz (802.11b/g/n mode operation), 2422-2452 MHz (802.11n 40 MHz channel operation)

Total Operating Power: average power 0.025 watts per chain, OBW 16,720 or 36,000 kHz

Opinion / Interpretation of Results

Tests Performed	Margin (dB)	Results
Restricted Frequency Bands 15.205, RSS-GEN 8.10	-0.3	Complies
AC Line Conducted 15.207, RSS-GEN 7.2.4	-8.4	Complies
Radiated Emissions 15.209, RSS-GEN 7.2.5	-3.1	Complies
Harmonic Emissions per 15.247, RSS-247	-0.4	Complies
Peak Power Spectral Density per 15.247, RSS-247	-12.5	Complies

Equipment Tested

<u>Equipment</u>	<u>Model</u>	<u>FCC I.D.</u>
EUT	RBcAP2nD	TV7RBCM2ND
AC Adapter	FLD301-240120-U	N/A
Power Adapter	POE	N/A
Dell Studio XPS	921LBN1	N/A

Test results in this report relate only to the items tested.

Equipment Function and Configuration

The EUT is a 2412-2462 MHz 2x2 MiMo Digital Transmission System used to transmit data in applications offering broadband wireless connectivity. The design utilizes internal fixed antenna system and offers no provision for antenna replacement or modification. The system provides two transmitter chains and may operate in a 2x2 MiMo configuration. The equipment is marketed for use to provide a wireless link to exchange data information from one point to another. For testing purposes, the EUT was connected to the manufacturer supplied AC/DC supply and POE adapter, and communicating to the laptop computer through Ethernet network interface. This configuration provided operational control of the EUT and communications over the network interface between the EUT and supporting computer system. No other interfacing options are provided. For testing purposes, the RBcAP2nD received power from the manufacturer provided AC/DC power adapter and was configured to transmit in available data modes during testing with worst-case data presented. The antenna system complies with requirements for unique antenna connection port.

Equipment Configuration

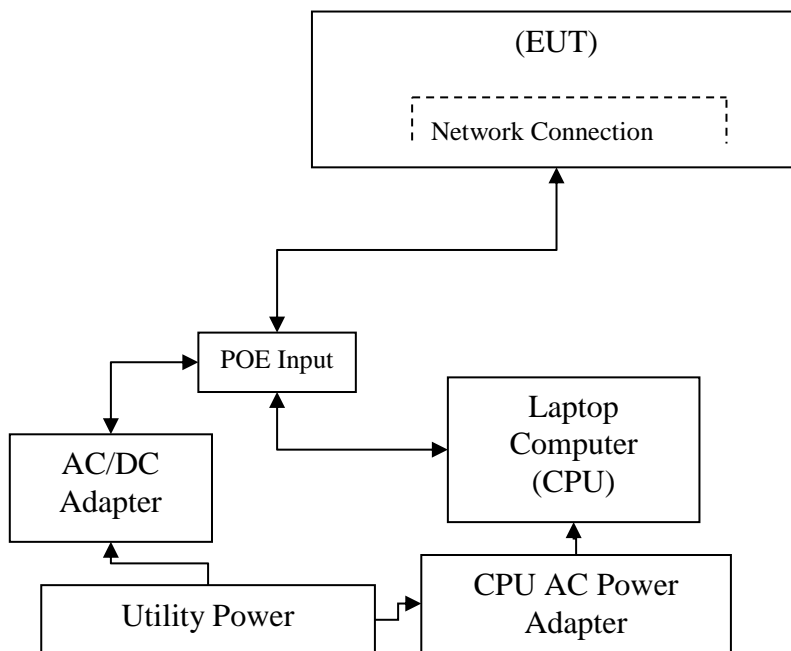

Applicant Company information

Applicants Company	MikroTik (“Mikrotīkls, SIA”)
Applicants Address	Pernavas 46 Str., Riga LV-1009 Latvia
FCC Identifier	TV7RBCM2ND
Industry Canada Identifier	7442A-CM2ND
Manufacturer Company	MikroTik (“Mikrotīkls, SIA”)
Manufacturer Address	Pernavas 46 Str., Riga LV-1009 Latvia

Equipment information

<p>Product Marketing Name (PMN) :</p> <p>The PMN is the name or model number under which the product will be marketed/offered for sale in Canada. If the product has PMN, it must be provided.</p>	cAP
<p>Unique Product Number (UPN):</p> <p>The applicant, made up of a maximum of 11 alphanumeric characters (A-Z, 0-9), assigns the UPN.</p>	CM2ND
<p>Hardware Version Identification Number (HVIN):</p> <p>The HVIN identifies hardware specifications of a product version. The HVIN replaces the ISED Model Number in the legacy E-filing System. An HVIN is required for all products for certification applications.</p>	RBcAP2nD
<p>Host Marketing Name (HMN) (if applicable):</p> <p>The HMN is the name or model number of a final product, which contains a certified radio module.</p>	n/a
Brand Name	cAP
Model Number	RBcAP2nD
Test Rule Part(s)	47CFR PART 15C 15.247, RSS-247,
Test Frequency Range	2,400 – 2,483.5 MHz
Project Number	160714
Submission Type	Certification

Product Details

Items	Description
Product Type	WLAN [2x2 MIMO, (2TX, 2RX)]
Radio Type	Transceiver
Power Type	External Power Supply and POE adapter
Modulation	IEE 802.11 b/g/n see the below table
Data Modulation	IEEE 802.11 g/n: OFDM (BPSK/QPSK/16QAM/64QAM) IEEE 802.11 b: DSSS
Data Rate (Mbps)	IEEE 802.11a/g: OFDM (6/9/12/18/24/36/48/54) IEEE 802.11n/ac: see the below table IEEE 802.11b: (1/2/2s/5/5s/11/11s)
Frequency Range	2400-2483.5 MHz
Channel Number	802.11b: 11 for 20MHz Channels 802.11g/n: 11 for 20MHz Channels; 5 for 40MHz Channels
Channel Band Width (99%)	802.11 b: 13,680 kHz 802.11 g: 16,600 kHz 802.11 n (HT-20): 16,720 kHz 802.11 n (HT-40): 36,000 kHz
Maximum Conducted Output Power	IEEE 802.11b: 12.56 dBm per chain IEEE 802.11g: 13.90 dBm per chain IEEE 802.11n (20): 13.88 dBm per chain IEEE 802.11n (40): 11.75 dBm per chain
Carrier Frequencies	Please refer to Table for Carrier Frequencies
Antenna	Internal PIFA
Communication Mode	Device is operating in a 2x2 Spatial Multiplexing MIMO configuration. The design utilizes Multiple-Input-Multiple-Output (MIMO) operational capability. The design may be configured to transmit on both chains same time or chosen single chain (without automatic switching between chains). The unit may receive on single or both chains and may transmit on single or both chains. Configuration could be (1tx, 1rx); (1tx, 2rx); (2tx, 1rx); (2tx, 2rx). Design provides transmitting on both chains at same time to cross-polarized antennas.
Beamforming Function	Without beamforming
Operating Mode	Indoor use

Accessories

AC Power Adapter	FLD301-240120-U
Power Over Ethernet (POE) adapter	POE

Table for Filed Antennas

Ant.	Brand	Model Name	P/N	Antenna Type	Connector	Gain (dBi)	
						2.4GHZ	5GHZ
1	Mikrotikls	-		PIF		2dBi	
2							

Table for Carrier Frequencies

There are two bandwidth systems:

Frequency Band	Channel No.	Frequency	Channel No.	Frequency
2400-2483.5 MHz	1	2412MHZ	7	2442MHZ
	2	2417MHZ	8	2447MHZ
	3	2422MHZ	9	2452MHZ
	4	2427MHZ	10	2457MHZ
	5	2432MHZ	11	2462MHZ
	6	2437MHZ	-	-

For 20MHz bandwidth systems, use Channel 1,6,11, 36, 40, 44, 48, 149, 153, 157, 161, 165.

For 40MHz bandwidth systems, use Channel 38, 46, 151, 159.

Frequency Band	Channel No.	Frequency	Channel No.	Frequency
2400-2483.5MHz	1	2412	2	2422
	6	2437	7	2447
	11	2462	10	2452

Table for Test Modes

Preliminary tests were performed in different data rates to define the worst radiated emission. The data rate shown in the table below is the worst-case rate with respect to the specific test item. Investigation has been done on all possible configurations while searching the worst cases. The following table is a list of the test modes investigated for this report.

Test Items	Mode	Data Rate	Channel	Chain
Max. Conducted Output Power	802.11b	11	1,6,11	1,2
	802.11g	54	1,6,11	1,2
	802.11n HT20	65	1,6,11	1,2
	802.11n HT40	135	2,7,10	1,2
Power Spectral Density	802.11b		1,6,11	1,2
	802.11g		1,6,11	1,2
	802.11n HT20		1,6,11	1,2
	802.11n HT40		2,7,10	1,2
26dB, 99% Occupied Bandwidth Measurement	802.11b		1,6,11	1,2
	802.11g		1,6,11	1,2
	802.11n HT20		1,6,11	1,2
	802.11n HT40		2,7,10	1,2
6dB Spectrum Bandwidth Measurement	802.11b		1,6,11	1,2
	802.11g		1,6,11	1,2
	802.11n HT20		1,6,11	1,2
	802.11n HT40		2,7,10	1,2
Radiated Emission Below 1GHz		-	-	-
Radiated Emission Above 1GHz	802.11b/g/n			1,2
Band Edge Emission	802.11b			
	802.11g			
	802.11n HT20			
	802.11n HT40			

Test Result of Occupied Bandwidth

Mode	Frequency	26dB Bandwidth (MHz)	6dB Bandwidth (MHz)	99% Occupied Bandwidth (MHz)
802.11b	2412 MHz	N/A	10,275 kHz	14,160 kHz
	2437 MHz	N/A	10,275 kHz	14,160 kHz
	2462 MHz	N/A	10,275 kHz	14,160 kHz
802.11g	2412 MHz	N/A	15,720 kHz	16,600 kHz
	2437 MHz	N/A	15,720 kHz	16,600 kHz
	2462 MHz	N/A	15,720 kHz	16,600 kHz
802.11n (HT20)	2412 MHz	N/A	15,640 kHz	16,720 kHz
	2437 MHz	N/A	15,640 kHz	16,720 kHz
	2462 MHz	N/A	15,640 kHz	16,720 kHz
802.11n (HT40)	2422 MHz	N/A	33,375 kHz	36,000 kHz
	2447 MHz	N/A	33,375 kHz	36,000 kHz
	2452 MHz	N/A	33,375 kHz	36,000 kHz

Application for Certification

- (1) Manufacturer: Mikrotikls SIA
Pernavas 46 Str.
Riga LV-1009 Latvia
- (2) Identification: Model: RBcAP2nD
FCC I.D.: TV7RBCM2ND IC: 7442A-CM2ND
- (3) Instruction Book:
Refer to Exhibit for Instruction Manual.
- (4) Description of Circuit Functions:
Refer to Exhibit of Operational Description.
- (5) Block Diagram with Frequencies:
Refer to Exhibit of Operational Description.
- (6) Report of Measurements:
Report of measurements follows in this Report.
- (7) Photographs: Construction, Component Placement, etc.:
Refer to Exhibit for photographs of equipment.
- (8) List of Peripheral Equipment Necessary for operation. The equipment operates from power received from authorized AC/DC power adapter. The EUT provides a single Ethernet connection ports for communications and power. During testing, the EUT was powered from AC/DC power supply, POE, and connected to CPU through network cable.
- (9) Transition Provisions of 47CFR 15.37 are not requested
- (10) Not Applicable. The unit is not a scanning receiver.
- (11) Not Applicable. The EUT does not operate in the 59 – 64 GHz frequency band.
- (12) The equipment is not software defined and this section is not applicable.
- (13) Applications for certification of U-NII devices in the 5.15-5.35 GHz and the 5.47-5.85 GHz bands must include a high-level operational description of the security procedures that control the radio frequency operating parameters and ensure that unauthorized modifications cannot be made. Not applicable to this filing.
- (14) Contain at least one drawing or photograph showing the test set-up for each of the required types of tests applicable to the device for which certification is requested. These drawings or photographs must show enough detail to confirm other information contained in the test report. Any photographs used must be focused originals without glare or dark spots and must clearly show the test configuration used. This information is provide in this report and Test Setup Exhibits provided with the application filing.

Applicable Standards & Test Procedures

The following information is submitted in accordance 47CFR dated October 1, 2015, Part 2, Subpart J, Paragraphs 2.907, 2.911, 2.913, 2.925, 2.926, 2.1031 through 2.1057, and applicable parts of paragraph 15, Part 15C Paragraph 15.247 and Industry Canada RSS-247. Test procedures used are the established Methods of Measurement of Radio-Noise Emissions as described in ANSI C63.10-2013, KDB 558074 D01 v03r05, KDB 662911 D02 v01, RSS-247 Issue 1, and RSS-GEN Issue 4, the following information is submitted for processing application for Certification.

Equipment Testing Procedures

AC Line Conducted Emission Test Procedure

Testing for the AC line-conducted emissions was performed as defined in ANSI C63.10-2013. The test setup, including the EUT, was arranged in the test configurations as presented during testing. The test configuration was placed on a 1 x 1.5-meter wooden bench, 0.8 meters high located in a screen room. The power lines of the system were isolated from the power source using a standard LISN with a 50- μ Hy choke. EMI was coupled to the spectrum analyzer through a 0.1 μ F capacitor internal to the LISN. The LISN was positioned on the floor beneath the wooden bench supporting the EUT. The power lines and cables were draped over the back edge of the table. Refer to diagram one showing typical test arrangement and photographs in exhibits for EUT placement used during testing.

Radiated Emission Test Procedure

Radiated emission testing was performed as required and specified in ANSI C63.10-2013 and referenced KDB documents. The EUT was placed on a rotating 0.9 x 1.2-meter platform, elevated as required above the ground plane at a distance of 3 meters from the FSM antenna. The table permitted orientation of the EUT in each of three orthogonal axis positions during testing. EMI energy was maximized by equipment placement, raising and lowering the FSM antenna, changing the antenna polarization, and by rotating the turntable. Each emission was maximized before data was taken using a spectrum analyzer. The frequency spectrum from 9 kHz to 25,000 MHz was searched for during preliminary investigation. Refer to diagrams two and three showing typical test arrangement and photographs in the test setup exhibits for specific EUT placement during testing.

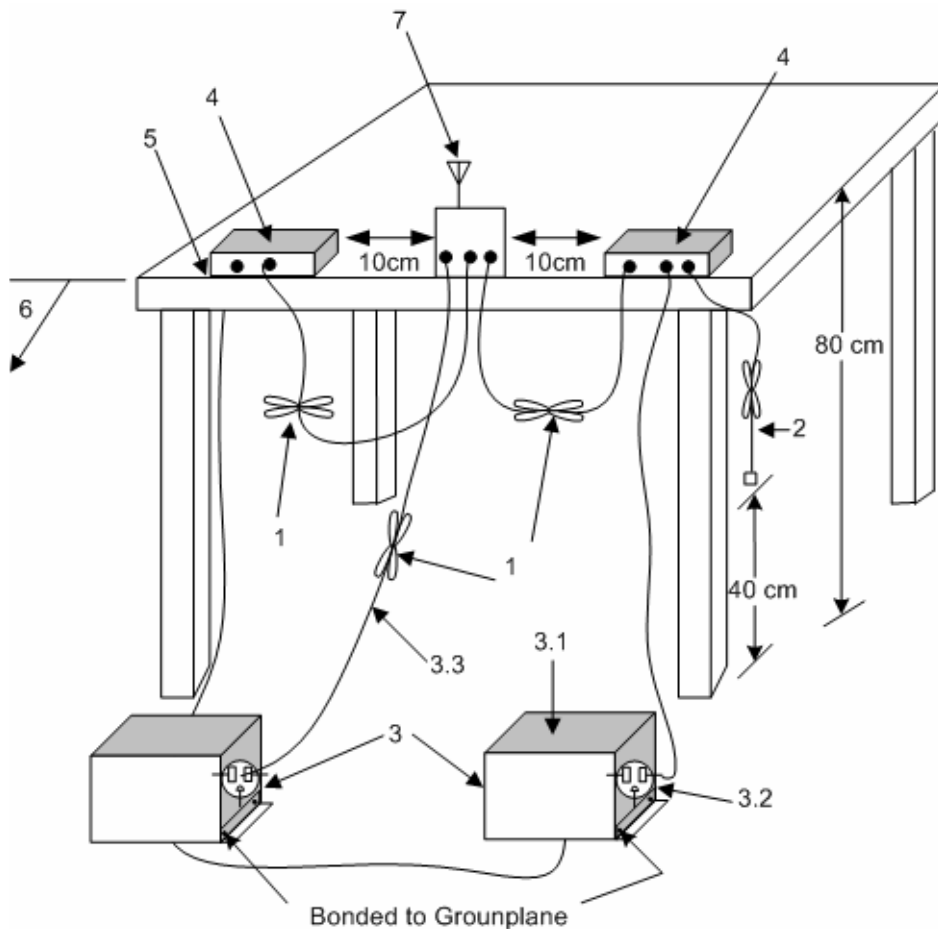

1. Interconnecting cables that hang closer than 40 cm to the ground plane shall be folded back and forth in the center forming a bundle 30 cm to 40 cm long see (see 6.2.3.2).
2. The I/O cables that are not connected to an accessory shall be bundled in the center. The end of the cable may be terminated, if required, using the correct terminating impedance. The overall length shall not exceed 1 m (see 6.2.2).
3. EUT connected to one LISN. Unused LISN measuring port connectors shall be terminated in 50 Ω loads. LISN may be placed on top of, or immediately beneath, reference ground plane (see 6.2.2 and 6.2.3).
 - 3.1 All other equipment powered from additional LISN(s).
 - 3.2 Multiple-outlet strip can be used for multiple power cords of non-EUT equipment.
 - 3.3 LISN at least 80 cm from nearest part of EUT chassis
4. Non-EUT components of EUT system being tested
5. Rear of EUT, including peripherals, shall all be aligned and flush with edge of tabletop (see 6.2.3.2).
6. Edge of tabletop shall be 40 cm removed from a vertical conducting plane that is bonded to the ground plane (see 6.2.2 for options).
7. Antenna may be integral or detachable. If detachable, the antenna shall be attached for this test.

Diagram 1 Test arrangement for Conducted emissions

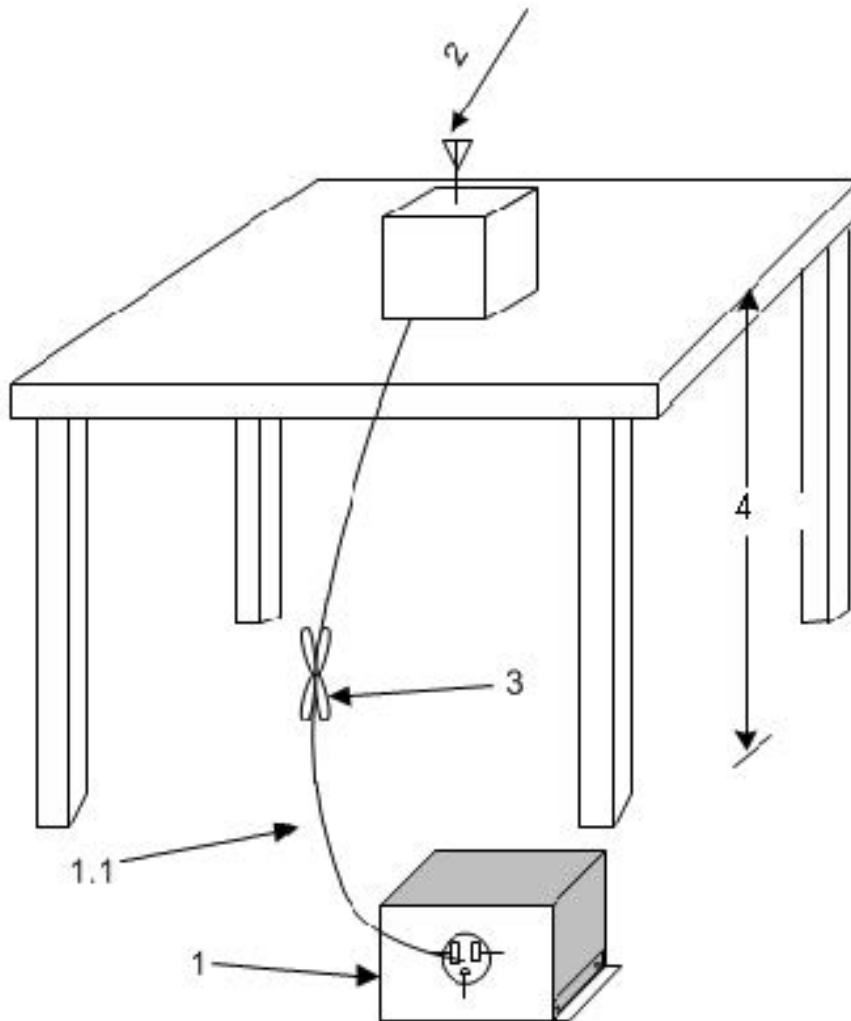

1. A LISN is optional for radiated measurements between 30 MHz and 1000 MHz but not allowed for measurements below 30 MHz and above 1000 MHz (see 6.3.1). If used, then connect EUT to one LISN. Unused LISN measuring port connectors shall be terminated in 50 Ω loads. The LISN may be placed on top of, or immediately beneath, the reference ground plane (see 6.2.2 and 6.2.3.2).
 - 1.1 LISN spaced at least 80 cm from nearest part of EUT chassis.
2. Antenna can be integral or detachable, depending on the EUT (see 6.3.1).
3. Interconnecting cables that hang closer than 40 cm to the ground plane shall be folded back and forth in the center forming a bundle 30 cm to 40 cm long (see 6.3.1).
4. For emission measurements at or below 1 GHz, the table height shall be 80 cm. For emission measurements above 1 GHz, the table height shall be 1.5 m for measurements, except as otherwise specified (see 6.3.1 and 6.6.3.1).

Diagram 2 Test arrangement for radiated emissions of tabletop equipment

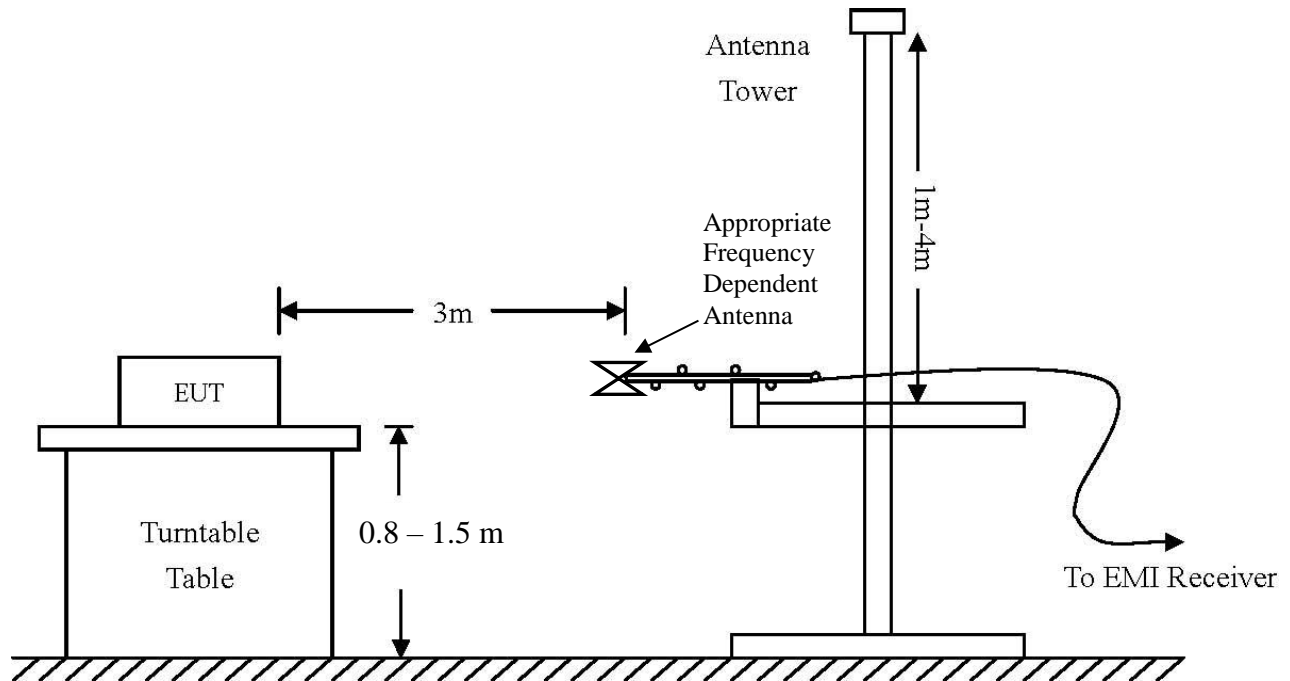

Frequency: 9 kHz-30 MHz	Frequency: 30 MHz- 1 GHZ	Frequency: Above 1 GHz
Loop Antenna	Broadband Biconilog	Horn
RBW = 9 kHz	RBW = 120 kHz	RBW = 1 MHz
VBW = 30 kHz	VBW = 120 kHz	VBW = 1 MHz
Sweep time = Auto	Sweep time = Auto	Sweep time = Auto
Detector = PK, QP	Detector = PK, QP	Detector = PK, AV
Antenna Height 1m	Antenna Height 1-4m	Antenna Height 1-4m

Diagram 3 Test arrangement for radiated emissions tested on Open Area Test Site (OATS)

Test Site Locations

- Conducted EMI The AC power line conducted emissions testing performed in a shielded screen room located at Rogers Labs, Inc., 4405 W. 259th Terrace, Louisburg, KS
- Radiated EMI The radiated emissions tests were performed at the 3 meters, Open Area Test Site (OATS) located at Rogers Labs, Inc., 4405 W. 259th Terrace, Louisburg, KS
- Site Registration Refer to Annex for Site Registration Letters
- NVLAP Accreditation Lab code 200087-0

List of Test Equipment

A Rohde and Schwarz ESU40 and/or Hewlett Packard 8591EM was used as the measuring device for the emissions testing of frequencies below 1 GHz. A Rohde and Schwarz ESU40 and/or Hewlett Packard 8562A Spectrum Analyzer was used as the measuring device for testing the emissions at frequencies above 1 GHz. The analyzer settings used are described in the following table. Refer to the appendix for a complete list of test equipment.

AC Line Conducted Emissions (0.150 -30 MHz)		
RBW	AVG. BW	Detector Function
9 kHz	30 kHz	Peak / Quasi Peak
Emissions (30-1000 MHz)		
RBW	AVG. BW	Detector Function
120 kHz	300 kHz	Peak / Quasi Peak
Emissions (Above 1000 MHz)		
RBW	Video BW	Detector Function
100 kHz	100 kHz	Peak
1 MHz	1 MHz	Peak / Average

<input checked="" type="checkbox"/>	LISN	FCC	FCC-LISN-50-2-10(1PA) (160611)	.15-30MHz	5/16	5/17
<input checked="" type="checkbox"/>	Cable	Time Microwave	750HF290-750 (L10M)	9kHz-40 GHz	10/15	10/16
<input checked="" type="checkbox"/>	Cable	Belden	RG-58 (L1-CAT3-11509)	9kHz-30 MHz	10/15	10/16
<input checked="" type="checkbox"/>	Cable	Belden	RG-58 (L2-CAT3-11509)	9kHz-30 MHz	10/15	10/16
<input type="checkbox"/>	Antenna	ARA	BCD-235-B (169)	20-350MHz	10/15	10/16
<input type="checkbox"/>	Antenna	EMCO	3147 (40582)	200-1000MHz	10/15	10/16
<input checked="" type="checkbox"/>	Antenna	ETS-Lindgren	3117 (200389)	1-18 GHz	5/16	5/18
<input type="checkbox"/>	Antenna	Com Power	AH-118 (10110)	1-18 GHz	10/15	10/16
<input checked="" type="checkbox"/>	Antenna	Com Power	AH-840 (101046)	18-40 GHz	5/16	5/18
<input checked="" type="checkbox"/>	Antenna	EMCO	6509 (9502-1374)	.001-30 MHz	10/15	10/16
<input checked="" type="checkbox"/>	Antenna	Sunol	JB-6 (A100709)	30-1000 MHz	10/15	10/16
<input type="checkbox"/>	Antenna	EMCO	3143 (9607-1277)	20-1200 MHz	5/16	5/17
<input type="checkbox"/>	Analyzer	HP	8591EM (3628A00871)	9kHz-1.8GHz	5/16	5/17
<input type="checkbox"/>	Analyzer	HP	8562A (3051A05950)	9kHz-110GHz	5/16	5/17
<input type="checkbox"/>	Analyzer	HP External Mixers	11571, 11970	25GHz-110GHz	5/16	5/17
<input checked="" type="checkbox"/>	Analyzer	Rohde & Schwarz	ESU40 (100108)	20Hz-40GHz	5/16	5/17
<input checked="" type="checkbox"/>	Amplifier	Com-Power	PA-010 (171003)	100Hz-30MHz	10/15	10/16
<input checked="" type="checkbox"/>	Amplifier	Com-Power	CPPA-102 (01254)	1-1000 MHz	10/15	10/16
<input checked="" type="checkbox"/>	Amplifier	Com-Power	PAM-118A (551014)	0.5-18 GHz	10/15	10/16

Rogers Labs, Inc.
4405 W. 259th Terrace
Louisburg, KS 66053

Phone/Fax: (913) 837-3214

Revision 1

Mikrotikls SIA
Model: RBcAP2nD
Test #: 160714

Test to: 47CFR 15.247, RSS-247

File: Mikrotikls RBcAP2nD TstRpt 160714 r2

S/N: 69FE01DC4C2C/611
FCC ID#: TV7RBCM2ND
IC: 7442A-CM2ND

Date: August 8, 2016

Page 18 of 53

Units of Measurements

Conducted EMI Data is in dB μ V; dB referenced to one microvolt

Radiated EMI Data is in dB μ V/m; dB/m referenced to one microvolt per meter

Sample Calculation:

RFS = Radiated Field Strength, FSM = Field Strength Measured
 A.F. = Receive antenna factor, Gain = amplification gains and/or cable losses
 $RFS (dB\mu V/m @ 3m) = FSM (dB\mu V) + A.F. (dB) - Gain (dB)$

Environmental Conditions

Ambient Temperature	23.1° C
Relative Humidity	48%
Atmospheric Pressure	1016.1 mb

Intentional Radiators

As per 47CFR part 15 subpart C, and Industry Canada RSS-247, Issue 1, the following information is submitted for consideration and demonstration of compliance with regulation and standards.

Antenna Requirements

The EUT incorporates integral antenna system and offers no provision for connection to alternate system. The EUT utilizes permanently attached antennas mounted to the printed circuit board. The antenna connection point complies with the unique antenna connection requirements. The antenna connection point complies with the unique antenna connection requirements. The requirements of 15.203 are fulfilled there are no deviations or exceptions to the specification.

Restricted Bands of Operation

Spurious emissions falling in the restricted frequency bands of operation were measured at the on the OATS. The EUT utilizes frequency, determining circuitry, which generates harmonics falling in restricted bands. Emissions were investigated at the antenna port and OATS, using appropriate antennas or pyramidal horns, amplification stages, and spectrum analyzer. Peak and average amplitudes of frequencies above 1000 MHz were compared to the required limits with worst-case data presented below. Test procedures of ANSI C63.10-2013 were used during testing. No other significant emission was observed which fell into the restricted bands of operation. Computed radiated emission values take into account the measured radiated field strength, receive antenna correction factor, amplifier gain stage, and test system cable losses.

Table 1 General Radiated Emissions in Restricted Bands Data (20 MHz Channel, worst-case)

Frequency in MHz	Horizontal Peak (dBµV/m)	Horizontal Quasi-Peak (dBµV/m)	Horizontal Average (dBµV/m)	Vertical Peak (dBµV/m)	Vertical Quasi-Peak (dBµV/m)	Vertical Average (dBµV/m)	Limit @ 3m (dBµV/m)
2390.0	52.7	N/A	37.8	51.6	N/A	35.9	54.0
2483.5	50.9	N/A	37.7	49.4	N/A	37.3	54.0
4824.0	55.0	N/A	52.5	50.7	N/A	47.9	54.0
4874.0	55.9	N/A	53.6	54.1	N/A	51.3	54.0
4924.0	54.0	N/A	53.3	55.8	N/A	53.3	54.0
7236.0	46.7	N/A	33.4	46.2	N/A	33.3	54.0
7311.0	46.2	N/A	33.5	45.5	N/A	32.8	54.0
7386.0	54.0	N/A	34.1	46.4	N/A	33.4	54.0
12060.0	50.6	N/A	37.4	50.3	N/A	37.4	54.0
12185.0	49.9	N/A	37.3	50.5	N/A	37.5	54.0
12310.0	49.9	N/A	37.1	49.8	N/A	37.0	54.0
14472.0	51.3	N/A	38.7	51.7	N/A	38.7	54.0

Other emissions present had amplitudes at least 20 dB below the limit. Peak and Quasi-Peak amplitude emissions are recorded above for frequency range below 1000 MHz. Peak and Average amplitude emissions are recorded above for frequency range above 1000 MHz.

Table 2 General Radiated Emissions in Restricted Bands Data (40 MHz Channel, worst-case)

Frequency in MHz	Horizontal Peak (dBμV/m)	Horizontal Quasi-Peak (dBμV/m)	Horizontal Average (dBμV/m)	Vertical Peak (dBμV/m)	Vertical Quasi-Peak (dBμV/m)	Vertical Average (dBμV/m)	Limit @ 3m (dBμV/m)
2390.0	71.8	N/A	53.7	68.1	N/A	50.9	54.0
2483.5	62.9	N/A	47.0	63.5	N/A	46.9	54.0
4844.0	46.4	N/A	32.7	44.8	N/A	31.9	54.0
4894.0	44.8	N/A	31.7	41.9	N/A	31.5	54.0
4904.0	44.8	N/A	16.6	16.1	N/A	31.4	54.0
7266.0	46.3	N/A	33.0	45.3	N/A	33.0	54.0
7341.0	46.1	N/A	33.3	46.2	N/A	33.2	54.0
7356.0	45.9	N/A	16.6	16.1	N/A	33.0	54.0
12110.0	50.1	N/A	37.1	50.5	N/A	37.2	54.0
12235.0	50.3	N/A	36.9	50.1	N/A	36.9	54.0
12260.0	50.1	N/A	37.3	51.0	N/A	37.3	54.0
14532.0	51.8	N/A	38.7	51.6	N/A	38.8	54.0

Other emissions present had amplitudes at least 20 dB below the limit. Peak and Quasi-Peak amplitude emissions are recorded above for frequency range below 1000 MHz. Peak and Average amplitude emissions are recorded above for frequency range above 1000 MHz.

Summary of Results for Radiated Emissions in Restricted Bands

The EUT demonstrated compliance with the emissions requirements of 47CFR 15.205, RSS-GEN and RSS-247, Issue 1 Intentional Radiators. The EUT provided a worst-case minimum margin of -0.3 dB below the emissions requirements in restricted frequency bands. Peak, Quasi-peak, and average amplitudes were checked for compliance with the regulations. Worst-case emissions are reported with other emissions found in the restricted frequency bands at least 20 dB below the requirements.

AC Line Conducted Emissions Procedure

The EUT was arranged in a typical equipment configuration and placed on a 1 x 1.5-meter wooden bench 80 cm above the conducting ground plane, floor of a screen room. The bench was positioned 40 cm away from the wall of the screen room. The LISN was positioned on the floor of the screen room 80-cm from the rear of the EUT. Testing for the line-conducted emissions were the procedures of ANSI C63.10-2013 paragraph 6. The AC adapter for the EUT was connected to the LISN for line-conducted emissions testing. A second LISN was positioned on the floor of the screen room 80-cm from the rear of the supporting equipment of the EUT. All power cords except the EUT were then powered from the second LISN. EMI was coupled to the spectrum analyzer through a 0.1 μ F capacitor, internal to the LISN. Power line conducted emissions testing were carried out individually for each current carrying conductor of the EUT support equipment. The excess length of lead between the system and the LISN receptacle was folded back and forth to form a bundle not exceeding 40 cm in length. The screen room, conducting ground plane, analyzer, and LISN were bonded together to the protective earth ground. Preliminary testing was performed to identify the frequency of each emission displaying the highest amplitude. The cables were repositioned to obtain maximum amplitude of measured EMI level. Once the worst-case configuration was identified, plots were made of the EMI from 0.15 MHz to 30 MHz then the data was recorded with maximum conducted emissions levels. Refer to figures one and two for plots of the EUT support equipment AC Line Conducted emissions.

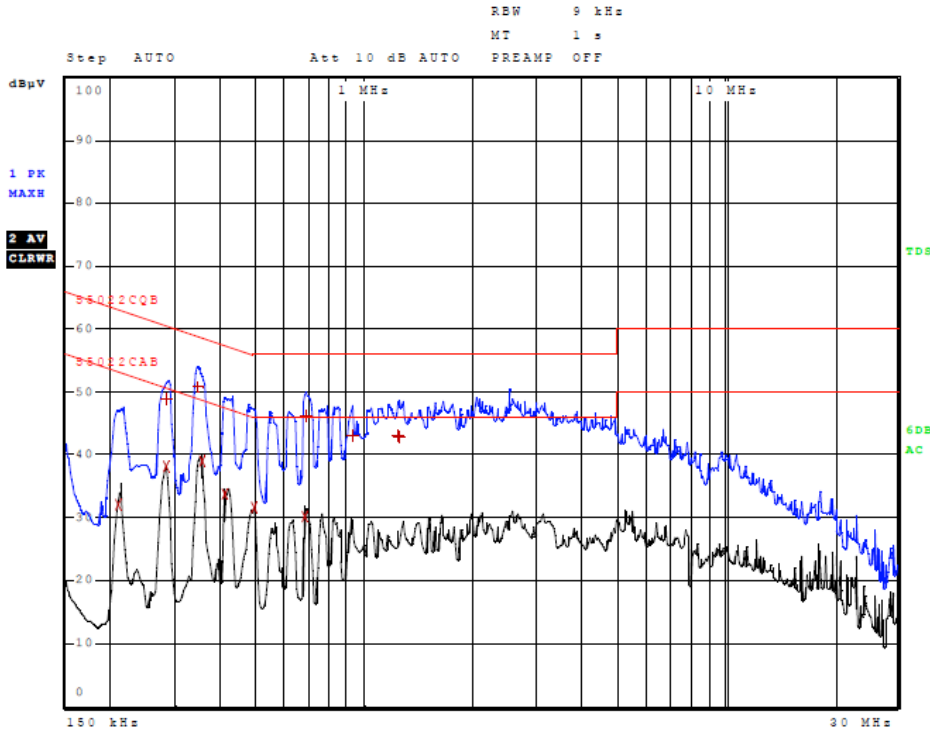

Figure 1 AC Line Conducted Emissions Line 1

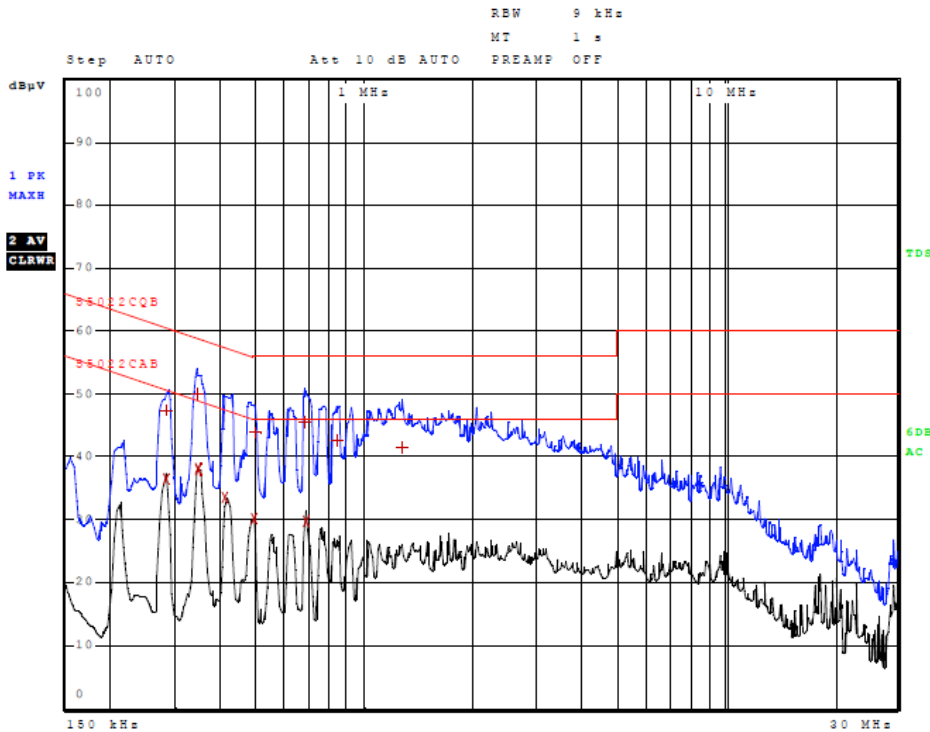

Figure 2 AC Line Conducted Emissions Line 2

Table 3 AC Line Conducted Emissions Data (Highest Emissions Line L1)

Trace	Frequency	Level (dBµV)	Detector	Delta Limit/dB
2	210.000000000 kHz	32.12	Average	-21.08
2	282.000000000 kHz	38.07	Average	-12.68
1	286.000000000 kHz	48.83	Quasi Peak	-11.81
1	346.000000000 kHz	50.65	Quasi Peak	-8.40
2	354.000000000 kHz	38.94	Average	-9.93
2	410.000000000 kHz	33.68	Average	-13.97
2	494.000000000 kHz	31.52	Average	-14.58
2	682.000000000 kHz	30.06	Average	-15.94
1	690.000000000 kHz	46.16	Quasi Peak	-9.84
1	930.000000000 kHz	42.96	Quasi Peak	-13.04
1	1.234000000 MHz	43.01	Quasi Peak	-12.99
1	1.254000000 MHz	42.85	Quasi Peak	-13.15

Other emissions present had amplitudes at least 20 dB below the limit.

Table 4 AC Line Conducted Emissions Data (Highest Emissions Line L2)

Trace	Frequency	Level (dBµV)	Detector	Delta Limit/dB
2	282.000000000 kHz	36.53	Average	-14.22
1	286.000000000 kHz	47.29	Quasi Peak	-13.34
1	342.000000000 kHz	49.90	Quasi Peak	-9.25
2	346.000000000 kHz	37.85	Average	-11.20
2	350.000000000 kHz	38.17	Average	-10.79
2	414.000000000 kHz	33.42	Average	-14.14
2	494.000000000 kHz	30.17	Average	-15.93
1	498.000000000 kHz	43.82	Quasi Peak	-12.21
1	682.000000000 kHz	45.58	Quasi Peak	-10.42
2	690.000000000 kHz	29.80	Average	-16.20
1	838.000000000 kHz	42.59	Quasi Peak	-13.41
1	1.266000000 MHz	41.51	Quasi Peak	-14.49

Other emissions present had amplitudes at least 20 dB below the limit.

Summary of Results for AC Line Conducted Emissions

The EUT test system demonstrated compliance to the conducted emissions requirements of 47CFR 15.207, RSS-247 Issue 1 and RSS-GEN. The EUT demonstrated minimum margin of -8.4 dB below the limit. Measurements were taken using the peak, quasi peak, and average, measurement function for each emissions amplitude and were below the limits stated in the specification. Other emissions were present with recorded data representing worst-case amplitudes.

General Radiated Emissions Procedure

The EUT was arranged in a typical equipment configuration and operated through all available modes with worst-case data recorded. Preliminary testing was performed in a screen room with the EUT positioned 1 meter from the FSM. Radiated emissions measurements were performed to identify the frequencies, which produced the highest emissions. Each radiated emission was then maximized at the OATS location before final radiated emissions measurements were performed. Final data was taken with the EUT located at the OATS at a distance of 3 meters between the EUT and the receiving antenna. The frequency spectrum from 9 kHz to 25,000 MHz was searched for general radiated emissions. Measured emission levels were maximized by EUT placement on the table, rotating the turntable through 360 degrees, varying the antenna height between 1 and 4 meters above the ground plane and changing antenna position between horizontal and vertical polarization. Antennas used were Loop from 9 kHz to 30 MHz, Broadband Biconical from 30 to 200 MHz, Biconilog from 30 to 1000 MHz, Log Periodic from 200 MHz to 1 GHz and or Double Ridge or pyramidal horns and mixers from 1 GHz to 25 GHz, notch filters, and appropriate amplifiers and external mixers were utilized.

Table 5 General Radiated Emissions from EUT Data (Highest Emissions)

Frequency in MHz	Horizontal Peak (dBµV/m)	Horizontal Quasi-Peak (dBµV/m)	Horizontal Average (dBµV/m)	Vertical Peak (dBµV/m)	Vertical Quasi-Peak (dBµV/m)	Vertical Average (dBµV/m)	Limit @ 3m (dBµV/m)
50.4	31.2	24.2	N/A	37.1	29.7	N/A	40.0
125.0	36.5	34.6	N/A	32.3	30.4	N/A	43.5
145.3	40.5	36.2	N/A	35.7	31.4	N/A	43.5
151.6	36.2	33.5	N/A	33.4	30.4	N/A	43.5
157.9	31.5	27.5	N/A	30.8	24.2	N/A	43.5
162.3	31.0	26.4	N/A	30.7	25.2	N/A	43.5
229.7	32.4	28.8	N/A	25.5	21.6	N/A	46.0
250.0	43.6	42.9	N/A	37.7	36.5	N/A	46.0

Other emissions present had amplitudes at least 20 dB below the limit. Peak and Quasi-Peak amplitude emissions are recorded above for frequency range below 1000 MHz. Peak and Average amplitude emissions are recorded above for frequency range above 1000 MHz.

Summary of Results for General Radiated Emissions

The EUT demonstrated compliance with the radiated emissions requirements of 47CFR part 15 and Industry Canada RSS-247 Issue 1 Intentional Radiators. The EUT demonstrated a minimum margin of -3.1 dB below the requirements. Other emissions were present with amplitudes at least 20 dB below the Limits.

Operation in the 2400-2483.5 MHz Frequency Band

Radiated emissions were measured on the Open Area Test Site (OATS) at a three-meter distance. The EUT utilizes permanently attached printed circuit board antenna. A second test sample was provided with antenna port connection points replacing the internal antennas. Antenna conducted measurements were take on the second test sample. Radiated emissions measurements were performed on the test sample with integral antennas. The EUT was placed on a turntable elevated as required above the ground plane at a distance of 3 meters from the FSM antenna located on the OATS. The peak and quasi-peak amplitude of the frequencies below 1000 MHz were measured using a spectrum analyzer. The peak and average amplitude of emissions above 1000 MHz were measured using a spectrum analyzer. Emissions data was recorded from the measurement results. Data presented reflects measurement result corrected to account for measurement system gains and losses. Plots were made of transmitter performance for reference purposes.

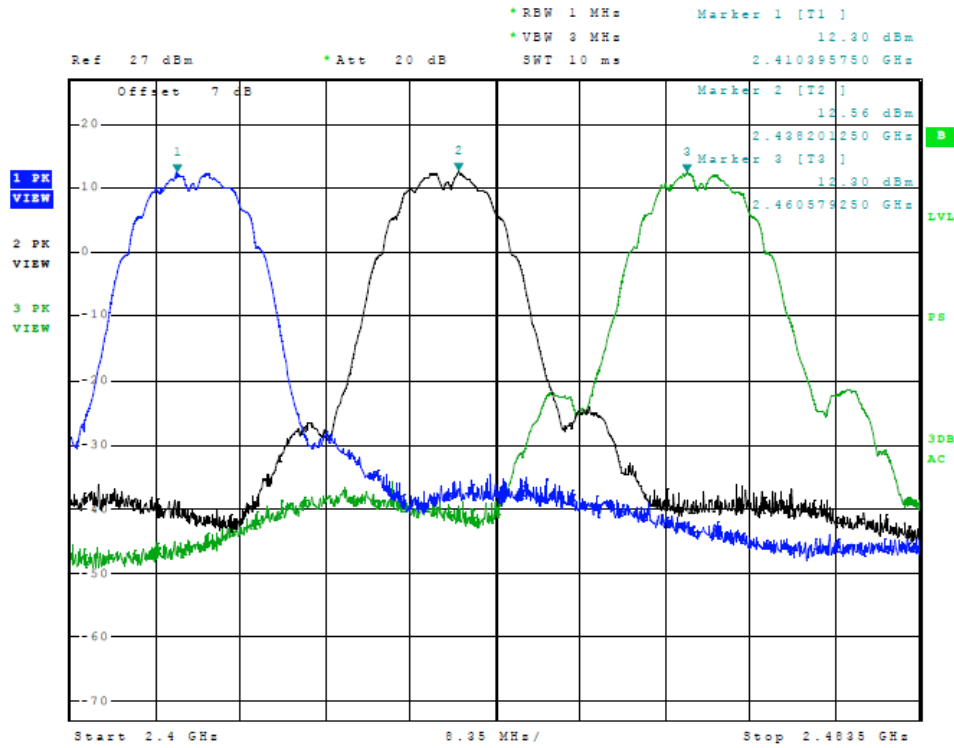

Figure 3 Plot of Transmitter Emissions (Across Operational Band 802.11b, Chain 0)

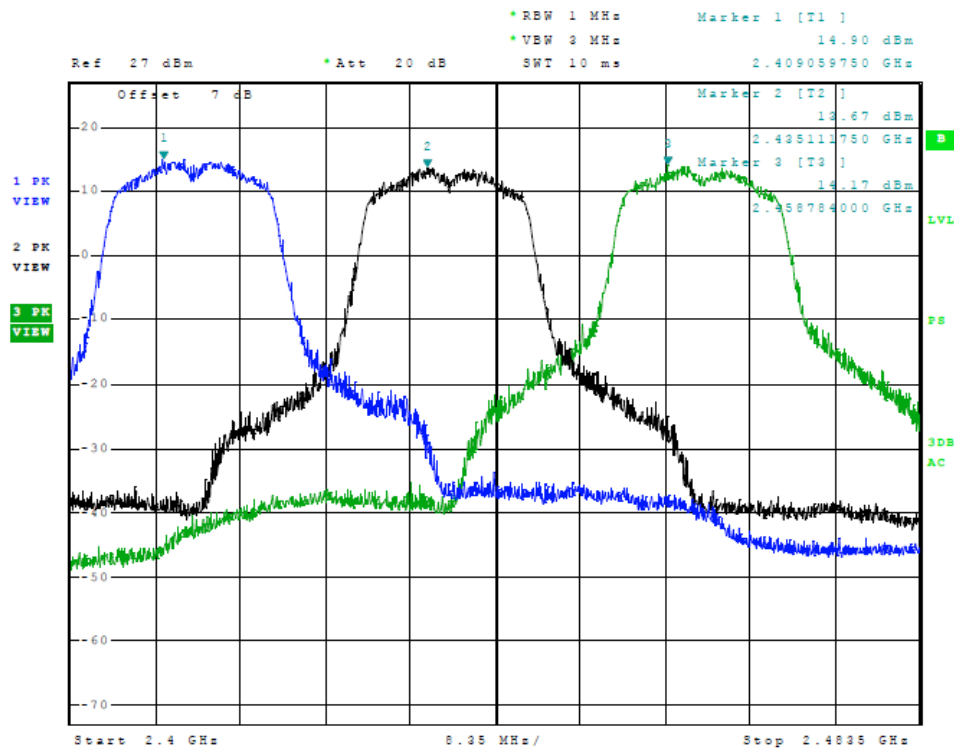

Figure 4 Plot of Transmitter Emissions (Across Operational Band, 802.11g, Chain 0)

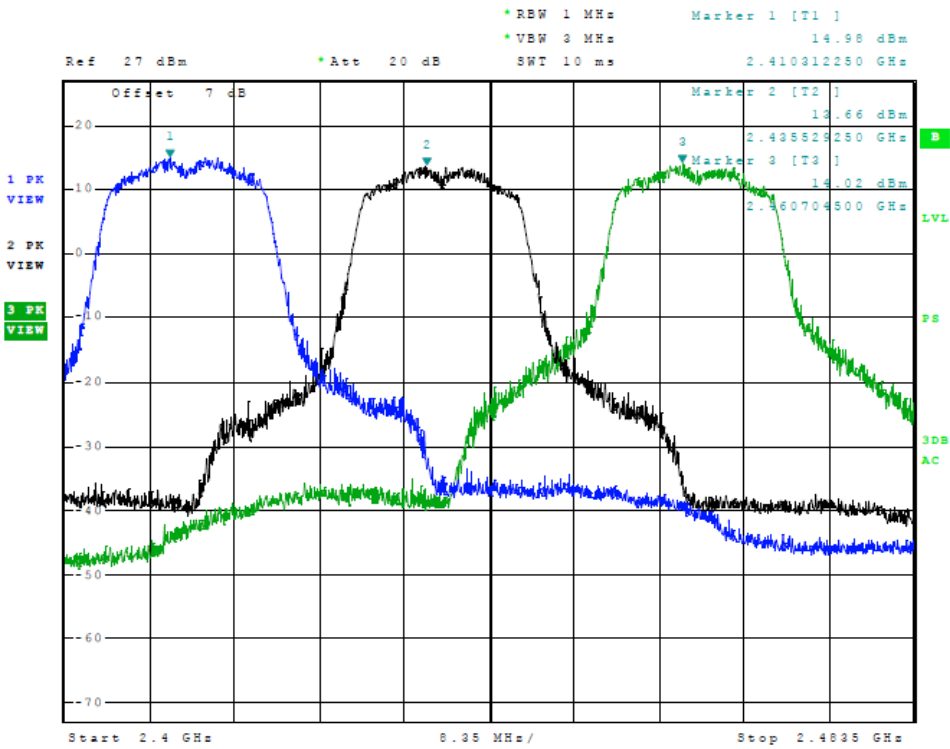

Figure 5 Plot of Transmitter Emissions (Across Operational Band, 802.11n (20), Chain 0)

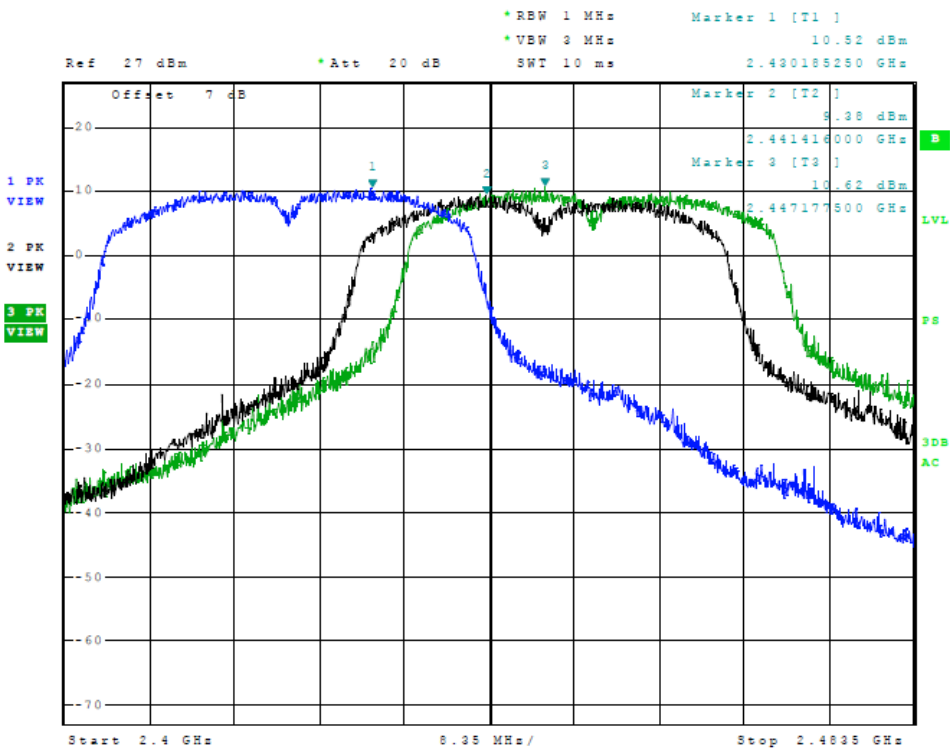

Figure 6 Plot of Transmitter Emissions (Across Operational Band, 802.11n (40), Chain 0)

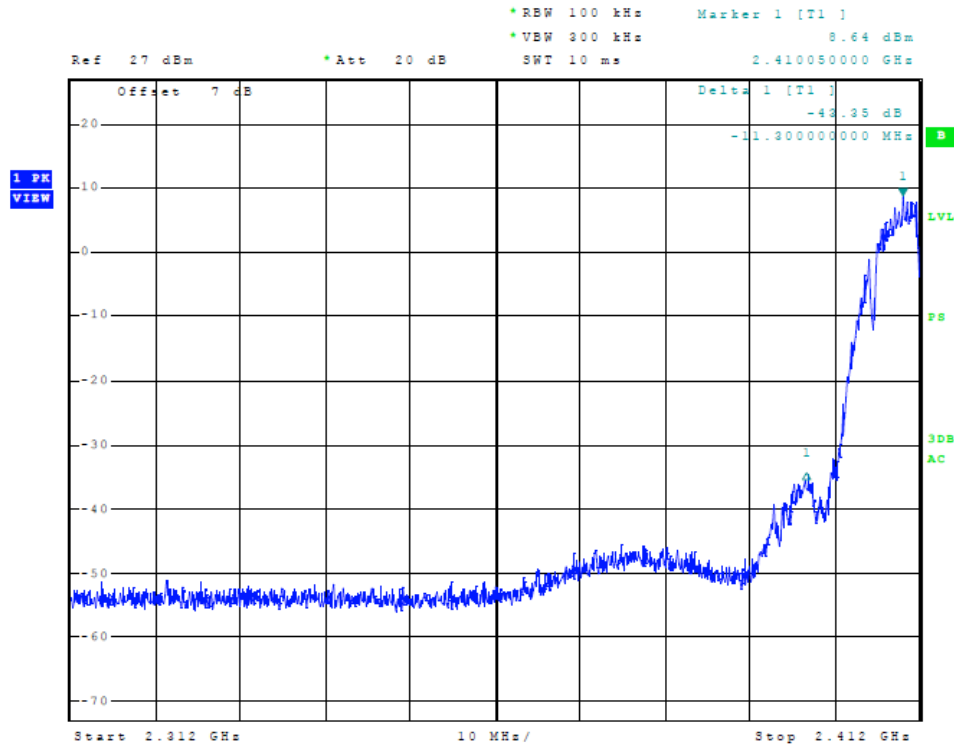

Figure 7 Plot of Transmitter Low Band Edge (802.11b, Chain 0)

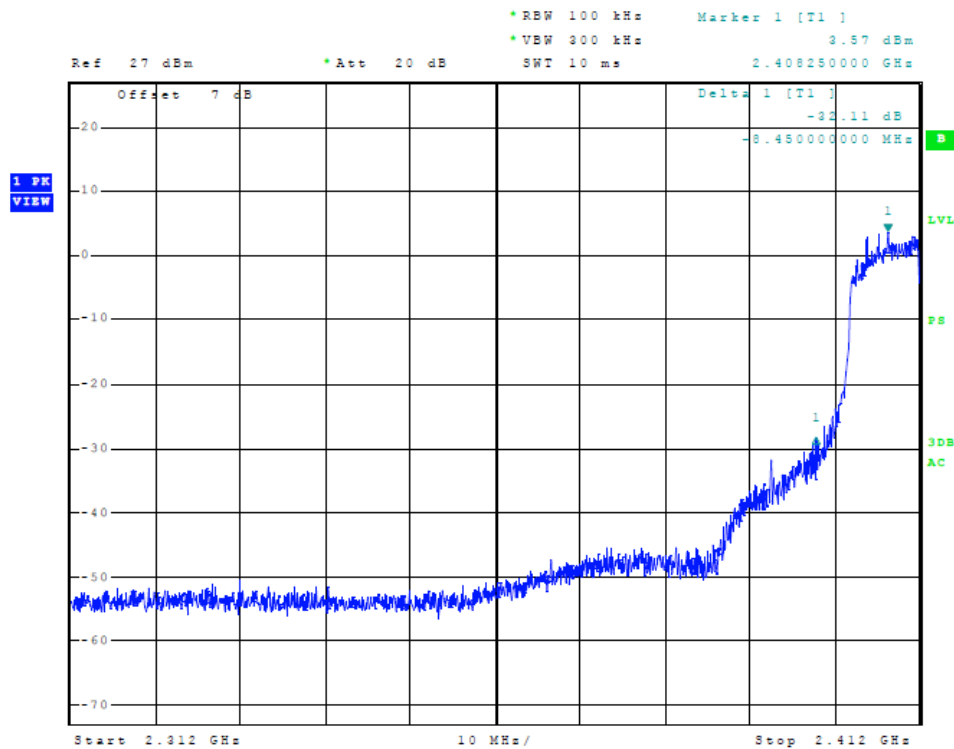

Figure 8 Plot of Transmitter Low Band Edge (802.11g, Chain 0)

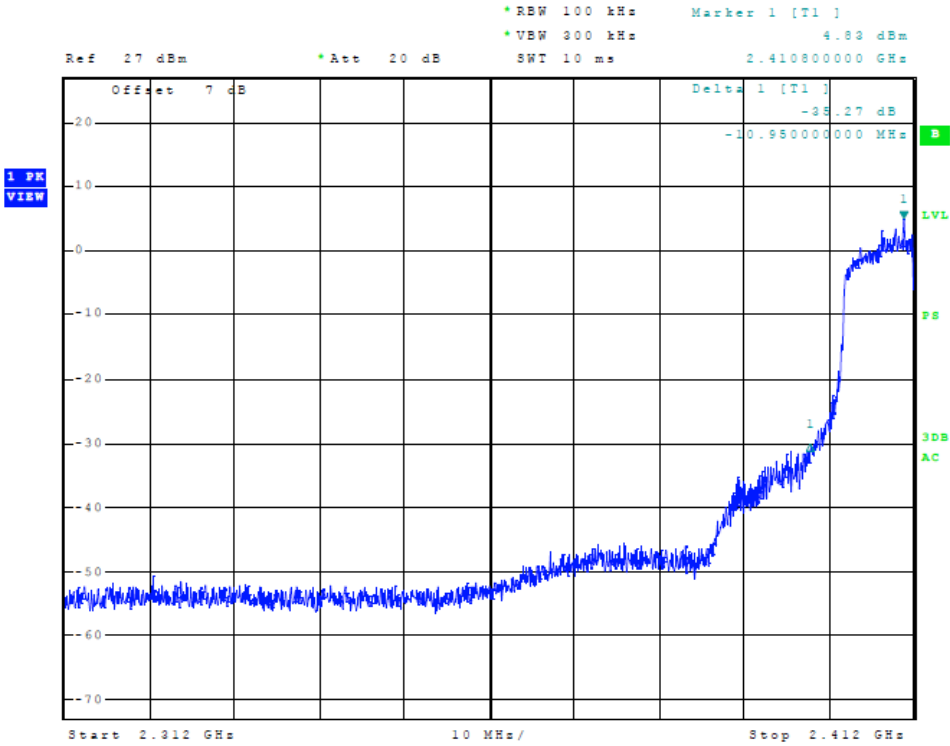

Figure 9 Plot of Transmitter Low Band Edge (802.11n (20), Chain 0)

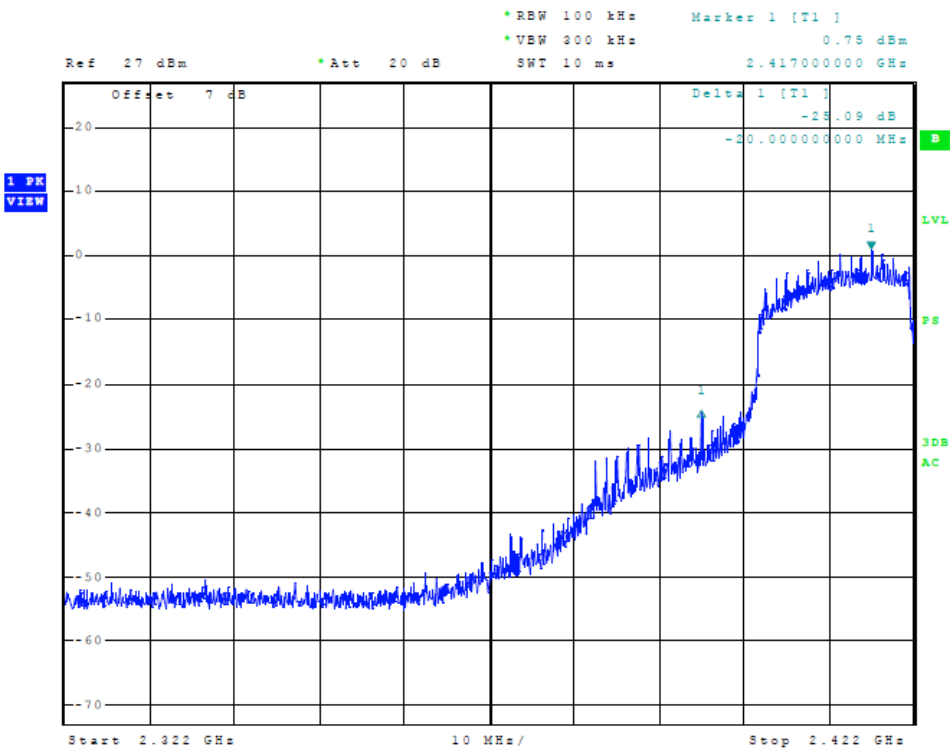

Figure 10 Plot of Transmitter Low Band Edge (802.11n (40), Chain 0)

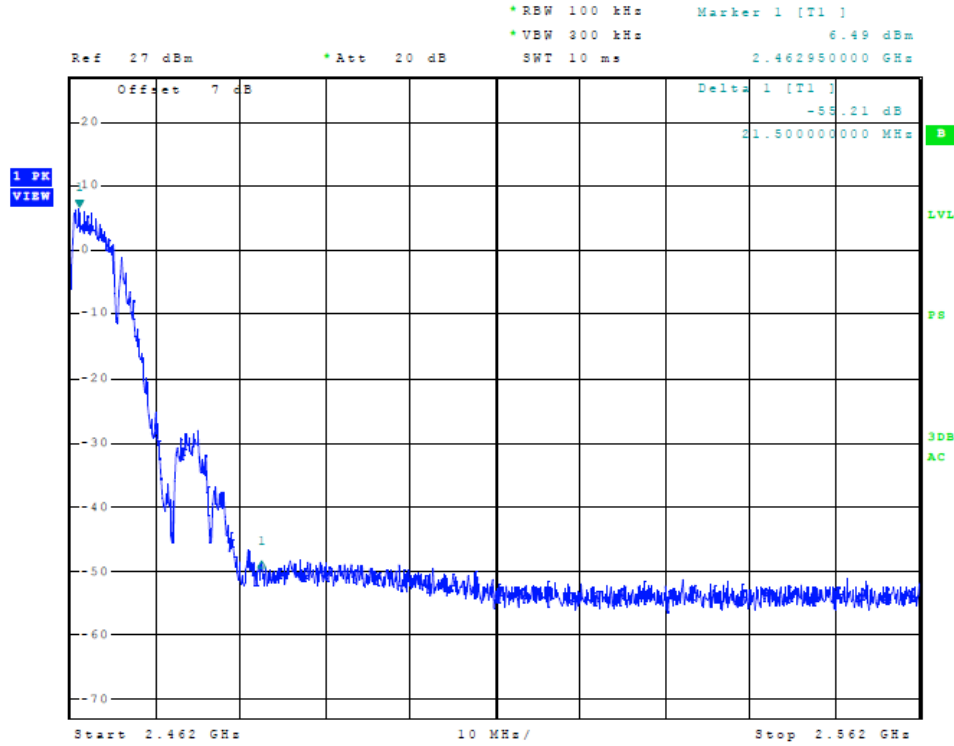

Figure 11 Plot of Transmitter High Band Edge (802.11b, Chain 0)

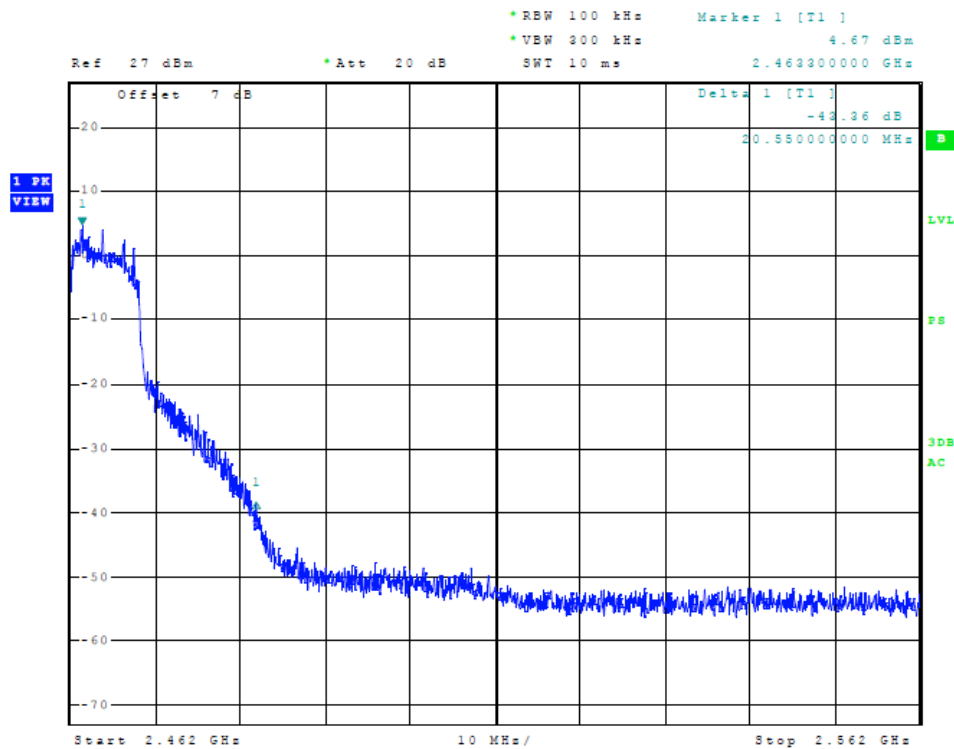

Figure 12 Plot of Transmitter High Band Edge (802.11g, Chain 0)

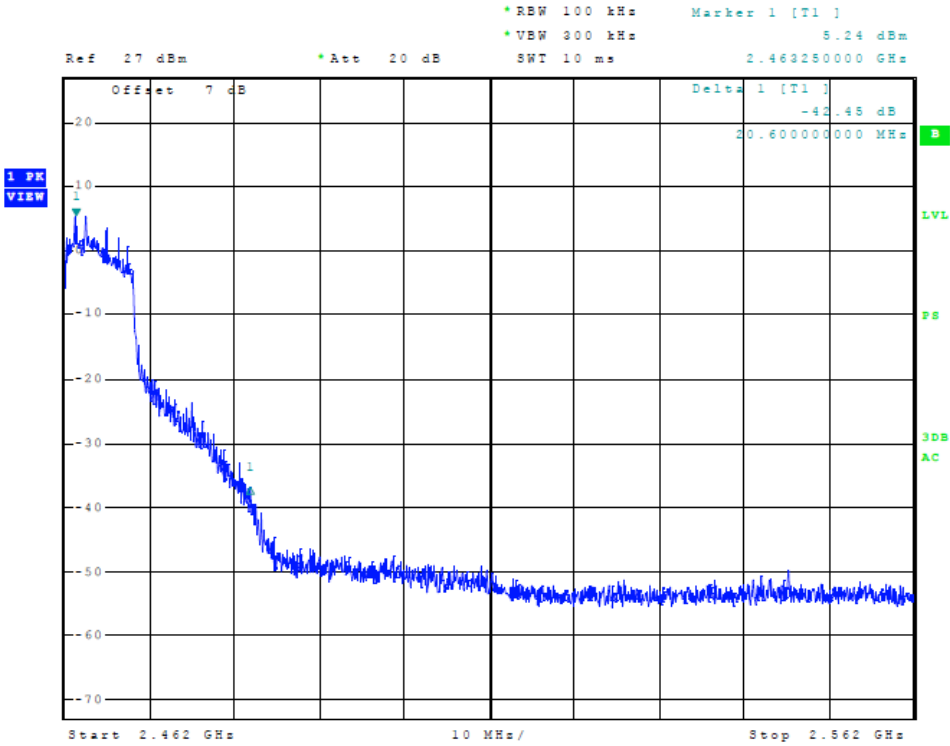

Figure 13 Plot of Transmitter High Band Edge (802.11n (20), Chain 0)

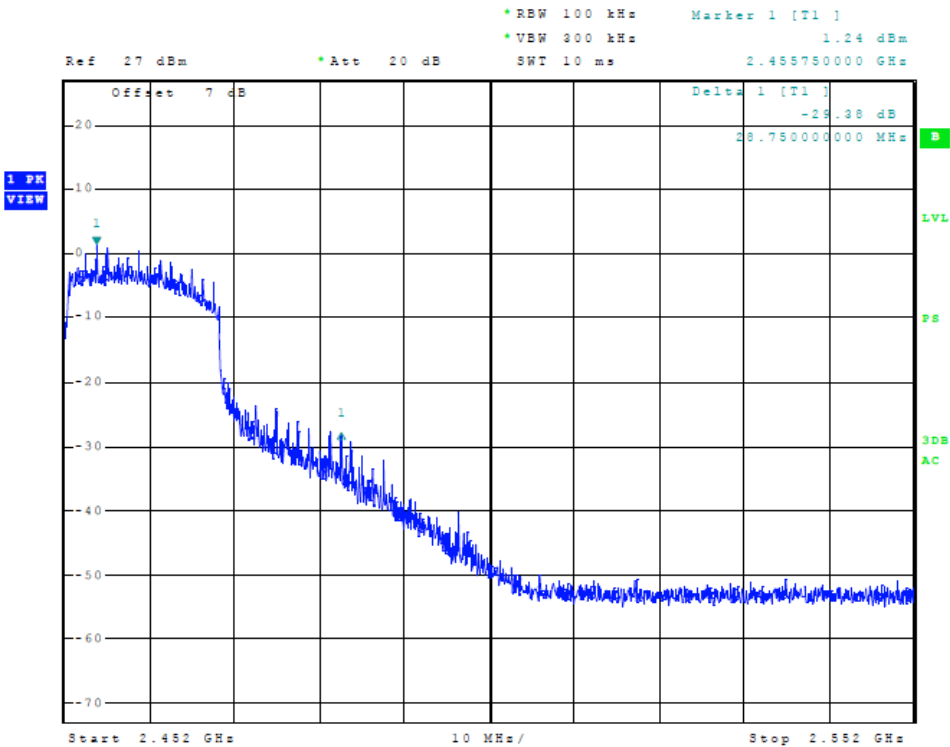

Figure 14 Plot of Transmitter High Band Edge (802.11n (40), Chain 0)

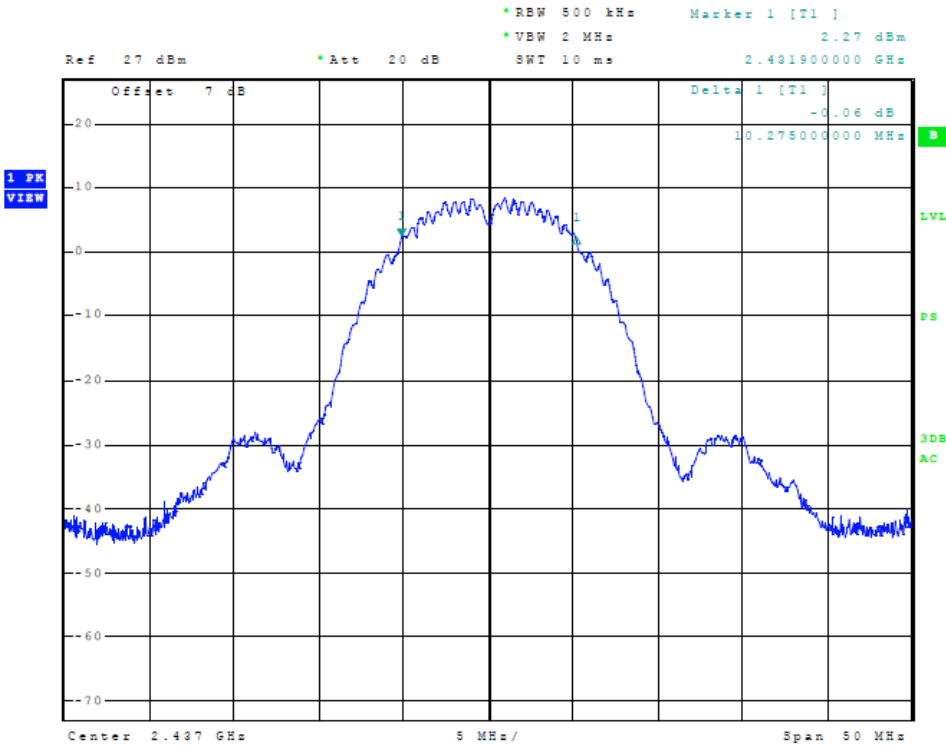

Figure 15 Plot of Transmitter 6-dB Occupied Band Width (802.11b, Chain 0)

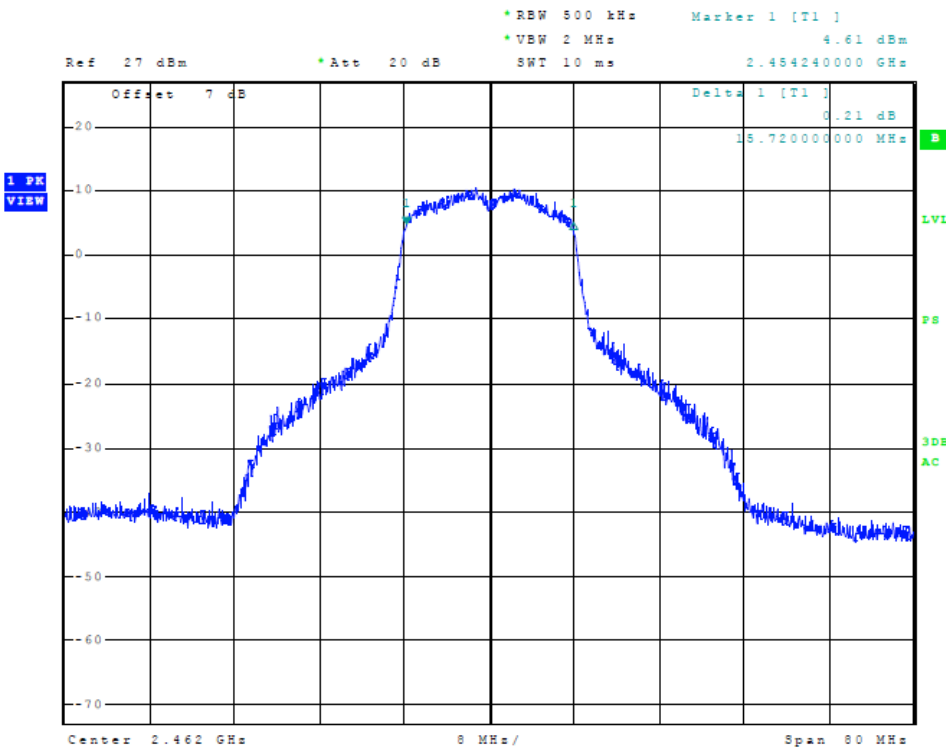

Figure 16 Plot of Transmitter 6-dB Occupied Band Width (802.11g, Chain 0)

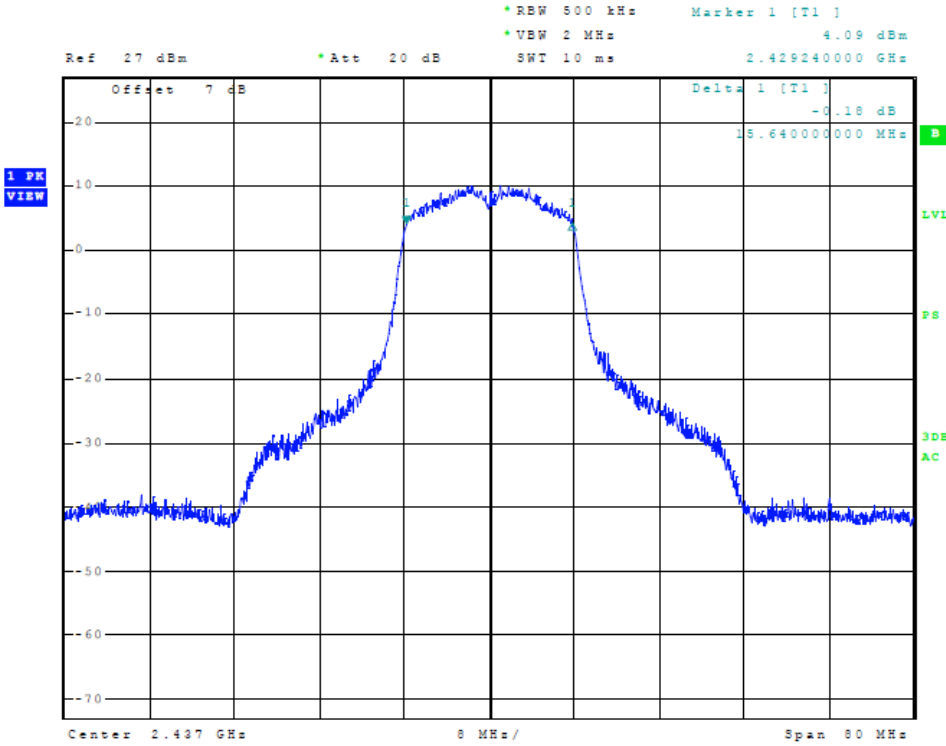

Figure 17 Plot of Transmitter 6-dB Occupied Band Width (802.11n (20), Chain 0)

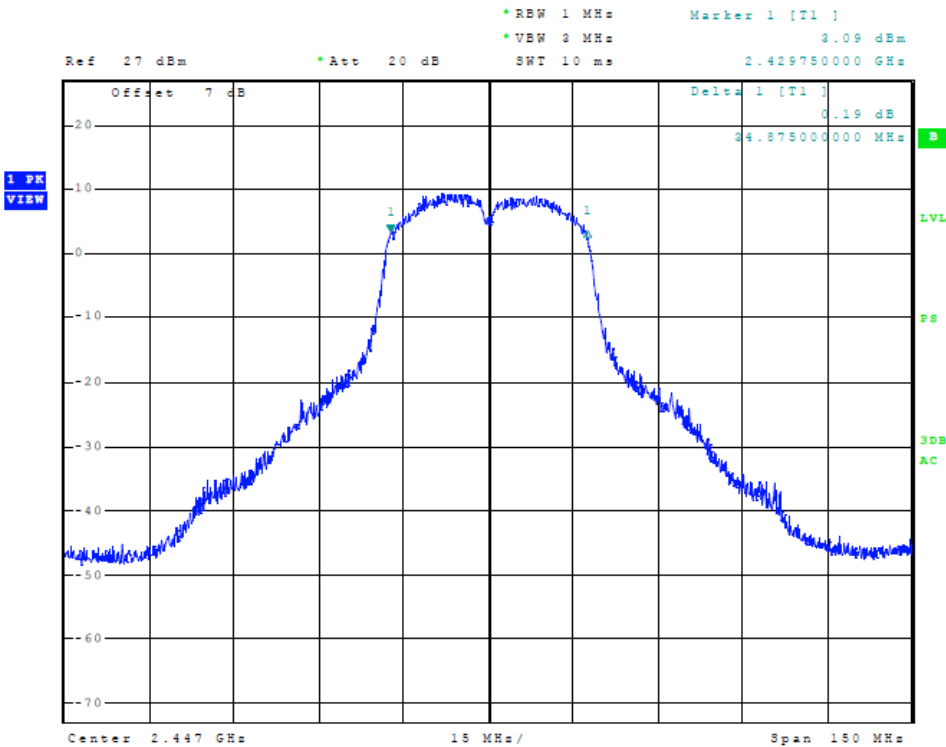

Figure 18 Plot of Transmitter 6-dB Occupied Band Width (802.11n (40), Chain 0)

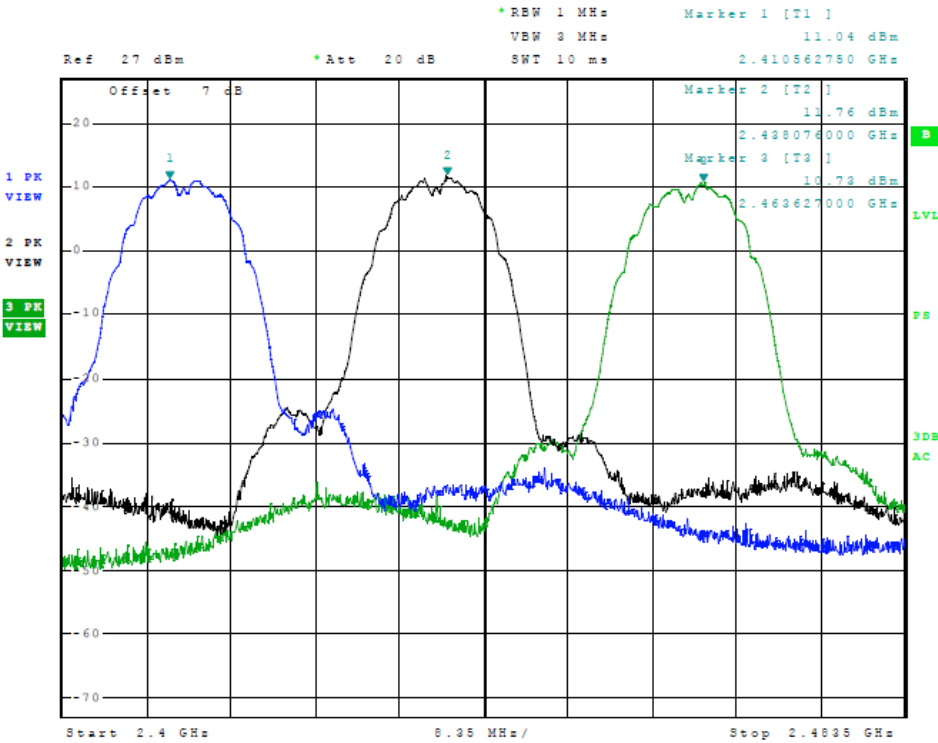

Figure 19 Plot of Transmitter Emissions (Across Operational Band 802.11b, Chain 1)

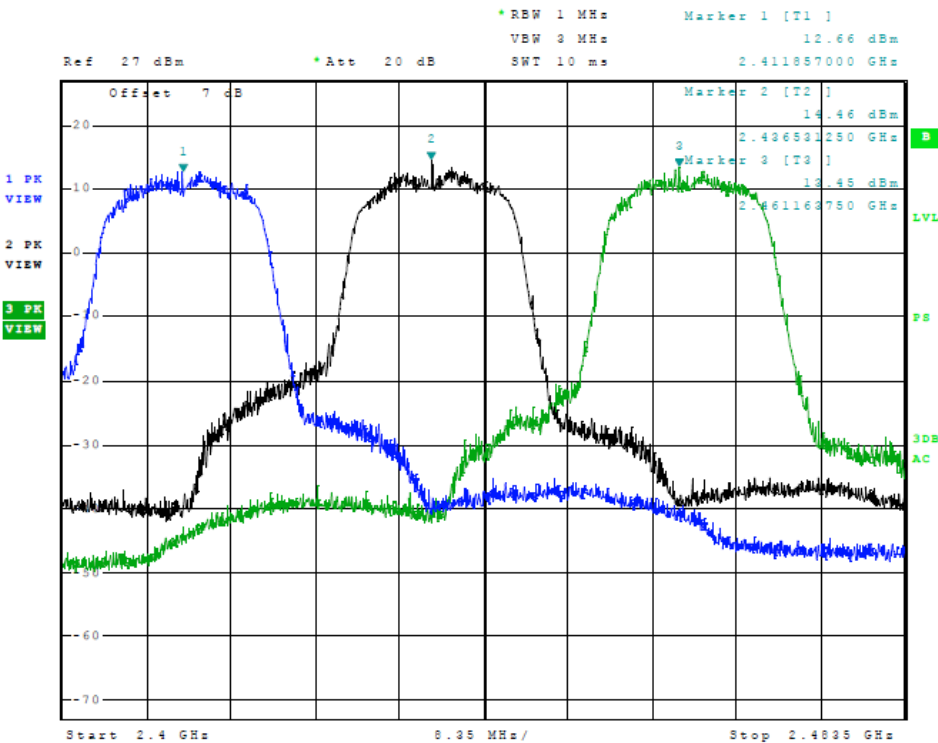

Figure 20 Plot of Transmitter Emissions (Across Operational Band, 802.11g, Chain 01)

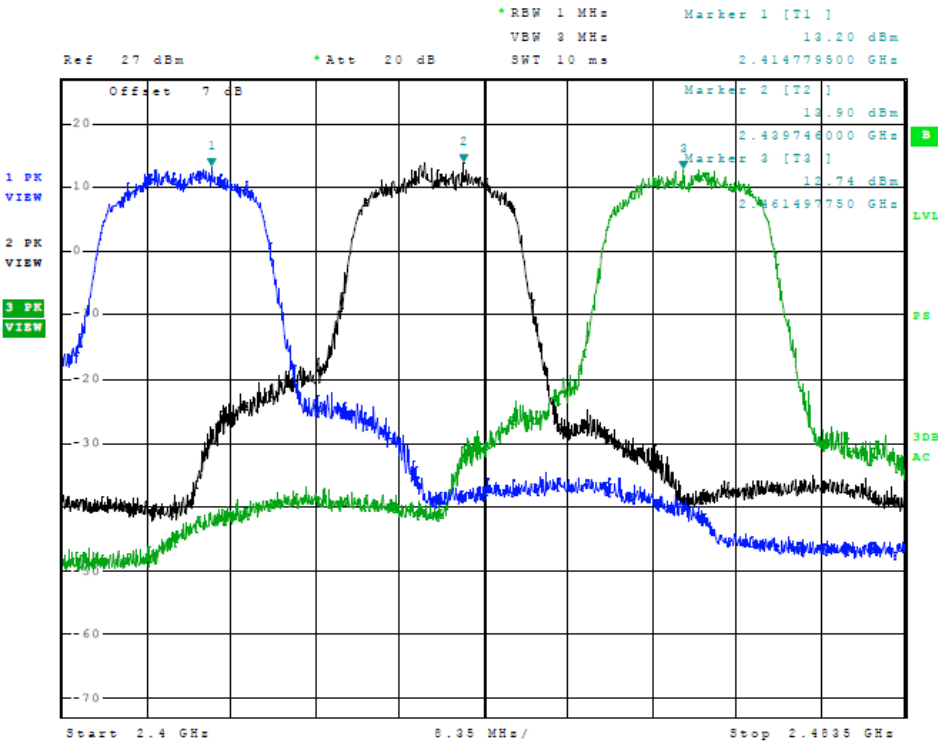

Figure 21 Plot of Transmitter Emissions (Across Operational Band, 802.11n (20), Chain 1)

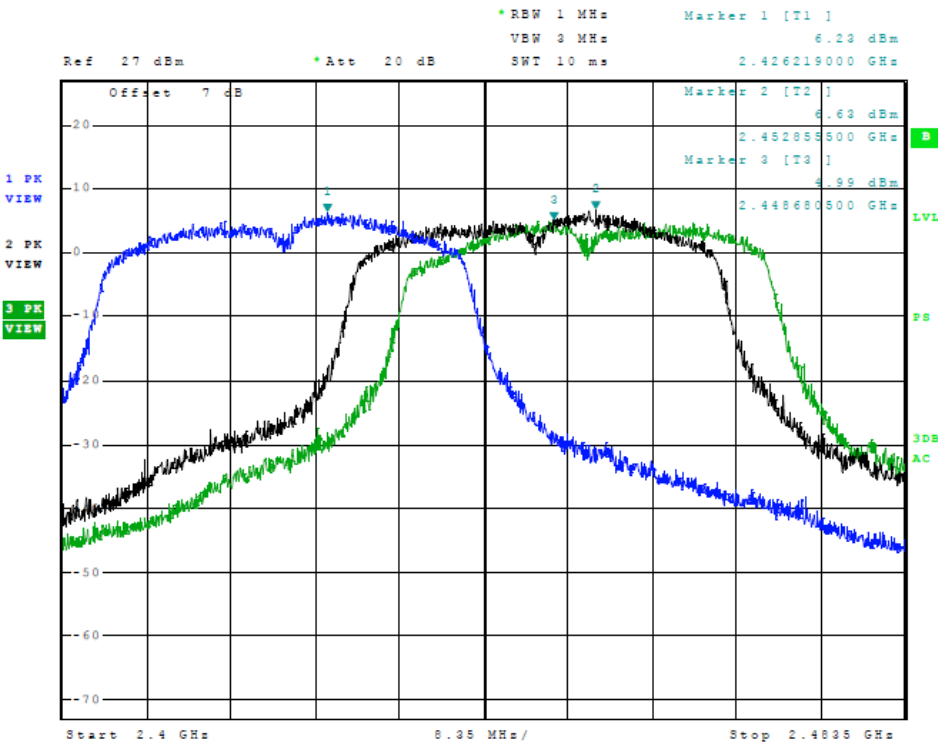

Figure 22 Plot of Transmitter Emissions (Across Operational Band, 802.11n (40), Chain 1)

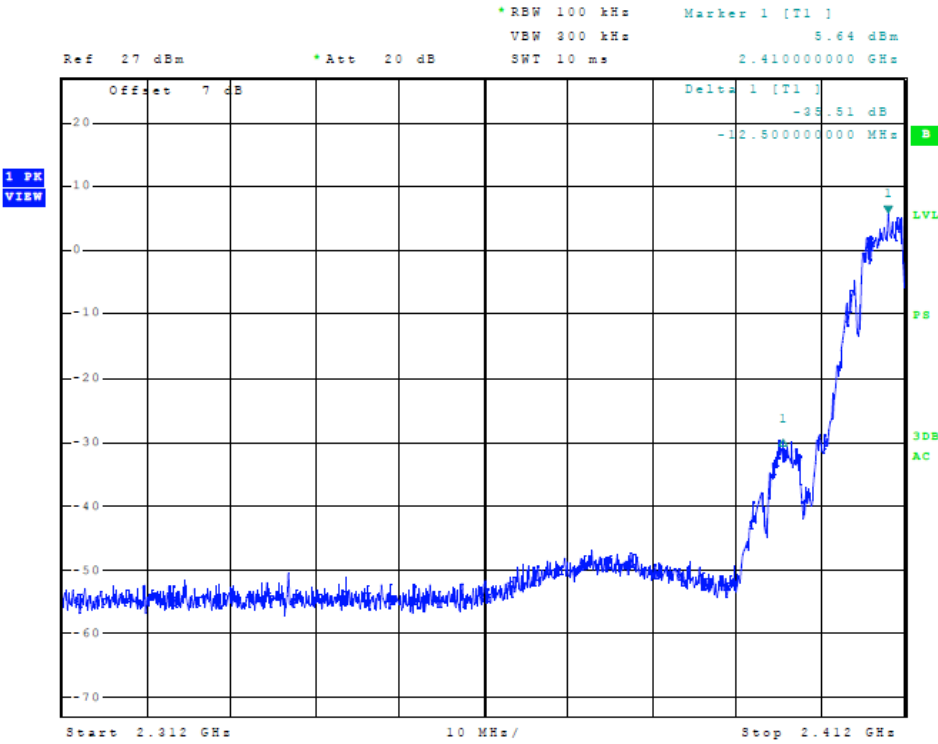

Figure 23 Plot of Transmitter Low Band Edge (802.11b, Chain 1)

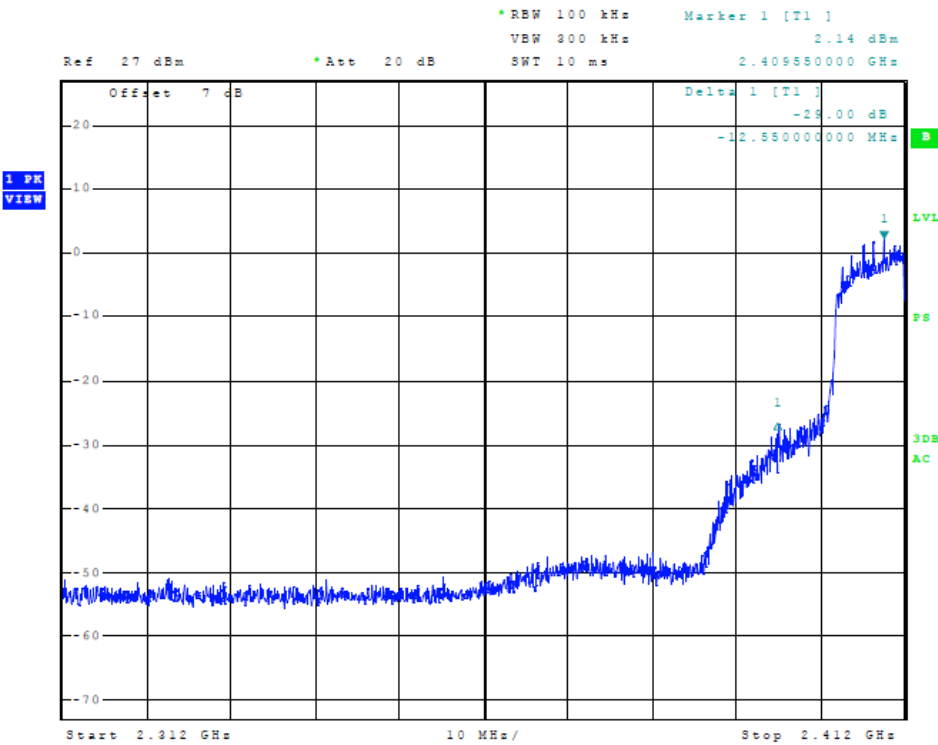

Figure 24 Plot of Transmitter Low Band Edge (802.11g, Chain 1)

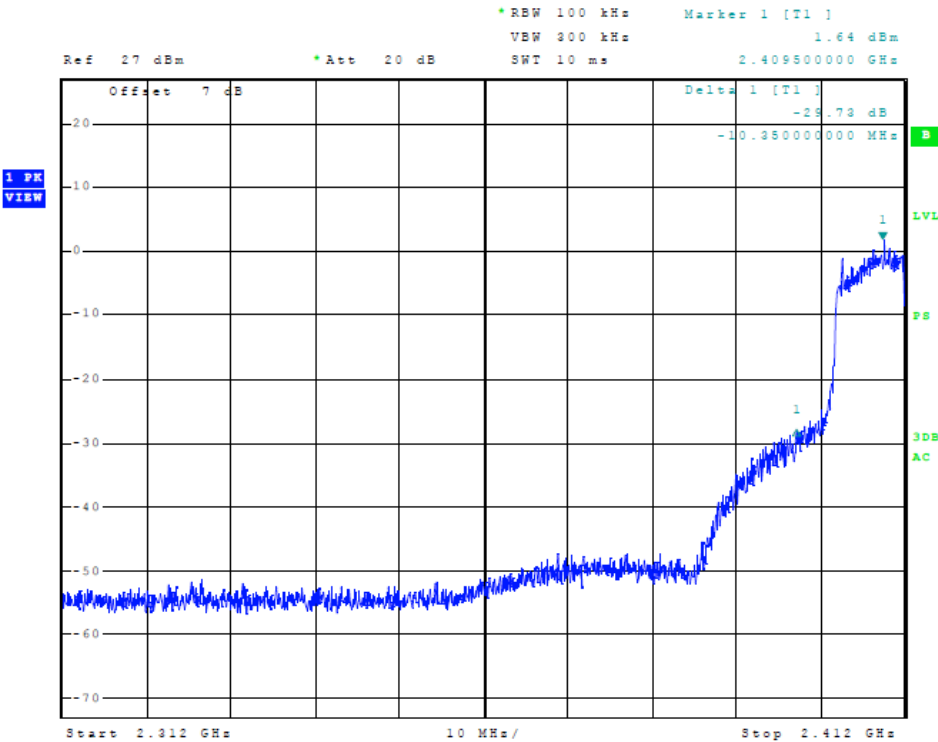

Figure 25 Plot of Transmitter Low Band Edge (802.11n (20), Chain 1)

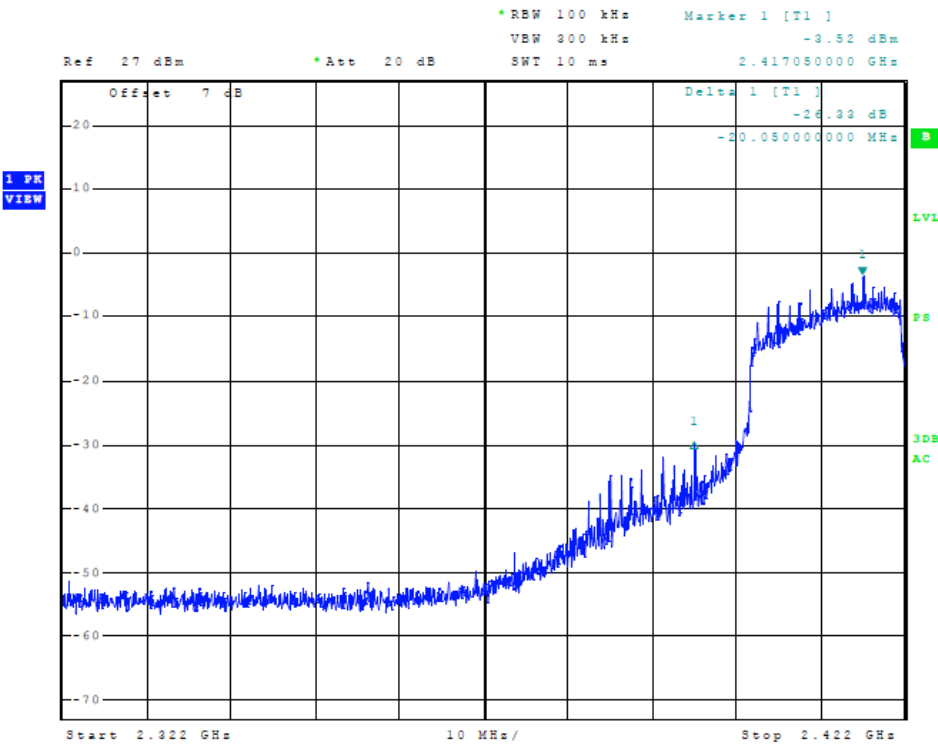

Figure 26 Plot of Transmitter Low Band Edge (802.11n (40), Chain 1)

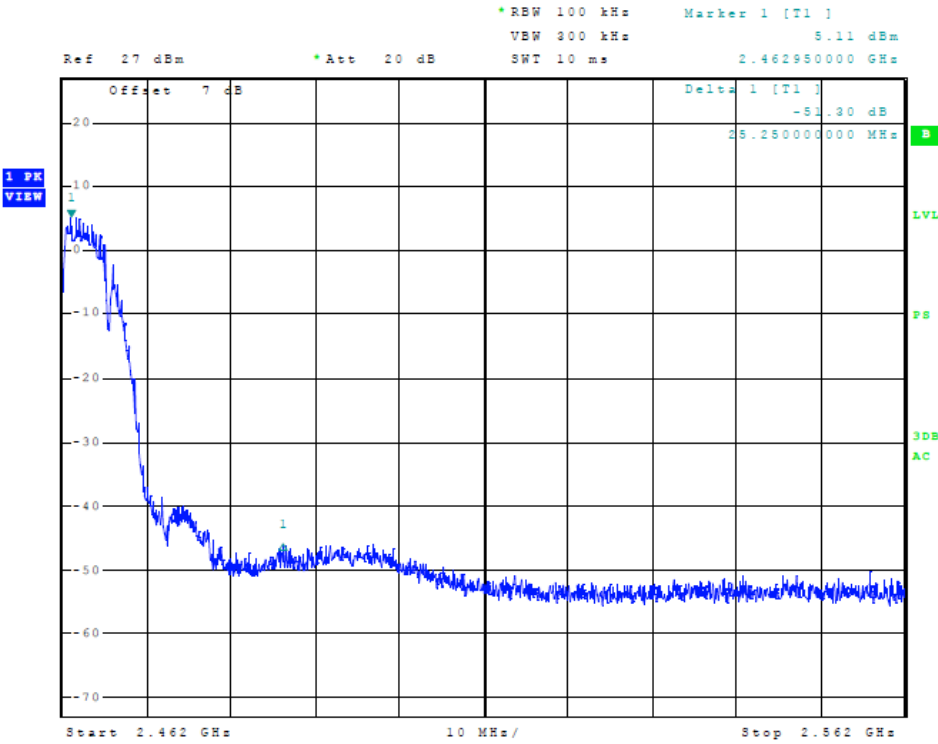

Figure 27 Plot of Transmitter High Band Edge (802.11b, Chain 1)

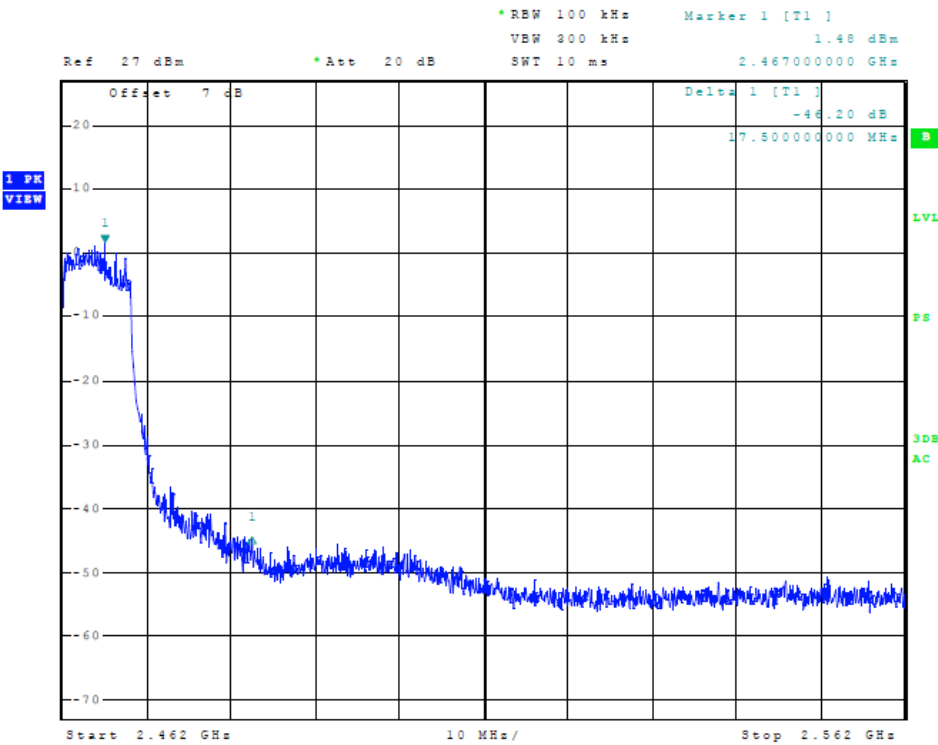

Figure 28 Plot of Transmitter High Band Edge (802.11g, Chain 1)

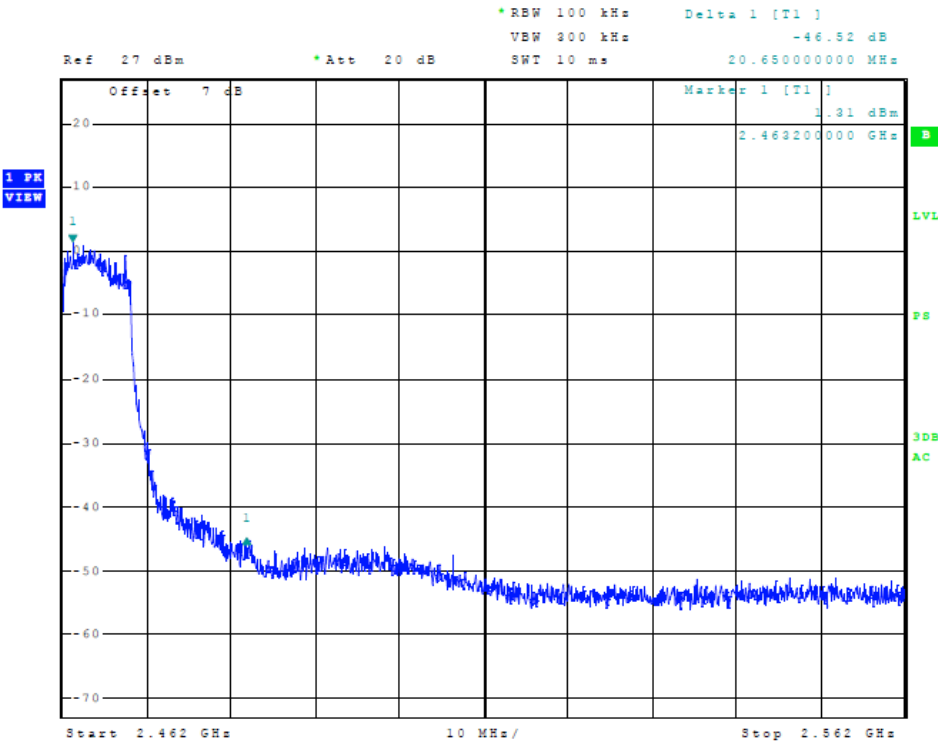

Figure 29 Plot of Transmitter High Band Edge (802.11n (20), Chain 1)

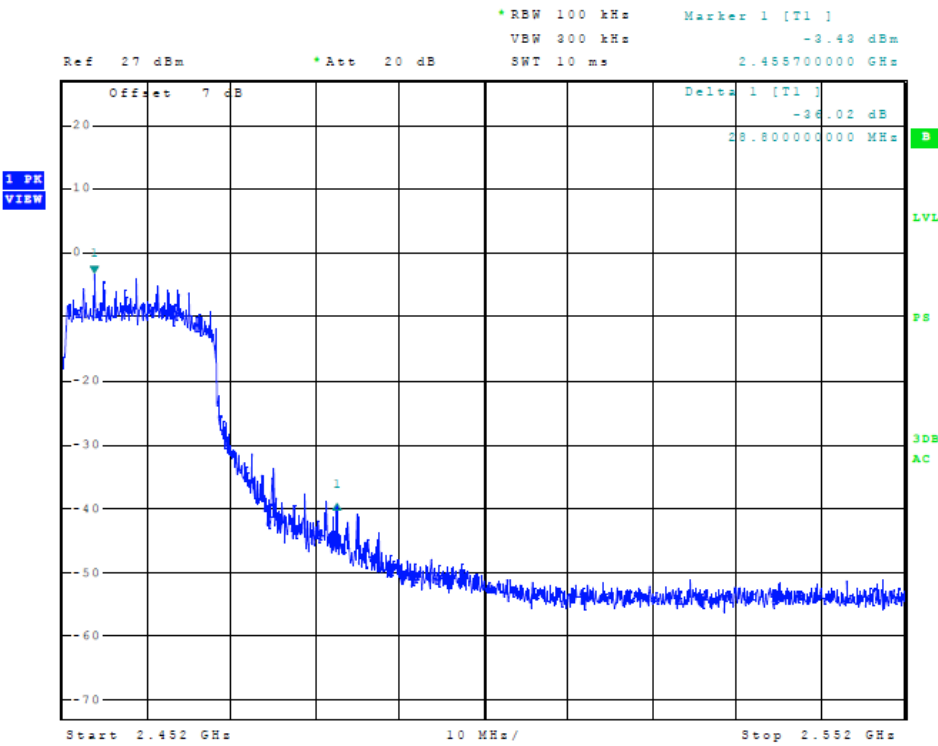

Figure 30 Plot of Transmitter High Band Edge (802.11n (40), Chain 1)

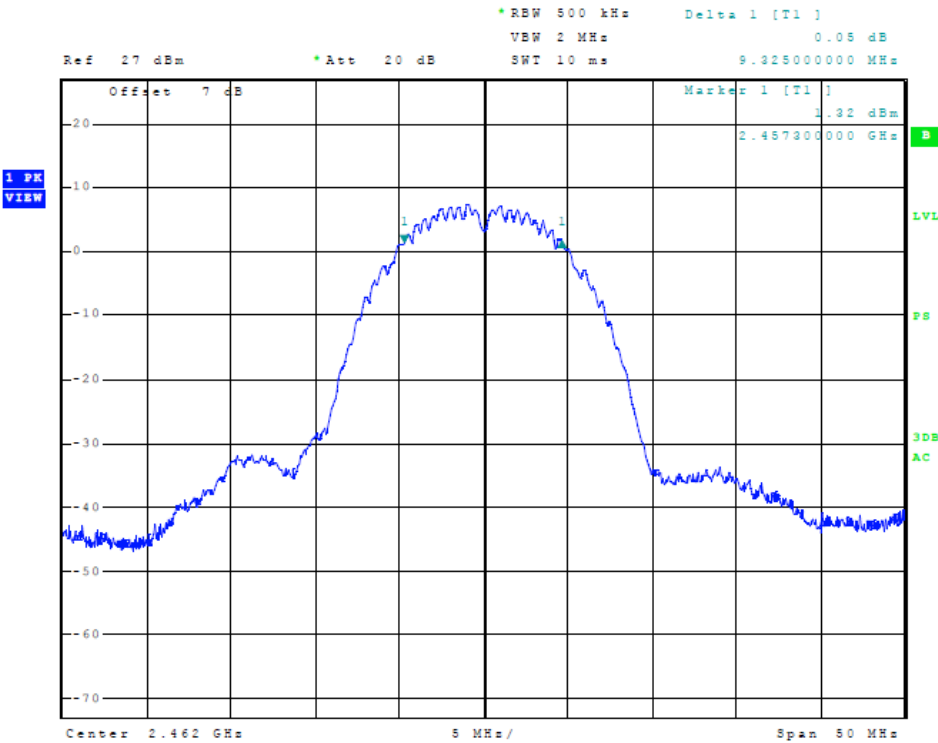

Figure 31 Plot of Transmitter 6-dB Occupied Band Width (802.11b, Chain 1)

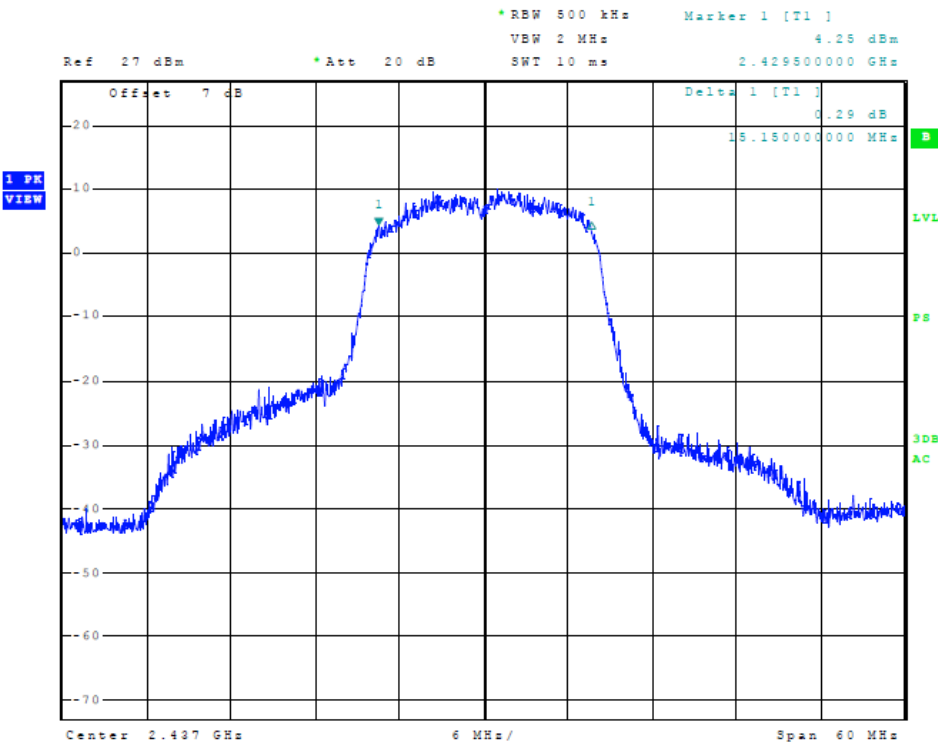

Figure 32 Plot of Transmitter 6-dB Occupied Band Width (802.11g, Chain 1)

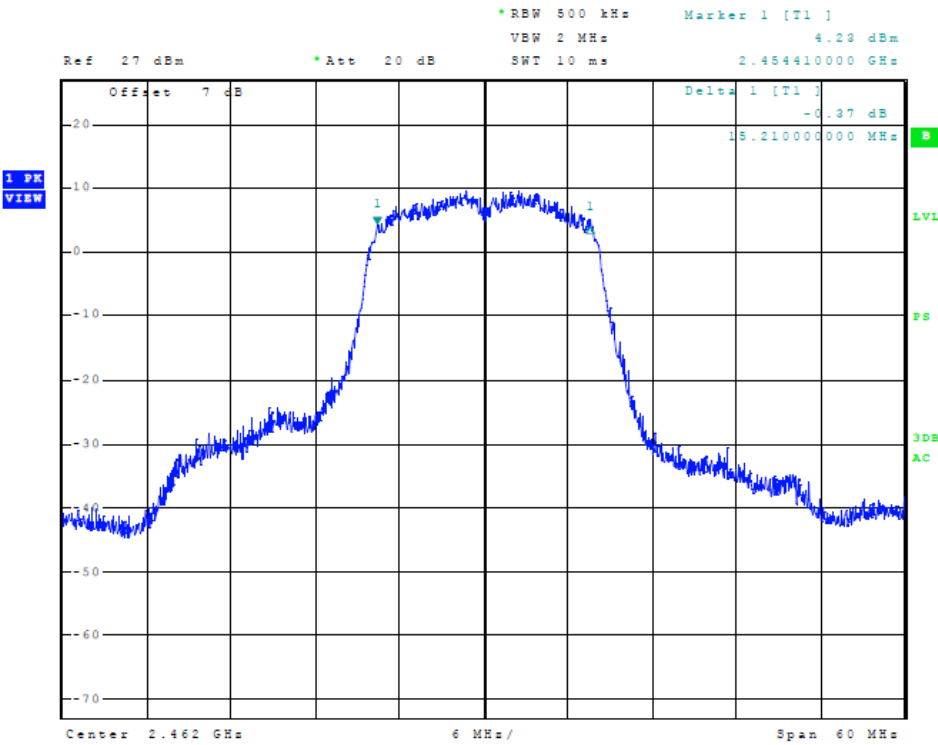

Figure 33 Plot of Transmitter 6-dB Occupied Band Width (802.11n (20), Chain 1)

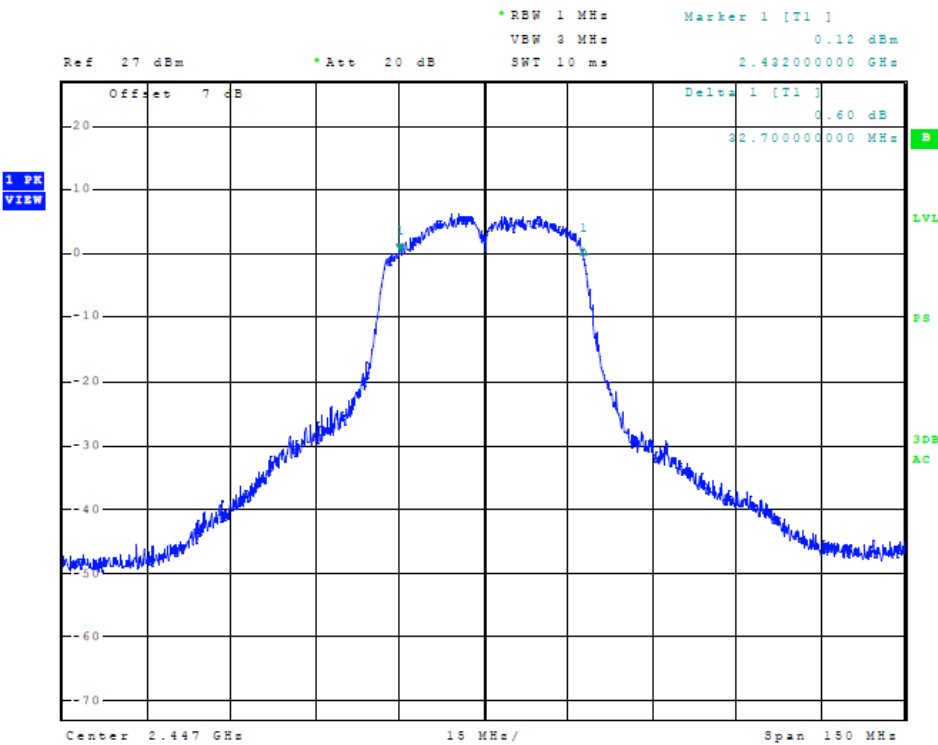

Figure 34 Plot of Transmitter 6-dB Occupied Band Width (802.11n (40), Chain 1)

Transmitter Emissions Data

Table 6 Transmitter Power and Emissions

Frequency MHz	Conducted Antenna Port Output Power (Watts)		6-dB Occupied Bandwidth kHz	Power Spectral Density dBm	
	Total	Chain 0 / Chain 1		Total	Chain 0 / Chain 1
20 MHz b-Mode					
2412.0	0.031 / 0.017 / 0.014		10,275 kHz	-4.3 / -6.53 / -8.16	
2437.0	0.033 / 0.018 / 0.015		10,275 kHz	-4.4 / -6.58 / -8.84	
2462.0	0.031 / 0.017 / 0.014		10,275 kHz	-5.2 / -7.71 / -8.83	
20 MHz g-Mode					
2412.0	0.048 / 0.025 / 0.023		15,720 kHz	-7.2 / -9.07 / -11.80	
2437.0	0.046 / 0.023 / 0.023		15,720 kHz	-7.1 / -9.49 / -10.80	
2462.0	0.043 / 0.021 / 0.022		15,720 kHz	-7.0 / -8.84 / -11.68	
20 MHz n-Mode					
2412.0	0.045 / 0.024 / 0.023		15,640 kHz	-6.7 / -8.79 / -10.87	
2437.0	0.047 / 0.023 / 0.024		15,640 kHz	-7.1 / -8.91 / -11.64	
2462.0	0.044 / 0.020 / 0.024		15,640 kHz	-7.0 / -8.85 / -12.03	
40 MHz Mode					
2422.0	0.028 / 0.015 / 0.013		33,375 kHz	-13.8 / -15.78 / -18.24	
2447.0	0.028 / 0.014 / 0.014		33,375 kHz	-13.5 / -16.21 / -16.78	
2452.0	0.027 / 0.014 / 0.013		33,375 kHz	-13.1 / -14.49 / -18.76	

Table 7 Transmitter Radiated Emissions (20 MHz Channel, Worst-case)

Frequency in MHz	Horizontal Peak (dBµV/m)	Horizontal Average (dBµV/m)	Vertical Peak (dBµV/m)	Vertical Average (dBµV/m)	Limit @ 3m (dBµV/m)
2412.0	-	-	-	-	-
4824.0	55.0	52.5	50.7	47.9	54.0
7236.0	46.7	33.4	46.2	33.3	54.0
9648.0	46.3	34.0	45.9	33.1	54.0
12060.0	50.6	37.4	50.3	37.4	54.0
14472.0	51.3	38.7	51.7	38.7	54.0
16884.0	54.5	41.7	55.1	41.8	54.0
2437.0	-	-	-	-	-
4874.0	55.9	53.6	54.1	51.3	54.0
7311.0	46.2	33.5	45.5	32.8	54.0
9748.0	47.9	34.9	47.5	34.9	54.0
12185.0	49.9	37.3	50.5	37.5	54.0
14622.0	52.2	39.0	52.0	39.1	54.0
17059.0	56.8	43.6	56.5	43.8	54.0
2462.0	-	-	-	-	-
4924.0	55.9	53.3	55.8	53.3	54.0
7386.0	47.0	34.1	46.4	33.4	54.0
9848.0	46.8	33.8	47.2	34.8	54.0
12310.0	49.9	37.1	49.8	37.0	54.0
14772.0	52.9	39.9	53.0	40.0	54.0
17234.0	57.2	44.5	57.6	44.6	54.0

Other emissions present had amplitudes at least 20 dB below the limit. Peak and Quasi-Peak amplitude emissions are recorded above for frequency range of 30-1000 MHz. Peak and Average amplitude emissions are recorded above for frequency range above 1000 MHz.

Table 8 Transmitter Radiated Emissions (40 MHz Channel, Worst-case)

Frequency in MHz	Horizontal Peak (dBµV/m)	Horizontal Average (dBµV/m)	Vertical Peak (dBµV/m)	Vertical Average (dBµV/m)	Limit @ 3m (dBµV/m)
2422.0	-	-	-	-	-
4844.0	46.4	32.7	44.8	31.9	54.0
7266.0	46.3	33.0	45.3	33.0	54.0
9688.0	46.3	33.2	46.5	33.2	54.0
12110.0	50.1	37.1	50.5	37.2	54.0
14532.0	51.8	38.7	51.6	38.8	54.0
16954.0	54.2	42.0	54.8	42.0	54.0
2447.0	-	-	-	-	-
4894.0	44.8	31.7	41.9	31.5	54.0
7341.0	46.1	33.3	46.2	33.2	54.0
9788.0	47.4	34.7	47.4	34.7	54.0
12235.0	50.3	36.9	50.1	36.9	54.0
14682.0	52.4	39.0	52.1	39.0	54.0
17129.0	56.4	43.6	56.8	43.8	54.0
2452.0	-	-	-	-	-
4904.0	44.8	31.4	44.7	31.4	54.0
7356.0	45.9	33.0	45.6	33.0	54.0
9808.0	45.8	33.0	46.3	33.1	54.0
12260.0	50.1	37.3	51.0	37.3	54.0
14712.0	52.7	39.8	53.3	39.9	54.0
17164.0	57.5	44.8	57.6	44.8	54.0

Other emissions present had amplitudes at least 20 dB below the limit. Peak and Quasi-Peak amplitude emissions are recorded above for frequency range of 30-1000 MHz. Peak and Average amplitude emissions are recorded above for frequency range above 1000 MHz.

Summary of Results for Transmitter Radiated Emissions of Intentional Radiator

The EUT demonstrated compliance with the radiated emissions requirements of 47CFR Part 15.247 and Industry Canada RSS-247. The highest average conducted chain power was 0.025-Watts. The worst-case total peak power spectral density provided a minimum margin of -12.3 dB below the requirements. The minimum margin harmonic radiated emission provided -0.4 dB margin below requirements. There were no other significantly measurable emissions in the restricted bands other than those recorded in this report. Other emissions were present with amplitudes at least 20 dB below the requirements. There were no other deviations or exceptions to the requirements.

Statement of Modifications and Deviations

No modifications to the EUT were required for the unit to demonstrate compliance with the 47CFR Part 15C and Industry Canada RSS-247 emissions requirements. There were no deviations or modifications to the specifications.

Annex

- Annex A Measurement Uncertainty Calculations
- Annex B Rogers Labs Test Equipment List
- Annex C Rogers Qualifications
- Annex D FCC Site Registration Letter
- Annex E Industry Canada Site Registration Letter

Annex A Measurement Uncertainty Calculations

Measurement uncertainty calculations were made for the laboratory. Result of measurement uncertainty calculations are recorded below for AC line conducted and radiated emission measurements.

Measurement Uncertainty	$U_{(E)}$	$U_{(lab)}$
3 Meter Horizontal 30-200 MHz Measurements	2.08	4.16
3 Meter Vertical 30-200 MHz Measurements	2.16	4.33
3 Meter Vertical Measurements 200-1000 MHz	2.99	5.97
10 Meter Horizontal Measurements 30-200 MHz	2.07	4.15
10 Meter Vertical Measurements 30-200 MHz	2.06	4.13
10 Meter Horizontal Measurements 200-1000 MHz	2.32	4.64
10 Meter Vertical Measurements 200-1000 MHz	2.33	4.66
3 Meter Measurements 1-6 GHz	2.57	5.14
3 Meter Measurements 6-18 GHz	2.58	5.16
AC Line Conducted	1.72	3.43

Annex B Rogers Labs Test Equipment List

List of Test Equipment	Calibration	<u>Date</u>	<u>Due</u>
Spectrum Analyzer: Rohde & Schwarz ESU40		5/16	5/17
Spectrum Analyzer: HP 8562A, HP Adapters: 11518, 11519, and 11520		5/16	5/17
Mixers: 11517A, 11970A, 11970K, 11970U, 11970V, 11970W			
Spectrum Analyzer: HP 8591EM		5/16	5/17
Antenna: EMCO Biconilog Model: 3143		5/16	5/17
Antenna: Sunol Biconilog Model: JB6		10/15	10/16
Antenna: EMCO Log Periodic Model: 3147		10/15	10/16
Antenna: Com Power Model: AH-118		10/15	10/16
Antenna: Com Power Model: AH-840		5/16	5/18
Antenna: Antenna Research Biconical Model: BCD 235		10/15	10/16
Antenna: EMCO 6509		10/15	10/16
LISN: Compliance Design Model: FCC-LISN-2.Mod.cd, 50 µHy/50 ohm/0.1 µf		10/15	10/16
R.F. Preamp CPPA-102		10/15	10/16
Attenuator: HP Model: HP11509A		10/15	10/16
Attenuator: Mini Circuits Model: CAT-3		10/15	10/16
Attenuator: Mini Circuits Model: CAT-3		10/15	10/16
Cable: Belden RG-58 (L1)		10/15	10/16
Cable: Belden RG-58 (L2)		10/15	10/16
Cable: Belden 8268 (L3)		10/15	10/16
Cable: Time Microwave: 4M-750HF290-750		10/15	10/16
Cable: Time Microwave: 10M-750HF290-750		10/15	10/16
Frequency Counter: Leader LDC825		2/16	2/17
Oscilloscope Scope: Tektronix 2230		2/16	2/17
Wattmeter: Bird 43 with Load Bird 8085		2/16	2/17
Power Supplies: Sorensen SRL 20-25, SRL 40-25, DCR 150, DCR 140		2/16	2/17
R.F. Generators: HP 606A, HP 8614A, HP 8640B		2/16	2/17
R.F. Power Amp 65W Model: 470-A-1010		2/16	2/17
R.F. Power Amp 50W M185- 10-501		2/16	2/17
R.F. Power Amp A.R. Model: 10W 1010M7		2/16	2/17
R.F. Power Amp EIN Model: A301		2/16	2/17
LISN: Compliance Eng. Model 240/20		2/16	2/17
LISN: Fischer Custom Communications Model: FCC-LISN-50-16-2-08		2/16	2/17
Antenna: EMCO Dipole Set 3121C		2/16	2/17
Antenna: C.D. B-101		2/16	2/17
Antenna: Solar 9229-1 & 9230-1		2/16	2/17
Audio Oscillator: H.P. 201CD		2/16	2/17
ELGAR Model: 1751		2/16	2/17
ELGAR Model: TG 704A-3D		2/16	2/17
ESD Test Set 2010i		2/16	2/17
Fast Transient Burst Generator Model: EFT/B-101		2/16	2/17
Field Intensity Meter: EFM-018		2/16	2/17
KEYTEK Ecat Surge Generator		2/16	2/17
Shielded Room 5 M x 3 M x 3.0 M			

Annex C Rogers Qualifications

Scot D. Rogers, Engineer

Rogers Labs, Inc.

Mr. Rogers has approximately 17 years' experience in the field of electronics. Engineering experience includes six years in the automated controls industry and remaining years working with the design, development and testing of radio communications and electronic equipment.

Positions Held

Systems Engineer: A/C Controls Mfg. Co., Inc. 6 Years

Electrical Engineer: Rogers Consulting Labs, Inc. 5 Years

Electrical Engineer: Rogers Labs, Inc. Current

Educational Background

- 1) Bachelor of Science Degree in Electrical Engineering from Kansas State University.
- 2) Bachelor of Science Degree in Business Administration Kansas State University.
- 3) Several Specialized Training courses and seminars pertaining to Microprocessors and Software programming.

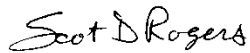

Scot D. Rogers



NVLAP Lab Code 200087-0

Annex D FCC Site Registration Letter

FEDERAL COMMUNICATIONS COMMISSION

**Laboratory Division
7435 Oakland Mills Road
Columbia, MD 21046**

April 16, 2015

Registration Number: 90910

Rogers Labs, Inc.
4405 West 259th Terrace
Louisburg, KS 66053

Attention: Scot Rogers,

Re: Measurement facility located at Louisburg
3 & 10 meter site
Date of Renewal: April 16, 2015

Dear Sir or Madam:

Your request for renewal of the registration of the subject measurement facility has been received. The information submitted has been placed in your file and the registration has been renewed. The name of your organization will remain on the list of facilities whose measurement data will be accepted in conjunction with applications for Certification under Parts 15 or 18 of the Commission's Rules. Please note that the file must be updated for any changes made to the facility and the registration must be renewed at least every three years.

Measurement facilities that have indicated that they are available to the public to perform measurement services on a fee basis may be found on the FCC website www.fcc.gov under E-Filing, OET Equipment Authorization Electronic Filing, Test Firms.

Sincerely,

Phyllis Parrish
Industry Analyst

Rogers Labs, Inc.
4405 W. 259th Terrace
Louisburg, KS 66053
Phone/Fax: (913) 837-3214
Revision 1

Mikrotikls SIA
Model: RBcAP2nD
Test #: 160714
Test to: 47CFR 15.247, RSS-247
File: Mikrotikls RBcAP2nD TstRpt 160714 r2

S/N: 69FE01DC4C2C/611
FCC ID#: TV7RBCM2ND
IC: 7442A-CM2ND
Date: August 8, 2016
Page 52 of 53



NVLAP Lab Code 200087-0

Annex E Industry Canada Site Registration Letter

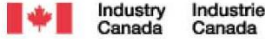

June 08, 2015

OUR FILE: 46405-3041
Authorization No: 010277847-001

Rogers Labs Inc.
4405 West 259th Terrace
Louisburg, KS
USA
66053

Attention: Mr. Scot D. Rogers

Dear Sir:

The Bureau has received your application for the renewal of 3m OATS. Be advised that the information received was satisfactory to Industry Canada. The following number(s) is now associated to the site(s) for which registration / renewal was sought (**Site# 3041A-1**). Please reference the appropriate site number in the body of test reports containing measurements performed on the site. In addition, please keep for your records the following information;

- The company address code associated to the site(s) located at the above address is: **3041A**

Furthermore, to obtain or renew a unique site number, the applicant shall demonstrate that the site has been accredited to ANSI C63.4-2009 or later. A scope of accreditation indicating the accreditation by a recognized accreditation body to ANSI C63.4-2009 or later shall be accepted. Please indicate in a letter the previous assigned site number if applicable and the type of site (example: 3 metre OATS or 3 metre chamber). If the test facility is not accredited to ANSI C63.4-2009 or later, the test facility shall submit test data demonstrating full compliance with the ANSI standard. The Bureau will evaluate the filing to determine if recognition shall be granted.

The frequency for re-validation of the test site and the information that is required to be filed or retained by the testing party shall comply with the requirements established by the accrediting organization. However, in all cases, test site re-validation shall occur on an interval not to exceed **three years**. There is no fee or form associated with an OATS filing. OATS submissions are encouraged to be submitted electronically to the Bureau using the following URL; http://strategis.ic.gc.ca/epic/internet/inceb-bhst.nsf/en/h_tt00052e.html.

If you have any questions, you may contact the Bureau by e-mail at certification.bureau@ic.gc.ca Please reference our file and submission number above for all correspondence.

Yours sincerely,

Bill Payn
For: Wireless Laboratory Manager
Certification and Engineering Bureau
3701 Carling Ave., Building 94
P.O. Box 11490, Station AH@
Ottawa, Ontario K2H 8S2
Email: certification.bureau@ic.gc.ca

Rogers Labs, Inc.
4405 W. 259th Terrace
Louisburg, KS 66053
Phone/Fax: (913) 837-3214
Revision 1

Mikrotikls SIA
Model: RBcAP2nD
Test #: 160714
Test to: 47CFR 15.247, RSS-247
File: Mikrotikls RBcAP2nD TstRpt 160714 r2

S/N: 69FE01DC4C2C/611
FCC ID#: TV7RBCM2ND
IC: 7442A-CM2ND
Date: August 8, 2016
Page 53 of 53