

SUBMITTAL APPLICATION REPORT

FOR
GRANT OF CERTIFICATION

FOR

Model: RB751U-2HnD
2412-2462 MHz
2422-2452 MHz (802.11n Mode)
2x2 MIMO 802.11 b/g/n Broadband Digital
Transmission System
FCC ID: TV7RB751-2HND

FOR

MIKROTIKLS SIA

Pernavas 46
Riga, Latvia LV-1009

Test Report Number: 110802

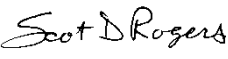
Authorized Signatory: 
Scot D. Rogers

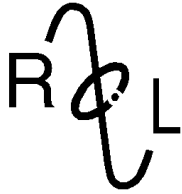

ROGERS LABS, INC.

4405 West 259th Terrace
Louisburg, KS 66053
Phone / Fax (913) 837-3214

Engineering Test Report For Grant of Certification Application

FOR
CFR 47, PART 15C - Intentional Radiators
CFR 47 Paragraph 15.247
License Exempt Intentional Radiator

For

MIKROTIKLS SIA

Pernavas 46
Riga, Latvia LV-1009

2x2 MIMO 802.11 b/g/n Broadband Digital Transmission System
Model: RB751U-2HnD
Frequency Range 2412-2462 MHz, 2422-2452 MHz (802.11n mode)
FCC ID#: TV7RB751-2HND

Test Date: August 2, 2011

Certifying Engineer: *Scot D. Rogers*
Scot D. Rogers
Rogers Labs, Inc.
4405 West 259th Terrace
Louisburg, KS 66053
Telephone/Facsimile: (913) 837-3214

This report shall not be reproduced except in full, without the written approval of the laboratory. This report must not be used by the client to claim product endorsement by NVLAP, NIST, or any agency of the U.S. Government.



Table Of Contents

TABLE OF CONTENTS..... 3

FORWARD 6

OPINION / INTERPRETATION OF RESULTS 6

ENVIRONMENTAL CONDITIONS..... 6

EQUIPMENT TESTED..... 6

APPLICATION FOR CERTIFICATION..... 7

APPLICABLE STANDARDS & TEST PROCEDURES 8

EQUIPMENT FUNCTION AND CONFIGURATION..... 8

Equipment Configuration.....9

TEST SITE LOCATIONS 9

UNITS OF MEASUREMENTS 9

TEST PROCEDURES..... 10

AC Line Conducted Emission Test Procedure10

Radiated Emission Test Procedure.....10

LIST OF TEST EQUIPMENT 11

INTENTIONAL RADIATORS..... 12

Antenna Requirements12

Restricted Bands of Operation.....12

 Radiated Emissions in Restricted Bands Data (worst-case configuration presented)..... 12

Summary of Results for Radiated Emissions in Restricted Bands13

AC Line Conducted Emissions Procedure13

 Figure 1 AC Line Conducted Emissions Line 1 14

 Figure 2 AC Line Conducted Emissions Line 2 14

 AC Line Conducted Emissions Data (Highest Emissions)..... 15

Summary of Results for AC Line Conducted Emissions15



General Radiated Emissions Procedure.....16

Figure 3 General Radiated Emissions taken at 1 meter in screen room..... 17

Figure 4 General Radiated Emissions taken at 1 meter in screen room..... 17

Figure 5 General Radiated Emissions taken at 1 meter in screen room..... 18

Figure 6 General Radiated Emissions taken at 1 meter in screen room..... 18

Figure 7 General Radiated Emissions taken at 1 meter in screen room..... 19

Figure 8 General Radiated Emissions taken at 1 meter in screen room..... 19

Figure 9 General Radiated Emissions taken at 1 meter in screen room..... 20

Figure 10 General Radiated Emissions taken at 1 meter in screen room..... 20

General Radiated Emissions from EUT Data (Highest Emissions)..... 21

Summary of Results for General Radiated Emissions21

Operation in the Frequency Band of 2400 – 2483.5 MHz.....22

Figure 11 Plot of Antenna Port Emissions (Across Operational Band, 5MHz Mode) 23

Figure 12 Plot of Antenna Port Emissions (Across Operational Band, 10MHz Mode)..... 23

Figure 13 Plot of Antenna Port Emissions (Across Operational Band, 20MHz Mode)..... 24

Figure 14 Plot of Antenna Port Emissions (Across Operational Band, 40MHz Mode)..... 24

Figure 15 Plot of Plot of 6dB Band width (5 MHz Mode, 2412 MHz) 25

Figure 16 Plot of Plot of 6dB Band width (5 MHz Mode, 2437 MHz) 25

Figure 17 Plot of Plot of 6dB Band width (5 MHz Mode, 2462 MHz) 26

Figure 18 Plot of 6dB Band width (20 MHz Mode, 2412 MHz)..... 26

Figure 19 Plot of 6dB Band width (20 MHz Mode, 2437 MHz)..... 27

Figure 20 Plot of 6dB Band width (20 MHz Mode, 2462 MHz)..... 27

Figure 21 Plot of 6dB Band width (40 MHz Mode, 2422 MHz)..... 28

Figure 22 Plot of 6dB Band width (40 MHz Mode, 2447 MHz)..... 28

Figure 23 Plot of 6dB Band width (40 MHz Mode, 2452 MHz)..... 29

Figure 24 Plot of Power Spectral Density (5 MHz Mode, 2412 MHz) 29

Figure 25 Plot of Power Spectral Density (5 MHz Mode, 2437 MHz) 30

Figure 26 Plot of Power Spectral Density (5 MHz Mode, 2462 MHz) 30

Figure 27 Plot of Power Spectral Density (20 MHz Mode, 2412 MHz) 31

Figure 28 Plot of Power Spectral Density (20 MHz Mode, 2437 MHz) 31

Figure 29 Plot of Power Spectral Density (20 MHz Mode, 2462 MHz) 32

Figure 30 Plot of Power Spectral Density (40 MHz Mode, 2422 MHz) 32

Figure 31 Plot of Power Spectral Density (40 MHz Mode, 2447 MHz) 33

Figure 32 Plot of Power Spectral Density (40 MHz Mode, 2452 MHz) 33

Figure 33 Plot of Antenna port conducted emissions 34

Figure 34 Plot of Antenna port conducted emissions 34

Figure 35 Plot of Antenna port conducted emissions 35

Figure 36 Plot of Antenna port conducted emissions 35

Figure 37 Plot of Antenna port conducted emissions 36

Figure 38 Plot of Antenna port conducted emissions 36

Figure 39 Plot of Band Edge Compliance at Antenna port (worst-case)..... 37



Figure 40 Plot of Band Edge Compliance at Antenna port (worst-case)37

Transmitter Emissions Data.....38

Transmitter Antenna port Conducted Emissions Data (Worst-case)38

Transmitter Antenna port Conducted Emissions Data.....38

Transmitter Antenna port Conducted Emissions Data (5 MHz Channel).....39

Transmitter Antenna port Conducted Emissions Data (10 MHz Channel).....39

Transmitter Antenna port Conducted Emissions Data (20 MHz Channel).....40

Transmitter Antenna port Conducted Emissions Data (40 MHz Channel).....40

Transmitter Radiated Emission (5.5 dBi Internal Antenna, Worst-case).....41

Transmitter Radiated Emission (7.4 dBi Omni, Worst-case)41

Transmitter Radiated Emission (8.5 dBi Panel, Worst-case).....42

Summary of Results for Transmitter Radiated Emissions of Intentional Radiator.....42

STATEMENT OF MODIFICATIONS AND DEVIATIONS 42

ANNEX..... 43

Annex A Measurement Uncertainty Calculations.....44

Annex B Rogers Labs Test Equipment List.....46

Annex C Rogers Qualifications.....47

Annex D FCC Site Registration Letter.....48

Annex E Industry Canada Site Registration Letter49



Forward

The following information is submitted for consideration in obtaining Grant of Certification for License Exempt Digital Transmission System Intentional Radiator operating under CFR 47 Paragraph 15.247.

Name of Applicant: Mikrotiks SIA
 Pernavas 46
 Riga, Latvia LV-1009

Model: RB751U-2HnD

FCC I.D.: TV7RB751-2HND FRN: 0014 43 1100

Frequency Range: 2412-2462 MHz (802.11 b/g), 2422-2452 MHz (802.11n mode)

Operating Power: 0.5-Watts output power single chain, 1-Watt 2 chains operational

Opinion / Interpretation of Results

Tests Performed	Margin (dB)	Results
Emissions as per CFR 47 paragraphs 2 and 15.205	-0.6	Complies
Emissions as per CFR 47 paragraphs 2 and 15.207	-10.8	Complies
Emissions as per CFR 47 paragraphs 2 and 15.209	-4.3	Complies
Emissions as per CFR 47 paragraphs 2 and 15.247	-0.6	Complies

Environmental Conditions

Ambient Temperature 26.9° C
 Relative Humidity 45%
 Atmospheric Pressure 1004.0 mb

Equipment Tested

<u>Equipment</u>	<u>Model</u>	<u>FCC I.D.</u>
EUT	RB751U-2HnD	TV7RB751-2HND
AC Adapter	KSAS024240008	N/A
USB Memory Stick	Verbatim 10050405316G50AAF	N/A
Dell Studio XPS	921LBN1	N/A

<u>Antenna/Type</u>	<u>Model</u>	<u>Gain</u>
Internal	RB751U-2HnD	5.5 dBi
Omni Directional	SF-245	7.5 dBi
Flat Panel	AAI-00089	8.5 dBi

Application for Certification

- (1) Manufacturer: Mikrotikls SIA
Pernavas 46
Riga, Latvia LV-1009
- (2) Identification: Model: RB751U-2HnD

FCC I.D.: TV7RB751-2HND
- (3) Instruction Book:

Refer to Exhibit for Instruction Manual.
- (4) Description of Circuit Functions:

Refer to Exhibit of Operational Description.
- (5) Block Diagram with Frequencies:

Refer to Exhibit of Operational Description.
- (6) Report of Measurements:

Report of measurements follows in this Report.
- (7) Photographs: Construction, Component Placement, etc.:

Refer to Exhibit for photographs of equipment.
- (8) List of Peripheral Equipment Necessary for operation. The equipment operates from power received from authorized AC power adapter or POE (Power Over Ethernet). The EUT offers connection ports for authorized antennas, power, USB, and network cables. During testing the EUT was connected to CPU through network cable, power supplied from external AC adapter, and USB memory stick.
- (9) Transition Provisions of CFR47 15.37 are not requested.
- (10) Not Applicable. The unit is not a scanning receiver.
- (11) Not Applicable. The EUT does not operate in the 59 – 64 GHz frequency band.
- (12) The equipment is not software defined and this section is not applicable.



Applicable Standards & Test Procedures

In accordance with the Federal Communications Code of Federal Regulations, dated October 1, 2010, Part 2, Subpart J, Paragraphs 2.907, 2.911, 2.913, 2.925, 2.926, 2.1031 through 2.1057, and applicable parts of paragraph 15, Part 15C Paragraph 15.247 the following information is submitted.

Test procedures used are the established Methods of Measurement of Radio-Noise Emissions as described in the ANSI C63.4-2009 Document, FCC documents KDB 662911 MIMO, DA00-1407 and DA00-705 and/or TIA/EIA 603-1. Testing for the AC line-conducted emissions were performed as defined in sections 7 and 13.1.3, testing of the radiated emissions was performed as defined in sections 8 and 13.1.4 of ANSI C63.4-2009. Testing of the intentional radiated emissions was performed as defined in section 13 of ANSI C63.4-2009.

Equipment Function and Configuration

The EUT is a 2412-2462 MHz 2x2 Multiple Input Multiple Output (MIMO) 802.11 b/g/n Digital Transmission System transmitter. The design incorporates internal and external antenna ports (chain 0 and 1 respectively). The equipment is used to transmit data in applications offering broadband wireless connectivity. The design offers operation in one of three modes; 1) Tx/Rx both chains; 2) Tx chain 0, Rx chain 1; 3) Rx chain 0, Tx chain 1. The equipment is marketed for use to incorporate a wireless link to exchange data information from one point to another. For testing purposes, the RB751U-2HnD transceiver was connected to the manufacturer supplied AC power adapter, USB memory stick, and communicating to the laptop computer allowing for operational control of the transmitter and communications over the network interface between the EUT and supporting computer system. The RB751U-2HnD receives power from the supplied AC power adapter or POE connected to utility power systems. The EUT offers connection ports for authorized antennas (chain 1), power, USB interface, and network only and requires power supplied from external source (AC adapter or POE), no other interfacing options are provided. For testing purposes, the RB751U-2HnD was powered from the AC power adapter and set to transmit in available data modes. Worst-case data presented in this report. The device is marketed for professional installation and antenna connection and options comply with the unique antenna connection requirements.

Equipment Configuration

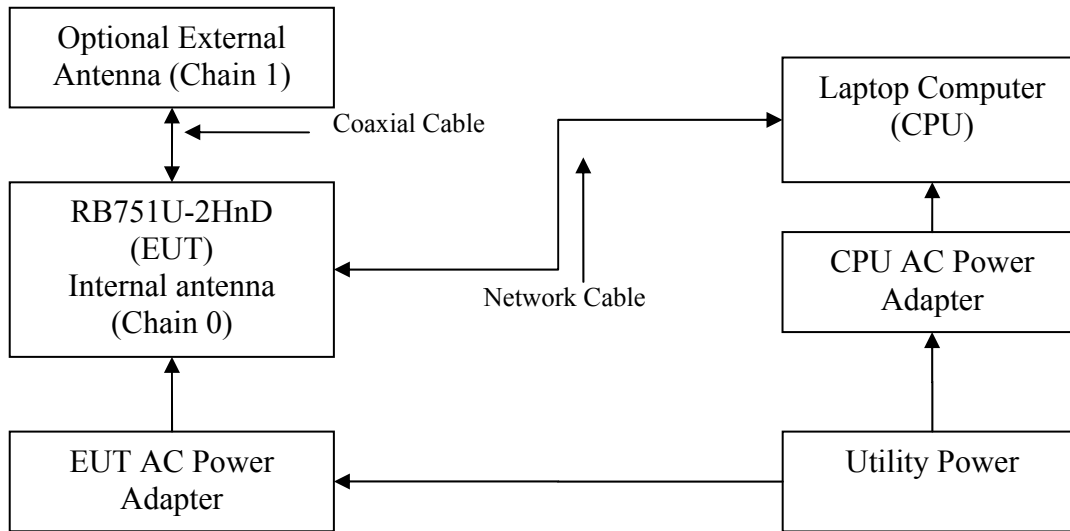

Test Site Locations

- Conducted EMI** The AC power line conducted emissions testing performed in a shielded screen room located at Rogers Labs, Inc., 4405 W. 259th Terrace, Louisburg, KS
- Radiated EMI** The radiated emissions tests were performed at the 3 meters, Open Area Test Site (OATS) located at Rogers Labs, Inc., 4405 W. 259th Terrace, Louisburg, KS
- Site Registration** Refer to Annex for Site Registration Letters
- NVLAP Accreditation** Lab code 200087-0

Units of Measurements

- Conducted EMI** Data is in dB μ V; dB referenced to one microvolt
- Radiated EMI** Data is in dB μ V/m; dB/m referenced to one microvolt per meter

Sample Calculation:

RFS = Radiated Field Strength, FSM = Field Strength Measured
 A.F. = Receive antenna factor, Gain = amplification gains and/or cable losses

$$RFS \text{ (dB}\mu\text{V/m @ 3m)} = FSM \text{ (dB}\mu\text{V)} + A.F. \text{ (dB)} - \text{Gain (dB)}$$

Test Procedures

AC Line Conducted Emission Test Procedure

The EUT operates from DC power only and must be connected to an approved AC adapter/POE for operation. For testing purposes, the manufacturer supplied AC power adapter was used to power the EUT and system. Testing for the AC line-conducted emissions testing was performed as defined in sections 7 and 13.1.3 of ANSI C63.4-2009. The test setup including the EUT was arranged in typical equipment configurations and placed on a 1 x 1.5-meter wooden bench, 0.8 meters high located in a screen room. The power lines of the system were isolated from the power source using a standard LISN with a 50- μ Hy choke. EMI was coupled to the spectrum analyzer through a 0.1 μ F capacitor internal to the LISN. The LISN was positioned on the floor beneath the wooden bench supporting the EUT. The power lines and cables were draped over the back edge of the table.

Radiated Emission Test Procedure

The EUT was placed on a rotating 1 x 1.5-meter wooden platform, 0.8 meters above the ground plane at a distance of 3 meters from the FSM antenna. Testing for the radiated emissions was performed as defined in sections 8 and 13.1.4 of ANSI C63.4-2009. EMI energy was maximized by equipment placement, raising and lowering the FSM antenna, changing the antenna polarization, and by rotating the turntable. Each emission was maximized before data was taken using a spectrum analyzer. Refer to photographs in the test setup exhibits for EUT placement during testing.

List of Test Equipment

A Rohde and Schwarz ESU40 and/or Hewlett Packard 8591EM was used as the measuring device for the emissions testing of frequencies below 1 GHz. A Rohde and Schwarz ESU40 and/or Hewlett Packard 8562A Spectrum Analyzer was used as the measuring device for testing the emissions at frequencies above 1 GHz. The analyzer settings used are described in the following table. Refer to the appendix for a complete list of test equipment.

AC Line Conducted Emissions (0.150 -30 MHz)		
RBW	AVG. BW	Detector Function
9 kHz	30 kHz	Peak / Quasi Peak
Emissions (30-1000 MHz)		
RBW	AVG. BW	Detector Function
120 kHz	300 kHz	Peak / Quasi Peak
Emissions (Above 1000 MHz)		
RBW	Video BW	Detector Function
100 kHz	100 kHz	Peak
1 MHz	1 MHz	Peak / Average

<u>Equipment</u>	<u>Manufacturer</u>	<u>Model</u>	<u>Calibration Date</u>	<u>Due</u>
LISN	Comp. Design	FCC-LISN-2-MOD.CD	10/10	10/11
Antenna	ARA	BCD-235-B	10/10	10/11
Antenna	EMCO	3147	10/10	10/11
Antenna	EMCO	3143	5/11	5/12
Analyzer	HP	8591EM	5/11	5/12
Analyzer	HP	8562A	5/11	5/12
Analyzer	Rohde & Schwarz	ESU40	5/11	5/12



Intentional Radiators

As per CFR47, Subpart C, paragraph 15.247 the following information is submitted.

Antenna Requirements

The EUT design incorporates internal antenna for Chain 0 and MMCX antenna connection port for chain 1 for use with authorized antenna systems only. The design is marketed for professional installation and use as described in accompanying documentation. The antenna connection point complies with the unique antenna connection requirements. The requirements of 15.203 are fulfilled; there are no deviations or exceptions to the specification.

Restricted Bands of Operation

Spurious emissions falling in the restricted frequency bands of operation were measured at a distance of three meters on the OATS. The EUT utilizes frequency, determining circuitry, which generates harmonics falling in the restricted bands. Emissions were measured at the OATS, using appropriate antennas or pyramidal horns, amplification stages, and a spectrum analyzer. No other significant emission was observed which fell into the restricted bands of operation.

Radiated Emissions in Restricted Bands Data (worst-case configuration presented)

Frequency in MHz	Horizontal Peak (dBµV/m)	Horizontal Quasi-Peak (dBµV/m)	Horizontal Average (dBµV/m)	Vertical Peak (dBµV/m)	Vertical Quasi-Peak (dBµV/m)	Vertical Average (dBµV/m)	Limit @ 3m (dBµV/m)
111.6	39.5	36.8	N/A	35.2	32.5	N/A	43.5
125.0	35.7	33.2	N/A	29.9	26.8	N/A	43.5
137.2	37.7	33.6	N/A	33.2	30.0	N/A	43.5
250.0	43.3	41.7	N/A	32.0	29.6	N/A	43.5
2390.0	45.5	N/A	32.8	48.8	N/A	36.5	54.0
2483.5	45.9	N/A	33.6	56.4	N/A	49.5	54.0
4824.0	59.4	N/A	50.8	57.7	N/A	47.9	54.0
4874.0	56.9	N/A	44.6	59.5	N/A	52.4	54.0
4924.0	54.0	N/A	16.6	16.1	N/A	53.4	54.0
7236.0	49.8	N/A	37.2	53.6	N/A	41.6	54.0
7311.0	45.0	N/A	32.7	46.8	N/A	33.7	54.0
7386.0	54.0	N/A	16.6	16.1	N/A	34.5	54.0
12060.0	48.7	N/A	36.2	49.1	N/A	36.7	54.0
12185.0	48.1	N/A	35.9	48.4	N/A	35.9	54.0
12310.0	54.0	N/A	16.6	16.1	N/A	35.8	54.0

Other emissions present had amplitudes at least 20 dB below the limit.

Quasi-Peak amplitude emissions are recorded above for frequency range of 30-1000 MHz.

Average amplitude emissions are recorded above for frequency range above 1000 MHz.

Summary of Results for Radiated Emissions in Restricted Bands

The EUT demonstrated compliance with the radiated emissions requirements of CFR 47 Part 15C Intentional Radiators. The EUT demonstrated a minimum margin of -0.6 dB below the radiated emissions requirements in restricted frequency bands. Peak, Quasi-peak, and average amplitudes were checked for compliance with the regulations. Worst-case emissions are reported with other emissions found in the restricted frequency bands at least 20 dB below the requirements.

AC Line Conducted Emissions Procedure

The EUT was arranged in a typical equipment configuration and placed on a 1 x 1.5-meter wooden bench 80 cm above the conducting ground plane, floor of a screen room. The bench was positioned 40 cm away from the wall of the screen room. The LISN was positioned on the floor of the screen room 80-cm from the rear of the EUT. The manufacturer supplied AC power adapter/POE for the EUT was connected to the LISN. A second LISN was positioned on the floor of the screen room 80-cm from the rear of the supporting equipment of the EUT. All power cords except the EUT were then powered from the second LISN. EMI was coupled to the spectrum analyzer through a 0.1 μ F capacitor, internal to the LISN. Power line conducted emissions testing were carried out individually for each current carrying conductor of the EUT. The excess length of lead between the system and the LISN receptacle was folded back and forth to form a bundle not exceeding 40 cm in length. The screen room, conducting ground plane, analyzer, and LISN were bonded together to the protective earth ground. Preliminary testing was performed to identify the frequency of each radio frequency emission displaying the highest amplitude. The cables were repositioned to obtain maximum amplitude of measured EMI level. Once the worst-case configuration was identified, plots were made of the EMI from 0.15 MHz to 30 MHz then the data was recorded with maximum conducted emissions levels. Refer to figures one and two for plots of the EUT powered by AC adapter, AC Power Line conducted emissions.

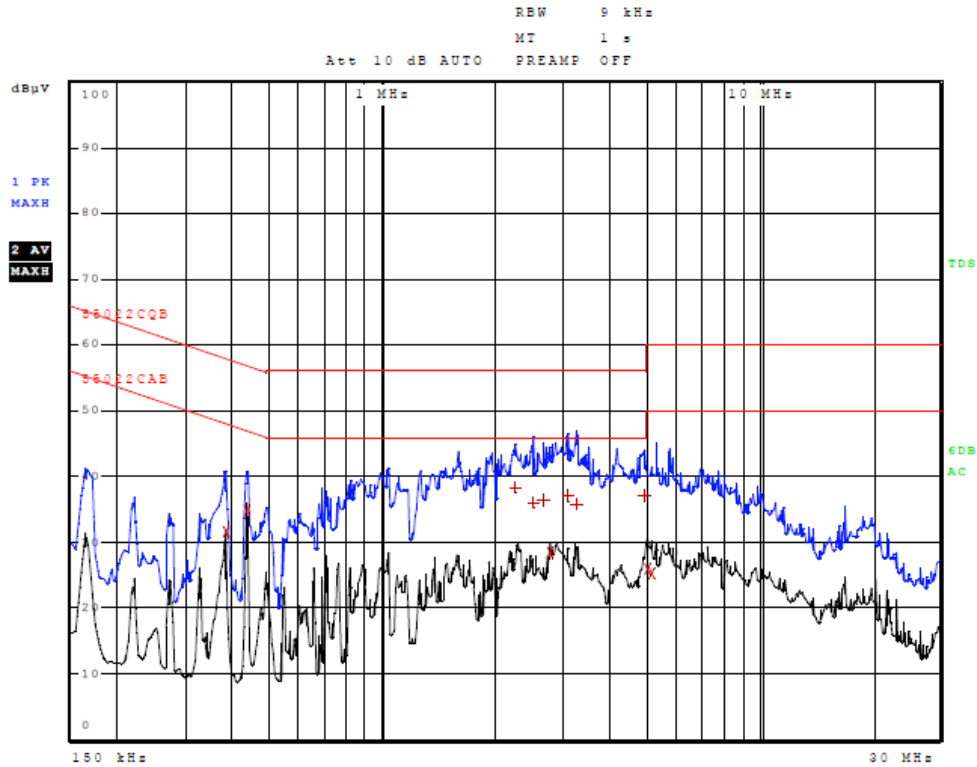

Figure 1 AC Line Conducted Emissions Line 1

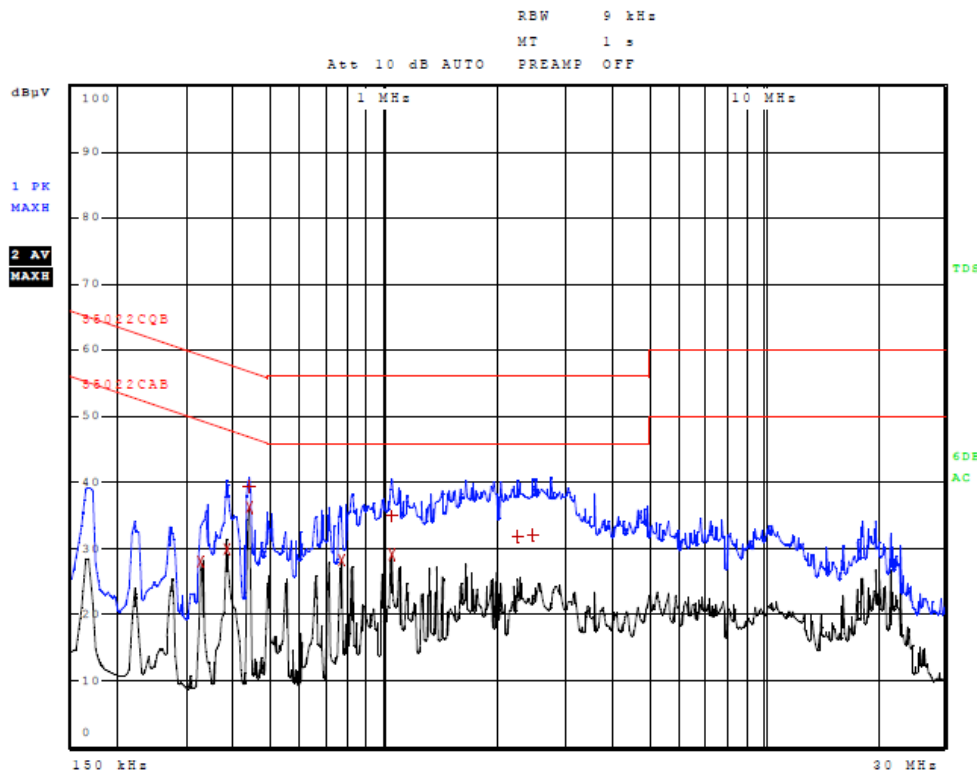

Figure 2 AC Line Conducted Emissions Line 2

AC Line Conducted Emissions Data (Highest Emissions)

Line 1

Trace	Frequency	Level (dBµV)	Detector	Delta Limit/dB
2	382.000000000 kHz	31.65	Average	-16.58
2	434.000000000 kHz	34.70	Average	-12.48
1	2.242000000 MHz	38.38	Quasi Peak	-17.62
1	2.506000000 MHz	36.12	Quasi Peak	-19.88
1	2.654000000 MHz	36.40	Quasi Peak	-19.60
2	2.778000000 MHz	28.55	Average	-17.45
1	3.106000000 MHz	37.15	Quasi Peak	-18.85
1	3.254000000 MHz	35.75	Quasi Peak	-20.25
1	4.958000000 MHz	37.18	Quasi Peak	-18.82
2	5.056000000 MHz	25.94	Average	-24.06
2	5.176000000 MHz	25.21	Average	-24.79

Line 2

Trace	Frequency	Level (dBµV)	Detector	Delta Limit/dB
2	330.000000000 kHz	27.94	Average	-21.51
2	382.000000000 kHz	29.87	Average	-18.36
2	438.000000000 kHz	36.28	Average	-10.82
1	438.000000000 kHz	39.33	Quasi Peak	-17.77
2	766.000000000 kHz	28.21	Average	-17.79
2	1.042000000 MHz	29.20	Average	-16.80
1	1.042000000 MHz	35.03	Quasi Peak	-20.97
1	2.242000000 MHz	31.74	Quasi Peak	-24.26
1	2.470000000 MHz	31.93	Quasi Peak	-24.07

Other emissions present had amplitudes at least 20 dB below the limit.

Summary of Results for AC Line Conducted Emissions

The EUT demonstrated compliance to the conducted emissions requirements of CFR47 Part 15C equipment. The EUT demonstrated minimum margin of -10.8 dB below the limit.

Measurements were taken using the peak, quasi peak, and average, measurement function for each emissions amplitude and were below the limits stated in the specification. Other emissions were present with recorded data representing worst-case amplitudes.



General Radiated Emissions Procedure

The EUT was arranged in a typical equipment configuration and operated through all available modes with worst-case data recorded. Preliminary testing was performed in a screen room with the EUT positioned 1 meter from the FSM. Radiated emissions measurements were performed to identify the frequencies, which produced the highest emissions. Plots were made of the radiated frequency spectrum from 30 MHz to 25,000 MHz for the preliminary testing. Refer to figures three through ten for plots of the general radiated emissions spectrum taken in a screen room. Each radiated emission was then maximized at the OATS location before final radiated emissions measurements were performed. Final data was taken with the EUT located at the OATS at a distance of 3 meters between the EUT and the receiving antenna. The frequency spectrum from 30 MHz to 60,000 MHz was searched for general radiated emissions. Measured emission levels were maximized by EUT placement on the table, rotating the turntable through 360 degrees, varying the antenna height between 1 and 4 meters above the ground plane and changing antenna position between horizontal and vertical polarization. Antennas used were Broadband Biconical from 30 to 200 MHz, Biconilog from 30 to 6000 MHz, Log Periodic from 200 MHz to 5 GHz and or double Ridge or pyramidal horns and mixers from 4 GHz to 60 GHz, notch filters and appropriate amplifiers and external mixers were utilized.

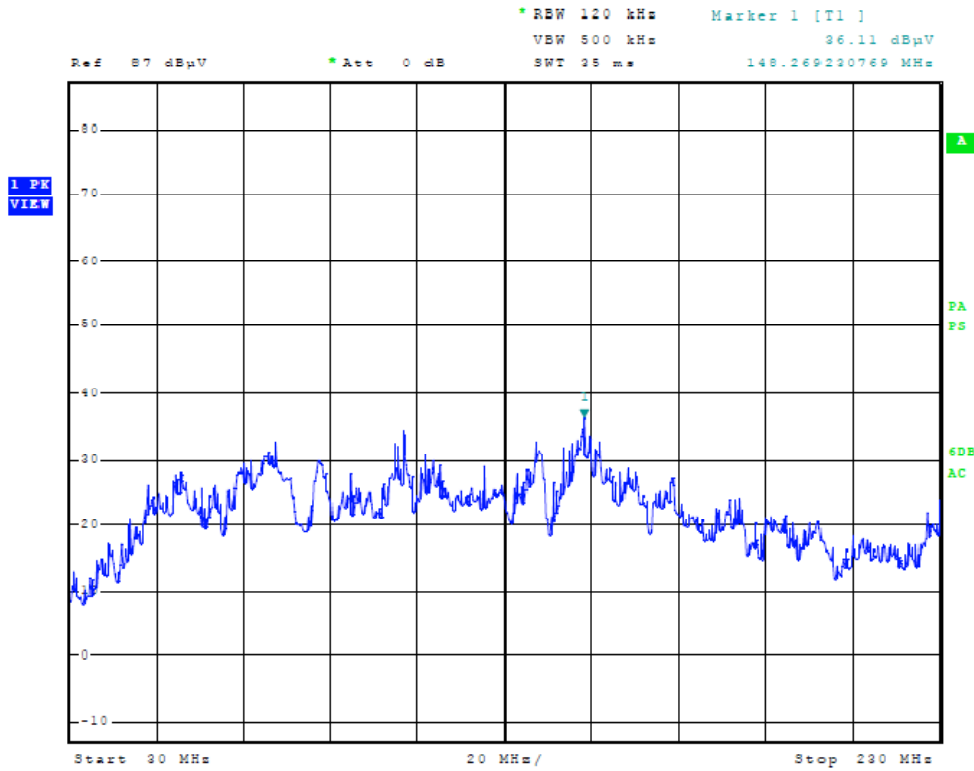

Figure 3 General Radiated Emissions taken at 1 meter in screen room

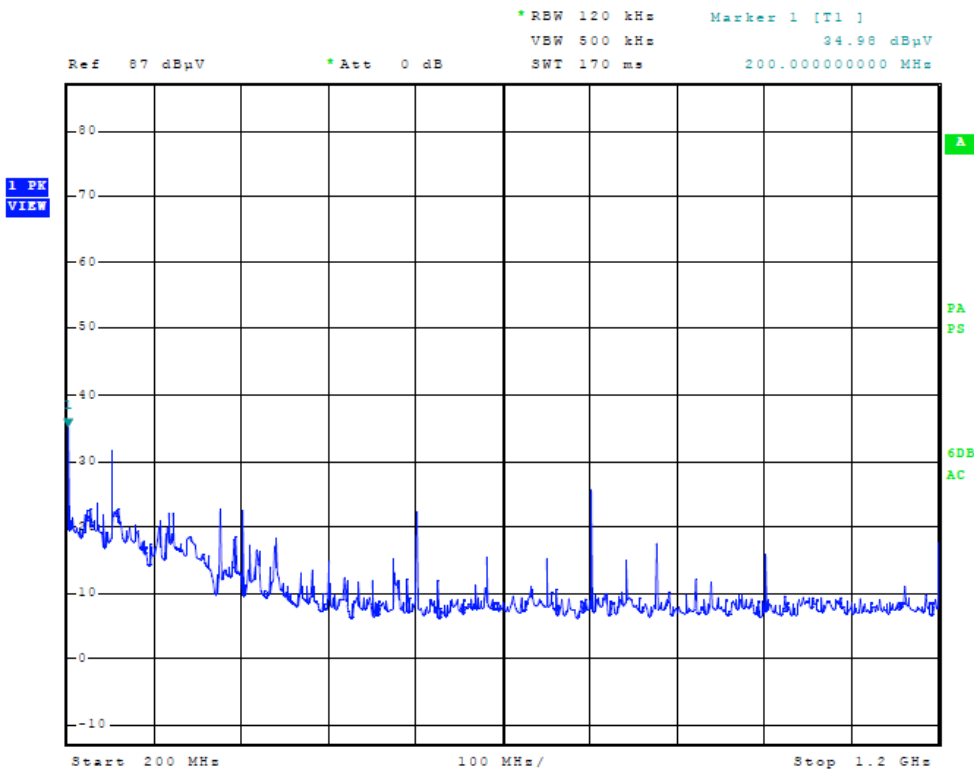

Figure 4 General Radiated Emissions taken at 1 meter in screen room

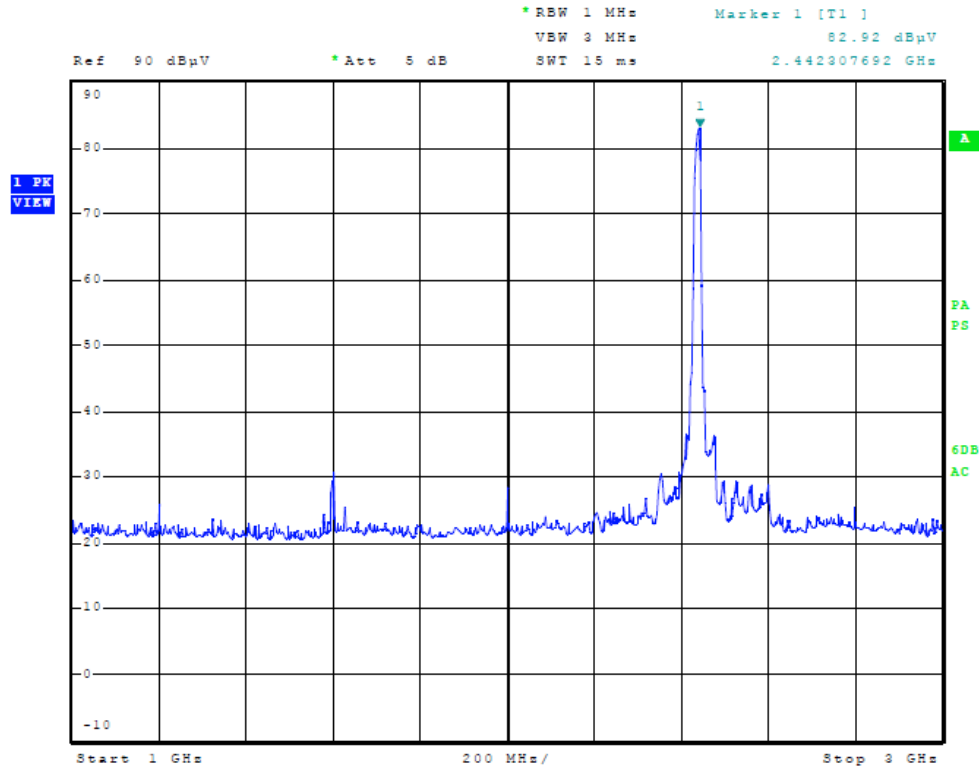

Figure 5 General Radiated Emissions taken at 1 meter in screen room

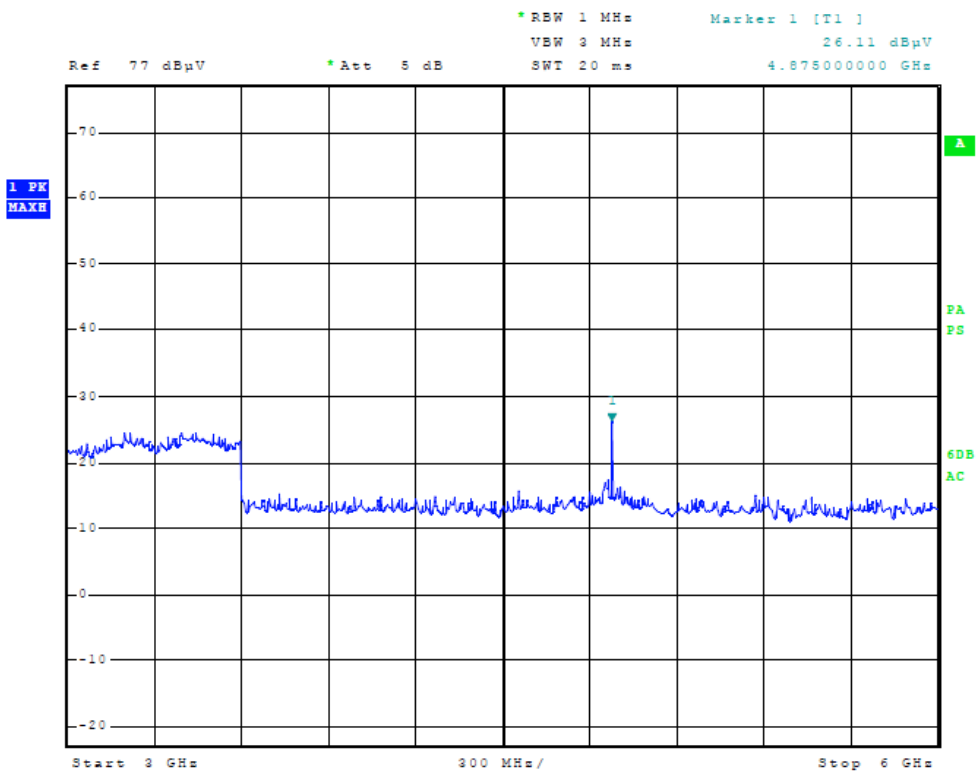

Figure 6 General Radiated Emissions taken at 1 meter in screen room

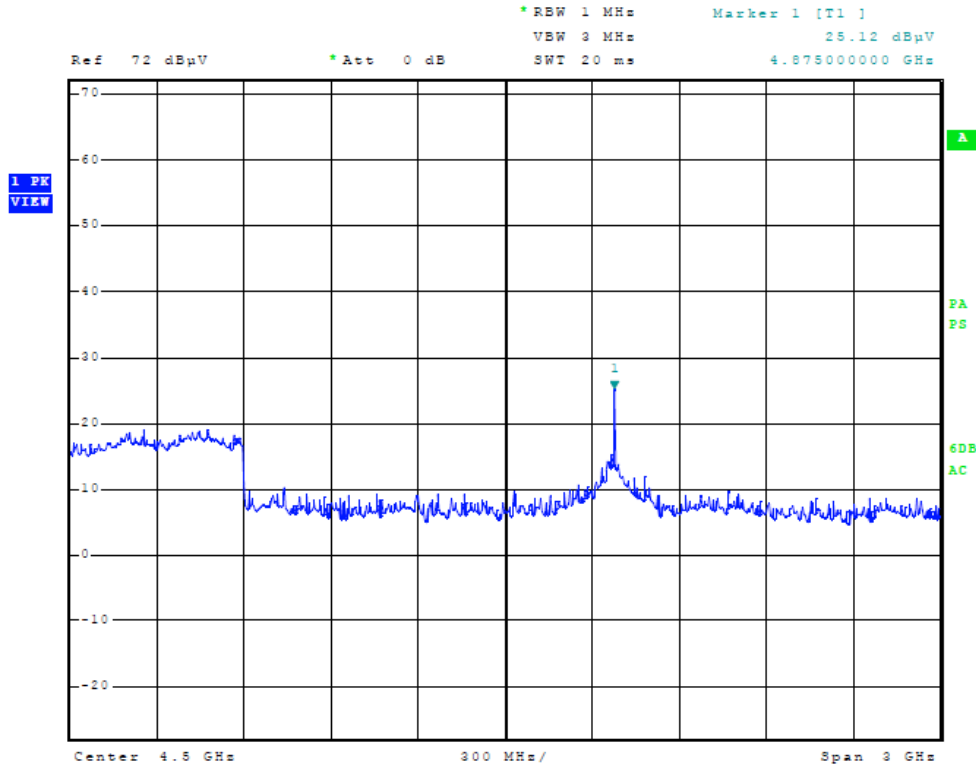

Figure 7 General Radiated Emissions taken at 1 meter in screen room

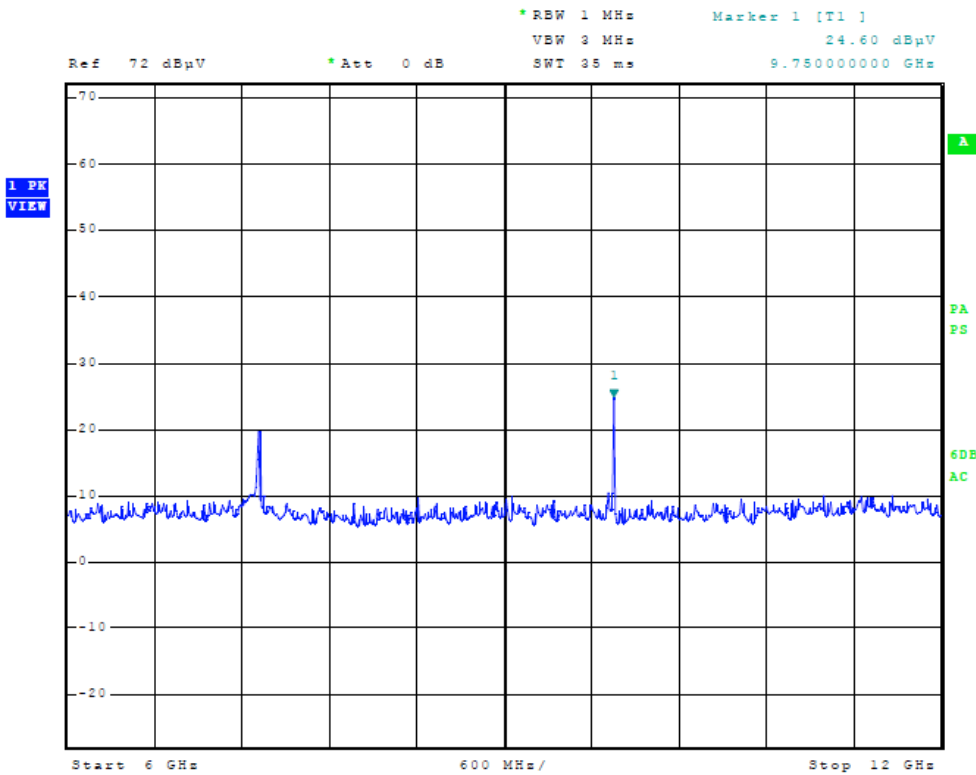

Figure 8 General Radiated Emissions taken at 1 meter in screen room

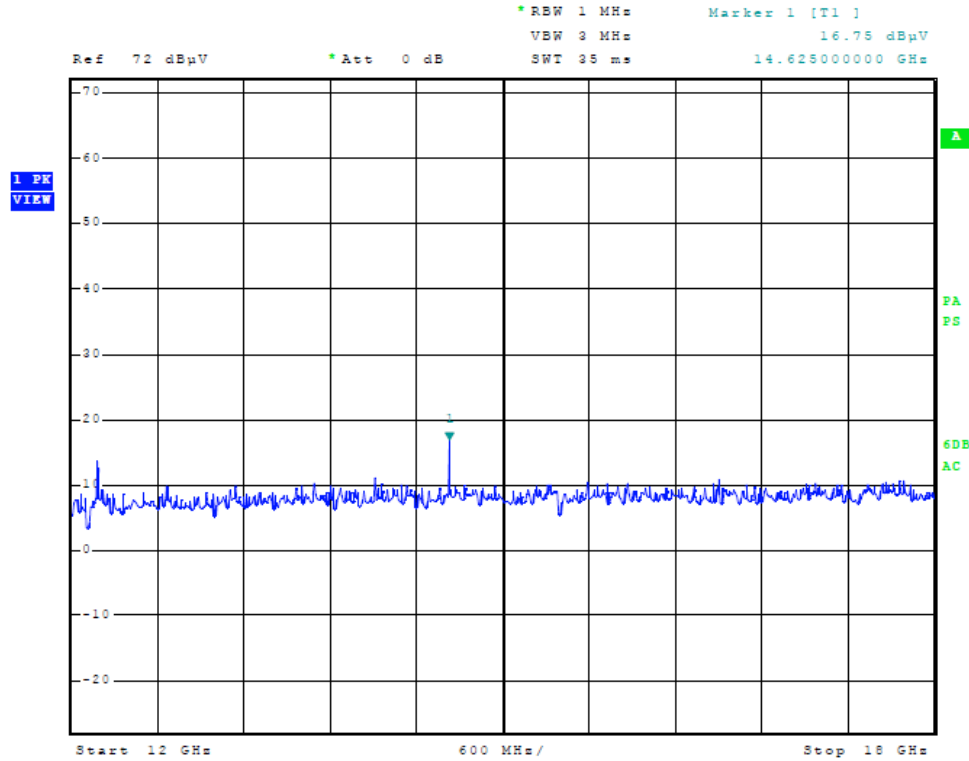

Figure 9 General Radiated Emissions taken at 1 meter in screen room

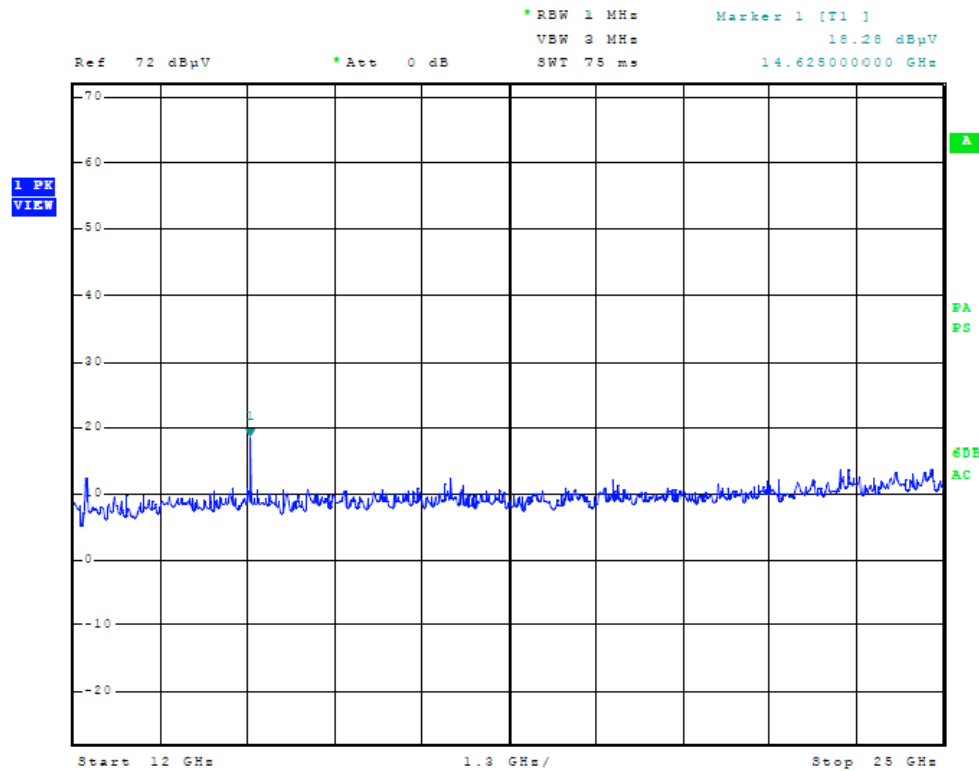

Figure 10 General Radiated Emissions taken at 1 meter in screen room

General Radiated Emissions from EUT Data (Highest Emissions)

Frequency in MHz	Horizontal Peak (dBµV/m)	Horizontal Quasi-Peak (dBµV/m)	Horizontal Average (dBµV/m)	Vertical Peak (dBµV/m)	Vertical Quasi-Peak (dBµV/m)	Vertical Average (dBµV/m)	Limit @ 3m (dBµV/m)
106.8	40.4	36.9	N/A	37.4	33.0	N/A	43.5
111.6	39.5	36.8	N/A	35.2	32.5	N/A	43.5
125.0	35.7	33.2	N/A	29.9	26.8	N/A	43.5
137.2	37.7	33.6	N/A	33.2	30.0	N/A	43.5
143.3	42.0	38.2	N/A	39.1	35.3	N/A	43.5
144.7	40.4	38.3	N/A	38.2	35.7	N/A	43.5
145.2	39.5	37.8	N/A	37.9	35.1	N/A	43.5
146.7	38.6	36.2	N/A	36.9	34.1	N/A	43.5
148.1	41.5	38.8	N/A	39.8	35.4	N/A	43.5
149.3	37.5	35.1	N/A	35.7	32.4	N/A	43.5

Other emissions present had amplitudes at least 20 dB below the limit.

Quasi-Peak amplitude emissions are recorded above for frequency range of 30-1000 MHz.

Average amplitude emissions are recorded above for frequency range above 1000 MHz.

Summary of Results for General Radiated Emissions

The EUT demonstrated compliance with the radiated emissions requirements of CFR47 Part 15C paragraph 15.209 Intentional Radiators. The EUT demonstrated a minimum margin of -4.3 dB below the requirements. Other emissions were present with amplitudes at least 20 dB below the Limits. Note: peak amplitudes measured for 1596.9 MHz – horizontal 36.4, vertical 34.2 dBµV.



Operation in the Frequency Band of 2400 – 2483.5 MHz

The power output and emissions were measured at the antenna port and OATS range in compliance with regulation and KDB 662911 guidance. The 2x2 MIMO equipment utilizes the internal antenna and external MMCX antenna connection ports for either transmit or receive. As this product offers single point for antenna port connection, use of the KDB-662911 measure and adds $10\log_e(N)$ dBi (where N is the number of outputs) was utilized in reporting antenna port power spectral density. Summing of emissions approach was used for comparison to in-band transmit power emissions limits. The measure and add “ $10\log(N)$ dB” method was used in determining compliance for In-Band Power Spectral Density (PSD). These test configurations demonstrate worst-case emissions in compliance with regulation. Antenna port conducted emissions were performed with both chains active in transmit operation. EUT radiated emissions were measured on the open area test site at a three-meter distance. The EUT and test configurations were placed on a wooden turntable 0.8 meters above the ground plane at a distance of 3 meters from the FSM antenna. The peak and quasi-peak amplitude of the frequencies below 1000 MHz were measured using a spectrum analyzer. The peak and average amplitude of emissions above 1000 MHz including were measured using a spectrum analyzer. Data was recorded from the analyzer measurement result. Plots were made of transmitter antenna port conducted performance taken in a screen room. Refer to figures eleven through forty showing plots of the EUT emissions performance displaying compliance with the specifications.

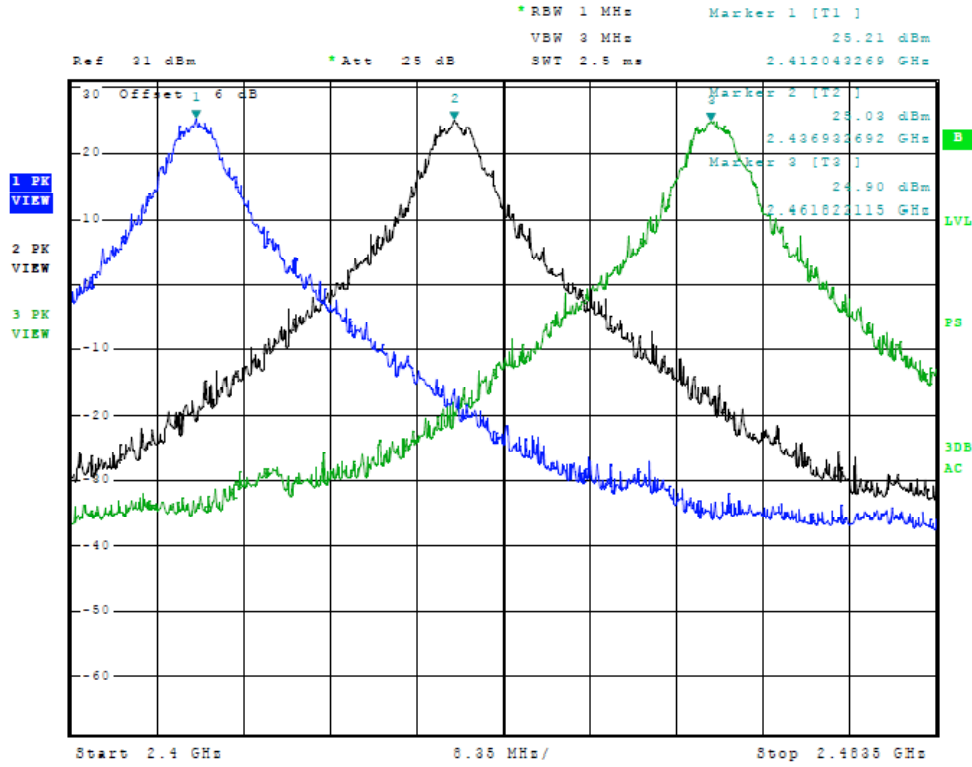

Figure 11 Plot of Antenna Port Emissions (Across Operational Band, 5MHz Mode)

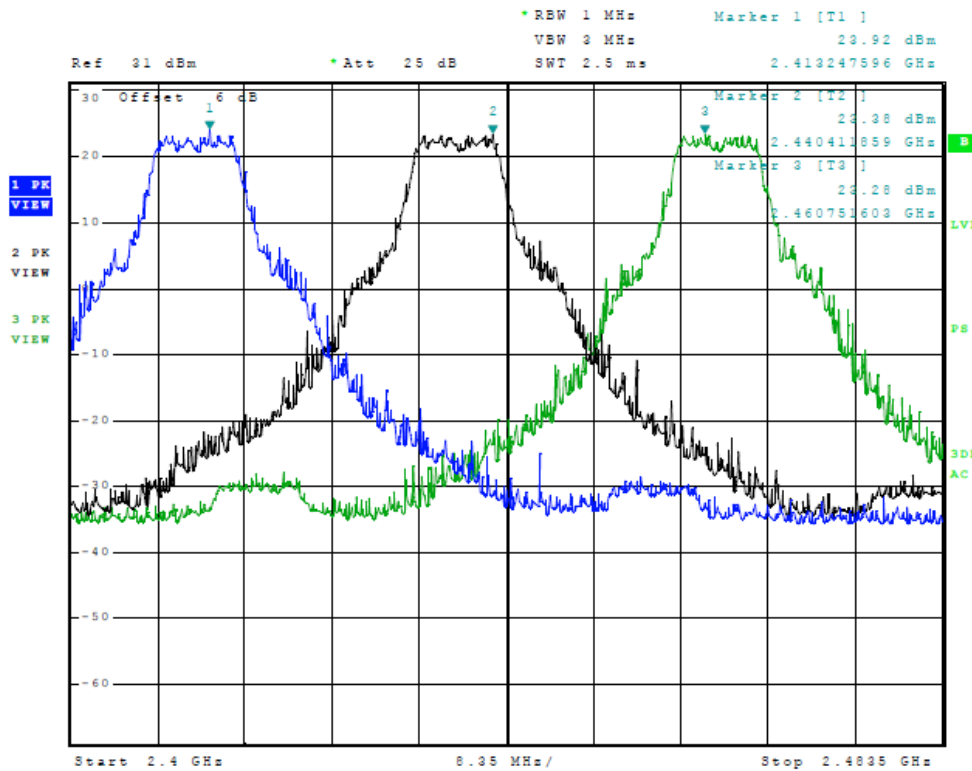

Figure 12 Plot of Antenna Port Emissions (Across Operational Band, 10MHz Mode)

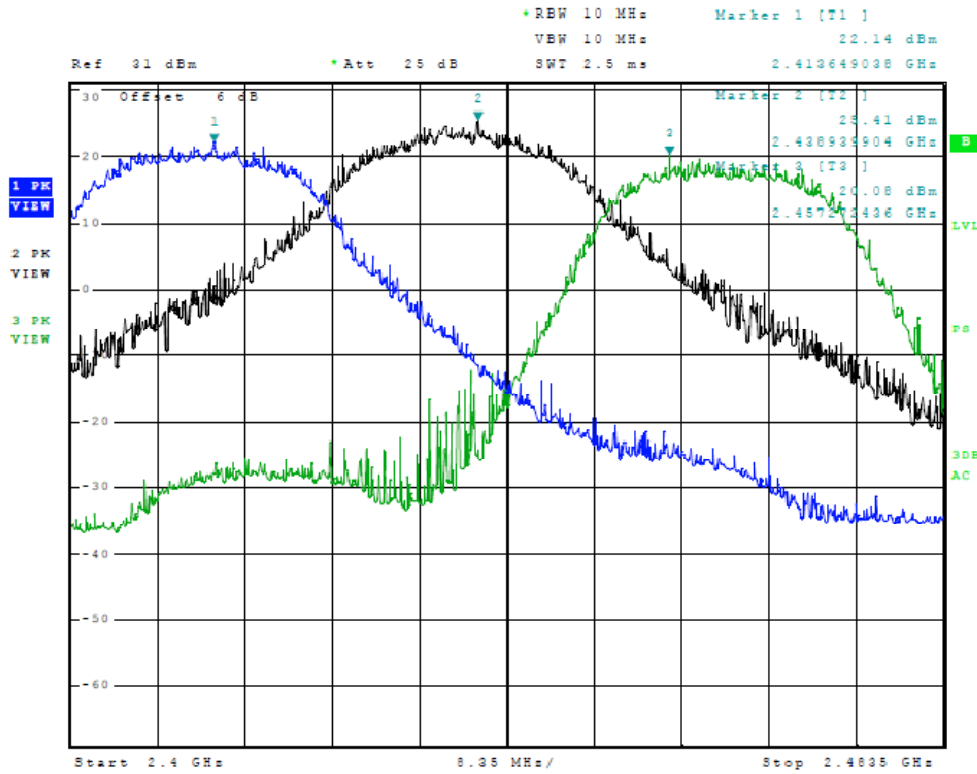

Figure 13 Plot of Antenna Port Emissions (Across Operational Band, 20MHz Mode)

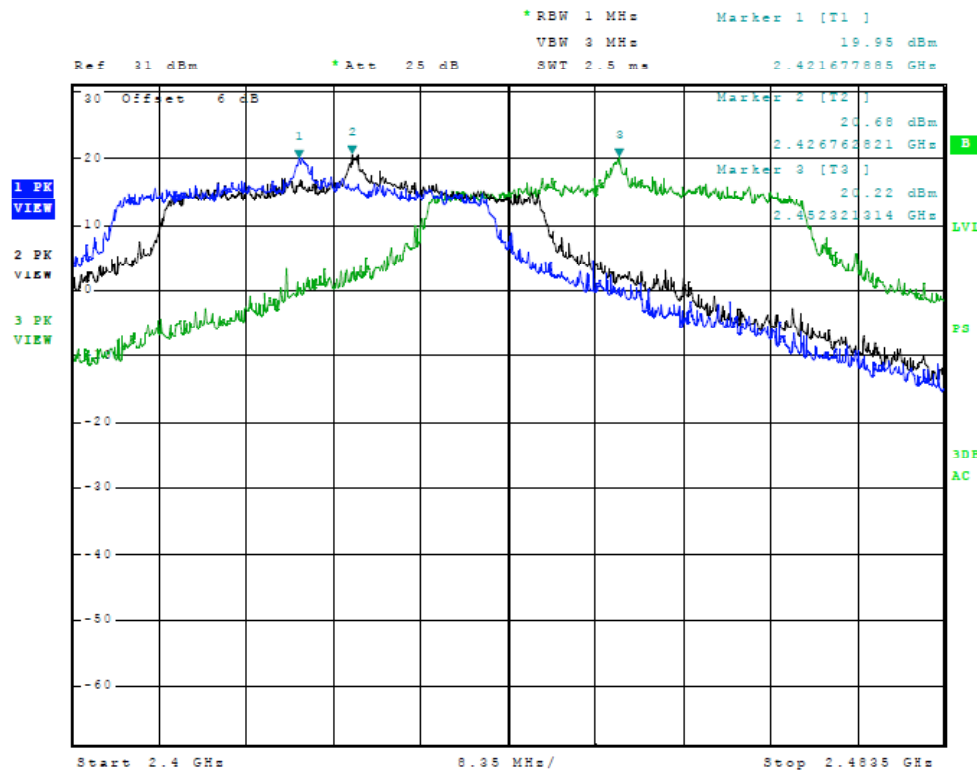

Figure 14 Plot of Antenna Port Emissions (Across Operational Band, 40MHz Mode)

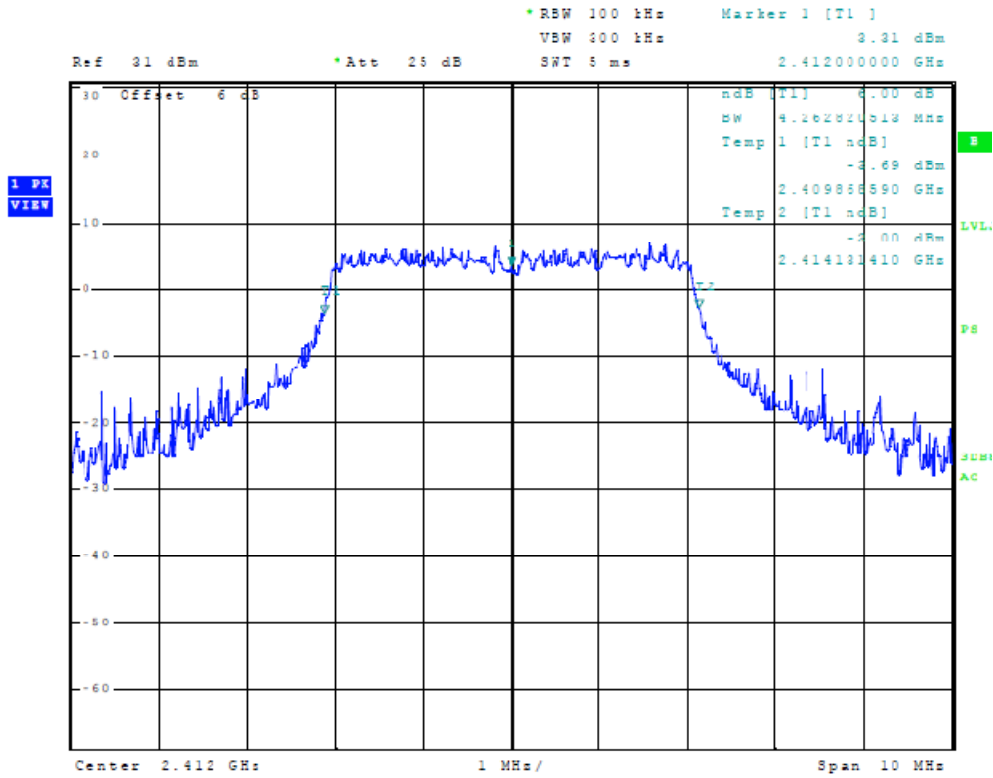

Figure 15 Plot of Plot of 6dB Band width (5 MHz Mode, 2412 MHz)

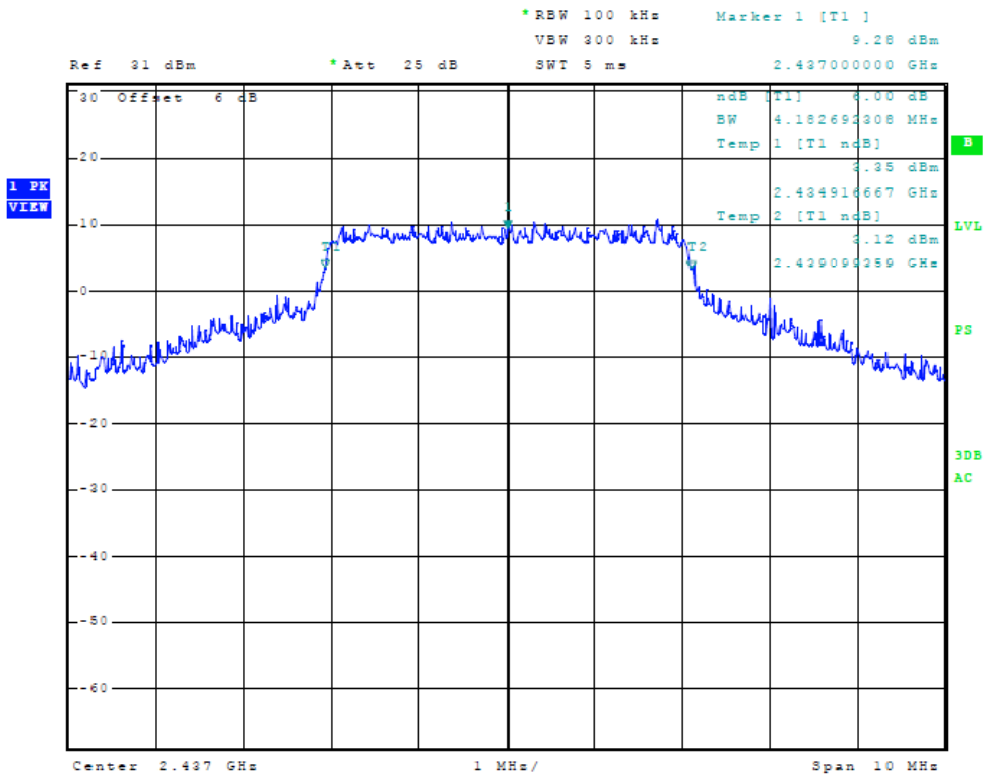

Figure 16 Plot of Plot of 6dB Band width (5 MHz Mode, 2437 MHz)

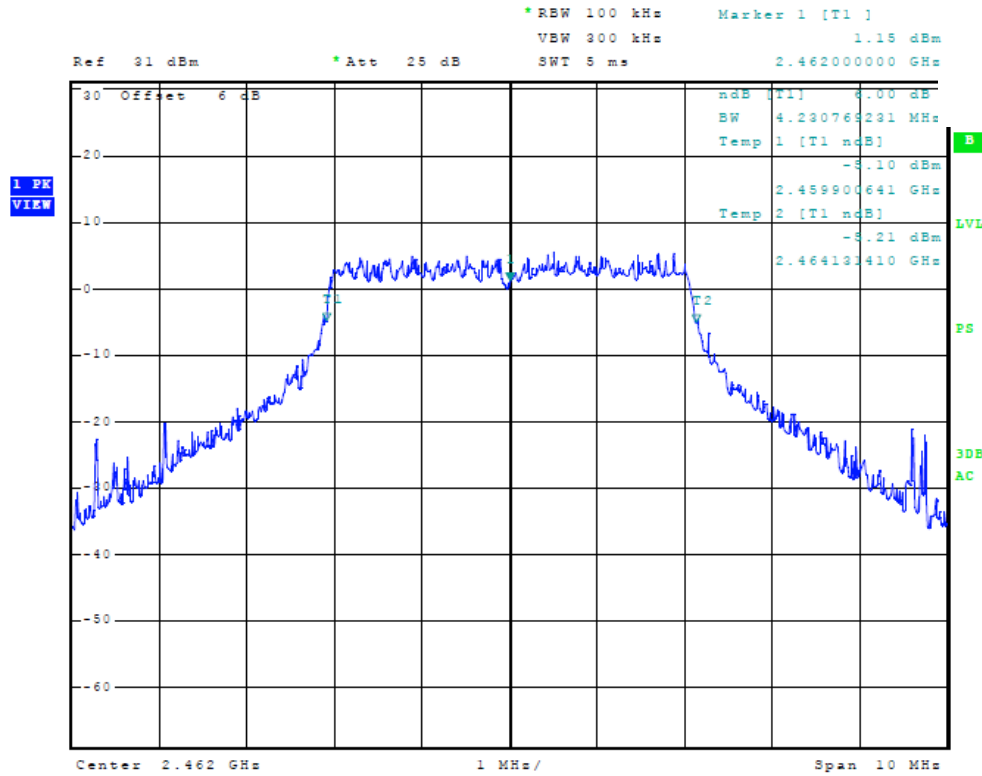

Figure 17 Plot of Plot of 6dB Band width (5 MHz Mode, 2462 MHz)

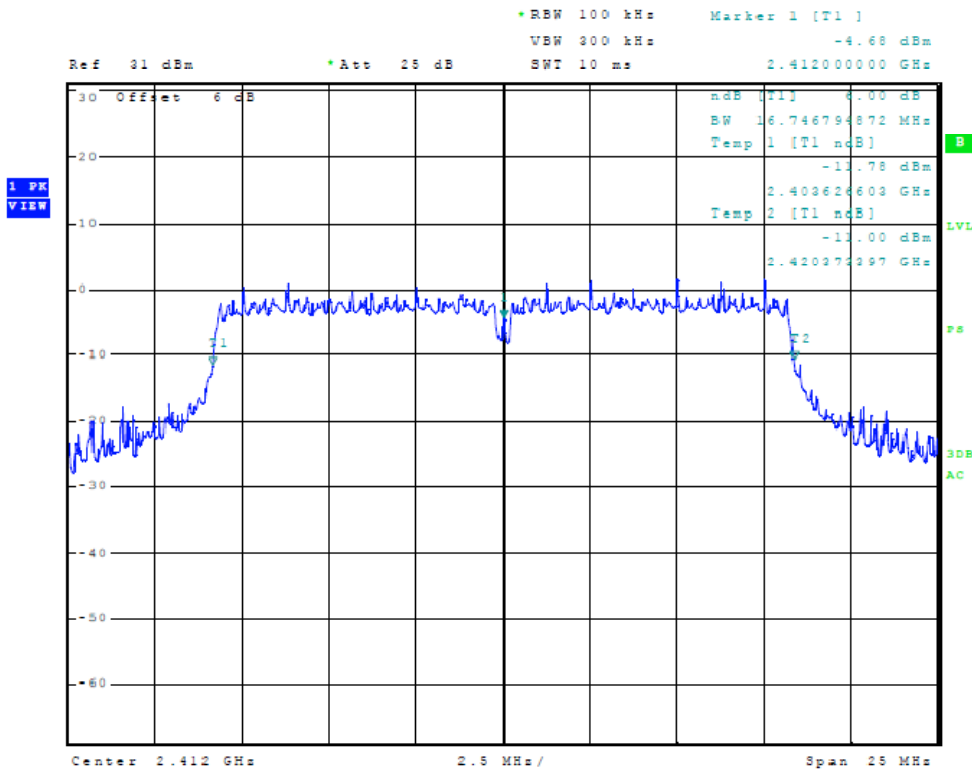

Figure 18 Plot of 6dB Band width (20 MHz Mode, 2412 MHz)

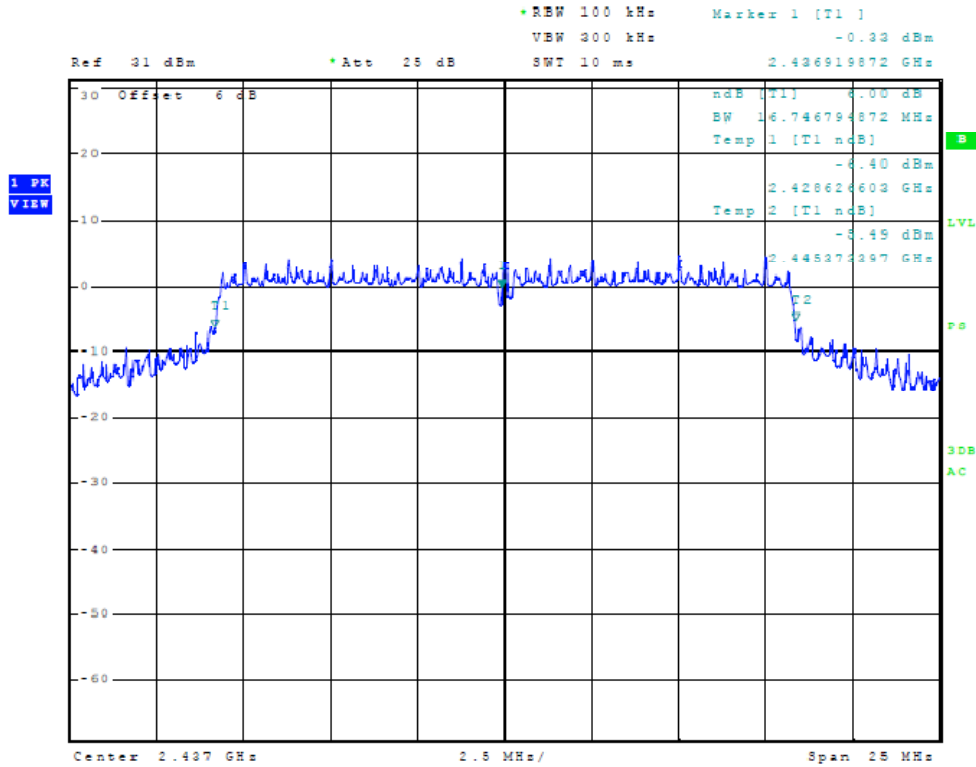

Figure 19 Plot of 6dB Band width (20 MHz Mode, 2437 MHz)

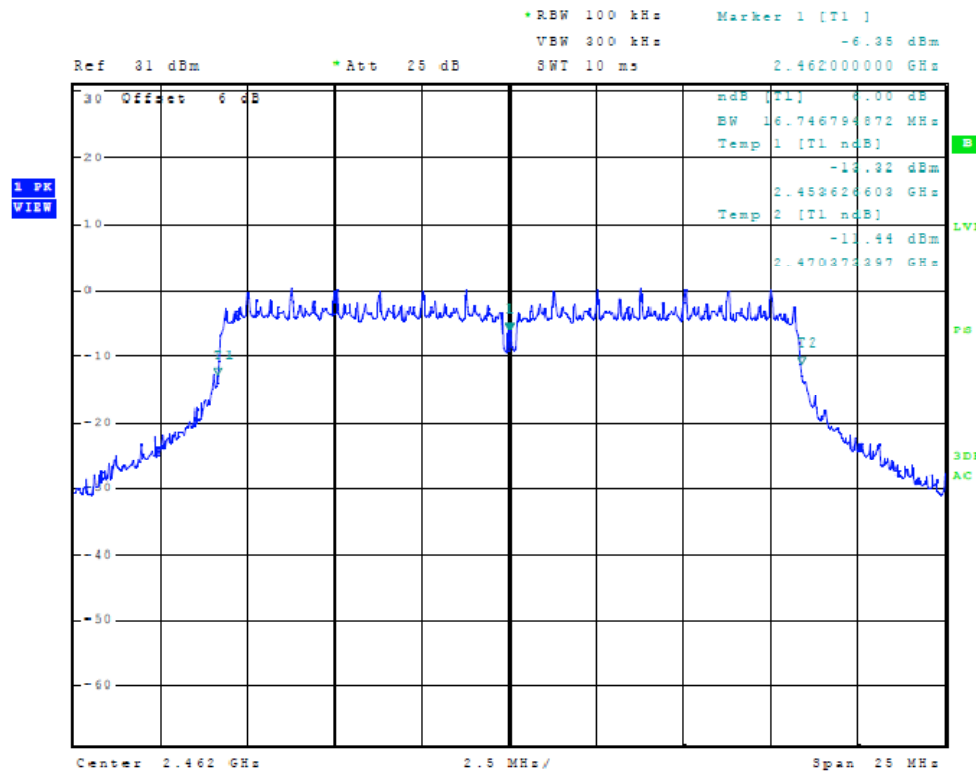

Figure 20 Plot of 6dB Band width (20 MHz Mode, 2462 MHz)

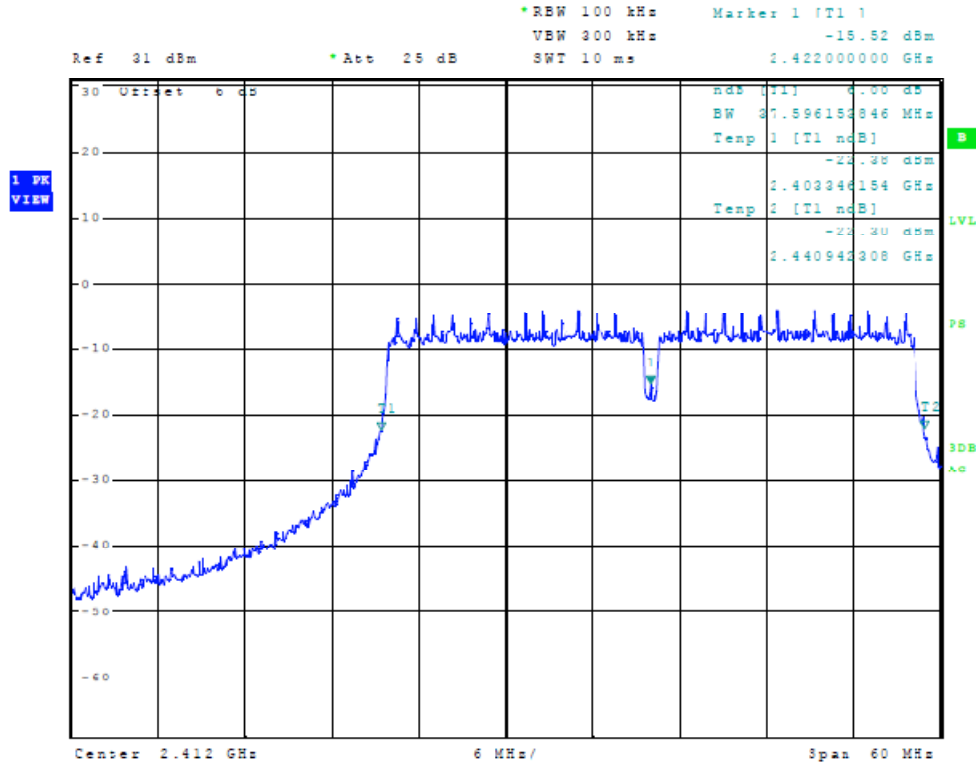

Figure 21 Plot of 6dB Band width (40 MHz Mode, 2422 MHz)

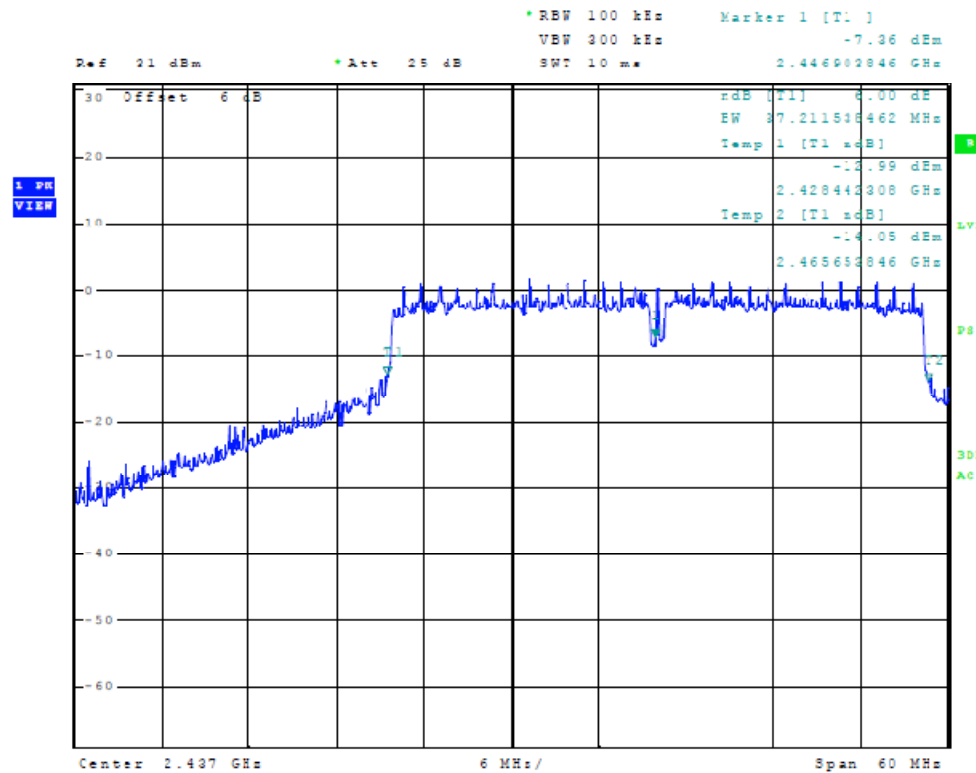

Figure 22 Plot of 6dB Band width (40 MHz Mode, 2447 MHz)

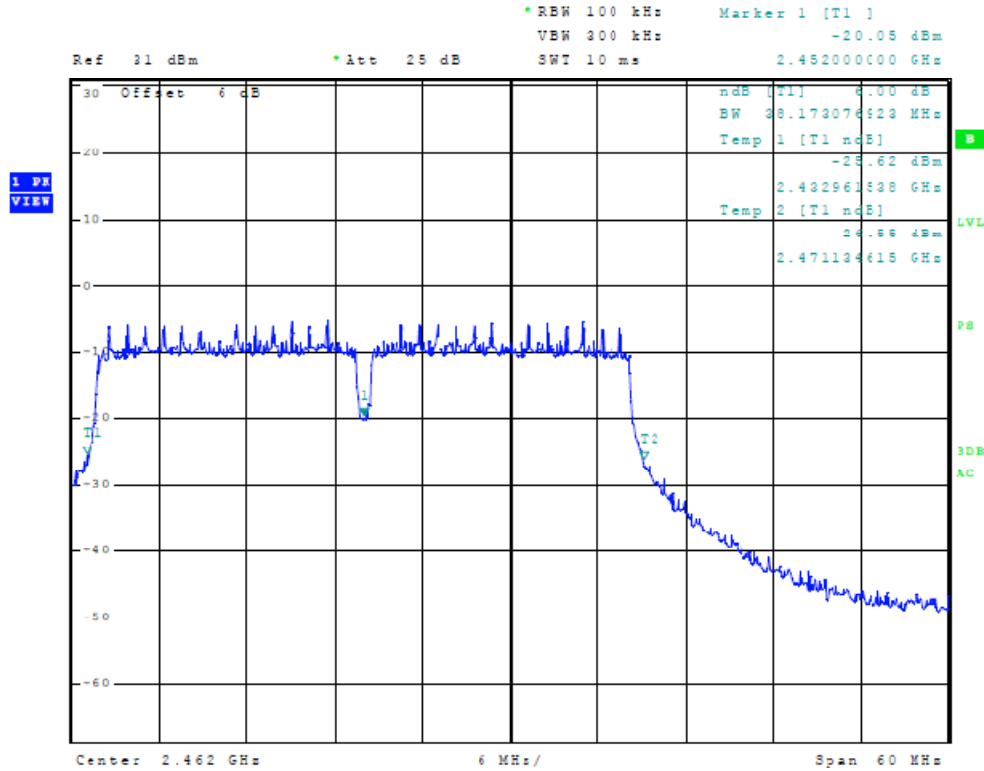

Figure 23 Plot of 6dB Band width (40 MHz Mode, 2452 MHz)

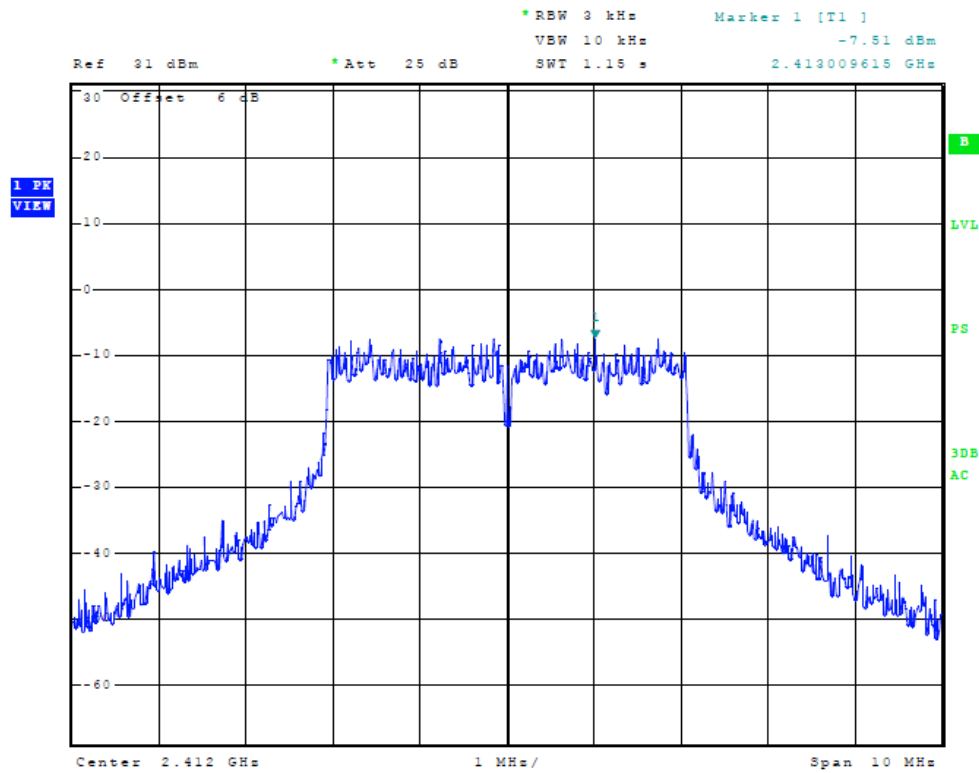

Figure 24 Plot of Power Spectral Density (5 MHz Mode, 2412 MHz)

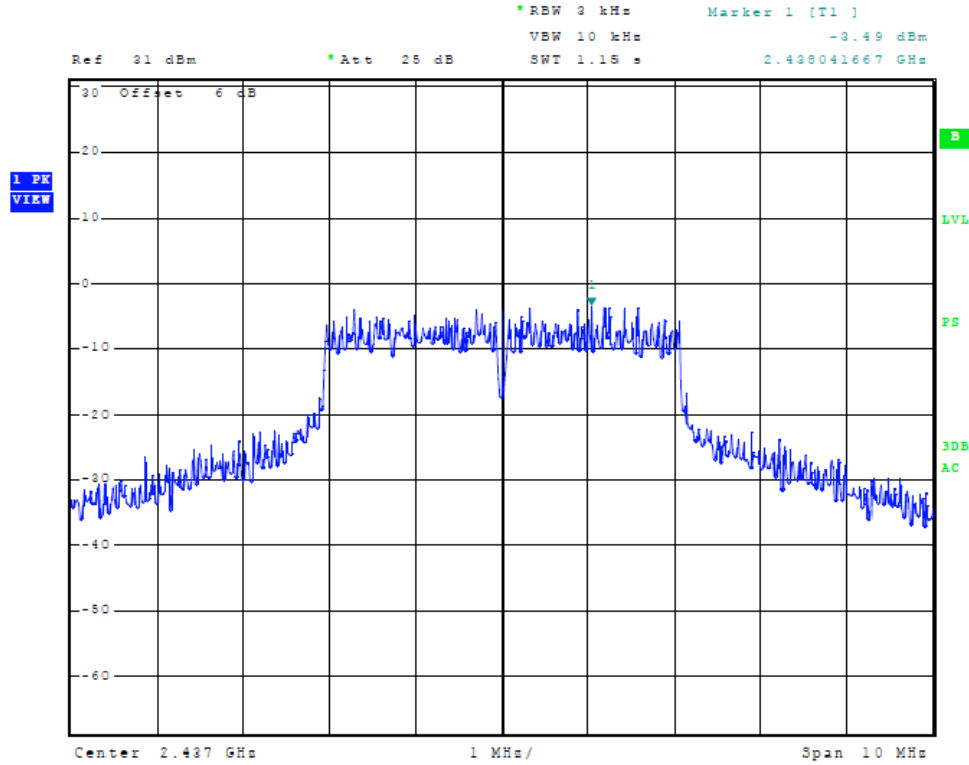

Figure 25 Plot of Power Spectral Density (5 MHz Mode, 2437 MHz)

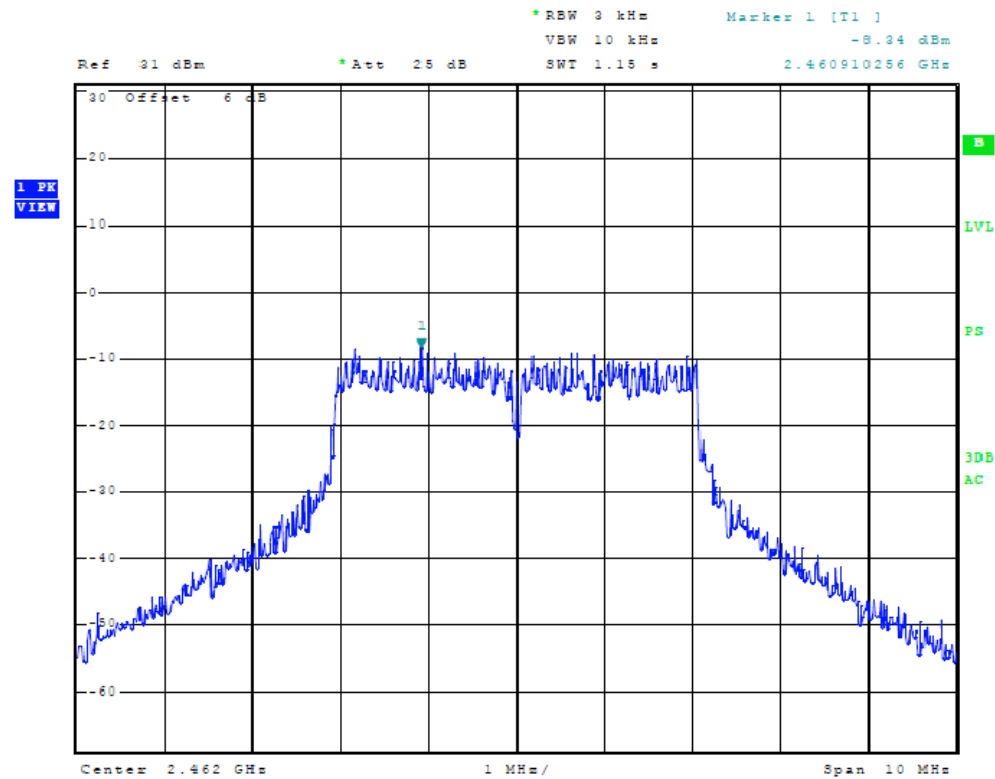

Figure 26 Plot of Power Spectral Density (5 MHz Mode, 2462 MHz)

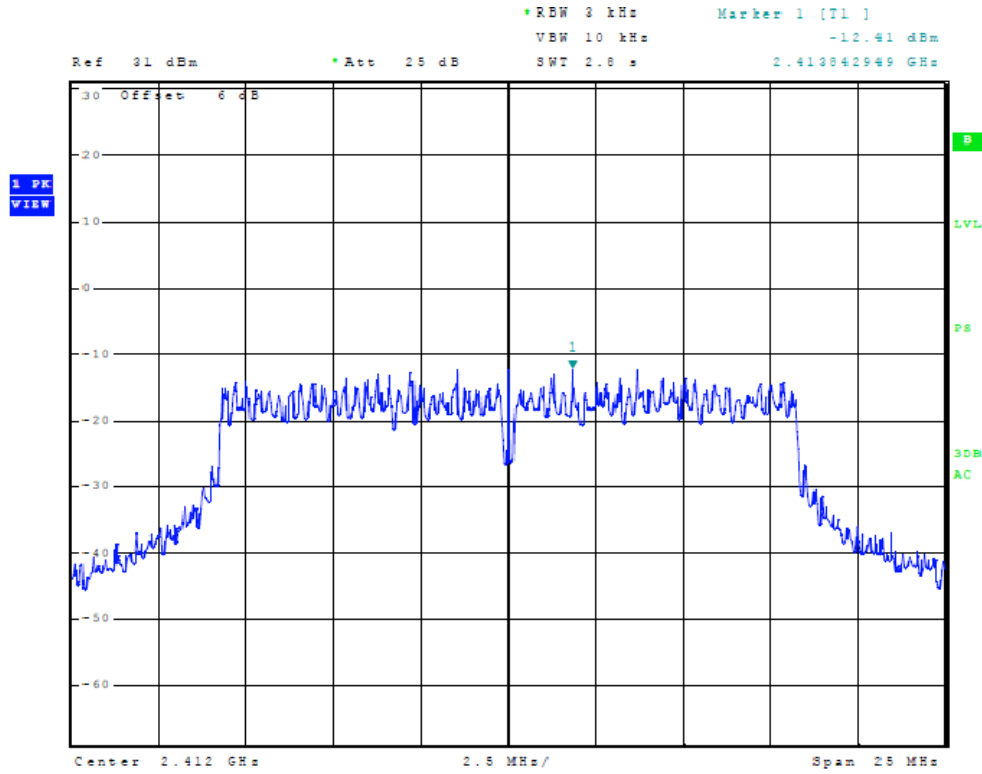

Figure 27 Plot of Power Spectral Density (20 MHz Mode, 2412 MHz)

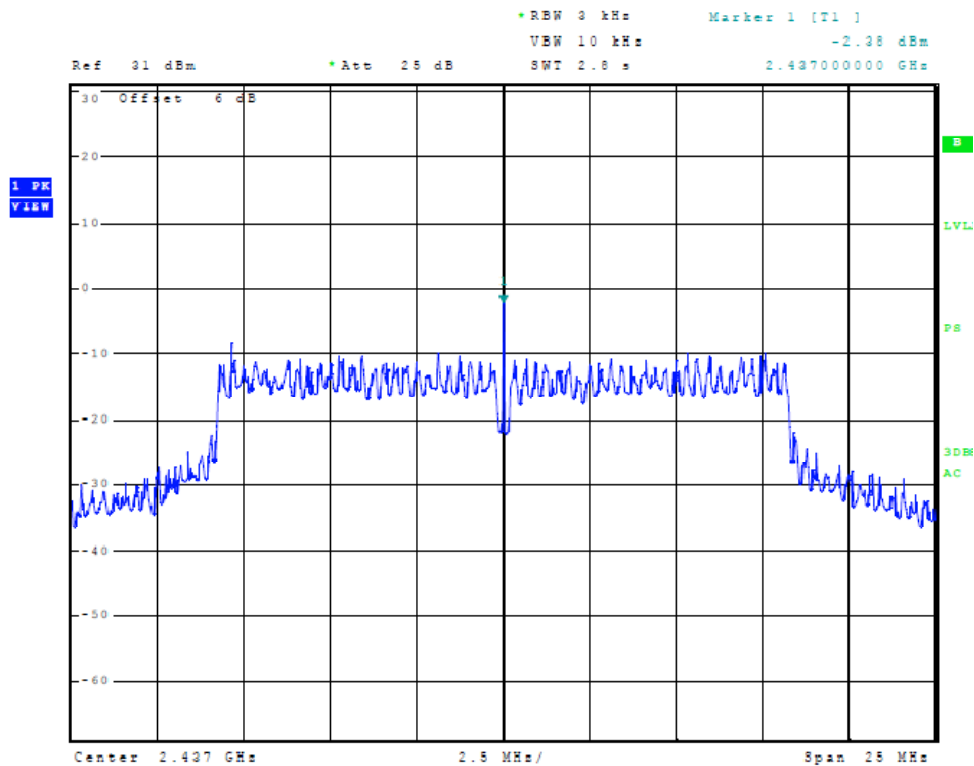

Figure 28 Plot of Power Spectral Density (20 MHz Mode, 2437 MHz)

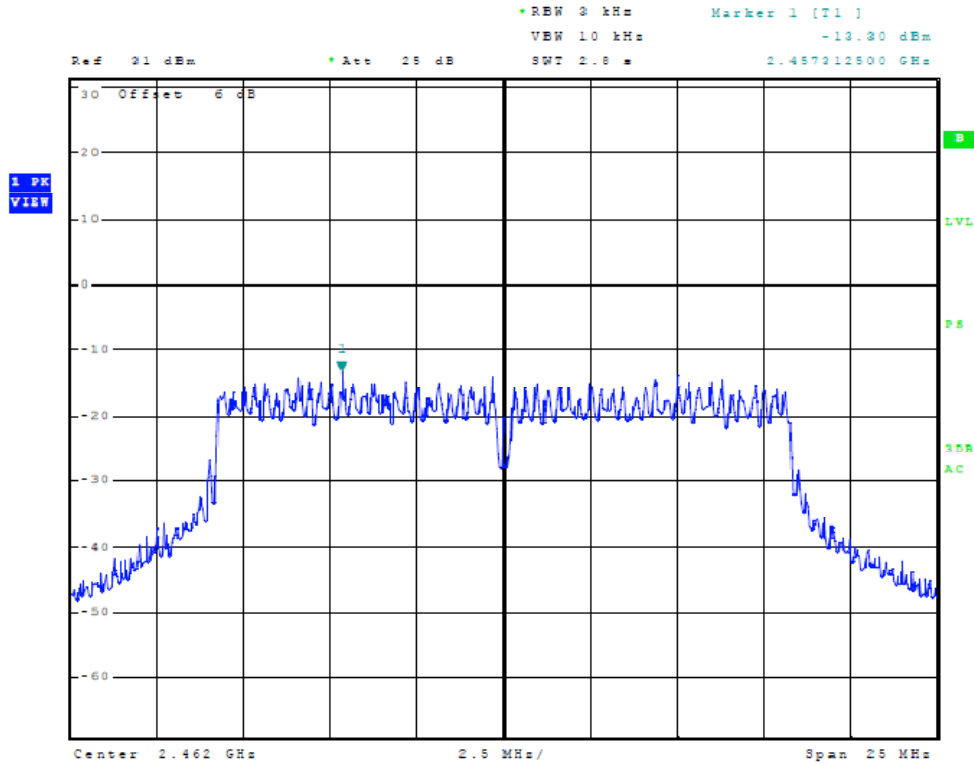

Figure 29 Plot of Power Spectral Density (20 MHz Mode, 2462 MHz)

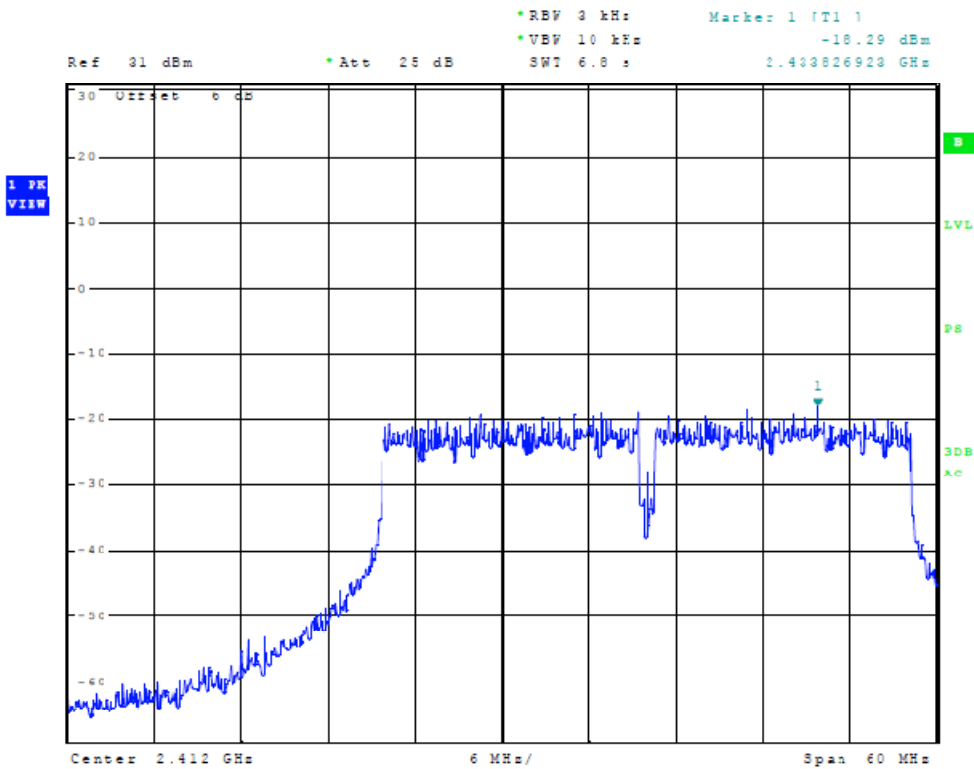

Figure 30 Plot of Power Spectral Density (40 MHz Mode, 2422 MHz)

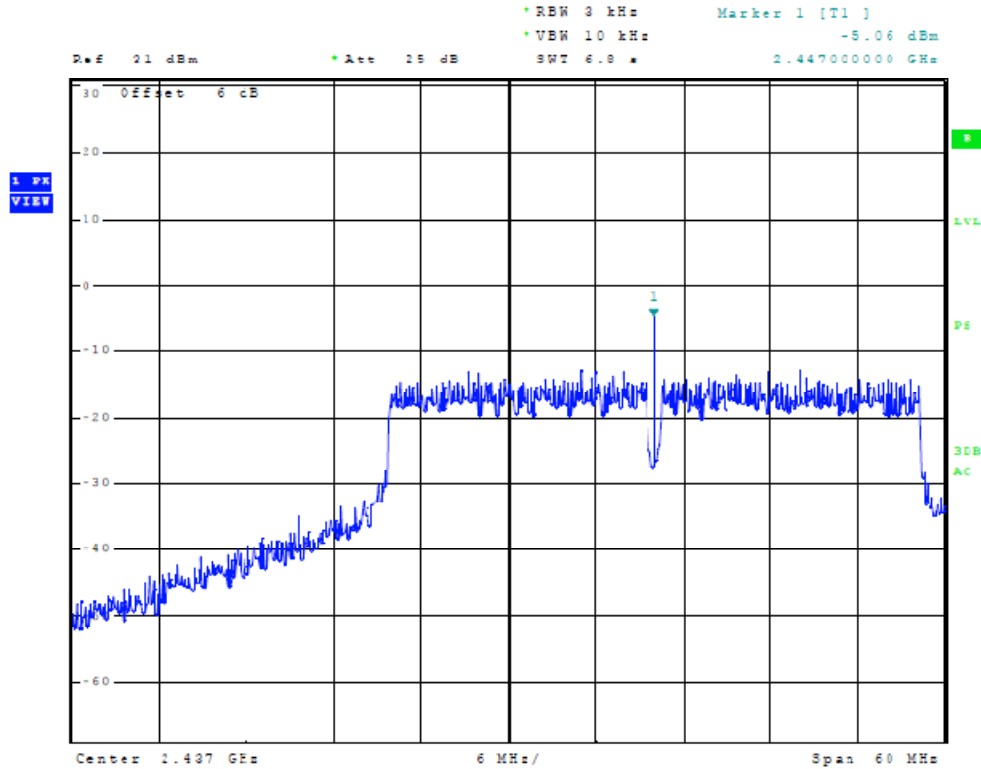

Figure 31 Plot of Power Spectral Density (40 MHz Mode, 2447 MHz)

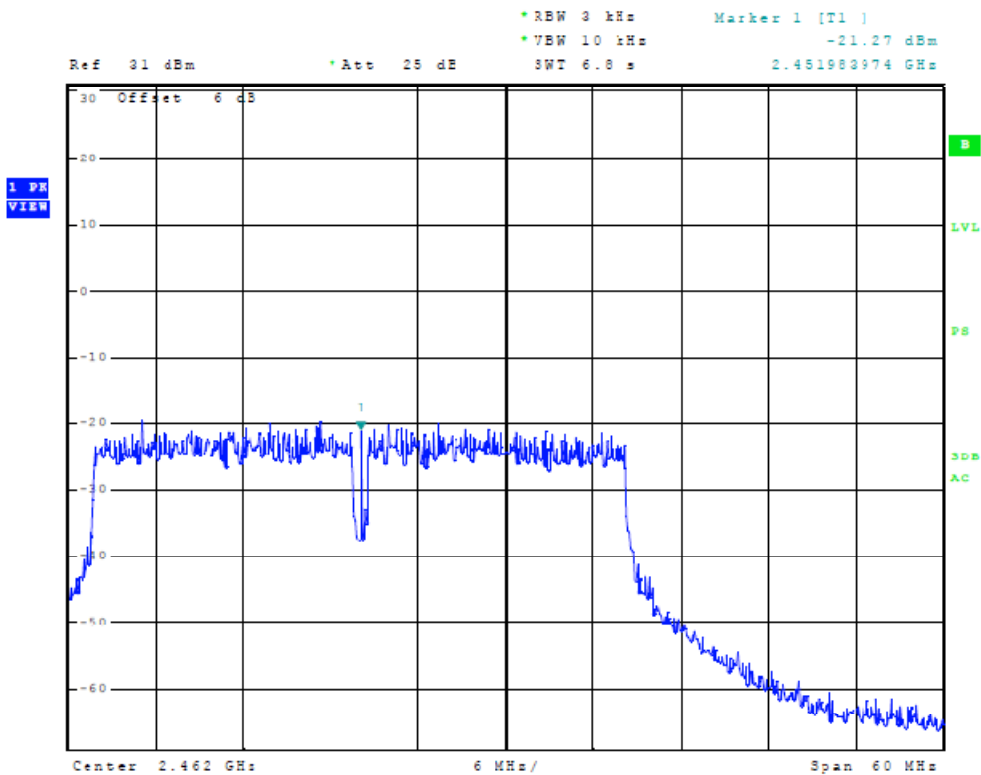

Figure 32 Plot of Power Spectral Density (40 MHz Mode, 2452 MHz)

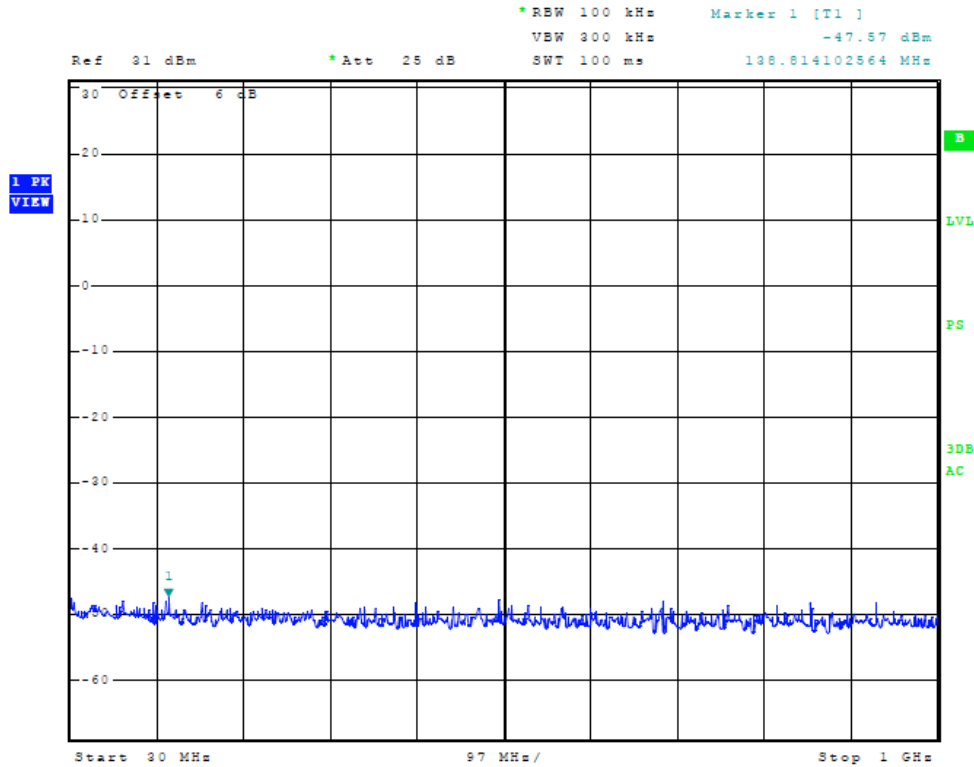

Figure 33 Plot of Antenna port conducted emissions

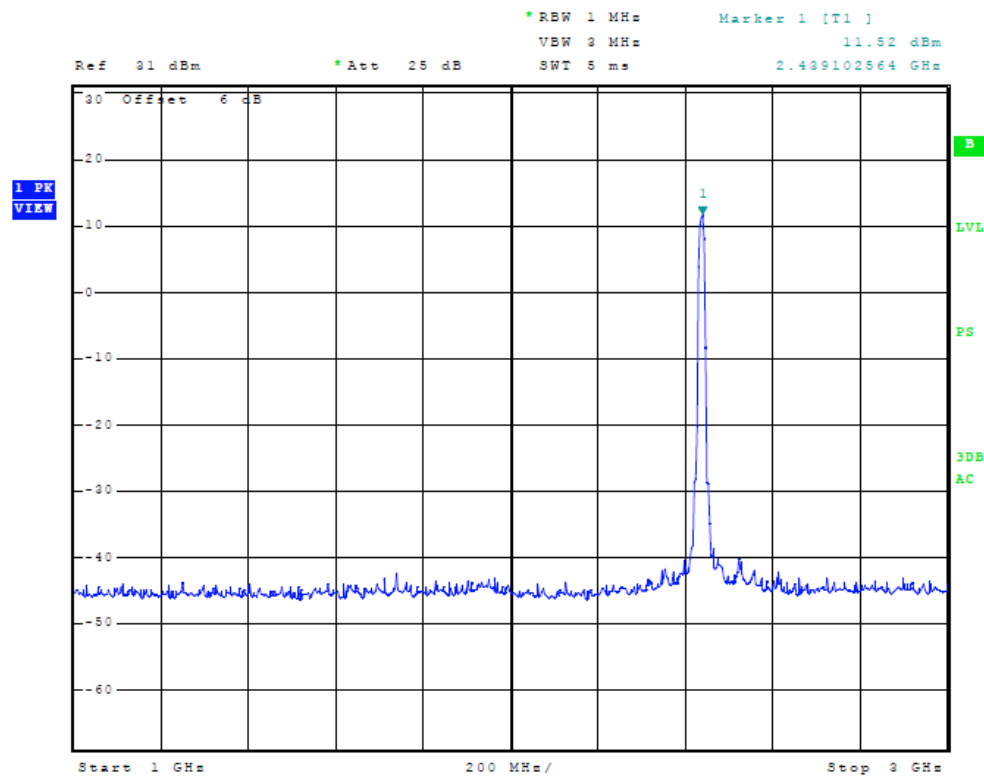

Figure 34 Plot of Antenna port conducted emissions

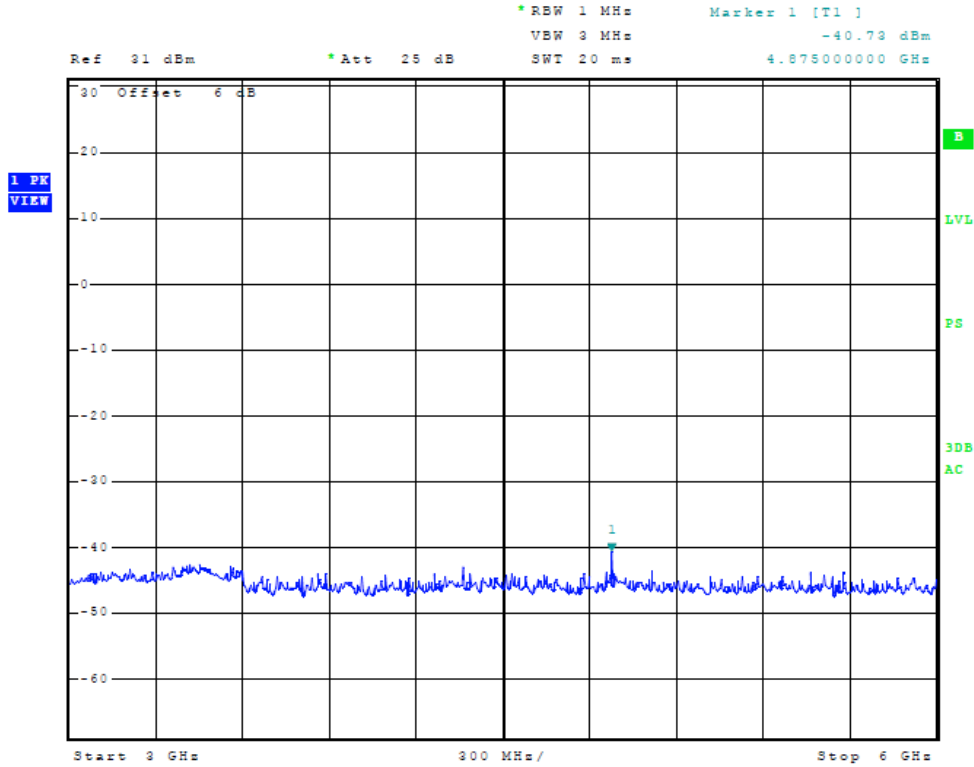

Figure 35 Plot of Antenna port conducted emissions

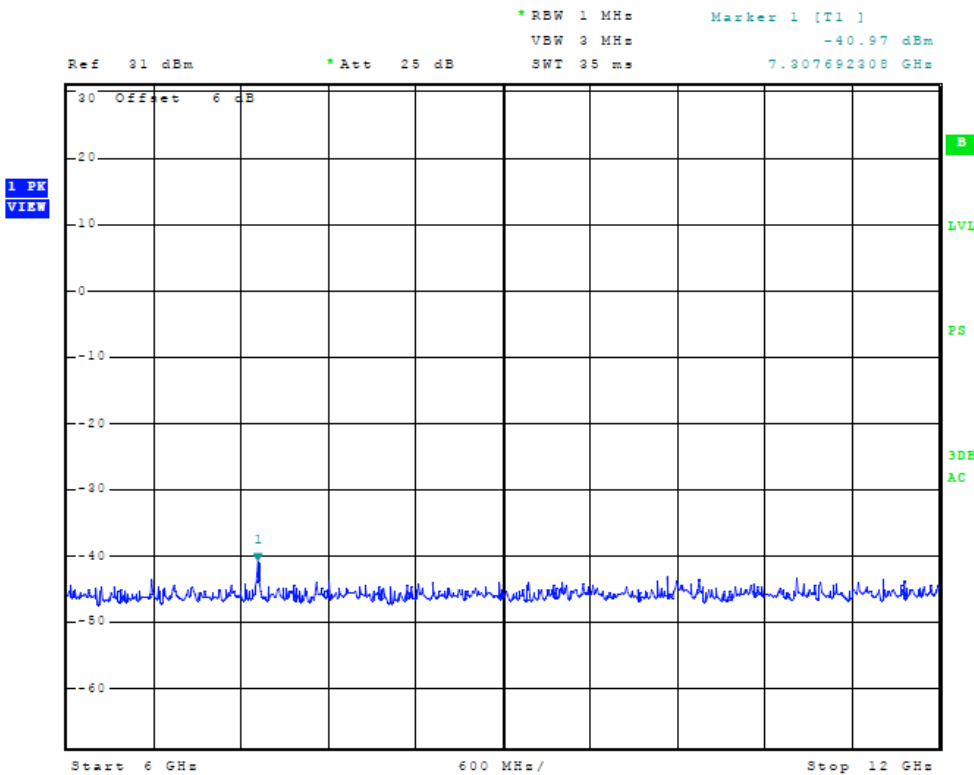

Figure 36 Plot of Antenna port conducted emissions

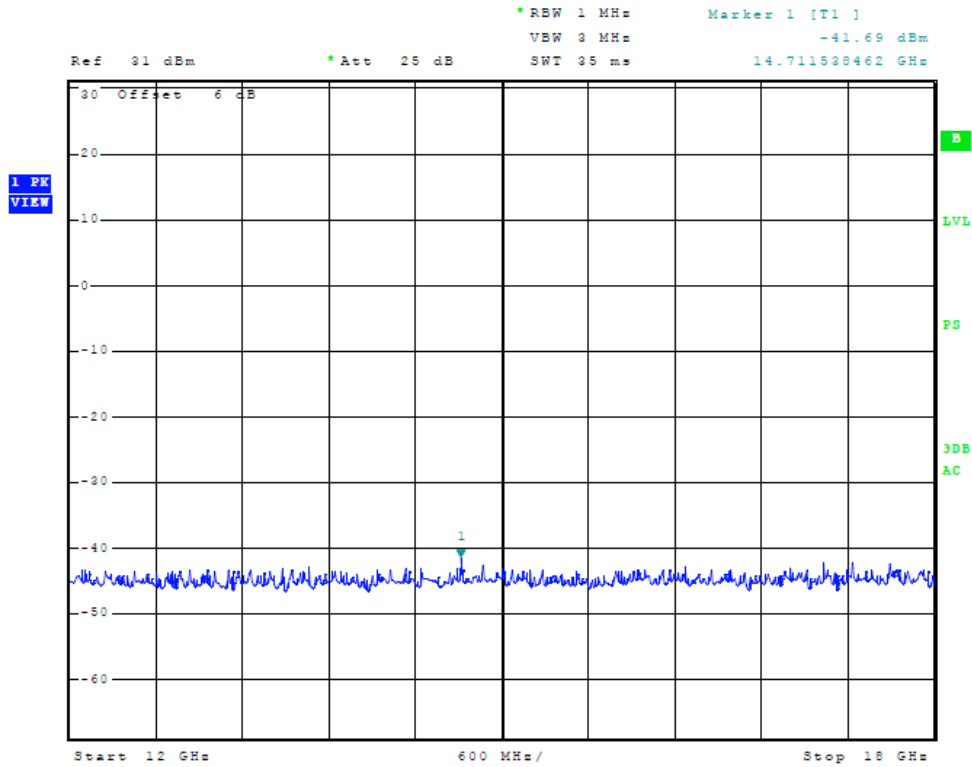

Figure 37 Plot of Antenna port conducted emissions

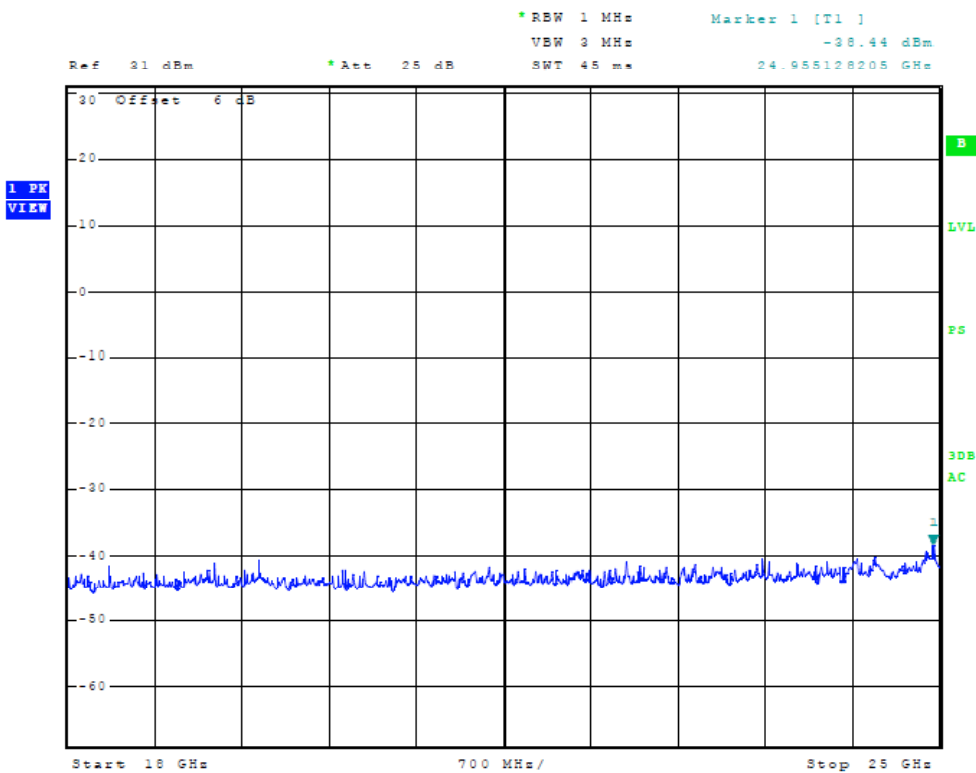

Figure 38 Plot of Antenna port conducted emissions

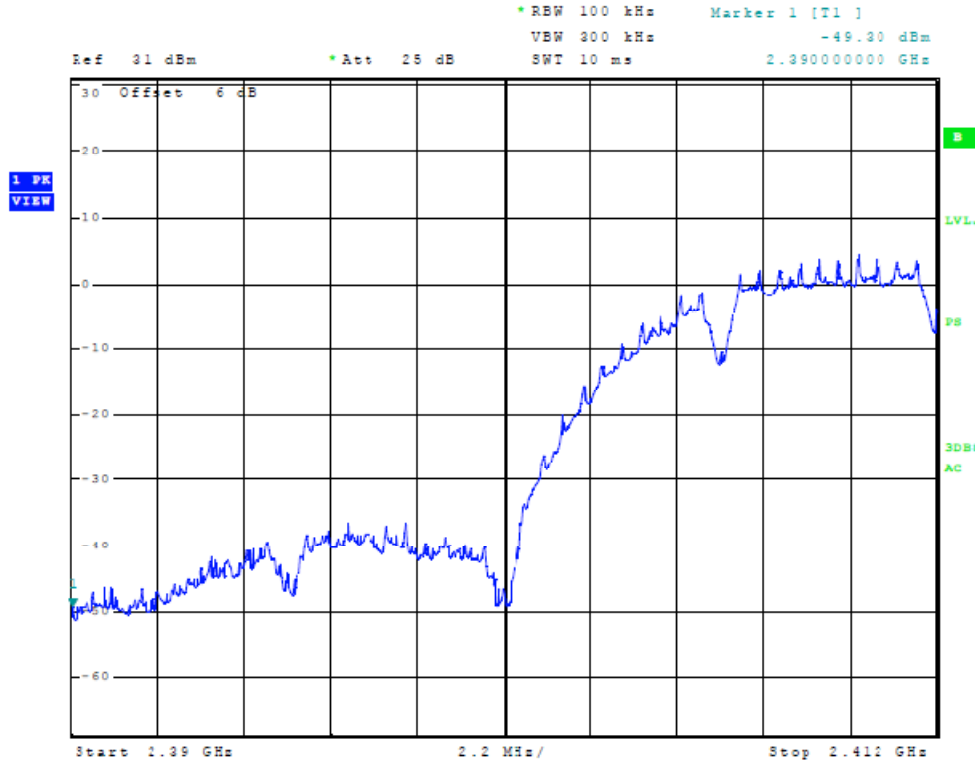

Figure 39 Plot of Band Edge Compliance at Antenna port (worst-case)

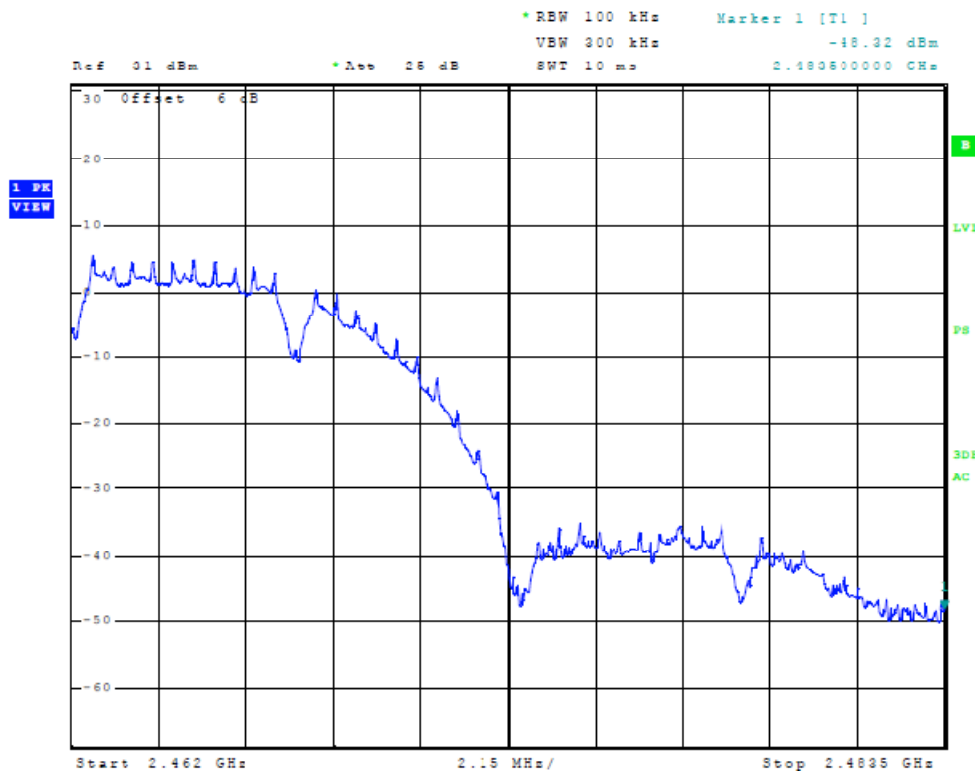

Figure 40 Plot of Band Edge Compliance at Antenna port (worst-case)

Transmitter Emissions Data

Transmitter Antenna port Conducted Emissions Data (Worst-case)

Channel Mode	Output Power single chain (mW / Watts)	Total Output Power (dBm / Watts)
5 MHz	463.4 / 0.5	30 / 1.0
10 MHz	413.0 / 0.4	29 / 0.8
20 MHz	347.5 / 0.4	28 / 0.6
40 MHz	116.9 / 0.12	23 / 0.2

Channel Mode	Power Spectral Density (dBm)	Total Power Spectral Density (dBm)
5 MHz	-3.49	-0.49
10 MHz	-1.56	1.44
20 MHz	-2.38	0.62
40 MHz	-5.06	-2.06

Transmitter Antenna port Conducted Emissions Data

Frequency MHz	Antenna Conducted Output Power dBm	Occupied Bandwidth kHz	Power Spectral Density dBm
5MHz Mode			
2412.0	25.33	4,262.8	-7.51
2437.0	26.66	4,182.7	-3.49
2462.0	22.39	4,230.8	-8.34
10MHz Mode			
2412.0	23.35	8,485.6	-9.45
2437.0	26.16	8,413.5	-1.56
2462.0	23.01	8,509.6	-10.03
20MHz Mode			
2412.0	22.14	16,746.8	-12.41
2437.0	25.41	16,746.8	-2.38
2462.0	20.08	16,746.8	-13.3
40MHz Mode			
2422.0	19.95	37,596.2	-18.29
2447.0	20.68	37,211.5	-5.06
2452.0	20.22	38,173.1	-21.27



Transmitter Antenna port Conducted Emissions Data (5 MHz Channel)

Channel MHz	Spurious Freq (MHz)	Measured Level (dBm)	Level Below Carrier (dB)
2412.0	4824.0	-44.86	-50.1
	7236.0	-44.30	-49.5
	9648.0	-48.15	-53.4
	12060.0	-47.19	-52.4
	14472.0	-47.26	-52.5
2437.0	4874.0	-41.28	-53.3
	7311.0	-33.19	-45.2
	9748.0	-47.71	-59.8
	12185.0	-47.05	-59.1
	14622.0	-47.16	-59.2
2462.0	4924.0	-46.26	-50.6
	7386.0	-45.18	-49.6
	9848.0	-47.23	-51.6
	12310.0	-46.50	-50.9
	14772.0	-47.38	-51.8

Transmitter Antenna port Conducted Emissions Data (10 MHz Channel)

Channel MHz	Spurious Freq (MHz)	Measured Level (dBm)	Level Below Carrier (dB)
2412.0	4824.0	-46.20	-51.4
	7236.0	-45.69	-50.9
	9648.0	-47.41	-52.6
	12060.0	-46.62	-51.8
	14472.0	-47.26	-52.5
2437.0	4874.0	-43.58	-55.6
	7311.0	-36.50	-48.6
	9748.0	-47.31	-59.4
	12185.0	-46.09	-58.1
	14622.0	-47.57	-59.6
2462.0	4924.0	-46.81	-51.2
	7386.0	-46.26	-50.6
	9848.0	-47.57	-51.9
	12310.0	-57.23	-61.6
	14772.0	-46.94	-51.3



Transmitter Antenna port Conducted Emissions Data (20 MHz Channel)

Channel MHz	Spurious Freq (MHz)	Measured Level (dBm)	Level Below Carrier (dB)
2412.0	4824.0	-47.45	-52.7
	7236.0	-45.59	-50.8
	9648.0	-48.07	-53.3
	12060.0	-47.57	-52.8
	14472.0	-46.84	-58.9
2437.0	4874.0	-43.27	-55.3
	7311.0	-47.52	-59.6
	9748.0	-47.23	-59.3
	12185.0	-46.84	-58.9
	14622.0	-46.84	-58.9
2462.0	4924.0	-47.23	-51.6
	7386.0	-47.31	-51.7
	9848.0	-47.65	-52.0
	12310.0	-47.08	-51.5
	14772.0	-47.52	-51.9

Transmitter Antenna port Conducted Emissions Data (40 MHz Channel)

Channel MHz	Spurious Freq (MHz)	Measured Level (dBm)	Level Below Carrier (dB)
2422.0	4844.0	-47.11	-52.3
	7266.0	-47.68	-52.9
	9688.0	-47.76	-53.0
	12110.0	-46.36	-51.6
	14532.0	-46.98	-52.2
2447.0	4894.0	-46.91	-59.0
	7341.0	-46.86	-58.9
	9788.0	-47.68	-59.7
	12235.0	-48.04	-60.1
	14682.0	-47.16	-59.2
2452.0	4904.0	-47.38	-51.8
	7356.0	-48.20	-52.6
	9808.0	-47.87	-52.2
	12260.0	-47.23	-51.6
	14712.0	-47.08	-51.5

Transmitter Radiated Emission (5.5 dBi Internal Antenna, Worst-case)

Frequency in MHz	Horizontal Peak (dBµV/m)	Horizontal Average (dBµV/m)	Vertical Peak (dBµV/m)	Vertical Average (dBµV/m)	Limit @ 3m (dBµV/m)
2412.0	86.4	79.1	95.7	88.7	--
4824.0	58.4	49.3	59.5	51.6	54.0
7236.0	47.7	35.0	48.7	35.9	54.0
9648.0	50.1	38.2	50.0	37.8	54.0
12060.0	48.5	36.1	48.8	36.1	54.0
2437.0	88.6	80.8	99.2	91.9	--
4874.0	55.7	43.9	58.1	47.5	54.0
7311.0	46.1	32.8	46.6	33.8	54.0
9748.0	48.8	35.7	49.9	36.8	54.0
12185.0	48.5	35.8	48.4	37.9	54.0
2462.0	96.0	86.4	100.4	88.7	--
4924.0	58.1	47.9	59.5	51.9	54.0
7386.0	47.0	33.9	46.4	33.8	54.0
9848.0	50.5	39.3	51.8	42.0	54.0
12310.0	48.5	35.4	48.5	36.1	54.0

Other emissions present had amplitudes at least 20 dB below the limit.

Quasi-Peak amplitude emissions are recorded above for frequency range of 30-1000 MHz.

Average amplitude emissions are recorded above for frequency range above 1000 MHz.

Transmitter Radiated Emission (7.4 dBi Omni, Worst-case)

Frequency in MHz	Horizontal Peak (dBµV/m)	Horizontal Average (dBµV/m)	Vertical Peak (dBµV/m)	Vertical Average (dBµV/m)	Limit @ 3m (dBµV/m)
2412.0	95.9	86.8	111.3	103.8	--
4824.0	60.4	52.3	58.9	51.2	54.0
7236.0	48.9	36.6	50.5	37.7	54.0
9648.0	50.3	37.5	50.3	37.4	54.0
12060.0	49.3	36.2	48.8	36.2	54.0
2437.0	97.2	88.7	113.0	105.1	--
4874.0	61.3	52.5	60.4	51.7	54.0
7311.0	47.1	34.1	49.8	36.9	54.0
9748.0	50.9	39.2	50.6	38.0	54.0
12185.0	48.1	36.0	48.7	35.9	54.0
2462.0	95.8	85.4	112.9	103.7	--
4924.0	62.3	51.8	59.7	52.9	54.0
7386.0	48.8	36.4	48.3	35.5	54.0
9848.0	50.9	39.8	49.7	36.9	54.0
12310.0	48.6	35.7	49.5	36.1	54.0

Other emissions present had amplitudes at least 20 dB below the limit.

Quasi-Peak amplitude emissions are recorded above for frequency range of 30-1000 MHz.

Average amplitude emissions are recorded above for frequency range above 1000 MHz.

Transmitter Radiated Emission (8.5 dBi Panel, Worst-case)

Frequency in MHz	Horizontal Peak (dBµV/m)	Horizontal Average (dBµV/m)	Vertical Peak (dBµV/m)	Vertical Average (dBµV/m)	Limit @ 3m (dBµV/m)
2412.0	103.4	91.1	112.8	106.8	--
4824.0	59.4	50.8	57.7	47.9	54.0
7236.0	49.8	37.2	53.6	41.6	54.0
9648.0	50.8	38.3	50.4	37.4	54.0
12060.0	48.7	36.2	49.1	36.7	54.0
2437.0	97.9	86.6	115.6	107.6	--
4874.0	56.9	44.6	59.5	52.4	54.0
7311.0	45.0	32.7	46.8	33.7	54.0
9748.0	51.4	40.6	49.6	37.8	54.0
12185.0	48.1	35.9	48.4	35.9	54.0
2462.0	95.8	82.4	114.5	106.9	--
4924.0	57.1	47.0	60.4	53.4	54.0
7386.0	46.3	33.7	47.4	34.5	54.0
9848.0	50.6	39.3	49.5	37.3	54.0
12310.0	48.0	35.8	49.1	35.8	54.0

Other emissions present had amplitudes at least 20 dB below the limit.

Quasi-Peak amplitude emissions are recorded above for frequency range of 30-1000 MHz.

Average amplitude emissions are recorded above for frequency range above 1000 MHz.

Summary of Results for Transmitter Radiated Emissions of Intentional Radiator

The EUT demonstrated compliance with the conducted and radiated emissions requirements of CFR47 Part 15.247. Conducted antenna port power of 26.6 dBm, 0.5 Watts was measured. The EUT demonstrated a minimum radiated emission margin of -0.6 dB below the harmonic emission requirements. There are no other significantly measurable emissions in the restricted bands other than those recorded in this report. Other emissions were present with amplitudes at least 20 dB below the requirements. The specifications of 15.247 were met; there are no deviations or exceptions to the requirements.

Statement of Modifications and Deviations

No modifications to the EUT were required for the unit to demonstrate compliance with the CFR47 Part 15C emissions standards. There were no deviations to the specifications.



NVLAP Lab Code 200087-0

Annex

- Annex A Measurement Uncertainty Calculations
- Annex B Rogers Labs Test Equipment List
- Annex C Rogers Qualifications
- Annex D FCC Site Registration Letter
- Annex E Industry Canada Site Registration Letter

Annex A Measurement Uncertainty Calculations

Radiated Emissions Measurement Uncertainty Calculation

Measurement of vertically polarized radiated field strength over the frequency range 30 MHz to 1 GHz on an open area test site at 3m and 10m includes following uncertainty:

Contribution	Probability Distribution	Uncertainty (dB)
Antenna factor calibration	normal (k = 2)	±0.58
Cable loss calibration	normal (k = 2)	±0.2
Receiver specification	rectangular	±1.0
Antenna directivity	rectangular	±0.1
Antenna factor variation with height	rectangular	±2.0
Antenna factor frequency interpolation	rectangular	±0.1
Measurement distance variation	rectangular	±0.2
Site Imperfections	rectangular	±1.5
Combined standard uncertainty $u_c(y)$ is		

$$U_c(y) = \pm \sqrt{\left[\frac{1.0}{2}\right]^2 + \left[\frac{0.2}{2}\right]^2 + \left[\frac{1.0^2 + 0.1^2 + 2.0^2 + 0.1^2 + 0.2^2 + 1.5^2}{3}\right]}$$

$$U_c(y) = \pm 1.6 \text{ dB}$$

It is probable that $u_c(y) / s(q_k) > 3$, where $s(q_k)$ is estimated standard deviation from a sample of n readings unless the repeatability of the EUT is particularly poor, and a coverage factor of $k = 2$ will ensure that the level of confidence will be approximately 95%, therefore:

$$s(q_k) = \sqrt{\frac{1}{(n-1)} \sum_{k=1}^n (q_k - \bar{q})^2}$$

$$U = 2 U_c(y) = 2 \times \pm 1.6 \text{ dB} = \pm 3.2 \text{ dB}$$

Notes:

- 1.1 Uncertainties for the antenna and cable were estimated, based on a normal probability distribution with $k = 2$.
- 1.2 The receiver uncertainty was obtained from the manufacturer's specification for which a rectangular distribution was assumed.
- 1.3 The antenna factor uncertainty does not take account of antenna directivity.
- 1.4 The antenna factor varies with height and since the height was not always the same in use as when the antenna was calibrated an additional uncertainty is added.
- 1.5 The uncertainty in the measurement distance is relatively small but has some effect on the received signal strength. The increase in measurement distance as the antenna height is increased is an inevitable consequence of the test method and is therefore not considered a contribution to uncertainty.
- 1.6 Site imperfections are difficult to quantify but may include the following contributions:
 - Unwanted reflections from adjacent objects.
 - Ground plane imperfections: reflection coefficient, flatness, and edge effects.
 - Losses or reflections from "transparent" cabins for the EUT or site coverings.
 - Earth currents in antenna cable (mainly effect Biconical antennas).

The specified limits for the difference between measured site attenuation and the theoretical value (± 4 dB) were not included in total since the measurement of site attenuation includes uncertainty contributions already allowed for in this budget, such as antenna factor.

Conducted Measurements Uncertainty Calculation

Measurement of conducted emissions over the frequency range 9 kHz to 30 MHz includes following uncertainty:

Contribution	Probability Distribution	Uncertainty (dB)
Receiver specification	rectangular	± 1.5
LISN coupling specification	rectangular	± 1.5
Cable and input attenuator calibration	normal (k=2)	± 0.5
Combined standard uncertainty $u_c(y)$ is		

$$U_c(y) = \pm \sqrt{\left[\frac{0.5}{2}\right]^2 + \frac{1.5^2 + 1.5^2}{3}}$$

$$U_c(y) = \pm 1.2 \text{ dB}$$

As with radiated field strength uncertainty, it is probable that $u_c(y) / s(q_k) > 3$ and a coverage factor of $k = 2$ will suffice, therefore:

$$U = 2 U_c(y) = 2 \times \pm 1.2 \text{ dB} = \pm 2.4 \text{ dB}$$



Annex B Rogers Labs Test Equipment List

The test equipment is maintained in calibration and good operating condition. Use of this calibrated equipment ensures measurements are traceable to national standards.

List of Test Equipment	Calibration Date
Spectrum Analyzer: Rohde & Schwarz ESU40	5/11
Spectrum Analyzer: HP 8562A, HP Adapters: 11518, 11519, and 11520	5/11
Mixers: 11517A, 11970A, 11970K, 11970U, 11970V, 11970W	
Spectrum Analyzer: HP 8591EM	5/11
Antenna: EMCO Biconilog Model: 3143	5/11
Antenna: Sunol Biconilog Model: JB6	10/10
Antenna: EMCO Log Periodic Model: 3147	10/10
Antenna: Antenna Research Biconical Model: BCD 235	10/10
LISN: Compliance Design Model: FCC-LISN-2.Mod.cd, 50 µHy/50 ohm/0.1 µf	10/10
R.F. Preamp CPPA-102	10/10
Attenuator: HP Model: HP11509A	10/10
Attenuator: Mini Circuits Model: CAT-3	10/10
Attenuator: Mini Circuits Model: CAT-3	10/10
Cable: Belden RG-58 (L1)	10/10
Cable: Belden RG-58 (L2)	10/10
Cable: Belden 8268 (L3)	10/10
Cable: Time Microwave: 4M-750HF290-750	10/10
Cable: Time Microwave: 10M-750HF290-750	10/10
Frequency Counter: Leader LDC825	2/11
Oscilloscope Scope: Tektronix 2230	2/11
Wattmeter: Bird 43 with Load Bird 8085	2/11
Power Supplies: Sorensen SRL 20-25, SRL 40-25, DCR 150, DCR 140	2/11
R.F. Generators: HP 606A, HP 8614A, HP 8640B	2/11
R.F. Power Amp 65W Model: 470-A-1010	2/11
R.F. Power Amp 50W M185- 10-501	2/11
R.F. Power Amp A.R. Model: 10W 1010M7	2/11
R.F. Power Amp EIN Model: A301	2/11
LISN: Compliance Eng. Model 240/20	2/11
LISN: Fischer Custom Communications Model: FCC-LISN-50-16-2-08	2/11
Antenna: EMCO Dipole Set 3121C	2/11
Antenna: C.D. B-101	2/11
Antenna: Solar 9229-1 & 9230-1	2/11
Antenna: EMCO 6509	2/11
Audio Oscillator: H.P. 201CD	2/11
Peavey Power Amp Model: IPS 801	2/11
ELGAR Model: 1751	2/11
ELGAR Model: TG 704A-3D	2/11
ESD Test Set 2010i	2/11
Fast Transient Burst Generator Model: EFT/B-101	2/11
Field Intensity Meter: EFM-018	2/11
KEYTEK Ecat Surge Generator	2/11
Shielded Room 5 M x 3 M x 3.0 M	



Annex C Rogers Qualifications

Scot D. Rogers, Engineer

Rogers Labs, Inc.

Mr. Rogers has approximately 17 years experience in the field of electronics. Engineering experience includes six years in the automated controls industry and remaining years working with the design, development and testing of radio communications and electronic equipment.

Positions Held

Systems Engineer: A/C Controls Mfg. Co., Inc. 6 Years

Electrical Engineer: Rogers Consulting Labs, Inc. 5 Years

Electrical Engineer: Rogers Labs, Inc. Current

Educational Background

- 1) Bachelor of Science Degree in Electrical Engineering from Kansas State University.
- 2) Bachelor of Science Degree in Business Administration Kansas State University.
- 3) Several Specialized Training courses and seminars pertaining to Microprocessors and Software programming.

Scot D. Rogers



NVLAP Lab Code 200087-0

Annex D FCC Site Registration Letter

FEDERAL COMMUNICATIONS COMMISSION

**Laboratory Division
7435 Oakland Mills Road
Columbia, MD 21046**

May 18, 2010

Registration Number: 90910

Rogers Labs, Inc.
4405 West 259th Terrace,
Louisburg, KS 66053

Attention: Scot Rogers,

Re: Measurement facility located at Louisburg
~~3 & 10 meter site~~
Date of Renewal: May 18, 2010

Dear Sir or Madam:

Your request for renewal of the registration of the subject measurement facility has been received. The information submitted has been placed in your file and the registration has been renewed. The name of your organization will remain on the list of facilities whose measurement data will be accepted in conjunction with applications for Certification under Parts 15 or 18 of the Commission's Rules. Please note that the file must be updated for any changes made to the facility and the registration must be renewed at least every three years.

Measurement facilities that have indicated that they are available to the public to perform measurement services on a fee basis may be found on the FCC website www.fcc.gov under E-Filing, OET Equipment Authorization Electronic Filing, Test Firms.

Sincerely,

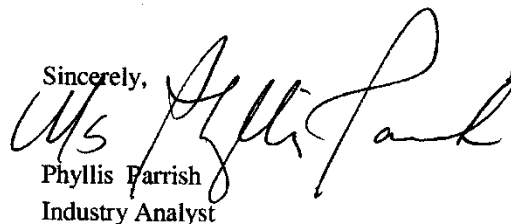

Phyllis Farrish
Industry Analyst

Rogers Labs, Inc.
4405 W. 259th Terrace
Louisburg, KS 66053
Phone/Fax: (913) 837-3214
Revision 1

Mikrotikls SIA
Model: RB751U-2HnD
Test #: 110802
Test to: CFR47 (15.247)
File: Mikrotikls RB51U 2HnD 110802 TstRpt

SN: 2B67011CE826
FCC ID#: TV7RB751-2HND
Date: September 1, 2011
Page 48 of 49



NVLAP Lab Code 200087-0

Annex E Industry Canada Site Registration Letter



May 26, 2010

OUR FILE: 46405-3041
Submission No: 140719

Rogers Labs Inc.

4405 West 259th Terrace
Louisburg, KY, 66053
USA

Attention: Mr. Scot D. Rogers

Dear Sir/Madame:

The Bureau has received your application for the renewal of a 3/10m OATS. Be advised that the information received was satisfactory to Industry Canada. The following number(s) is now associated to the site(s) for which registration / renewal was sought (**3041A-1**). Please reference the appropriate site number in the body of test reports containing measurements performed on the site. In addition, please keep for your records the following information;

- Your primary code is: **3041**
- The company number associated to the site(s) located at the above address is: **3041A**

Furthermore, to obtain or renew a unique site number, the applicant shall demonstrate that the site has been accredited to ANSI C63.4-2003 or later. A scope of accreditation indicating the accreditation by a recognized accreditation body to ANSI C63.4-2003 or later shall be accepted. Please indicate in a letter the previous assigned site number if applicable and the type of site (example: 3 metre OATS or 3 metre chamber). If the test facility is not accredited to ANSI C63.4-2003 or later, the test facility shall submit test data demonstrating full compliance with the ANSI standard. The Bureau will evaluate the filing to determine if recognition shall be granted.

The frequency for re-validation of the test site and the information that is required to be filed or retained by the testing party shall comply with the requirements established by the accrediting organization. However, in all cases, test site re-validation shall occur on an interval not to exceed two years. There is no fee or form associated with an OATS filing. OATS submissions are encouraged to be submitted electronically to the Bureau using the following URL;

http://strategis.ic.gc.ca/epic/internet/inceb-bhst.nsf/en/h_tt00052e.html.

If you have any questions, you may contact the Bureau by e-mail at certification.bureau@ic.gc.ca Please reference our file and submission number above for all correspondence.

Yours sincerely,

Dalwinder Gill
For: Wireless Laboratory Manager
Certification and Engineering Bureau
3701 Carling Ave., Building 94
P.O. Box 11490, Station "H"
Ottawa, Ontario K2H 8S2
Email: dalwinder.gill@ic.gc.ca
Tel. No. (613) 998-3363
Fax. No. (613) 990-4752

Rogers Labs, Inc.
4405 W. 259th Terrace
Louisburg, KS 66053
Phone/Fax: (913) 837-3214
Revision 1

Mikrotikls SIA
Model: RB751U-2HnD
Test #: 110802
Test to: CFR47 (15.247)
File: Mikrotikls RB51U 2HnD 110802 TstRpt

SN: 2B67011CE826
FCC ID#: TV7RB751-2HND
Date: September 1, 2011
Page 49 of 49