

SUBMITTAL APPLICATION REPORT

FOR
GRANT OF CERTIFICATION

FOR

Model: RB711G-5HnD
5740-5830 MHz

MIMO Broadband Digital Transmission System
FCC ID: TV7RB711G-5HND

FOR

MIKROTIKLS SIA

Pernavas 46
Riga, Latvia LV-1009

Test Report Number: 110628

Authorized Signatory: *Scot D Rogers*
Scot D. Rogers

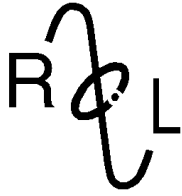

ROGERS LABS, INC.

4405 West 259th Terrace
 Louisburg, KS 66053
 Phone / Fax (913) 837-3214

**Engineering Test Report
 For
 Grant of Certification Application**

FOR
 CFR 47, PART 15C - Intentional Radiators
 CFR 47 Paragraph 15.247
 License Exempt Intentional Radiator

For

MIKROTIKLS SIA

Pernavas 46
 Riga, Latvia LV-1009

2x2 MIMO Broadband Digital Transmission System
 Model: RB711G-5HnD
 Frequency Range 5740-5830 MHz
 FCC ID#: TV7RB711G-5HND

Test Date: June 28, 2011

Certifying Engineer: *Scot D. Rogers*
 Scot D. Rogers
 Rogers Labs, Inc.
 4405 West 259th Terrace
 Louisburg, KS 66053
 Telephone/Facsimile: (913) 837-3214

This report shall not be reproduced except in full, without the written approval of the laboratory. This report must not be used by the client to claim product endorsement by NVLAP, NIST, or any agency of the U.S. Government.



Table Of Contents

TABLE OF CONTENTS..... 3

FORWARD 6

OPINION / INTERPRETATION OF RESULTS 6

ENVIRONMENTAL CONDITIONS..... 6

EQUIPMENT TESTED..... 6

APPLICATION FOR CERTIFICATION..... 7

APPLICABLE STANDARDS & TEST PROCEDURES 8

EQUIPMENT FUNCTION AND CONFIGURATION..... 8

Equipment Configuration.....9

TEST SITE LOCATIONS 9

UNITS OF MEASUREMENTS 9

TEST PROCEDURES..... 10

AC Line Conducted Emission Test Procedure10

Radiated Emission Test Procedure.....10

LIST OF TEST EQUIPMENT 11

INTENTIONAL RADIATORS..... 12

Antenna Requirements12

Restricted Bands of Operation.....12

 Radiated Emissions in Restricted Bands Data (worst-case configuration presented)..... 12

Summary of Results for Radiated Emissions in Restricted Bands13

AC Line Conducted Emissions Procedure13

 Figure One AC Line Conducted Emissions Line 1..... 14

 Figure Two AC Line Conducted Emissions Line 2..... 14

 AC Line Conducted Emissions Data (Highest Emissions)..... 15

Summary of Results for AC Line Conducted Emissions15



General Radiated Emissions Procedure.....16

Figure Three General Radiated Emissions taken at 1 meter in screen room17

Figure Four General Radiated Emissions taken at 1 meter in screen room17

Figure Five General Radiated Emissions taken at 1 meter in screen room.....18

Figure Six General Radiated Emissions taken at 1 meter in screen room18

Figure Seven General Radiated Emissions taken at 1 meter in screen room19

Figure Eight General Radiated Emissions taken at 1 meter in screen room19

Figure Nine General Radiated Emissions taken at 1 meter in screen room20

Figure Ten General Radiated Emissions taken at 1 meter in screen room20

Figure Eleven General Radiated Emissions taken at 1 meter in screen room.....21

General Radiated Emissions from EUT Data (Highest Emissions).....21

Summary of Results for General Radiated Emissions22

Operation in the Band 5725 – 5850 MHz22

Figure Twelve Plot of Radiated Emissions (Across Operational Band, 5MHz Mode).....23

Figure Thirteen Plot of Radiated Emissions (Across Operational Band, 20MHz Mode).....23

Figure Fourteen Plot of Radiated Emissions (Across Operational Band, 40MHz Mode)24

Figure Fifteen Plot of Plot of 6dB Band width (chain 1, 5 MHz Mode, 5740 MHz)24

Figure Sixteen Plot of Plot of 6dB Band width (chain 1, 5 MHz Mode, 5785 MHz).....25

Figure Seventeen Plot of Plot of 6dB Band width (chain 1, 5 MHz Mode, 5830 MHz)25

Figure Eighteen Plot of 6dB Band width (chain 1, 20 MHz Mode, 5745 MHz)26

Figure Nineteen Plot of 6dB Band width (chain 1, 20 MHz Mode, 5785 MHz).....26

Figure Twenty Plot of 6dB Band width (chain 1, 20 MHz Mode, 5825 MHz)27

Figure Twenty-one Plot of 6dB Band width (chain 1, 40 MHz Mode, 5755 MHz)27

Figure Twenty-two Plot of 6dB Band width (chain 1, 40 MHz Mode, 5795 MHz).....28

Figure Twenty-three Plot of 6dB Band width (chain 1, 40 MHz Mode, 5815 MHz).....28

Figure Twenty-four Plot of Power Spectral Density (chain 1, 5 MHz Mode, 5740 MHz).....29

Figure Twenty-five Plot of Power Spectral Density (chain 1, 5 MHz Mode, 5785 MHz)29

Figure Twenty-six Plot of Power Spectral Density (chain 1, 5 MHz Mode, 5830 MHz).....30

Figure Twenty-seven Plot of Power Spectral Density (chain 1, 20 MHz Mode, 5745 MHz)30

Figure Twenty-eight Plot of Power Spectral Density (chain 1, 20 MHz Mode, 5785 MHz).....31

Figure Twenty-nine Plot of Power Spectral Density (chain 1, 20 MHz Mode, 5825 MHz).....31

Figure Thirty Plot of Power Spectral Density (chain 1, 40 MHz Mode, 5755 MHz).....32

Figure Thirty-one Plot of Power Spectral Density (chain 1, 40 MHz Mode, 5795 MHz)32

Figure Thirty-two Plot of Power Spectral Density (chain 1, 40 MHz Mode, 5815 MHz).....33

Figure Thirty-three Plot of Plot of 6dB Band width (chain 2, 5 MHz Mode, 5740 MHz).....33

Figure Thirty-four Plot of Plot of 6dB Band width (chain 2, 5 MHz Mode, 5785 MHz)34

Figure Thirty-five Plot of Plot of 6dB Band width (chain 2, 5 MHz Mode, 5830 MHz).....34

Figure Thirty-six Plot of 6dB Band width (chain 2, 20 MHz Mode, 5745 MHz).....35

Figure Thirty-seven Plot of 6dB Band width (chain 2, 20 MHz Mode, 5785 MHz)35

Figure Thirty-eight Plot of 6dB Band width (chain 2, 20 MHz Mode, 5825 MHz)36

Figure Thirty-nine Plot of 6dB Band width (chain 2, 40 MHz Mode, 5755 MHz).....36



Figure Forty Plot of 6dB Band width (chain 2, 40 MHz Mode, 5795 MHz).....37

Figure Forty-one Plot of 6dB Band width (chain 2, 40 MHz Mode, 5815 MHz).....37

Figure Forty-two Plot of Power Spectral Density (chain 2, 5 MHz Mode, 5740 MHz).....38

Figure Forty-three Plot of Power Spectral Density (chain 2, 5 MHz Mode, 5785 MHz).....38

Figure Forty-four Plot of Power Spectral Density (chain 2, 5 MHz Mode, 5830 MHz)39

Figure Forty-five Plot of Power Spectral Density (chain 2, 20 MHz Mode, 5745 MHz).....39

Figure Forty-six Plot of Power Spectral Density (chain 1, 20 MHz Mode, 5785 MHz)40

Figure Forty-seven Plot of Power Spectral Density (chain 1, 20 MHz Mode, 5825 MHz).....40

Figure Forty-eight Plot of Power Spectral Density (chain 1, 40 MHz Mode, 5755 MHz).....41

Figure Forty-nine Plot of Power Spectral Density (chain 1, 40 MHz Mode, 5795 MHz)41

Figure Fifty Plot of Power Spectral Density (chain 1, 40 MHz Mode, 5815 MHz)42

Figure Fifty-one Plot of Antenna port conducted emissions.....42

Figure Fifty-two Plot of Antenna port conducted emissions43

Figure Fifty-three Plot of Antenna port conducted emissions.....43

Figure Fifty-four Plot of Antenna port conducted emissions.....44

Figure Fifty-five Plot of Antenna port conducted emissions44

Figure Fifty-six Plot of Antenna port conducted emissions.....45

Figure Fifty-seven Plot of Antenna port conducted emissions45

Transmitter Emissions Data.....46

Transmitter Antenna port Conducted Emissions Data (per Chain)46

Transmitter Antenna port Conducted Emissions Data (Total).....46

Transmitter Antenna port Conducted Emissions Data (5 MHz Channel) (worst-case chain)47

Transmitter Antenna port Conducted Emissions Data (10 MHz Channel) (worst-case chain)47

Transmitter Antenna port Conducted Emissions Data (20 MHz Channel) (worst-case chain)48

Transmitter Antenna port Conducted Emissions Data (40 MHz Channel) (worst-case chain)48

Transmitter Radiated Emission (9dBi Omni, Worst-case)49

Transmitter Radiated Emission (24dBi Panel, Worst-case).....49

Transmitter Radiated Emission (32dBi Dish, Worst-case).....50

Summary of Results for Transmitter Radiated Emissions of Intentional Radiator.....50

STATEMENT OF MODIFICATIONS AND DEVIATIONS 50

ANNEX..... 51

Annex A Measurement Uncertainty Calculations.....52

Annex B Rogers Labs Test Equipment List.....54

Annex C Rogers Qualifications55

Annex D FCC Site Registration Letter.....56

Annex E Industry Canada Site Registration Letter57



Forward

The following information is submitted for consideration in obtaining Grant of Certification for License Exempt Digital Transmission System Intentional Radiator operating under CFR 47 Paragraph 15.247.

Name of Applicant: Mikrotiks SIA
 Pernavas 46
 Riga, Latvia LV-1009

Model: RB711G-5HnD

FCC I.D.: TV7RB711G-5HND FRN: 0014 43 1100

Frequency Range: 5740-5830 MHz (5 and 10 MHz channel operation), 5745-5825 MHz (20 and 40 MHz channel operation)

Operating Power: 0.2-Watts total output power of two chain operation, 19.67 dBm, 0.1 Watts per chain (using measure and sum testing for each Tx chain)

Opinion / Interpretation of Results

Tests Performed	Margin (dB)	Results
Emissions as per CFR 47 paragraphs 2 and 15.205	-1.6	Complies
Emissions as per CFR 47 paragraphs 2 and 15.207	-10.8	Complies
Emissions as per CFR 47 paragraphs 2 and 15.209	-1.6	Complies
Emissions as per CFR 47 paragraphs 2 and 15.247	-10.4	Complies

Environmental Conditions

Ambient Temperature 24.3° C
 Relative Humidity 49%
 Atmospheric Pressure 1014.7 mb

Equipment Tested

<u>Equipment</u>	<u>Model</u>	<u>FCC I.D.</u>
EUT	RB711G-5HnD	TV7RB711G-5HND
AC Adapter	KSAS024240008	N/A
USB Memory Stick	Verbatim 10050405316G50AAF	N/A
Dell Studio XPS	921LBN1	N/A

<u>Antenna/Type</u>	<u>Model</u>	<u>Gain</u>
Omni Directional	MT-482016NA	9 dBi
Panel	PA 58-24	24 dBi
Dish	HDDA 5W-32-DP2	32 dBi

Application for Certification

- (1) Manufacturer: Mikrotikls SIA
Pernavas 46
Riga, Latvia LV-1009
- (2) Identification: Model: RB711G-5HnD

FCC I.D.: TV7RB711G-5HND
- (3) Instruction Book:

Refer to Exhibit for Instruction Manual.
- (4) Description of Circuit Functions:

Refer to Exhibit of Operational Description.
- (5) Block Diagram with Frequencies:

Refer to Exhibit of Operational Description.
- (6) Report of Measurements:

Report of measurements follows in this Report.
- (7) Photographs: Construction, Component Placement, etc.:

Refer to Exhibit for photographs of equipment.
- (8) List of Peripheral Equipment Necessary for operation. The equipment operates from power received from authorized AC power adapter or POE (Power Over Ethernet). The EUT offers connection ports for authorized antennas, power, USB, and network cables. During testing the EUT was connected to CPU through network cable, power supplied from external AC adapter, and USB memory stick.
- (9) Transition Provisions of CFR47 15.37 are not requested.
- (10) Not Applicable. The unit is not a scanning receiver.
- (11) Not Applicable. The EUT does not operate in the 59 – 64 GHz frequency band.
- (12) The equipment is not software defined and this section is not applicable.



Applicable Standards & Test Procedures

In accordance with the Federal Communications Code of Federal Regulations, dated October 1, 2010, Part 2, Subpart J, Paragraphs 2.907, 2.911, 2.913, 2.925, 2.926, 2.1031 through 2.1057, and applicable parts of paragraph 15, Part 15C Paragraph 15.247 the following information is submitted.

Test procedures used are the established Methods of Measurement of Radio-Noise Emissions as described in the ANSI C63.4-2009 Document, FCC documents KDB 662911 MIMO, DA00-1407 and DA00-705 and/or TIA/EIA 603-1. Testing for the AC line-conducted emissions were performed as defined in sections 7 and 13.1.3, testing of the radiated emissions was performed as defined in sections 8 and 13.1.4 of ANSI C63.4-2009. Testing of the intentional radiated emissions was performed as defined in section 13 of ANSI C63.4-2009.

Equipment Function and Configuration

The EUT is a 5740-5830 MHz Multiple Input Multiple Output (MIMO) Digital Transmission System transmitters used to transmit data in applications offering broadband wireless connectivity. The equipment is marketed for use to incorporate a wireless link to exchange data information from one point to another. For testing purposes, the RB711G-5HnD transceiver was connected to the manufacturer supplied AC power adapter, USB memory stick, and communicating to the laptop computer allowing for operational control of the transmitter and communications over the network interface between the EUT and supporting computer system. The RB711G-5HnD receives power from the supplied AC power adapter or POE connected to utility power systems. The EUT offers connection ports for power, USB interface, and network only and requires power supplied from external source (AC adapter or POE), no other interfacing options are provided. The RB711G-5HnD was powered from the AC power adapter and configured to transmit in available data modes during testing. The device is marketed for professional installation and antenna connection and options comply with the unique antenna connection requirements.

Equipment Configuration

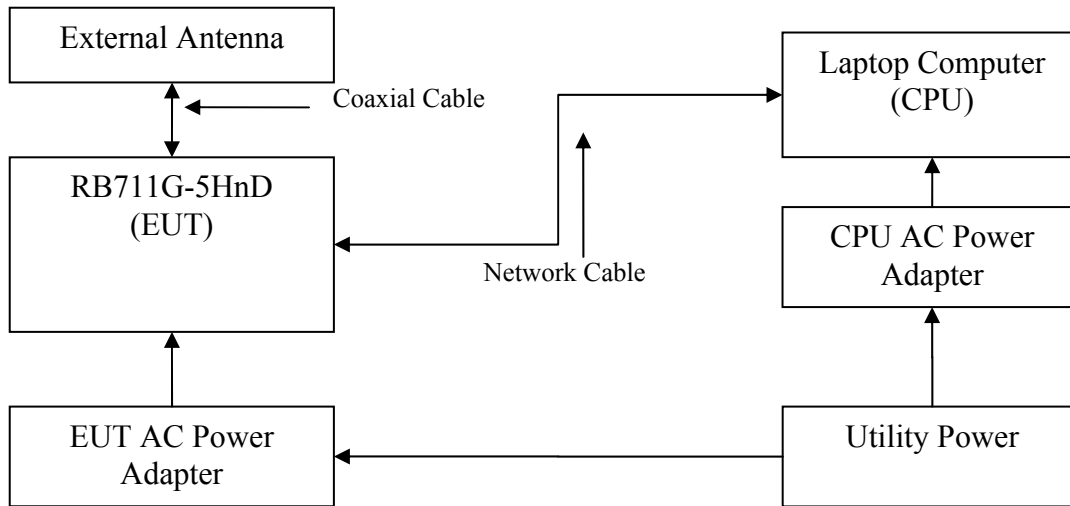

Test Site Locations

- Conducted EMI** The AC power line conducted emissions testing performed in a shielded screen room located at Rogers Labs, Inc., 4405 W. 259th Terrace, Louisburg, KS
- Radiated EMI** The radiated emissions tests were performed at the 3 meters, Open Area Test Site (OATS) located at Rogers Labs, Inc., 4405 W. 259th Terrace, Louisburg, KS
- Site Registration** Refer to Annex for Site Registration Letters
- NVLAP Accreditation** Lab code 200087-0

Units of Measurements

- Conducted EMI** Data is in dB μ V; dB referenced to one microvolt
- Radiated EMI** Data is in dB μ V/m; dB/m referenced to one microvolt per meter

Sample Calculation:

RFS = Radiated Field Strength, FSM = Field Strength Measured
 A.F. = Receive antenna factor, Gain = amplification gains and/or cable losses

$$RFS \text{ (dB}\mu\text{V/m @ 3m)} = FSM \text{ (dB}\mu\text{V)} + A.F. \text{ (dB)} - \text{Gain (dB)}$$

Test Procedures

AC Line Conducted Emission Test Procedure

The EUT operates from DC power only and must be connected to an approved AC adapter/POE for operation. For testing purposes, the manufacturer supplied AC power adapter was used to power the EUT and system. Testing for the AC line-conducted emissions testing was performed as defined in sections 7 and 13.1.3 of ANSI C63.4-2009. The test setup including the EUT was arranged in typical equipment configurations and placed on a 1 x 1.5-meter wooden bench, 0.8 meters high located in a screen room. The power lines of the system were isolated from the power source using a standard LISN with a 50- μ Hy choke. EMI was coupled to the spectrum analyzer through a 0.1 μ F capacitor internal to the LISN. The LISN was positioned on the floor beneath the wooden bench supporting the EUT. The power lines and cables were draped over the back edge of the table.

Radiated Emission Test Procedure

The EUT was placed on a rotating 1 x 1.5-meter wooden platform, 0.8 meters above the ground plane at a distance of 3 meters from the FSM antenna. Testing for the radiated emissions was performed as defined in sections 8 and 13.1.4 of ANSI C63.4-2009. EMI energy was maximized by equipment placement, raising and lowering the FSM antenna, changing the antenna polarization, and by rotating the turntable. Each emission was maximized before data was taken using a spectrum analyzer. Refer to photographs in the test setup exhibits for EUT placement during testing.

List of Test Equipment

A Rohde and Schwarz ESU40 and/or Hewlett Packard 8591EM was used as the measuring device for the emissions testing of frequencies below 1 GHz. A Rohde and Schwarz ESU40 and/or Hewlett Packard 8562A Spectrum Analyzer was used as the measuring device for testing the emissions at frequencies above 1 GHz. The analyzer settings used are described in the following table. Refer to the appendix for a complete list of test equipment.

AC Line Conducted Emissions (0.150 -30 MHz)		
RBW	AVG. BW	Detector Function
9 kHz	30 kHz	Peak / Quasi Peak
Emissions (30-1000 MHz)		
RBW	AVG. BW	Detector Function
120 kHz	300 kHz	Peak / Quasi Peak
Emissions (Above 1000 MHz)		
RBW	Video BW	Detector Function
100 kHz	100 kHz	Peak
1 MHz	1 MHz	Peak / Average

<u>Equipment</u>	<u>Manufacturer</u>	<u>Model</u>	<u>Calibration Date</u>	<u>Due</u>
LISN	Comp. Design	FCC-LISN-2-MOD.CD	10/10	10/11
Antenna	ARA	BCD-235-B	10/10	10/11
Antenna	EMCO	3147	10/10	10/11
Antenna	EMCO	3143	5/11	5/12
Analyzer	HP	8591EM	5/11	5/12
Analyzer	HP	8562A	5/11	5/12
Analyzer	Rohde & Schwarz	ESU40	5/11	5/12

Intentional Radiators

As per CFR47, Subpart C, paragraph 15.247 the following information is submitted.

Antenna Requirements

The EUT offers female N-type connectors for use with authorized antenna systems only. The design is marketed for professional installation and use as described in accompanying documentation. The antenna connection point complies with the unique antenna connection requirements. The requirements of 15.203 are fulfilled; there are no deviations or exceptions to the specification.

Restricted Bands of Operation

Spurious emissions falling in the restricted frequency bands of operation were measured at a distance of three meters on the OATS. The EUT utilizes frequency, determining circuitry, which generates harmonics falling in the restricted bands. Emissions were measured at the OATS, using appropriate antennas or pyramidal horns, amplification stages, and a spectrum analyzer. No other significant emission was observed which fell into the restricted bands of operation.

Radiated Emissions in Restricted Bands Data (worst-case configuration presented)

Frequency in MHz	Horizontal Peak (dBμV)	Horizontal Quasi-Peak (dBμV)	Horizontal Average (dBμV)	Vertical Peak (dBμV)	Vertical Quasi-Peak (dBμV)	Vertical Average (dBμV)	Limit @ 3m (dBμV/m)
125.0	44.3	41.9	N/A	45.6	41.9	N/A	43.5
166.9	38.3	33.2	N/A	36.3	30.9	N/A	43.5
250.0	37.6	34.7	N/A	32.5	28.9	N/A	46.0
255.5	32.7	27.7	N/A	23.4	17.6	N/A	46.0
1598.8	44.5	N/A	30.7	50.7	N/A	34.7	54.0
11480.0	55.3	N/A	41.4	52.1	N/A	39.7	54.0
11570.0	48.5	N/A	36.2	53.6	N/A	40.6	54.0
11660.0	54.0	N/A	16.6	16.1	N/A	36.3	54.0
22960.0	38.8	N/A	26.4	38.5	N/A	26.3	54.0

Other emissions present had amplitudes at least 20 dB below the limit.

Quasi-Peak amplitude emissions are recorded above for frequency range of 30-1000 MHz.

Average amplitude emissions are recorded above for frequency range above 1000 MHz.

Summary of Results for Radiated Emissions in Restricted Bands

The EUT demonstrated compliance with the radiated emissions requirements of CFR 47 Part 15C Intentional Radiators. The EUT demonstrated a minimum margin of -1.6 dB below the radiated emissions requirements in restricted frequency bands. Peak, Quasi-peak, and average amplitudes were checked for compliance with the regulations. Worst-case emissions are reported with other emissions found in the restricted frequency bands at least 20 dB below the requirements.

AC Line Conducted Emissions Procedure

The EUT was arranged in a typical equipment configuration and placed on a 1 x 1.5-meter wooden bench 80 cm above the conducting ground plane, floor of a screen room. The bench was positioned 40 cm away from the wall of the screen room. The LISN was positioned on the floor of the screen room 80-cm from the rear of the EUT. The manufacturer supplied POE/AC power adapter for the EUT was connected to the LISN. A second LISN was positioned on the floor of the screen room 80-cm from the rear of the supporting equipment of the EUT. All power cords except the EUT were then powered from the second LISN. EMI was coupled to the spectrum analyzer through a 0.1 μ F capacitor, internal to the LISN. Power line conducted emissions testing were carried out individually for each current carrying conductor of the EUT. The excess length of lead between the system and the LISN receptacle was folded back and forth to form a bundle not exceeding 40 cm in length. The screen room, conducting ground plane, analyzer, and LISN were bonded together to the protective earth ground. Preliminary testing was performed to identify the frequency of each radio frequency emission displaying the highest amplitude. The cables were repositioned to obtain maximum amplitude of measured EMI level. Once the worst-case configuration was identified, plots were made of the EMI from 0.15 MHz to 30 MHz then the data was recorded with maximum conducted emissions levels. Refer to figures one and two for plots of the EUT powered by AC adapter, AC Power Line conducted emissions.

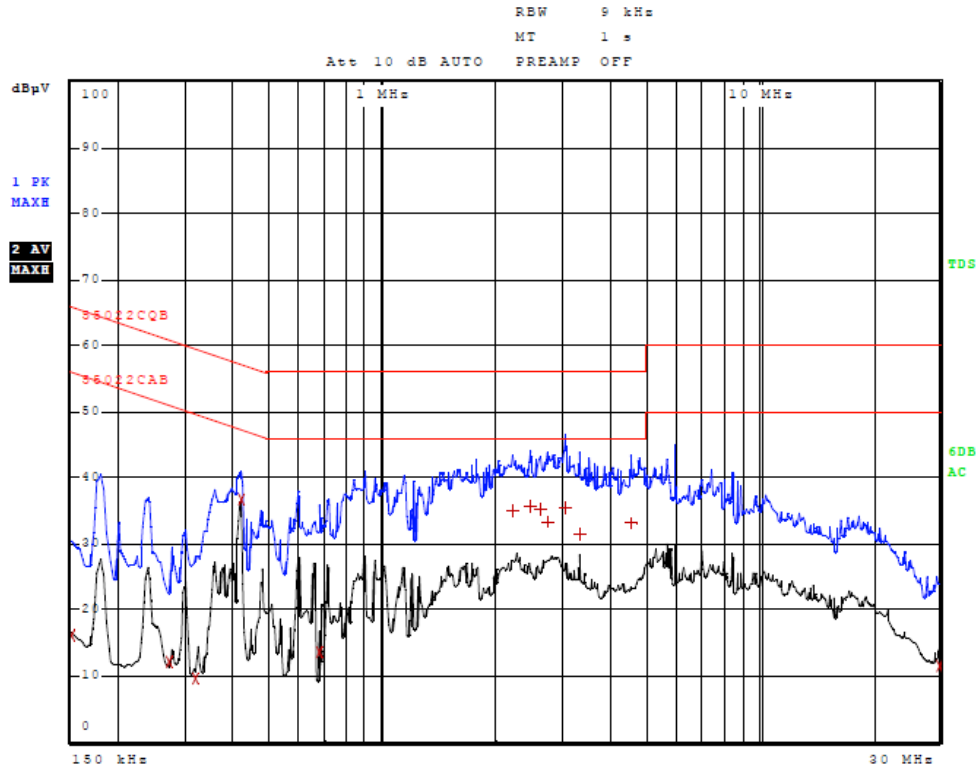

Figure One AC Line Conducted Emissions Line 1

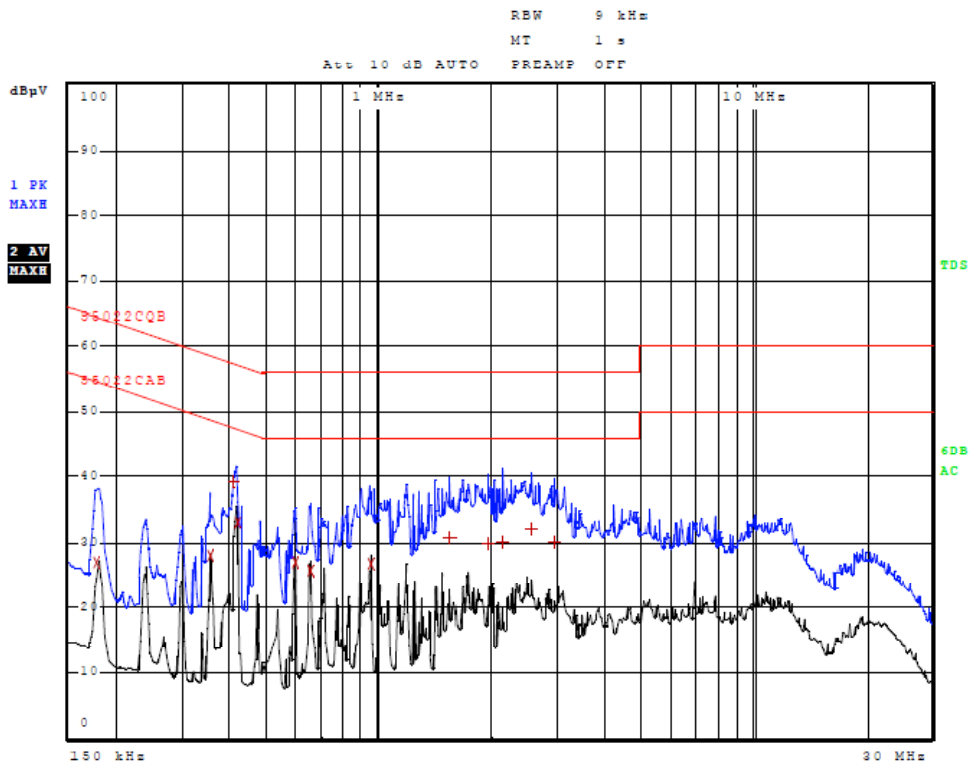

Figure Two AC Line Conducted Emissions Line 2



AC Line Conducted Emissions Data (Highest Emissions)

Line 1

Trace	Frequency	Level (dBµV)	Detector	Delta Limit/dB
2	150.000000000 kHz	16.08	Average	-39.92
2	274.000000000 kHz	12.07	Average	-38.93
2	322.000000000 kHz	9.59	Average	-40.06
2	418.000000000 kHz	36.61	Average	-10.88
2	678.000000000 kHz	13.65	Average	-32.35
1	2.218000000 MHz	35.02	Quasi Peak	-20.98
1	2.470000000 MHz	35.67	Quasi Peak	-20.33
1	2.626000000 MHz	35.28	Quasi Peak	-20.72
1	2.734000000 MHz	33.29	Quasi Peak	-22.71
1	3.050000000 MHz	35.44	Quasi Peak	-20.56
1	3.310000000 MHz	31.45	Quasi Peak	-24.55
1	4.570000000 MHz	33.11	Quasi Peak	-22.89
2	30.000000000 MHz	11.44	Average	-38.56

Line 2

Trace	Frequency	Level (dBµV)	Detector	Delta Limit/dB
2	178.000000000 kHz	27.06	Average	-27.52
2	354.000000000 kHz	28.12	Average	-20.75
1	414.000000000 kHz	39.20	Quasi Peak	-18.37
2	418.000000000 kHz	33.08	Average	-14.41
2	594.000000000 kHz	26.99	Average	-19.01
2	654.000000000 kHz	25.71	Average	-20.29
2	950.000000000 kHz	26.69	Average	-19.31
1	1.546000000 MHz	30.75	Quasi Peak	-25.25
1	1.950000000 MHz	30.02	Quasi Peak	-25.98
1	2.134000000 MHz	30.09	Quasi Peak	-25.91
1	2.546000000 MHz	32.02	Quasi Peak	-23.98
1	2.950000000 MHz	30.23	Quasi Peak	-25.77

Other emissions present had amplitudes at least 20 dB below the limit.

Summary of Results for AC Line Conducted Emissions

The EUT demonstrated compliance to the conducted emissions requirements of CFR47 Part 15C equipment. The EUT demonstrated minimum margin of -10.9 dB below the limit.

Measurements were taken using the peak, quasi peak, and average, measurement function for each emissions amplitude and were below the limits stated in the specification. Other emissions were present with recorded data representing worst-case amplitudes.



General Radiated Emissions Procedure

The EUT was arranged in a typical equipment configuration and operated through all available modes with worst-case data recorded. Preliminary testing was performed in a screen room with the EUT positioned 1 meter from the FSM. Radiated emissions measurements were performed to identify the frequencies, which produced the highest emissions. Plots were made of the radiated frequency spectrum from 30 MHz to 40,000 MHz for the preliminary testing. Refer to figures three through eleven for plots of the general radiated emissions spectrum taken in a screen room. Each radiated emission was then maximized at the OATS location before final radiated emissions measurements were performed. Final data was taken with the EUT located at the OATS at a distance of 3 meters between the EUT and the receiving antenna. The frequency spectrum from 30 MHz to 60,000 MHz was searched for general radiated emissions. Measured emission levels were maximized by EUT placement on the table, rotating the turntable through 360 degrees, varying the antenna height between 1 and 4 meters above the ground plane and changing antenna position between horizontal and vertical polarization. Antennas used were Broadband Biconical from 30 to 200 MHz, Biconilog from 30 to 6000 MHz, Log Periodic from 200 MHz to 5 GHz and or double Ridge or pyramidal horns and mixers from 4 GHz to 60 GHz, notch filters and appropriate amplifiers and external mixers were utilized.

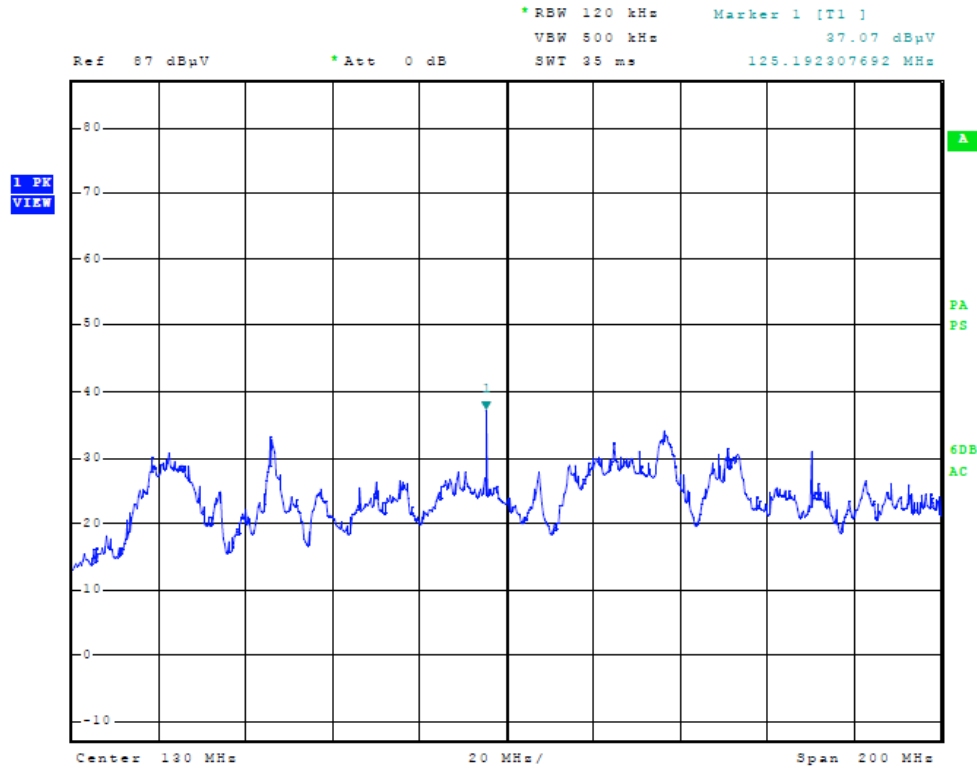

Figure Three General Radiated Emissions taken at 1 meter in screen room

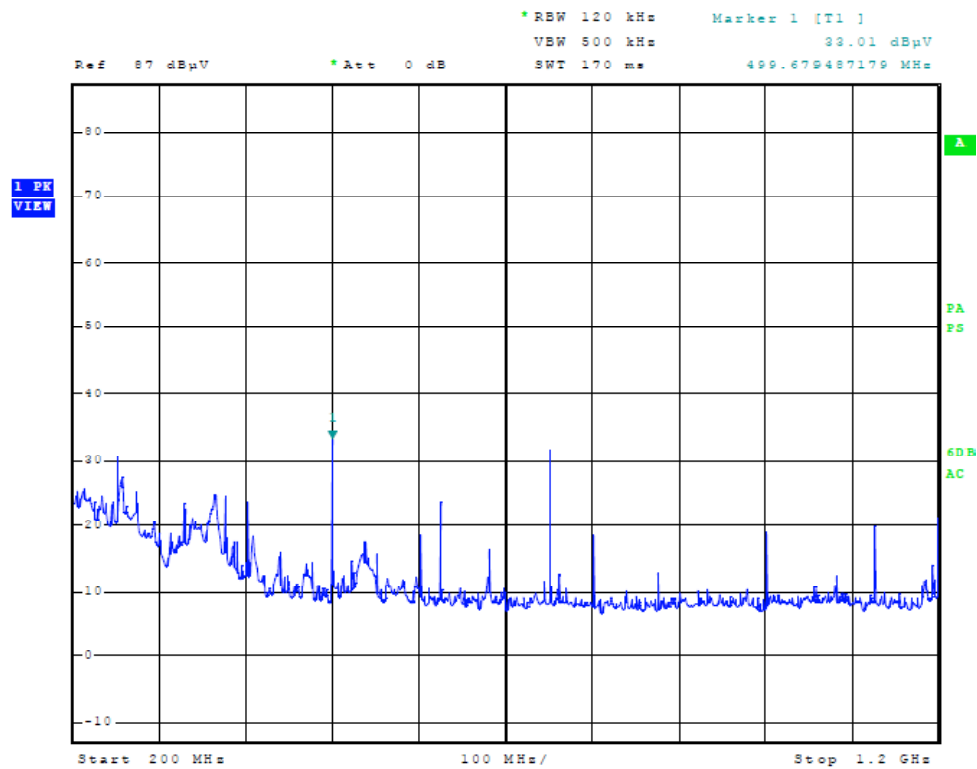

Figure Four General Radiated Emissions taken at 1 meter in screen room

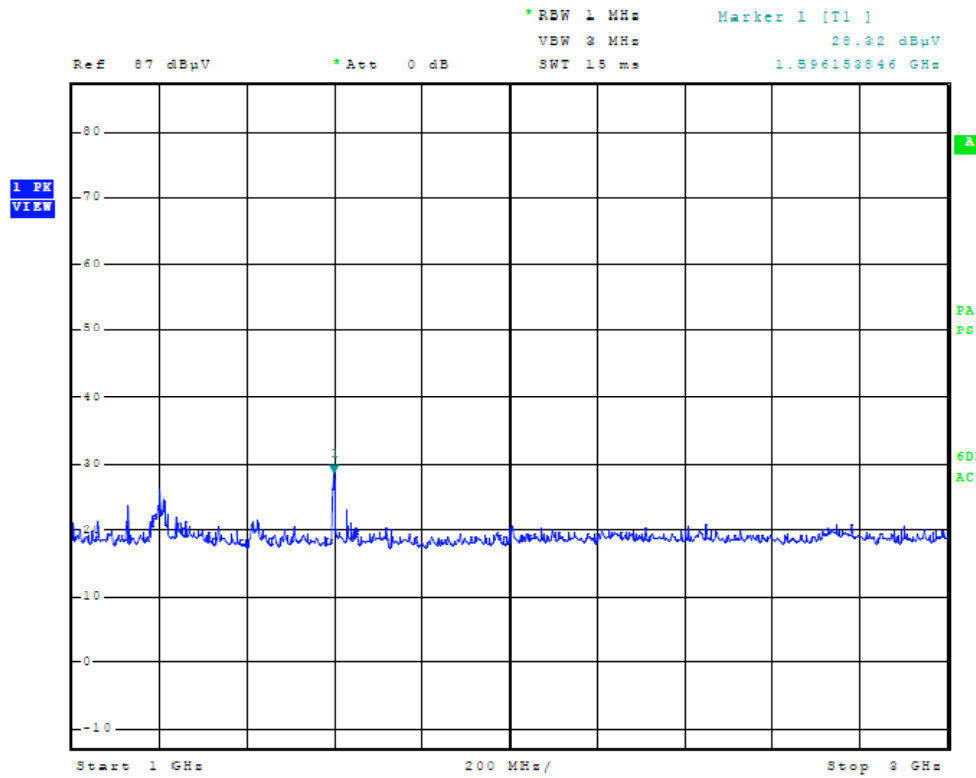

Figure Five General Radiated Emissions taken at 1 meter in screen room

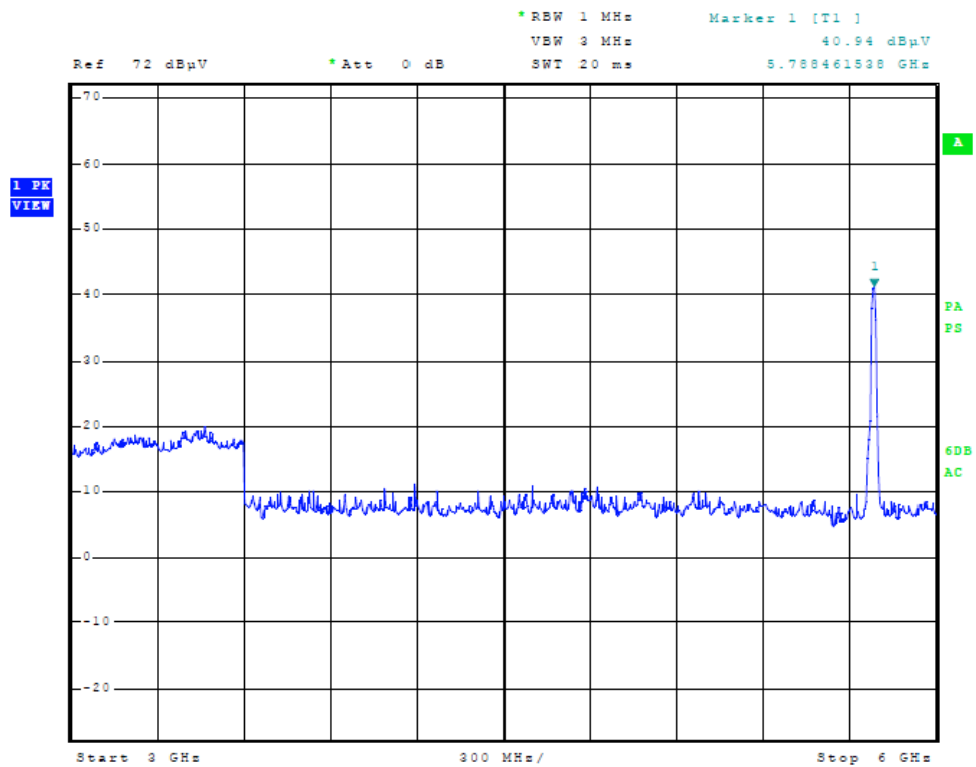

Figure Six General Radiated Emissions taken at 1 meter in screen room

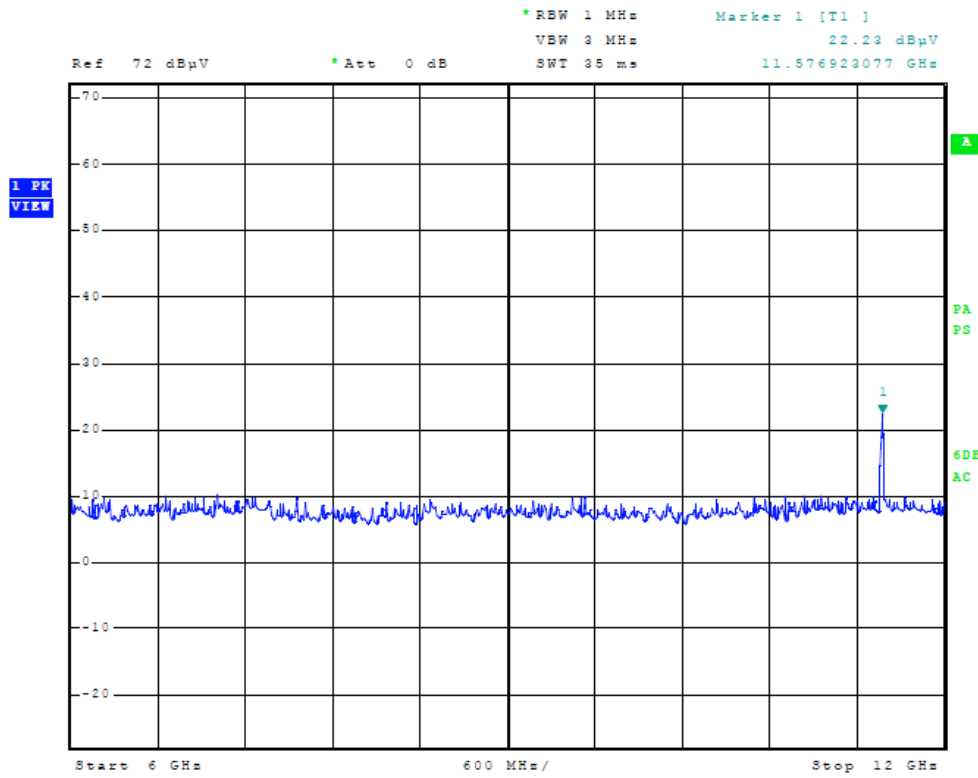

Figure Seven General Radiated Emissions taken at 1 meter in screen room

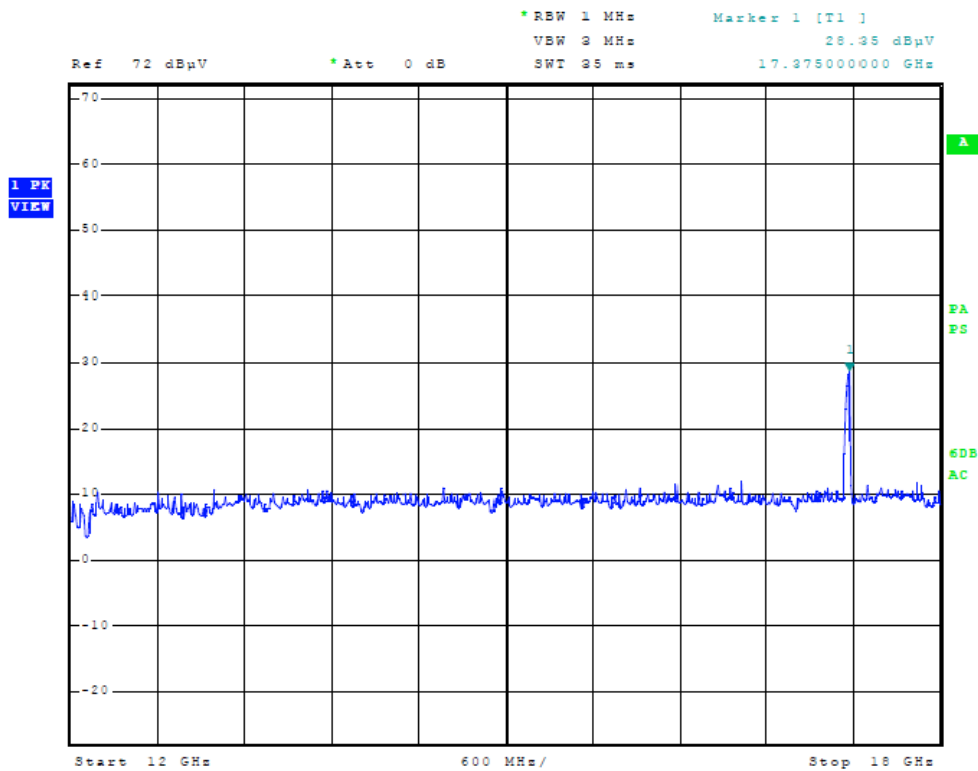

Figure Eight General Radiated Emissions taken at 1 meter in screen room

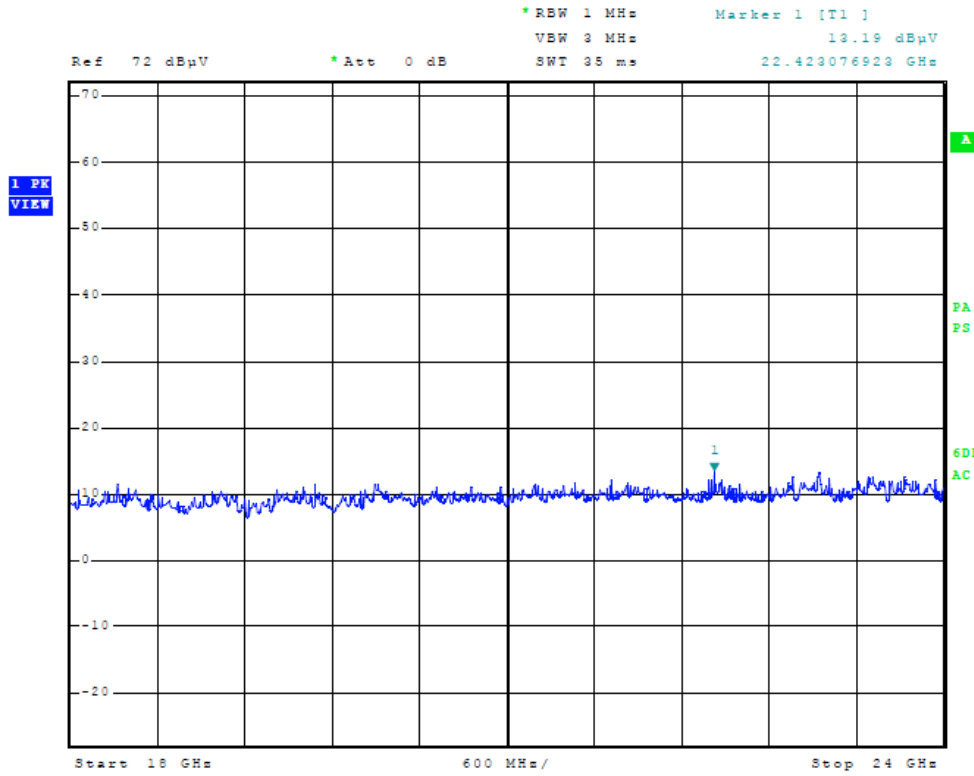

Figure Nine General Radiated Emissions taken at 1 meter in screen room

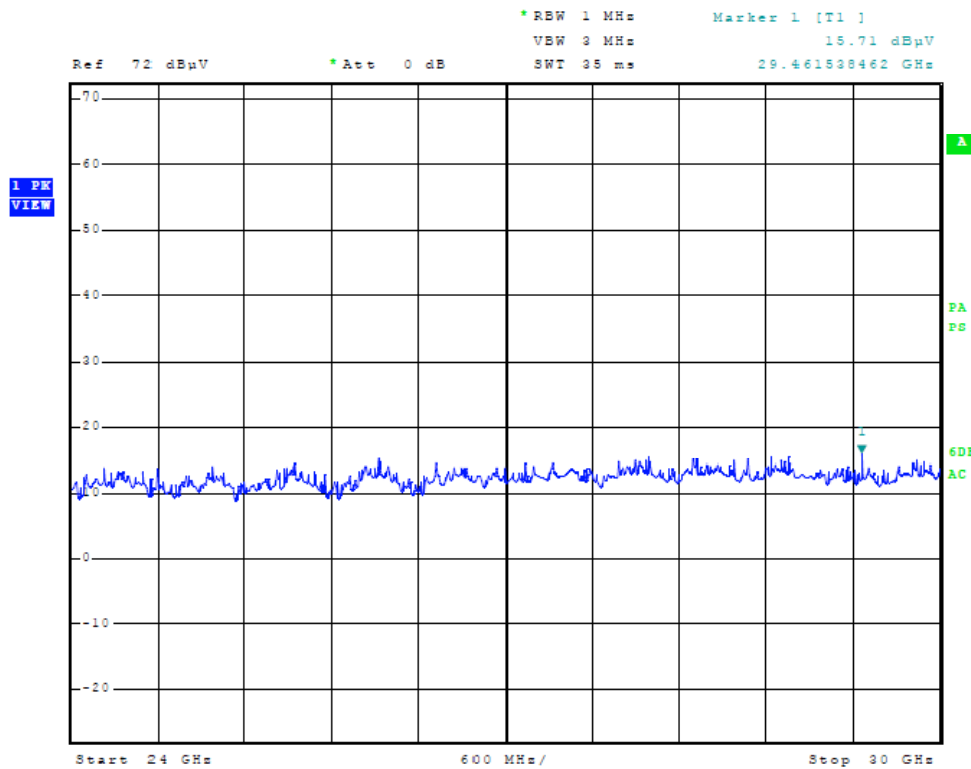
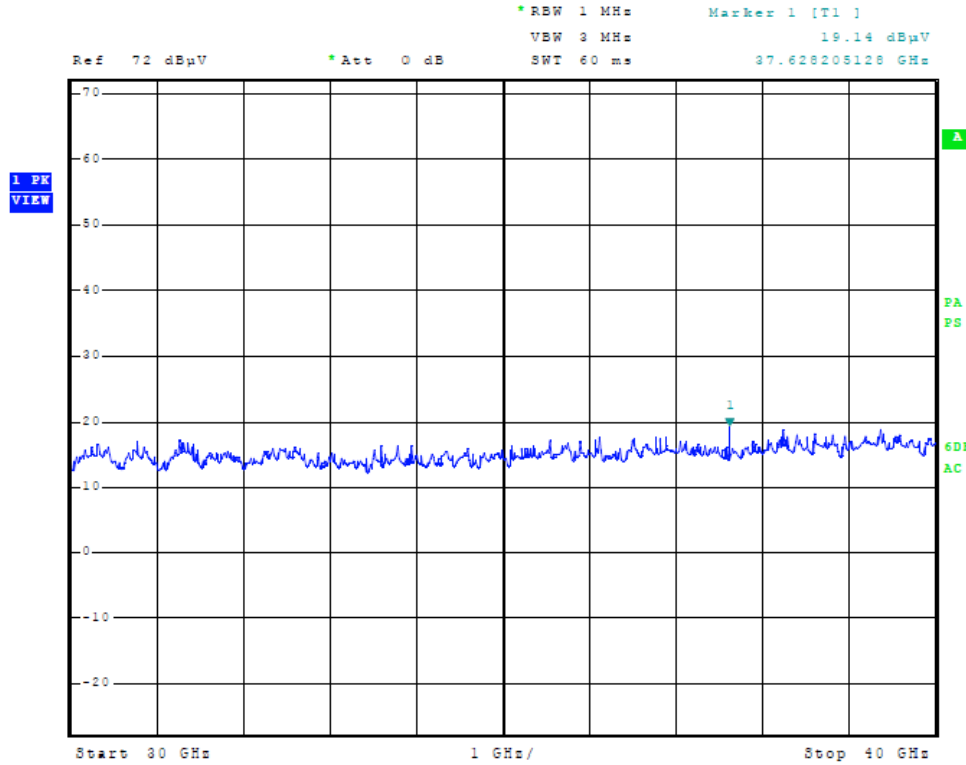

Figure Ten General Radiated Emissions taken at 1 meter in screen room



**Figure Eleven General Radiated Emissions taken at 1 meter in screen room
General Radiated Emissions from EUT Data (Highest Emissions)**

Frequency in MHz	Horizontal Peak (dBµV)	Horizontal Quasi-Peak (dBµV)	Horizontal Average (dBµV)	Vertical Peak (dBµV)	Vertical Quasi-Peak (dBµV)	Vertical Average (dBµV)	Limit @ 3m (dBµV/m)
51.7	30.3	24.7	N/A	41.9	35.7	N/A	40.0
76.0	31.4	26.2	N/A	33.2	27.3	N/A	40.0
125.0	44.3	41.9	N/A	45.6	41.9	N/A	43.5
154.1	31.6	26.3	N/A	35.4	30.3	N/A	43.5
154.9	32.6	26.2	N/A	35.7	30.2	N/A	43.5
157.6	33.5	28.0	N/A	36.6	30.6	N/A	43.5
166.9	38.3	33.2	N/A	36.3	30.9	N/A	43.5
178.0	36.0	30.1	N/A	36.1	30.3	N/A	43.5
181.9	32.4	27.9	N/A	36.1	29.6	N/A	43.5
183.0	31.8	26.8	N/A	34.2	29.6	N/A	43.5
200.0	35.2	26.6	N/A	36.5	30.5	N/A	43.5
250.0	37.6	34.7	N/A	32.5	28.9	N/A	46.0
255.5	32.7	27.7	N/A	23.4	17.6	N/A	46.0
500.0	36.5	32.3	N/A	42.7	41.2	N/A	46.0
750.0	45.8	44.3	N/A	42.3	41.1	N/A	46.0
1598.8	44.5	N/A	30.7	50.7	N/A	34.7	54.0

Other emissions present had amplitudes at least 20 dB below the limit.

Quasi-Peak amplitude emissions are recorded above for frequency range of 30-1000 MHz.

Average amplitude emissions are recorded above for frequency range above 1000 MHz.

Summary of Results for General Radiated Emissions

The EUT demonstrated compliance with the radiated emissions requirements of CFR47 Part 15C paragraph 15.209 Intentional Radiators. The EUT demonstrated a minimum margin of -1.6 dB below the requirements. Other emissions were present with amplitudes at least 20 dB below the Limits. Note: peak amplitudes measured for 1596.9 MHz – horizontal 36.4, vertical 34.2 dB μ V.

Operation in the Band 5725 – 5850 MHz

The power output and emissions were measured at the antenna port in compliance with regulation and KDB guidance. Antenna port conducted emissions testing was performed on each chain as reported below. Summing the measured antenna port conducted data presents total EUT output emissions. EUT emissions were also measured on the open area test site at a three-meter distance. The EUT and test configurations were placed on a wooden turntable 0.8 meters above the ground plane at a distance of 3 meters from the FSM antenna. The peak and quasi-peak amplitude of the frequencies below 1000 MHz were measured using a spectrum analyzer. The peak and average amplitude of emissions above 1000 MHz including were measured using a spectrum analyzer. Data was recorded from the analyzer measurement result. Plots were made of transmitter antenna port conducted performance taken in a screen room. Refer to figures twelve through fifty-seven showing plots of the EUT emissions performance displaying compliance with the specifications.

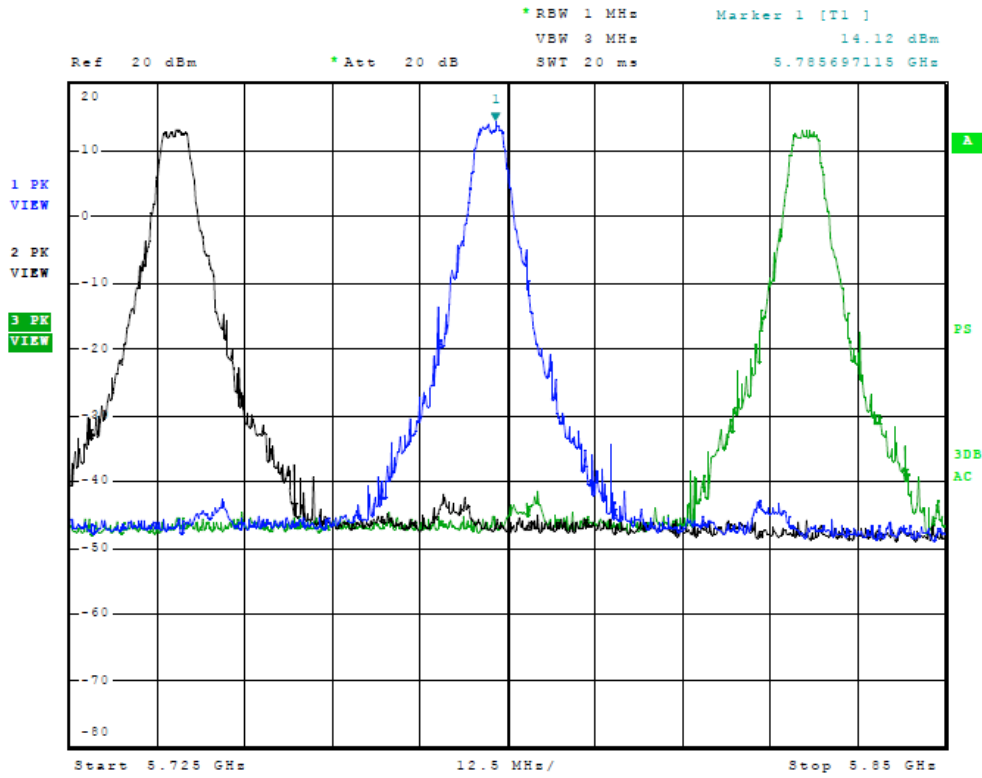

Figure Twelve Plot of Radiated Emissions (Across Operational Band, 5MHz Mode)

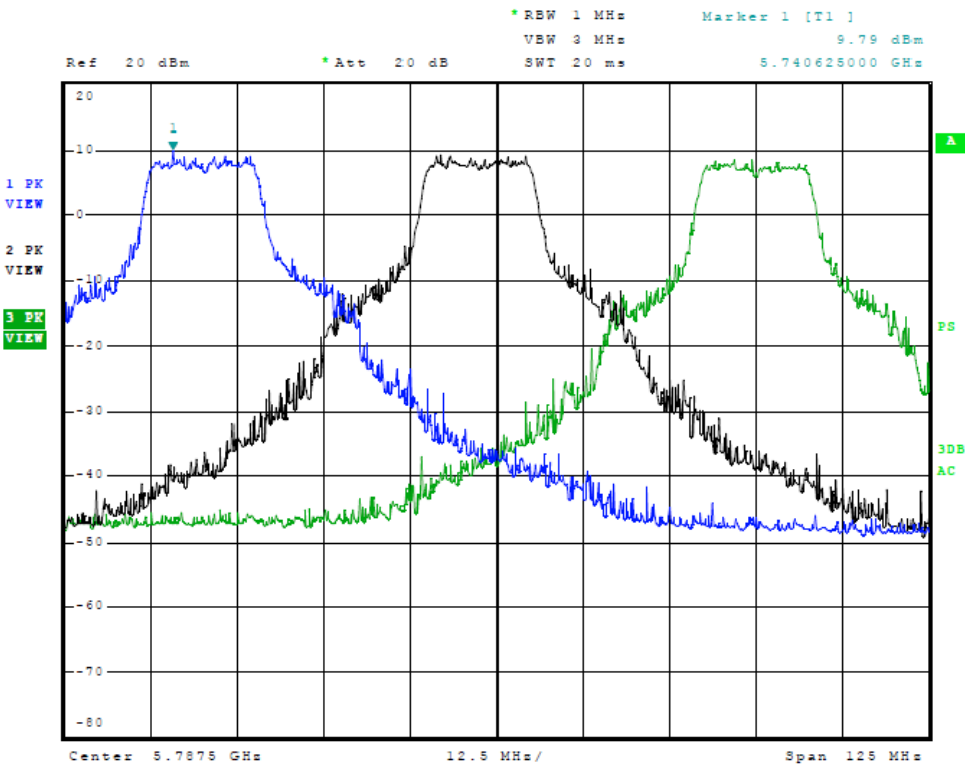

Figure Thirteen Plot of Radiated Emissions (Across Operational Band, 20MHz Mode)

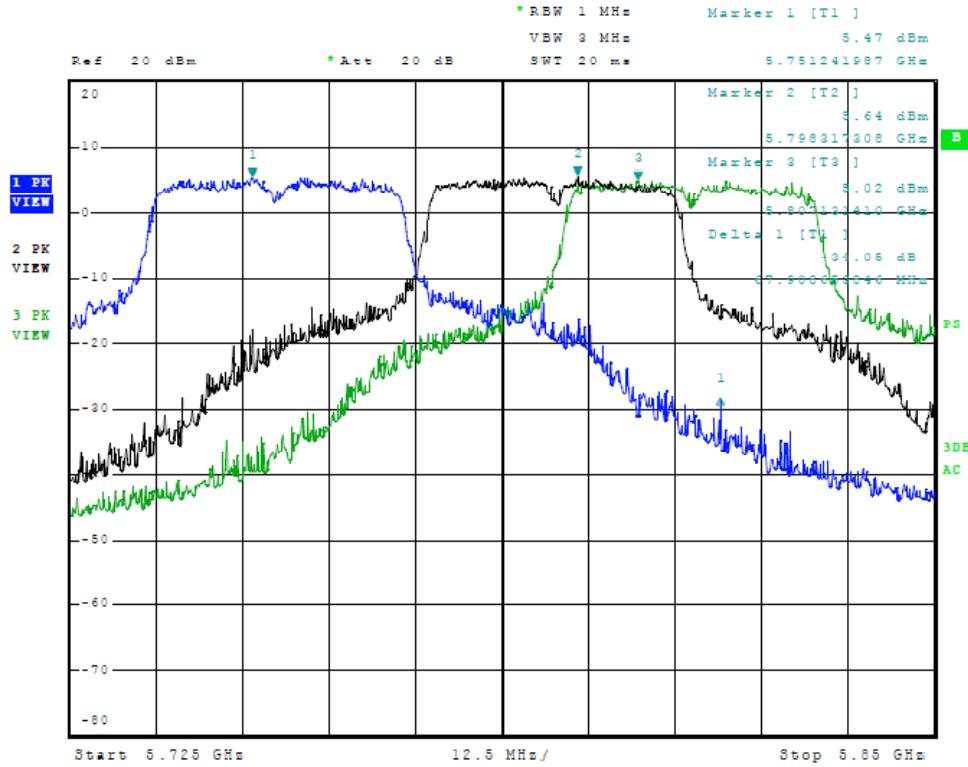

Figure Fourteen Plot of Radiated Emissions (Across Operational Band, 40MHz Mode)

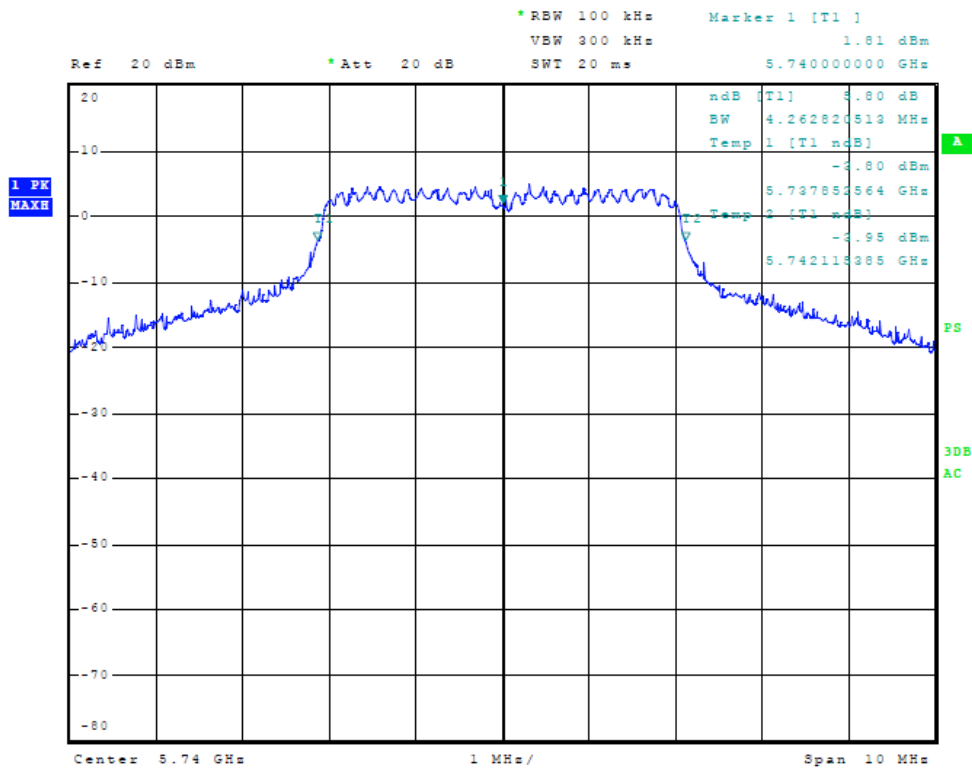

Figure Fifteen Plot of Plot of 6dB Band width (chain 1, 5 MHz Mode, 5740 MHz)

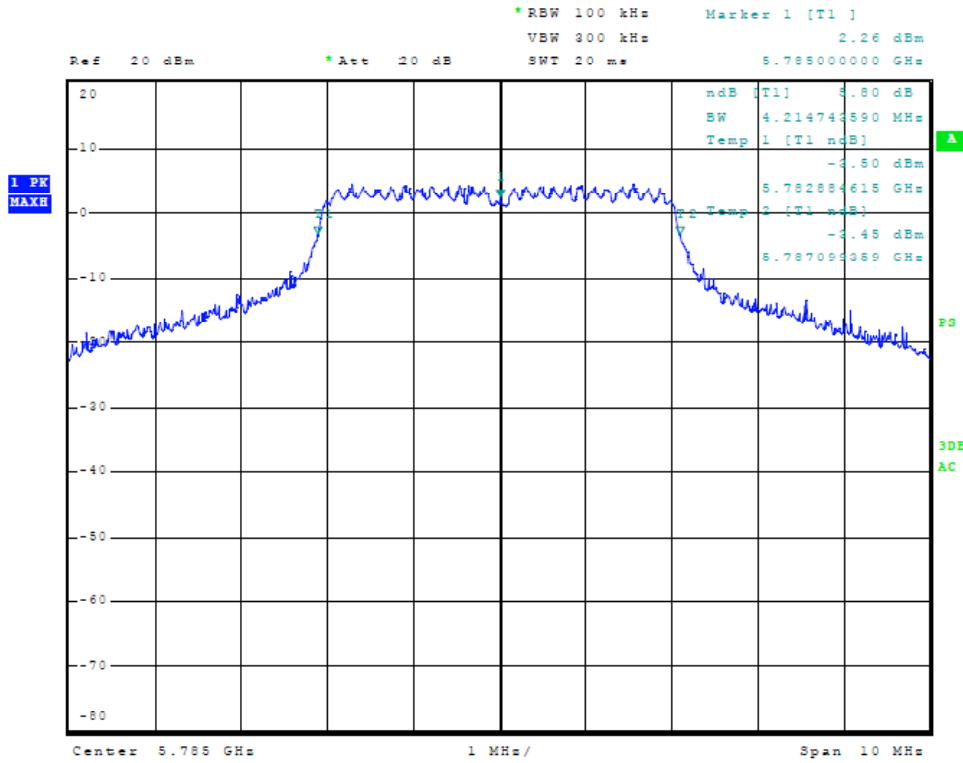

Figure Sixteen Plot of Plot of 6dB Band width (chain 1, 5 MHz Mode, 5785 MHz)

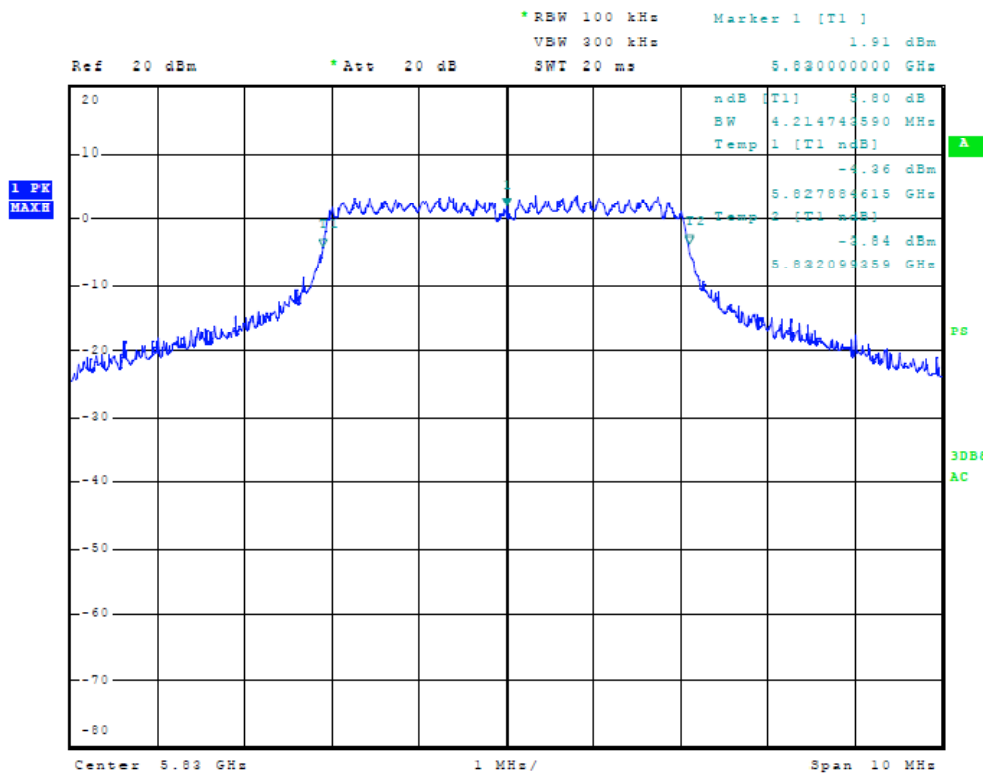

Figure Seventeen Plot of Plot of 6dB Band width (chain 1, 5 MHz Mode, 5830 MHz)

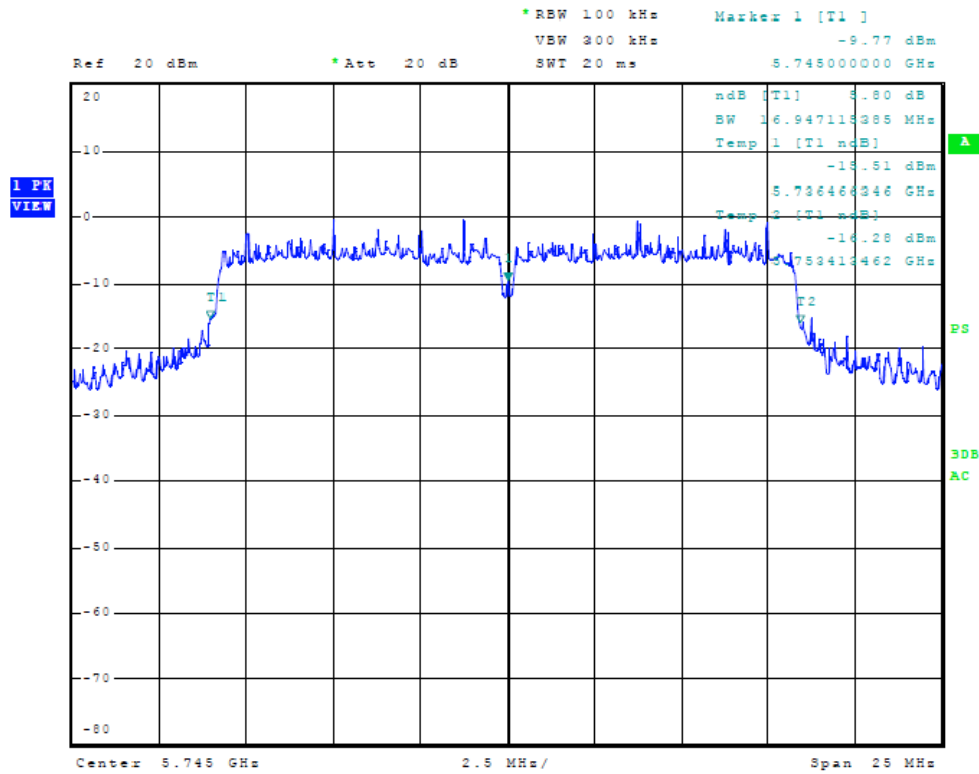

Figure Eighteen Plot of 6dB Band width (chain 1, 20 MHz Mode, 5745 MHz)

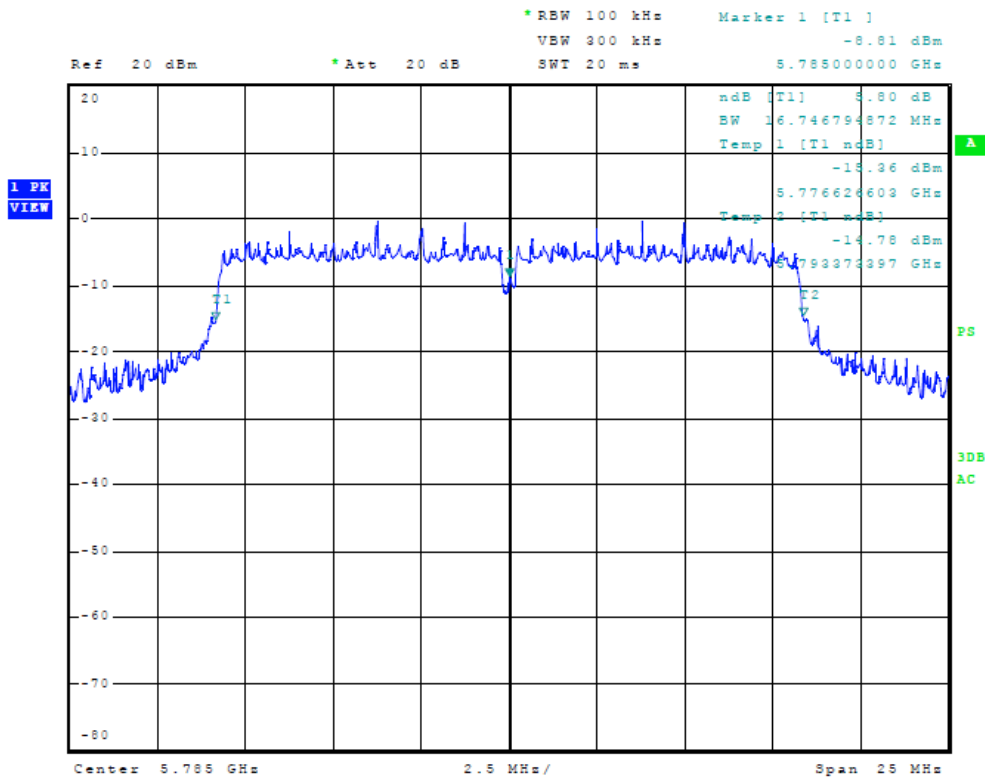

Figure Nineteen Plot of 6dB Band width (chain 1, 20 MHz Mode, 5785 MHz)

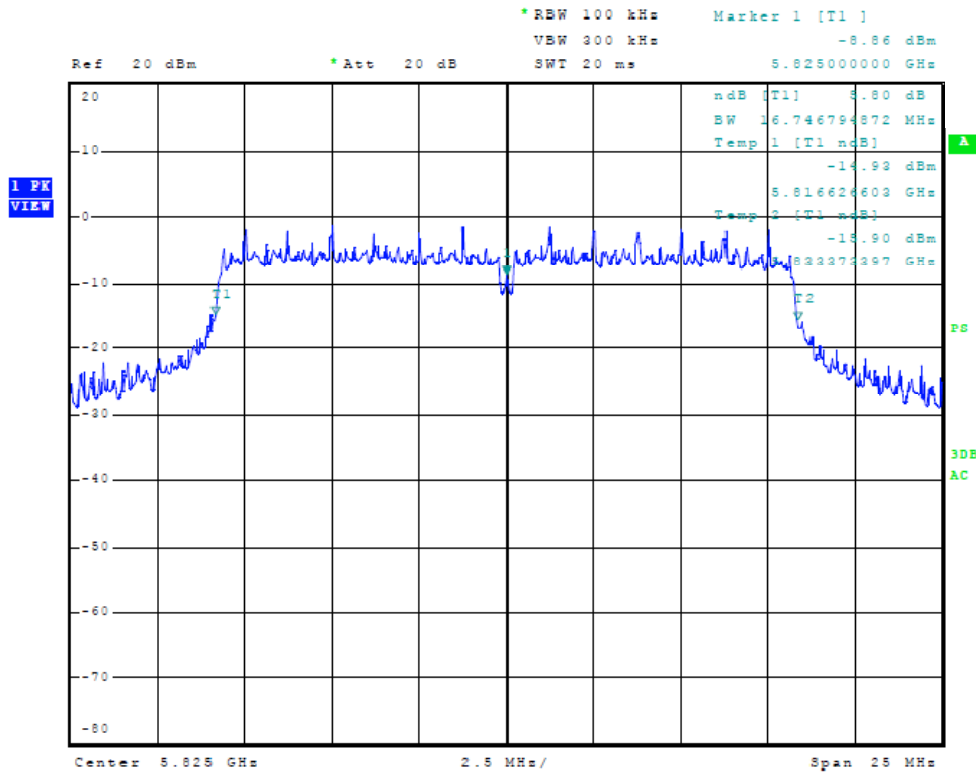

Figure Twenty Plot of 6dB Band width (chain 1, 20 MHz Mode, 5825 MHz)

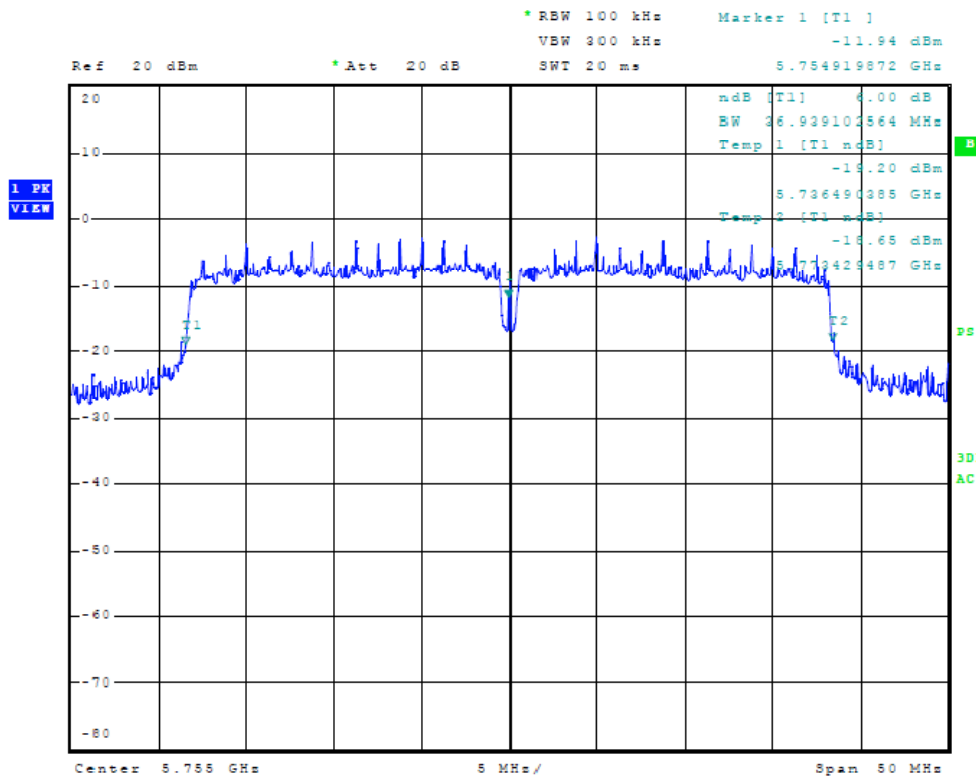

Figure Twenty-one Plot of 6dB Band width (chain 1, 40 MHz Mode, 5755 MHz)

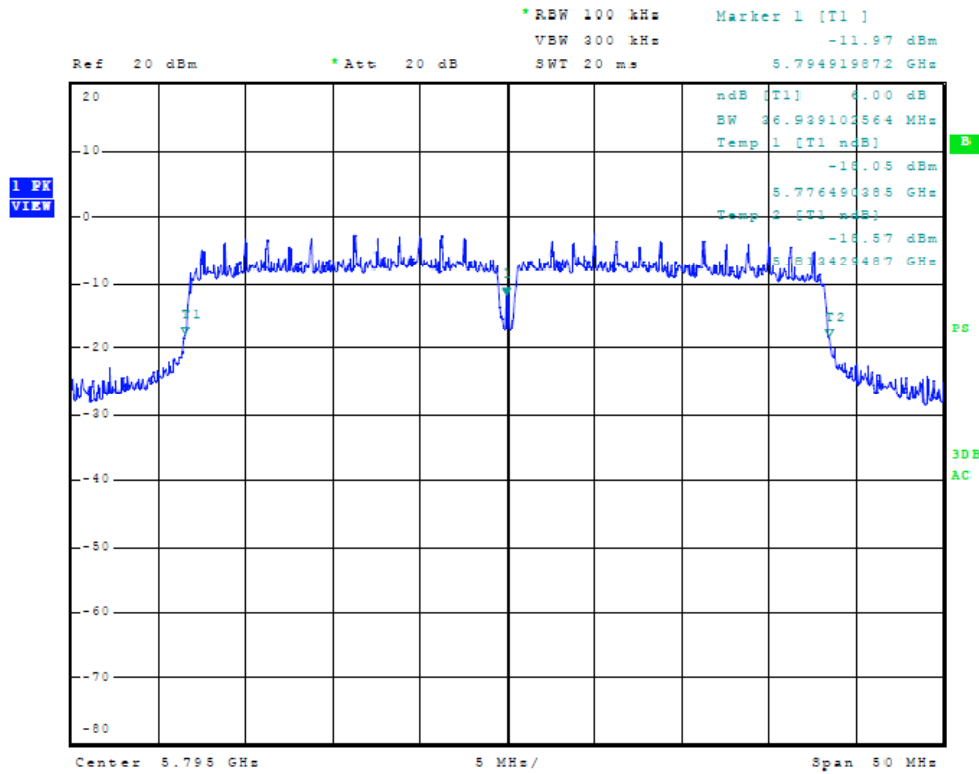

Figure Twenty-two Plot of 6dB Band width (chain 1, 40 MHz Mode, 5795 MHz)

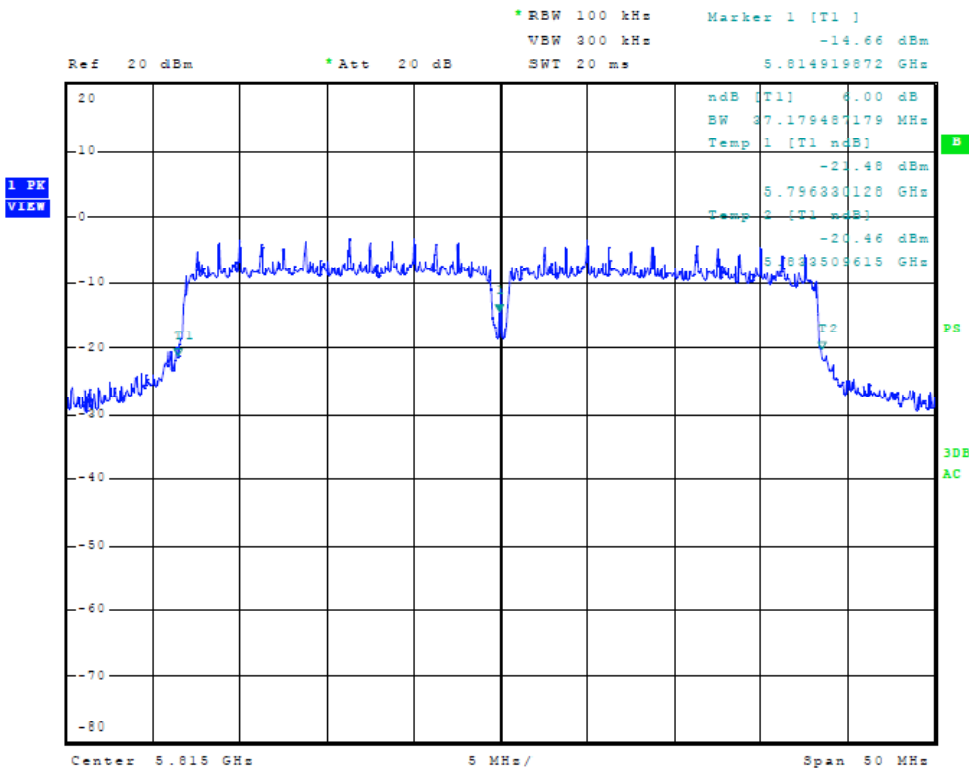

Figure Twenty-three Plot of 6dB Band width (chain 1, 40 MHz Mode, 5815 MHz)

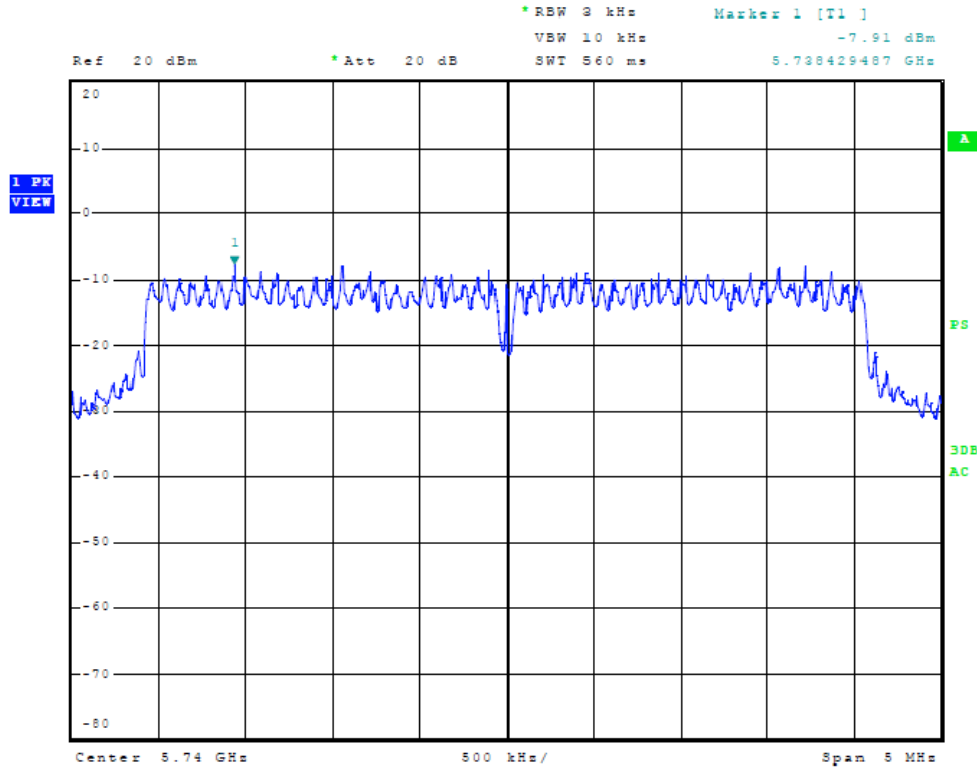

Figure Twenty-four Plot of Power Spectral Density (chain 1, 5 MHz Mode, 5740 MHz)

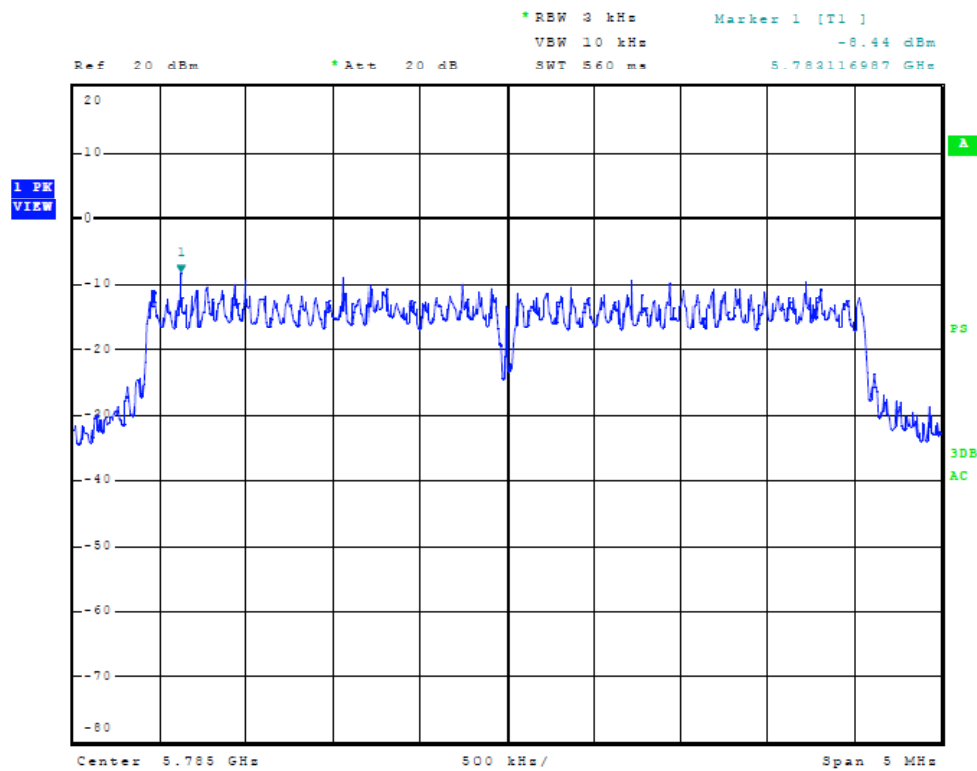

Figure Twenty-five Plot of Power Spectral Density (chain 1, 5 MHz Mode, 5785 MHz)

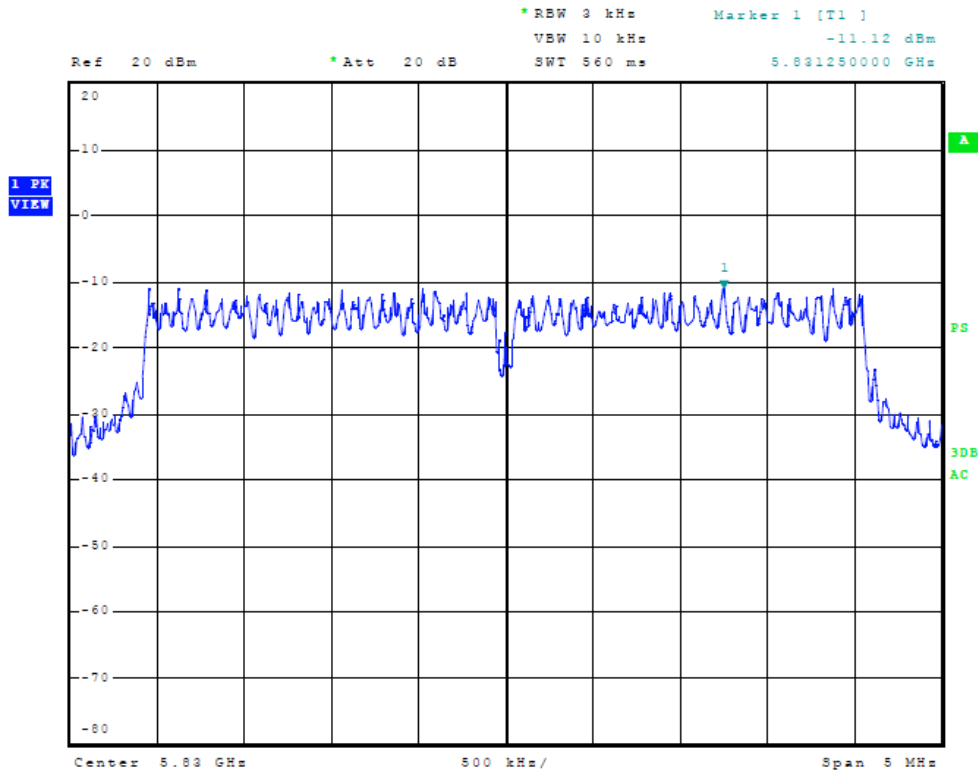

Figure Twenty-six Plot of Power Spectral Density (chain 1, 5 MHz Mode, 5830 MHz)

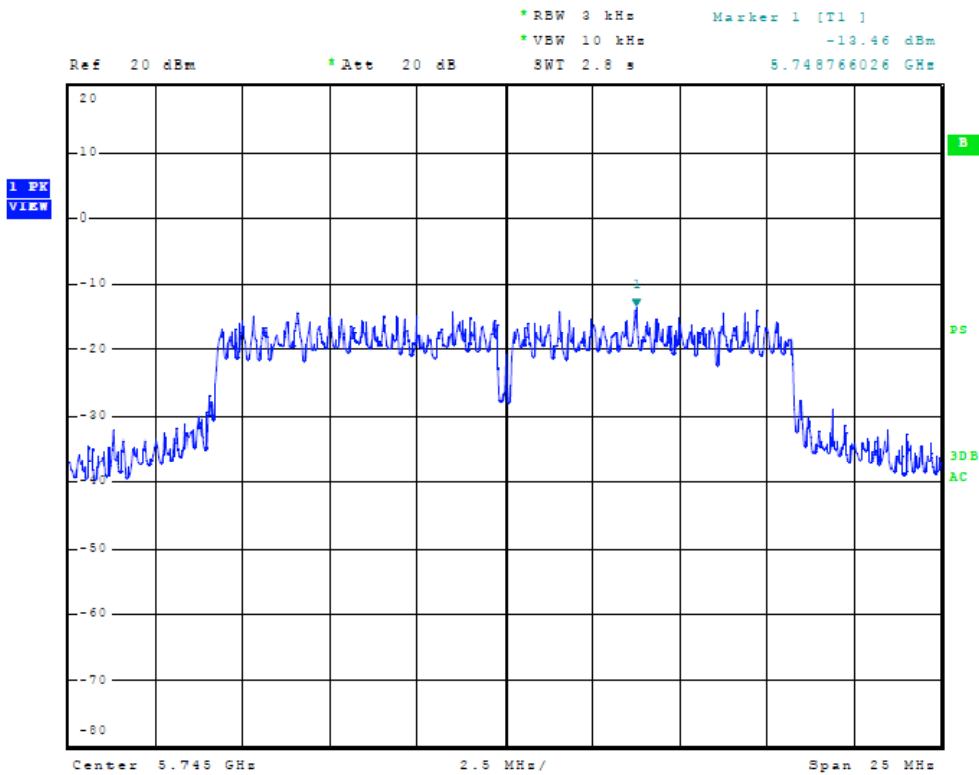

Figure Twenty-seven Plot of Power Spectral Density (chain 1, 20 MHz Mode, 5745 MHz)

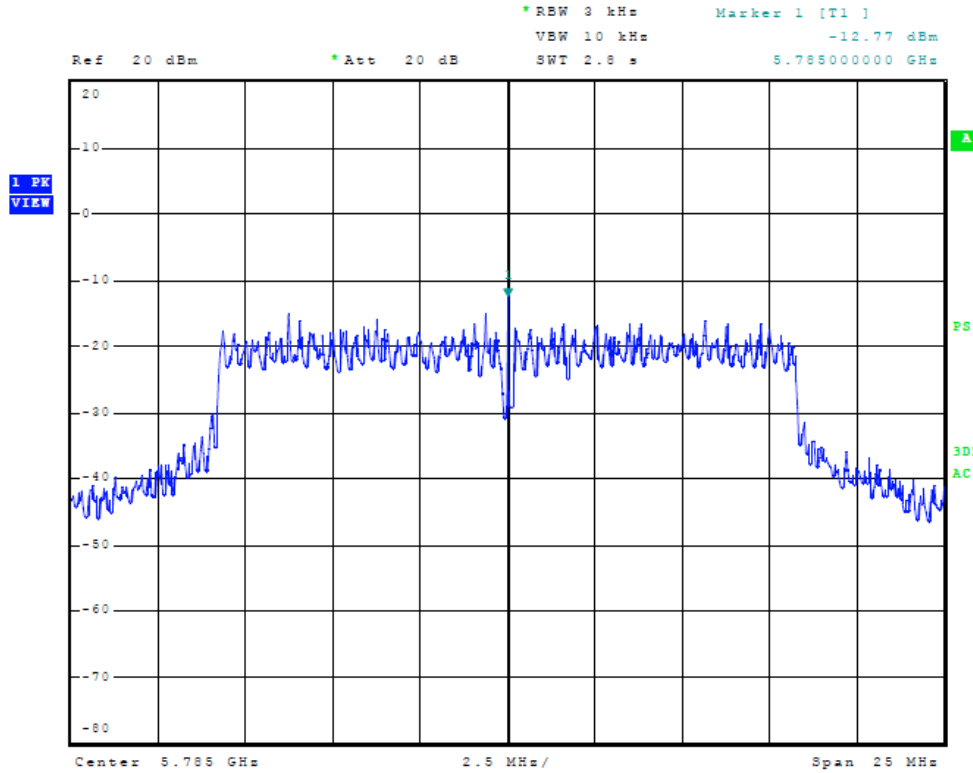

Figure Twenty-eight Plot of Power Spectral Density (chain 1, 20 MHz Mode, 5785 MHz)

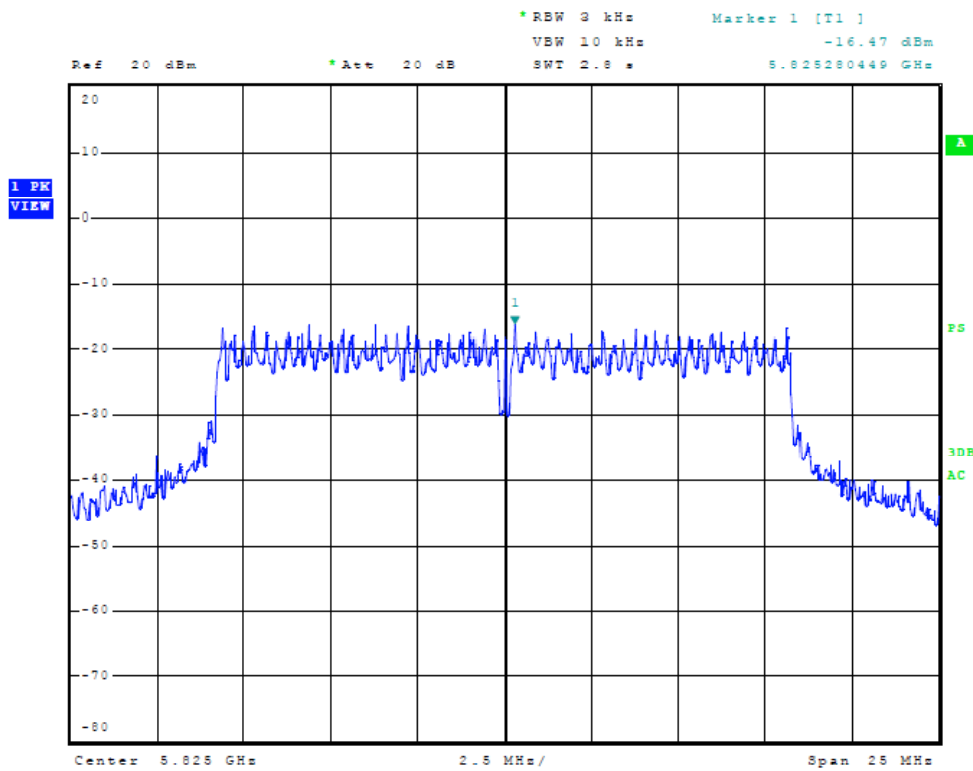

Figure Twenty-nine Plot of Power Spectral Density (chain 1, 20 MHz Mode, 5825 MHz)

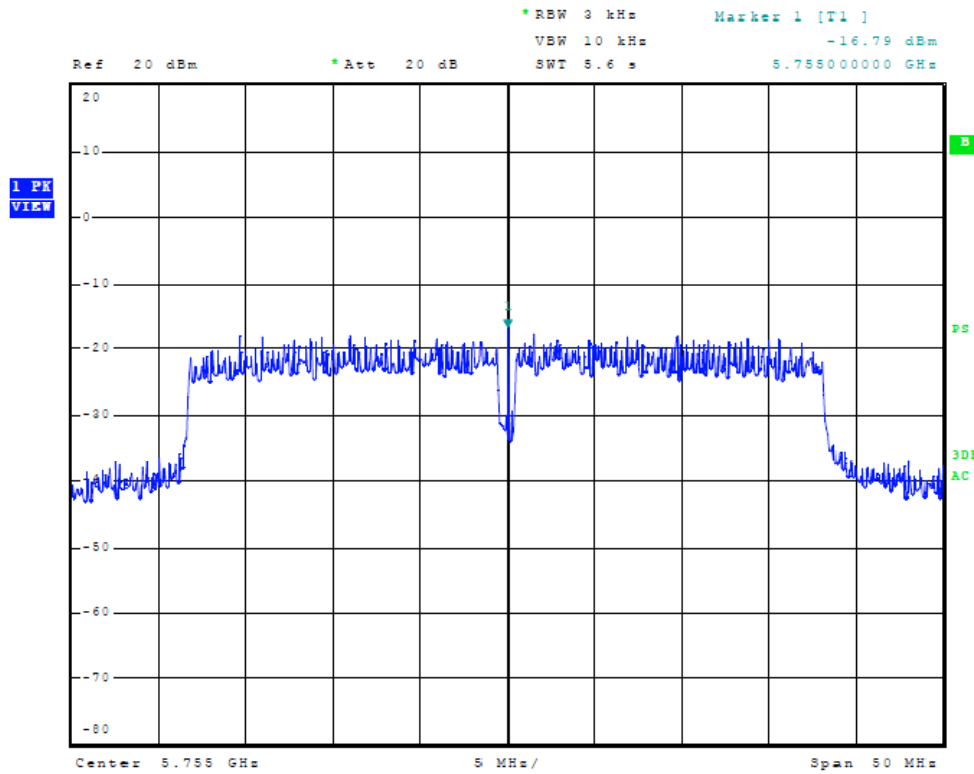

Figure Thirty Plot of Power Spectral Density (chain 1, 40 MHz Mode, 5755 MHz)

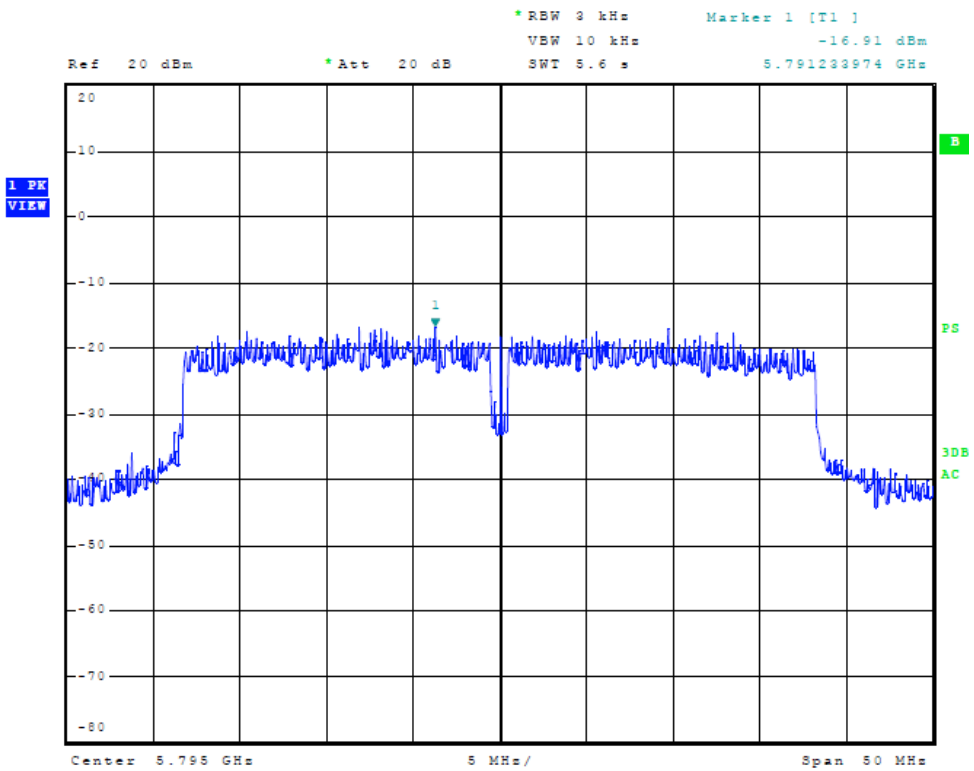

Figure Thirty-one Plot of Power Spectral Density (chain 1, 40 MHz Mode, 5795 MHz)

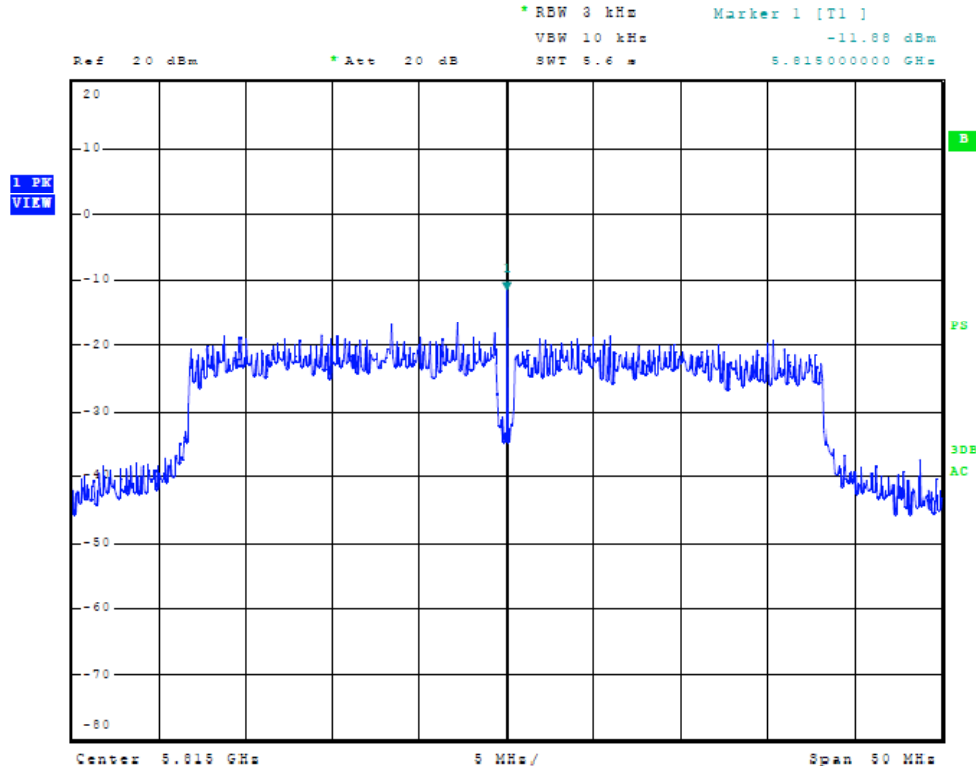

Figure Thirty-two Plot of Power Spectral Density (chain 1, 40 MHz Mode, 5815 MHz)

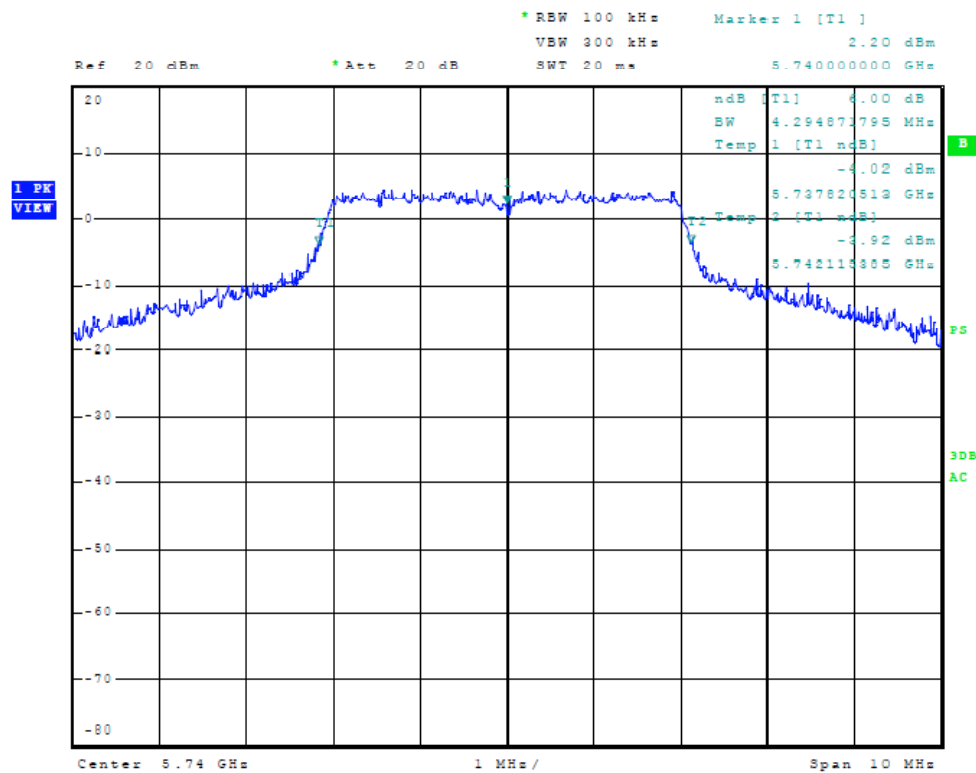

Figure Thirty-three Plot of Plot of 6dB Band width (chain 2, 5 MHz Mode, 5740 MHz)

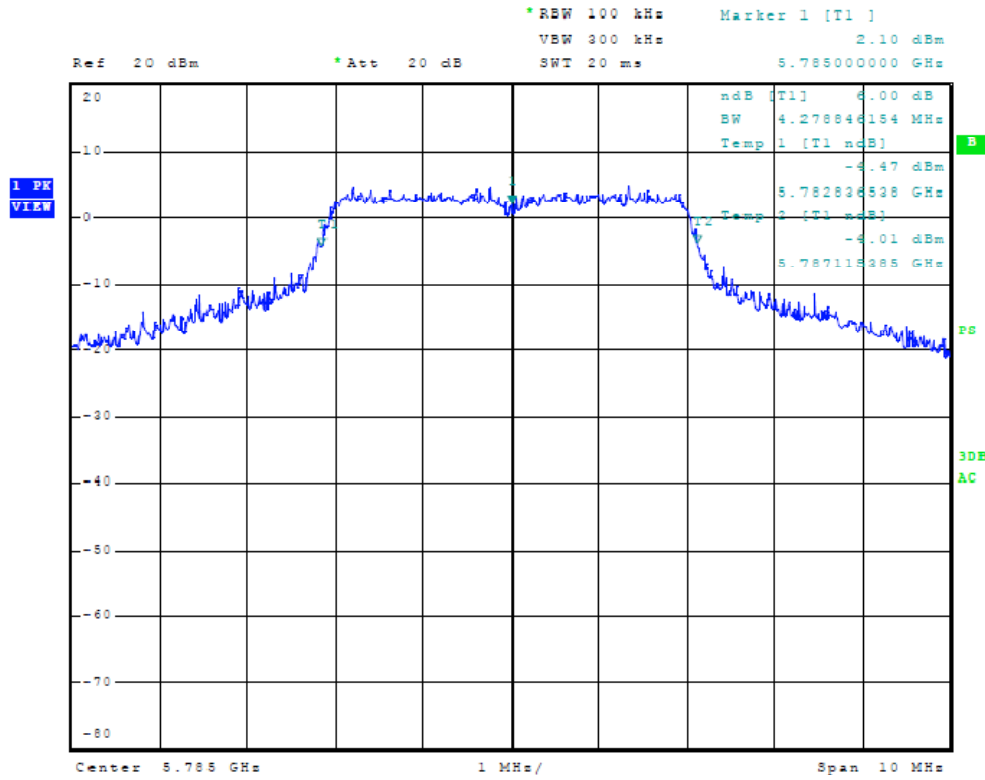

Figure Thirty-four Plot of Plot of 6dB Band width (chain 2, 5 MHz Mode, 5785 MHz)

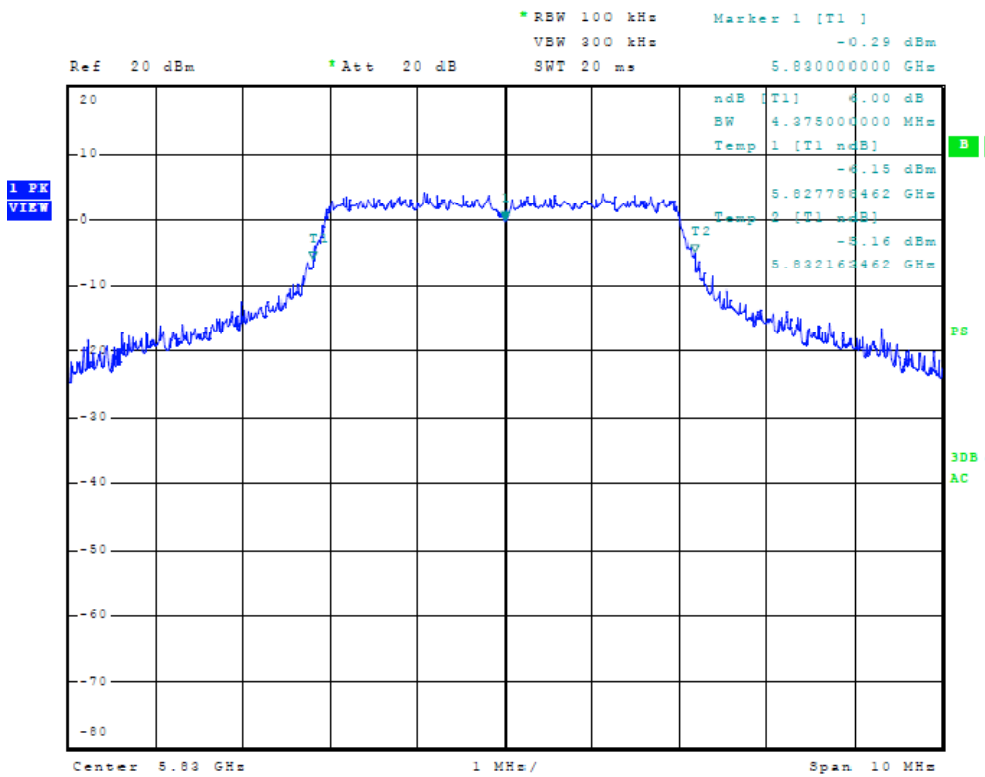

Figure Thirty-five Plot of Plot of 6dB Band width (chain 2, 5 MHz Mode, 5830 MHz)

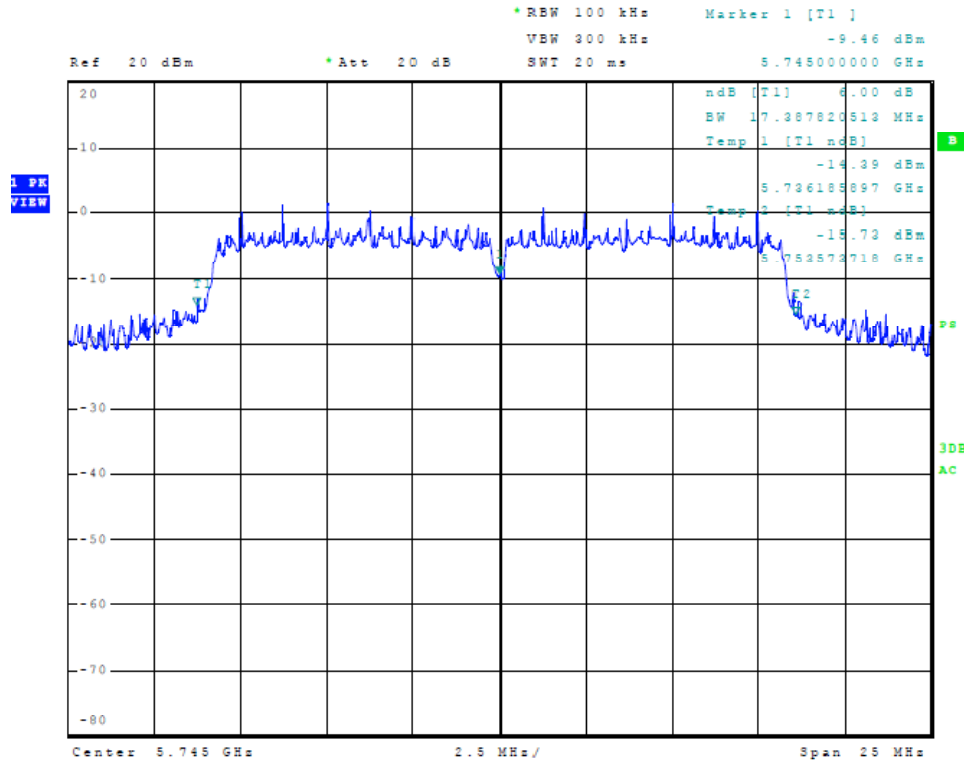

Figure Thirty-six Plot of 6dB Band width (chain 2, 20 MHz Mode, 5745 MHz)

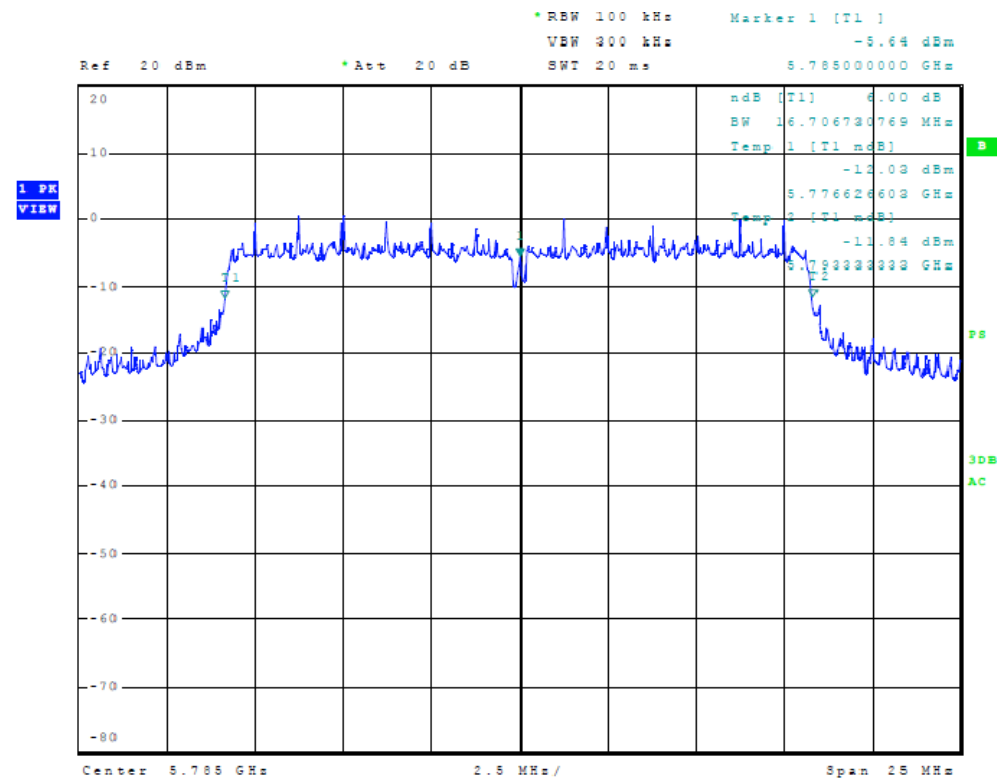

Figure Thirty-seven Plot of 6dB Band width (chain 2, 20 MHz Mode, 5785 MHz)

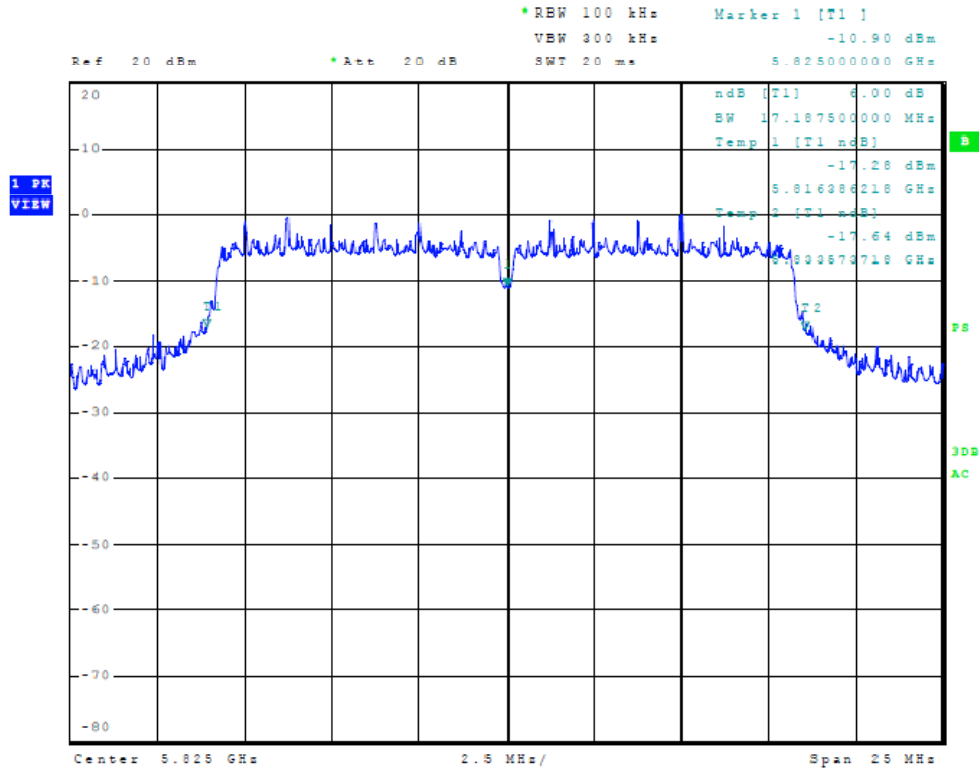

Figure Thirty-eight Plot of 6dB Band width (chain 2, 20 MHz Mode, 5825 MHz)

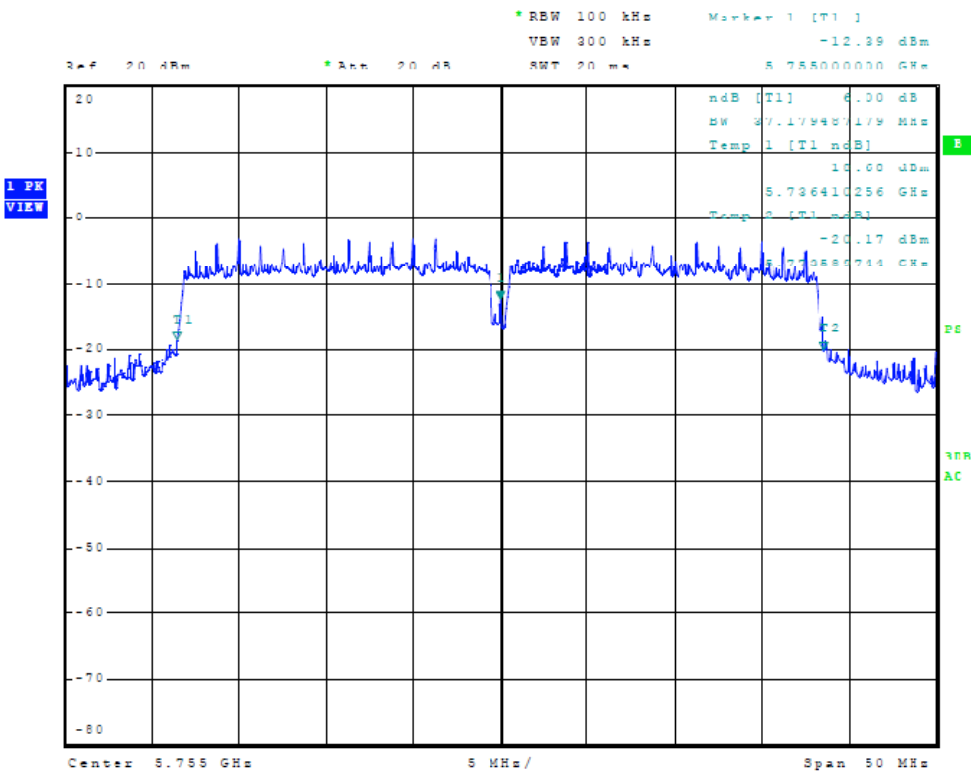

Figure Thirty-nine Plot of 6dB Band width (chain 2, 40 MHz Mode, 5755 MHz)

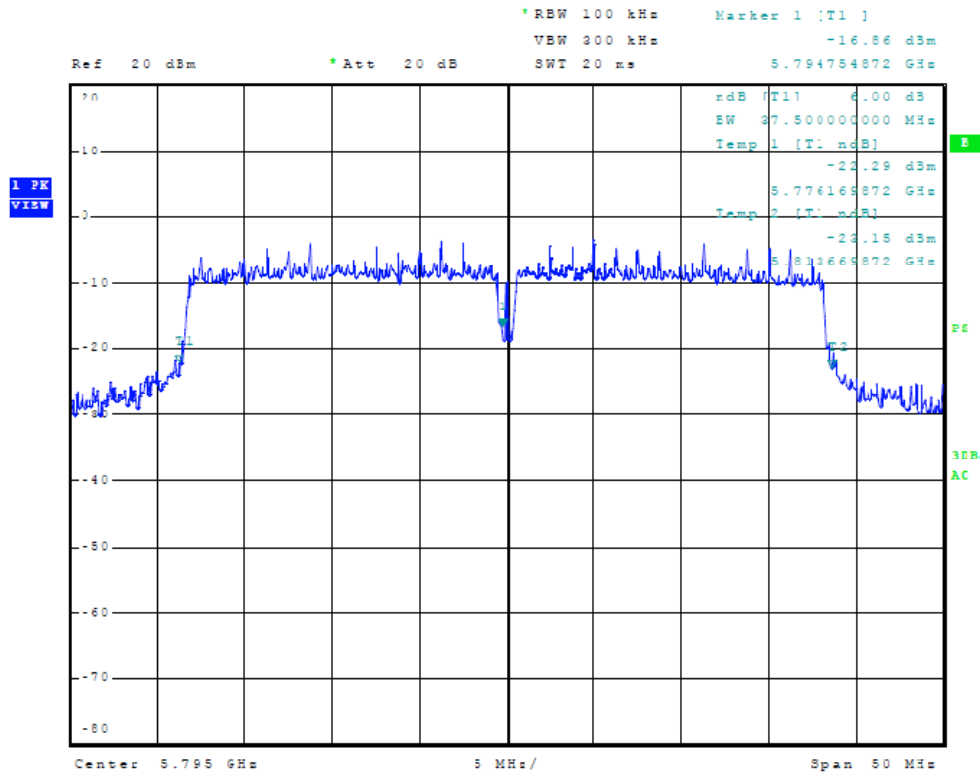

Figure Forty Plot of 6dB Band width (chain 2, 40 MHz Mode, 5795 MHz)

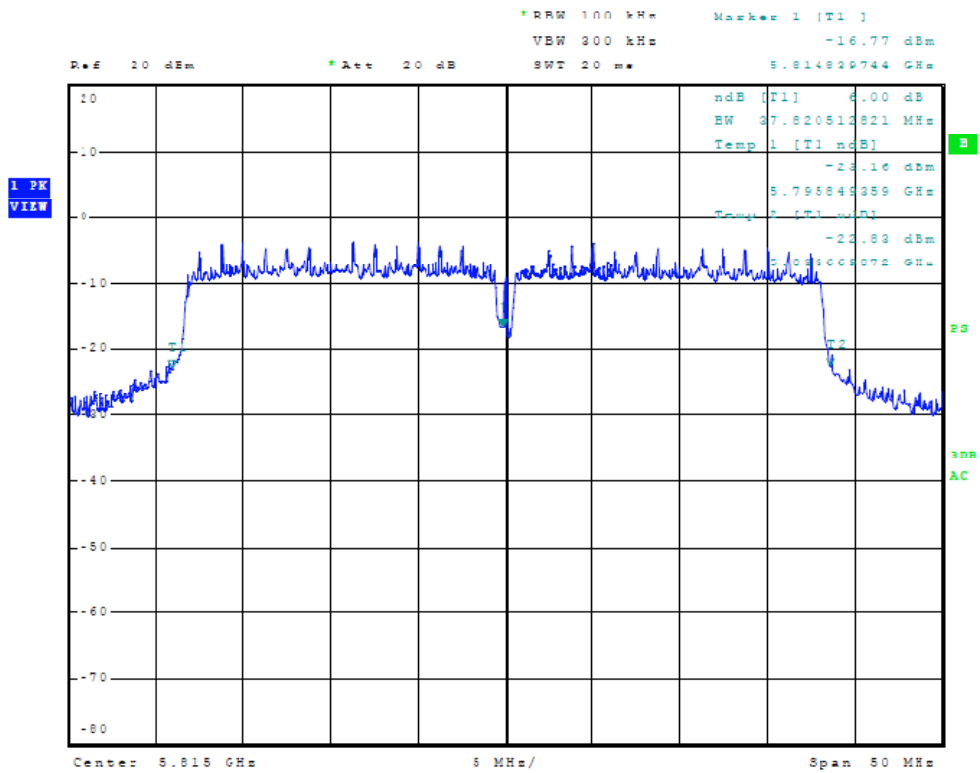

Figure Forty-one Plot of 6dB Band width (chain 2, 40 MHz Mode, 5815 MHz)

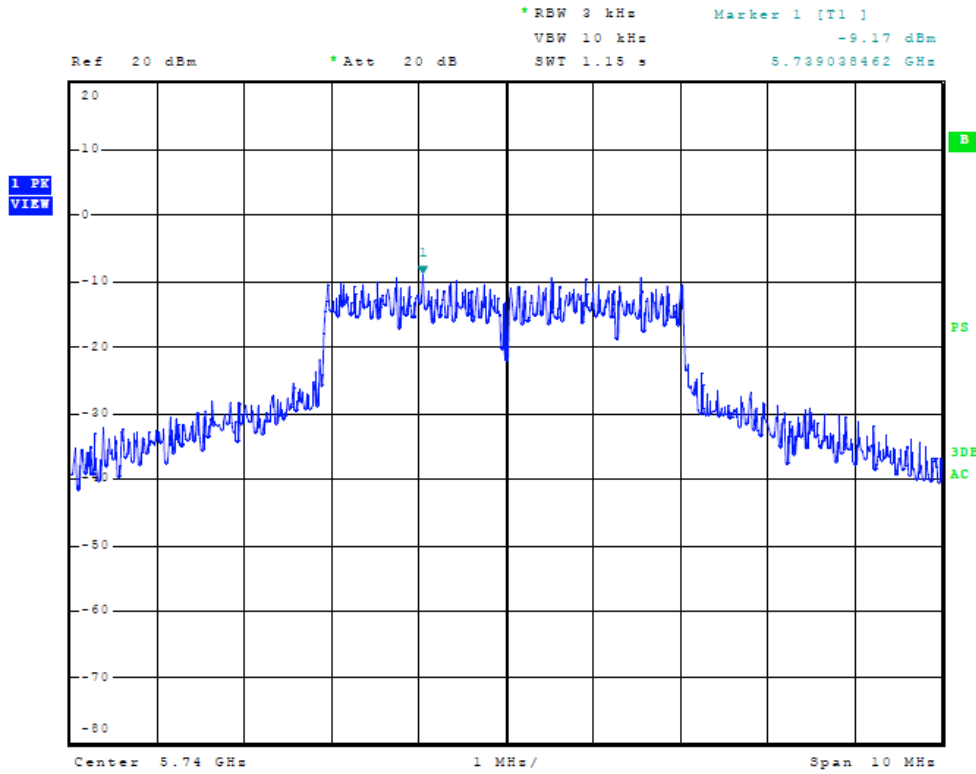

Figure Forty-two Plot of Power Spectral Density (chain 2, 5 MHz Mode, 5740 MHz)

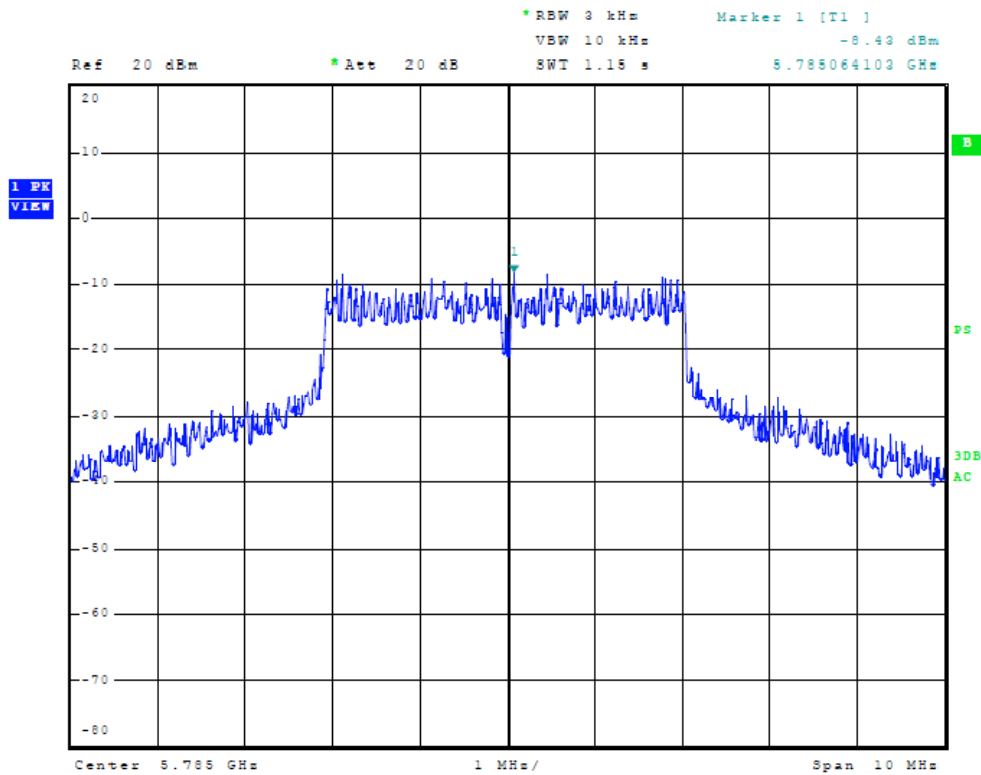

Figure Forty-three Plot of Power Spectral Density (chain 2, 5 MHz Mode, 5785 MHz)

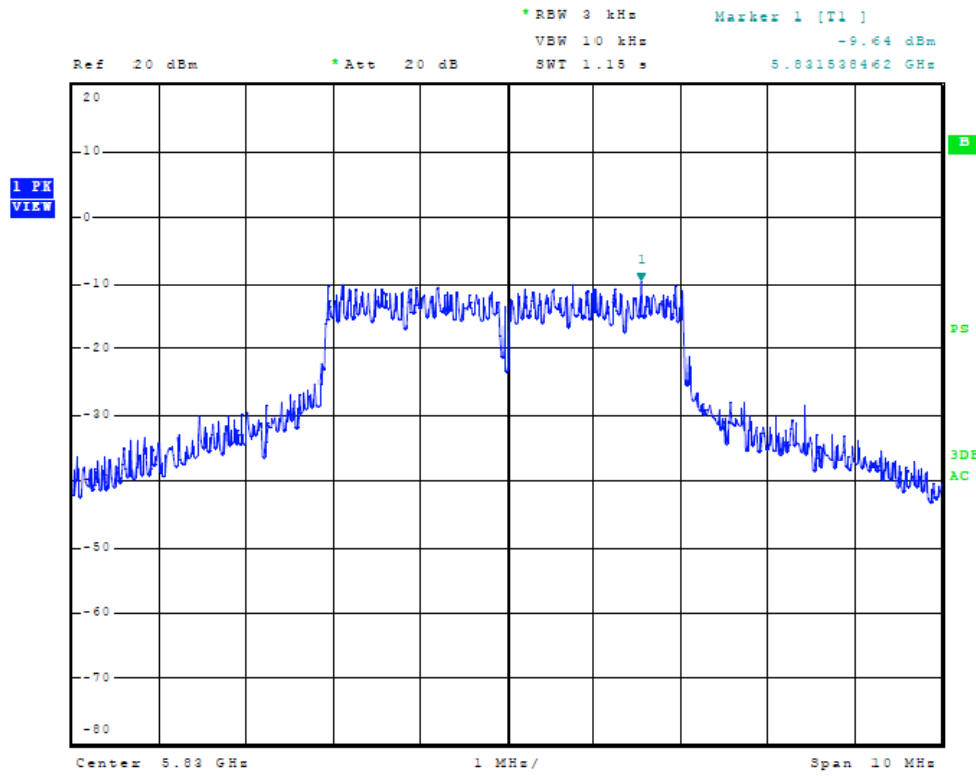

Figure Forty-four Plot of Power Spectral Density (chain 2, 5 MHz Mode, 5830 MHz)

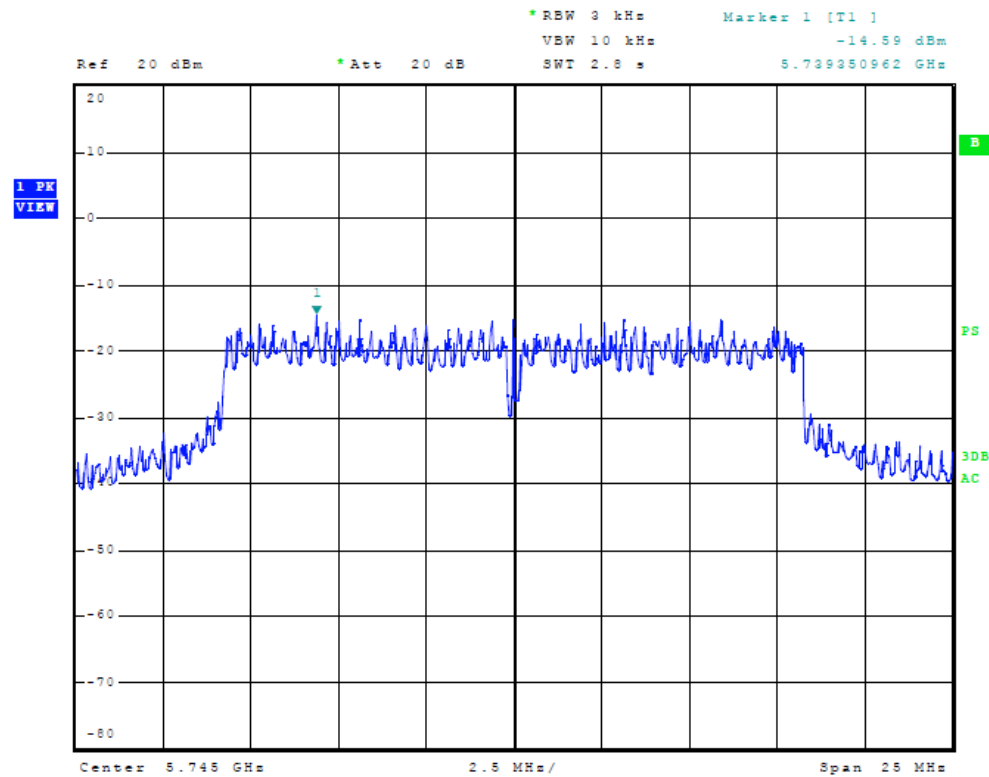

Figure Forty-five Plot of Power Spectral Density (chain 2, 20 MHz Mode, 5745 MHz)

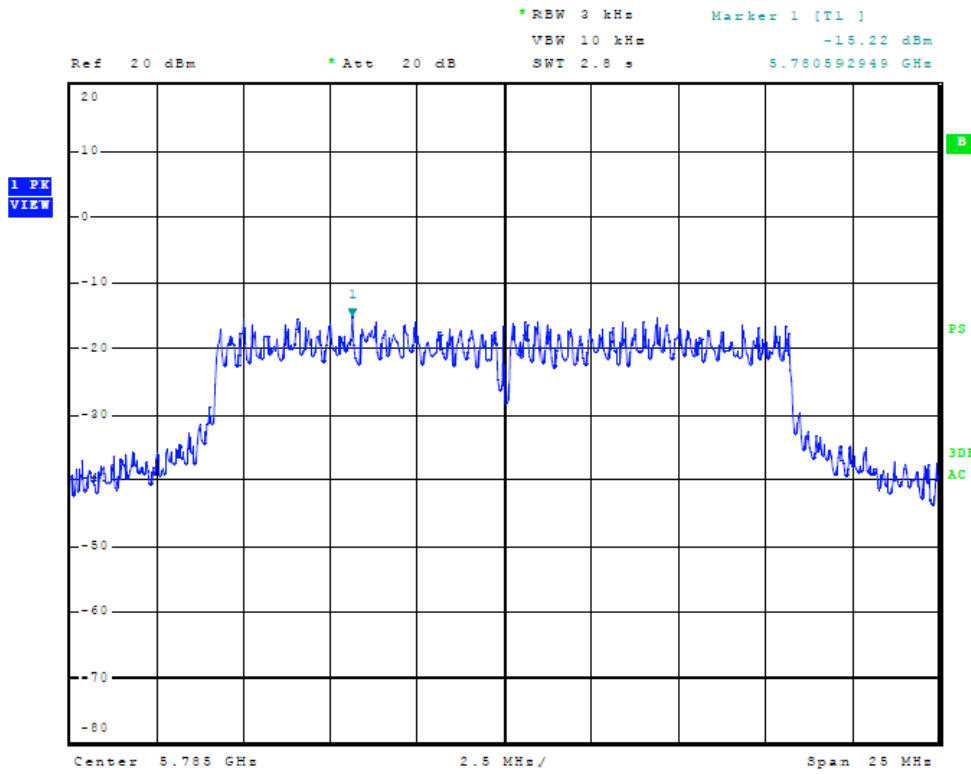

Figure Forty-six Plot of Power Spectral Density (chain 1, 20 MHz Mode, 5785 MHz)

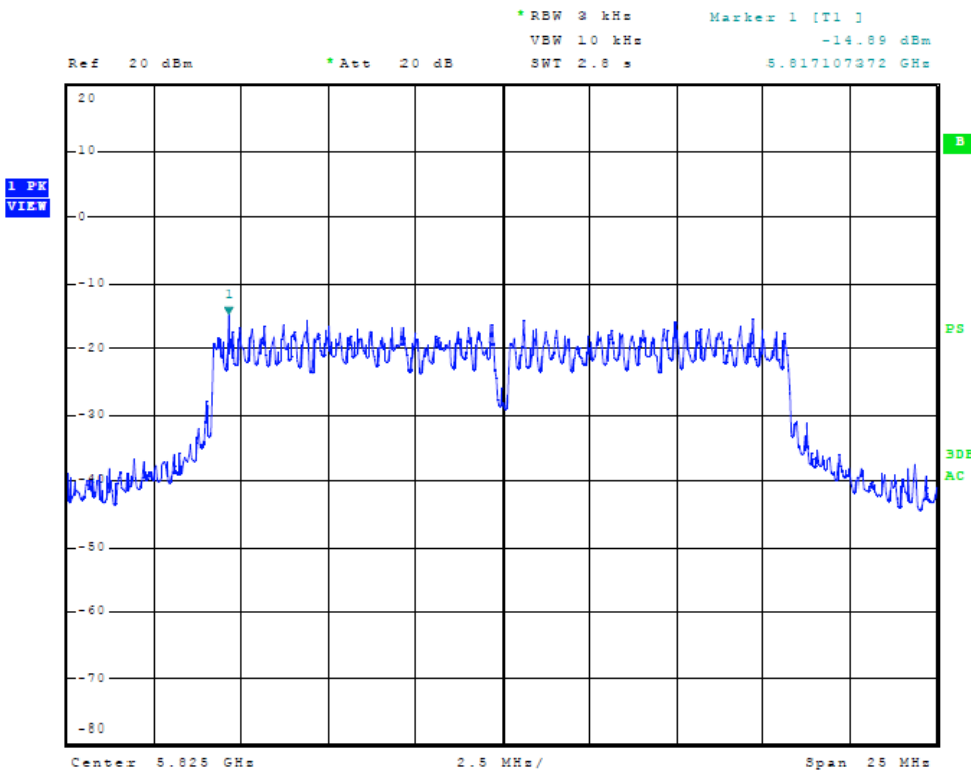

Figure Forty-seven Plot of Power Spectral Density (chain 1, 20 MHz Mode, 5825 MHz)

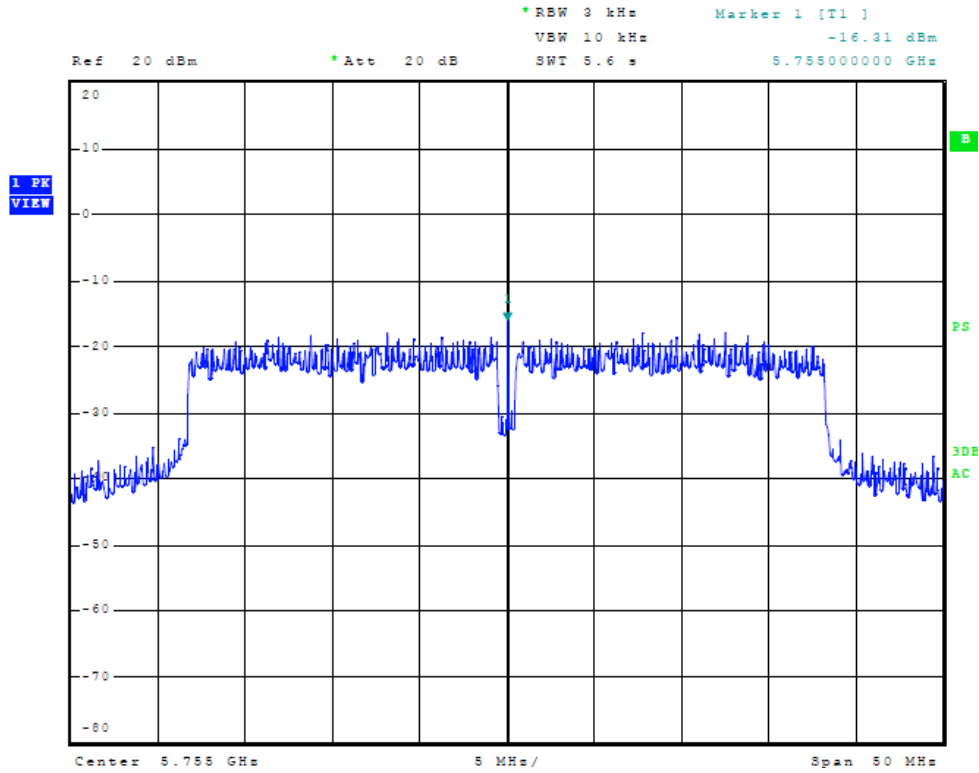

Figure Forty-eight Plot of Power Spectral Density (chain 1, 40 MHz Mode, 5755 MHz)

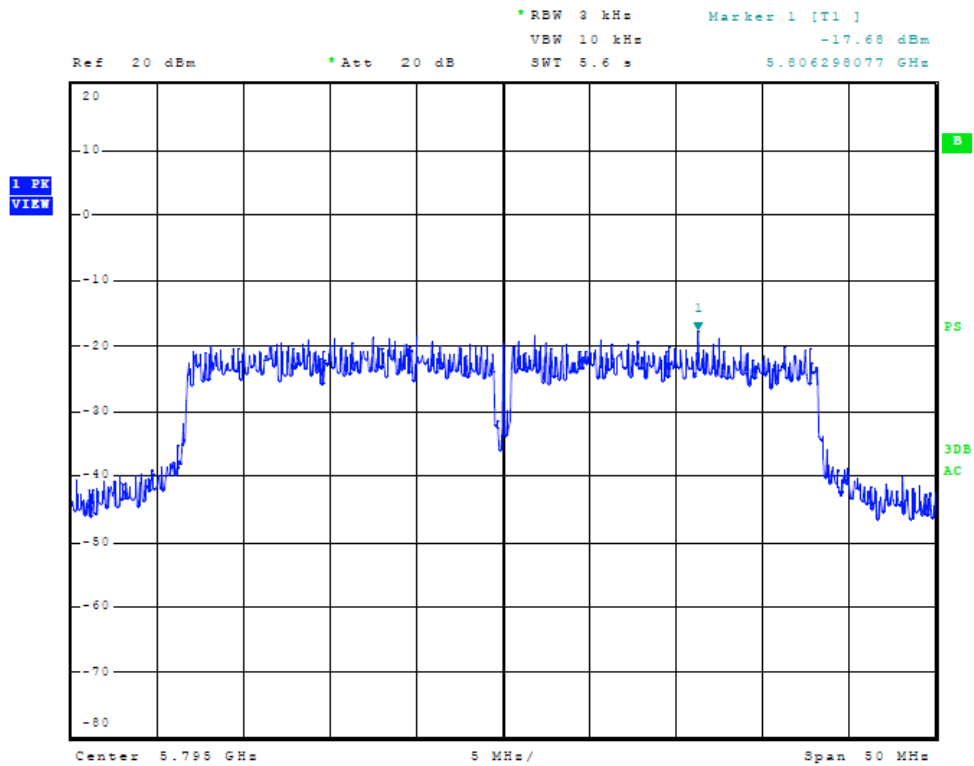

Figure Forty-nine Plot of Power Spectral Density (chain 1, 40 MHz Mode, 5795 MHz)

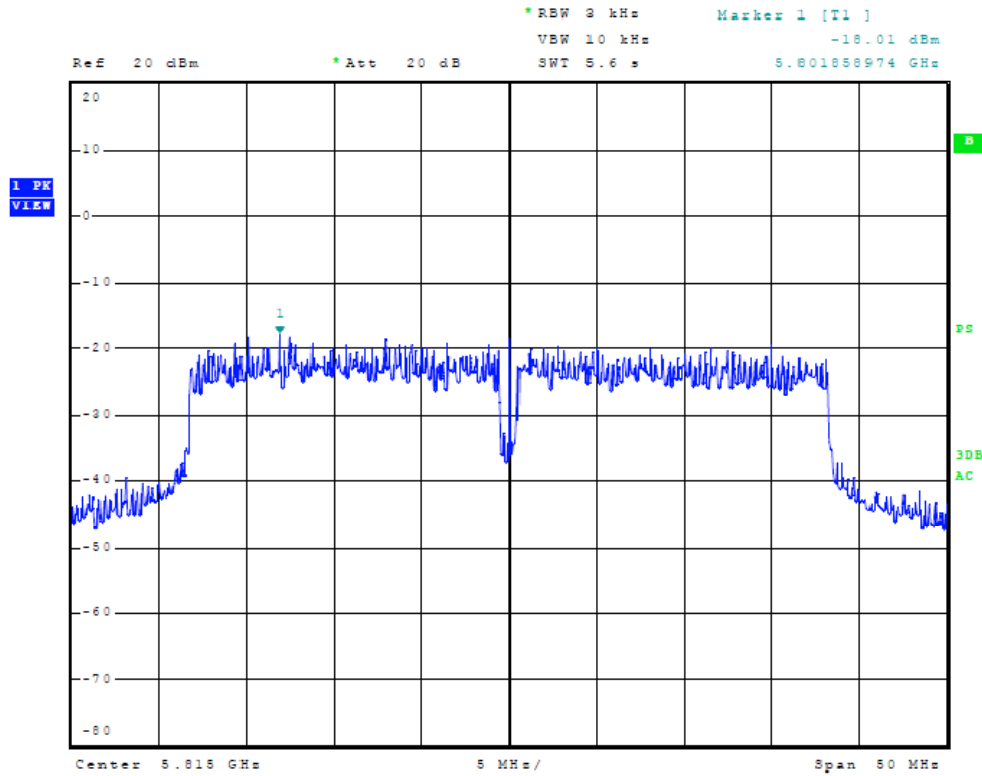

Figure Fifty Plot of Power Spectral Density (chain 1, 40 MHz Mode, 5815 MHz)

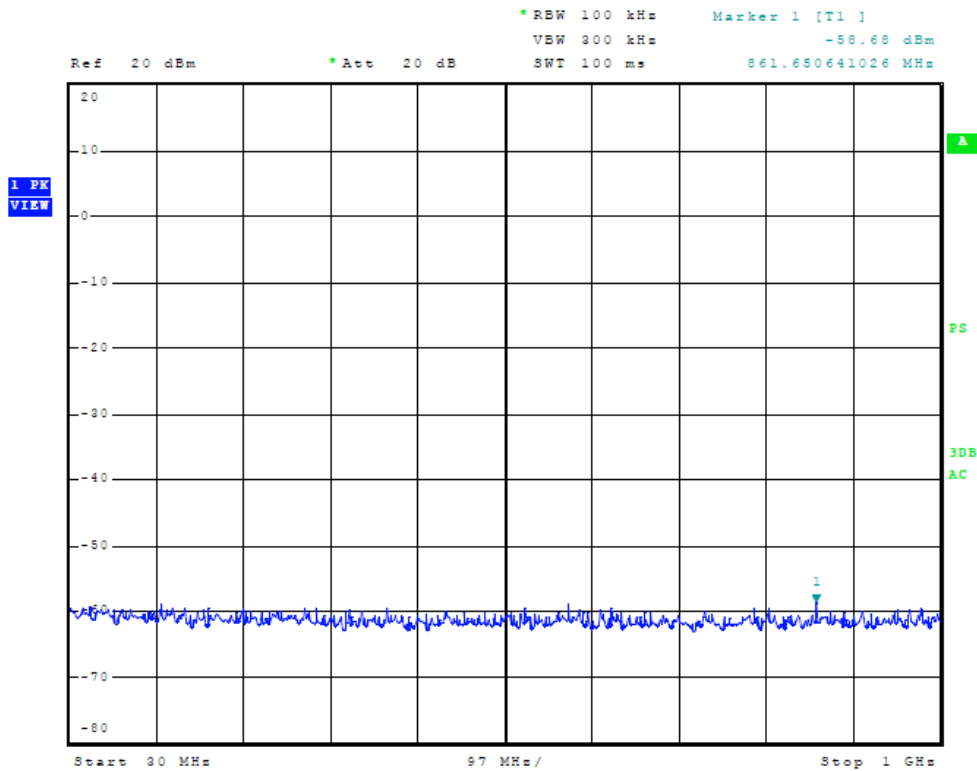

Figure Fifty-one Plot of Antenna port conducted emissions

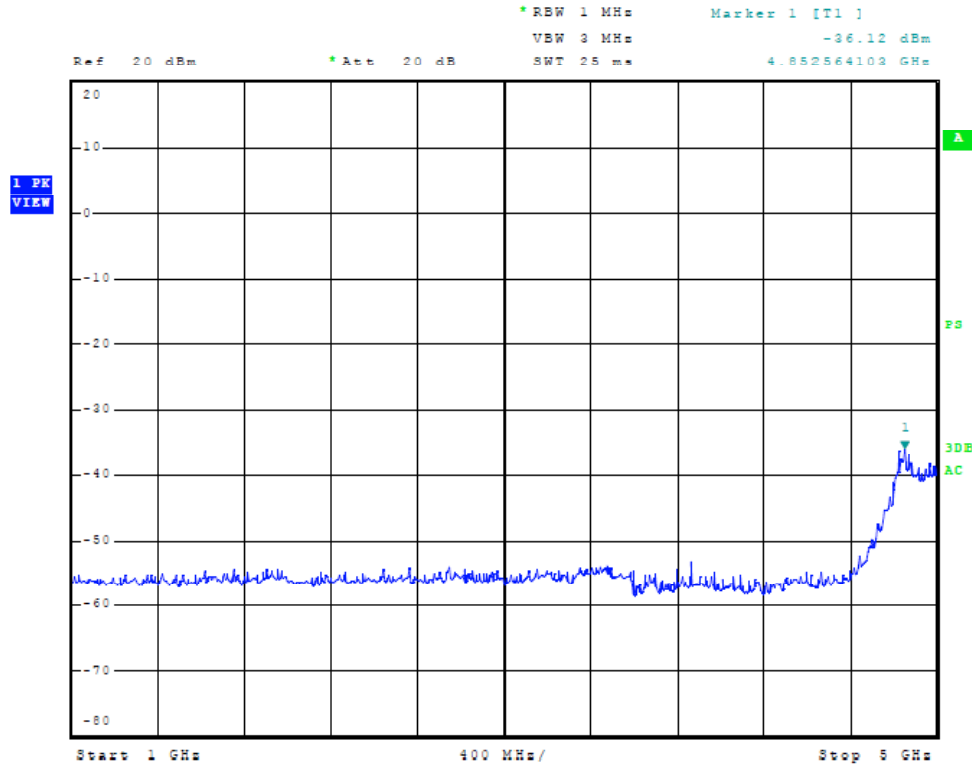

Figure Fifty-two Plot of Antenna port conducted emissions

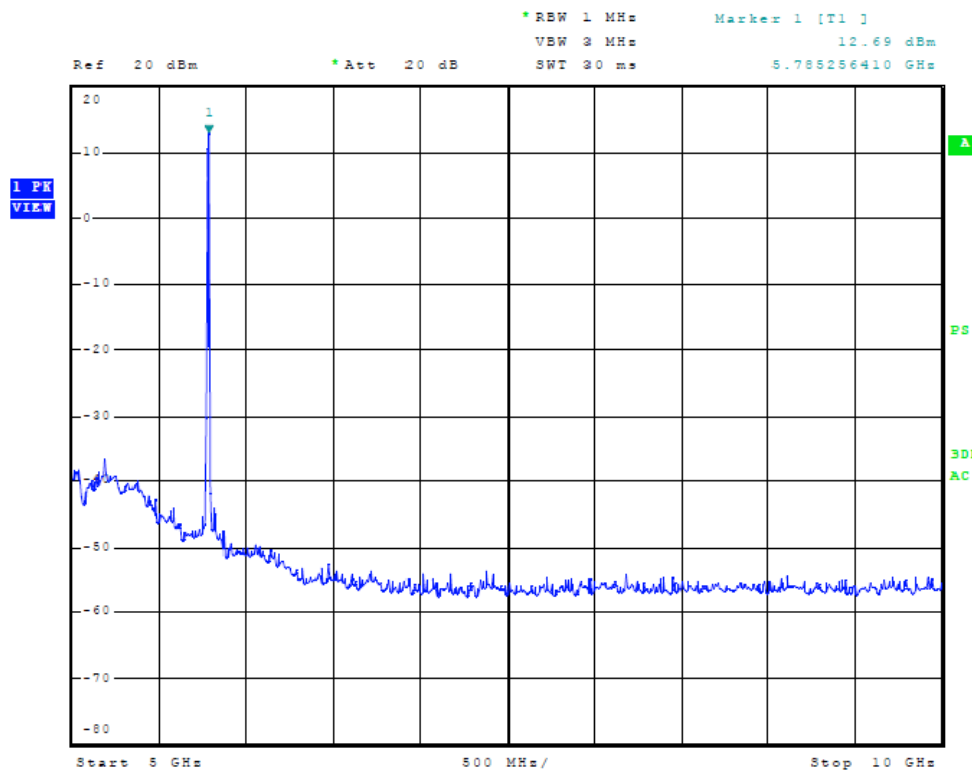

Figure Fifty-three Plot of Antenna port conducted emissions

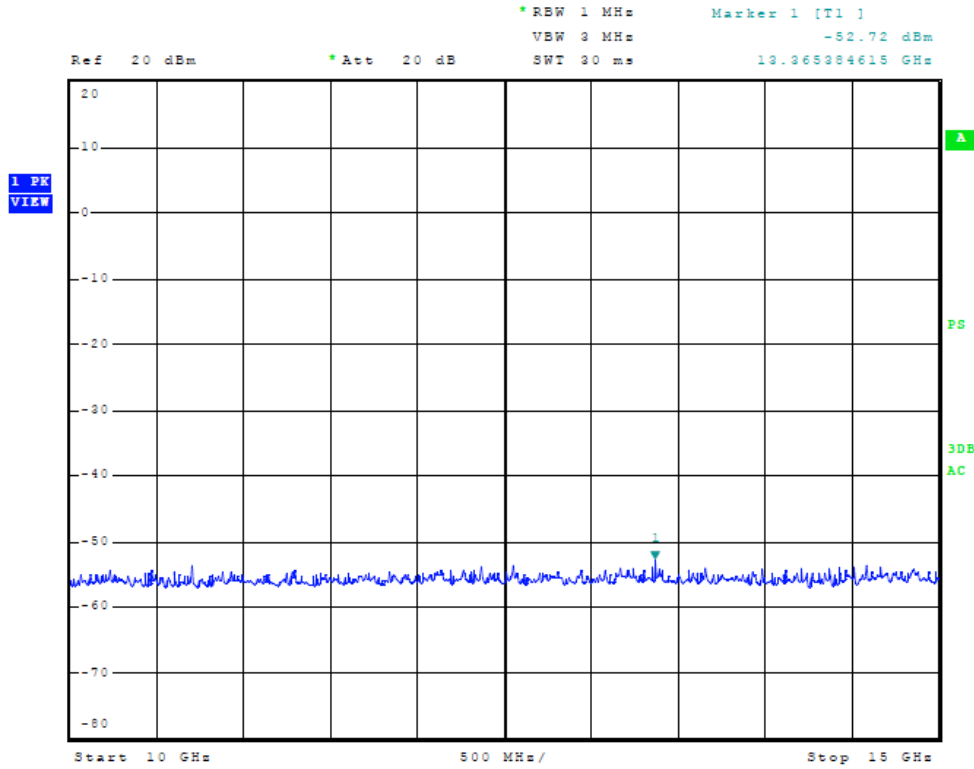

Figure Fifty-four Plot of Antenna port conducted emissions

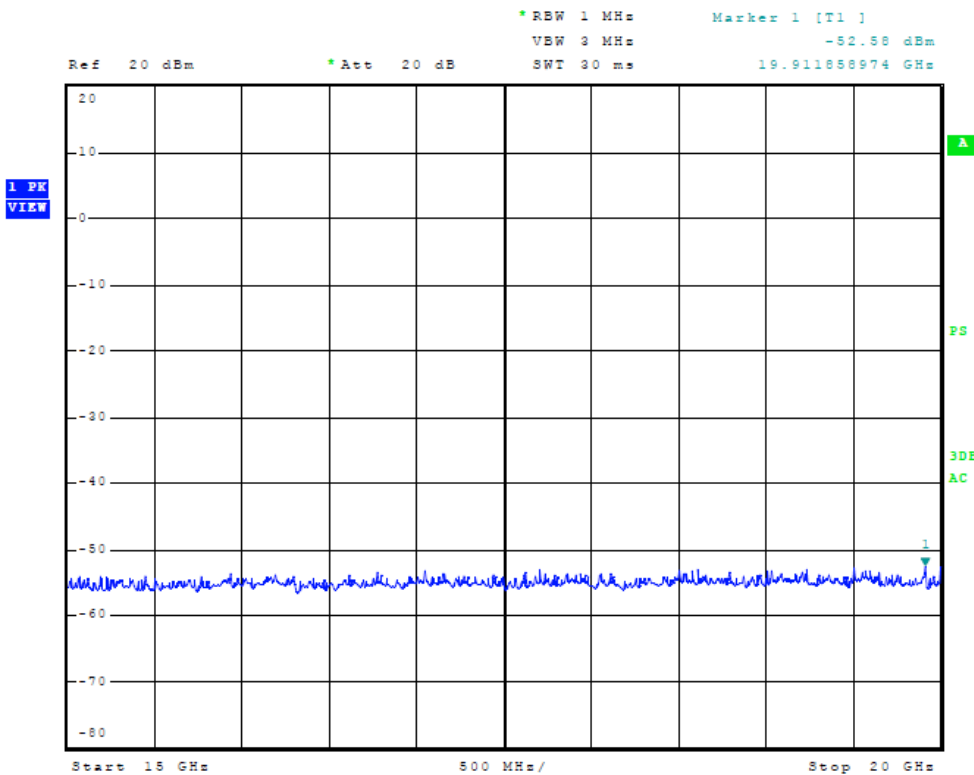

Figure Fifty-five Plot of Antenna port conducted emissions

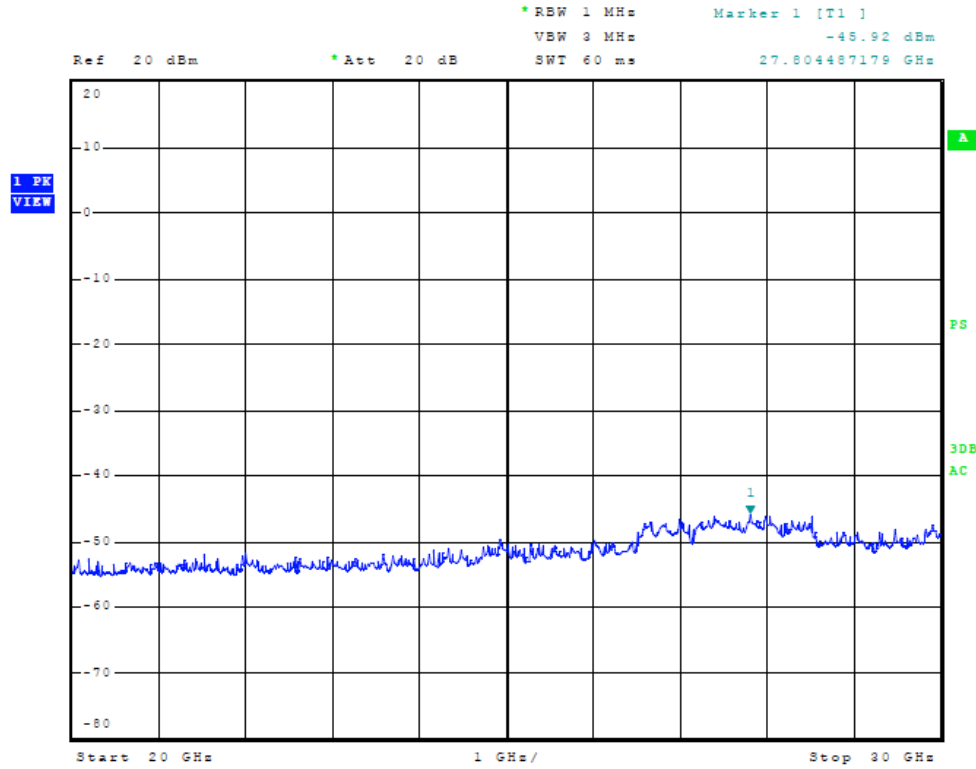

Figure Fifty-six Plot of Antenna port conducted emissions

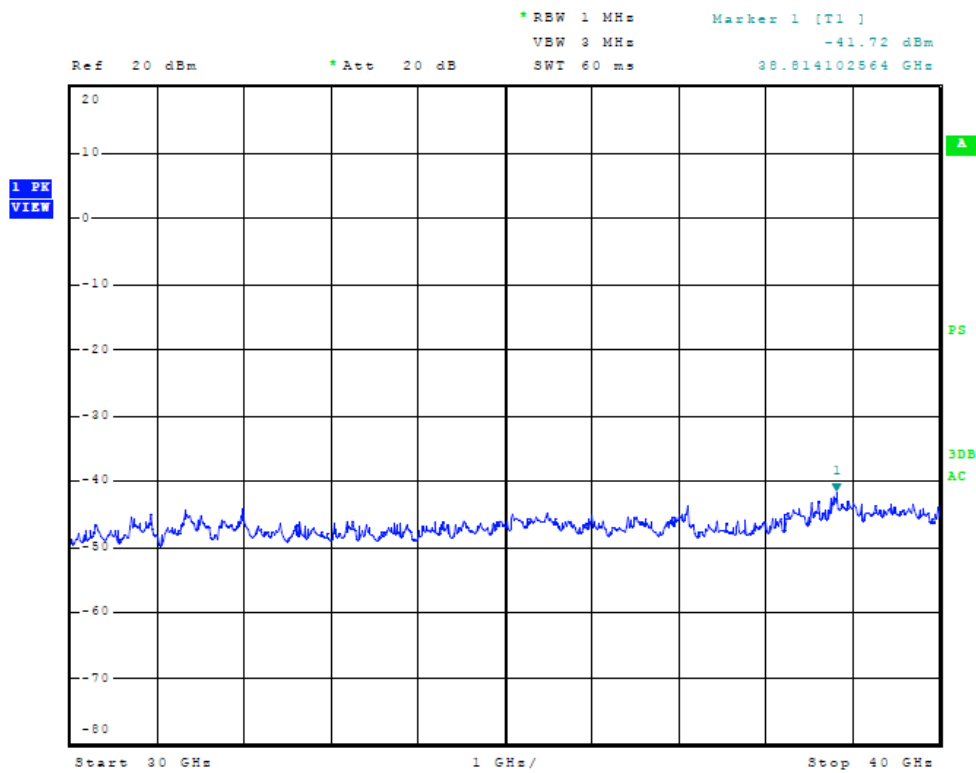

Figure Fifty-seven Plot of Antenna port conducted emissions

Transmitter Emissions Data

Transmitter Antenna port Conducted Emissions Data (per Chain)

Frequency MHz	Antenna Conducted Output Power dBm	Occupied Bandwidth MHz	Power Spectral Density dBm
5MHz Mode chain 1			
5740	19.52	4.26	-7.91
5785	19.41	4.21	-8.44
5830	19.02	4.21	-11.12
5MHz Mode chain 2			
5740	19.51	4.29	-9.17
5785	19.39	4.28	-8.43
5830	19.00	4.38	-9.64
10MHz Mode chain 1			
5740	19.06	8.51	-12.57
5785	19.67	8.44	-15.56
5830	19.40	8.53	-12.91
10MHz Mode chain 2			
5740	19.01	8.58	-12.96
5785	19.65	8.56	-16.34
5830	19.38	8.59	-14.21
20MHz Mode chain 1			
5745	18.57	16.95	-12.47
5785	19.06	16.75	-12.77
5825	18.69	16.75	-16.47
20MHz Mode chain 2			
5745	18.55	17.39	-14.59
5785	19.04	16.71	-15.22
5825	18.64	17.19	-14.89
40MHz Mode chain 1			
5755	17.19	36.94	-16.97
5795	17.49	36.94	-16.91
5815	17.22	37.18	-11.88
40MHz Mode chain 2			
5755	17.14	37.82	-16.31
5795	17.43	37.02	-17.68
5815	17.19	37.26	-18.01

Transmitter Antenna port Conducted Emissions Data (Total)

Channel Mode	Total Output Power (mW / Watts)	Total Power Spectral Density (dBm)
5 MHz	185 / 0.2	-4.69
10 MHz	180 / 0.2	-9.59
20 MHz	160 / 0.2	-10.46
40 MHz	112 / 0.1	-7.50



Transmitter Antenna port Conducted Emissions Data (5 MHz Channel) (worst-case chain)

Channel MHz	Spurious Freq (MHz)	Measured Level (dBm)	Level Below Carrier (dB)
5740.0	11480.0	-57.81	-77.3
	17220.0	-58.16	-77.7
	22960.0	-58.08	-77.6
	28700.0	-56.01	-75.5
	34440.0	-54.60	-74.1
5785.0	11570.0	-58.41	-77.8
	17355.0	-58.11	-77.5
	23140.0	-58.05	-77.5
	28925.0	-56.21	-75.6
	34710.0	-54.53	-73.9
5830.0	11660.0	-58.16	-77.3
	17490.0	-58.49	-77.6
	23320.0	-58.03	-77.1
	29150.0	-56.72	-75.8
	34980.0	-54.09	-73.2

Transmitter Antenna port Conducted Emissions Data (10 MHz Channel) (worst-case chain)

Channel MHz	Spurious Freq (MHz)	Measured Level (dBm)	Level Below Carrier (dB)
5740.0	11480.0	-57.52	-76.6
	17220.0	-58.41	-77.5
	22960.0	-57.52	-76.6
	28700.0	-56.18	-75.2
	34440.0	-54.99	-74.1
5785.0	11570.0	-57.76	-77.4
	17355.0	-58.01	-77.7
	23140.0	-58.49	-78.2
	28925.0	-56.44	-76.1
	34710.0	-54.18	-73.9
5830.0	11660.0	-57.91	-77.3
	17490.0	-57.98	-77.4
	23320.0	-56.87	-76.3
	29150.0	-56.63	-76.0
	34980.0	-54.72	-74.1



Transmitter Antenna port Conducted Emissions Data (20 MHz Channel) (worst-case chain)

Channel MHz	Spurious Freq (MHz)	Measured Level (dBm)	Level Below Carrier (dB)
5745.0	11490.0	-58.16	-76.7
	17235.0	-57.98	-76.6
	22980.0	-58.19	-76.8
	28725.0	-57.00	-75.6
	34470.0	-54.67	-73.2
5785.0	11570.0	-58.52	-77.6
	17355.0	-58.08	-77.1
	23140.0	-57.32	-76.4
	28925.0	-56.36	-75.4
	34710.0	-53.97	-73.0
5825.0	11650.0	-58.31	-77.0
	17475.0	-58.34	-77.0
	23300.0	-56.91	-75.6
	29125.0	-57.09	-75.8
	34950.0	-45.46	-63.2

Transmitter Antenna port Conducted Emissions Data (40 MHz Channel) (worst-case chain)

Channel MHz	Spurious Freq (MHz)	Measured Level (dBm)	Level Below Carrier (dB)
5755.0	11510.0	-57.69	-74.9
	17265.0	-58.01	-75.2
	23020.0	-57.94	-75.1
	28775.0	-56.27	-73.5
	34530.0	-54.97	-72.2
5795.0	11590.0	-58.23	-75.7
	17385.0	-58.60	-76.1
	23180.0	-58.05	-75.5
	28975.0	-56.42	-73.9
	34770.0	-54.77	-72.3
5815.0	11630.0	-58.41	-75.6
	17445.0	-58.45	-75.7
	23260.0	-57.76	-75.0
	29075.0	-56.15	-73.4
	34890.0	-54.67	-71.9

Transmitter Radiated Emission (9dBi Omni, Worst-case)

Frequency in MHz	Horizontal Peak (dBµV)	Horizontal Average (dBµV)	Vertical Peak (dBµV)	Vertical Average (dBµV)	Limit @ 3m (dBµV/m)
5740.0	104.6	93.6	127.8	116.4	--
11480.0	54.1	40.1	55.3	40.6	54.0
17220.0	56.3	42.9	55.2	42.8	54.0
22960.0	39.5	26.5	39.3	26.3	54.0
28700.0	37.5	25.1	38.1	25.1	54.0
5785.0	104.1	92.5	126.9	114.3	--
11570.0	49.4	36.7	50.4	37.2	54.0
17355.0	55.8	42.8	55.4	43.0	54.0
23140.0	37.9	25.4	38.3	25.4	54.0
28925.0	37.8	25.4	38.3	25.4	54.0
5830.0	102.9	91.6	125.5	113.6	--
11660.0	49.4	36.8	48.7	36.3	54.0
17490.0	57.6	43.6	56.5	43.6	54.0
23320.0	35.3	22.3	34.7	22.3	54.0
29150.0	37.2	24.4	37.4	24.5	54.0
5725.0	60.5	37.7	73.3	49.0	54.0
5850.0	61.5	38.4	74.6	51.0	54.0

Other emissions present had amplitudes at least 20 dB below the limit.

Quasi-Peak amplitude emissions are recorded above for frequency range of 30-1000 MHz. Average amplitude emissions are recorded above for frequency range above 1000 MHz.

Transmitter Radiated Emission (24dBi Panel, Worst-case)

Frequency in MHz	Horizontal Peak (dBµV)	Horizontal Average (dBµV)	Vertical Peak (dBµV)	Vertical Average (dBµV)	Limit @ 3m (dBµV/m)
5740.0	109.7	99.4	137.8	125.9	--
11480.0	49.9	35.8	52.2	39.4	54.0
17220.0	54.6	42.5	54.9	42.5	54.0
22960.0	38.2	26.0	38.8	26.3	54.0
28700.0	37.8	24.9	41.3	27.6	54.0
5785.0	108.6	99.7	137.8	125.5	--
11570.0	48.6	36.1	48.6	36.4	54.0
17355.0	55.0	42.3	54.9	42.4	54.0
23140.0	37.3	25.4	37.9	25.6	54.0
28925.0	27.9	25.2	38.3	26.2	54.0
5830.0	108.8	97.9	137.5	126.0	--
11660.0	48.6	35.9	50.2	36.5	54.0
17490.0	56.4	43.3	56.5	43.3	54.0
23320.0	35.3	22.3	35.3	22.6	54.0
29150.0	36.7	24.4	40.1	25.9	54.0

Other emissions present had amplitudes at least 20 dB below the limit.

Quasi-Peak amplitude emissions are recorded above for frequency range of 30-1000 MHz. Average amplitude emissions are recorded above for frequency range above 1000 MHz.

Transmitter Radiated Emission (32dBi Dish, Worst-case)

Frequency in MHz	Horizontal Peak (dBμV)	Horizontal Average (dBμV)	Vertical Peak (dBμV)	Vertical Average (dBμV)	Limit @ 3m (dBμV/m)
5740.0	138.0	126.0	140.0	129.8	--
11480.0	55.3	41.4	52.1	39.7	54.0
17220.0	54.7	42.5	54.9	42.5	54.0
22960.0	38.8	26.4	38.5	26.3	54.0
28700.0	37.5	25.1	40.1	26.5	54.0
5785.0	136.6	125.0	138.1	129.4	--
11570.0	48.5	36.2	53.6	40.6	54.0
17355.0	55.1	42.3	54.9	42.2	54.0
23140.0	38.6	25.4	38.0	25.5	54.0
28925.0	38.0	25.2	39.3	26.7	54.0
5830.0	136.6	124.4	138.9	129.6	--
11660.0	49.2	35.8	49.0	36.3	54.0
17490.0	56.0	43.6	55.8	43.4	54.0
23320.0	35.2	22.7	35.5	23.1	54.0
29150.0	37.1	24.8	36.9	28.5	54.0

Other emissions present had amplitudes at least 20 dB below the limit.

Quasi-Peak amplitude emissions are recorded above for frequency range of 30-1000 MHz.

Average amplitude emissions are recorded above for frequency range above 1000 MHz.

Summary of Results for Transmitter Radiated Emissions of Intentional Radiator

The EUT demonstrated compliance with the conducted and radiated emissions requirements of CFR47 Part 15.247. Conducted antenna port power of 19.67 dBm, 0.1 Watts was measured on single chain. The EUT demonstrated a minimum radiated emission margin of -10.4 dB below the harmonic emission requirements. There are no other significantly measurable emissions in the restricted bands other than those recorded in this report. Other emissions were present with amplitudes at least 20 dB below the requirements. The specifications of 15.247 were met; there are no deviations or exceptions to the requirements.

Statement of Modifications and Deviations

No modifications to the EUT were required for the unit to demonstrate compliance with the CFR47 Part 15C emissions standards. There were no deviations to the specifications.



NVLAP Lab Code 200087-0

Annex

- Annex A Measurement Uncertainty Calculations
- Annex B Rogers Labs Test Equipment List
- Annex C Rogers Qualifications
- Annex D FCC Site Registration Letter
- Annex E Industry Canada Site Registration Letter

Annex A Measurement Uncertainty Calculations

Radiated Emissions Measurement Uncertainty Calculation

Measurement of vertically polarized radiated field strength over the frequency range 30 MHz to 1 GHz on an open area test site at 3m and 10m includes following uncertainty:

Contribution	Probability Distribution	Uncertainty (dB)
Antenna factor calibration	normal (k = 2)	±0.58
Cable loss calibration	normal (k = 2)	±0.2
Receiver specification	rectangular	±1.0
Antenna directivity	rectangular	±0.1
Antenna factor variation with height	rectangular	±2.0
Antenna factor frequency interpolation	rectangular	±0.1
Measurement distance variation	rectangular	±0.2
Site Imperfections	rectangular	±1.5
Combined standard uncertainty $u_c(y)$ is		

$$U_c(y) = \pm \sqrt{\left[\frac{1.0}{2}\right]^2 + \left[\frac{0.2}{2}\right]^2 + \left[\frac{1.0^2 + 0.1^2 + 2.0^2 + 0.1^2 + 0.2^2 + 1.5^2}{3}\right]}$$

$$U_c(y) = \pm 1.6 \text{ dB}$$

It is probable that $u_c(y) / s(q_k) > 3$, where $s(q_k)$ is estimated standard deviation from a sample of n readings unless the repeatability of the EUT is particularly poor, and a coverage factor of $k = 2$ will ensure that the level of confidence will be approximately 95%, therefore:

$$s(q_k) = \sqrt{\frac{1}{(n-1)} \sum_{k=1}^n (q_k - \bar{q})^2}$$

$$U = 2 U_c(y) = 2 \times \pm 1.6 \text{ dB} = \pm 3.2 \text{ dB}$$

Notes:

- 1.1 Uncertainties for the antenna and cable were estimated, based on a normal probability distribution with $k = 2$.
- 1.2 The receiver uncertainty was obtained from the manufacturer's specification for which a rectangular distribution was assumed.
- 1.3 The antenna factor uncertainty does not take account of antenna directivity.
- 1.4 The antenna factor varies with height and since the height was not always the same in use as when the antenna was calibrated an additional uncertainty is added.
- 1.5 The uncertainty in the measurement distance is relatively small but has some effect on the received signal strength. The increase in measurement distance as the antenna height is increased is an inevitable consequence of the test method and is therefore not considered a contribution to uncertainty.
- 1.6 Site imperfections are difficult to quantify but may include the following contributions:
 - Unwanted reflections from adjacent objects.
 - Ground plane imperfections: reflection coefficient, flatness, and edge effects.
 - Losses or reflections from "transparent" cabins for the EUT or site coverings.
 - Earth currents in antenna cable (mainly effect Biconical antennas).

The specified limits for the difference between measured site attenuation and the theoretical value (± 4 dB) were not included in total since the measurement of site attenuation includes uncertainty contributions already allowed for in this budget, such as antenna factor.

Conducted Measurements Uncertainty Calculation

Measurement of conducted emissions over the frequency range 9 kHz to 30 MHz includes following uncertainty:

Contribution	Probability Distribution	Uncertainty (dB)
Receiver specification	rectangular	± 1.5
LISN coupling specification	rectangular	± 1.5
Cable and input attenuator calibration	normal (k=2)	± 0.5
Combined standard uncertainty $u_c(y)$ is		

$$U_c(y) = \pm \sqrt{\left[\frac{0.5}{2}\right]^2 + \frac{1.5^2 + 1.5^2}{3}}$$

$$U_c(y) = \pm 1.2 \text{ dB}$$

As with radiated field strength uncertainty, it is probable that $u_c(y) / s(q_k) > 3$ and a coverage factor of $k = 2$ will suffice, therefore:

$$U = 2 U_c(y) = 2 \times \pm 1.2 \text{ dB} = \pm 2.4 \text{ dB}$$



Annex B Rogers Labs Test Equipment List

The test equipment is maintained in calibration and good operating condition. Use of this calibrated equipment ensures measurements are traceable to national standards.

List of Test Equipment	Calibration Date
Spectrum Analyzer: Rohde & Schwarz ESU40	5/11
Spectrum Analyzer: HP 8562A, HP Adapters: 11518, 11519, and 11520	5/11
Mixers: 11517A, 11970A, 11970K, 11970U, 11970V, 11970W	
Spectrum Analyzer: HP 8591EM	5/11
Antenna: EMCO Biconilog Model: 3143	5/11
Antenna: Sunol Biconilog Model: JB6	10/10
Antenna: EMCO Log Periodic Model: 3147	10/10
Antenna: Antenna Research Biconical Model: BCD 235	10/10
LISN: Compliance Design Model: FCC-LISN-2.Mod.cd, 50 µHy/50 ohm/0.1 µf	10/10
R.F. Preamp CPPA-102	10/10
Attenuator: HP Model: HP11509A	10/10
Attenuator: Mini Circuits Model: CAT-3	10/10
Attenuator: Mini Circuits Model: CAT-3	10/10
Cable: Belden RG-58 (L1)	10/10
Cable: Belden RG-58 (L2)	10/10
Cable: Belden 8268 (L3)	10/10
Cable: Time Microwave: 4M-750HF290-750	10/10
Cable: Time Microwave: 10M-750HF290-750	10/10
Frequency Counter: Leader LDC825	2/11
Oscilloscope Scope: Tektronix 2230	2/11
Wattmeter: Bird 43 with Load Bird 8085	2/11
Power Supplies: Sorensen SRL 20-25, SRL 40-25, DCR 150, DCR 140	2/11
R.F. Generators: HP 606A, HP 8614A, HP 8640B	2/11
R.F. Power Amp 65W Model: 470-A-1010	2/11
R.F. Power Amp 50W M185- 10-501	2/11
R.F. Power Amp A.R. Model: 10W 1010M7	2/11
R.F. Power Amp EIN Model: A301	2/11
LISN: Compliance Eng. Model 240/20	2/11
LISN: Fischer Custom Communications Model: FCC-LISN-50-16-2-08	2/11
Antenna: EMCO Dipole Set 3121C	2/11
Antenna: C.D. B-101	2/11
Antenna: Solar 9229-1 & 9230-1	2/11
Antenna: EMCO 6509	2/11
Audio Oscillator: H.P. 201CD	2/11
Peavey Power Amp Model: IPS 801	2/11
ELGAR Model: 1751	2/11
ELGAR Model: TG 704A-3D	2/11
ESD Test Set 2010i	2/11
Fast Transient Burst Generator Model: EFT/B-101	2/11
Field Intensity Meter: EFM-018	2/11
KEYTEK Ecat Surge Generator	2/11
Shielded Room 5 M x 3 M x 3.0 M	



Annex C Rogers Qualifications

Scot D. Rogers, Engineer

Rogers Labs, Inc.

Mr. Rogers has approximately 17 years experience in the field of electronics. Engineering experience includes six years in the automated controls industry and remaining years working with the design, development and testing of radio communications and electronic equipment.

Positions Held

Systems Engineer: A/C Controls Mfg. Co., Inc. 6 Years

Electrical Engineer: Rogers Consulting Labs, Inc. 5 Years

Electrical Engineer: Rogers Labs, Inc. Current

Educational Background

- 1) Bachelor of Science Degree in Electrical Engineering from Kansas State University.
- 2) Bachelor of Science Degree in Business Administration Kansas State University.
- 3) Several Specialized Training courses and seminars pertaining to Microprocessors and Software programming.

Scot D. Rogers



NVLAP Lab Code 200087-0

Annex D FCC Site Registration Letter

FEDERAL COMMUNICATIONS COMMISSION

**Laboratory Division
7435 Oakland Mills Road
Columbia, MD 21046**

May 18, 2010

Registration Number: 90910

Rogers Labs, Inc.
4405 West 259th Terrace,
Louisburg, KS 66053

Attention: Scot Rogers,

Re: Measurement facility located at Louisburg
~~3 & 10 meter site~~
Date of Renewal: May 18, 2010

Dear Sir or Madam:

Your request for renewal of the registration of the subject measurement facility has been received. The information submitted has been placed in your file and the registration has been renewed. The name of your organization will remain on the list of facilities whose measurement data will be accepted in conjunction with applications for Certification under Parts 15 or 18 of the Commission's Rules. Please note that the file must be updated for any changes made to the facility and the registration must be renewed at least every three years.

Measurement facilities that have indicated that they are available to the public to perform measurement services on a fee basis may be found on the FCC website www.fcc.gov under E-Filing, OET Equipment Authorization Electronic Filing, Test Firms.

Sincerely,

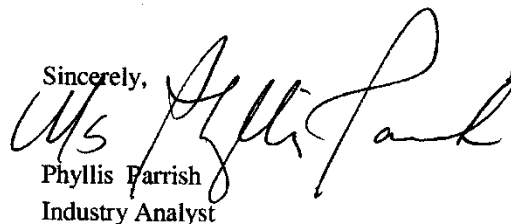

Phyllis Farrish
Industry Analyst

Rogers Labs, Inc.
4405 W. 259th Terrace
Louisburg, KS 66053
Phone/Fax: (913) 837-3214
Revision 1

Mikrotikls SIA
Model: RB711G-5HnD
Test #: 110628
Test to: CFR47 (15.247)
File: Mikrotikls RB711G 5HND 110628 TstRpt

SN: 2F1201DD0A3C
FCC ID#: TV7RB711G-5HND
Date: August 19, 2011
Page 56 of 57



NVLAP Lab Code 200087-0

Annex E Industry Canada Site Registration Letter

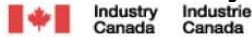

May 26, 2010

OUR FILE: 46405-3041
Submission No: 140719

Rogers Labs Inc.

4405 West 259th Terrace
Louisburg, KY, 66053
USA

Attention: Mr. Scot D. Rogers

Dear Sir/Madame:

The Bureau has received your application for the renewal of a 3/10m OATS. Be advised that the information received was satisfactory to Industry Canada. The following number(s) is now associated to the site(s) for which registration / renewal was sought (**3041A-1**). Please reference the appropriate site number in the body of test reports containing measurements performed on the site. In addition, please keep for your records the following information;

- Your primary code is: **3041**
- The company number associated to the site(s) located at the above address is: **3041A**

Furthermore, to obtain or renew a unique site number, the applicant shall demonstrate that the site has been accredited to ANSI C63.4-2003 or later. A scope of accreditation indicating the accreditation by a recognized accreditation body to ANSI C63.4-2003 or later shall be accepted. Please indicate in a letter the previous assigned site number if applicable and the type of site (example: 3 metre OATS or 3 metre chamber). If the test facility is not accredited to ANSI C63.4-2003 or later, the test facility shall submit test data demonstrating full compliance with the ANSI standard. The Bureau will evaluate the filing to determine if recognition shall be granted.

The frequency for re-validation of the test site and the information that is required to be filed or retained by the testing party shall comply with the requirements established by the accrediting organization. However, in all cases, test site re-validation shall occur on an interval not to exceed two years. There is no fee or form associated with an OATS filing. OATS submissions are encouraged to be submitted electronically to the Bureau using the following URL;

http://strategis.ic.gc.ca/epic/internet/inceb-bhst.nsf/en/h_tt00052e.html.

If you have any questions, you may contact the Bureau by e-mail at certification.bureau@ic.gc.ca Please reference our file and submission number above for all correspondence.

Yours sincerely,

Dalwinder Gill
For: Wireless Laboratory Manager
Certification and Engineering Bureau
3701 Carling Ave., Building 94
P.O. Box 11490, Station "H"
Ottawa, Ontario K2H 8S2
Email: dalwinder.gill@ic.gc.ca
Tel. No. (613) 998-3363
Fax. No. (613) 990-4752

Rogers Labs, Inc.
4405 W. 259th Terrace
Louisburg, KS 66053
Phone/Fax: (913) 837-3214
Revision 1

Mikrotikls SIA
Model: RB711G-5HnD
Test #: 110628
Test to: CFR47 (15.247)
File: Mikrotikls RB711G 5HND 110628 TstRpt

SN: 2F1201DD0A3C
FCC ID#: TV7RB711G-5HND
Date: August 19, 2011
Page 57 of 57