

Submittal Application Report

FOR
GRANT OF CERTIFICATION

FOR

Model: RouterBOARD R2SHPn
2412-2462 MHz
Single Input Single Output
Broadband Digital Transmission System
FCC ID: TV7R2SHPN

FOR

MIKROTIKLS SIA

Pernavas 46
Riga, Latvia LV-1009

Test Report Number: 140320

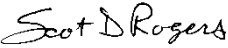
Authorized Signatory: 
Scot D. Rogers

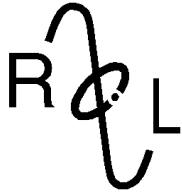

ROGERS LABS, INC.

4405 West 259th Terrace
 Louisburg, KS 66053
 Phone / Fax (913) 837-3214

**Engineering Test Report for
 Grant of Certification Application**

FOR
 CFR 47, PART 15C - Intentional Radiators
 CFR 47 Paragraph 15.247
 License Exempt Intentional Radiator

For

MIKROTIKLS SIA

Pernavas 46
 Riga, Latvia LV-1009

SISO Broadband Digital Transmission System

Model: RouterBOARD R2SHPn
 Frequency Range 2412-2462 MHz
 FCC ID#: TV7R2SHPN

Test Date: March 20, 2013

Certifying Engineer: *Scot D. Rogers*
 Scot D. Rogers
 Rogers Labs, Inc.
 4405 West 259th Terrace
 Louisburg, KS 66053
 Telephone/Facsimile: (913) 837-3214

This report shall not be reproduced except in full, without the written approval of the laboratory.
 This report must not be used by the client to claim product endorsement by NVLAP, NIST, or
 any agency of the U.S. Government.



Table Of Contents

TABLE OF CONTENTS..... 3

REVISIONS..... 4

FORWARD 5

OPINION / INTERPRETATION OF RESULTS 5

EQUIPMENT TESTED..... 5

Equipment Function6

Equipment Configuration.....6

APPLICATION FOR CERTIFICATION..... 7

APPLICABLE STANDARDS & TEST PROCEDURES 8

EQUIPMENT TESTING PROCEDURES 8

AC Line Conducted Emission Test Procedure8

Radiated Emission Test Procedure.....8

 Diagram 1 Test arrangement for Conducted emissions9

 Diagram 2 Test arrangement for radiated emissions of tabletop equipment.....10

 Diagram 3 Test arrangement for radiated emissions tested on Open Area Test Site (OATS).....11

TEST SITE LOCATIONS 11

LIST OF TEST EQUIPMENT 12

UNITS OF MEASUREMENTS 13

ENVIRONMENTAL CONDITIONS..... 13

INTENTIONAL RADIATORS..... 13

Antenna Requirements13

Restricted Bands of Operation.....14

 Table 1 General Radiated Emissions in Restricted Bands Data14

 Table 2 Harmonic Radiated Emissions in Restricted Bands Data (130K-D-1131-150K(WS))15

 Table 3 Harmonic Radiated Emissions in Restricted Bands Data (ODH 24-13).....15

 Table 4 Harmonic Radiated Emissions in Restricted Bands Data (WLO-2450-15).....16

 Table 5 Harmonic Radiated Emissions in Restricted Bands Data (SA 24-90-17-WB)16

 Table 6 Harmonic Radiated Emissions in Restricted Bands Data (WLP-2450-20).....17

 Table 7 Harmonic Radiated Emissions in Restricted Bands Data (DC-24-HD-PFIP)17

Summary of Results for Radiated Emissions in Restricted Bands18

AC Line Conducted Emissions Procedure18

 Figure 1 AC Line Conducted Emissions Line 119

 Figure 2 AC Line Conducted Emissions Line 219

 Table 8 AC Line Conducted Emissions Data (Highest Emissions) Line L120



Table 9 AC Line Conducted Emissions Data (Highest Emissions) Line L220

Summary of Results for AC Line Conducted Emissions20

General Radiated Emissions Procedure21

Table 10 General Radiated Emissions from EUT Data (Highest Emissions)22

Summary of Results for General Radiated Emissions22

Operation in the Band 2400 – 2483.5 MHz23

Table 11 Transmitter Antenna port Conducted Emissions Data (Total Highest)23

Table 12 Transmitter Antenna Conducted Emissions Data23

Figure 3 Plot of Transmitter Emissions (Across Operational Band, b/g/n Mode)24

Figure 4 Plot of Transmitter Emissions (Across Operational Band, n Mode)24

Figure 5 Plot of Low Band Edge (b/g/n Mode)25

Figure 6 Plot of Low Band Edge (n Mode)25

Figure 7 Plot of High Band Edge (b/g/n Mode)26

Figure 8 Plot of High Band Edge (n Mode).....26

Transmitter Emissions Data.....27

Table 13 Transmitter Radiated Emission (130K-D-1131-150K(WS))27

Table 14 Transmitter Radiated Emission (ODH 24-13)28

Table 15 Transmitter Radiated Emission (WLO-2450-15)29

Table 16 Transmitter Radiated Emission (SA 24-90-17-WB).....30

Table 17 Transmitter Radiated Emission (WLP-2450-20)31

Table 18 Transmitter Radiated Emission (DC-24-HD-PFIP).....32

Summary of Results for Transmitter Radiated Emissions of Intentional Radiator33

STATEMENT OF MODIFICATIONS AND DEVIATIONS 33

ANNEX..... 34

Annex A Measurement Uncertainty Calculations35

Annex B Rogers Labs Test Equipment List.....36

Annex C Rogers Qualifications37

Annex D FCC Site Registration Letter.....38

Annex E Industry Canada Site Registration Letter39

Revisions

Revision 1, Issued April 1, 2014



Forward

The following information is submitted for consideration in obtaining Grant of Certification for License Exempt Digital Transmission System Intentional Radiator operating under CFR 47 Paragraph 15.247 as modular equipment.

Name of Applicant: Mikrotiks SIA
 Pernavas 46
 Riga, Latvia LV-1009

Model: RouterBOARD R2SHPn FCC ID: TV7R2SHPN FRN: 0014 43 1100
 Frequency Range: 2412-2462 MHz (802.11a/b/g mode operation), 2422-2452 MHz
 (802.11n 40 MHz channel operation)

Total Operating Power: 1.0 watt

Opinion / Interpretation of Results

| Tests Performed | Margin (dB) | Results |
|---|-------------|----------|
| Emissions as per CFR 47 paragraphs 2 and 15.205 | -0.1 | Complies |
| Emissions as per CFR 47 paragraphs 2 and 15.207 | -9.7 | Complies |
| Emissions as per CFR 47 paragraphs 2 and 15.209 | -4.0 | Complies |
| Harmonic Emissions per CFR 47 15.247 | -0.1 | Complies |
| Peak Power Spectral Density per CFR 47 15.247 | -7.2 | Complies |

Equipment Tested

| <u>Equipment</u> | <u>Model</u> | <u>SN</u> | <u>FCC I.D.</u> |
|-------------------------|--------------------|------------------------|-----------------|
| EUT | RouterBOARD R2SHPn | 3796FFFC1C29-221 | TV7R2SHPN |
| Support interface Board | Router-Board 11 | 5580009760215 | N/A |
| Computer | HP6300PMT | CZC2326DZ2 | N/A |
| Monitor | Dell E2011Hc | CN-02H2VM-64180-1B1-30 | N/A |

| <u>Antenna/Type</u> | <u>Model</u> | <u>Gain</u> |
|---------------------|----------------------|-------------|
| Omni Directional | 130K-D-1131-150K(WS) | 2 dBi |
| Omni Directional | WLO-2450-15 | 15 dBi |
| Omni Directional HP | ODH 24-13 | 13 dBi |
| Panel | WLP-2450-20 | 20 dBi |
| Sector | SA 24-90-17-WB | 17 dBi |
| Dish | DC 24-HD-PFIP | 24 dBi |

Rogers Labs, Inc.
 4405 W. 259th Terrace
 Louisburg, KS 66053
 Phone/Fax: (913) 837-3214
 Revision 1

Mikrotiks SIA
 Model: RouterBOARD R2SHPn
 Test #: 140320
 Test to: CFR47 (15.247)
 File: Mikrotiks R2SHPn TstRpt 140320

SN: 3796FFFC1C29/221
 FCC ID#: TV7R2SHPN
 Date: April 1, 2014
 Page 5 of 39

Equipment Function

The EUT is a 2412-2462 MHz 2x2 SISO Digital Transmission System used to transmit data in applications offering broadband wireless connectivity. The design provides MMCX antenna connection port for use with authorized antenna systems. The equipment is marketed for placement inside a computer enclosure providing a wireless link for exchanging data information from one point to another. For testing purposes, the RouterBOARD R2SHPn transceiver was inserted into the PCI interface slot of the computer motherboard. This configuration offered operational control of the EUT. No other interfacing options are provided. For testing purposes, the RouterBOARD R2SHPn received power from the supporting interface system and computer and was configured to transmit in available data modes. The antenna system complies with requirements for unique antenna connection if installed by professional installer.

Equipment Configuration

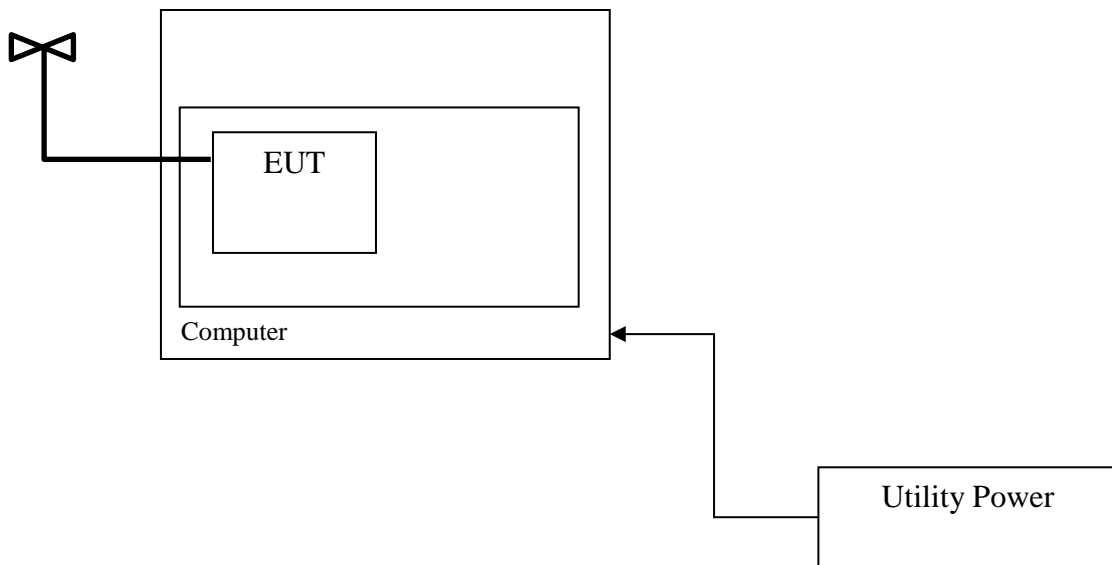

Application for Certification

- (1) Manufacturer: Mikrotikls SIA
Pernavas 46
Riga, Latvia LV-1009
- (2) Identification: Model: RouterBOARD R2SHPn
FCC I.D.: TV7R2SHPN
- (3) Instruction Book:
Refer to Exhibit for Instruction Manual.
- (4) Description of Circuit Functions:
Refer to Exhibit of Operational Description.
- (5) Block Diagram with Frequencies:
Refer to Exhibit of Operational Description.
- (6) Report of Measurements:
Report of measurements follows in this Report.
- (7) Photographs: Construction, Component Placement, etc.:
Refer to Exhibit for photographs of equipment.
- (8) List of Peripheral Equipment Necessary for operation. The equipment operates from power received from the supporting computer motherboard over the PCI interface. The design requires insertion into compliant interface on supporting motherboard for operation. The EUT is produced with MMCX antenna port interface for use with authorized antenna systems. During testing, the EUT was installed inside the manufacturer provided CPU and connected to external antennas thought 6" coaxial cable.
- (9) Transition Provisions of CFR47 15.37 are not requested
- (10) Not Applicable. The unit is not a scanning receiver.
- (11) Not Applicable. The EUT does not operate in the 59 – 64 GHz frequency band.
- (12) The equipment is not software defined and this section is not applicable.

Applicable Standards & Test Procedures

In accordance with the Federal Communications Code of Federal Regulations, dated October 1, 2012, Part 2, Subpart J, Paragraphs 2.907, 2.911, 2.913, 2.925, 2.926, 2.1031 through 2.1057, and applicable parts of paragraph 15, Part 15C Paragraph 15.212 and 15.247 the following information is submitted. Test procedures used are the established Methods of Measurement of Radio-Noise Emissions as described in ANSI C63.4-2009, ANSI C63.10-2009, KDB 996369 D01 v01r04, KDB 558074 D01 v03r1, and KDB 913591. Testing for the AC line-conducted and radiated emissions were performed as defined in section 6 of ANSI C63.10-2009.

Equipment Testing Procedures

AC Line Conducted Emission Test Procedure

Testing for the AC line-conducted emissions was performed as defined in ANSI C63.10-2009. The test setup, including the EUT, was arranged in the test configurations as presented during testing. The test configuration was placed on a 1 x 1.5-meter wooden bench, 0.8 meters high located in a screen room. The power lines of the system were isolated from the power source using a standard LISN with a 50- μ Hy choke. EMI was coupled to the spectrum analyzer through a 0.1 μ F capacitor internal to the LISN. The LISN was positioned on the floor beneath the wooden bench supporting the EUT. The power lines and cables were draped over the back edge of the table. Refer to diagram 1 showing typical test arrangement and photographs in exhibits for EUT placement used during testing.

Radiated Emission Test Procedure

The EUT was placed on a rotating 1 x 1.5-meter wooden platform, 0.8 meters above the ground plane at a distance of 3 meters from the FSM antenna. Radiated emissions testing was performed as required in CFR47 15, RSS-210 and specified in sections 6 and 7 of ANSI C63.10-2009. EMI energy was maximized by equipment placement, raising and lowering the FSM antenna, changing the antenna polarization, and by rotating the turntable. Each emission was maximized before data was taken using a spectrum analyzer. The frequency spectrum from 9 kHz to 25,000 MHz was searched for during preliminary investigation. Refer to diagrams 2 and 3 showing typical test arrangement and photographs in the test setup exhibits for specific EUT placement during testing.

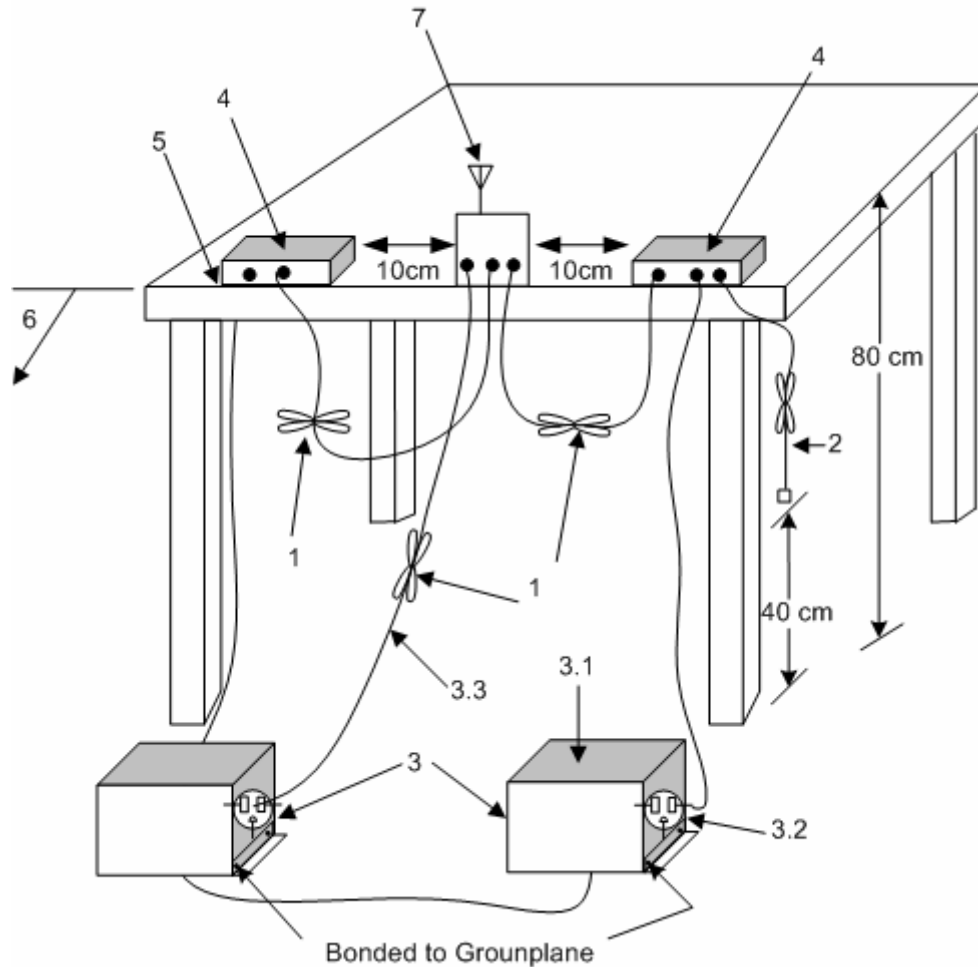

1. Interconnecting cables that hang closer than 40 cm to the ground plane shall be folded back and forth in the center forming a bundle 30 cm to 40 cm long see (see 6.2.3.1).
2. I/O cables that are not connected to an accessory shall be bundled in the center. The end of the cable may be terminated, if required, using the correct terminating impedance. The overall length shall not exceed 1 m (see 6.2.2).
3. EUT connected to one LISN. Unused LISN measuring port connectors shall be terminated in 50 Ω loads. LISN can be placed on top of, or immediately beneath, reference ground plane (see 6.2.2 and 6.2.3).
 - 3.1 All other equipment powered from additional LISN(s).
 - 3.2 Multiple-outlet strip can be used for multiple power cords of non-EUT equipment.
 - 3.3 LISN at least 80 cm from nearest part of EUT chassis.
4. Non-EUT components of EUT system being tested.
5. Rear of EUT, including peripherals, shall all be aligned and flush with rear of tabletop (see 6.2.3.1).
6. Edge of tabletop shall be 40 cm removed from a vertical conducting plane that is bonded to the ground plane (see 6.2.2 for options).
7. Antenna may be integral or detachable. If detachable, the antenna shall be attached for this test.

Diagram 1 Test arrangement for Conducted emissions

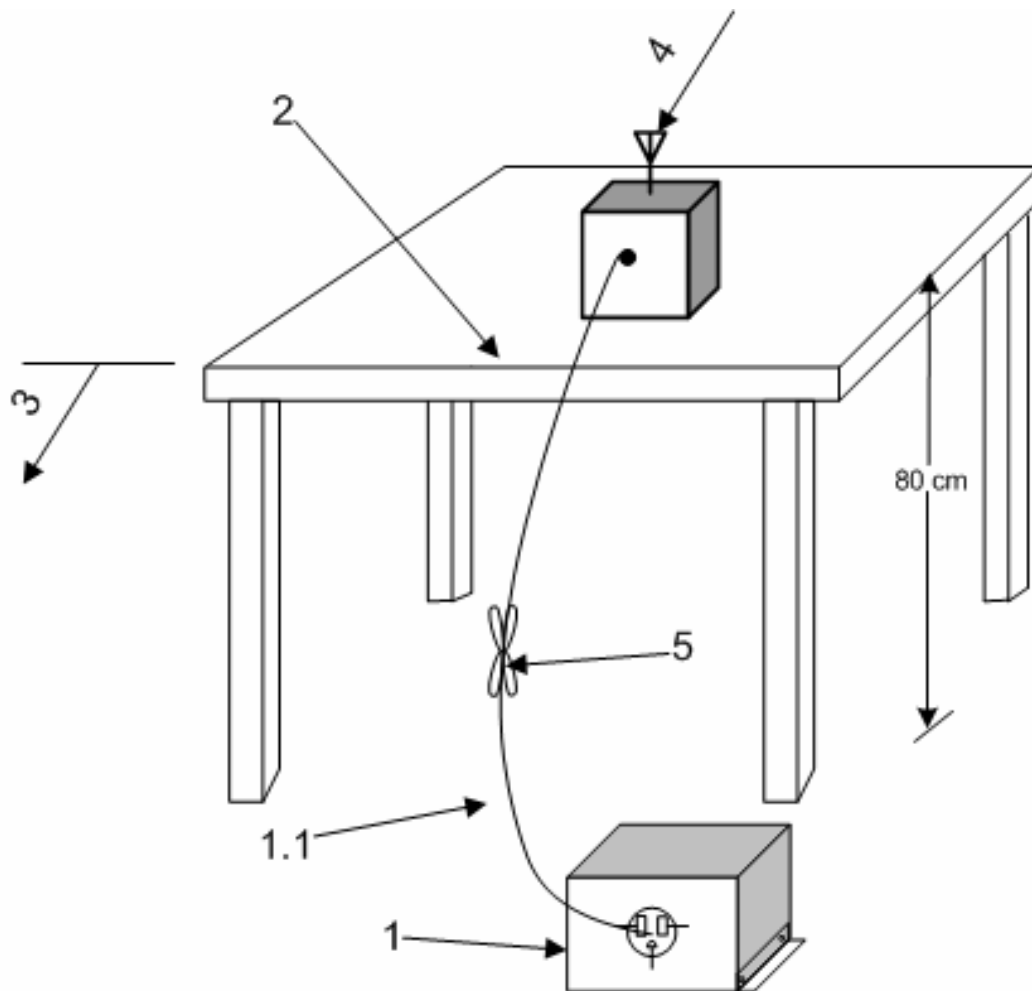

1. A LISN is optional for radiated measurements between 30 MHz to 1000 MHz, but not allowed for measurements below 30 MHz and above 1000 MHz. (See 6.4.3, 6.5.1, and 6.6.3.). If used, connect EUT to one LISN. Unused LISN measuring port connectors shall be terminated in 50Ω. LISN can be placed on top of, or immediately beneath, reference ground plane (see 6.2.2 and 6.2.3.1).
 - 1.1 LISN spaced at least 80 cm from nearest part of EUT chassis.
2. The EUT shall be placed in the center of the table to the extent possible. (See 6.2.3.1 and 6.3.4).
3. A vertical conducting plane, if used for conducted tests per 6.2.2, shall be removed for radiated emission tests.
4. Antenna may be integral or detachable, depending on the EUT.
5. Interconnecting cables that hang closer than 40 cm to the ground plane shall be folded back and forth in the center forming a bundle 30 cm to 40 cm long.

Diagram 2 Test arrangement for radiated emissions of tabletop equipment

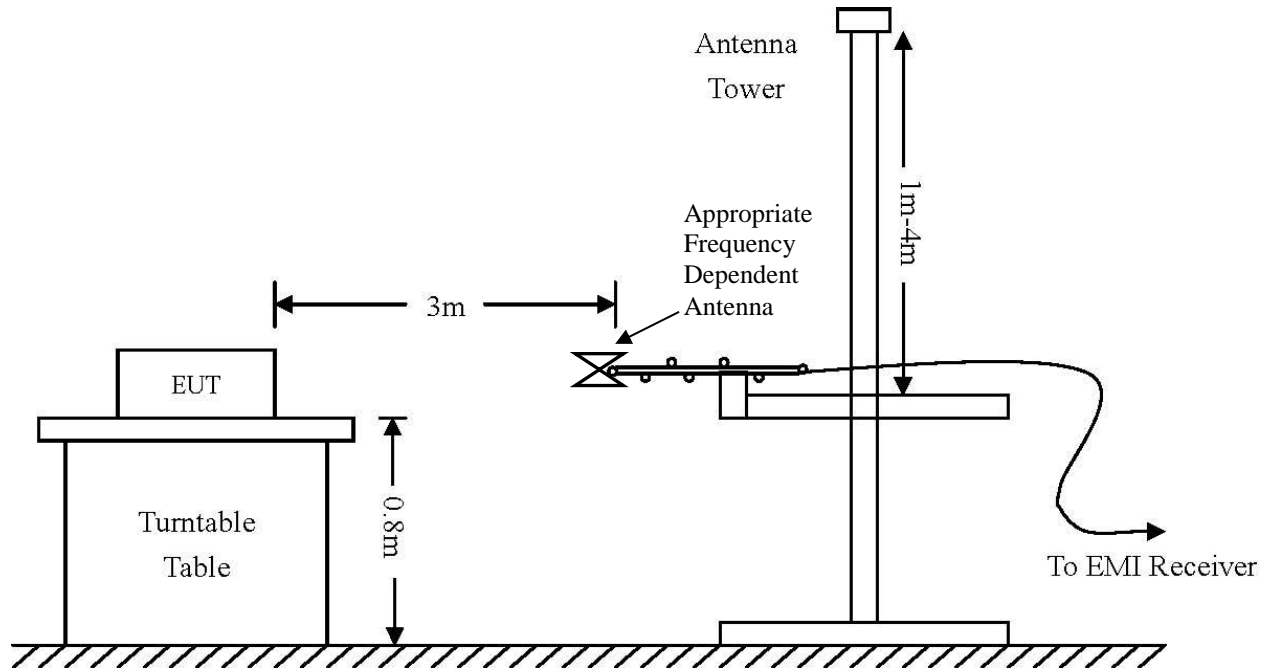

| | | |
|-------------------------|--------------------------|------------------------|
| Frequency: 9 kHz-30 MHz | Frequency: 30 MHz- 1 GHz | Frequency: Above 1 GHz |
| RBW = 9 kHz | RBW = 120 kHz | RBW = 1 MHz |
| VBW = 30 kHz | VBW = 120 kHz | VBW = 1 MHz |
| Sweep time = Auto | Sweep time = Auto | Sweep time = Auto |
| Detector = PK, QP | Detector = PK, QP | Detector = PK, AV |

Diagram 3 Test arrangement for radiated emissions tested on Open Area Test Site (OATS)

Test Site Locations

| | |
|---------------------|--|
| Conducted EMI | The AC power line conducted emissions testing performed in a shielded screen room located at Rogers Labs, Inc., 4405 W. 259 th Terrace, Louisburg, KS |
| Radiated EMI | The radiated emissions tests were performed at the 3 meters, Open Area Test Site (OATS) located at Rogers Labs, Inc., 4405 W. 259 th Terrace, Louisburg, KS |
| Site Registration | Refer to Annex for Site Registration Letters |
| NVLAP Accreditation | Lab code 200087-0 |

List of Test Equipment

A Rohde and Schwarz ESU40 and/or Hewlett Packard 8591EM was used as the measuring device for the emissions testing of frequencies below 1 GHz. A Rohde and Schwarz ESU40 and/or Hewlett Packard 8562A Spectrum Analyzer was used as the measuring device for testing the emissions at frequencies above 1 GHz. The analyzer settings used are described in the following table. Refer to the appendix for a complete list of test equipment.

| AC Line Conducted Emissions (0.150 -30 MHz) | | |
|---|----------|-------------------|
| RBW | AVG. BW | Detector Function |
| 9 kHz | 30 kHz | Peak / Quasi Peak |
| Emissions (30-1000 MHz) | | |
| RBW | AVG. BW | Detector Function |
| 120 kHz | 300 kHz | Peak / Quasi Peak |
| Emissions (Above 1000 MHz) | | |
| RBW | Video BW | Detector Function |
| 100 kHz | 100 kHz | Peak |
| 1 MHz | 1 MHz | Peak / Average |

| <u>Equipment</u> | <u>Manufacturer</u> | <u>Model (SN)</u> | <u>Band</u> | <u>Cal Date</u> | <u>Due</u> |
|---|---------------------|------------------------|-------------|-----------------|------------|
| <input checked="" type="checkbox"/> LISN | Comp. Design | FCC-LISN-2-MOD.CD(126) | .15-30MHz | 10/13 | 10/14 |
| <input checked="" type="checkbox"/> Cable | Time Microwave | 750HF290-750 (L10M) | 9kHz-40 GHz | 10/13 | 10/14 |
| <input checked="" type="checkbox"/> Cable | Belden | RG-58 (L1-CAT3-11509) | 9kHz-30 MHz | 10/13 | 10/14 |
| <input checked="" type="checkbox"/> Cable | Belden | RG-58 (L2-CAT3-11509) | 9kHz-30 MHz | 10/13 | 10/14 |
| <input type="checkbox"/> Antenna | ARA | BCD-235-B (169) | 20-350MHz | 10/13 | 10/14 |
| <input type="checkbox"/> Antenna | EMCO | 3147 (40582) | 200-1000MHz | 10/13 | 10/14 |
| <input checked="" type="checkbox"/> Antenna | Com Power | AH-118 (10110) | 1-18 GHz | 10/13 | 10/14 |
| <input checked="" type="checkbox"/> Antenna | Com Power | AH-840 (101046) | 18-40 GHz | 5/13 | 5/14 |
| <input checked="" type="checkbox"/> Antenna | EMCO | 6509 (9502-1374) | .001-30 MHz | 10/13 | 10/14 |
| <input checked="" type="checkbox"/> Antenna | Sunol | JB-6 (A100709) | 30-1000 MHz | 10/13 | 10/14 |
| <input checked="" type="checkbox"/> Antenna | Standard | FXRY638A (621786) | 10-18 GHz | 5/13 | 5/14 |
| <input type="checkbox"/> Antenna | EMCO | 3143 (9607-1277) | 20-1200 MHz | 5/13 | 5/14 |
| <input type="checkbox"/> Analyzer | HP | 8591EM (3628A00871) | 9kHz-1.8GHz | 5/13 | 5/14 |
| <input type="checkbox"/> Analyzer | HP | 8562A (3051A05950) | 9kHz-110GHz | 5/13 | 5/14 |
| <input checked="" type="checkbox"/> Analyzer | Rohde & Schwarz | ESU40 (100108) | 20Hz-40GHz | 5/13 | 5/14 |
| <input checked="" type="checkbox"/> Amplifier | Com-Power | PA-010 (171003) | 100Hz-30MHz | 10/13 | 10/14 |
| <input checked="" type="checkbox"/> Amplifier | Com-Power | CPPA-102 (01254) | 1-1000 MHz | 10/13 | 10/14 |
| <input checked="" type="checkbox"/> Amplifier | Com-Power | PAM-118A (551014) | 0.5-18 GHz | 10/13 | 10/14 |



Units of Measurements

Conducted EMI Data is in dB μ V; dB referenced to one microvolt

Radiated EMI Data is in dB μ V/m; dB/m referenced to one microvolt per meter

Sample Calculation:

RFS = Radiated Field Strength, FSM = Field Strength Measured

A.F. = Receive antenna factor, Gain = amplification gains and/or cable losses

RFS (dB μ V/m @ 3m) = FSM (dB μ V) + A.F. (dB) - Gain (dB)

Environmental Conditions

| | |
|----------------------|-----------|
| Ambient Temperature | 20.0° C |
| Relative Humidity | 38% |
| Atmospheric Pressure | 1004.1 mb |

Intentional Radiators

As per CFR47, Subpart C, paragraph 15.247 the following information is submitted.

Antenna Requirements

The EUT utilizes MMCX antenna connectors for use with authorized antenna systems. The antenna connection point requires professional installation to comply with the unique antenna connection requirements. As such, the EUT is limited to professional installations only. The requirements of 15.203 are fulfilled; there are no deviations or exceptions to the specification.

Restricted Bands of Operation

Spurious emissions falling in the restricted frequency bands of operation were measured at the OATS. The EUT utilizes frequency, determining circuitry, which generates harmonics falling in the restricted bands. Emissions were investigated at the OATS, using appropriate antennas or pyramidal horns, amplification stages, and a spectrum analyzer. Peak and average amplitudes of frequencies above 1000 MHz were compared to the required limits with worst-case data presented below. Test procedures of ANSI C63.4-2009 paragraphs 13.1 and 8.3.1.2 and KDB 558074 paragraph 10.2 were used during testing. No other significant emission was observed which fell into the restricted bands of operation. Computed emission values take into account the received radiated field strength, receive antenna correction factor, amplifier gain stage, and test system cable losses.

Table 1 General Radiated Emissions in Restricted Bands Data

| Frequency in MHz | Horizontal Peak (dBµV/m) | Horizontal Quasi-Peak (dBµV/m) | Horizontal Average (dBµV/m) | Vertical Peak (dBµV/m) | Vertical Quasi-Peak (dBµV/m) | Vertical Average (dBµV/m) | Limit @ 3m (dBµV/m) |
|------------------|--------------------------|--------------------------------|-----------------------------|------------------------|------------------------------|---------------------------|---------------------|
| 116.7 | 42.2 | 37.0 | N/A | 37.0 | 34.2 | N/A | 43.5 |
| 121.3 | 37.4 | 31.8 | N/A | 29.0 | 23.2 | N/A | 43.5 |

Other emissions present had amplitudes at least 20 dB below the limit. Peak and Quasi-Peak amplitude emissions are recorded above for frequency range of 30-1000 MHz. Peak and Average amplitude emissions are recorded above for frequency range above 1000 MHz.

Table 2 Harmonic Radiated Emissions in Restricted Bands Data (130K-D-1131-150K(WS))

| Frequency in MHz | Horizontal Peak (dBµV/m) | Horizontal Quasi-Peak (dBµV/m) | Horizontal Average (dBµV/m) | Vertical Peak (dBµV/m) | Vertical Quasi-Peak (dBµV/m) | Vertical Average (dBµV/m) | Limit @ 3m (dBµV/m) |
|------------------|--------------------------|--------------------------------|-----------------------------|------------------------|------------------------------|---------------------------|---------------------|
| 2390.0 | 60.9 | N/A | 52.6 | 63.2 | N/A | 53.2 | 54.0 |
| 2483.5 | 57.4 | N/A | 49.8 | 61.9 | N/A | 53.9 | 54.0 |
| 4824.0 | 58.4 | N/A | 49.5 | 63.6 | N/A | 53.7 | 54.0 |
| 4874.0 | 58.8 | N/A | 50.8 | 60.7 | N/A | 53.6 | 54.0 |
| 4924.0 | 54.0 | N/A | 16.6 | 16.1 | N/A | 53.1 | 54.0 |
| 7236.0 | 59.4 | N/A | 46.2 | 58.9 | N/A | 46.3 | 54.0 |
| 7311.0 | 58.3 | N/A | 45.8 | 59.0 | N/A | 46.4 | 54.0 |
| 7386.0 | 54.0 | N/A | 16.6 | 16.1 | N/A | 45.3 | 54.0 |
| 12060.0 | 58.9 | N/A | 46.3 | 59.2 | N/A | 46.6 | 54.0 |
| 12185.0 | 59.9 | N/A | 47.1 | 59.4 | N/A | 46.6 | 54.0 |
| 12310.0 | 60.1 | N/A | 46.6 | 60.2 | N/A | 47.3 | 54.0 |
| 14472.0 | 57.6 | N/A | 45.4 | 58.2 | N/A | 45.8 | 54.0 |

Other emissions present had amplitudes at least 20 dB below the limit.

Table 3 Harmonic Radiated Emissions in Restricted Bands Data (ODH 24-13)

| Frequency in MHz | Horizontal Peak (dBµV/m) | Horizontal Quasi-Peak (dBµV/m) | Horizontal Average (dBµV/m) | Vertical Peak (dBµV/m) | Vertical Quasi-Peak (dBµV/m) | Vertical Average (dBµV/m) | Limit @ 3m (dBµV/m) |
|------------------|--------------------------|--------------------------------|-----------------------------|------------------------|------------------------------|---------------------------|---------------------|
| 2390.0 | 62.8 | N/A | 53.7 | 60.2 | N/A | 53.4 | 54.0 |
| 2483.5 | 58.9 | N/A | 53.3 | 48.8 | N/A | 39.7 | 54.0 |
| 4824.0 | 57.1 | N/A | 45.4 | 55.9 | N/A | 43.1 | 54.0 |
| 4874.0 | 56.0 | N/A | 43.7 | 55.9 | N/A | 43.3 | 54.0 |
| 4924.0 | 54.0 | N/A | 16.6 | 16.1 | N/A | 42.4 | 54.0 |
| 7236.0 | 59.1 | N/A | 46.2 | 58.7 | N/A | 46.2 | 54.0 |
| 7311.0 | 57.9 | N/A | 45.6 | 58.8 | N/A | 45.8 | 54.0 |
| 7386.0 | 54.0 | N/A | 16.6 | 16.1 | N/A | 45.4 | 54.0 |
| 12060.0 | 59.8 | N/A | 46.8 | 58.8 | N/A | 46.4 | 54.0 |
| 12185.0 | 60.2 | N/A | 47.3 | 59.3 | N/A | 46.8 | 54.0 |
| 12310.0 | 59.2 | N/A | 46.7 | 60.2 | N/A | 47.3 | 54.0 |
| 14472.0 | 58.7 | N/A | 46.0 | 57.7 | N/A | 45.6 | 54.0 |

Other emissions present had amplitudes at least 20 dB below the limit.

Table 4 Harmonic Radiated Emissions in Restricted Bands Data (WLO-2450-15)

| Frequency in MHz | Horizontal Peak (dBµV/m) | Horizontal Quasi-Peak (dBµV/m) | Horizontal Average (dBµV/m) | Vertical Peak (dBµV/m) | Vertical Quasi-Peak (dBµV/m) | Vertical Average (dBµV/m) | Limit @ 3m (dBµV/m) |
|------------------|--------------------------|--------------------------------|-----------------------------|------------------------|------------------------------|---------------------------|---------------------|
| 2390.0 | 54.7 | N/A | 49.0 | 67.4 | N/A | 53.9 | 54.0 |
| 2483.5 | 62.0 | N/A | 47.2 | 62.0 | N/A | 53.8 | 54.0 |
| 4824.0 | 56.7 | N/A | 44.6 | 62.3 | N/A | 53.2 | 54.0 |
| 4874.0 | 56.2 | N/A | 45.0 | 59.8 | N/A | 53.2 | 54.0 |
| 4924.0 | 54.0 | N/A | 16.6 | 16.1 | N/A | 53.5 | 54.0 |
| 7236.0 | 58.7 | N/A | 46.2 | 59.3 | N/A | 46.0 | 54.0 |
| 7311.0 | 58.6 | N/A | 45.8 | 58.2 | N/A | 45.7 | 54.0 |
| 7386.0 | 54.0 | N/A | 16.6 | 16.1 | N/A | 45.4 | 54.0 |
| 12060.0 | 58.4 | N/A | 46.3 | 59.3 | N/A | 46.7 | 54.0 |
| 12185.0 | 59.1 | N/A | 46.6 | 59.4 | N/A | 47.3 | 54.0 |
| 12310.0 | 60.2 | N/A | 47.2 | 59.6 | N/A | 46.4 | 54.0 |
| 14472.0 | 58.0 | N/A | 45.5 | 58.5 | N/A | 46.0 | 54.0 |

Other emissions present had amplitudes at least 20 dB below the limit.

Table 5 Harmonic Radiated Emissions in Restricted Bands Data (SA 24-90-17-WB)

| Frequency in MHz | Horizontal Peak (dBµV/m) | Horizontal Quasi-Peak (dBµV/m) | Horizontal Average (dBµV/m) | Vertical Peak (dBµV/m) | Vertical Quasi-Peak (dBµV/m) | Vertical Average (dBµV/m) | Limit @ 3m (dBµV/m) |
|------------------|--------------------------|--------------------------------|-----------------------------|------------------------|------------------------------|---------------------------|---------------------|
| 2390.0 | 58.2 | N/A | 53.0 | 63.5 | N/A | 53.7 | 54.0 |
| 2483.5 | 47.6 | N/A | 34.6 | 59.8 | N/A | 52.7 | 54.0 |
| 4824.0 | 57.6 | N/A | 46.3 | 59.3 | N/A | 51.6 | 54.0 |
| 4874.0 | 56.9 | N/A | 45.0 | 61.6 | N/A | 53.3 | 54.0 |
| 4924.0 | 54.0 | N/A | 16.6 | 16.1 | N/A | 53.2 | 54.0 |
| 7236.0 | 59.0 | N/A | 46.3 | 59.2 | N/A | 46.7 | 54.0 |
| 7311.0 | 57.7 | N/A | 45.6 | 58.6 | N/A | 45.9 | 54.0 |
| 7386.0 | 54.0 | N/A | 16.6 | 16.1 | N/A | 45.4 | 54.0 |
| 12060.0 | 59.8 | N/A | 46.2 | 59.8 | N/A | 46.5 | 54.0 |
| 12185.0 | 60.3 | N/A | 47.3 | 58.9 | N/A | 46.8 | 54.0 |
| 12310.0 | 59.0 | N/A | 46.5 | 59.7 | N/A | 47.2 | 54.0 |
| 14472.0 | 58.2 | N/A | 45.7 | 58.8 | N/A | 46.0 | 54.0 |

Other emissions present had amplitudes at least 20 dB below the limit.

Table 6 Harmonic Radiated Emissions in Restricted Bands Data (WLP-2450-20)

| Frequency in MHz | Horizontal Peak (dBµV/m) | Horizontal Quasi-Peak (dBµV/m) | Horizontal Average (dBµV/m) | Vertical Peak (dBµV/m) | Vertical Quasi-Peak (dBµV/m) | Vertical Average (dBµV/m) | Limit @ 3m (dBµV/m) |
|------------------|--------------------------|--------------------------------|-----------------------------|------------------------|------------------------------|---------------------------|---------------------|
| 2390.0 | 65.9 | N/A | 53.7 | 59.3 | N/A | 52.6 | 54.0 |
| 2483.5 | 61.2 | N/A | 52.8 | 57.4 | N/A | 40.4 | 54.0 |
| 4824.0 | 56.7 | N/A | 45.1 | 55.7 | N/A | 43.5 | 54.0 |
| 4874.0 | 57.6 | N/A | 45.8 | 56.3 | N/A | 43.7 | 54.0 |
| 4924.0 | 54.0 | N/A | 16.6 | 16.1 | N/A | 43.1 | 54.0 |
| 7236.0 | 59.6 | N/A | 47.4 | 59.0 | N/A | 46.4 | 54.0 |
| 7311.0 | 59.5 | N/A | 47.1 | 58.3 | N/A | 45.8 | 54.0 |
| 7386.0 | 54.0 | N/A | 16.6 | 16.1 | N/A | 45.4 | 54.0 |
| 12060.0 | 59.2 | N/A | 46.7 | 58.5 | N/A | 46.3 | 54.0 |
| 12185.0 | 60.0 | N/A | 47.4 | 59.5 | N/A | 46.9 | 54.0 |
| 12310.0 | 59.2 | N/A | 46.5 | 59.7 | N/A | 47.3 | 54.0 |
| 14472.0 | 58.8 | N/A | 46.1 | 58.1 | N/A | 45.7 | 54.0 |

Other emissions present had amplitudes at least 20 dB below the limit.

Table 7 Harmonic Radiated Emissions in Restricted Bands Data (DC-24-HD-PFIP)

| Frequency in MHz | Horizontal Peak (dBµV/m) | Horizontal Quasi-Peak (dBµV/m) | Horizontal Average (dBµV/m) | Vertical Peak (dBµV/m) | Vertical Quasi-Peak (dBµV/m) | Vertical Average (dBµV/m) | Limit @ 3m (dBµV/m) |
|------------------|--------------------------|--------------------------------|-----------------------------|------------------------|------------------------------|---------------------------|---------------------|
| 2390.0 | 48.8 | N/A | 43.7 | 66.6 | N/A | 53.4 | 54.0 |
| 2483.5 | 52.5 | N/A | 40.7 | 69.2 | N/A | 53.8 | 54.0 |
| 4824.0 | 53.9 | N/A | 46.0 | 59.5 | N/A | 53.9 | 54.0 |
| 4874.0 | 53.7 | N/A | 45.4 | 56.9 | N/A | 53.9 | 54.0 |
| 4924.0 | 54.0 | N/A | 16.6 | 16.1 | N/A | 53.7 | 54.0 |
| 7236.0 | 59.1 | N/A | 45.8 | 59.4 | N/A | 46.5 | 54.0 |
| 7311.0 | 58.3 | N/A | 45.7 | 58.7 | N/A | 46.1 | 54.0 |
| 7386.0 | 54.0 | N/A | 16.6 | 16.1 | N/A | 45.5 | 54.0 |
| 12060.0 | 58.6 | N/A | 46.3 | 59.4 | N/A | 46.6 | 54.0 |
| 12185.0 | 60.0 | N/A | 47.4 | 59.5 | N/A | 46.8 | 54.0 |
| 12310.0 | 59.5 | N/A | 47.1 | 61.7 | N/A | 47.8 | 54.0 |
| 14472.0 | 58.1 | N/A | 45.5 | 58.8 | N/A | 46.0 | 54.0 |

Other emissions present had amplitudes at least 20 dB below the limit.



Peak and Quasi-Peak amplitude emissions are recorded above for frequency range of 30-1000 MHz. Peak and Average amplitude emissions are recorded in tables above for frequency range above 1000 MHz.

Summary of Results for Radiated Emissions in Restricted Bands

The EUT demonstrated compliance with the radiated emissions requirements of CFR 47 Part 15C Intentional Radiators. The EUT demonstrated a worst-case minimum margin of -0.1 dB below the radiated emissions requirements in restricted frequency bands. Peak, Quasi-peak, and average amplitudes were checked for compliance with the regulations. Worst-case emissions are reported with other emissions found in the restricted frequency bands at least 20 dB below the requirements.

AC Line Conducted Emissions Procedure

The EUT was arranged in a typical equipment configuration and placed on a 1 x 1.5-meter wooden bench 80 cm above the conducting ground plane, floor of a screen room. The bench was positioned 40 cm away from the wall of the screen room. The LISN was positioned on the floor of the screen room 80-cm from the rear of the EUT. The manufacturer supplied AC power cord for the computer supporting the transmitter EUT was connected to the LISN. A second LISN was positioned on the floor of the screen room 80-cm from the rear of the supporting equipment of the EUT. All power cords except the EUT were then powered from the second LISN. EMI was coupled to the spectrum analyzer through a 0.1 μ F capacitor, internal to the LISN. Power line conducted emissions testing were carried out individually for each current carrying conductor of the EUT. The excess length of lead between the system and the LISN receptacle was folded back and forth to form a bundle not exceeding 40 cm in length. The screen room, conducting ground plane, analyzer, and LISN were bonded together to the protective earth ground. Preliminary testing was performed to identify the frequency of each radio frequency emission displaying the highest amplitude. The cables were repositioned to obtain maximum amplitude of measured EMI level. Once the worst-case configuration was identified, plots were made of the EMI from 0.15 MHz to 30 MHz then the data was recorded with maximum conducted emissions levels. Refer to figures one and two for plots of the AC Power Line conducted emissions of the computer systems supporting the EUT.

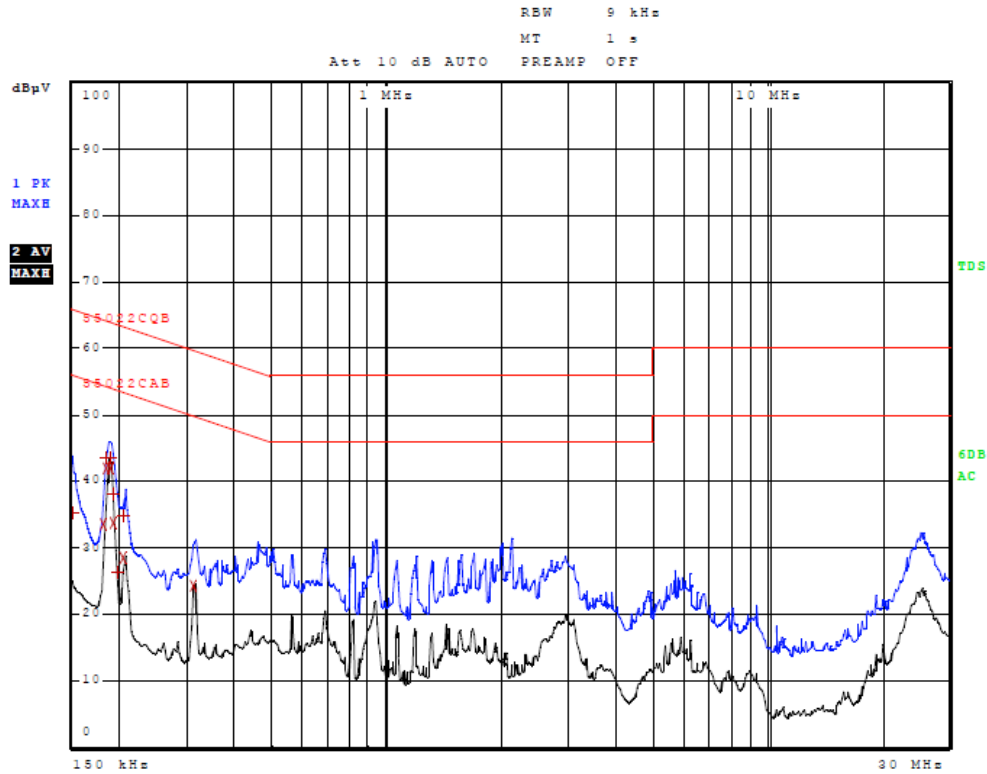

Figure 1 AC Line Conducted Emissions Line 1

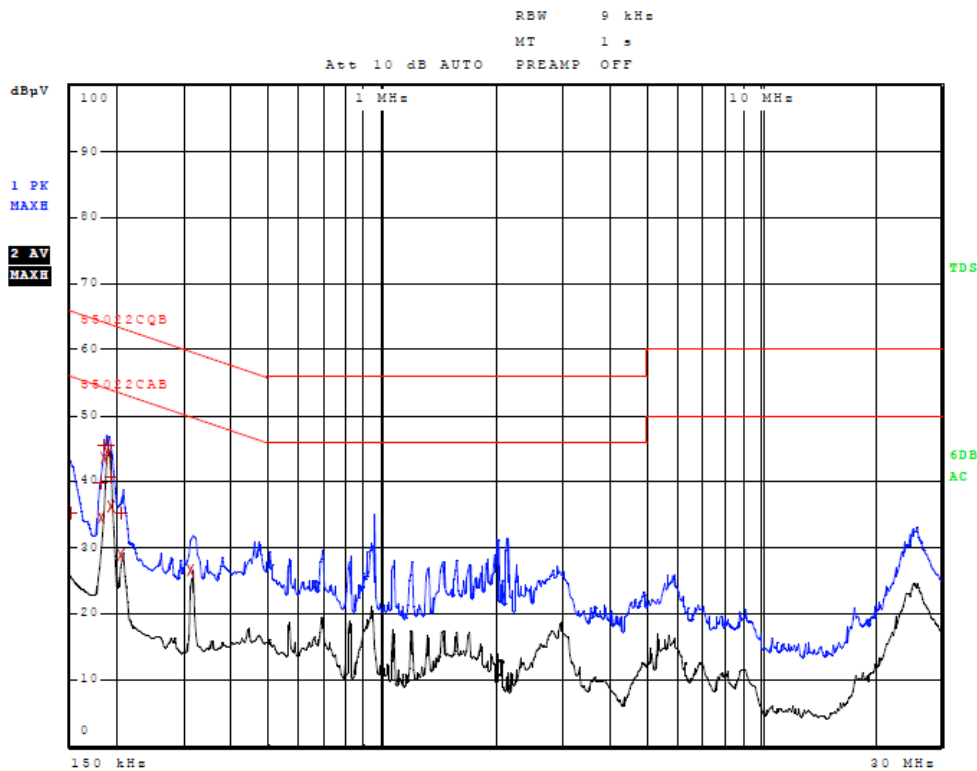

Figure 2 AC Line Conducted Emissions Line 2

Table 8 AC Line Conducted Emissions Data (Highest Emissions) Line L1

| Trace | Frequency | Level (dBµV) | Detector | Delta Limit/dB |
|-------|-------------------|--------------|------------|----------------|
| 1 | 150.000000000 kHz | 35.11 | Quasi Peak | -30.89 |
| 2 | 182.000000000 kHz | 33.45 | Average | -20.95 |
| 2 | 186.000000000 kHz | 41.91 | Average | -12.30 |
| 1 | 186.000000000 kHz | 43.56 | Quasi Peak | -20.66 |
| 2 | 190.000000000 kHz | 42.00 | Average | -12.03 |
| 1 | 190.000000000 kHz | 43.52 | Quasi Peak | -20.52 |
| 2 | 194.000000000 kHz | 33.73 | Average | -20.14 |
| 1 | 194.000000000 kHz | 38.16 | Quasi Peak | -25.70 |
| 1 | 198.000000000 kHz | 26.29 | Quasi Peak | -37.40 |
| 2 | 206.000000000 kHz | 28.47 | Average | -24.90 |
| 1 | 206.000000000 kHz | 34.76 | Quasi Peak | -28.61 |
| 2 | 314.000000000 kHz | 24.18 | Average | -25.69 |

Table 9 AC Line Conducted Emissions Data (Highest Emissions) Line L2

| Trace | Frequency | Level (dBµV) | Detector | Delta Limit/dB |
|-------|-------------------|--------------|------------|----------------|
| 1 | 150.000000000 kHz | 35.14 | Quasi Peak | -30.86 |
| 1 | 182.000000000 kHz | 39.76 | Quasi Peak | -24.64 |
| 2 | 182.000000000 kHz | 34.57 | Average | -19.83 |
| 2 | 186.000000000 kHz | 43.59 | Average | -10.62 |
| 1 | 186.000000000 kHz | 45.45 | Quasi Peak | -18.76 |
| 2 | 190.000000000 kHz | 44.26 | Average | -9.78 |
| 1 | 190.000000000 kHz | 45.42 | Quasi Peak | -18.62 |
| 2 | 194.000000000 kHz | 36.34 | Average | -17.52 |
| 1 | 194.000000000 kHz | 40.56 | Quasi Peak | -23.30 |
| 2 | 206.000000000 kHz | 28.91 | Average | -24.45 |
| 1 | 206.000000000 kHz | 35.16 | Quasi Peak | -28.21 |
| 2 | 314.000000000 kHz | 26.51 | Average | -23.36 |

Other emissions present had amplitudes at least 20 dB below the limit.

Summary of Results for AC Line Conducted Emissions

The EUT demonstrated compliance to the conducted emissions requirements of CFR47 Part 15C equipment. The EUT supporting computer system demonstrated minimum margin of -9.7 dB below the limit. Measurements were taken using the peak, quasi peak, and average, measurement function for each emissions amplitude and were below the limits stated in the specification. Other emissions were present with recorded data representing worst-case amplitudes.



General Radiated Emissions Procedure

The EUT was arranged on the supporting interface board without an enclosure emulating a worst-case equipment configuration and operated through all available modes. Preliminary testing was performed in a screen room with the EUT positioned 1 meter from the FSM.

Radiated emissions measurements were performed to identify the frequencies, which produced the highest emissions. Each radiated emission was then maximized at the OATS location before final radiated emissions measurements were performed. Final data was taken with the EUT located at the OATS at a distance of 3 meters between the EUT and the receiving antenna. The frequency spectrum from 9 kHz to 25,000 MHz was searched for general radiated emissions.

Measured emission levels were maximized by EUT placement on the table, rotating the turntable through 360 degrees, varying the antenna height between 1 and 4 meters above the ground plane and changing antenna position between horizontal and vertical polarization. Antennas used were Loop from 9 kHz to 30 MHz, Broadband Biconical from 30 to 200 MHz, Biconilog from 30 to 1000 MHz, Log Periodic from 200 MHz to 1 GHz and or double Ridge or pyramidal horns and mixers from 1 GHz to 40 GHz, notch filters and appropriate amplifiers and external mixers were utilized.

Table 10 General Radiated Emissions from EUT Data (Highest Emissions)

| Frequency in MHz | Horizontal Peak (dBµV/m) | Horizontal Quasi-Peak (dBµV/m) | Horizontal Average (dBµV/m) | Vertical Peak (dBµV/m) | Vertical Quasi-Peak (dBµV/m) | Vertical Average (dBµV/m) | Limit @ 3m (dBµV/m) |
|------------------|--------------------------|--------------------------------|-----------------------------|------------------------|------------------------------|---------------------------|---------------------|
| 63.1 | 30.5 | 27.9 | N/A | 26.6 | 23.8 | N/A | 43.5 |
| 71.5 | 33.7 | 28.4 | N/A | 23.8 | 19.0 | N/A | 43.5 |
| 75.7 | 31.2 | 25.1 | N/A | 19.0 | 13.9 | N/A | 43.5 |
| 84.1 | 33.4 | 30.9 | N/A | 35.2 | 31.6 | N/A | 43.5 |
| 116.7 | 42.2 | 37.0 | N/A | 37.0 | 34.2 | N/A | 46.0 |
| 121.3 | 37.4 | 31.8 | N/A | 29.0 | 23.2 | N/A | 46.0 |
| 139.0 | 32.1 | 26.7 | N/A | 26.8 | 20.0 | N/A | 46.0 |
| 144.9 | 38.3 | 33.0 | N/A | 29.4 | 23.8 | N/A | 46.0 |
| 166.2 | 41.5 | 38.7 | N/A | 42.8 | 39.5 | N/A | 46.0 |
| 298.8 | 36.3 | 34.6 | N/A | 29.1 | 26.7 | N/A | 54.0 |
| 333.2 | 22.1 | 18.1 | N/A | 24.9 | 21.7 | N/A | 54.0 |
| 365.2 | 37.5 | 36.3 | N/A | 30.0 | 28.0 | N/A | 54.0 |
| 474.0 | 27.4 | 24.4 | N/A | 27.8 | 25.0 | N/A | 54.0 |

Other emissions present had amplitudes at least 20 dB below the limit. Peak and Quasi-Peak amplitude emissions are recorded above for frequency range of 30-1000 MHz. Peak and Average amplitude emissions are recorded above for frequency range above 1000 MHz.

Summary of Results for General Radiated Emissions

The EUT demonstrated compliance with the radiated emissions requirements of CFR47 Part 15C paragraph 15.209 Intentional Radiators. The EUT computer support system demonstrated a minimum margin of -4.0 dB below the requirements. Other emissions were present with amplitudes at least 20 dB below the Limits.

Operation in the Band 2400 – 2483.5 MHz

The power output was measured at the antenna port and the open area test site at a three-meter distance. The EUT was placed on a wooden turntable 0.8 meters above the ground plane at a distance of 3 meters from the FSM antenna. The peak and quasi-peak amplitude of the frequencies below 1000 MHz were measured using a spectrum analyzer. The peak and average amplitude of emissions above 1000 MHz including were measured using a spectrum analyzer. Emissions data was recorded from the measurement results. Plots were made of transmitter performance for reference purposes. Refer to figures three through fourteen showing plots of the EUT performance displaying compliance with the specifications.

Table 11 Transmitter Antenna port Conducted Emissions Data (Total Highest)

| Channel Mode | Total Output Power (dBm / Watts) | Total Power Spectral Density (dBm) |
|--------------|----------------------------------|------------------------------------|
| 20 MHz | 30.0 dBm / 1.0 Watts | 0.78 |
| 40 MHz | 29.9 dBm / 1.0 Watts | -7.75 |

Table 12 Transmitter Antenna Conducted Emissions Data

| Frequency MHz | Antenna Conducted Output Power dBm | 6-dB Occupied Bandwidth kHz | Power Spectral Density dBm |
|---------------|------------------------------------|-----------------------------|----------------------------|
| 20 MHz Mode | | | |
| 2412.0 | 30.00 | 16,490.4 | 0.80 |
| 2437.0 | 29.96 | 16,490.4 | 0.51 |
| 2462.0 | 29.55 | 16,456.7 | 0.78 |
| 40 MHz Mode | | | |
| 2422.0 | 30 | 39,163.5 | -7.75 |
| 2447.0 | 29.98 | 38,365.4 | -8.09 |
| 2452.0 | 29.82 | 37,826.9 | -7.96 |

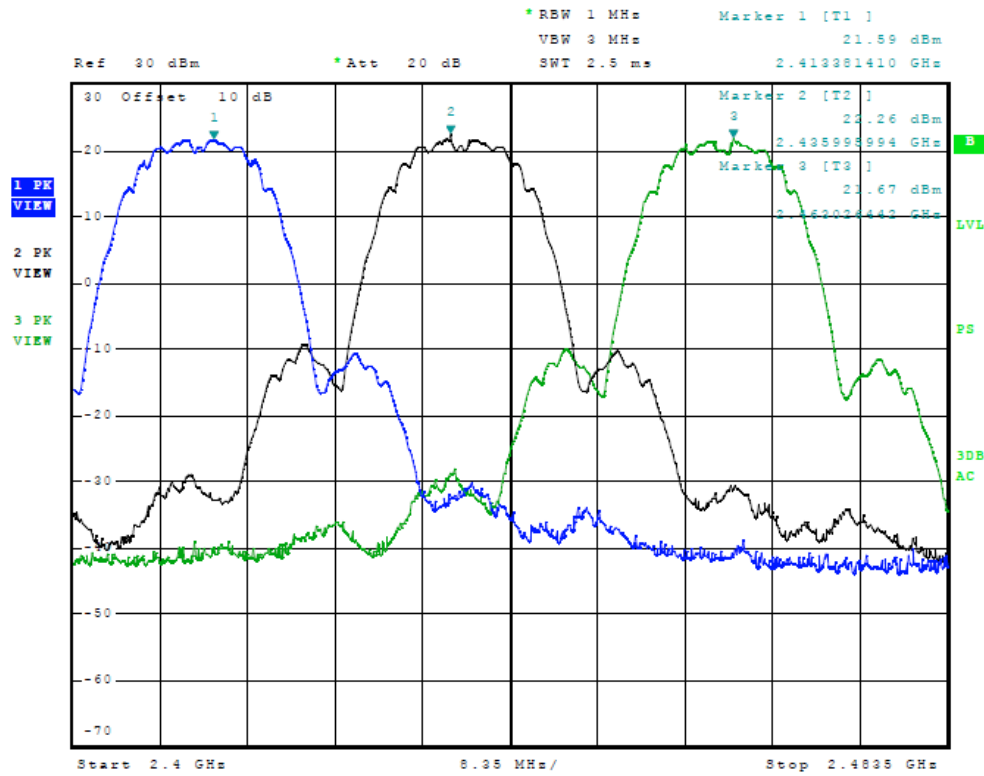

Figure 3 Plot of Transmitter Emissions (Across Operational Band, b/g/n Mode)

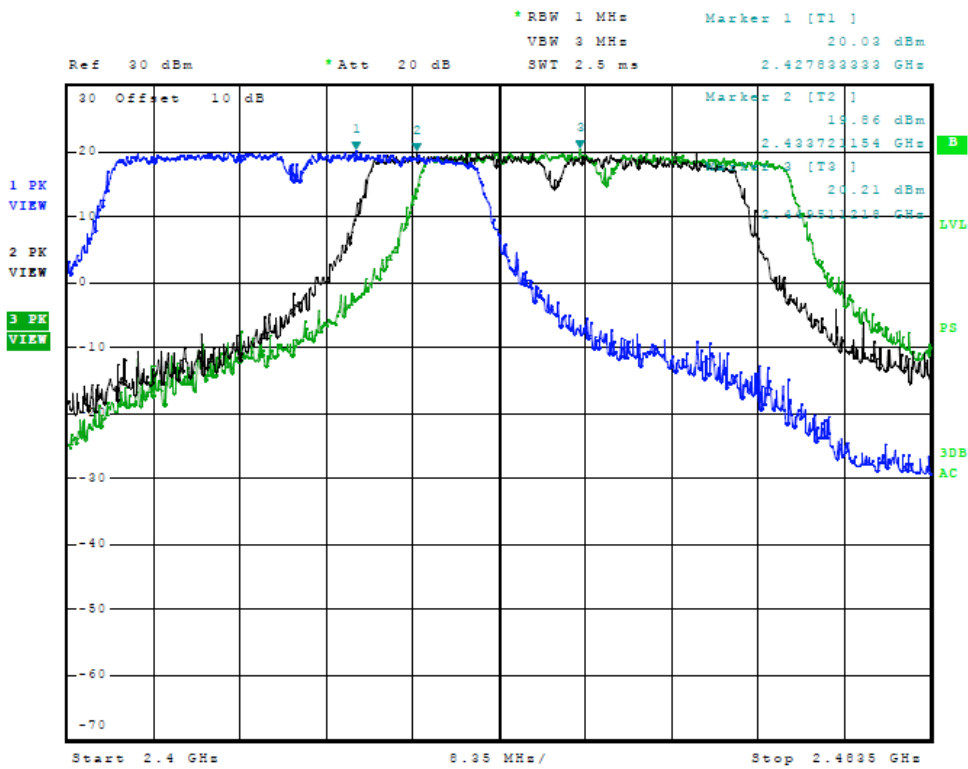

Figure 4 Plot of Transmitter Emissions (Across Operational Band, n Mode)

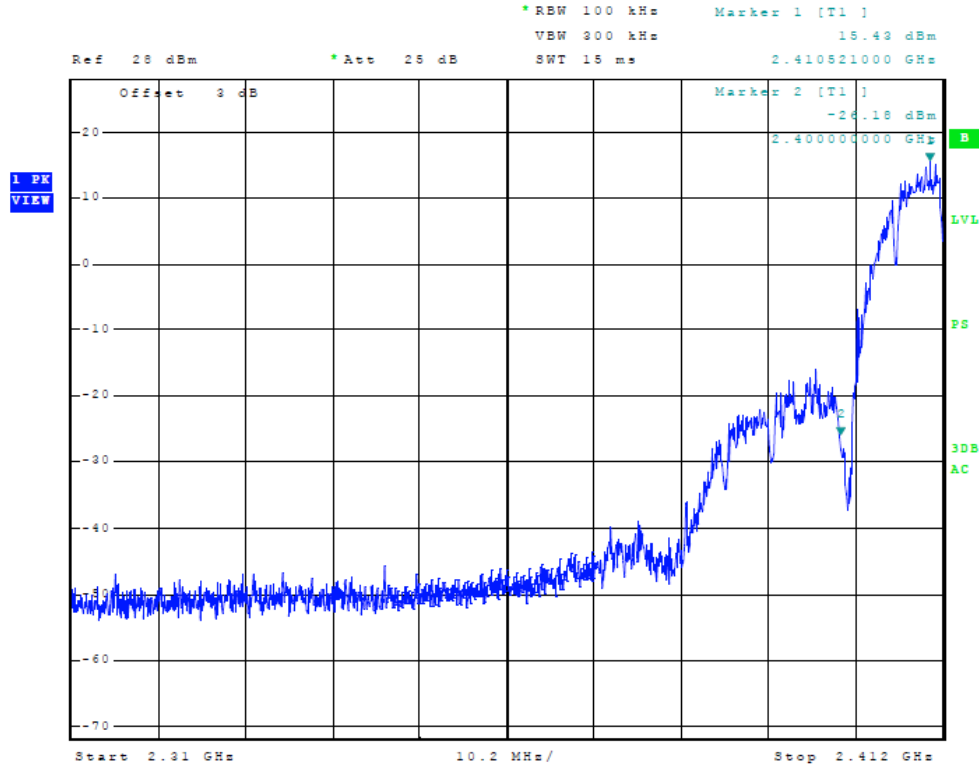

Figure 5 Plot of Low Band Edge (b/g/n Mode)

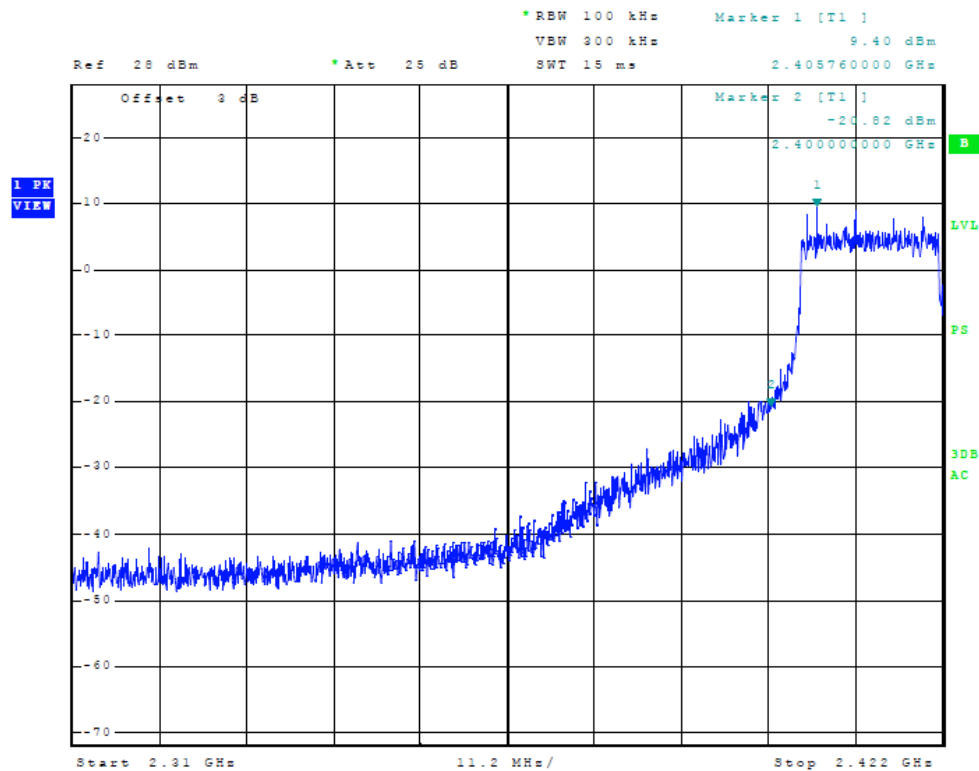

Figure 6 Plot of Low Band Edge (n Mode)

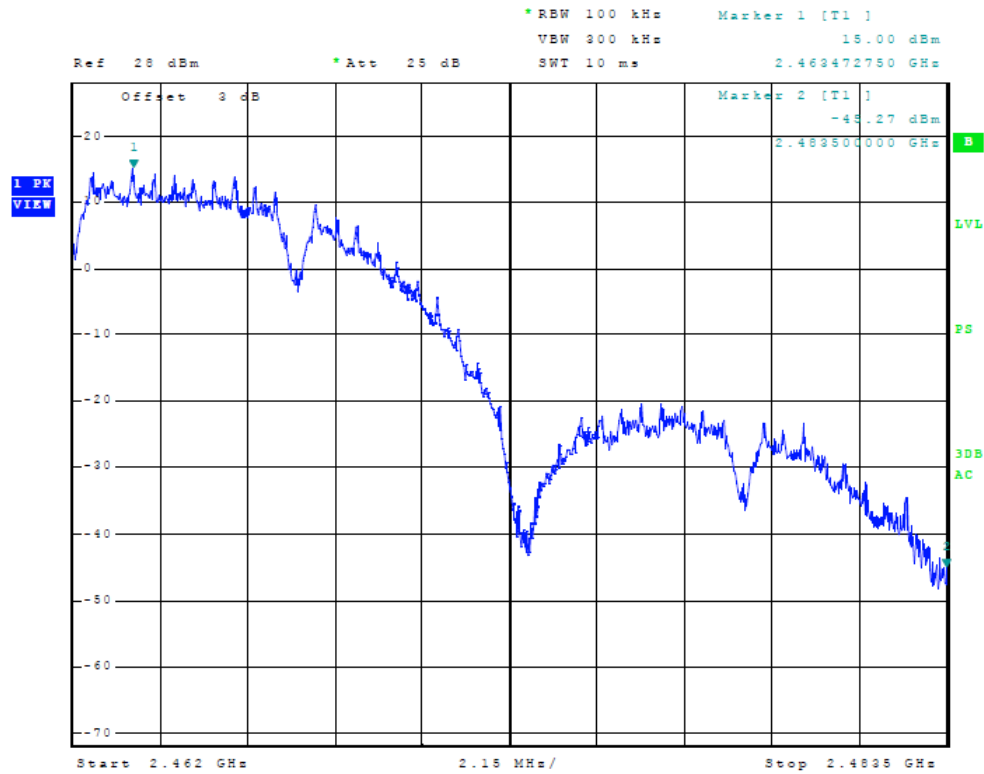

Figure 7 Plot of High Band Edge (b/g/n Mode)

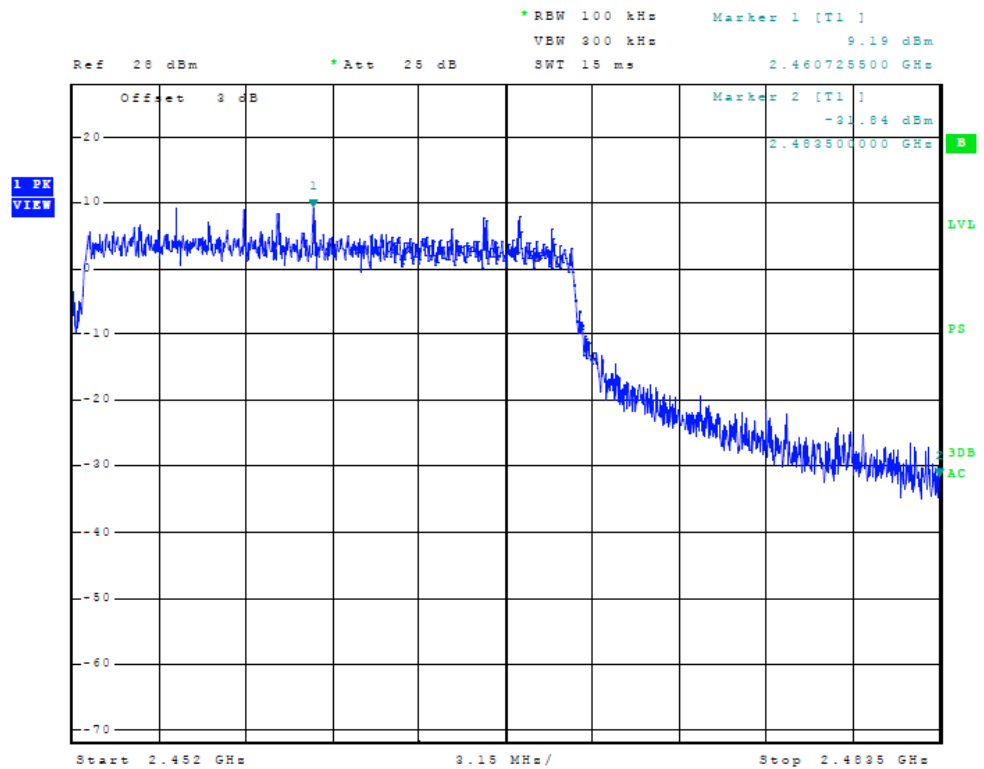

Figure 8 Plot of High Band Edge (n Mode)

Transmitter Emissions Data

Table 13 Transmitter Radiated Emission (130K-D-1131-150K(WS))

| Frequency in MHz | Horizontal Peak (dBµV/m) | Horizontal Average (dBµV/m) | Vertical Peak (dBµV/m) | Vertical Average (dBµV/m) | Limit @ 3m (dBµV/m) |
|------------------|--------------------------|-----------------------------|------------------------|---------------------------|---------------------|
| 2412.0 | -- | -- | -- | -- | -- |
| 4824.0 | 58.4 | 49.5 | 63.6 | 53.7 | 54.0 |
| 7236.0 | 59.4 | 46.2 | 58.9 | 46.3 | 54.0 |
| 9648.0 | 58.4 | 45.5 | 57.8 | 45.6 | 54.0 |
| 12060.0 | 58.9 | 46.3 | 59.2 | 46.6 | 54.0 |
| 14472.0 | 57.6 | 45.4 | 58.2 | 45.8 | 54.0 |
| 16884.0 | 61.2 | 48.6 | 61.1 | 48.6 | 54.0 |
| 2437.0 | -- | -- | -- | -- | -- |
| 4874.0 | 58.8 | 50.8 | 60.7 | 53.6 | 54.0 |
| 7311.0 | 58.3 | 45.8 | 59.0 | 46.4 | 54.0 |
| 9748.0 | 58.4 | 45.9 | 58.7 | 46.3 | 54.0 |
| 12185.0 | 59.9 | 47.1 | 59.4 | 46.6 | 54.0 |
| 14622.0 | 60.0 | 47.2 | 59.8 | 46.9 | 54.0 |
| 17059.0 | 60.3 | 47.9 | 60.7 | 47.9 | 54.0 |
| 2462.0 | -- | -- | -- | -- | -- |
| 4924.0 | 59.4 | 51.3 | 58.2 | 53.1 | 54.0 |
| 7386.0 | 57.5 | 45.2 | 58.2 | 45.3 | 54.0 |
| 9848.0 | 58.4 | 45.9 | 58.7 | 45.9 | 54.0 |
| 12310.0 | 60.1 | 46.6 | 60.2 | 47.3 | 54.0 |
| 14772.0 | 61.2 | 47.6 | 60.5 | 47.7 | 54.0 |
| 17234.0 | 62.7 | 49.3 | 62.1 | 49.4 | 54.0 |

Other emissions present had amplitudes at least 20 dB below the limit. Peak and Quasi-Peak amplitude emissions are recorded above for frequency range of 30-1000 MHz. Peak and Average amplitude emissions are recorded above for frequency range above 1000 MHz.

Table 14 Transmitter Radiated Emission (ODH 24-13)

| Frequency in MHz | Horizontal Peak (dBµV/m) | Horizontal Average (dBµV/m) | Vertical Peak (dBµV/m) | Vertical Average (dBµV/m) | Limit @ 3m (dBµV/m) |
|------------------|--------------------------|-----------------------------|------------------------|---------------------------|---------------------|
| 2412.0 | -- | -- | -- | -- | -- |
| 4824.0 | 57.1 | 45.4 | 55.9 | 43.1 | 54.0 |
| 7236.0 | 59.1 | 46.2 | 58.7 | 46.2 | 54.0 |
| 9648.0 | 58.3 | 45.6 | 59.1 | 45.5 | 54.0 |
| 12060.0 | 59.8 | 46.8 | 58.8 | 46.4 | 54.0 |
| 14472.0 | 58.7 | 46.0 | 57.7 | 45.6 | 54.0 |
| 16884.0 | 61.6 | 48.7 | 61.4 | 48.8 | 54.0 |
| 2437.0 | -- | -- | -- | -- | -- |
| 4874.0 | 56.0 | 43.7 | 55.9 | 43.3 | 54.0 |
| 7311.0 | 57.9 | 45.6 | 58.8 | 45.8 | 54.0 |
| 9748.0 | 58.3 | 46.0 | 57.9 | 45.7 | 54.0 |
| 12185.0 | 60.2 | 47.3 | 59.3 | 46.8 | 54.0 |
| 14622.0 | 59.9 | 47.1 | 58.8 | 46.7 | 54.0 |
| 17059.0 | 60.8 | 48.3 | 60.7 | 48.3 | 54.0 |
| 2462.0 | -- | -- | -- | -- | -- |
| 4924.0 | 55.6 | 44.7 | 56.0 | 42.4 | 54.0 |
| 7386.0 | 58.1 | 45.4 | 57.9 | 45.4 | 54.0 |
| 9848.0 | 58.3 | 45.6 | 58.8 | 45.9 | 54.0 |
| 12310.0 | 59.2 | 46.7 | 60.2 | 47.3 | 54.0 |
| 14772.0 | 61.0 | 47.8 | 60.1 | 47.7 | 54.0 |
| 17234.0 | 61.7 | 49.3 | 61.8 | 49.4 | 54.0 |

Other emissions present had amplitudes at least 20 dB below the limit. Peak and Quasi-Peak amplitude emissions are recorded above for frequency range of 30-1000 MHz. Peak and Average amplitude emissions are recorded above for frequency range above 1000 MHz.

Table 15 Transmitter Radiated Emission (WLO-2450-15)

| Frequency in MHz | Horizontal Peak (dBμV/m) | Horizontal Average (dBμV/m) | Vertical Peak (dBμV/m) | Vertical Average (dBμV/m) | Limit @ 3m (dBμV/m) |
|------------------|--------------------------|-----------------------------|------------------------|---------------------------|---------------------|
| 2412.0 | -- | -- | -- | -- | -- |
| 4824.0 | 56.7 | 44.6 | 62.3 | 53.2 | 54.0 |
| 7236.0 | 58.7 | 46.2 | 59.3 | 46.0 | 54.0 |
| 9648.0 | 58.3 | 45.8 | 58.0 | 45.6 | 54.0 |
| 12060.0 | 58.4 | 46.3 | 59.3 | 46.7 | 54.0 |
| 14472.0 | 58.0 | 45.5 | 58.5 | 46.0 | 54.0 |
| 16884.0 | 61.2 | 48.7 | 61.4 | 48.7 | 54.0 |
| 2437.0 | -- | -- | -- | -- | -- |
| 4874.0 | 56.2 | 45.0 | 59.8 | 53.2 | 54.0 |
| 7311.0 | 58.6 | 45.8 | 58.2 | 45.7 | 54.0 |
| 9748.0 | 58.3 | 45.7 | 58.7 | 46.0 | 54.0 |
| 12185.0 | 59.1 | 46.6 | 59.4 | 47.3 | 54.0 |
| 14622.0 | 59.4 | 47.0 | 60.4 | 47.6 | 54.0 |
| 17059.0 | 60.5 | 48.0 | 60.8 | 48.1 | 54.0 |
| 2462.0 | -- | -- | -- | -- | -- |
| 4924.0 | 55.2 | 42.6 | 59.4 | 53.5 | 54.0 |
| 7386.0 | 57.8 | 45.4 | 58.2 | 45.4 | 54.0 |
| 9848.0 | 58.1 | 45.8 | 58.1 | 45.5 | 54.0 |
| 12310.0 | 60.2 | 47.2 | 59.6 | 46.4 | 54.0 |
| 14772.0 | 59.9 | 47.5 | 60.4 | 47.4 | 54.0 |
| 17234.0 | 63.2 | 49.6 | 62.6 | 49.5 | 54.0 |

Other emissions present had amplitudes at least 20 dB below the limit. Peak and Quasi-Peak amplitude emissions are recorded above for frequency range of 30-1000 MHz. Peak and Average amplitude emissions are recorded above for frequency range above 1000 MHz.

Table 16 Transmitter Radiated Emission (SA 24-90-17-WB)

| Frequency in MHz | Horizontal Peak (dBµV/m) | Horizontal Average (dBµV/m) | Vertical Peak (dBµV/m) | Vertical Average (dBµV/m) | Limit @ 3m (dBµV/m) |
|------------------|--------------------------|-----------------------------|------------------------|---------------------------|---------------------|
| 2412.0 | -- | -- | -- | -- | -- |
| 4824.0 | 57.6 | 46.3 | 59.3 | 51.6 | 54.0 |
| 7236.0 | 59.0 | 46.3 | 59.2 | 46.7 | 54.0 |
| 9648.0 | 58.6 | 45.8 | 58.3 | 45.9 | 54.0 |
| 12060.0 | 59.8 | 46.2 | 59.8 | 46.5 | 54.0 |
| 14472.0 | 58.2 | 45.7 | 58.8 | 46.0 | 54.0 |
| 16884.0 | 60.9 | 48.5 | 61.4 | 48.5 | 54.0 |
| 2437.0 | -- | -- | -- | -- | -- |
| 4874.0 | 56.9 | 45.0 | 61.6 | 53.3 | 54.0 |
| 7311.0 | 57.7 | 45.6 | 58.6 | 45.9 | 54.0 |
| 9748.0 | 58.6 | 45.9 | 58.2 | 45.7 | 54.0 |
| 12185.0 | 60.3 | 47.3 | 58.9 | 46.8 | 54.0 |
| 14622.0 | 59.4 | 47.2 | 58.9 | 46.7 | 54.0 |
| 17059.0 | 61.2 | 48.1 | 60.9 | 48.1 | 54.0 |
| 2462.0 | -- | -- | -- | -- | -- |
| 4924.0 | 56.8 | 48.0 | 60.1 | 53.2 | 54.0 |
| 7386.0 | 59.0 | 45.4 | 58.3 | 45.4 | 54.0 |
| 9848.0 | 57.8 | 45.5 | 58.3 | 45.7 | 54.0 |
| 12310.0 | 59.0 | 46.5 | 59.7 | 47.2 | 54.0 |
| 14772.0 | 60.3 | 47.5 | 60.0 | 47.6 | 54.0 |
| 17234.0 | 61.6 | 49.3 | 61.7 | 49.3 | 54.0 |

Other emissions present had amplitudes at least 20 dB below the limit. Peak and Quasi-Peak amplitude emissions are recorded above for frequency range of 30-1000 MHz. Peak and Average amplitude emissions are recorded above for frequency range above 1000 MHz.

Table 17 Transmitter Radiated Emission (WLP-2450-20)

| Frequency in MHz | Horizontal Peak (dBµV/m) | Horizontal Average (dBµV/m) | Vertical Peak (dBµV/m) | Vertical Average (dBµV/m) | Limit @ 3m (dBµV/m) |
|------------------|--------------------------|-----------------------------|------------------------|---------------------------|---------------------|
| 2412.0 | -- | -- | -- | -- | -- |
| 4824.0 | 56.7 | 45.1 | 55.7 | 43.5 | 54.0 |
| 7236.0 | 59.6 | 47.4 | 59.0 | 46.4 | 54.0 |
| 9648.0 | 58.2 | 45.9 | 58.1 | 45.9 | 54.0 |
| 12060.0 | 59.2 | 46.7 | 58.5 | 46.3 | 54.0 |
| 14472.0 | 58.8 | 46.1 | 58.1 | 45.7 | 54.0 |
| 16884.0 | 61.2 | 48.7 | 61.6 | 48.7 | 54.0 |
| 2437.0 | -- | -- | -- | -- | -- |
| 4874.0 | 57.6 | 45.8 | 56.3 | 43.7 | 54.0 |
| 7311.0 | 59.5 | 47.1 | 58.3 | 45.8 | 54.0 |
| 9748.0 | 58.9 | 45.9 | 58.4 | 45.8 | 54.0 |
| 12185.0 | 60.0 | 47.4 | 59.5 | 46.9 | 54.0 |
| 14622.0 | 59.6 | 47.0 | 59.3 | 46.6 | 54.0 |
| 17059.0 | 60.5 | 47.9 | 60.0 | 47.9 | 54.0 |
| 2462.0 | -- | -- | -- | -- | -- |
| 4924.0 | 59.6 | 45.9 | 55.3 | 43.1 | 54.0 |
| 7386.0 | 58.7 | 46.5 | 58.0 | 45.4 | 54.0 |
| 9848.0 | 58.3 | 45.8 | 58.3 | 46.0 | 54.0 |
| 12310.0 | 59.2 | 46.5 | 59.7 | 47.3 | 54.0 |
| 14772.0 | 60.7 | 47.5 | 60.2 | 47.7 | 54.0 |
| 17234.0 | 61.8 | 49.5 | 62.3 | 49.5 | 54.0 |

Other emissions present had amplitudes at least 20 dB below the limit. Peak and Quasi-Peak amplitude emissions are recorded above for frequency range of 30-1000 MHz. Peak and Average amplitude emissions are recorded above for frequency range above 1000 MHz.

Table 18 Transmitter Radiated Emission (DC-24-HD-PFIP)

| Frequency in MHz | Horizontal Peak (dBμV/m) | Horizontal Average (dBμV/m) | Vertical Peak (dBμV/m) | Vertical Average (dBμV/m) | Limit @ 3m (dBμV/m) |
|------------------|--------------------------|-----------------------------|------------------------|---------------------------|---------------------|
| 2412.0 | -- | -- | -- | -- | -- |
| 4824.0 | 53.9 | 46.0 | 59.5 | 53.9 | 54.0 |
| 7236.0 | 59.1 | 45.8 | 59.4 | 46.5 | 54.0 |
| 9648.0 | 58.2 | 45.4 | 59.0 | 45.6 | 54.0 |
| 12060.0 | 58.6 | 46.3 | 59.4 | 46.6 | 54.0 |
| 14472.0 | 58.1 | 45.5 | 58.8 | 46.0 | 54.0 |
| 16884.0 | 61.0 | 48.6 | 60.9 | 48.6 | 54.0 |
| 2437.0 | -- | -- | -- | -- | -- |
| 4874.0 | 53.7 | 45.4 | 56.9 | 53.9 | 54.0 |
| 7311.0 | 58.3 | 45.7 | 58.7 | 46.1 | 54.0 |
| 9748.0 | 59.0 | 45.8 | 58.8 | 45.7 | 54.0 |
| 12185.0 | 60.0 | 47.4 | 59.5 | 46.8 | 54.0 |
| 14622.0 | 59.8 | 47.2 | 59.7 | 46.8 | 54.0 |
| 17059.0 | 60.9 | 47.9 | 60.3 | 47.9 | 54.0 |
| 2462.0 | -- | -- | -- | -- | -- |
| 4924.0 | 57.3 | 49.4 | 59.7 | 53.7 | 54.0 |
| 7386.0 | 58.3 | 45.4 | 57.9 | 45.5 | 54.0 |
| 9848.0 | 57.9 | 44.9 | 58.7 | 45.2 | 54.0 |
| 12310.0 | 59.5 | 47.1 | 61.7 | 47.8 | 54.0 |
| 14772.0 | 60.2 | 47.4 | 60.5 | 47.5 | 54.0 |
| 17234.0 | 61.4 | 49.1 | 61.2 | 49.1 | 54.0 |

Other emissions present had amplitudes at least 20 dB below the limit. Peak and Quasi-Peak amplitude emissions are recorded above for frequency range of 30-1000 MHz. Peak and Average amplitude emissions are recorded above for frequency range above 1000 MHz.



Summary of Results for Transmitter Radiated Emissions of Intentional Radiator

The EUT demonstrated compliance with the radiated emissions requirements of CFR47 Part 15.247. Peak antenna port conducted power of 1 watt (30.0 dBm). The peak power spectral density presented a minimum margin of -7.2 dB below the requirements. The EUT demonstrated a minimum margin of -0.1 dB below the harmonic emissions requirements. There were no other significantly measurable emissions in the restricted bands other than those recorded in this report. Other emissions were present with amplitudes at least 20 dB below the requirements. There were no other deviations or exceptions to the requirements.

Statement of Modifications and Deviations

No modifications to the EUT were required for the unit to demonstrate compliance with the CFR47 Part 15C emissions standards. There were no deviations to the specifications.



NVLAP Lab Code 200087-0

Annex

- Annex A Measurement Uncertainty Calculations
- Annex B Rogers Labs Test Equipment List
- Annex C Rogers Qualifications
- Annex D FCC Site Registration Letter
- Annex E Industry Canada Site Registration Letter

**Annex A Measurement Uncertainty Calculations**

Measurement uncertainty calculations were made for the laboratory. Result of measurement uncertainty calculations are recorded below for AC line conducted and radiated emission measurements.

| Measurement Uncertainty | $U_{(E)}$ | $U_{(lab)}$ |
|---|-----------|-------------|
| 3 Meter Horizontal 30-200 MHz Measurements | 2.08 | 4.16 |
| 3 Meter Vertical 30-200 MHz Measurements | 2.16 | 4.33 |
| 3 Meter Vertical Measurements 200-1000 MHz | 2.99 | 5.97 |
| 10 Meter Horizontal Measurements 30-200 MHz | 2.07 | 4.15 |
| 10 Meter Vertical Measurements 30-200 MHz | 2.06 | 4.13 |
| 10 Meter Horizontal Measurements 200-1000 MHz | 2.32 | 4.64 |
| 10 Meter Vertical Measurements 200-1000 MHz | 2.33 | 4.66 |
| 3 Meter Measurements 1-6 GHz | 2.57 | 5.14 |
| 3 Meter Measurements 6-18 GHz | 2.58 | 5.16 |
| AC Line Conducted | 1.72 | 3.43 |



Annex B Rogers Labs Test Equipment List

| List of Test Equipment | Calibration Date |
|---|------------------|
| Spectrum Analyzer: Rohde & Schwarz ESU40 | 5/13 |
| Spectrum Analyzer: HP 8562A, HP Adapters: 11518, 11519, and 11520 Mixers: 11517A, 11970A, 11970K, 11970U, 11970V, 11970W | 5/13 |
| Spectrum Analyzer: HP 8591EM | 5/13 |
| Antenna: EMCO Biconilog Model: 3143 | 5/13 |
| Antenna: Sunol Biconilog Model: JB6 | 10/13 |
| Antenna: EMCO Log Periodic Model: 3147 | 10/13 |
| Antenna: Com Power Model: AH-118 | 10/13 |
| Antenna: Com Power Model: AH-840 | 10/13 |
| Antenna: Antenna Research Biconical Model: BCD 235 | 10/13 |
| Antenna: EMCO 6509 | 10/13 |
| LISN: Compliance Design Model: FCC-LISN-2.Mod.cd, 50 µHy/50 ohm/0.1 µf | 10/13 |
| R.F. Preamp CPPA-102 | 10/13 |
| Attenuator: HP Model: HP11509A | 10/13 |
| Attenuator: Mini Circuits Model: CAT-3 | 10/13 |
| Attenuator: Mini Circuits Model: CAT-3 | 10/13 |
| Cable: Belden RG-58 (L1) | 10/13 |
| Cable: Belden RG-58 (L2) | 10/13 |
| Cable: Belden 8268 (L3) | 10/13 |
| Cable: Time Microwave: 4M-750HF290-750 | 10/13 |
| Cable: Time Microwave: 10M-750HF290-750 | 10/13 |
| Frequency Counter: Leader LDC825 | 2/14 |
| Oscilloscope Scope: Tektronix 2230 | 2/14 |
| Wattmeter: Bird 43 with Load Bird 8085 | 2/14 |
| Power Supplies: Sorensen SRL 20-25, SRL 40-25, DCR 150, DCR 140 | 2/14 |
| R.F. Generators: HP 606A, HP 8614A, HP 8640B | 2/14 |
| R.F. Power Amp 65W Model: 470-A-1010 | 2/14 |
| R.F. Power Amp 50W M185- 10-501 | 2/14 |
| R.F. Power Amp A.R. Model: 10W 1010M7 | 2/14 |
| R.F. Power Amp EIN Model: A301 | 2/14 |
| LISN: Compliance Eng. Model 240/20 | 2/14 |
| LISN: Fischer Custom Communications Model: FCC-LISN-50-16-2-08 | 2/14 |
| Antenna: EMCO Dipole Set 3121C | 2/14 |
| Antenna: C.D. B-101 | 2/14 |
| Antenna: Solar 9229-1 & 9230-1 | 2/14 |
| Audio Oscillator: H.P. 201CD | 2/14 |
| ELGAR Model: 1751 | 2/14 |
| ELGAR Model: TG 704A-3D | 2/14 |
| ESD Test Set 2010i | 2/14 |
| Fast Transient Burst Generator Model: EFT/B-101 | 2/14 |
| Field Intensity Meter: EFM-018 | 2/14 |
| KEYTEK Ecat Surge Generator | 2/14 |
| Shielded Room 5 M x 3 M x 3.0 M | |



Annex C Rogers Qualifications

Scot D. Rogers, Engineer

Rogers Labs, Inc.

Mr. Rogers has approximately 17 years experience in the field of electronics. Engineering experience includes six years in the automated controls industry and remaining years working with the design, development and testing of radio communications and electronic equipment.

Positions Held

Systems Engineer: A/C Controls Mfg. Co., Inc. 6 Years

Electrical Engineer: Rogers Consulting Labs, Inc. 5 Years

Electrical Engineer: Rogers Labs, Inc. Current

Educational Background

- 1) Bachelor of Science Degree in Electrical Engineering from Kansas State University.
- 2) Bachelor of Science Degree in Business Administration Kansas State University.
- 3) Several Specialized Training courses and seminars pertaining to Microprocessors and Software programming.

Scot D. Rogers



NVLAP Lab Code 200087-0

Annex D FCC Site Registration Letter

FEDERAL COMMUNICATIONS COMMISSION

**Laboratory Division
7435 Oakland Mills Road
Columbia, MD 21046**

June 28, 2013

Registration Number: 90910

Rogers Labs, Inc.
4405 West 259th Terrace,
Louisburg, KS 66053

Attention: Scot Rogers,

Re: Measurement facility located at Louisburg
3 & 10 meter site
Date of Renewal: June 28, 2013

Dear Sir or Madam:

Your request for renewal of the registration of the subject measurement facility has been received. The information submitted has been placed in your file and the registration has been renewed. The name of your organization will remain on the list of facilities whose measurement data will be accepted in conjunction with applications for Certification under Parts 15 or 18 of the Commission's Rules. Please note that the file must be updated for any changes made to the facility and the registration must be renewed at least every three years.

Measurement facilities that have indicated that they are available to the public to perform measurement services on a fee basis may be found on the FCC website www.fcc.gov under E-Filing, OET Equipment Authorization Electronic Filing, Test Firms.

Sincerely,

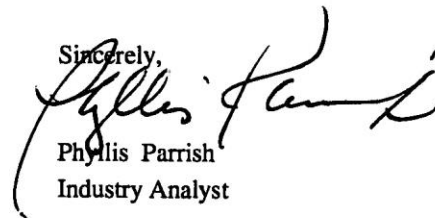

Phyllis Parrish
Industry Analyst

Rogers Labs, Inc.
4405 W. 259th Terrace
Louisburg, KS 66053
Phone/Fax: (913) 837-3214
Revision 1

Mikrotikls SIA
Model: RouterBOARD R2SHPn
Test #: 140320
Test to: CFR47 (15.247)
File: Mikrotikls R2SHPn TstRpt 140320

SN: 3796FFFC1C29/221
FCC ID#: TV7R2SHPN
Date: April 1, 2014
Page 38 of 39



NVLAP Lab Code 200087-0

Annex E Industry Canada Site Registration Letter

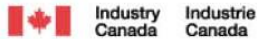

June 19, 2013

OUR FILE: 46405-3041

Submission No: 168037

Rogers Labs Inc.
4405 West 259th Terrace
Louisburg
KS, USA
66053

Attention: Mr. Scot D. Rogers

Dear Sir:

The Bureau has received your application for the renewal of 3/10m OATS. Be advised that the information received was satisfactory to Industry Canada. The following number(s) is now associated to the site(s) for which registration / renewal was sought (**Site# 3041A-1**). Please reference the appropriate site number in the body of test reports containing measurements performed on the site. In addition, please keep for your records the following information;

- The company address code associated to the site(s) located at the above address is: **3041A**

Furthermore, to obtain or renew a unique site number, the applicant shall demonstrate that the site has been accredited to ANSI C63.4-2003 or later. A scope of accreditation indicating the accreditation by a recognized accreditation body to ANSI C63.4-2003 or later shall be accepted. Please indicate in a letter the previous assigned site number if applicable and the type of site (example: 3 metre OATS or 3 metre chamber). If the test facility is not accredited to ANSI C63.4-2003 or later, the test facility shall submit test data demonstrating full compliance with the ANSI standard. The Bureau will evaluate the filing to determine if recognition shall be granted.

The frequency for re-validation of the test site and the information that is required to be filed or retained by the testing party shall comply with the requirements established by the accrediting organization. However, in all cases, test site re-validation shall occur on an interval not to **exceed three years**. There is no fee or form associated with an OATS filing. OATS submissions are encouraged to be submitted electronically to the Bureau using the following URL;

http://strategis.ic.gc.ca/epic/internet/inceb-bhst.nsf/en/h_tt00052e.html.

If you have any questions, you may contact the Bureau by e-mail at certification.bureau@ic.gc.ca Please reference our file and submission number above for all correspondence.

Yours sincerely,

Bill Payn
For: Wireless Laboratory Manager
Certification and Engineering Bureau
3701 Carling Ave., Building 94
P.O. Box 11490, Station "H"
Ottawa, Ontario K2H 8S2
Email: Bill.Payn@ic.gc.ca
Tel. No. (613) 990-3639
Fax. No. (613) 990-4752

Rogers Labs, Inc.
4405 W. 259th Terrace
Louisburg, KS 66053
Phone/Fax: (913) 837-3214
Revision 1

Mikrotikls SIA
Model: RouterBOARD R2SHPn
Test #: 140320
Test to: CFR47 (15.247)
File: Mikrotikls R2SHPn TstRpt 140320

SN: 3796FFFC1C29/221
FCC ID#: TV7R2SHPN
Date: April 1, 2014
Page 39 of 39