

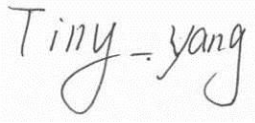

FCC RF Test Report

For

Mikrotikls SIA

Test Standards:	<u>FCC 47 CFR Part 2, 22(H), 24(E)</u>
Product Description:	LTE Mini PCIe card R11e-LTE6
Brand Name:	Mikrotik
Model Name:	R11e-LTE6
Additional Model:	N/A
FCC ID:	TV7R11ELTE6
Classification	PCS Licensed Transmitter (PCB)
Report No.:	<u>EC1812017F01</u>
Tested Date:	<u>2018-12-20 to 2019-02-26</u>
Issued Date:	<u>2019-02-26</u>
Tested/ Prepared By:	 _____ Tiny Yang/ Engineer
Approved By:	 _____ Bacon Wu / RF Manager

Hunan Ecloud Testing Technology Co., Ltd.
Building A1, Changsha E Center, No. 18 Xiangtai Avenue, Liuyang Economic and
Technological Development Zone, Hunan, P.R.C
Tel.: +86-731-89634887 Fax.: +86-731-89634887
www.hn-ecloud.com

Note: The test results in this report apply exclusively to the tested model / sample. Without written approval of Hunan Ecloud Testing Technology Co., Ltd., the test report shall not be reproduced except in full.

Report Revise Record

Report Version	Revise Time	Issued Date	Valid Version	Notes
V1.0	/	2019.02.26	Valid	Original Report

TABLE OF CONTENTS

REPORT REVISE RECORD	2
SUMMARY OF TEST RESULT.....	4
1 TEST LABORATORY	5
1.1 Test facility.....	5
2 GENERAL DESCRIPTION	6
2.1 Applicant	6
2.2 Manufacturer	6
2.3 Product Feature of Equipment Under Test.....	6
2.4 Product Specification of Equipment Under Test	8
2.5 Modification of EUT	8
2.6 Applicable Standards.....	9
3 TEST CONFIGURATION OF EQUIPMENT UNDER TEST	10
3.1 Test Mode.....	10
3.2 Connection Diagram of Test System.....	11
3.3 Support Unit used in test configuration	11
3.4 Measurement Results Explanation Example.....	12
4 CONDUCTED TEST RESULT	13
4.1 Measuring Instruments	13
4.2 Conducted Output Power and ERP/EIRP	13
4.3 Peak-to-Average Ratio	17
4.4 99% Occupied Bandwidth and 26dB Bandwidth Measurement.....	18
4.5 Conducted Band Edge	20
4.6 Conducted Spurious Emission	22
4.7 Frequency Stability	24
5 RADIATED TEST ITEMS.....	25
5.1 Measuring Instruments	25
5.2 Field Strength of Spurious Radiation Measurement	25
6 LIST OF MEASURING EQUIPMENT	28
7 UNCERTAINTY OF EVALUATION	29
APPENDIX A. TEST RESULTS OF CONDUCTED TEST	
APPENDIX B. TEST RESULTS OF RADIATED TEST	
APPENDIX C. TEST SETUP PHOTOGRAPHS	

SUMMARY OF TEST RESULT

Report Section	FCC Rule	Description	Limit	Result	Remark
4.2	§2.1046	Conducted Output Power	Reporting Only	PASS	-
	§22.913(a)(2)	Effective Radiated Power	< 7 Watts	PASS	-
	§24.232(c)	Effective Isotropic Radiated Power	< 2 Watts	PASS	-
4.3	§22.913(d) §24.232(d)	Peak-to-Average Ratio	< 13 dB	PASS	-
4.4	§2.1049 §22.917(b) §24.238(b)	Occupied Bandwidth	Reporting Only	PASS	-
4.5	§2.1051 §22.917(a) §24.238(a)	Band Edge Measurement	< 43+10log10(P[Watts])	PASS	-
4.6	§2.1051 §22.917(a) §24.238(a)	Conducted Emission	< 43+10log10(P[Watts])	PASS	-
4.7	§2.1055 §22.355	Frequency Stability for Temperature & Voltage	< 2.5 ppm	PASS	-
	§2.1055 §24.235		Within Authorized Band		
5.5	§2.1053 §22.917(a) §24.238(a)	Field Strength of Spurious Radiation	< 43+10log10(P[Watts])	PASS	Under limit -28.91 dB at 2472.6 MHz

1 Test Laboratory

1.1 Test facility

CNAS (accreditation number: L11138)

Hunan Ecloud Testing Technology Co., Ltd. has obtained the accreditation of China National Accreditation Service for Conformity Assessment (CNAS).

FCC (Designation number: CN1244 , Test Firm Registration Number: 793308)

Hunan Ecloud Testing Technology Co., Ltd. has been listed on the US Federal Communications Commission list of test facilities recognized to perform electromagnetic emissions measurements.

ISED(CAB identifier: CN0012)

Hunan Ecloud Testing Technology Co., Ltd. has been listed on the Wireless Device Testing Laboratories list of innovation, Science and Economic Development Canada to test to Canadian radio equipment requirements.

A2LA (Certificate Number: 4895.01)

Hunan Ecloud Testing Technology Co., Ltd. has been listed by American Association for Laboratory Accreditation to perform electromagnetic emission measurement.

2 General Description

2.1 Applicant

Mikrotiks SIA
 Brivibas gatve 214i, Riga, LV-1039 LATVIA

2.2 Manufacturer

Mikrotiks SIA
 Brivibas gatve 214i, Riga, LV-1039 LATVIA

2.3 Product Feature of Equipment Under Test

Product Feature	
Equipment	LTE Mini PCIe card R11e-LTE6
Brand Name	Mikrotik
Model Name	R11e-LTE6
Additional Model	N/A
FCC ID	TV7R11ELTE6
Nominal Voltage	3.8 Vdc (From Test fixture)
Extreme Voltage	DC 3.2V and DC 4.3V
Extreme Temperature	-40°C and 80°C
Modulation Type	GSM GSMK, 8PSK
	WCDMA BPSK
	LTE QPSK,16QAM
Operating frequency	GSM 824.2 MHz ~ 848.8 MHz (FOR GSM 850) 1850.2 MHz ~ 1909.8MHz (FOR DCS 1900)
	WCDMA 826.4 MHz ~ 846.6 MHz (FOR WCDMA 850) 1852.4 MHz ~ 1907.6 MHz (FOR WCDMA 1900)
	LTE LTE Band 2: 1805.7 MHz ~ 1909.3MHz LTE Band 5: 824.7 MHz ~ 848.3 MHz LTE Band 7: 2502.5 MHz ~ 2567.5 MHz LTE Band 12: 699.7 MHz ~ 715.3 MHz LTE Band 17: 706.5 MHz ~ 713.5 MHz LTE Band 25: 1850.7MHz ~ 1914.3 MHz LTE Band 26: 824.7MHz ~ 848.3 MHz LTE Band 38: 2572.5 MHz ~ 2617.5 MHz LTE Band 39: 1882.5 MHz ~ 1907.5 MHz LTE Band 40: 2307.5 MHz ~ 2312.5 MHz & 2352.5MHz~2357.5MHz

	LTE Band 41: 2498.5 MHz ~ 2687.5 MHz
HW Version	M26H_1_10
SW Version	R11e_LTE6
EUT Stage	Production Unit

Remark:

1. The above EUT's information was declared by manufacturer. Please refer to the specifications or user's manual for more detailed description.
2. The EUT was investigated in three orthogonal orientations X/Y/Z on antennas. For Main antenna, it was determined that worst-case orientation Y (Landscape) orientation.

2.4 Product Specification of Equipment Under Test

Standards-related Product Specification	
Tx Frequency	GSM/GPRS: 850: 824.2 MHz ~ 848.8 MHz 1900: 1850.2 MHz ~ 1909.8MHz WCDMA: Band V: 826.4 MHz ~ 846.6 MHz Band II: 1852.4 MHz ~ 1907.6 MHz
Rx Frequency	GSM/GPRS: 850: 869.2 MHz ~ 893.8 MHz 1900: 1930.2 MHz ~ 1989.8 MHz WCDMA: Band V: 871.4 MHz ~ 891.6 MHz Band II: 1932.4 MHz ~ 1987.6 MHz
Maximum EIRP Power	GSM/GPRS: 850: 37.41 dBm 1900: 32.50 dBm WCDMA: Band V: 27.24 dBm Band II: 25.03 dBm
Antenna Type	Omni Antenna
Antenna Gain (Main)	GSM/GPRS: 850: 4.83 dBi 1900: -0.21 dBi WCDMA: Band V: 4.83 dBi Band II: -0.21 dBi
Antenna Gain (AUX -Only RX)	GSM/GPRS: 850: 4.83 dBi 1900: -0.21 dBi WCDMA: Band V: 4.83 dBi Band II: -0.21 dBi
Type of Modulation	GSM: GMSK GPRS: GMSK EDGE: GMSK / 8PSK WCDMA: QPSK (Uplink) HSDPA: QPSK (Uplink) HSUPA: QPSK (Uplink)

2.5 Modification of EUT

No modifications are made to the EUT during all test items.

2.6 Applicable Standards

According to the specifications of the manufacturer, the EUT must comply with the requirements of the following standards:

- ♦ 47 CFR Part 2, 22(H), 24(E)
- ♦ ANSI / TIA / EIA-603-E-2016
- ♦ ANSI C63.26-2015
- ♦ FCC KDB 971168 D01 Power Meas. License Digital Systems v03r01

Remark:

1. All test items were verified and recorded according to the standards and without any deviation during the test.
2. This EUT has also been tested and complied with the requirements of FCC Part 15, Subpart B, recorded in a separate test report.

3 Test Configuration of Equipment Under Test

3.1 Test Mode

Antenna port conducted and radiated test items were performed according to KDB 971168 D01 Power Meas. License Digital Systems v03r01 with maximum output power.

Radiated measurements were performed with rotating EUT in different three orthogonal test planes to find the maximum emission.

Radiated emissions were investigated from 30 MHz to 10th harmonic.

Test modes are chosen to be reported as the worst case configuration below:

Test Modes		
Band	Radiated TCs	Conducted TCs
GSM 850	<ul style="list-style-type: none">■ GPRS Link■ EDGE class 8 Link	<ul style="list-style-type: none">■ GPRS Link■ EDGE class 8 Link
GSM 1900	<ul style="list-style-type: none">■ GPRS Link■ EDGE class 8 Link	<ul style="list-style-type: none">■ GPRS Link■ EDGE class 8 Link
WCDMA Band V	<ul style="list-style-type: none">■ RMC 12.2Kbps Link	<ul style="list-style-type: none">■ RMC 12.2Kbps Link
WCDMA Band II	<ul style="list-style-type: none">■ RMC 12.2Kbps Link	<ul style="list-style-type: none">■ RMC 12.2Kbps Link
WCDMA Band IV	<ul style="list-style-type: none">■ RMC 12.2Kbps Link	<ul style="list-style-type: none">■ RMC 12.2Kbps Link

3.2 Connection Diagram of Test System

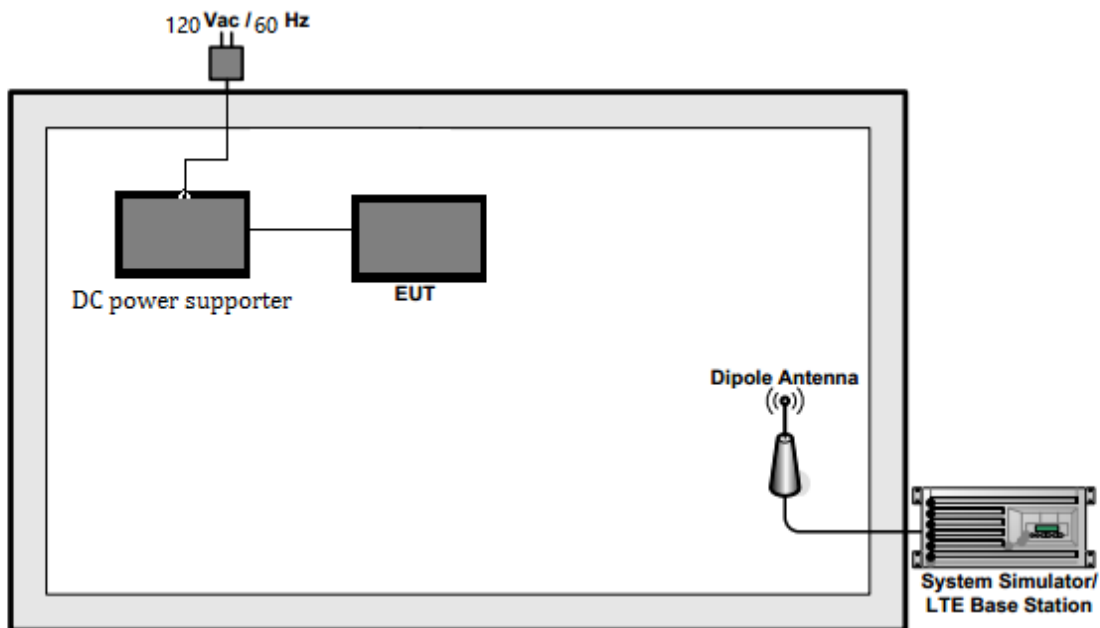

Radiated Setup

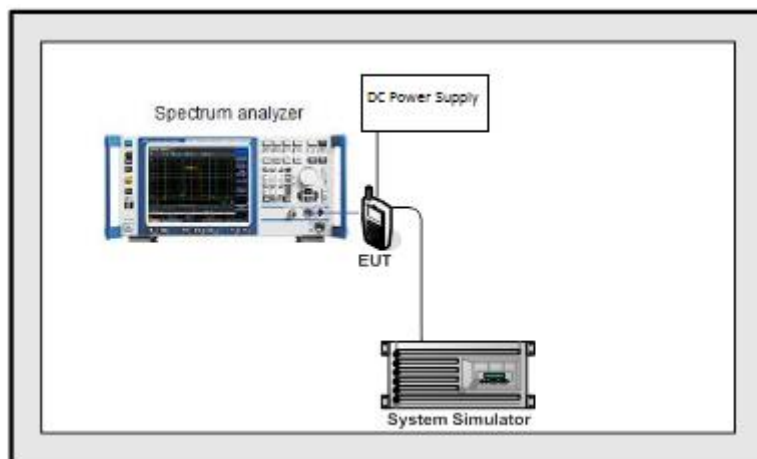

Conducted Setup

3.3 Support Unit used in test configuration

Item	Equipment	Trade Name	Model No.	FCC ID	Data Cable	Power Cord
1.	System Simulator	R&S	CMU 500	N/A	N/A	Unshielded, 1.8 m
2.	DC Power Supply	Keysight	E3642A	N/A	N/A	Unshielded, 1.8 m

3.4 Measurement Results Explanation Example

For all conducted test items:

The offset level is set in the spectrum analyzer to compensate the RF cable loss and attenuator factor between RF conducted output port and spectrum analyzer. With the offset compensation, the spectrum analyzer reading level will be exactly the RF output level.

The spectrum analyzer offset is derived from RF cable loss and attenuator factor.

Offset = RF cable loss + attenuator factor.

The following shows an offset computation example with RF cable loss 4.5 dB and a 10dB attenuator.

Example :

$$\begin{aligned} \text{Offset(dB)} &= \text{RF cable loss(dB)} + \text{attenuator factor(dB)}. \\ &= 4.5 + 10 = 14.5 \text{ (dB)} \end{aligned}$$

4 Conducted Test Result

4.1 Measuring Instruments

See list of measuring instruments of this test report.

4.2 Conducted Output Power and ERP/EIRP

4.2.1 Description of the Conducted Output Power and ERP/EIRP

A system simulator was used to establish communication with the EUT. Its parameters were set to enforce EUT transmitting at the maximum power. The measured power in the radio frequency on the transmitter output terminals shall be reported.

The ERP of mobile transmitters must not exceed 7 Watts for GSM850 and WCDMA Band V

The EIRP of mobile transmitters must not exceed 2 Watts for GSM1900 and WCDMA Band II

The EIRP of mobile transmitters must not exceed 1 Watts for WCDMA Band IV

According to KDB 412172 D01 Power Approach,

$EIRP = P_T + G_T - L_C$, $ERP = EIRP - 2.15$, Where

P_T = transmitter output power in dBm

G_T = gain of the transmitting antenna in dBi

L_C = signal attenuation in the connecting cable between the transmitter and antenna in dB

4.2.2 Test Procedures

GSM

Using CMW500 Communication Test Set

Function: Menu select > GSM Mobile Station > GSM 850/900/1800/1900

Press Connection control to choose the different menus

Press RESET > choose all to reset all settings

Connection Press Signal Off to turn off the signal and change settings
 Network Support > GSM+GPRS or GSM+EGPRS
 Main Service > Packet Data
 Service selection > Test Mode A – Auto Slot Config. Off

MS Signal Press Slot Config bottom on the right twice to select and change the number of
 time slots and power setting

> Slot configuration > Uplink/Gamma

> 33 dBm for GPRS 850/900

> 27 dBm for EGPRS 850/900

> 30 dBm for GPRS1800/1900

> 26 dBm for EGPRS1800/1900

BS Signal	Enter the same channel number for TCH channel (test channel) and BCCH Channel
	Frequency Offset > + 0 Hz
	Mode > BCCH and TCH
	BCCH Level > -85 dBm (May need to adjust if link is not stable)
	BCCH Channel > choose desire test channel [Enter the same channel number for TCH channel (test channel) and BCCH channel]
	Channel Type > Off
	P0> 4 dB
	Slot Config > Unchanged (if already set under MS Signal)
	TCH > choose desired test channel
	Hopping > Off
	Main Timeslot > 3 (Default)
Network	Coding Scheme > CS 4 (GPRS) and MCS5-9 (EGPRS)
	Bit Stream > 2E9-1PSR Bit Pattern
AF/RF Connection	Enter appropriate offsets for Ext. Att. Output and Ext. Att. Input Press Signal On to turn on the signal and change settings

UMTS REL99

The following summary of these settings are illustrated below:

	Mode	Rel99
	Subtest	-
WCDMA General Setting	Loopback Mode	Test Mode 2
	Rel99 RMC	12.2kbps RMC
	HSDPA FRC	Not Applicable
	HSUPA Test	Not Applicable
	Power Control Algorithm	Algorithm2
	β_c	Not Applicable
	β_d	Not Applicable
	β_{ec}	Not Applicable
	β_c/β_d	8/15
	β_{hs}	Not Applicable
	β_{ed}	Not Applicable

HSPA REL 6 (HSDPA & HSUPA)

The following summary of these settings are illustrated below:

	Mode	Rel6 HSUPA	Rel6 HSUPA	Rel6 HSUPA	Rel6 HSUPA	Rel6 HSUPA	
	Subtest	1	2	3	4	5	
WCDMA General Settings	Loopback Mode	Test Mode 1					
	Rel99 RMC	12.2kbps RMC					
	HSDPA FRC	H-Set1					
	HSUPA Test	HSUPA Loopback					
	Power Control Algorithm	Algorithm2					
	β_c	11/15	6/15	15/15	2/15	15/15	
	β_d	15/15	15/15	9/15	15/15	0	
	β_{ec}	209/225	12/15	30/15	2/15	5/15	
	β_c/β_d	11/15	6/15	15/9	2/15	15/1	
	β_{hs}	22/15	12/15	30/15	4/15	5/15	
	β_{ed}	1309/225	94/75	47/15	56/75	47/15	
	CM (dB)	1	3	2	3	1	
MPR (dB)	0	2	1	2	0		
HSDPA Specific Settings	DACK	8					
	DNAK	8					
	DCQI	8					
	Ack-Nack repetition factor	3					
	CQI Feedback (Table 5.2B.4)	4ms					
	CQI Repetition Factor (Table 5.2B.4)	2					
$A_{hs} = \beta_{hs}/\beta_c$	30/15						
HSUPA Specific Settings	D E-DPCCH	6	8	8	5	7	
	DHARQ	0	0	0	0	0	
	AG Index	20	12	15	17	12	
	ETFCI	75	67	92	71	67	
	Associated Max UL Data Rate	242.1	174.9	482.8	205.8	308.9	
	Reference E_TFCIs	E-TFCI11				E-TFCI11	
		E-TFCI PO 4				E-TFCI PO 4	
E-TFCI 67					E-TFCI 67		
E-TFCI PO 18					E-TFCI PO 18		
E-TFCI 71				E-TFCI 11	E-TFCI 71		
E-TFCI PO 23				E-TFCI PO 4	E-TFCI PO 23		
E-TFCI 75				E-TFCI 92	E-TFCI 75		
E-TFCI PO 26			E-TFCI PO18	E-TFCI PO 26			

4.2.3 Test Setup

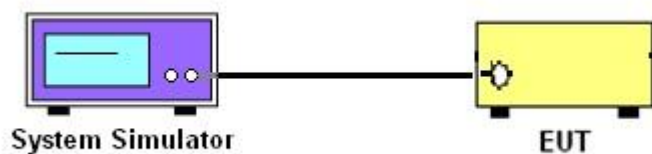

4.2.4 Test Results

Refer to Appendix A of this test report.

4.3 Peak-to-Average Ratio

4.3.1 Description of the PAR Measurement

A peak to average ratio measurement is performed at the conducted port of the EUT. For WCDMA signals, the spectrum analyzers Complementary Cumulative Distribution Function (CCDF) measurement profile is used to determine the largest deviation between the average and the peak power of the EUT in a given bandwidth. The CCDF curve shows how much time the peak waveform spends at or above a given average power level. The percent of time the signal spends at or above the level defines the probability for that particular power level. For GSM signals, an average and a peak trace are used on a spectrum analyzer to determine the largest deviation between the average and the peak power of the EUT in a bandwidth greater than the emission bandwidth. The traces are generated with the spectrum analyzer set to zero span mode.

4.3.2 Limit

when the transmitter power is measured in terms of average value, the peak-to-average ratio of the power shall not exceed 13 dB.

4.3.3 Test Procedures

1. The testing follows ANSI C63.26 Section 5.2.3.4 (CCDF)
2. The EUT was connected to spectrum analyzer and system simulator via a power divider.
3. Set EUT to transmit at maximum output power.
4. The signal analyzer's CCDF measurement profile is enabled
5. Frequency = carrier center frequency
6. Measurement BW > Emission bandwidth of signal
7. When the duty cycle is less than 98%, then signal gating will be implemented on the spectrum analyzer by triggering from the system simulator.
8. Set the CCDF (Complementary Cumulative Distribution Function) option of the spectrum analyzer.
Record the maximum PAPR level associated with a probability of 0.1%.

4.3.4 Test Setup

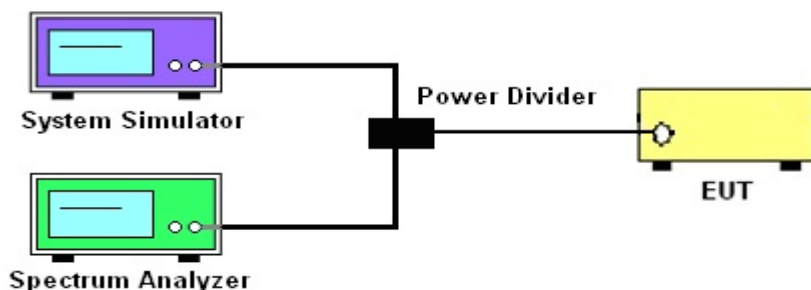

4.3.5 Test Results

Refer to Appendix A of this test report.

4.4 99% Occupied Bandwidth and 26dB Bandwidth Measurement

4.4.1 Description of 99% Occupied Bandwidth and 26dB Bandwidth Measurement

The occupied bandwidth is the width of a frequency band such that, below the lower and above the upper frequency limits, the mean powers emitted are each equal to a specified percentage 0.5% of the total mean transmitted power.

The 26 dB emission bandwidth is defined as the frequency range between two points, one above and one below the carrier frequency, at which the spectral density of the emission is attenuated 26 dB below the maximum in-band spectral density of the modulated signal. Spectral density (power per unit bandwidth) is to be measured with a detector of resolution bandwidth equal to approximately 1.0% of the emission bandwidth.

4.4.2 Test Procedures

- 1.The testing follows Sub clause 5.4.3 of ANSI C63.26-2015
- 2.The EUT was connected to spectrum analyzer and system simulator via a power divider.
- 3.The signal analyzer's automatic bandwidth measurement capability was used to perform the 99% occupied bandwidth and the 26dB bandwidth the bandwidth measurement was not influenced by any intermediate power nulls in the fundamental emission.
- 4.RBW = 1~5% of the expected OBW, VBW \geq 3 x RBW
- 5.Set the detection mode to peak, and the trace mode to max hold.
- 6.Determine the reference value: Set the EUT to transmit a modulated signal. Allow the trace to stabilize. Set the spectrum analyzer marker to the highest level of the displayed trace.(this is the reference value)
- 7.Determine the "-26 dB down amplitude" as equal to (Reference Value – X).
- 8.Place two markers, one at the lowest and the other at the highest frequency of the envelope of the spectral display such that each marker is at or slightly below the "-X dB down amplitude" determined in step 6. If a marker is below this "-X dB down amplitude" value it shall be placed as close as possible to this value. The OBW is the positive frequency difference between the two markers.
- 9.Use the 99 % power bandwidth function of the spectrum analyzer and report the measured bandwidth.

4.4.3 Test Setup

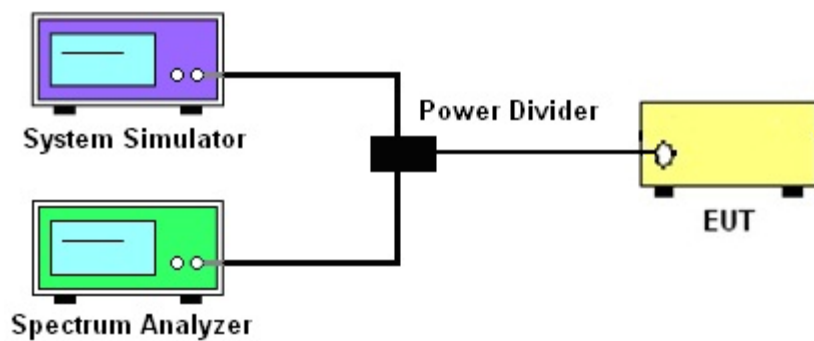

4.4.4 Test Results

Refer to Appendix A of this test report.

4.5 Conducted Band Edge

4.5.1 Description of Conducted Band Edge Measurement

The transmitter output was connected to a calibrated coaxial cable, attenuator and Spectrum analyser, the other end of which was connected to a Base Station Simulator. The Base Station Simulator was set to force the EUT to its maximum power setting. The tests were performed at three frequencies (low channel and high channel).in the 1MHz bands immediately outside and adjacent to the frequency block a resolution bandwidth of 100kHz or 1% of the emission bandwidth of the fundamental emission of the transmitter may be employed. The EUT emission bandwidth is measured as the width of the signal between two points, outside of which all emission are attenuated at least 26dB below the transmitter power. The video bandwidth of the spectrum analyzer was set at thrice the resolution bandwidth. Detector Mode was set to peak or peak hold power.

4.5.2 Limit

FCC: §22.917, §24.238, §27.53

The power of any emission outside of the authorized operating frequency ranges must be attenuated below the transmitting power (P) by a factor of at least $43 + 10 \log (P)$ dB.

4.5.3 Test Procedures

1. The testing follows ANSI C63.26 Section 5.7.
2. The EUT was connected to the spectrum analyzer and system simulator via a power divider.
3. Start and stop frequency were set such that the band edge would be placed in the center of the plot
4. Span was set large enough so as to capture all out of band emissions near the band edge
5. RBW \geq 1% of the emission bandwidth
6. VBW \geq 3 x RBW
7. Detector = RMS
8. Number of sweep points \geq 2 x Span/RBW
9. Trace mode = trace average for continuous emissions, max hold for pulse emissions
10. Sweep time = auto couple
11. The trace was allowed to stabilize
12. The RF fundamental frequency should be excluded against the limit line in the operating frequency band.
13. The limit line is derived from $43 + 10\log(P)$ dB below the transmitter power P(Watts)
= $P(W) - [43 + 10\log(P)]$ (dB)
= $[30 + 10\log(P)]$ (dBm) - $[43 + 10\log(P)]$ (dB)
= -13dBm.

4.5.4 Test Setup

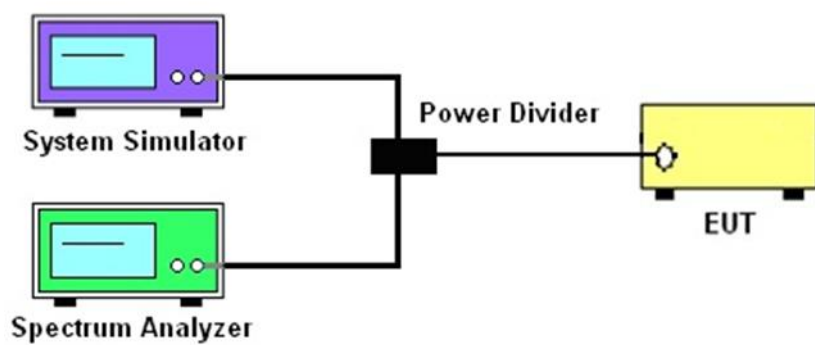

4.5.5 Test Results

Refer to Appendix A of this test report.

4.6 Conducted Spurious Emission

4.6.1 Description of Conducted Spurious Emission Measurement

The transmitter output was connected to a calibrated coaxial cable, attenuator and Spectrum analyzer, the other end of which was connected to a Base Station Simulator. The Base Station Simulator was set to force the EUT to its maximum power setting. The tests were performed at three frequencies (low channel and high channel). The level of the carrier and the various conducted spurious and harmonic frequencies is measured by means of a calibrated spectrum analyzer. The spectrum is scanned from the lowest frequency generated in the equipment up to a frequency including its 10th harmonic. On any frequency outside a licensee's frequency block, the power of any emission shall be attenuated below the transmitter power (P) by at least $43 + 10 \log(P)$ dB. Compliance with these provisions is based on the use of measurement instrumentation employing a resolution bandwidth of 1 MHz or greater. However, in the 1 MHz bands immediately outside and adjacent to the frequency block a resolution bandwidth of at least one percent of the emission bandwidth of the fundamental emission of the transmitter may be employed. The emission bandwidth is defined as the width of the signal between two points, one below the carrier center frequency and one above the carrier center frequency, outside of which all emission are attenuated at least 26 dB below the transmitter power.

4.6.2 Limit

FCC: §22.917, §24.238, §27.53

The power of any emission outside of the authorized operating frequency ranges must be attenuated below the transmitting power (P) by a factor of at least $43 + 10 \log(P)$ dB.

It is measured by means of a calibrated spectrum analyzer and scanned from 30 MHz up to a frequency including its 10th harmonic.

4.6.3 Test Procedures

1. The testing follows ANSI C63.26 section 5.7.
2. The EUT was connected to the spectrum analyzer and system simulator via a power divider.
3. The RF output of EUT was connected to the spectrum analyzer by an RF cable and attenuator. The path loss was compensated to the results for each measurement.
4. The middle channel for the highest RF power within the transmitting frequency was measured.
5. The conducted spurious emission for the whole frequency range was taken.
6. The RF fundamental frequency should be excluded against the limit line in the operating frequency band.
7. The limit line is derived from $43 + 10\log(P)$ dB below the transmitter power P(Watts)
 $= P(W) - [43 + 10\log(P)]$ (dB)
 $= [30 + 10\log(P)]$ (dBm) - $[43 + 10\log(P)]$ (dB)
 $= -13\text{dBm}$.

4.6.4 Test Setup

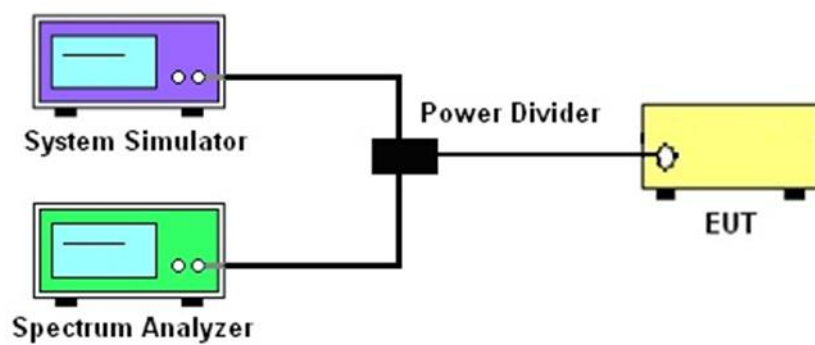

4.6.5 Test Results

Refer to Appendix A of this test report.

4.7 Frequency Stability

4.7.1 Description of Frequency Stability Measurement

FCC §22.355

The carrier frequency shall not depart from the reference frequency in excess of ± 2.5 ppm for mobile stations.

FCC §24.235 & §27.54

The frequency stability shall be sufficient to ensure that the fundamental emission stays within the authorized frequency block.

4.7.2 Test Condition

Temp. = -30° to $+50^{\circ}\text{C}$

Voltage = (85% - 115%)

4.7.3 Test Procedures for Temperature Variation

1. The testing follows ANSI C63.26 section 5.6.4.
2. The EUT was set up in the thermal chamber and connected with the system simulator.
3. With power OFF, the temperature was decreased to -30°C and the EUT was stabilized before testing. Power was applied and the maximum change in frequency was recorded within one minute.
4. With power OFF, the temperature was raised in 10°C steps up to 50°C . The EUT was stabilized at each step for at least half an hour. Power was applied and the maximum frequency change was recorded within one minute.

4.7.4 Test Procedures for Voltage Variation

1. The testing follows ANSI C63.26 section 5.6.5.
2. The EUT was placed in a temperature chamber at $25\pm 5^{\circ}\text{C}$ and connected with the system simulator.
3. The power supply voltage to the EUT was varied from 85% to 115% of the nominal value measured at the input to the EUT.
4. The variation in frequency was measured for the worst case.

4.7.5 Test Setup

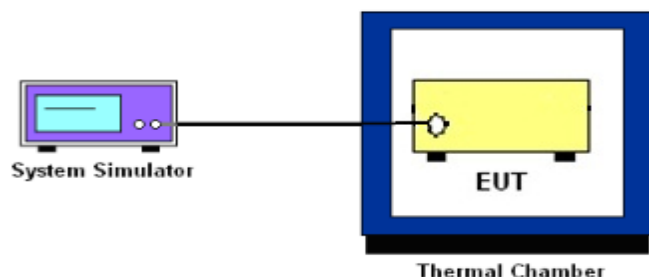

4.7.6 Test Results

Refer to Appendix A of this test report.

5 Radiated Test Items

5.1 Measuring Instruments

See list of measuring instruments of this test report.

5.2 Field Strength of Spurious Radiation Measurement

5.2.1 Description of Field Strength of Spurious Radiated Measurement

FCC: §22.917, §24.238, §27.53

The power of any emission outside of the authorized operating frequency ranges must be attenuated below the transmitting power (P) by a factor of at least $43 + 10 \log (P)$ dB.

5.2.2 Test Procedures

The testing follows FCC KDB 971168 D01 v03r01 Section 5.8 and ANSI / TIA-603-E-2016 Section 2.2.12.

Below 1GHz test procedure as below:

- 1.The EUT was powered ON and placed on a 80cm high table in the chamber. The antenna of the transmitter was extended to its maximum length.
- 2.Make the measurement with the spectrum analyzer's RBW = 100KHz, VBW = 100KHz, taking record of maximum spurious emission.
- 3.The disturbance of the transmitter was maximized on the test receiver display by raising and lowering from 1m to 4m (for the test frequency of below 30MHz, the antenna was tuned to heights 1 meter) the receive antenna and by rotating through 360° the turntable. After the fundamental emission was maximized, a field strength measurement was made.
- 4.Steps 1) and 2) were performed with the EUT and the receive antenna in both vertical and horizontal polarization.
- 5.The transmitter was then removed and replaced with another antenna. The center of the antenna was approximately at the same location as the center of the transmitter.
- 6.A signal at the disturbance was fed to the substitution antenna by means of a non-radiating cable. With both the substitution and the receive antennas horizontally polarized, the receive antenna was raised and lowered to obtain a maximum reading at the test receiver. The level of the signal generator was adjusted until the measured field strength level in step 2) is obtained for this set of conditions.
- 7.The output power into the substitution antenna was then measured.
- 8.Steps 5) and 6) were repeated with both antennas polarized.
- 9.Calculate power in dBm by the following formula:

$$\text{ERP(dBm)} = \text{Pg(dBm)} - \text{cable loss (dB)} + \text{antenna gain (dBd)} - 2.15$$

Where:

P_d is the dipole equivalent power, P_g is the generator output into the substitution antenna, and the antenna gain is the gain of the substitute antenna used relative to either a half-wave dipole (dBd) or an isotropic source (dBi). The substitute level is equal to P_g [dBm] – cable loss [dB]. The calculated

Pd levels are then compared to the absolute spurious emission limit of -13dBm which is equivalent to the required minimum attenuation of $43 + 10\log_{10}(\text{Power [Watts]})$.

Above 1GHz test procedure as below:

1. The EUT was powered ON and placed on a 150cm high table in the chamber. The antenna of the transmitter was extended to its maximum length.
2. Make the measurement with the spectrum analyzer's RBW = 1MHz, VBW = 3MHz, taking record of maximum spurious emission.
3. The disturbance of the transmitter was maximized on the test receiver display by raising and lowering from 1m to 4m (for the test frequency of below 30MHz, the antenna was tuned to heights 1 meter) the receive antenna and by rotating through 360° the turntable. After the fundamental emission was maximized, a field strength measurement was made.
4. Steps 1) and 2) were performed with the EUT and the receive antenna in both vertical and horizontal polarization.
5. The transmitter was then removed and replaced with another antenna. The center of the antenna was approximately at the same location as the center of the transmitter.
6. A signal at the disturbance was fed to the substitution antenna by means of a non-radiating cable. With both the substitution and the receive antennas horizontally polarized, the receive antenna was raised and lowered to obtain a maximum reading at the test receiver. The level of the signal generator was adjusted until the measured field strength level in step 2) is obtained for this set of conditions.
7. The output power into the substitution antenna was then measured.
8. Steps 5) and 6) were repeated with both antennas polarized.
9. Calculate power in dBm by the following formula:

$$\text{EIRP(dBm)} = \text{Pg(dBm)} - \text{cable loss (dB)} + \text{antenna gain (dBd)}$$

Where:

Pd is the dipole equivalent power, Pg is the generator output into the substitution antenna, and the antenna gain is the gain of the substitute antenna used relative to either a half-wave dipole (dBd) or an isotropic source (dBi). The substitute level is equal to $\text{Pg [dBm]} - \text{cable loss [dB]}$. The calculated Pd levels are then compared to the absolute spurious emission limit of -13dBm which is equivalent to the required minimum attenuation of $43 + 10\log_{10}(\text{Power [Watts]})$.

5.2.3 Test Setup

For radiated test from 30MHz to 1GHz

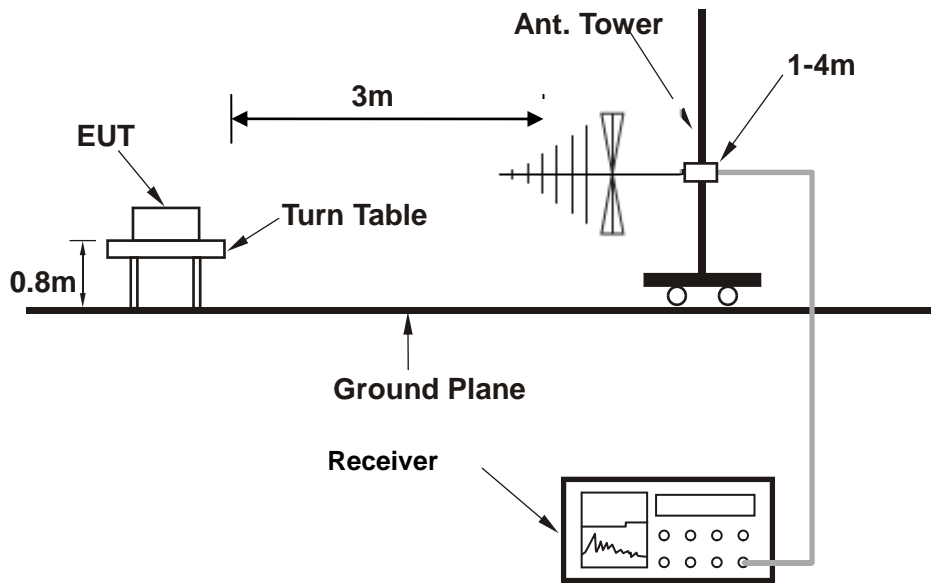

For radiated test above 1GHz

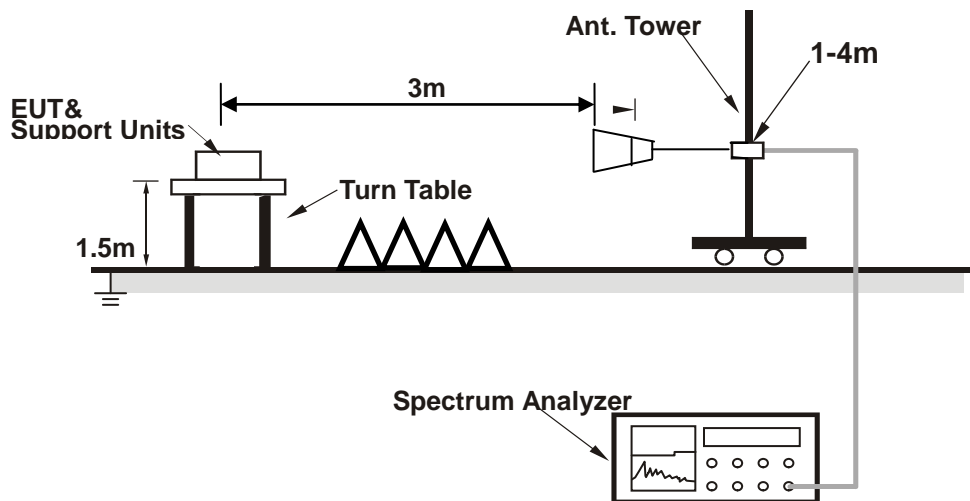

5.2.4 Test Results

Refer to Appendix B of this test report.

6 List of Measuring Equipment

Instrument	Manufacturer	Model No.	Serial No.	Calibration Date	Due Date	Remark
Spectrum Analyzer	Keysight	N9010A	MY56070788	2018/3/2	2019/3/1	Conducted
Base Station	R&S	CMW500	164998	2018/3/17	2019/3/16	Conducted
Thermal Chamber	Sanmtest	SMC-408-CD	2435	2017/5/16	2018/5/15	Conducted
Signal Generator (Interferer)	Keysight	N5182B	MY56200384	2018/4/10	2019/4/09	Conducted
Signal Generator (Blocker)	Keysight	N5171B	MY56200661	2018/3/2	2019/3/1	Conducted

Instrument	Manufacturer	Model No.	Serial No.	Calibration Date	Due Date	Remark
Spectrum Analyzer	R&S	FSV 40	101433	2018/3/14	2019/3/13	Radiation
Amplifier	Sonoma	310	363917	2018/3/6	2019/3/5	Radiation
Amplifier	Schwarzbeck	BBV 9718	327	2018/3/14	2019/3/13	Radiation
Loop Antenna	Schwarzbeck	FMZB 1519 B	1519B-051	2017/3/3	2020/3/2	Radiation
Bilog Antenna	Schwarzbeck	VULB 9168	9168-757	2017/3/3	2020/3/2	Radiation
Horn Antenna	Schwarzbeck	BBHA 9120 D	1677	2017/3/3	2020/3/2	Radiation
Signal Generator (Blocker)	R&S	SMB100A	180717	2018/3/15	2019/3/14	Radiation
Test Software	Auidx	E3	6.111221a	N/A	N/A	Radiation
Filter	Micro-Tronics	BRM 50702	G266	N/A	N/A	Radiation

7 Uncertainty of Evaluation

Uncertainty of Radiated Emission Measurement (30 MHz ~ 1000 MHz)

Measuring Uncertainty for a Level of Confidence of 95% ($U = 2U_c(y)$)	5.0 dB
--	--------

Uncertainty of Radiated Emission Measurement (1GHz ~ 18GHz)

Measuring Uncertainty for a Level of Confidence of 95% ($U = 2U_c(y)$)	4.9dB
--	-------

Uncertainty of Radiated Emission Measurement (18GHz ~ 40GHz)

Measuring Uncertainty for a Level of Confidence of 95% ($U = 2U_c(y)$)	5.1dB
--	-------

Appendix A. Test Results of Conducted Test

Conducted Output Power(Average power)

Conducted Power (*Unit: dBm)						
Band	GSM850			GSM1900		
Channel	128	189	251	512	661	810
Frequency	824.2	836.4	848.8	1850.2	1880.0	1909.8
GPRS class 8	32.50	32.50	32.58	32.71	32.66	32.01
GPRS class 10	32.44	32.49	32.58	32.67	32.62	31.97
GPRS class 11	31.36	31.43	31.54	31.70	31.78	31.28
GPRS class 12	29.79	29.84	29.90	30.74	30.87	30.48
EGPRS class 8	27.24	27.37	27.31	24.81	24.66	24.35
EGPRS class 10	26.01	25.85	25.43	22.63	22.75	21.78
EGPRS class 11	23.75	24.17	23.77	20.78	20.96	19.47
EGPRS class 12	21.68	21.83	21.62	18.58	17.99	17.64

Conducted Power (*Unit: dBm)						
Band	WCDMA Band V			WCDMA Band II		
Channel	4132	4182	4233	9262	9400	9538
Frequency	826.4	836.4	846.6	1852.4	1880	1907.6
RMC 12.2Kbps	22.37	22.14	22.88	25.24	25.06	24.84
HSDPA Subtest-1	21.38	21.69	21.54	22.68	22.79	22.91
HSDPA Subtest-2	21.22	21.82	21.36	21.92	22.05	21.86
HSDPA Subtest-3	20.61	20.50	20.68	20.76	20.81	20.49
HSDPA Subtest-4	21.72	21.66	21.53	22.89	22.60	22.53
HSUPA Subtest-1	22.41	22.40	22.29	22.81	23.01	22.86
HSUPA Subtest-2	22.39	21.52	21.54	22.01	22.12	21.98
HSUPA Subtest-3	21.98	22.13	22.11	22.58	22.77	22.49
HSUPA Subtest-4	20.65	20.74	20.72	20.50	20.68	20.41
HSUPA Subtest-5	22.78	22.56	22.62	23.60	23.43	23.14

Effective Radiated Power

Conducted Power (*Unit: dBm)						
Band	GSM850			GSM1900		
Channel	128	189	251	512	661	810
Frequency	824.2	836.4	848.8	1850.2	1880.0	1909.8
GPRS class 8	37.33	37.33	37.41	32.5	32.45	31.8
GPRS class 10	37.27	37.32	37.41	32.46	32.41	31.76
GPRS class 11	36.19	36.26	36.37	31.49	31.57	31.07
GPRS class 12	34.62	34.67	34.73	30.53	30.66	30.27
EGPRS class 8	32.07	32.2	32.14	24.6	24.45	24.14
EGPRS class 10	30.84	30.68	30.26	22.42	22.54	21.57
EGPRS class 11	28.58	29	28.6	20.57	20.75	19.26
EGPRS class 12	26.51	26.66	26.45	18.37	17.78	17.43

Conducted Power (*Unit: dBm)						
Band	WCDMA Band V			WCDMA Band II		
Channel	4132	4182	4233	9262	9400	9538
Frequency	826.4	836.4	846.6	1852.4	1880	1907.6
RMC 12.2Kbps	27.2	26.97	27.01	25.03	24.85	24.63
HSDPA Subtest-1	26.21	26.52	26.37	22.47	22.58	22.7
HSDPA Subtest-2	26.05	26.65	26.19	21.71	21.84	21.65
HSDPA Subtest-3	25.44	25.33	25.51	20.55	20.6	20.28
HSDPA Subtest-4	26.55	26.49	26.36	22.68	22.39	22.32
HSUPA Subtest-1	27.24	27.23	27.12	22.6	22.8	22.65
HSUPA Subtest-2	27.22	26.35	26.37	21.8	21.91	21.77
HSUPA Subtest-3	26.81	26.96	26.94	22.37	22.56	22.28
HSUPA Subtest-4	20.44	20.53	20.51	20.29	20.47	20.2
HSUPA Subtest-5	22.57	22.35	22.41	23.39	23.22	22.93

A1. GSM

Peak-to-Average Ratio

Test Band	Test Mode	Test Channel	Measured (dbm)	Limit (dbm)	Verdict
GSM850	GPRS	LCH	7.74	13	PASS
		MCH	7.77	13	PASS
		HCH	7.74	13	PASS
	EDGE	LCH	7.74	13	PASS
		MCH	7.77	13	PASS
		HCH	7.74	13	PASS

Test Band	Test Mode	Test Channel	Measured (dbm)	Limit (dbm)	Verdict
GSM1900	GPRS	LCH	7.74	13	PASS
		MCH	7.80	13	PASS
		HCH	8.03	13	PASS
	EDGE	LCH	7.71	13	PASS
		MCH	7.74	13	PASS
		HCH	7.94	13	PASS

Test Band	Test Mode	Test Channel	Measured (db)	Limit (db)	Verdict
WCDMA850	RMC 12.2Kbps	LCH	3.25	13	PASS
		MCH	2.93	13	PASS
		HCH	3.28	13	PASS

Test Band	Test Mode	Test Channel	Measured (db)	Limit (db)	Verdict
WCDMA1900	RMC 12.2Kbps	LCH	2.99	13	PASS
		MCH	3.10	13	PASS
		HCH	2.81	13	PASS

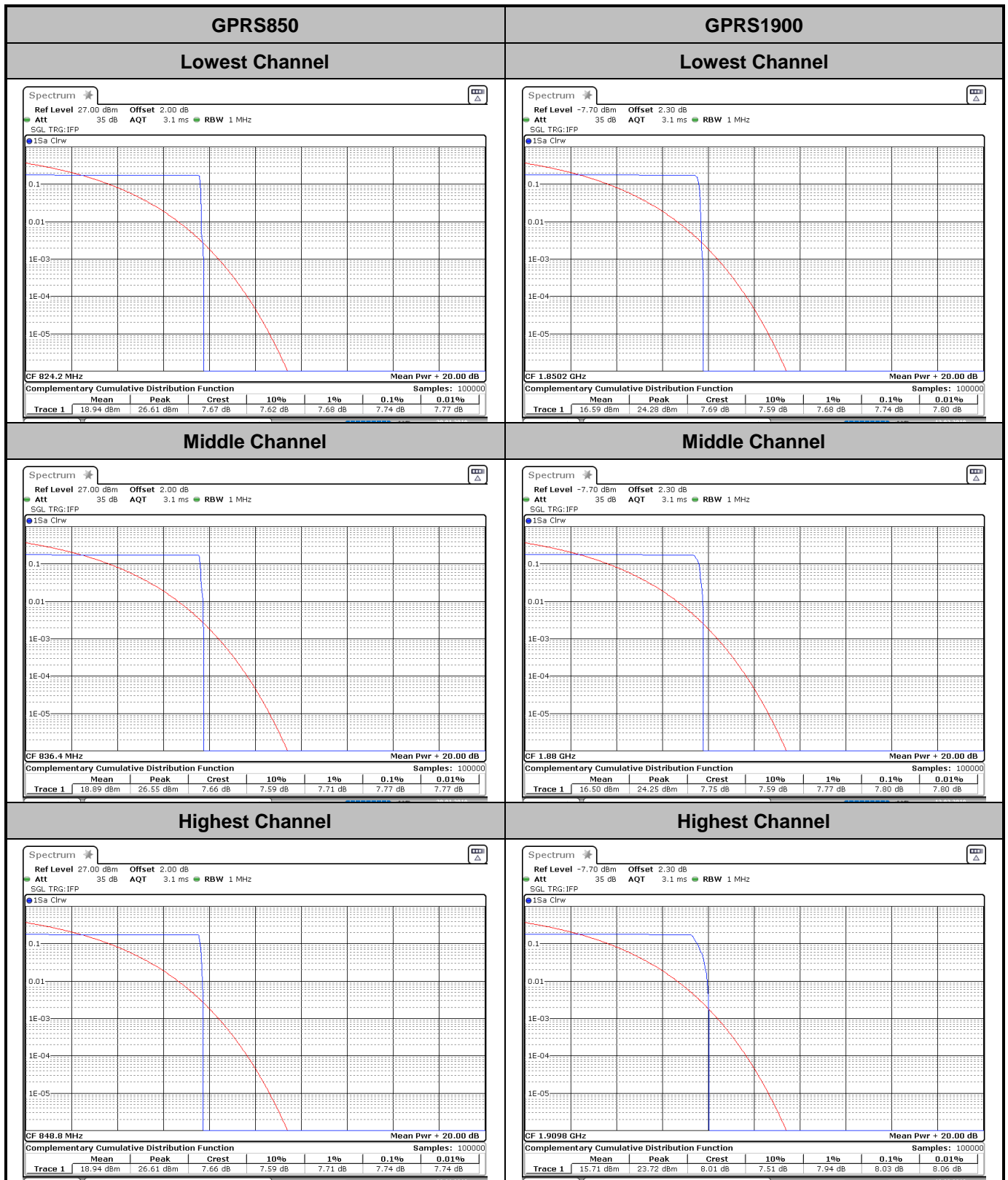

Date: 30.JAN.2019 00:55:10

Date: 13.FEB.2019 15:50:22

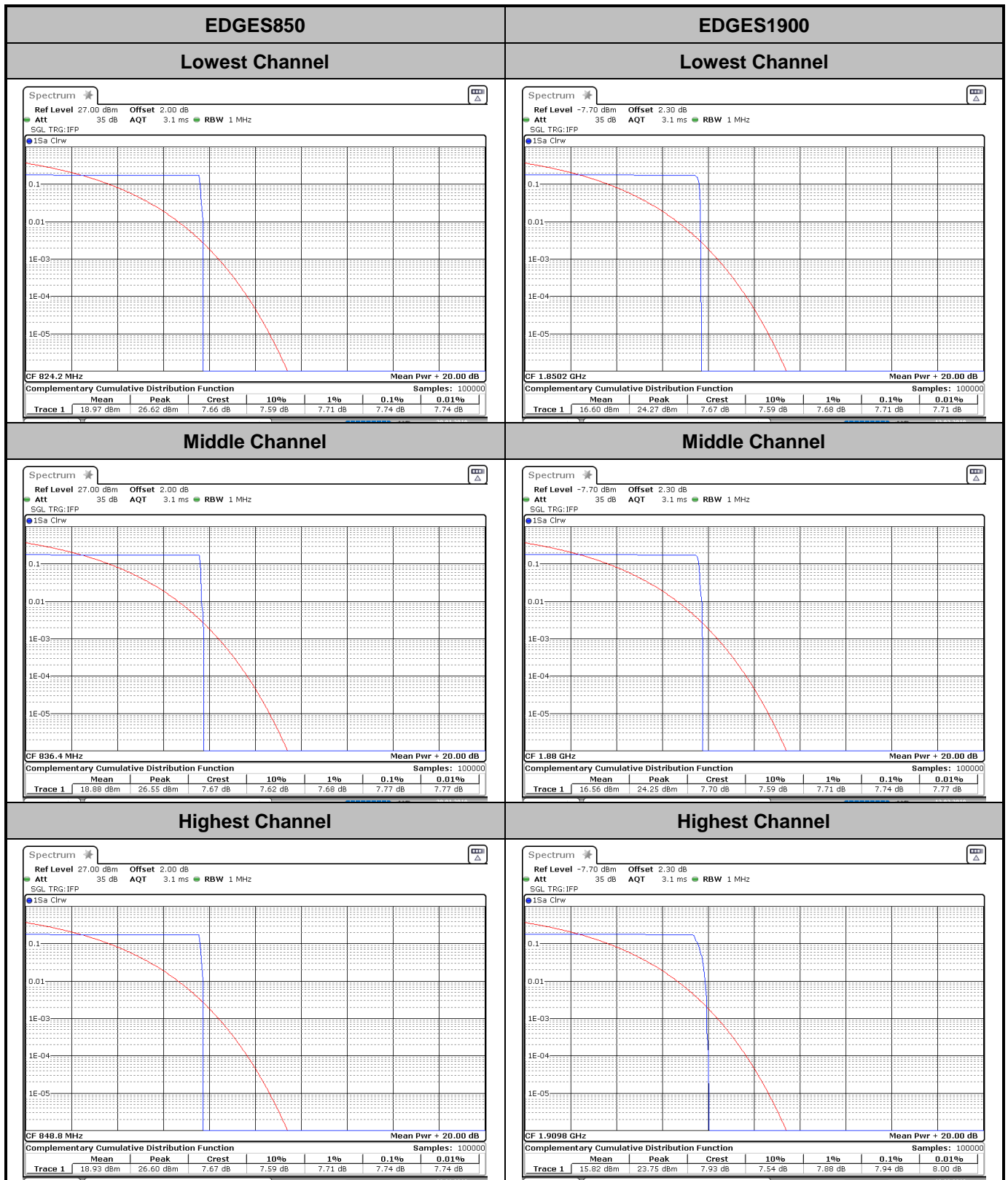

Date: 30.JAN.2019 00:58:28

Date: 13.FEB.2019 15:53:50

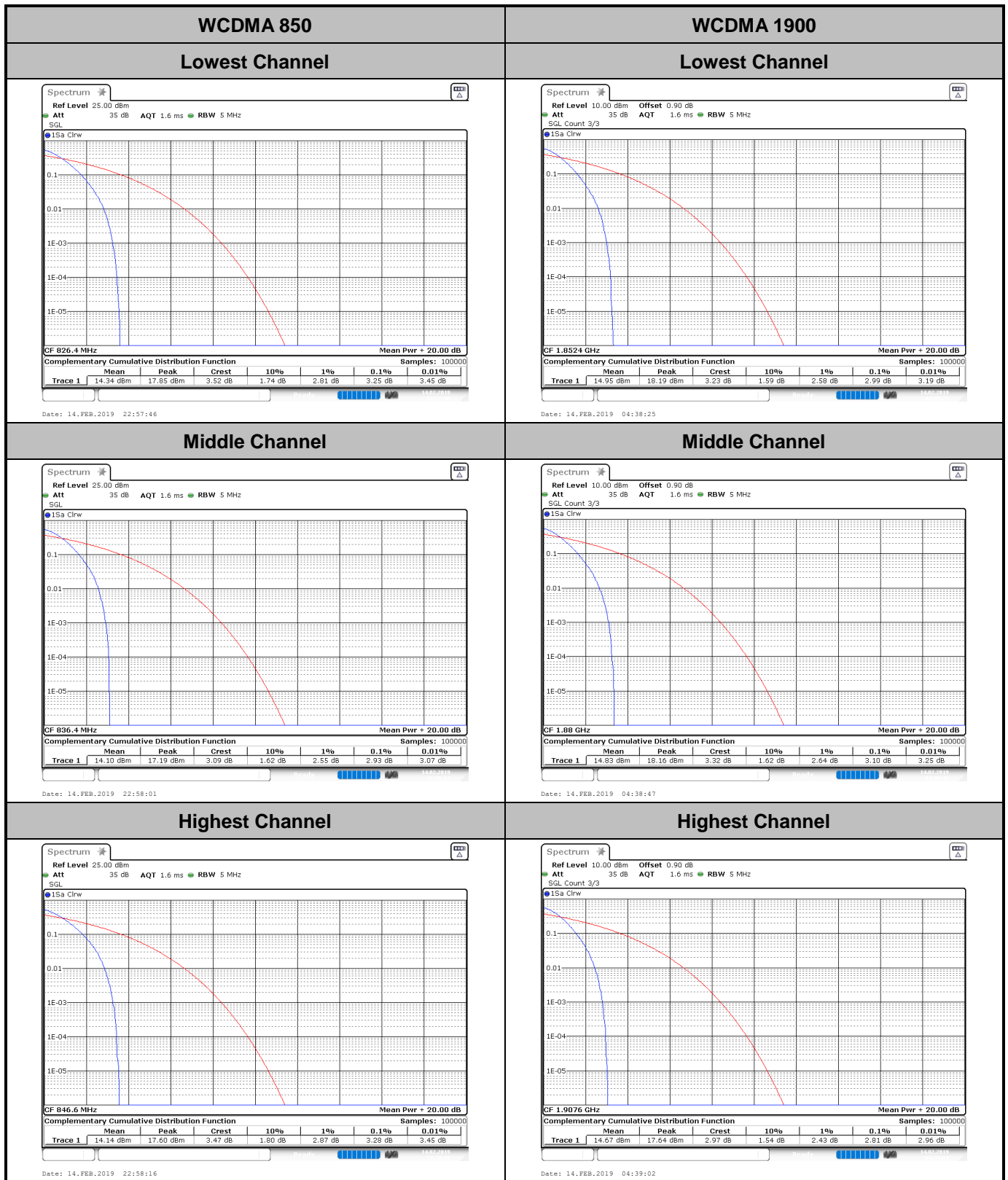

26dB Bandwidth and Occupied Bandwidth

Test Band	Test Mode	Test Channel	Occupied Bandwidth (KHZ)	Emission Bandwidth (KHZ)	Verdict
GSM850	GPRS	LCH	243.13	310.14	PASS
		MCH	243.13	305.80	PASS
		HCH	247.47	300.00	PASS
	EDGE	LCH	244.57	301.45	PASS
		MCH	247.47	308.70	PASS
		HCH	243.13	300.00	PASS

Test Band	Test Mode	Test Channel	Occupied Bandwidth (KHZ)	Emission Bandwidth (KHZ)	Verdict
GSM1900	GPRS	LCH	248.91	313.04	PASS
		MCH	251.81	315.94	PASS
		HCH	250.36	317.39	PASS
	EDGE	LCH	243.13	310.14	PASS
		MCH	240.23	297.10	PASS
		HCH	240.23	286.96	PASS

Test Band	Test Mode	Test Channel	Occupied Bandwidth (KHZ)	Emission Bandwidth (KHZ)	Verdict
WCDMA850	RMC 12.2Kbps	LCH	4153.4	4739	PASS
		MCH	4167.9	4739	PASS
		HCH	4153.4	4725	PASS

Test Band	Test Mode	Test Channel	Occupied Bandwidth (KHZ)	Emission Bandwidth (KHZ)	Verdict
WCDMA1900	RMC 12.2Kbps	LCH	4153.4	4768	PASS
		MCH	4153.4	4754	PASS
		HCH	4167.9	4783	PASS

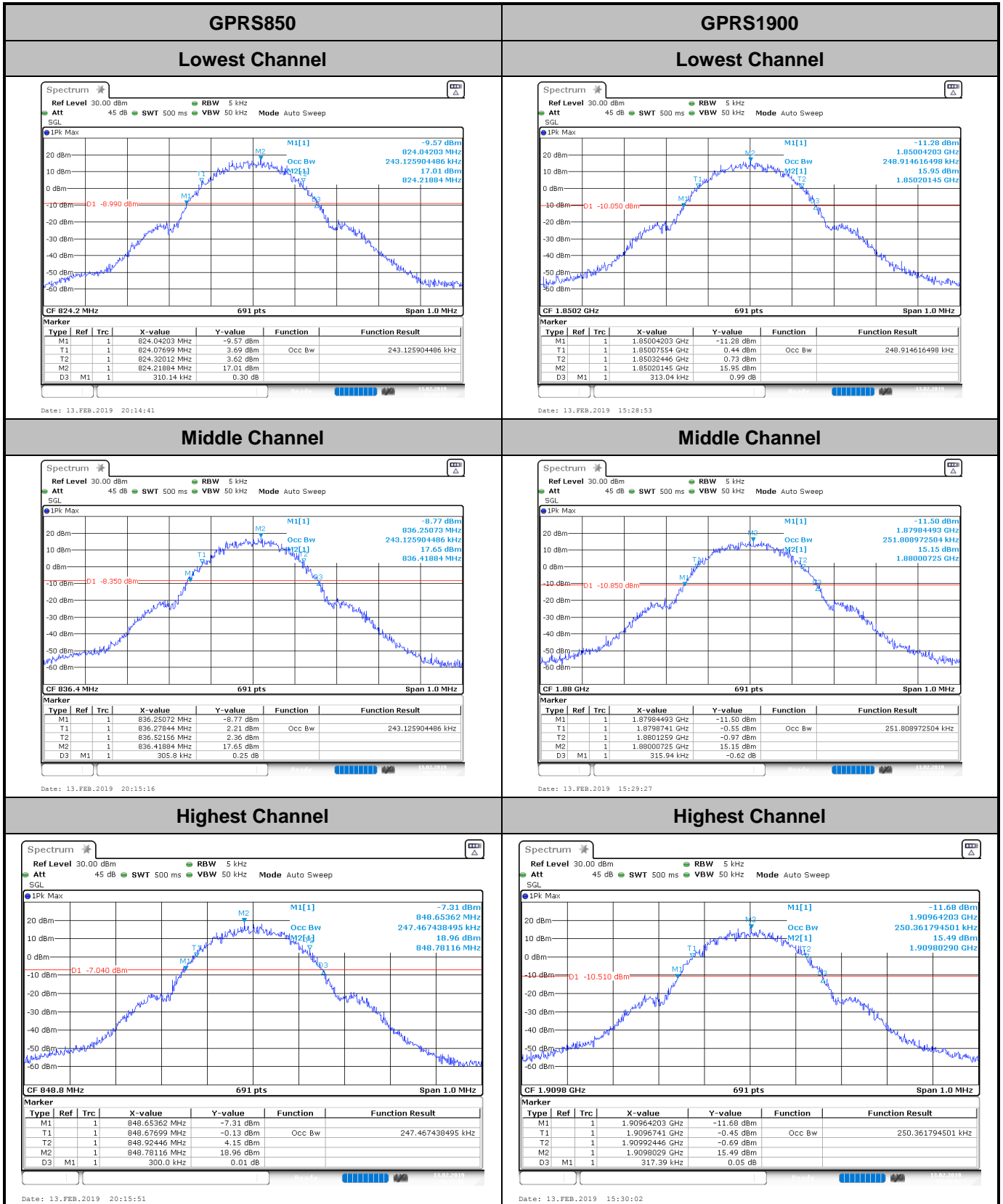

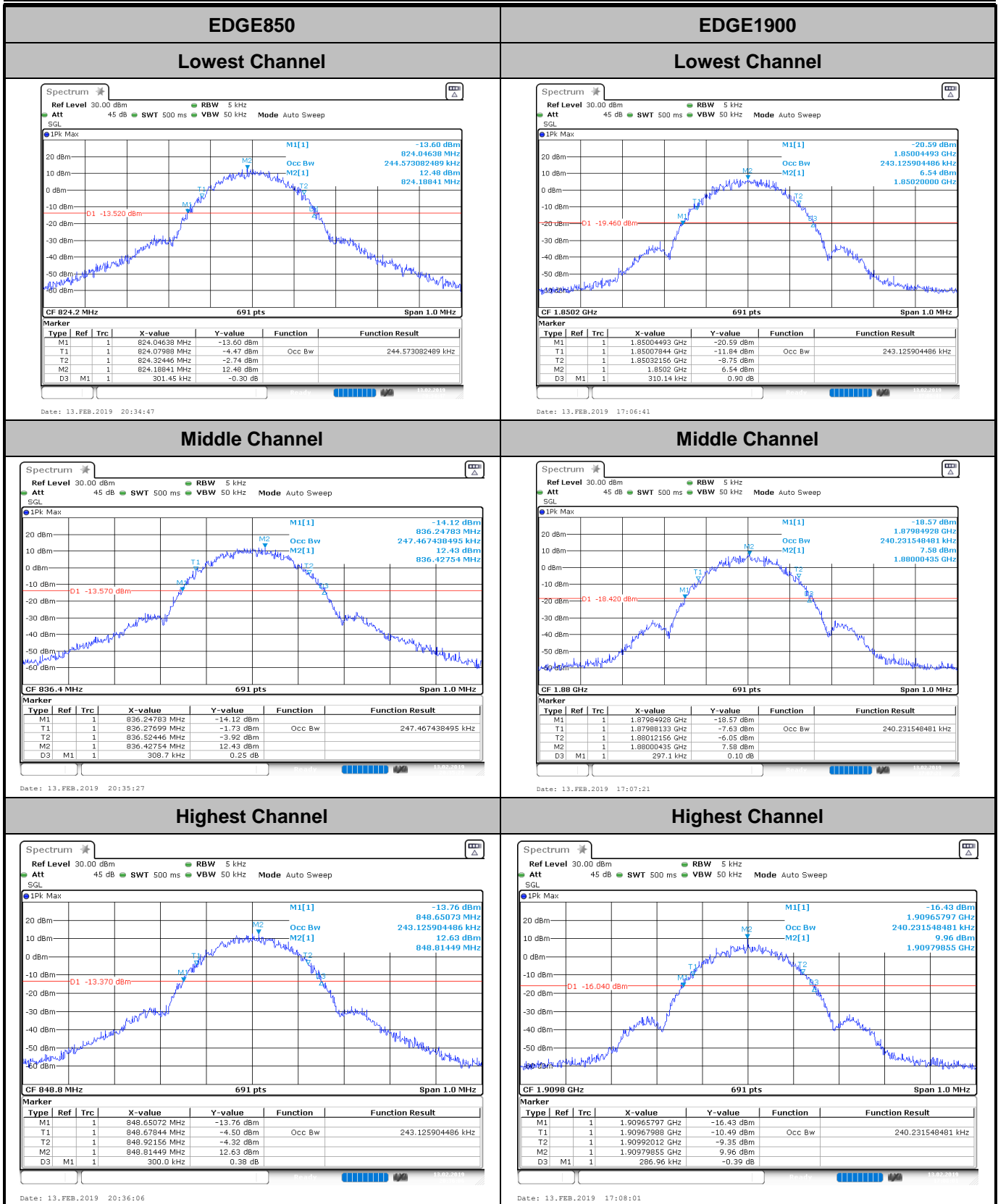

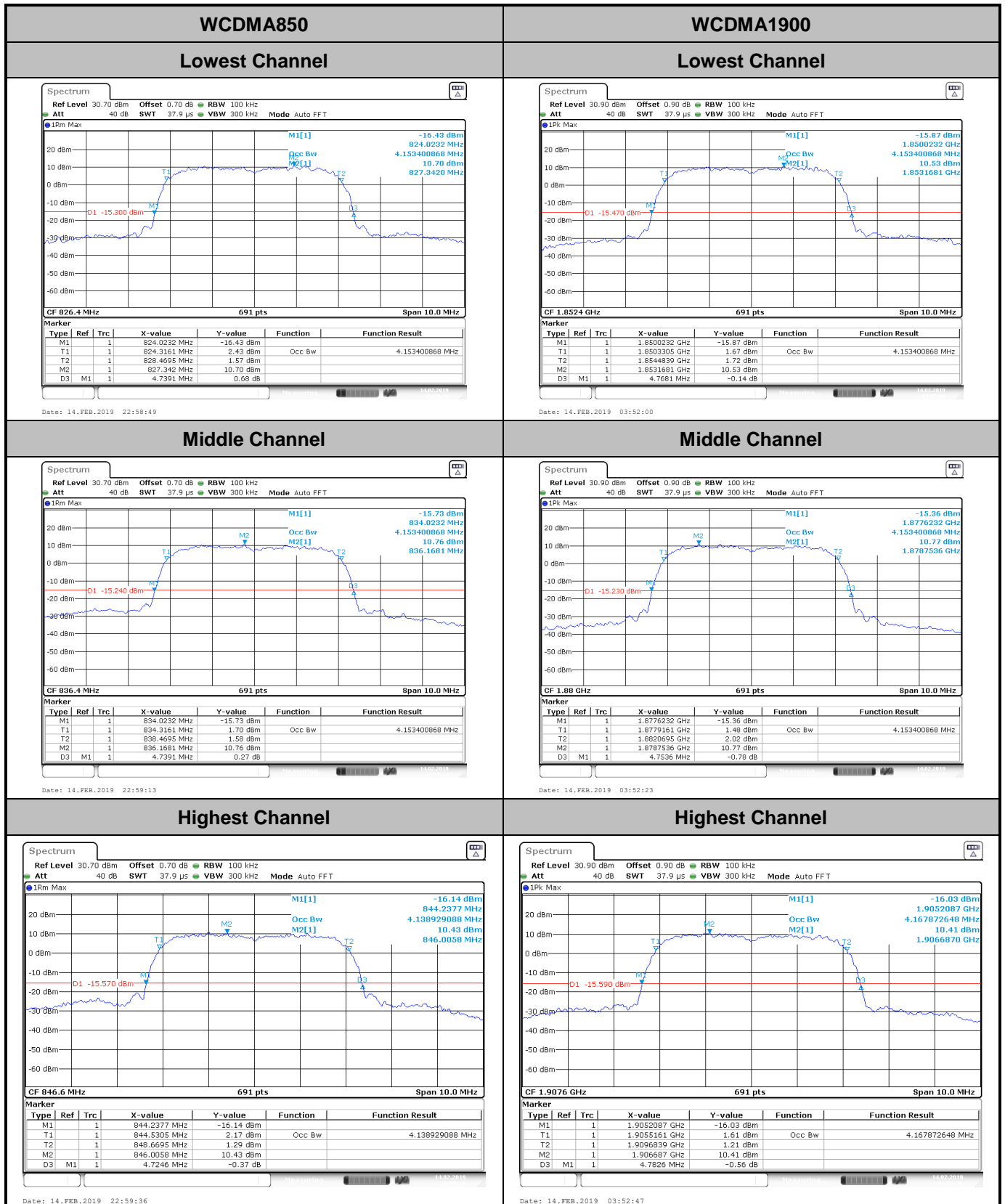

Conducted Band Edge

GSM850 (GPRS)

Lowest Band Edge

Highest Band Edge

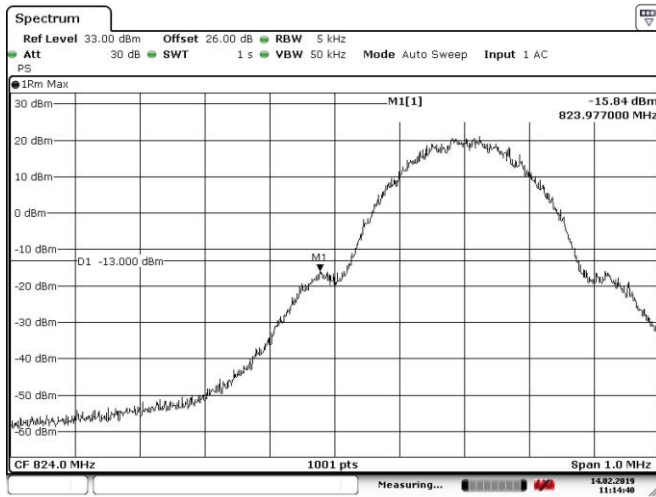

Date: 14.FEB.2019 11:14:41

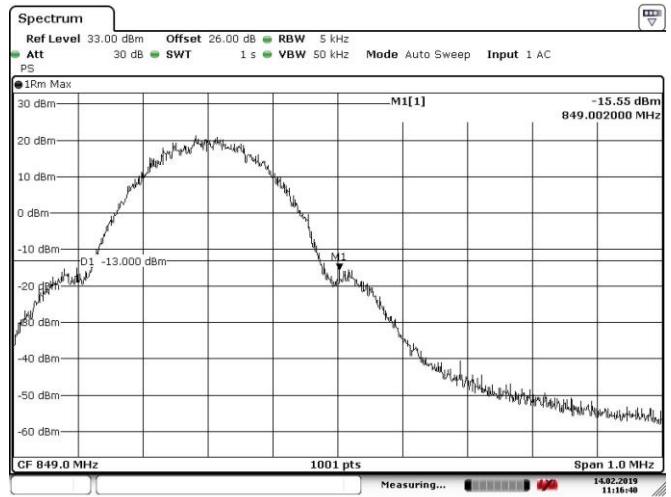

Date: 14.FEB.2019 11:16:40

GSM850 (EDGE Class8)

Lowest Band Edge

Highest Band Edge

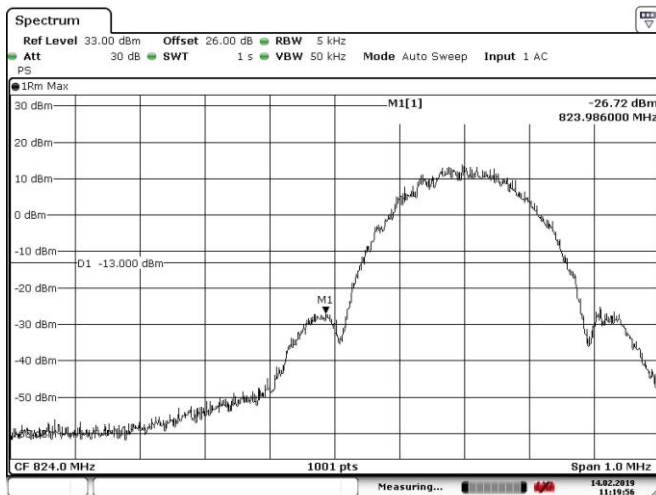

Date: 14.FEB.2019 11:19:56

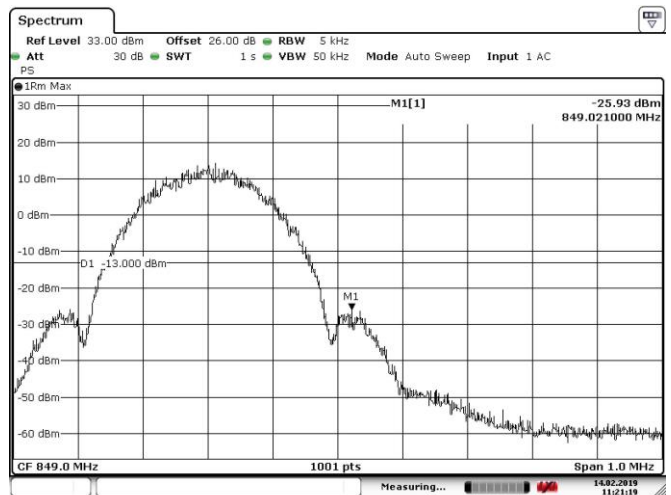

Date: 14.FEB.2019 11:21:19

GSM1900 (GPRS)

Lowest Band Edge

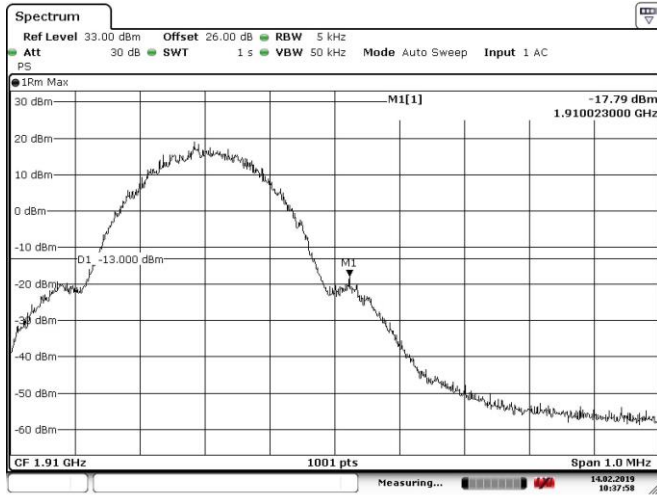

Date: 14.FEB.2019 10:37:58

Highest Band Edge

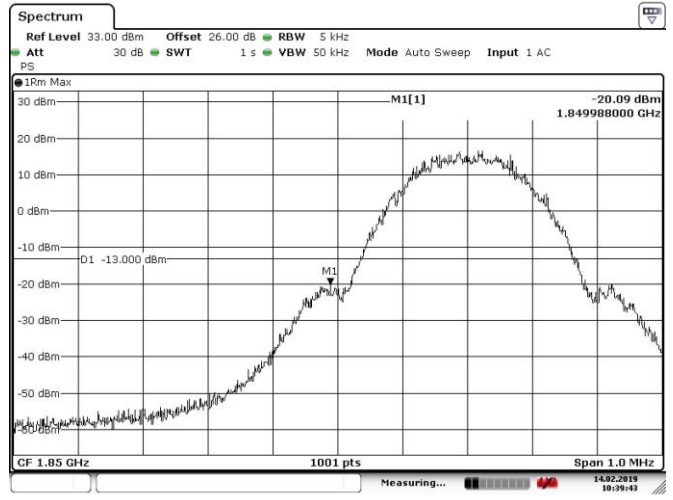

Date: 14.FEB.2019 10:39:44

GSM1900 (EDGE Class8)

Lowest Band Edge

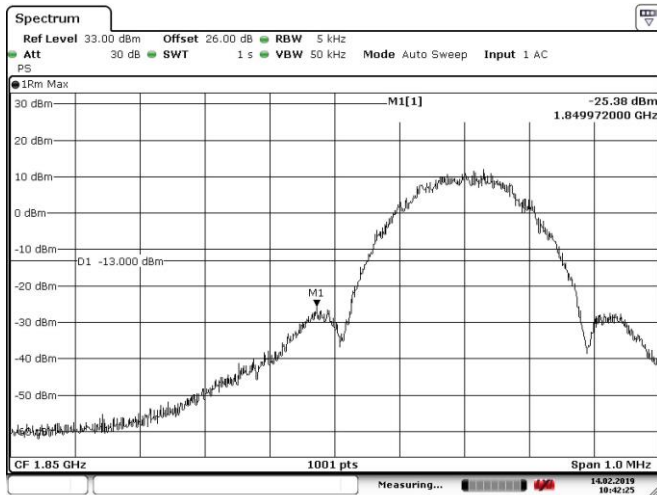

Date: 14.FEB.2019 10:42:25

Highest Band Edge

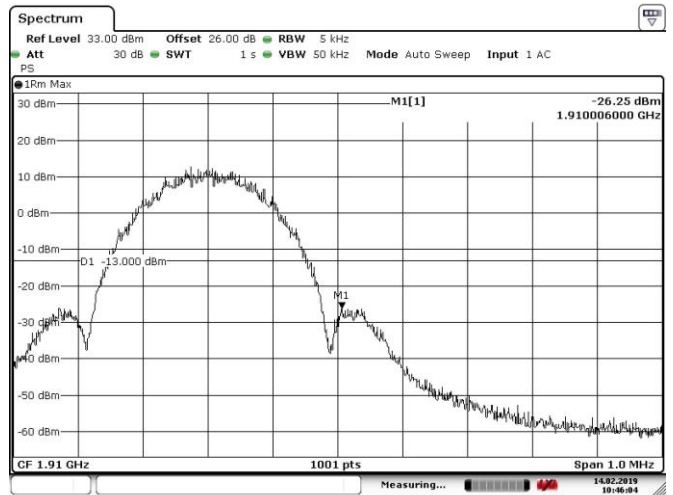

Date: 14.FEB.2019 10:46:04

WCDMA Band V (RMC 12.2Kbps)

Lowest Band Edge

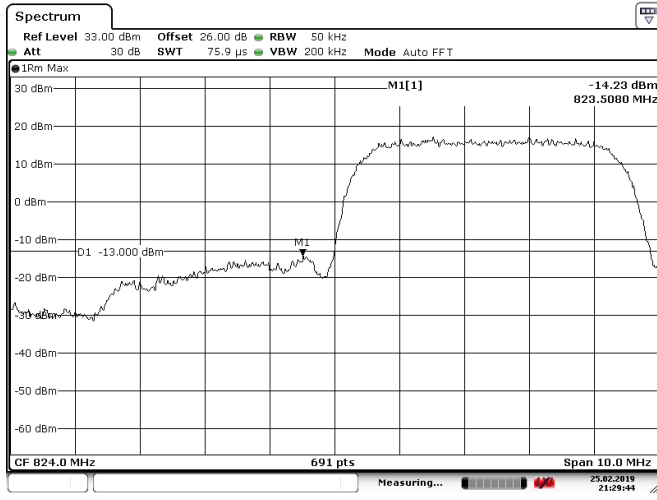

Date: 25.FEB.2019 21:29:45

Highest Band Edge

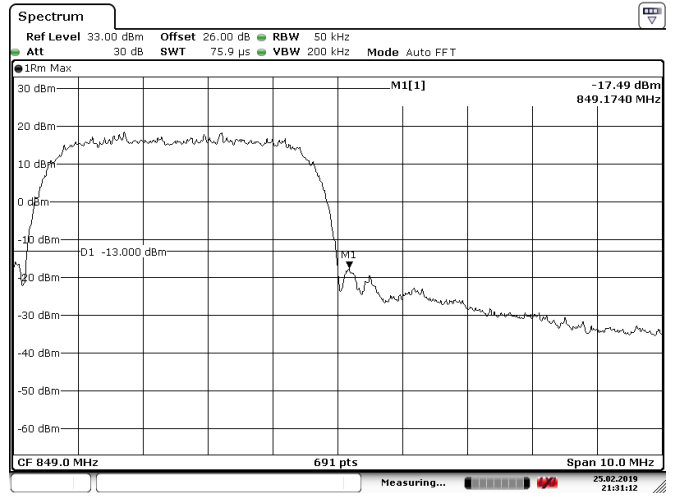

Date: 25.FEB.2019 21:31:13

WCDMA Band II (RMC 12.2Kbps)

Lowest Band Edge

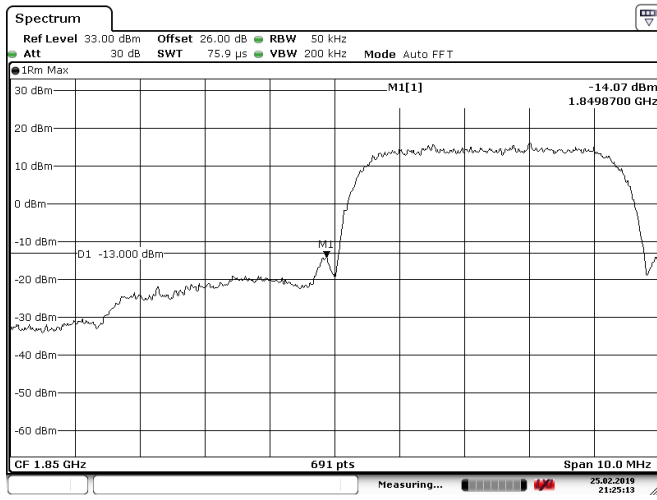

Date: 25.FEB.2019 21:25:13

Highest Band Edge

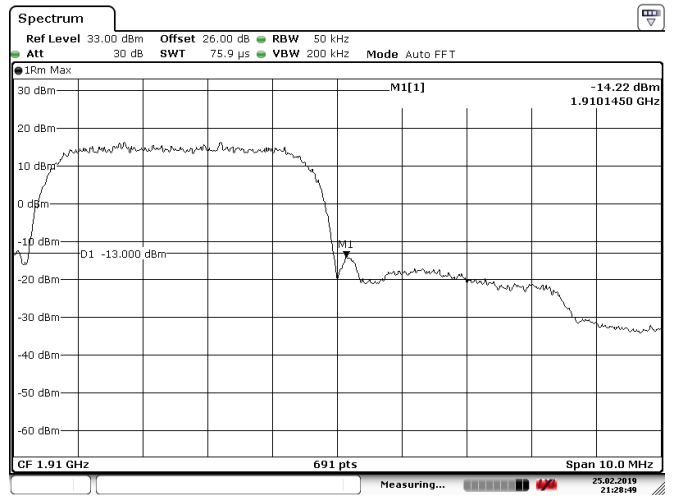

Date: 25.FEB.2019 21:28:49

Conducted Spurious Emission

Band	Channel	Frequency Rang(Mhz)	Value(dBm)	Limit(dBm)	Verdict
GPRS850	128	0.009~0.15	-35.41	-33	PASS
GPRS850	128	0.15~30	-58.51	-13	PASS
GPRS850	128	30~1000	-43.63	-13	PASS
GPRS850	128	1000~3000	-44.87	-13	PASS
GPRS850	128	3000~10000	-56.71	-13	PASS
GPRS850	189	0.009~0.15	-35.08	-33	PASS
GPRS850	189	0.15~30	-57.54	-13	PASS
GPRS850	189	30~1000	-43.71	-13	PASS
GPRS850	189	1000~3000	-44.88	-13	PASS
GPRS850	189	3000~10000	-53.23	-13	PASS
GPRS850	251	0.009~0.15	-34.40	-33	PASS
GPRS850	251	0.15~30	-57.70	-13	PASS
GPRS850	251	30~1000	-44.01	-13	PASS
GPRS850	251	1000~3000	-44.91	-13	PASS
GPRS850	251	3000~10000	-53.66	-13	PASS
EGPRS850	128	0.009~0.15	-42.80	-33	PASS
EGPRS850	128	0.15~30	-58.26	-13	PASS
EGPRS850	128	30~1000	-43.28	-13	PASS
EGPRS850	128	1000~3000	-49.58	-13	PASS
EGPRS850	128	3000~10000	-61.00	-13	PASS
EGPRS850	189	0.009~0.15	-41.63	-33	PASS
EGPRS850	189	0.15~30	-58.36	-13	PASS
EGPRS850	189	30~1000	-43.74	-13	PASS
EGPRS850	189	1000~3000	-50.24	-13	PASS
EGPRS850	189	3000~10000	-61.41	-13	PASS
EGPRS850	251	0.009~0.15	-42.15	-33	PASS
EGPRS850	251	0.15~30	-56.61	-13	PASS
EGPRS850	251	30~1000	-43.78	-13	PASS
EGPRS850	251	1000~3000	-50.47	-13	PASS
EGPRS850	251	3000~10000	-61.15	-13	PASS
GPRS1900	512	0.009~0.15	-57.59	-43	PASS
GPRS1900	512	0.15~30	-58.57	-23	PASS
GPRS1900	512	30~1000	-43.89	-13	PASS
GPRS1900	512	1000~3000	-50.98	-13	PASS

GPRS1900	512	3000~10000	-53.80	-13	PASS
GPRS1900	512	10000~18000	-57.39	-13	PASS
GPRS1900	661	0.009~0.15	-57.09	-43	PASS
GPRS1900	661	0.15~30	-58.42	-23	PASS
GPRS1900	661	30~1000	-43.68	-13	PASS
GPRS1900	661	1000~3000	-51.25	-13	PASS
GPRS1900	661	3000~10000	-54.30	-13	PASS
GPRS1900	661	10000~18000	-57.34	-13	PASS
GPRS1900	810	0.009~0.15	-59.11	-43	PASS
GPRS1900	810	0.15~30	-57.27	-23	PASS
GPRS1900	810	30~1000	-43.62	-13	PASS
GPRS1900	810	1000~3000	-51.17	-13	PASS
GPRS1900	810	3000~10000	-55.25	-13	PASS
GPRS1900	810	10000~18000	-57.28	-13	PASS
EGPRS1900	512	0.009~0.15	-51.31	-43	PASS
EGPRS1900	512	0.15~30	-57.44	-23	PASS
EGPRS1900	512	30~1000	-43.85	-13	PASS
EGPRS1900	512	1000~3000	-51.17	-13	PASS
EGPRS1900	512	3000~10000	-59.75	-13	PASS
EGPRS1900	512	10000~18000	-57.55	-13	PASS
EGPRS1900	661	0.009~0.15	-53.40	-43	PASS
EGPRS1900	661	0.15~30	-57.93	-23	PASS
EGPRS1900	661	30~1000	-43.78	-13	PASS
EGPRS1900	661	1000~3000	-51.18	-13	PASS
EGPRS1900	661	3000~10000	-59.69	-13	PASS
EGPRS1900	661	10000~18000	-57.39	-13	PASS
EGPRS1900	810	0.009~0.15	-52.05	-43	PASS
EGPRS1900	810	0.15~30	-58.53	-23	PASS
EGPRS1900	810	30~1000	-43.34	-13	PASS
EGPRS1900	810	1000~3000	-51.23	-13	PASS
EGPRS1900	810	3000~10000	-59.67	-13	PASS
EGPRS1900	810	10000~18000	-57.37	-13	PASS

Test Graphs

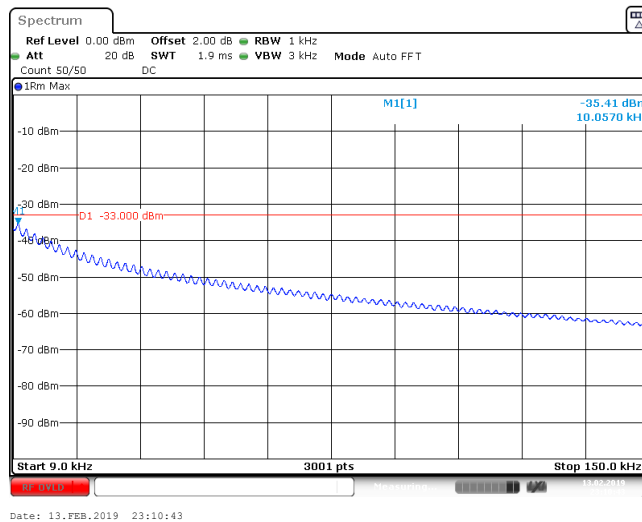

GPRS850_128

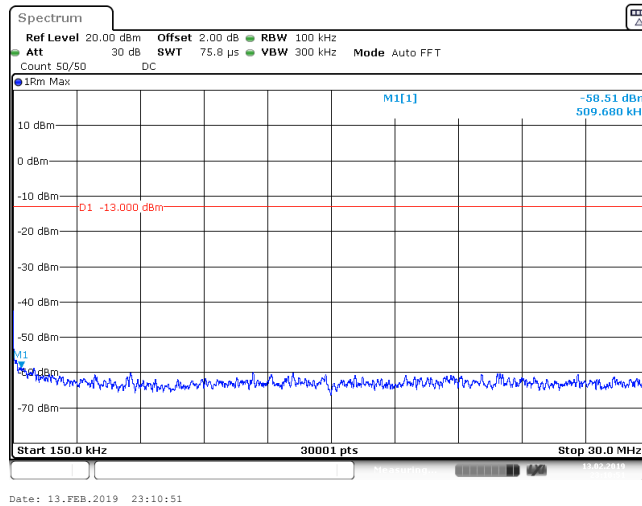

GPRS850_128

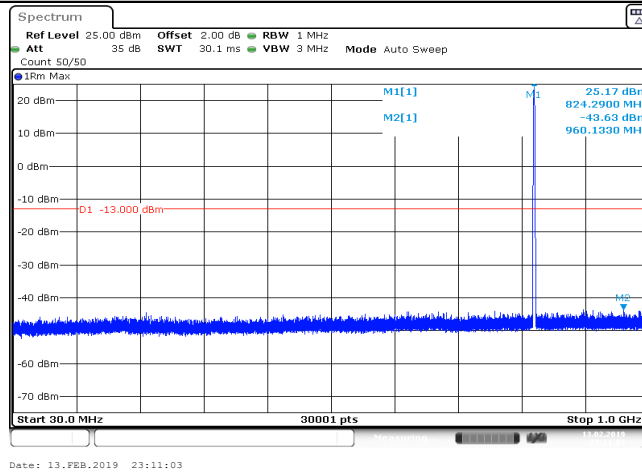

GPRS850_128

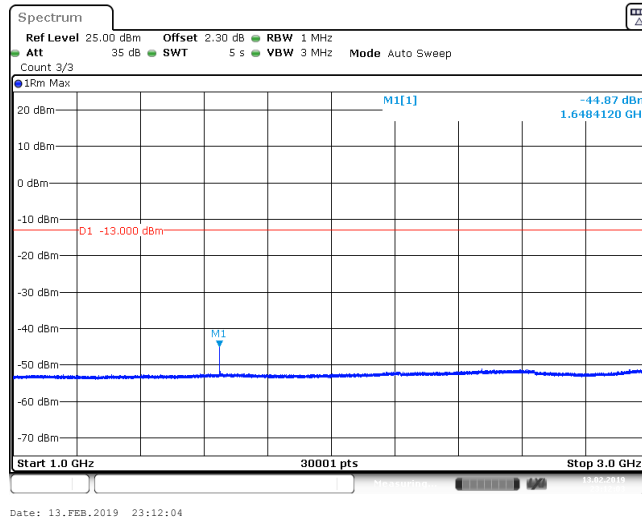

GPRS850_128

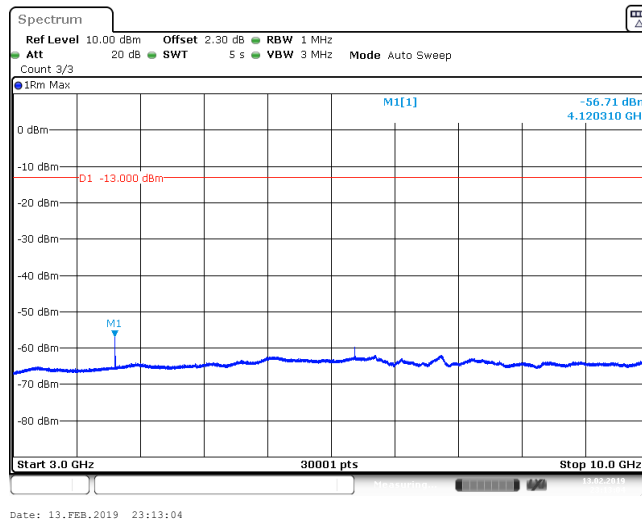

GPRS850_128

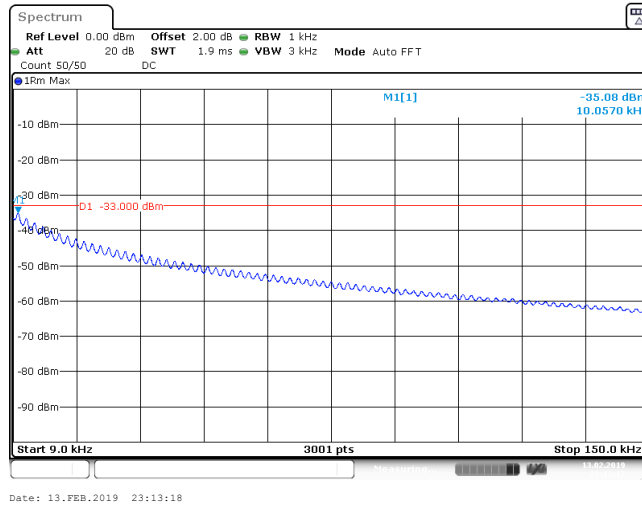

GPRS850_189

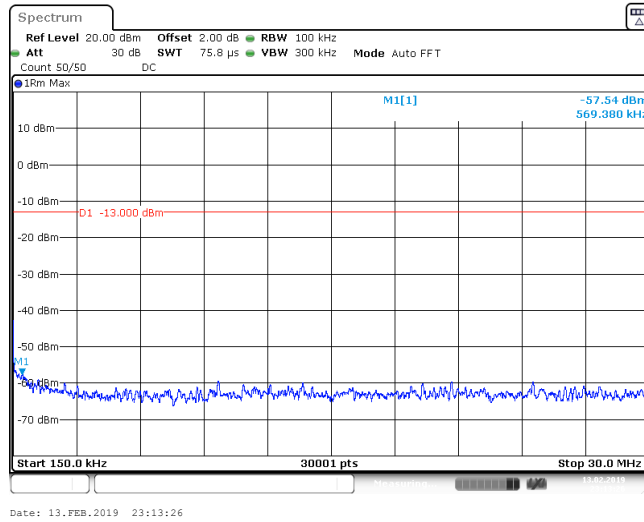

GPRS850_189

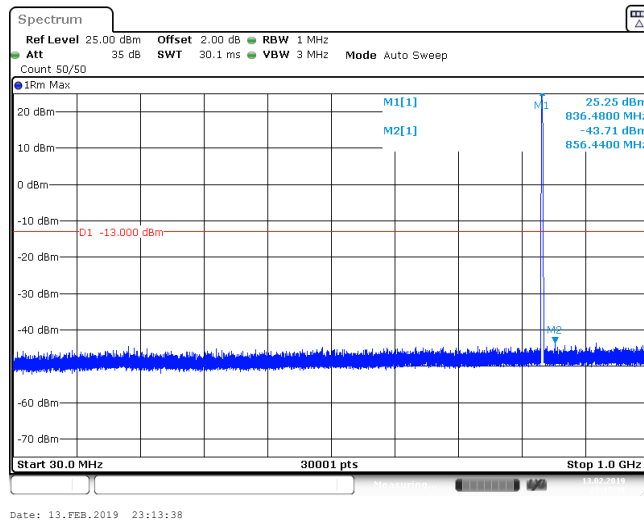

GPRS850_189

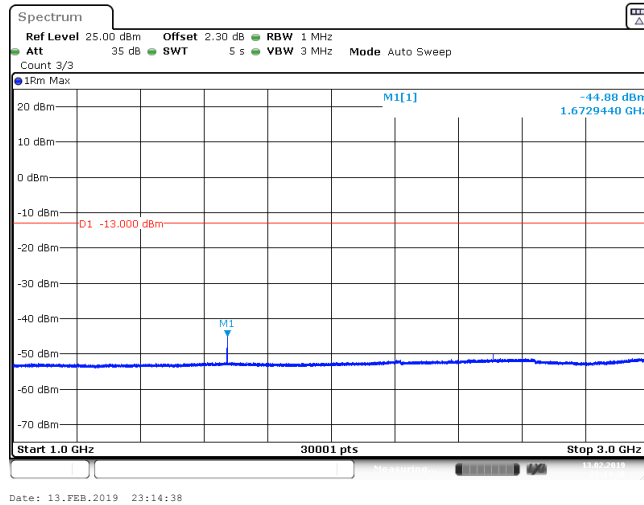

GPRS850_189

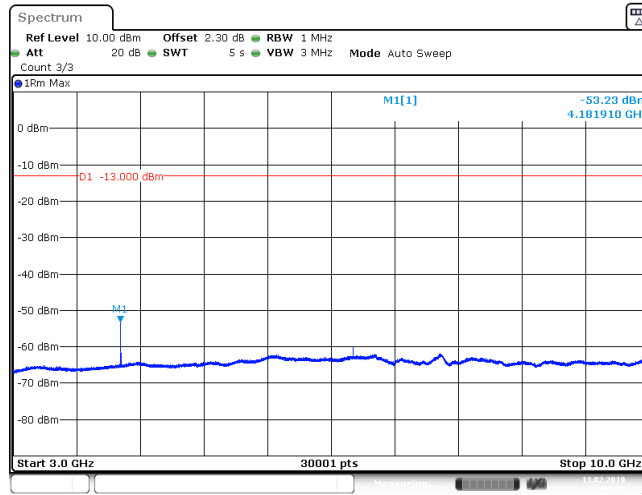

Date: 13.FEB.2019 23:15:39

GPRS850_189

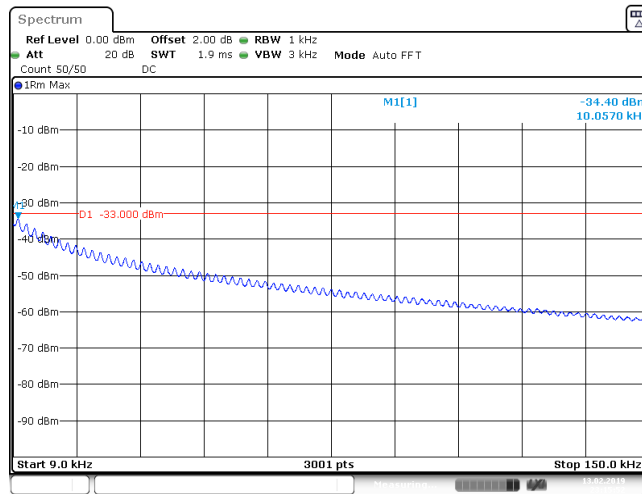

Date: 13.FEB.2019 23:15:52

GPRS850_251

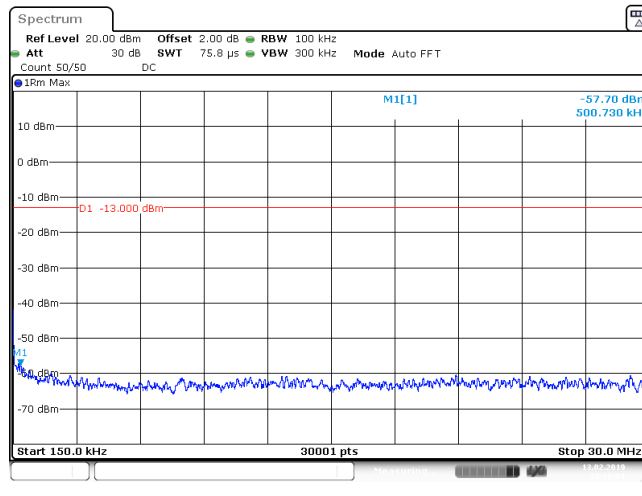

Date: 13.FEB.2019 23:16:01

GPRS850_251

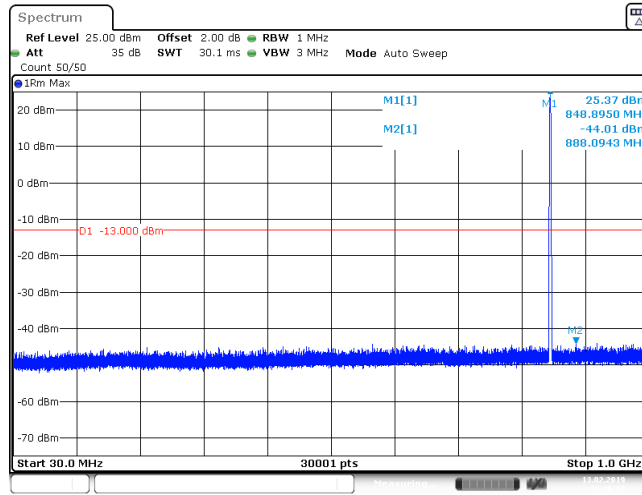

Date: 13.FEB.2019 23:16:13

GPRS850_251

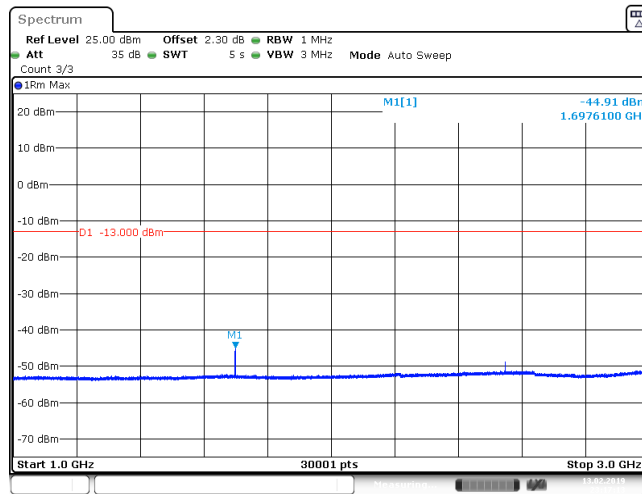

Date: 13.FEB.2019 23:17:13

GPRS850_251

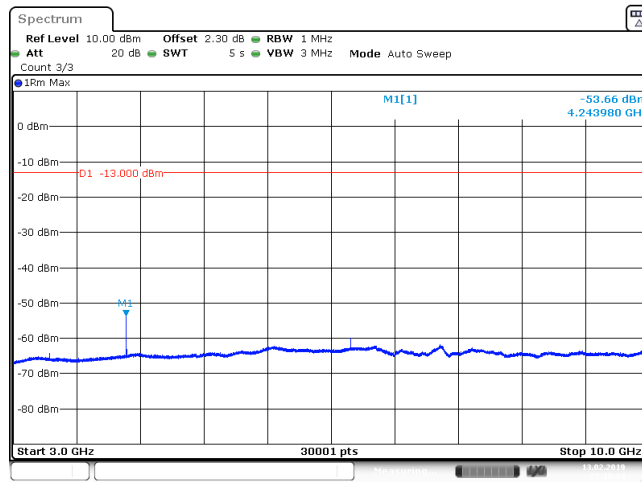

Date: 13.FEB.2019 23:18:14

GPRS850_251

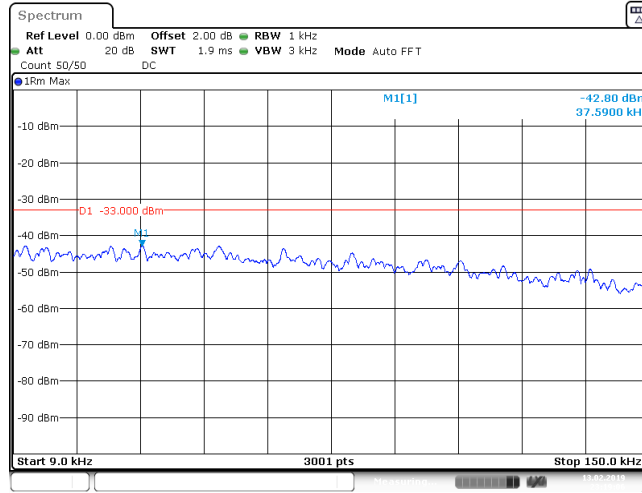

Date: 13.FEB.2019 23:19:06

EGPRS850_128

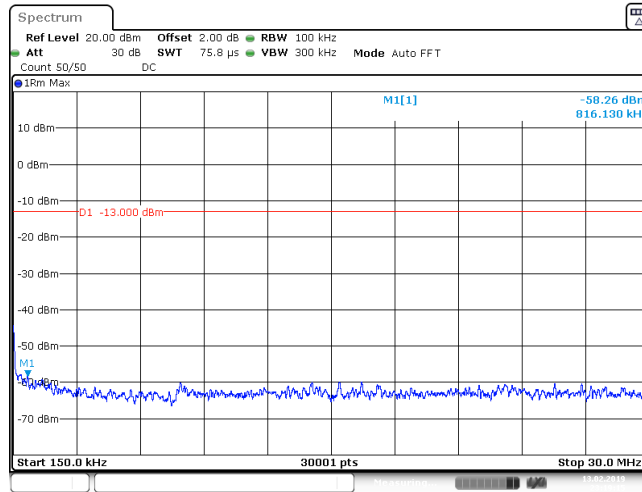

Date: 13.FEB.2019 23:19:15

EGPRS850_128

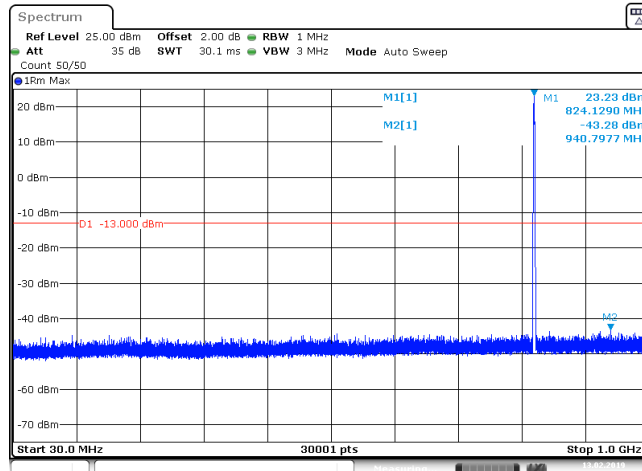

Date: 13.FEB.2019 23:19:26

EGPRS850_128

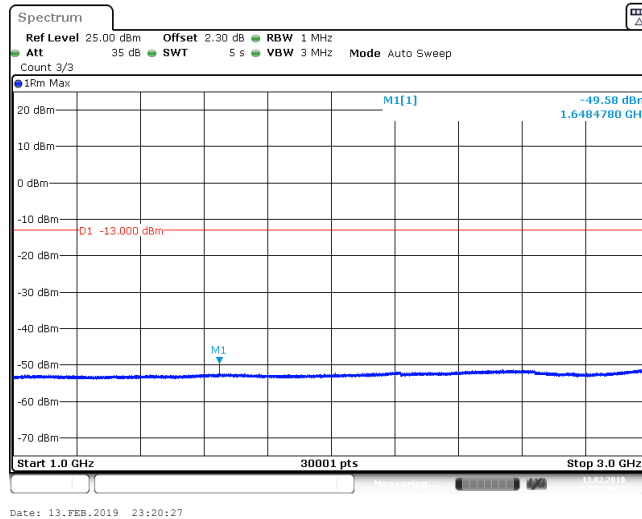

EGPRS850_128

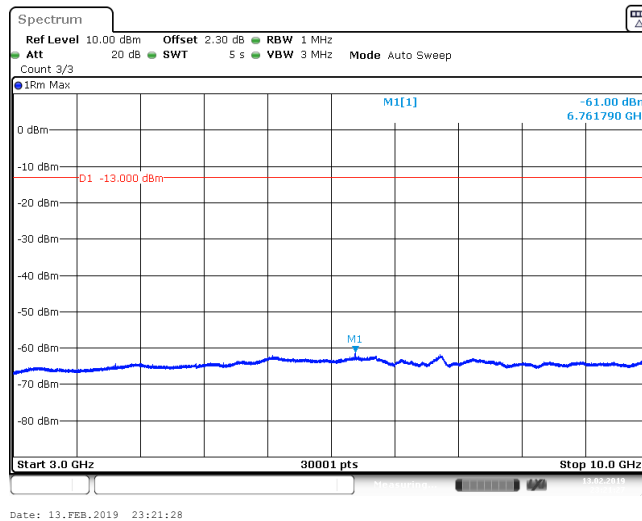

EGPRS850_128

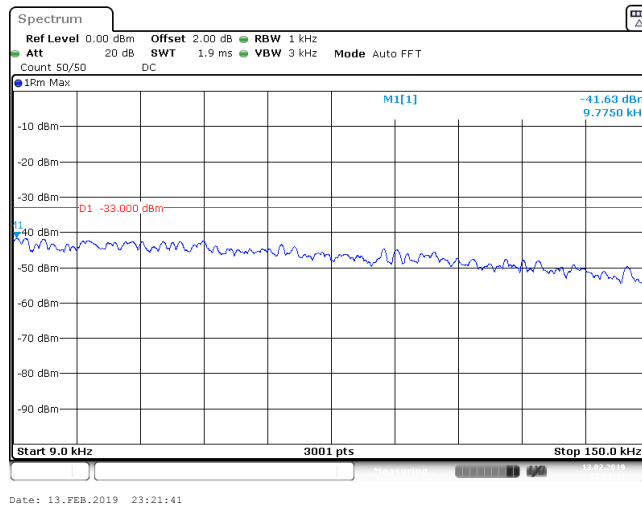

EGPRS850_189

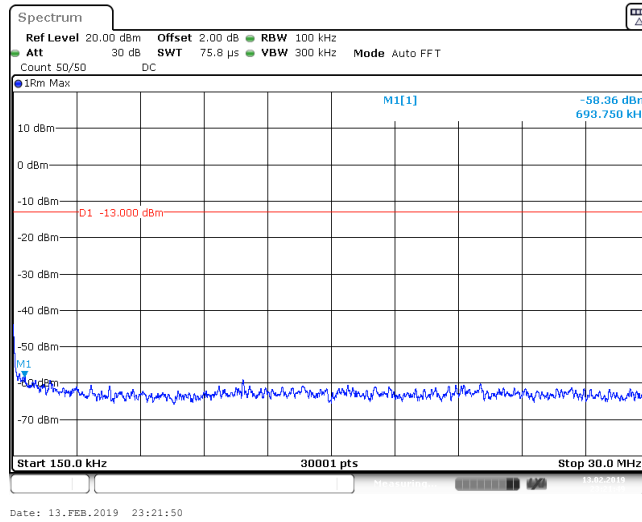

EGPRS850_189

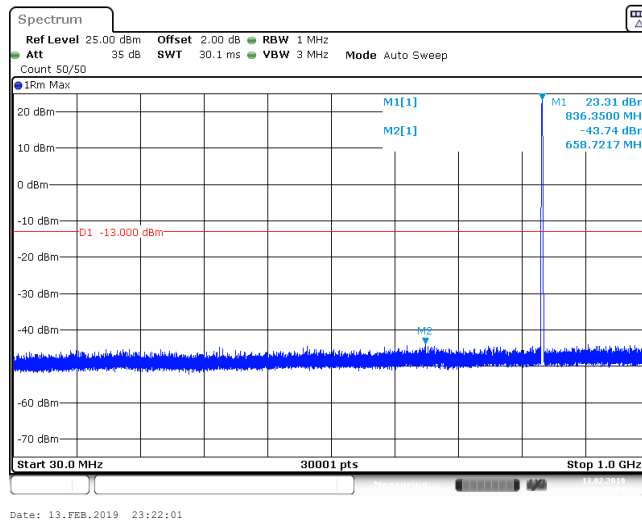

EGPRS850_189

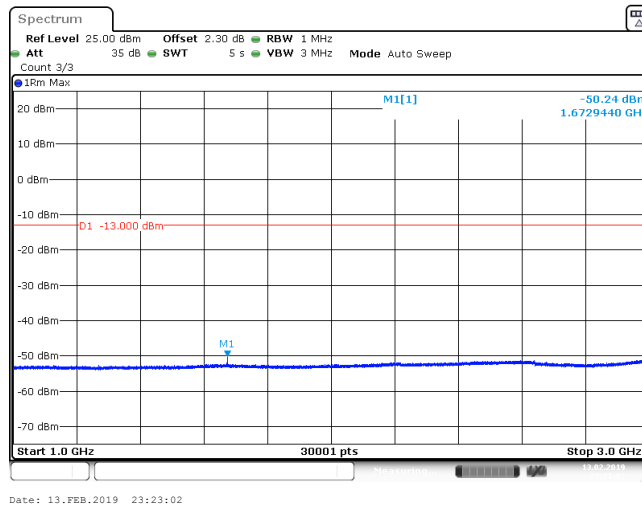

EGPRS850_189

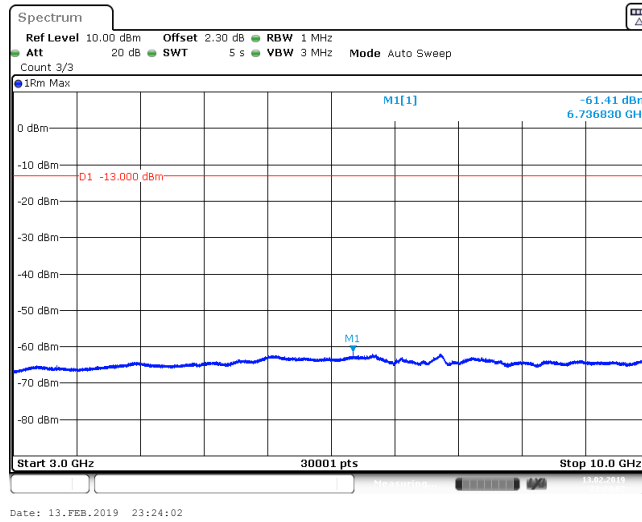

EGPRS850_189

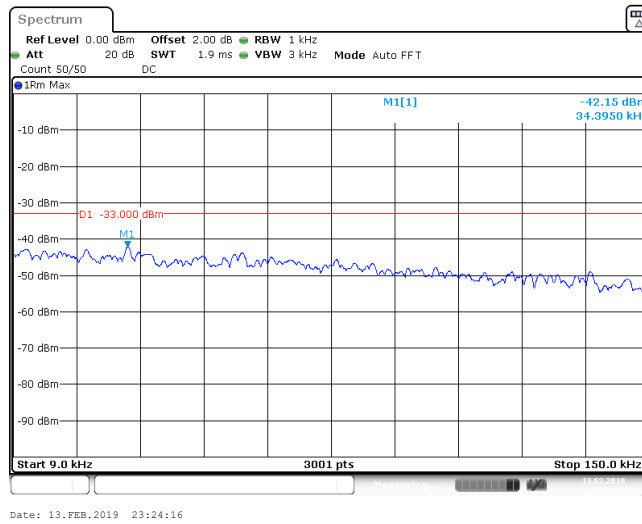

EGPRS850_251

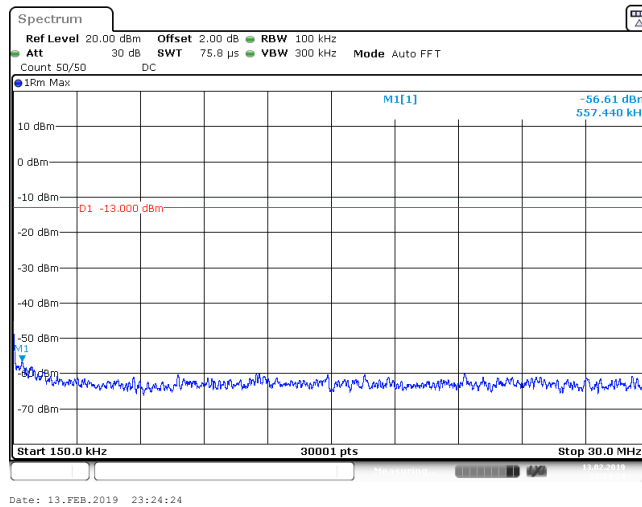

EGPRS850_251

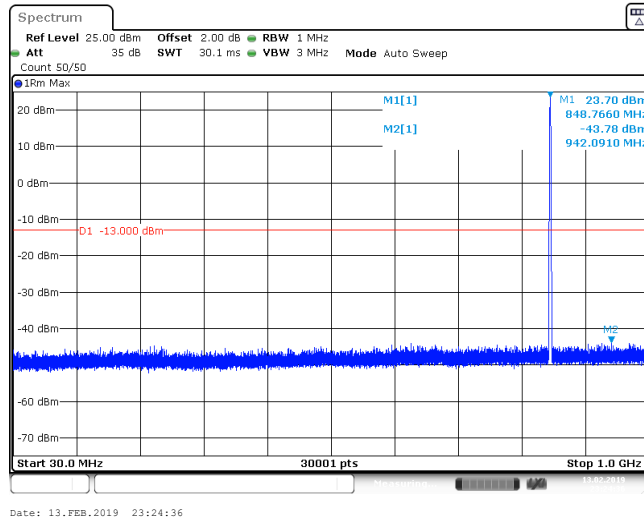

EGPRS850_251

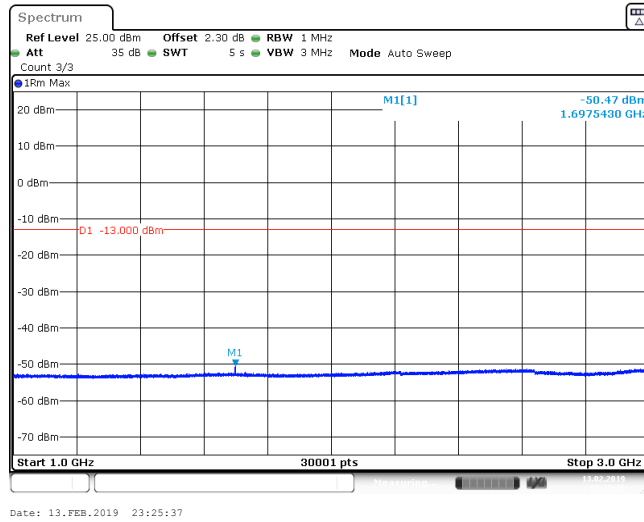

EGPRS850_251

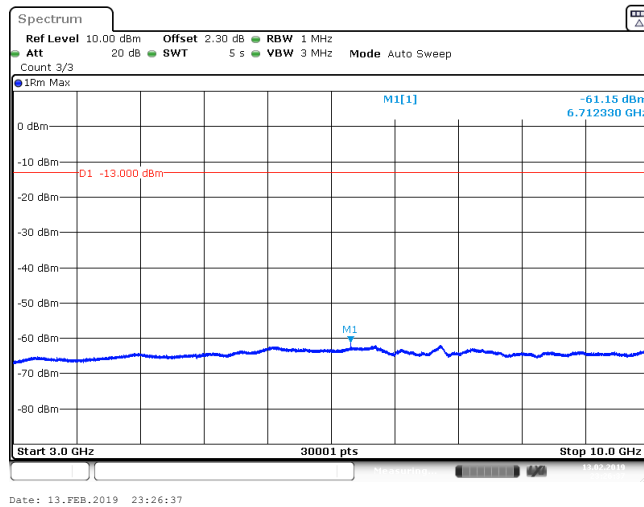

EGPRS850_251

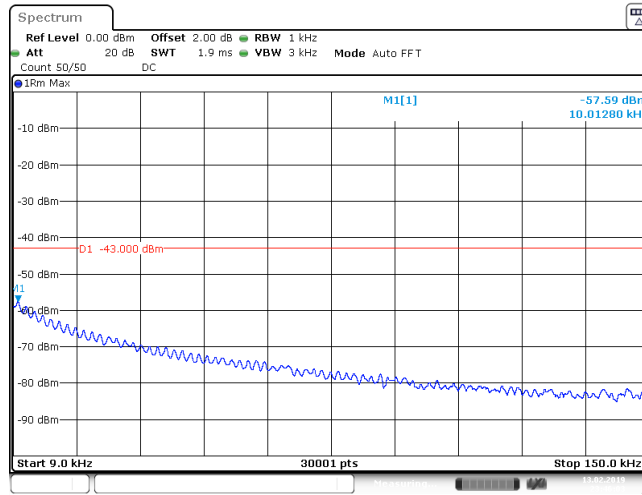

Date: 13.FEB.2019 23:46:03

GPRS1900_512

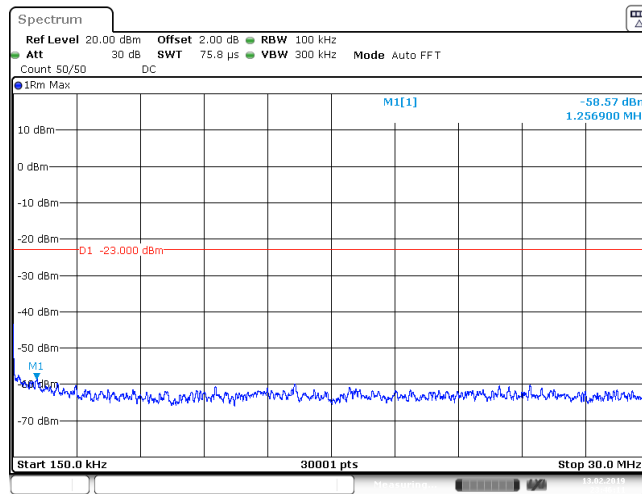

Date: 13.FEB.2019 23:46:12

GPRS1900_512

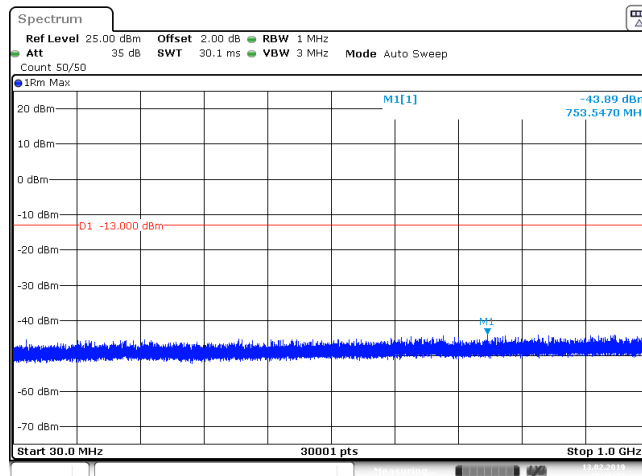

Date: 13.FEB.2019 23:46:22

GPRS1900_512

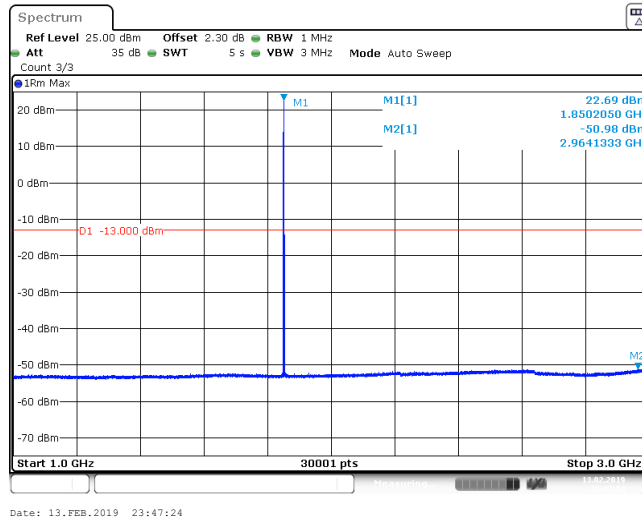

GPRS1900_512

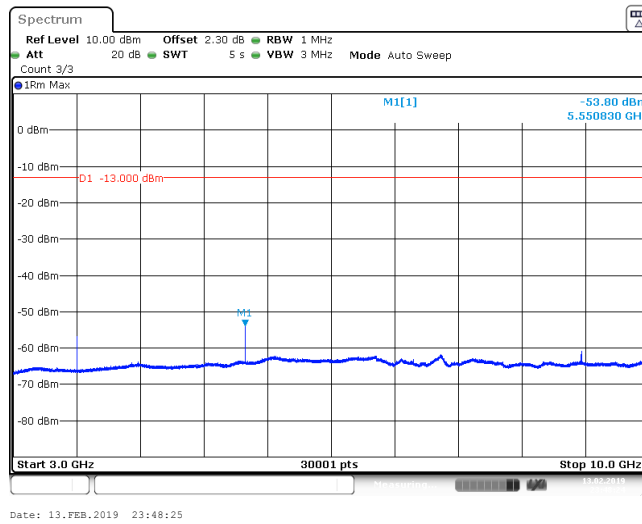

GPRS1900_512

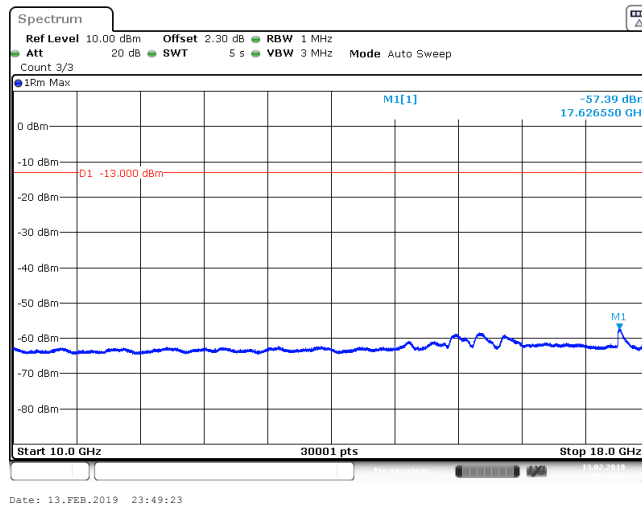

GPRS1900_512

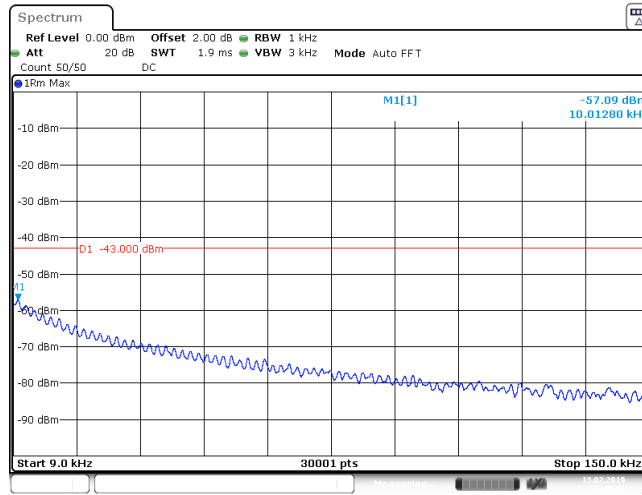

Date: 13.FEB.2019 23:49:37

GPRS1900_661

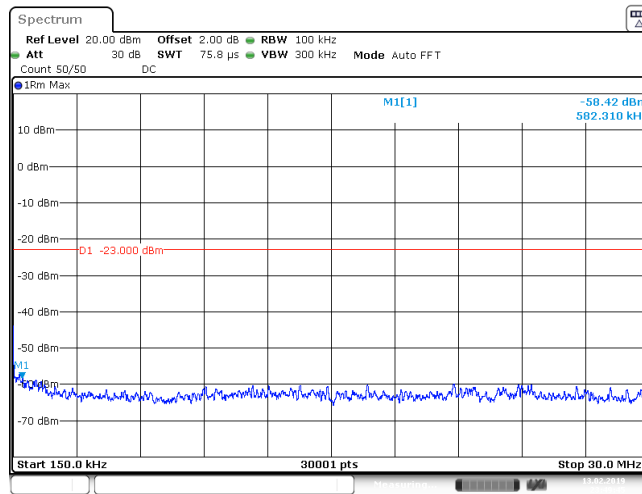

Date: 13.FEB.2019 23:49:45

GPRS1900_661

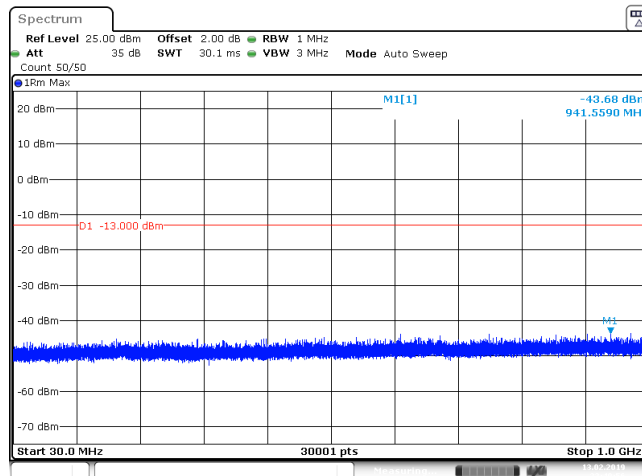

Date: 13.FEB.2019 23:49:56

GPRS1900_661

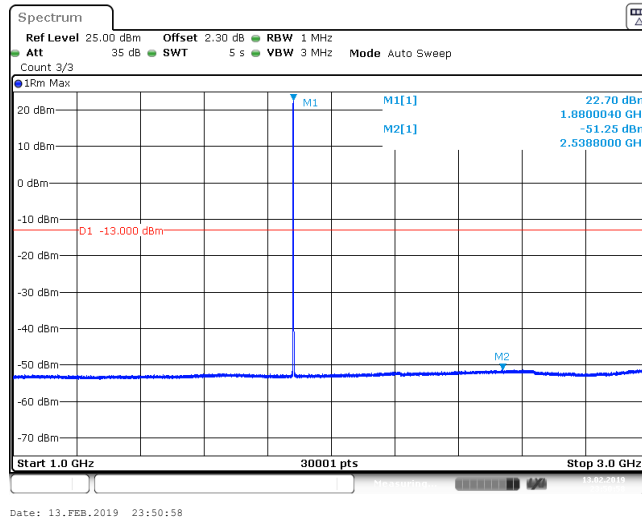

GPRS1900_661

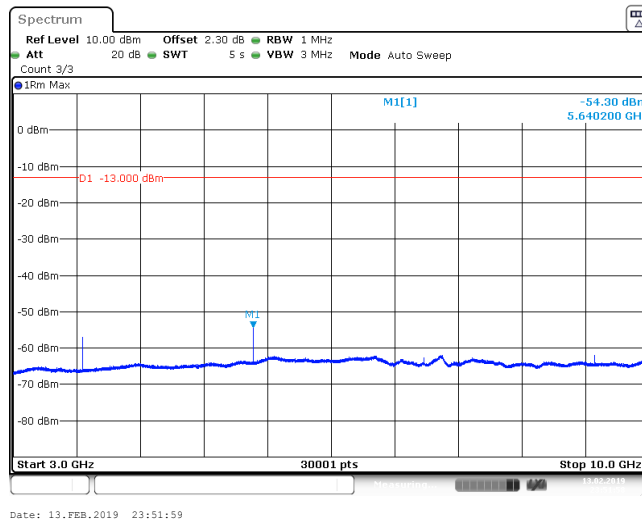

GPRS1900_661

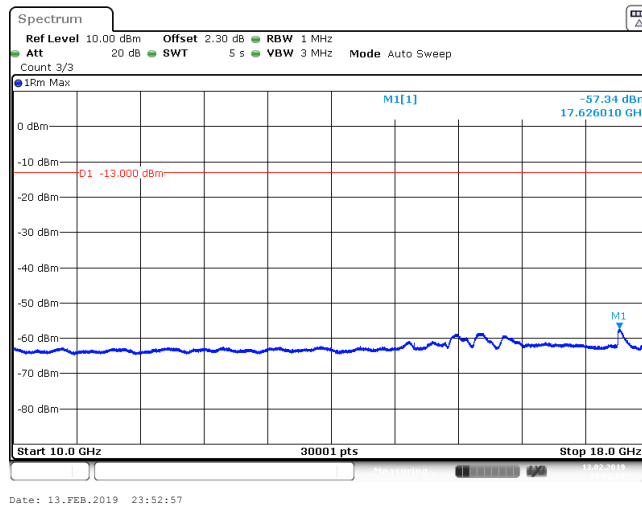

GPRS1900_661

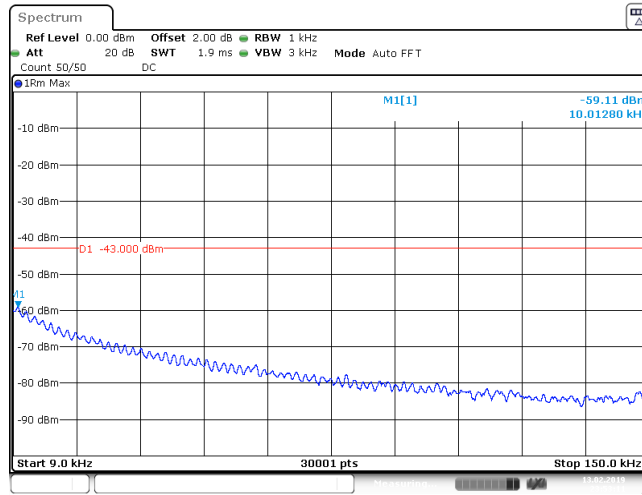

Date: 13.FEB.2019 23:53:11

GPRS1900_810

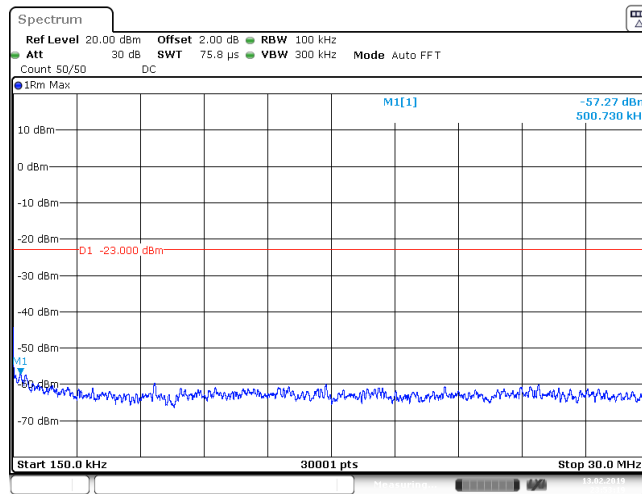

Date: 13.FEB.2019 23:53:20

GPRS1900_810

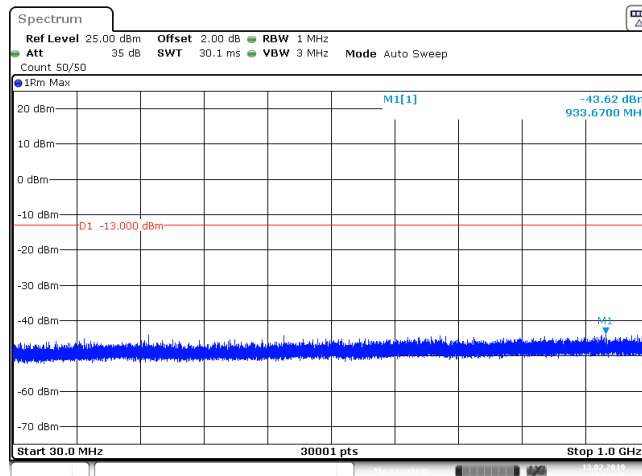

Date: 13.FEB.2019 23:53:31

GPRS1900_810

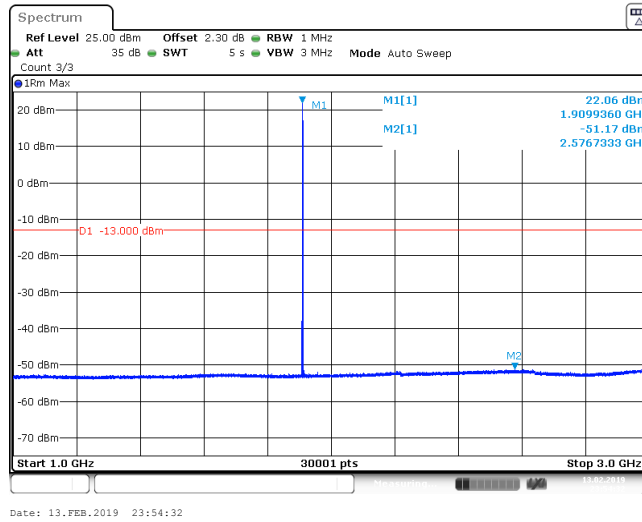

GPRS1900_810

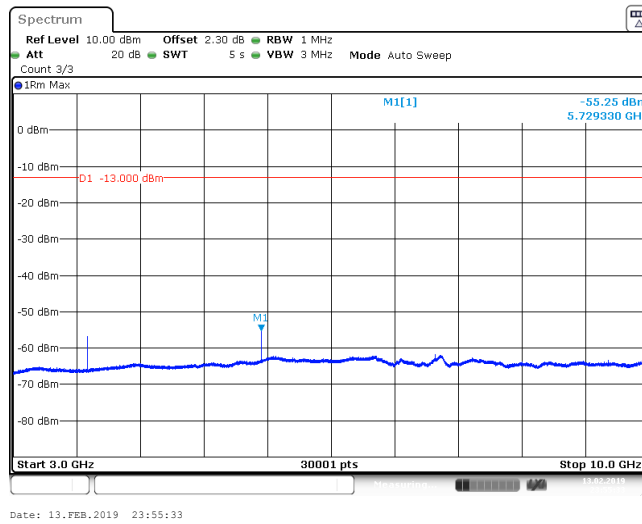

GPRS1900_810

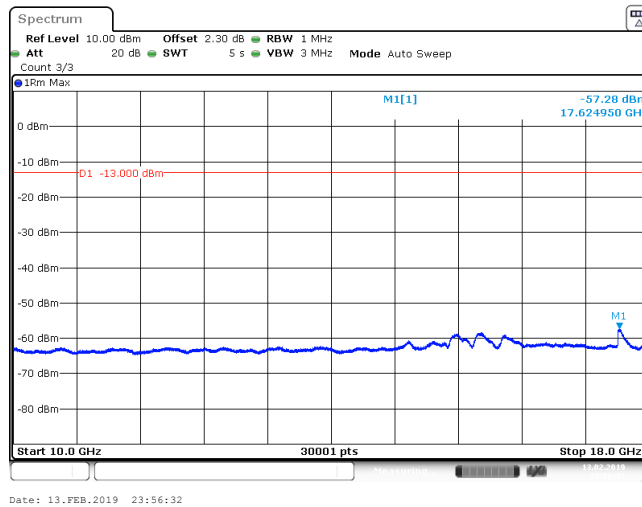

GPRS1900_810

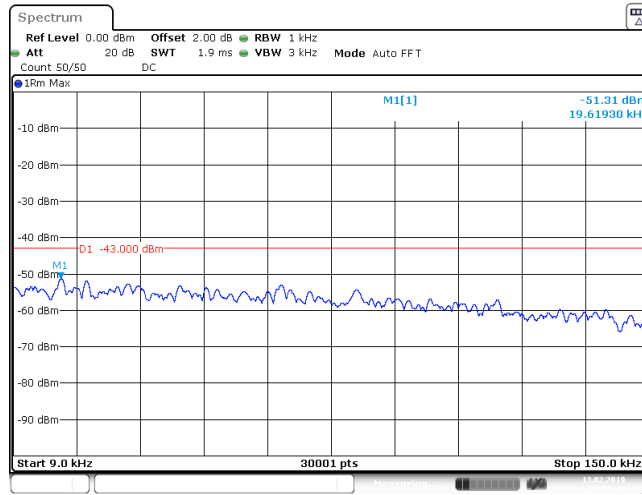

Date: 13.FEB.2019 23:57:48

EGPRS1900_512

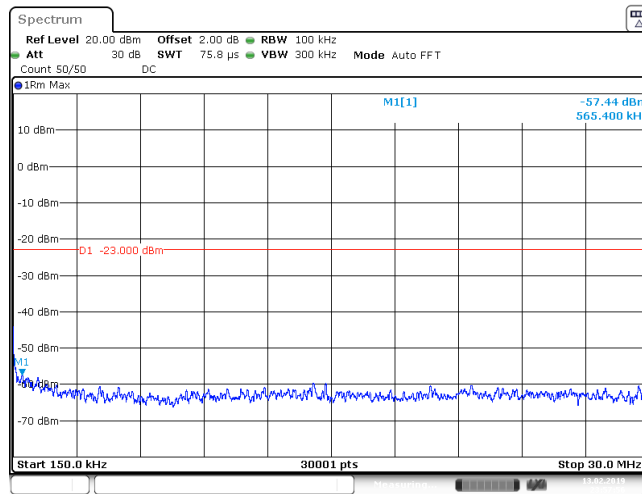

Date: 13.FEB.2019 23:57:57

EGPRS1900_512

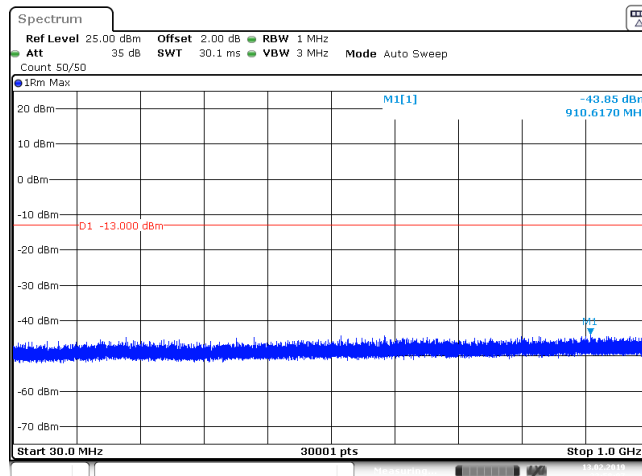

Date: 13.FEB.2019 23:58:07

EGPRS1900_512

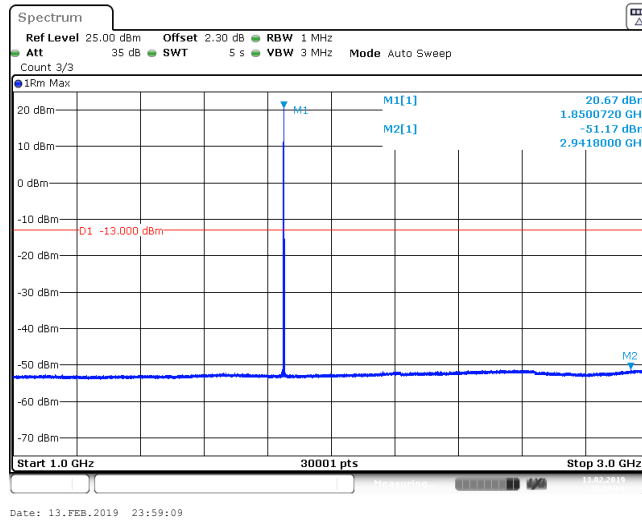

EGPRS1900_512

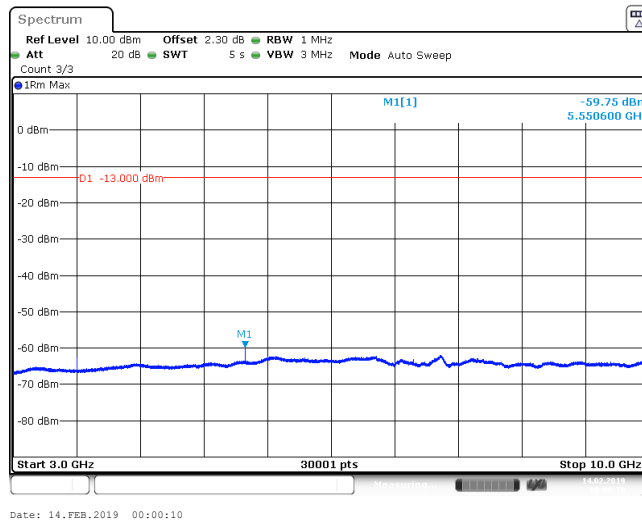

EGPRS1900_512

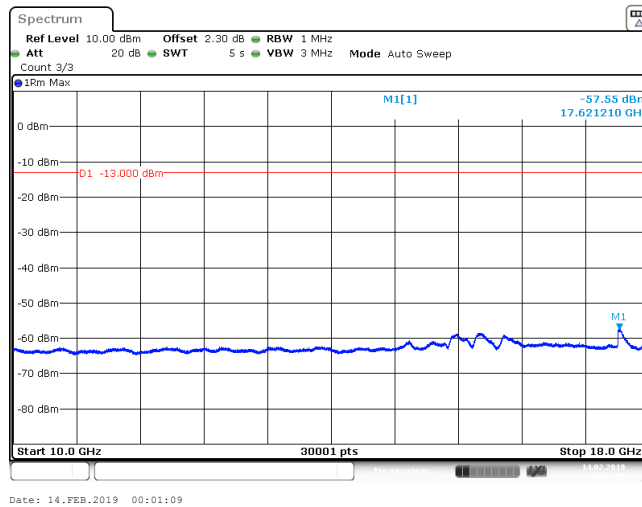

EGPRS1900_512

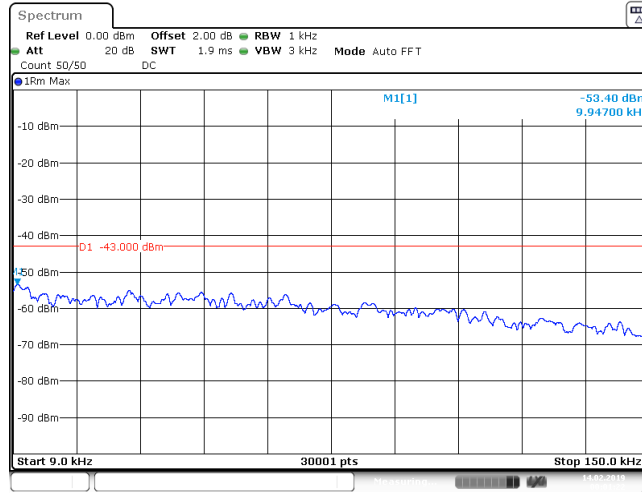

Date: 14.FEB.2019 00:01:22

EGPRS1900_661

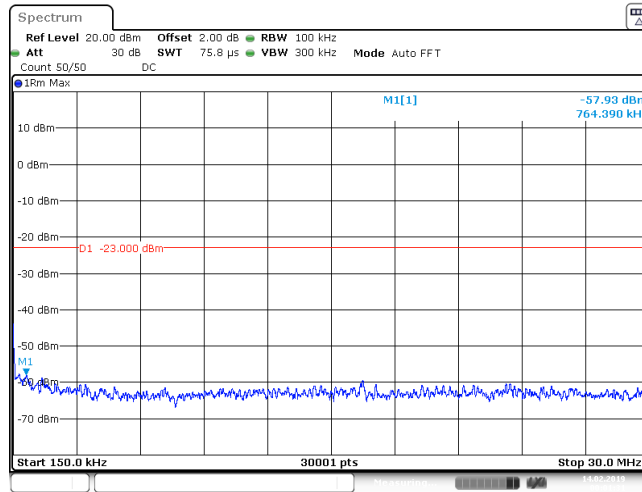

Date: 14.FEB.2019 00:01:31

EGPRS1900_661

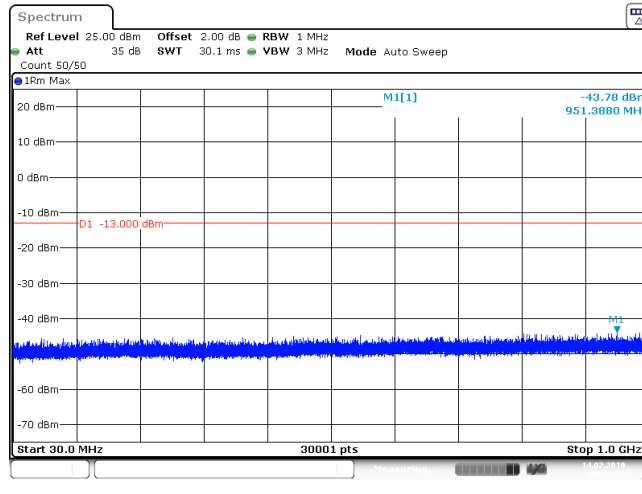

Date: 14.FEB.2019 00:01:42

EGPRS1900_661

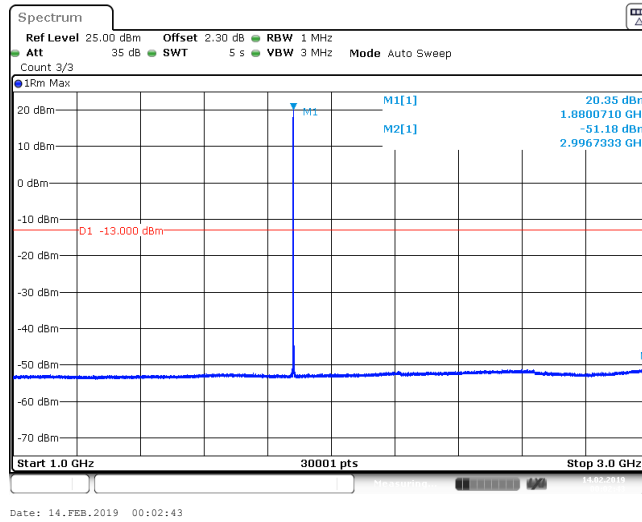

EGPRS1900_661

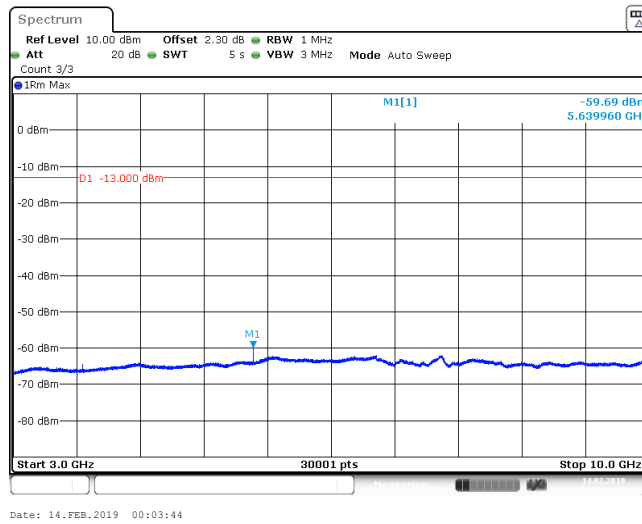

EGPRS1900_661

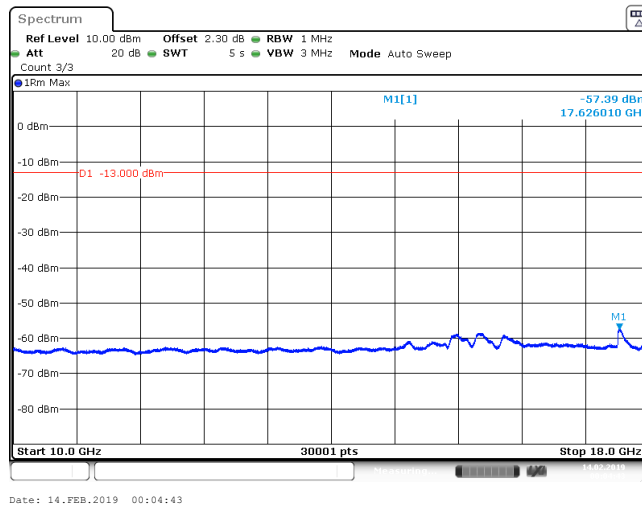

EGPRS1900_661

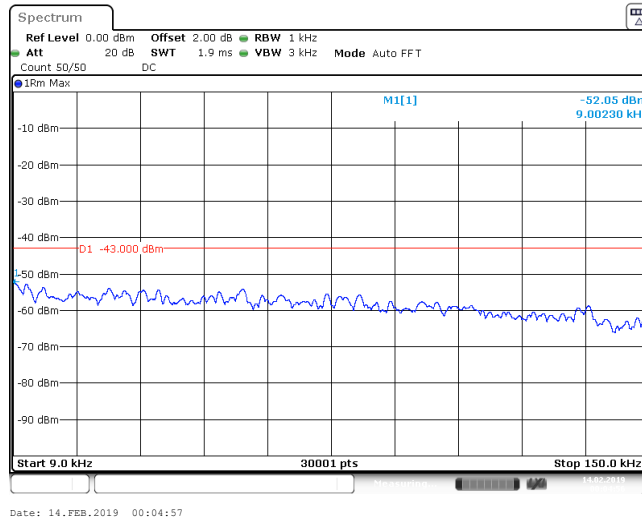

EGPRS1900_810

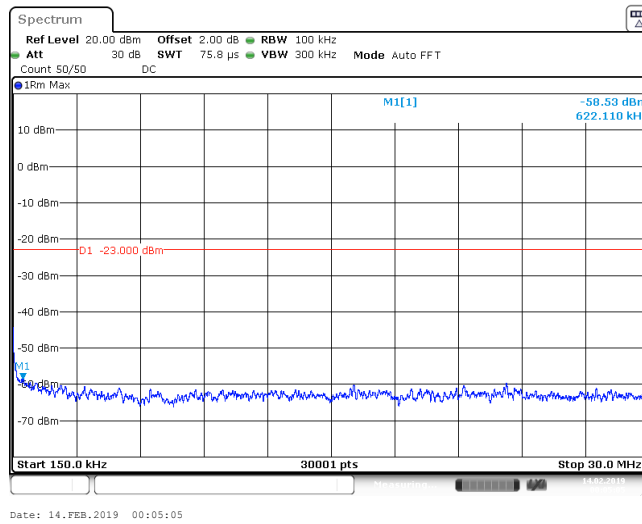

EGPRS1900_810

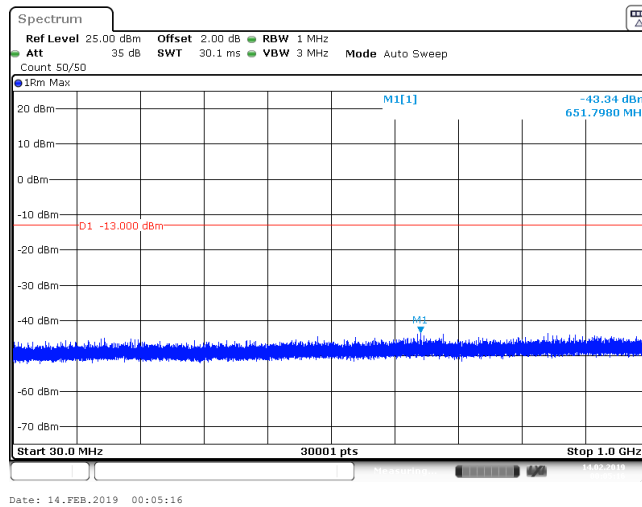

EGPRS1900_810

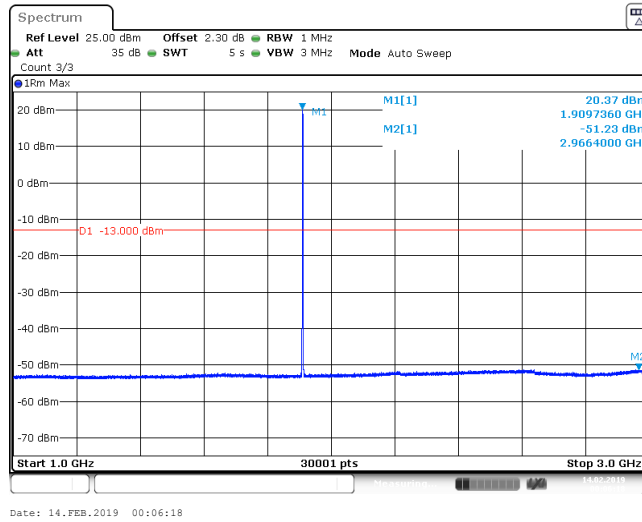

EGPRS1900_810

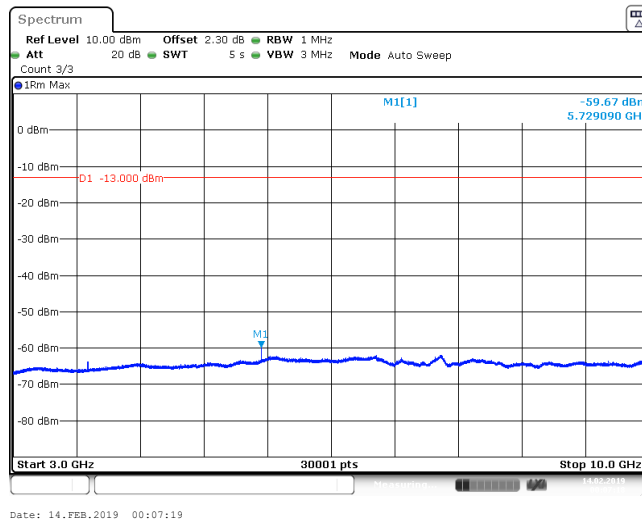

EGPRS1900_810

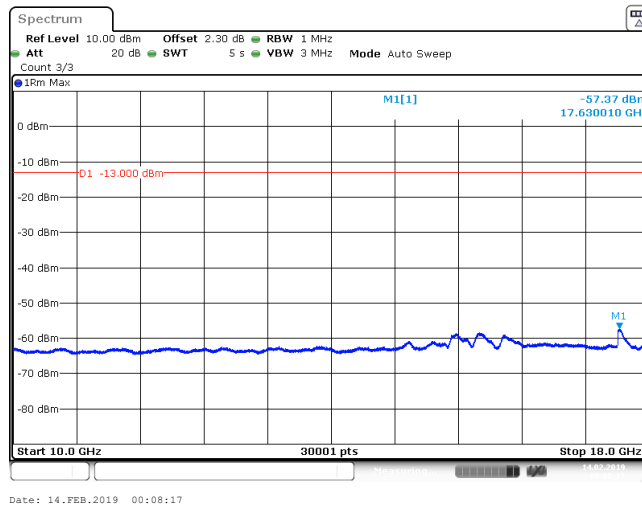

EGPRS1900_810

Band	Channel	Frequency Rang(Mhz)	Value(dBm)	Limit(dBm)	Verdict
Band II	9262	30~1000	-45.32	-13.00	PASS
Band II	9262	1000~3000	-52.75	-13.00	PASS
Band II	9262	3000~10000	-63.41	-13.00	PASS
Band II	9262	10000~20000	-58.83	-13.00	PASS
Band II	9400	30~1000	-44.26	-13.00	PASS
Band II	9400	1000~3000	-52.77	-13.00	PASS
Band II	9400	3000~10000	-63.37	-13.00	PASS
Band II	9400	10000~20000	-58.80	-13.00	PASS
Band II	9538	30~1000	-43.94	-13.00	PASS
Band II	9538	1000~3000	-52.46	-13.00	PASS
Band II	9538	3000~10000	-63.29	-13.00	PASS
Band II	9538	10000~20000	-58.68	-13.00	PASS
Band V	4132	30~1000	-30.56	-13.00	PASS
Band V	4132	1000~3000	-36.50	-13.00	PASS
Band V	4132	3000~10000	-44.99	-13.00	PASS
Band V	4132	10000~18000	-34.42	-13.00	PASS
Band V	4182	30~1000	-30.77	-13.00	PASS
Band V	4182	1000~3000	-36.49	-13.00	PASS
Band V	4182	3000~10000	-45.07	-13.00	PASS
Band V	4182	10000~18000	-34.46	-13.00	PASS
Band V	4233	30~1000	-30.90	-13.00	PASS
Band V	4233	1000~3000	-36.35	-13.00	PASS
Band V	4233	3000~10000	-44.97	-13.00	PASS
Band V	4233	10000~18000	-34.51	-13.00	PASS

Test Graphs

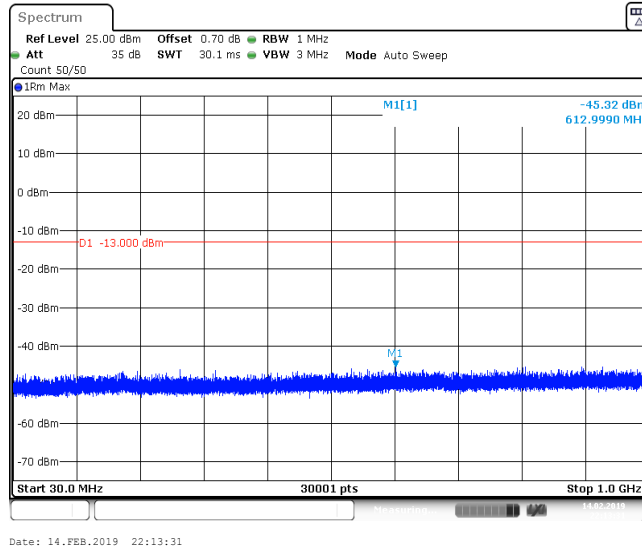

Band II_9262

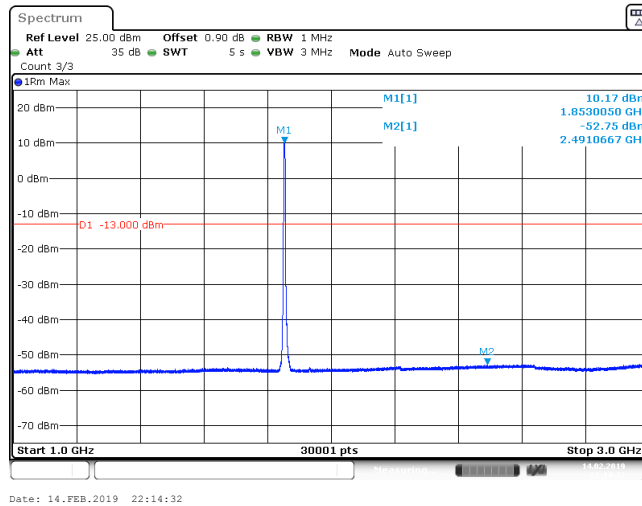

Band II_9262

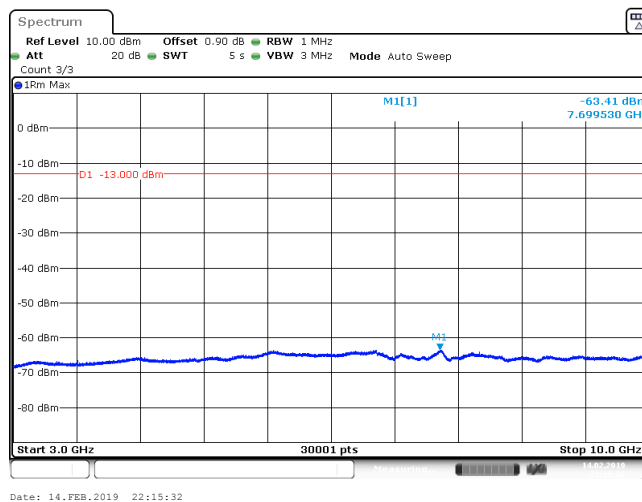

Band II_9262

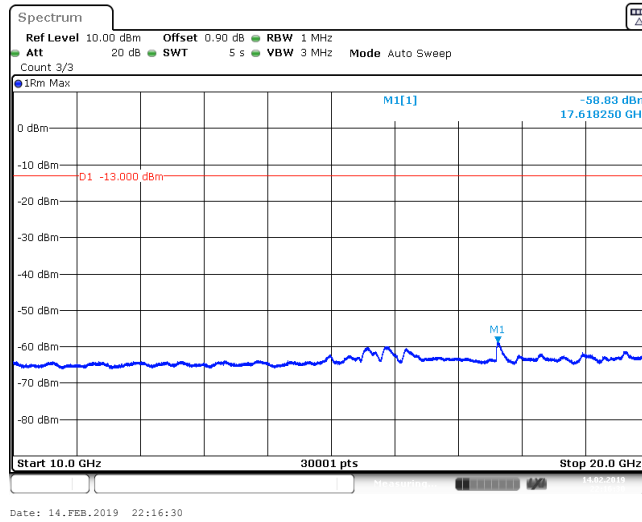

Band II_9262

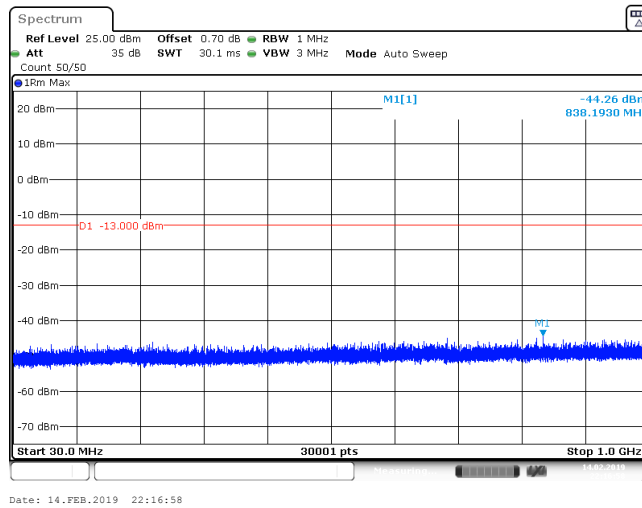

Band II_9400

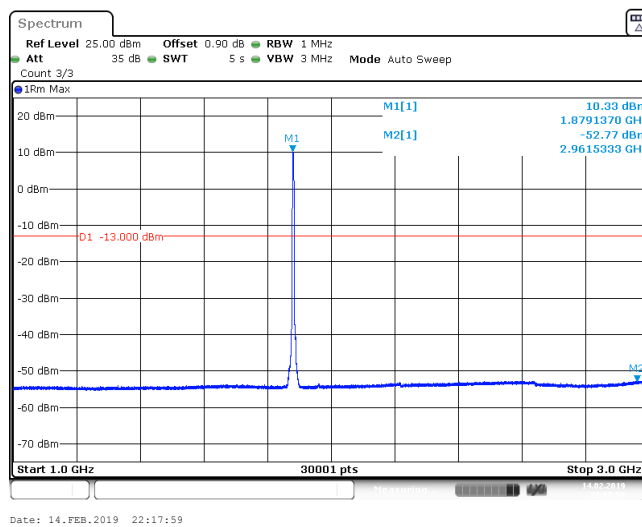

Band II_9400

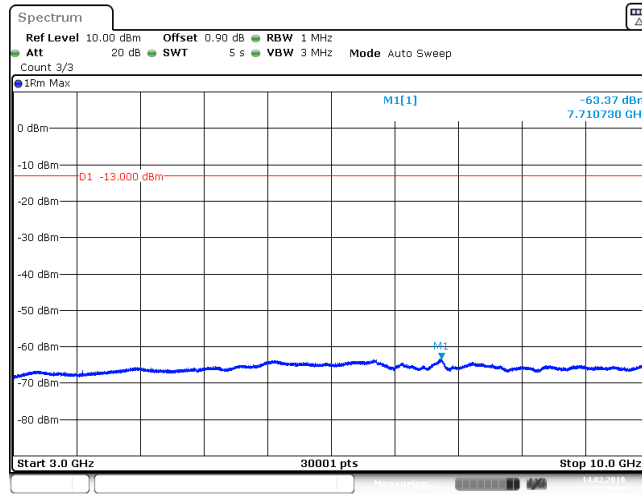

Date: 14.FEB.2019 22:18:59

Band II_9400

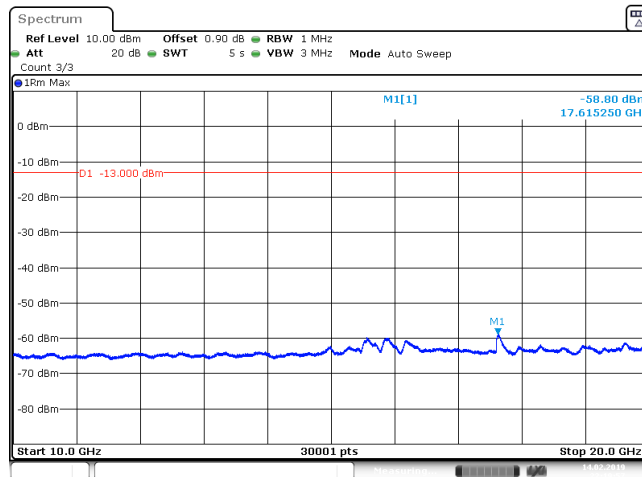

Date: 14.FEB.2019 22:19:57

Band II_9400

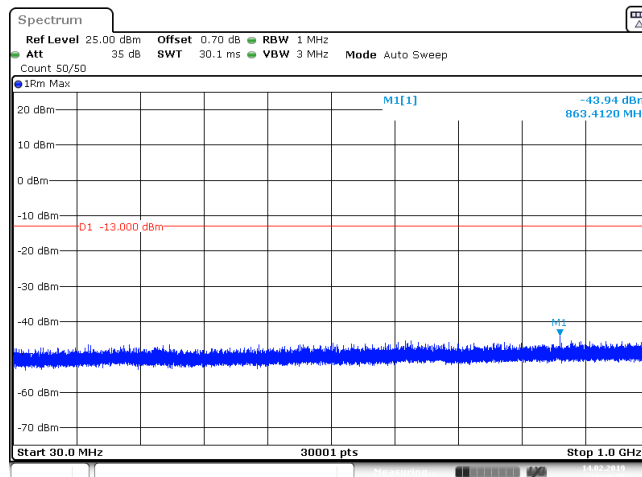

Date: 14.FEB.2019 22:20:24

Band II_9538

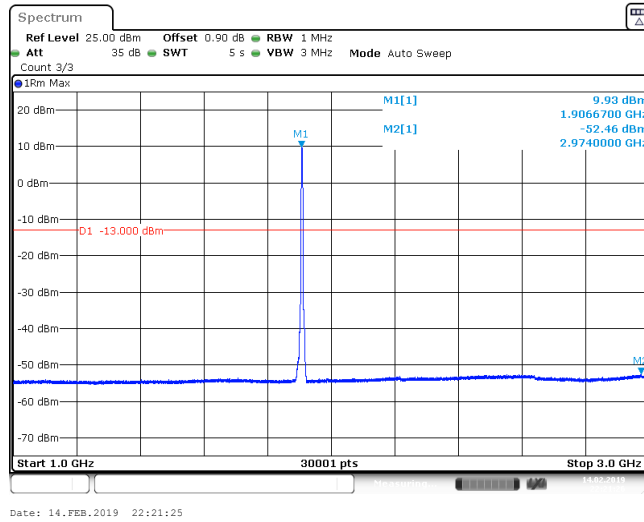

Band II_9538

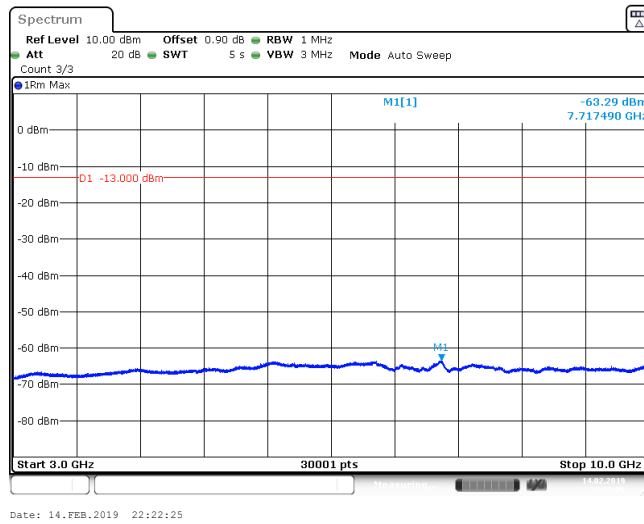

Band II_9538

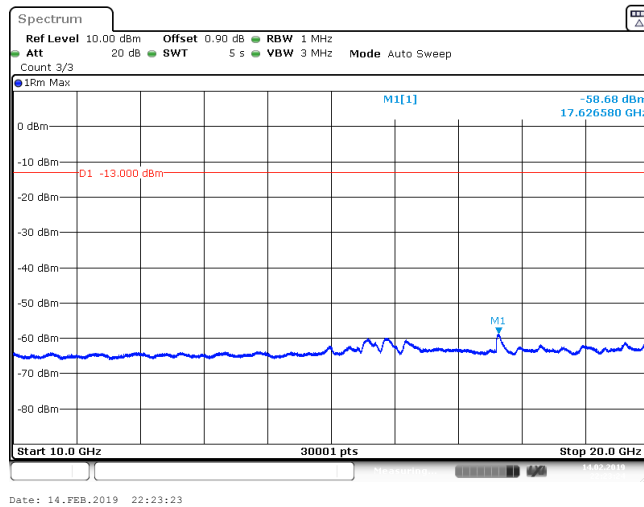

Band II_9538

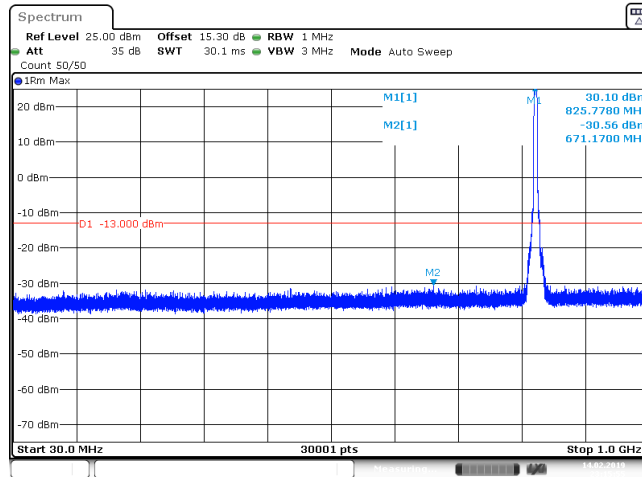

Band V_4132

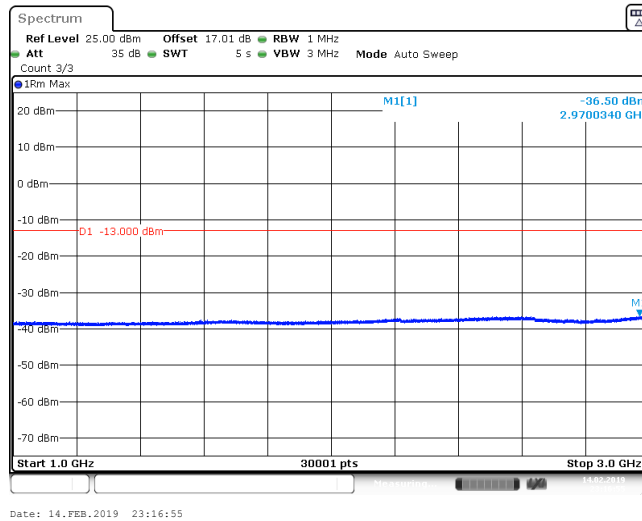

Band V_4132

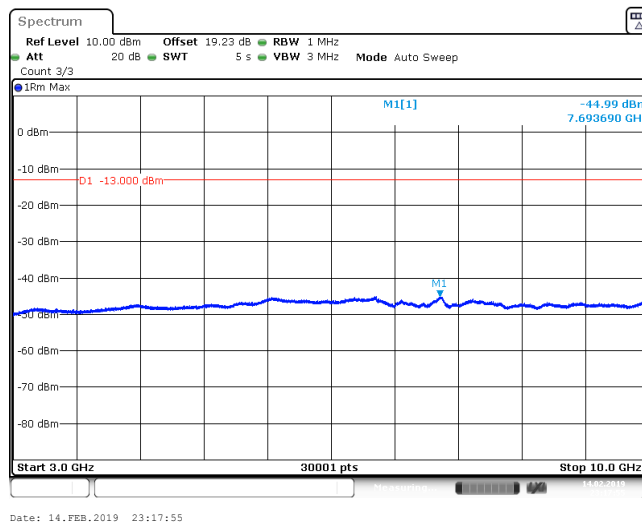

Band V_4132

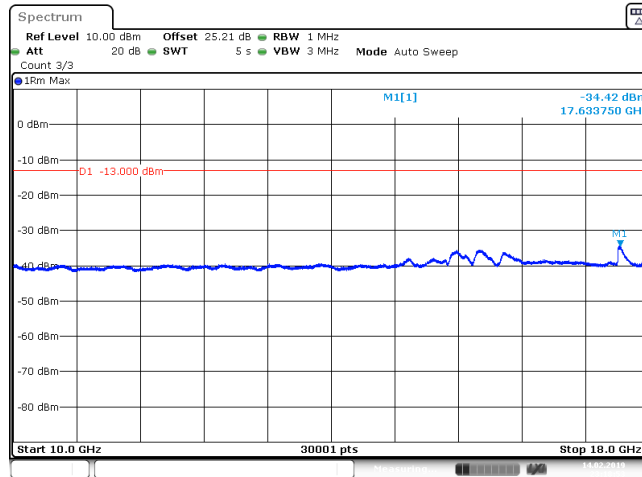

Date: 14.FEB.2019 23:18:53

Band V_4132

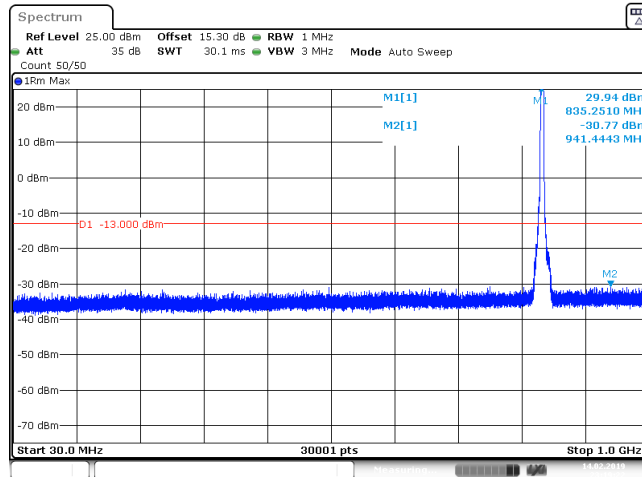

Date: 14.FEB.2019 23:19:22

Band V_4182

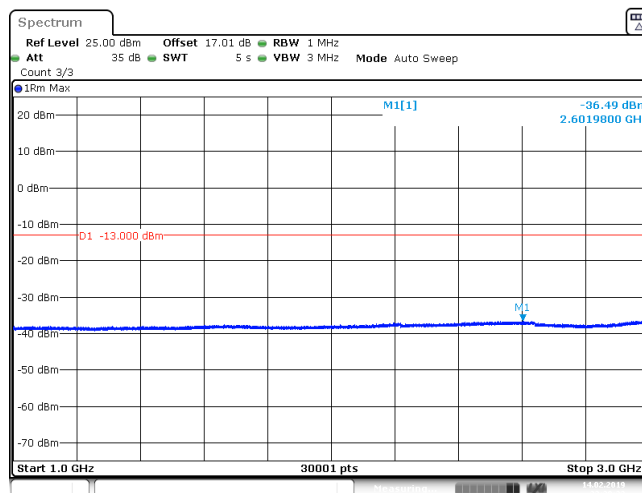

Date: 14.FEB.2019 23:20:22

Band V_4182

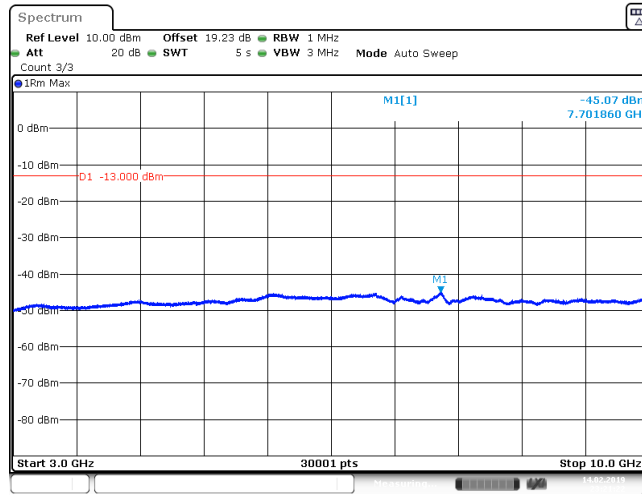

Date: 14.FEB.2019 23:21:22

Band V_4182

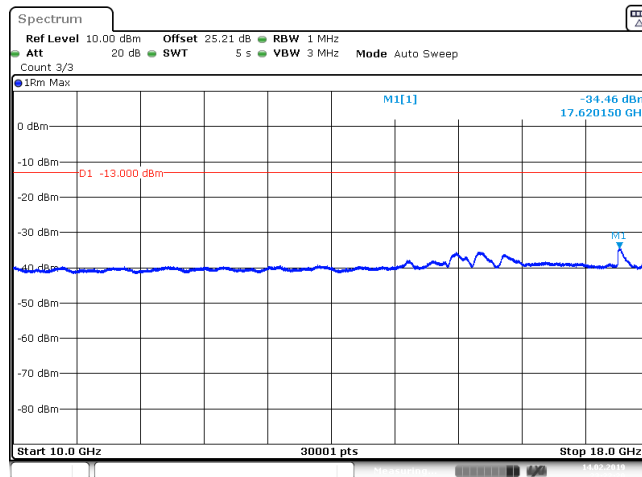

Date: 14.FEB.2019 23:22:20

Band V_4182

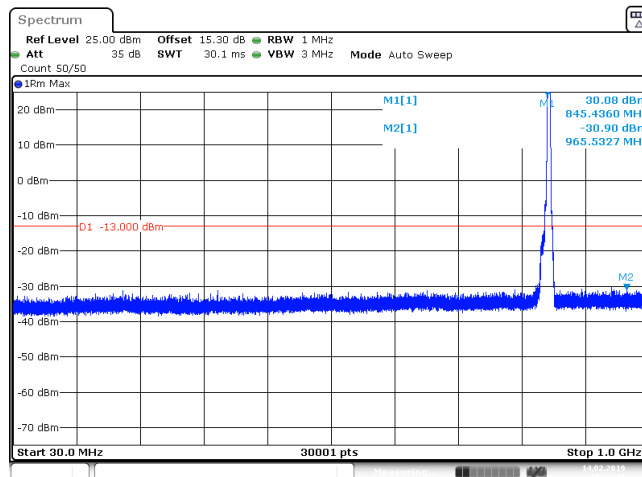

Date: 14.FEB.2019 23:22:48

Band V_4233

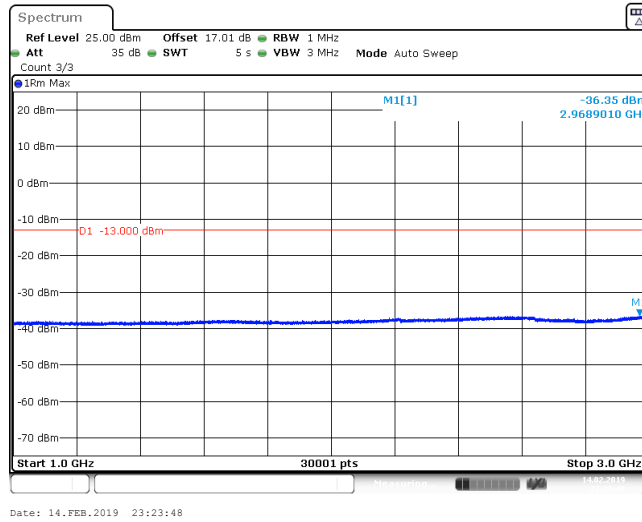

Band V_4233

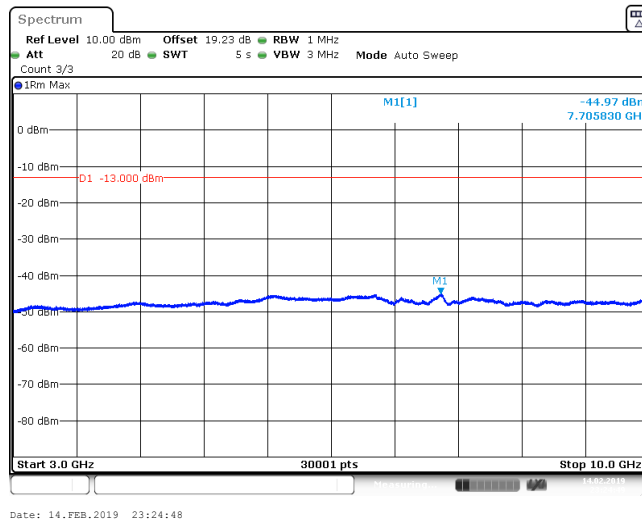

Band V_4233

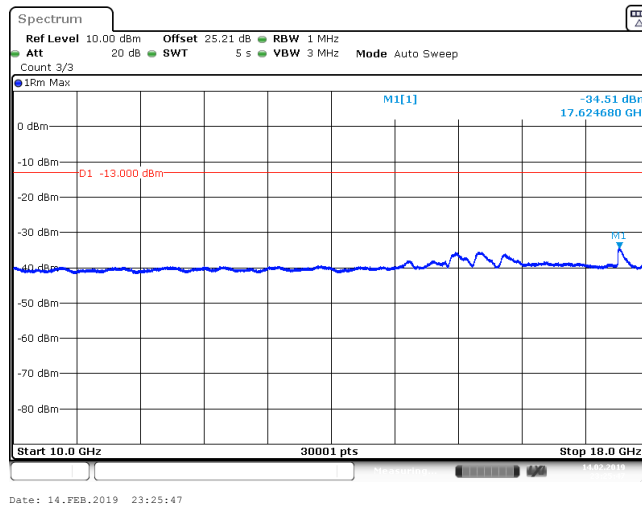

Band V_4233

Frequency Stability

Frequency Error vs. Voltage:

Test Band	Test Mode	Test Channel	Test Temp.	Test Volt.	Freq.Error (Hz)	Freq.vs.rated (ppm)	Limit (ppm)	Verdict
GSM850	GPRS	LCH	TN	VL	14.81	0.017965	±2.5	PASS
			TN	VN	-83.66	-0.101510	±2.5	PASS
			TN	VH	-67.58	-0.081989	±2.5	PASS
		MCH	TN	VL	4.64	0.005551	±2.5	PASS
			TN	VN	-1.08	-0.001287	±2.5	PASS
			TN	VH	2.54	0.003031	±2.5	PASS
		HCH	TN	VL	6.43	0.007573	±2.5	PASS
			TN	VN	3.88	0.004574	±2.5	PASS
			TN	VH	2.42	0.002845	±2.5	PASS

Test Band	Test Mode	Test Channel	Test Temp.	Test Volt.	Freq.Error (Hz)	Freq.vs.rated (ppm)	Limit (ppm)	Verdict
GSM850	EDGE	LCH	TN	VL	1.94	0.002353	±2.5	PASS
			TN	VN	1.69	0.002049	±2.5	PASS
			TN	VH	1.71	0.002074	±2.5	PASS
		MCH	TN	VL	1.82	0.002175	±2.5	PASS
			TN	VN	1.54	0.001840	±2.5	PASS
			TN	VH	1.71	0.002043	±2.5	PASS
		HCH	TN	VL	1.94	0.002284	±2.5	PASS
			TN	VN	1.85	0.002178	±2.5	PASS
			TN	VH	1.64	0.001931	±2.5	PASS

Test Band	Test Mode	Test Channel	Test Temp.	Test Volt.	Freq.Error (Hz)	Freq.vs.rated (ppm)	Limit (ppm)	Verdict
GSM1900	GPRS	LCH	TN	VL	-28.48	-0.015391	±2.5	PASS
			TN	VN	-24.78	-0.013395	±2.5	PASS
			TN	VH	-31.23	-0.016879	±2.5	PASS
		MCH	TN	VL	-24.55	-0.013057	±2.5	PASS
			TN	VN	-40.96	-0.021789	±2.5	PASS
			TN	VH	-41.26	-0.021944	±2.5	PASS
		HCH	TN	VL	-52.25	-0.027360	±2.5	PASS
			TN	VN	-50.96	-0.026685	±2.5	PASS
			TN	VH	-55.43	-0.029024	±2.5	PASS

Test Band	Test Mode	Test Channel	Test Temp.	Test Volt.	Freq.Error (Hz)	Freq.vs.rated (ppm)	Limit (ppm)	Verdict
GSM1900	EDGE	LCH	TN	VL	3.27	0.001769	±2.5	PASS
			TN	VN	3.10	0.001673	±2.5	PASS
			TN	VH	3.40	0.001835	±2.5	PASS
		MCH	TN	VL	3.75	0.001992	±2.5	PASS
			TN	VN	3.35	0.001779	±2.5	PASS
			TN	VH	3.80	0.002019	±2.5	PASS
		HCH	TN	VL	3.65	0.001909	±2.5	PASS
			TN	VN	3.60	0.001882	±2.5	PASS
			TN	VH	3.30	0.001725	±2.5	PASS

Test Band	Test Mode	Test Channel	Test Temp.	Test Volt.	Freq.Error (Hz)	Freq.vs.rated (ppm)	Limit (ppm)	Verdict
WCDMA8 50	RCM	LCH	TN	VL	-1.64	-0.001985	±2.5	PASS
			TN	VN	-2.05	-0.002481	±2.5	PASS
			TN	VH	-3.05	-0.003691	±2.5	PASS
		MCH	TN	VL	-0.94	-0.001124	±2.5	PASS
			TN	VN	1.15	0.001375	±2.5	PASS
			TN	VH	-2.20	-0.002630	±2.5	PASS
		HCH	TN	VL	-4.50	-0.005315	±2.5	PASS
			TN	VN	-3.85	-0.004548	±2.5	PASS
			TN	VH	-4.12	-0.004867	±2.5	PASS

Test Band	Test Mode	Test Channel	Test Temp.	Test Volt.	Freq.Error (Hz)	Freq.vs.rated (ppm)	Limit (ppm)	Verdict
WCDMA1 900	RCM	LCH	TN	VL	-4.17	-0.002251	±2.5	PASS
			TN	VN	0.22	0.000119	±2.5	PASS
			TN	VH	-2.26	-0.001220	±2.5	PASS
		MCH	TN	VL	-4.08	-0.002170	±2.5	PASS
			TN	VN	0.22	0.000117	±2.5	PASS
			TN	VH	1.67	0.000888	±2.5	PASS
		HCH	TN	VL	-7.72	-0.004047	±2.5	PASS
			TN	VN	0.22	0.000115	±2.5	PASS
			TN	VH	0.42	0.000220	±2.5	PASS

Frequency Error vs. Temperature:

Test Band	Test Mode	Test Channel	Test Volt.	Test Temp	Freq.Error (Hz)	Freq.vs.rated (ppm)	Limit (ppm)	Verdict
GSM850	GPRS	LCH	VN	-30	14.03	0.017021	±2.5	PASS
			VN	-20	12.67	0.015376	±2.5	PASS
			VN	-10	-5.59	-0.006785	±2.5	PASS
			VN	0	21.54	0.026131	±2.5	PASS
			VN	10	10.09	0.012244	±2.5	PASS
			VN	20	11.00	0.013340	±2.5	PASS
			VN	30	-5.68	-0.006893	±2.5	PASS
			VN	40	12.28	0.014904	±2.5	PASS
			VN	50	12.67	0.015376	±2.5	PASS
GSM850	GPRS	MCH	VN	-30	6.71	0.008020	±2.5	PASS
			VN	-20	5.34	0.006386	±2.5	PASS
			VN	-10	19.12	0.022860	±2.5	PASS
			VN	0	-2.39	-0.002862	±2.5	PASS
			VN	10	-2.56	-0.003065	±2.5	PASS
			VN	20	-2.15	-0.002566	±2.5	PASS
			VN	30	-1.88	-0.002253	±2.5	PASS
			VN	40	15.69	0.018753	±2.5	PASS
			VN	50	-5.74	-0.006865	±2.5	PASS
GSM850	GPRS	HCH	VN	-30	1.59	0.001874	±2.5	PASS
			VN	-20	0.88	0.001033	±2.5	PASS
			VN	-10	-3.55	-0.004180	±2.5	PASS
			VN	0	-5.76	-0.006781	±2.5	PASS
			VN	10	-0.29	-0.000346	±2.5	PASS
			VN	20	2.35	0.002769	±2.5	PASS
			VN	30	-2.62	-0.003092	±2.5	PASS
			VN	40	1.10	0.001292	±2.5	PASS
			VN	50	8.48	0.009988	±2.5	PASS

Test Band	Test Mode	Test Channel	Test Volt.	Test Temp	Freq.Error (Hz)	Freq.vs.rated (ppm)	Limit (ppm)	Verdict
GSM850	EDGE	LCH	VN	-30	1.52	0.001843	±2.5	PASS
			VN	-20	1.64	0.001989	±2.5	PASS
			VN	-10	1.79	0.002171	±2.5	PASS
			VN	0	1.77	0.002146	±2.5	PASS
			VN	10	1.79	0.002171	±2.5	PASS
			VN	20	1.79	0.002171	±2.5	PASS
			VN	30	1.70	0.002061	±2.5	PASS
			VN	40	1.77	0.002146	±2.5	PASS
			VN	50	1.79	0.002171	±2.5	PASS
GSM850	EDGE	MCH	VN	-30	1.62	0.001936	±2.5	PASS
			VN	-20	1.62	0.001936	±2.5	PASS
			VN	-10	1.50	0.001792	±2.5	PASS
			VN	0	1.74	0.002079	±2.5	PASS
			VN	10	1.61	0.001924	±2.5	PASS
			VN	20	1.59	0.001906	±2.5	PASS
			VN	30	1.70	0.002032	±2.5	PASS
			VN	40	1.57	0.001882	±2.5	PASS
			VN	50	1.66	0.001984	±2.5	PASS
GSM850	EDGE	HCH	VN	-30	1.70	0.002002	±2.5	PASS
			VN	-20	1.58	0.001860	±2.5	PASS
			VN	-10	1.56	0.001837	±2.5	PASS
			VN	0	1.49	0.001754	±2.5	PASS
			VN	10	1.61	0.001896	±2.5	PASS
			VN	20	1.90	0.002234	±2.5	PASS
			VN	30	1.71	0.002020	±2.5	PASS
			VN	40	2.05	0.002409	±2.5	PASS
			VN	50	1.80	0.002119	±2.5	PASS

Test Band	Test Mode	Test Channel	Test Volt.	Test Temp	Freq.Error (Hz)	Freq.vs.rated (ppm)	Limit (ppm)	Verdict
GSM1900	GPRS	LCH	VN	-30	-60.50	-0.032700	±2.5	PASS
			VN	-20	-57.99	-0.031344	±2.5	PASS
			VN	-10	-39.31	-0.021245	±2.5	PASS
			VN	0	-28.93	-0.015635	±2.5	PASS
			VN	10	-35.80	-0.019350	±2.5	PASS
			VN	20	-33.04	-0.017857	±2.5	PASS
			VN	30	-39.72	-0.021468	±2.5	PASS
			VN	40	-31.04	-0.016774	±2.5	PASS
			VN	50	-33.58	-0.018149	±2.5	PASS
GSM1900	GPRS	MCH	VN	-30	-55.57	-0.029561	±2.5	PASS
			VN	-20	-40.65	-0.021621	±2.5	PASS
			VN	-10	-50.04	-0.026616	±2.5	PASS
			VN	0	-46.31	-0.024635	±2.5	PASS
			VN	10	-46.60	-0.024790	±2.5	PASS
			VN	20	-67.00	-0.035638	±2.5	PASS
			VN	30	-67.02	-0.035650	±2.5	PASS
			VN	40	-39.99	-0.021272	±2.5	PASS
			VN	50	-69.34	-0.036885	±2.5	PASS
GSM1900	GPRS	HCH	VN	-30	-66.09	-0.034605	±2.5	PASS
			VN	-20	-44.87	-0.023492	±2.5	PASS
			VN	-10	-57.14	-0.029922	±2.5	PASS
			VN	0	-46.91	-0.024564	±2.5	PASS
			VN	10	-71.22	-0.037293	±2.5	PASS
			VN	20	-66.10	-0.034610	±2.5	PASS
			VN	30	-66.23	-0.034677	±2.5	PASS
			VN	40	-70.62	-0.036978	±2.5	PASS
			VN	50	-62.18	-0.032558	±2.5	PASS

Test Band	Test Mode	Test Channel	Test Volt.	Test Temp	Freq.Error (Hz)	Freq.vs.rated (ppm)	Limit (ppm)	Verdict
GSM1900	EDGE	LCH	VN	-30	3.80	0.002051	±2.5	PASS
			VN	-20	3.60	0.001943	±2.5	PASS
			VN	-10	2.99	0.001614	±2.5	PASS
			VN	0	2.62	0.001417	±2.5	PASS
			VN	10	3.70	0.001997	±2.5	PASS
			VN	20	3.27	0.001765	±2.5	PASS
			VN	30	3.45	0.001863	±2.5	PASS
			VN	40	3.35	0.001808	±2.5	PASS
			VN	50	3.43	0.001855	±2.5	PASS
GSM1900	EDGE	MCH	VN	-30	3.60	0.001912	±2.5	PASS
			VN	-20	3.35	0.001779	±2.5	PASS
			VN	-10	3.44	0.001828	±2.5	PASS
			VN	0	3.40	0.001806	±2.5	PASS
			VN	10	3.85	0.002045	±2.5	PASS
			VN	20	3.50	0.001859	±2.5	PASS
			VN	30	3.32	0.001763	±2.5	PASS
			VN	40	4.20	0.002231	±2.5	PASS
			VN	50	3.35	0.001781	±2.5	PASS
GSM1900	EDGE	HCH	VN	-30	3.25	0.001700	±2.5	PASS
			VN	-20	2.92	0.001531	±2.5	PASS
			VN	-10	3.52	0.001841	±2.5	PASS
			VN	0	2.97	0.001556	±2.5	PASS
			VN	10	3.20	0.001674	±2.5	PASS
			VN	20	3.35	0.001753	±2.5	PASS
			VN	30	3.15	0.001647	±2.5	PASS
			VN	40	2.98	0.001561	±2.5	PASS
			VN	50	3.40	0.001778	±2.5	PASS

Test Band	Test Mode	Test Channel	Test Volt.	Test Temp	Freq.Error (Hz)	Freq.vs.rated (ppm)	Limit (ppm)	Verdict
WCDMA8 50	RCM	LCH	VN	-30	-7.94	-0.009608	±2.5	PASS
			VN	-20	-5.57	-0.006740	±2.5	PASS
			VN	-10	4.61	0.005578	±2.5	PASS
			VN	0	1.68	0.002033	±2.5	PASS
			VN	10	-3.88	-0.004695	±2.5	PASS
			VN	20	-2.94	-0.003558	±2.5	PASS
			VN	30	-5.42	-0.006559	±2.5	PASS
			VN	40	-6.85	-0.008289	±2.5	PASS
			VN	50	6.64	0.008035	±2.5	PASS
WCDMA8 50	RCM	MCH	VN	-30	-10.05	-0.012016	±2.5	PASS
			VN	-20	-5.92	-0.007078	±2.5	PASS
			VN	-10	-7.71	-0.009218	±2.5	PASS
			VN	0	5.18	0.006193	±2.5	PASS
			VN	10	6.28	0.007508	±2.5	PASS
			VN	20	-4.15	-0.004962	±2.5	PASS
			VN	30	-3.02	-0.003611	±2.5	PASS
			VN	40	-1.58	-0.001889	±2.5	PASS
			VN	50	1.13	0.001351	±2.5	PASS
WCDMA8 50	RCM	HCH	VN	-30	6.12	0.007229	±2.5	PASS
			VN	-20	0.29	0.000343	±2.5	PASS
			VN	-10	4.28	0.005056	±2.5	PASS
			VN	0	-0.36	-0.000425	±2.5	PASS
			VN	10	-1.25	-0.001476	±2.5	PASS
			VN	20	-5.51	-0.006508	±2.5	PASS
			VN	30	-4.57	-0.005398	±2.5	PASS
			VN	40	-3.35	-0.003957	±2.5	PASS
			VN	50	-2.20	-0.002599	±2.5	PASS

Test Band	Test Mode	Test Channel	Test Volt.	Test Temp	Freq.Error (Hz)	Freq.vs.rated (ppm)	Limit (ppm)	Verdict
WCDMA1 900	RCM	LCH	VN	-30	-5.29	-0.002856	±2.5	PASS
			VN	-20	-2.27	-0.001225	±2.5	PASS
			VN	-10	1.30	0.000702	±2.5	PASS
			VN	0	-4.37	-0.002359	±2.5	PASS
			VN	10	-4.46	-0.002408	±2.5	PASS
			VN	20	-6.23	-0.003363	±2.5	PASS
			VN	30	0.42	0.000227	±2.5	PASS
			VN	40	-7.19	-0.003881	±2.5	PASS
			VN	50	-3.69	-0.001992	±2.5	PASS
WCDMA1 900	RCM	MCH	VN	-30	1.82	0.000968	±2.5	PASS
			VN	-20	-4.18	-0.002223	±2.5	PASS
			VN	-10	-2.76	-0.001468	±2.5	PASS
			VN	0	-3.07	-0.001633	±2.5	PASS
			VN	10	2.40	0.001277	±2.5	PASS
			VN	20	-2.75	-0.001463	±2.5	PASS
			VN	30	0.43	0.000229	±2.5	PASS
			VN	40	2.02	0.001074	±2.5	PASS
			VN	50	-4.59	-0.002441	±2.5	PASS
WCDMA1 900	RCM	HCH	VN	-30	-3.10	-0.001625	±2.5	PASS
			VN	-20	-0.46	-0.000241	±2.5	PASS
			VN	-10	-2.74	-0.001436	±2.5	PASS
			VN	0	-3.16	-0.001657	±2.5	PASS
			VN	10	-4.31	-0.002259	±2.5	PASS
			VN	20	-5.33	-0.002794	±2.5	PASS
			VN	30	-0.31	-0.000163	±2.5	PASS
			VN	40	-1.99	-0.001043	±2.5	PASS
			VN	50	-5.16	-0.002705	±2.5	PASS

Note:

1. Normal Voltage = 3.8V. ; Battery End Point (BEP) = 3.5 V. ; Maximum Voltage = 4.2 V
2. The frequency fundamental emissions stay within the authorized frequency block based on the frequency deviation measured is small.

Appendix B. Test Results of Radiated Test

Radiated Spurious Emission

GSM850 (GPRS)									
Channel	Frequency (MHz)	EIRP (dBm)	Limit (dBm)	Over Limit (dB)	SPA Reading (dBm)	S.G. Power (dBm)	TX Cable loss (dB)	TX Antenna Gain (dBi)	Polarization (H/V)
Lowest	1648.4	-51.17	-13	-38.17	-57.57	-55.64	2.78	9.40	H
	2472.6	-41.91	-13	-28.91	-50.94	-46.66	3.7	10.60	H
	3296.8	-56.11	-13	-43.11	-65.22	-62.30	3.35	11.69	H
	1648.4	-55.63	-13	-42.63	-61.92	-60.10	2.78	9.40	V
	2472.6	-46.09	-13	-33.09	-54.66	-50.84	3.70	10.60	V
	3296.8	-55.59	-13	-42.59	-64.45	-61.78	3.35	11.69	V
Middle	1672	-52.71	-13	-39.71	-59.16	-57.18	2.78	9.40	H
	2510	-56.19	-13	-43.19	-65.28	-60.94	3.7	10.60	H
	3346	-55.26	-13	-42.26	-64.58	-61.45	3.35	11.69	H
	1672	-56.42	-13	-43.42	-62.73	-60.89	2.78	9.40	V
	2510	-56.45	-13	-43.45	-65.07	-61.20	3.70	10.60	V
	3346	-55.76	-13	-42.76	-64.83	-61.95	3.35	11.69	V
Highest	1697.6	-53.82	-13	-40.82	-60.32	-58.29	2.78	9.40	H
	2546.4	-55.50	-13	-42.50	-64.58	-60.25	3.7	10.60	H
	3395.2	-55.49	-13	-42.49	-65.03	-61.68	3.35	11.69	H
	1697.6	-54.41	-13	-41.41	-60.74	-58.88	2.78	9.40	V
	2546.4	-56.51	-13	-43.51	-65.12	-61.26	3.70	10.60	V
	3395.2	-55.56	-13	-42.56	-64.85	-61.75	3.35	11.69	V

Remark: Spurious emissions within 30-1000MHz were found more than 20dB below limit line.

GSM850 (EDGE Class8)									
Channel	Frequency (MHz)	EIRP (dBm)	Limit (dBm)	Over Limit (dB)	SPA Reading (dBm)	S.G. Power (dBm)	TX Cable loss (dB)	TX Antenna Gain (dBi)	Polarization (H/V)
Lowest	1648.4	-52.80	-13	-39.80	-59.20	-57.27	2.78	9.40	H
	2472.6	-55.55	-13	-42.55	-64.58	-60.30	3.7	10.60	H
	3296.8	-55.28	-13	-42.28	-64.39	-61.47	3.35	11.69	H
	1648.4	-57.66	-13	-44.66	-63.95	-62.13	2.78	9.40	V
	2472.6	-55.66	-13	-42.66	-64.23	-60.41	3.70	10.60	V
	3296.8	-55.72	-13	-42.72	-64.58	-61.91	3.35	11.69	V
Middle	1672	-53.46	-13	-40.46	-59.91	-57.93	2.78	9.40	H
	2510	-56.41	-13	-43.41	-65.50	-61.16	3.7	10.60	H
	3346	-55.43	-13	-42.43	-64.75	-61.62	3.35	11.69	H
	1672	-57.75	-13	-44.75	-64.06	-62.22	2.78	9.40	V
	2510	-56.53	-13	-43.53	-65.15	-61.28	3.70	10.60	V
	3346	-56.06	-13	-43.06	-65.13	-62.25	3.35	11.69	V
Highest	1697.6	-54.42	-13	-41.42	-60.92	-58.89	2.78	9.40	H
	2546.4	-55.31	-13	-42.31	-64.39	-60.06	3.7	10.60	H
	3395.2	-55.07	-13	-42.07	-64.61	-61.26	3.35	11.69	H
	1697.6	-57.33	-13	-44.33	-63.66	-61.80	2.78	9.40	V
	2546.4	-56.61	-13	-43.61	-65.22	-61.36	3.70	10.60	V
	3395.2	-54.58	-13	-41.58	-63.87	-60.77	3.35	11.69	V

Remark: Spurious emissions within 30-1000MHz were found more than 20dB below limit line.

GSM1900 (GPRS)									
Channel	Frequency (MHz)	EIRP (dBm)	Limit (dBm)	Over Limit (dB)	SPA Reading (dBm)	S.G. Power (dBm)	TX Cable loss (dB)	TX Antenna Gain (dBi)	Polarization (H/V)
Lowest	3700.4	-53.45	-13	-40.45	-64.25	-59.49	6.56	12.60	H
	5550.6	-49.23	-13	-36.23	-65.14	-54.33	8	13.10	H
	7400.8	-45.59	-13	-32.59	-67.79	-47.32	9.57	11.30	H
	3700.4	-53.36	-13	-40.36	-63.87	-59.40	6.56	12.6	V
	5550.6	-51.03	-13	-38.03	-65.74	-56.13	8	13.1	V
	7400.8	-45.26	-13	-32.26	-67.18	-46.99	9.57	11.3	V
Middle	3760	-53.11	-13	-40.11	-64.11	-59.15	6.56	12.60	H
	5640	-49.96	-13	-36.96	-66.09	-55.06	8	13.10	H
	7520	-45.66	-13	-32.66	-68.09	-47.39	9.57	11.30	H
	3760	-54.01	-13	-41.01	-64.71	-60.05	6.56	12.6	V
	5640	-50.78	-13	-37.78	-65.74	-55.88	8	13.1	V
	7520	-45.75	-13	-32.75	-67.98	-47.48	9.57	11.3	V
Highest	3819.6	-52.39	-13	-39.39	-63.41	-58.43	6.56	12.60	H
	5729.4	-49.88	-13	-36.88	-66.24	-54.98	8	13.10	H
	7639.2	-46.28	-13	-33.28	-68.33	-48.01	9.57	11.30	H
	3819.6	-53.20	-13	-40.20	-63.93	-59.24	6.56	12.6	V
	5729.4	-51.02	-13	-38.02	-66.24	-56.12	8	13.1	V
	7639.2	-45.77	-13	-32.77	-67.63	-47.50	9.57	11.3	V

Remark: Spurious emissions within 30-1000MHz were found more than 20dB below limit line.

GSM1900 (EDGE Class8)									
Channel	Frequency (MHz)	EIRP (dBm)	Limit (dBm)	Over Limit (dB)	SPA Reading (dBm)	S.G. Power (dBm)	TX Cable loss (dB)	TX Antenna Gain (dBi)	Polarization (H/V)
Lowest	3700.4	-53.81	-13	-40.81	-64.61	-61.44	4.97	12.60	H
	5550.6	-50.18	-13	-37.18	-66.09	-57.06	6.22	13.10	H
	7400.8	-45.62	-13	-32.62	-67.82	-49.42	7.5	11.30	H
	3700.4	-53.51	-13	-40.51	-64.02	-61.14	4.97	12.6	V
	5550.6	-51.49	-13	-38.49	-66.2	-58.37	6.22	13.1	V
	7400.8	-45.87	-13	-32.87	-67.79	-49.67	7.5	11.3	V
Middle	3760	-52.43	-13	-39.43	-63.45	-59.96	5.07	12.60	H
	5640	-49.69	-13	-36.69	-66.05	-56.51	6.28	13.10	H
	7520	-46.33	-13	-33.33	-68.38	-50.32	7.31	11.30	H
	3760	-53.85	-13	-40.85	-64.58	-61.38	5.07	12.60	V
	5640	-51.22	-13	-38.22	-66.44	-58.04	6.28	13.10	V
	7520	-45.30	-13	-32.30	-67.16	-49.29	7.31	11.30	V
Highest	3819.6	-53.56	-13	-40.56	-64.56	-60.96	5.20	12.60	H
	5729.4	-50.19	-13	-37.19	-66.32	-56.83	6.46	13.10	H
	7639.2	-46.04	-13	-33.04	-68.47	-50.15	7.19	11.30	H
	3819.6	-53.31	-13	-40.31	-64.01	-60.71	5.20	12.60	V
	5729.4	-51.43	-13	-38.43	-66.39	-58.07	6.46	13.10	V
	7639.2	-45.85	-13	-32.85	-68.08	-49.96	7.19	11.30	V

Remark: Spurious emissions within 30-1000MHz were found more than 20dB below limit line.

WCDMA Band V(RMC 12.2Kbps)									
Channel	Frequency (MHz)	EIRP (dBm)	Limit (dBm)	Over Limit (dB)	SPA Reading (dBm)	S.G. Power (dBm)	TX Cable loss (dB)	TX Antenna Gain (dBi)	Polarization (H/V)
Lowest	1652.8	-58.59	-13	-45.59	-65.00	-63.06	2.78	9.40	H
	2479.2	-55.94	-13	-42.94	-64.99	-60.69	3.7	10.60	H
	3305.6	-55.61	-13	-42.61	-64.75	-61.80	3.35	11.69	H
	1652.8	-57.66	-13	-44.66	-63.95	-62.13	2.78	9.40	V
	2479.2	-55.99	-13	-42.99	-64.57	-60.74	3.70	10.60	V
	3305.6	-55.67	-13	-42.67	-64.56	-61.86	3.35	11.69	V
Middle	1672	-57.94	-13	-44.94	-64.39	-62.41	2.78	9.40	H
	2510	-55.93	-13	-42.93	-65.02	-60.68	3.7	10.60	H
	3346	-56.32	-13	-43.32	-65.65	-62.51	3.35	11.69	H
	1672	-58.32	-13	-45.32	-64.63	-62.79	2.78	9.40	V
	2510	-56.47	-13	-43.47	-65.09	-61.22	3.70	10.60	V
	3346	-56.28	-13	-43.28	-65.36	-62.47	3.35	11.69	V
Highest	1693.2	-57.22	-13	-44.22	-63.71	-61.69	2.78	9.40	H
	2539.8	-55.57	-13	-42.57	-64.65	-60.32	3.7	10.60	H
	3386.4	-55.54	-13	-42.54	-65.04	-61.73	3.35	11.69	H
	1693.2	-57.84	-13	-44.84	-64.17	-62.31	2.78	9.40	V
	2539.8	-56.46	-13	-43.46	-65.07	-61.21	3.70	10.60	V
	3386.4	-55.44	-13	-42.44	-64.69	-61.63	3.35	11.69	V

Remark: Spurious emissions within 30-1000MHz were found more than 20dB below limit line.

WCDMA Band II(RMC 12.2Kbps)									
Channel	Frequency (MHz)	EIRP (dBm)	Limit (dBm)	Over Limit (dB)	SPA Reading (dBm)	S.G. Power (dBm)	TX Cable loss (dB)	TX Antenna Gain (dBi)	Polarization (H/V)
Lowest	3704.8	-53.17	-13	-40.17	-63.99	-59.21	6.56	12.60	H
	5557.2	-49.81	-13	-36.81	-65.73	-54.91	8	13.10	H
	7409.6	-46.14	-13	-33.14	-68.37	-47.87	9.57	11.30	H
	3704.8	-53.81	-13	-40.81	-64.34	-59.85	6.56	12.6	V
	5557.2	-51.13	-13	-38.13	-65.85	-56.23	8	13.1	V
	7409.6	-46.27	-13	-33.27	-68.23	-48.00	9.57	11.3	V
Middle	3760	-53.45	-13	-40.45	-64.45	-59.49	6.56	12.60	H
	5640	-49.69	-13	-36.69	-65.82	-54.79	8	13.10	H
	7520	-46.17	-13	-33.17	-68.60	-47.90	9.57	11.30	H
	3760	-53.94	-13	-40.94	-64.64	-59.98	6.56	12.6	V
	5640	-51.38	-13	-38.38	-66.34	-56.48	8	13.1	V
	7520	-45.62	-13	-32.62	-67.85	-47.35	9.57	11.3	V
Highest	3815.2	-53.68	-13	-40.68	-64.70	-59.72	6.56	12.60	H
	5722.8	-49.48	-13	-36.48	-65.82	-54.58	8	13.10	H
	7630.4	-45.24	-13	-32.24	-67.32	-46.97	9.57	11.30	H
	3815.2	-53.21	-13	-40.21	-63.94	-59.25	6.56	12.6	V
	5722.8	-51.30	-13	-38.30	-66.5	-56.40	8	13.1	V
	7630.4	-46.26	-13	-33.26	-68.14	-47.99	9.57	11.3	V

Remark: Spurious emissions within 30-1000MHz were found more than 20dB below limit line.

-----End of the report-----