

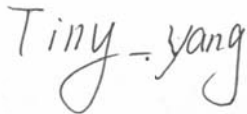

FCC RF Test Report

For

Mikrotiks SIA

Test Standards:	<u>FCC 47 CFR Part 2. 27(D)</u>
Product Description:	Mini-pcie card R11e-LTE6
Brand Name:	Mikrotik
Model Name:	R11e-LTE6
Additional Model:	N/A
FCC ID:	TV7R11ELTE6
Classification	PCS Licensed Transmitter (PCB)
Report No.:	<u>EC1812017F03</u>
Tested Date:	<u>2018-12-20 to 2019-03-04</u>
Issued Date:	<u>2019-03-04</u>
Prepared By:	<u></u> Tiny yang/ Engineer
Approved By:	<u></u> Bacon Wu / RF Manager

Hunan Ecloud Testing Technology Co., Ltd.
Building A1, Changsha E Center, No. 18 Xiangtai Avenue, Liuyang Economic and
Technological Development Zone, Hunan, P.R.C
Tel.: +86-731-89634887 Fax.: +86-731-89634887
www.hn-ecloud.com

Note: The test results in this report apply exclusively to the tested model / sample. Without written approval of

Hunan Ecloud Testing Technology Co., Ltd., the test report shall not be reproduced except in full.

Report Revise Record

Report Version	Revise Time	Issued Date	Valid Version	Notes
V1.0	/	2019.03.04	Valid	Original Report

TABLE OF CONTENTS

SUMMARY OF TEST RESULT	4
1 TEST LABORATORY.....	5
1.1 Test facility.....	5
2 GENERAL DESCRIPTION.....	6
2.1 Applicant.....	6
2.2 Manufacturer	6
2.3 Product Feature of Equipment Under Test	6
2.4 Product Specification of Equipment Under Test	8
2.5 Modification of EUT	8
2.6 Applicable Standards	8
3 TEST CONFIGURATION OF EQUIPMENT UNDER TEST.....	9
3.1 Test Mode.....	9
3.2 Frequency List of Low/Middle/High Channels.....	11
3.3 Connection Diagram of Test System	12
3.4 Support Unit used in test configuration	12
3.5 Measurement Results Explanation Example	13
4 CONDUCTED TEST RESULT.....	14
4.1 Measuring Instruments.....	14
4.2 Conducted Output Power and E.R.P./E.I.R.P.....	14
4.3 Peak-to-Average Ratio	16
4.4 EIRP Power Density.....	17
4.5 99% Occupied Bandwidth and 26dB Bandwidth Measurement.....	18
4.6 Conducted Band Edge and Emission Mask.....	20
4.7 Conducted Spurious Emission	22
4.8 Frequency Stability.....	24
5 RADIATED TEST ITEMS	26
5.1 Measuring Instruments.....	26
5.2 Radiated Spurious Emission	26
6 LIST OF MEASURING EQUIPMENT	28
7 UNCERTAINTY OF EVALUATION	29
APPENDIX A:TEST RESULTS	30
APPENDIX B:TEST RESULTS OF RADIATED TEST	88
APPENDIX C:TEST SETUP PHOTOGRAPHS.....	错误!未定义书签。
APPENDIX A. TEST RESULTS OF CONDUCTED TEST	
APPENDIX B. TEST RESULTS OF RADIATED TEST	
APPENDIX C. TEST SETUP PHOTOGRAPHS	

Summary Of Test Result

Report Section	FCC Rule	Description	Limit	Result	Remark
4.2	§2.1046	Conducted Output Power	Reporting Only	-	-
4.3	-	Peak-to-Average Ratio	< 13 dB	-	Reporting Only
4.4	§27.50 (a)(3)	EIRP Power Density	EIRP < 250mW/5MHz	PASS	-
4.5	§2.1049	Occupied Bandwidth	Reporting Only	-	-
4.6	§2.1051 §27.53(a)(4)	Conducted Band Edge Measurement	Refer standard	PASS	-
4.7	§2.1051 §27.53(a)(4)	Conducted Spurious Emission	< 70+10log ₁₀ (P[Watts])	PASS	-
4.8	§2.1055 §27.54	Frequency Stability for Temperature & Voltage	Within the band	PASS	-

Report Section	FCC Rule	Description	Limit	Result	Remark
5.2	§2.1053 §27.53(a)(4)	Radiated Spurious Emission	< 70+10log ₁₀ (P[Watts])	PASS	Under limit 2.79 dB at 9240 MHz

1 Test Laboratory

1.1 Test facility

CNAS (accreditation number: L11138)

Hunan Ecloud Testing Technology Co., Ltd. has obtained the accreditation of China National Accreditation Service for Conformity Assessment (CNAS).

FCC (Designation number: CN1244 , Test Firm Registration Number: 793308)

Hunan Ecloud Testing Technology Co., Ltd. has been listed on the US Federal Communications Commission list of test facilities recognized to perform electromagnetic emissions measurements.

ISED(CAB identifier: CN0012)

Hunan Ecloud Testing Technology Co., Ltd. has been listed on the Wireless Device Testing Laboratories list of innovation, Science and Economic Development Canada to test to Canadian radio equipment requirements.

A2LA (Certificate Code: 4895.01)

Hunan Ecloud Testing Technology Co., Ltd. has been listed by American Association for Laboratory Accreditation to perform electromagnetic emission measurement.

2 General Description

2.1 Applicant

Mikrotiks SIA
Brivibas gatve 214i, Riga, LV-1039 LATVIA

2.2 Manufacturer

Shanghai Notion information technology CO. LTD
Room 501, Building 5, NO 289, Bisheng Rd, Pudong district, Shanghai, China

2.3 Product Feature of Equipment Under Test

Product Feature	
Equipment	Mini-pcie card R11e-LTE6
Brand Name	Mikrotik
Model Name	R11e-LTE6
Additional Model	N/A
FCC ID	TV7R11ELTE6
Nominal Voltage	3.8 Vdc (From Test fixture)
Extreme Voltage	DC 3.2V and DC 4.3V
Extreme Temperature	-40°C and 80°C
Modulation Type	GSM GMSK, 8PSK
	WCDMA BPSK
	LTE 8PSK, 16QAM, 64QAM
Operating frequency	GSM 824.2 MHz ~ 848.8 MHz (FOR GSM 850) 1850.2 MHz ~ 1909.8MHz (FOR DCS 1900)
	WCDMA 826.4 MHz ~ 846.6 MHz (FOR WCDMA 850) MA 1852.4 MHz ~ 1907.6 MHz (FOR WCDMA 1900)
	LTE LTE Band 2: 1805.7 MHz ~ 1909.3MHz LTE Band 5: 824.7 MHz ~ 848.3 MHz LTE Band 7: 2502.5 MHz ~ 2567.5 MHz LTE Band 12: 699.7 MHz ~ 715.3 MHz LTE Band 17: 706.5 MHz ~ 713.5 MHz LTE Band 25: 1850.7MHz ~ 1914.3 MHz LTE Band 26: 824.7MHz ~ 848.3 MHz LTE Band 38: 2572.5 MHz ~ 2617.5 MHz LTE Band 39: 1882.5 MHz ~ 1907.5 MHz

		LTE Band 40: 2307.5 MHz ~ 2312.5 MHz & 2352.5MHz~2357.5MHz LTE Band 41: 2498.5 MHz ~ 2687.5 MHz
HW Version	M26H_1_10	
SW Version	R11e_LTE6	
EUT Stage	Production Unit	

Remark:

1. The above EUT's information was declared by manufacturer. Please refer to the specifications or user's manual for more detailed description.
2. The EUT was investigated in three orthogonal orientations X/Y/Z on antennas. For Main antenna, it was determined that worst-case orientation Y (Landscape) orientation.

2.4 Product Specification of Equipment Under Test

Standards-related Product Specification	
Tx Frequency	LTE Band 40 :2307.5 MHz ~ 2312.5 MHz & 2352.5MHz~2357.5MHz
Rx Frequency	LTE Band 40 : 2307.5 MHz ~ 2312.5 MHz & 2352.5MHz~2357.5MHz
Bandwidth	LTE Band 40 : 5MHz / 10MHz
Maximum EIRP Power	LTE Band 40: 19.55 dBm
Antenna Type	Omni Antenna
Antenna Gain (Main)	LTE Band 40: -0.38 dBi
Antenna Gain (AUX Only for RX)	LTE Band 40: -0.38 dBi
Type of Modulation	QPSK/ 16QAM

2.5 Modification of EUT

No modifications are made to the EUT during all test items.

2.6 Applicable Standards

According to the specifications of the manufacturer, the EUT must comply with the requirements of the following standards:

- ♦ 47 CFR Part 2, 27(C)(D)
 - ♦ ANSI / TIA / EIA-603-E-2016
 - ♦ ANSI C63.26-2015
- FCC KDB 971168 D01 Power Meas. License Digital Systems v03r01

Remark:

1. All test items were verified and recorded according to the standards and without any deviation during the test.
2. This EUT has also been tested and complied with the requirements of FCC Part 15, Subpart B, recorded in a separate test report.

3 Test Configuration of Equipment Under Test

3.1 Test Mode

Antenna port conducted and radiated test items were performed according to KDB 971168 D01 Power Meas. License Digital Systems v03r01 with maximum output power.

Radiated measurements were performed with rotating EUT in different three orthogonal test planes to find the maximum emission.

Radiated emissions were investigated from 30 MHz to 10th harmonic.

Test modes are chosen to be reported as the worst case configuration below:

Test Items	Band	Bandwidth(MHz)						Modulation			RB#			Test Channel		
		1.4	3	5	10	15	20	QPSK	16QAM	64QAM	1	Half	Full	L	M	H
Max. Output Power and E.R.P./ E.I.R.P.	40	-	-	•	•	-	-	•	•	•	•	•	•	•	•	•
Peak-to-Average Ratio	40	-	-	•	•	-	-	•	•	•	•	-	•	•	•	•
26dB and 99% Bandwidth	40	-	-	•	•	-	-	•	•	•	-	-	•	•	•	•
EIRP Power Density	40	-	-	•	•	-	-	•	•	•	•	•	•	•	•	•
Conducted Band Edge	40	-	-	•	•	-	-	•	•	•	•	-	•	•	•	•
Conducted Spurious Emission	40	-	-	•	•	-	-	•	•	•	-	-	•	•	•	•
Frequency Stability	40	-	-	•	•	-	-	•	•	•	-	-	•	•	•	•
Radiated Spurious Emission	40	-	-	•	•	-	-	•	•	•	•	•	•	•	•	•

Note	<ol style="list-style-type: none">1. The mark "●" means that this configuration is chosen for testing.2. The mark "-" means that this bandwidth is not supported.3. The device is investigated from 30MHz to 10 times of fundamental signal for radiated spurious emission test under different RB size/offset and modulations in exploratory test. Subsequently, only the worst case emissions are reported.
-------------	---

3.2 Frequency List of Low/Middle/High Channels

LTE Band 40 Channel-1	Bandwidth [MHz]	EARFCN	Frequency (UL and DL) [MHz]
Low Range	5	38725	2307.5
Mid Range	5/10	38750	2310
High Range	5	38775	2312.5

LTE Band 40 Channel-2	Bandwidth [MHz]	EARFCN	Frequency (UL and DL) [MHz]
Low Range	5	39175	2352.5
Mid Range	5/10	39200	2355
High Range	5	39225	2357.5

3.3 Connection Diagram of Test System

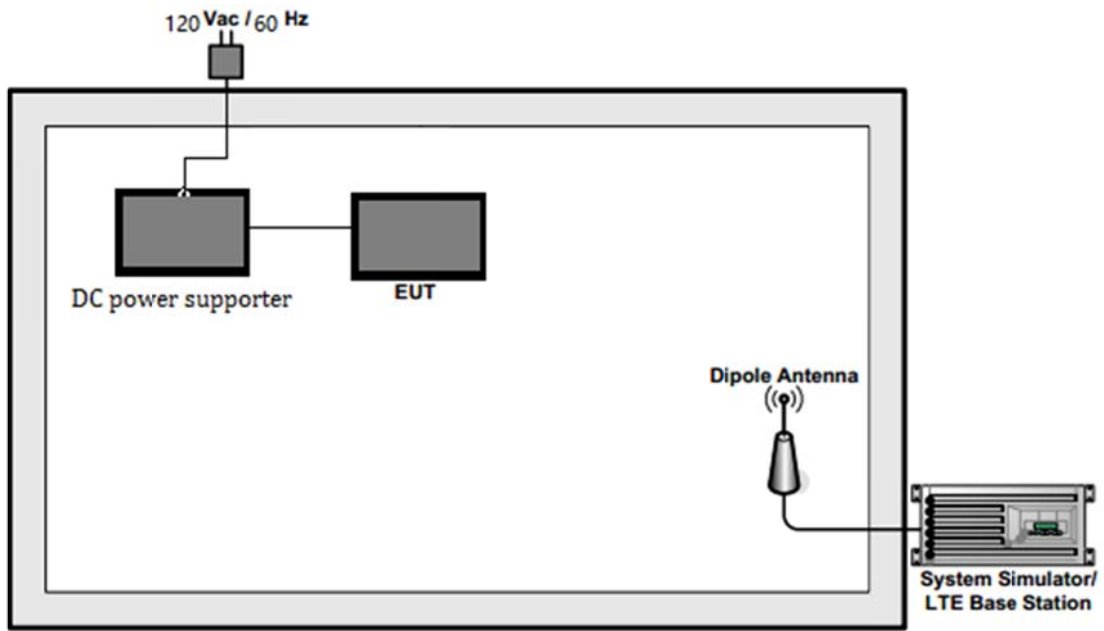

Radiated Setup

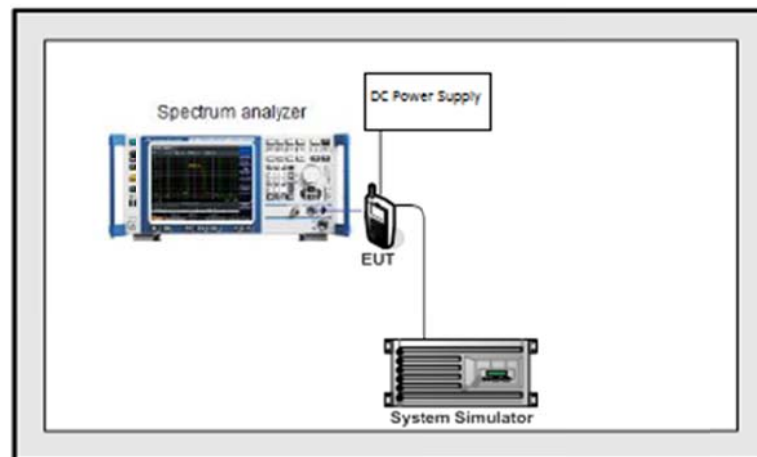

Conducted Setup

3.4 Support Unit used in test configuration

Item	Equipment	Trade Name	Model No.	FCC ID	Data Cable	Power Cord
1.	System Simulator	R&S	CMU 500	N/A	N/A	Unshielded, 1.8 m
2.	DC Power Supply	Keysight	E3642A	N/A	N/A	Unshielded, 1.8 m

3.5 Measurement Results Explanation Example

For all conducted test items:

The offset level is set in the spectrum analyzer to compensate the RF cable loss and attenuator factor between RF conducted output port and spectrum analyzer. With the offset compensation, the spectrum analyzer reading level will be exactly the RF output level.

The spectrum analyzer offset is derived from RF cable loss and attenuator factor.

Offset = RF cable loss + attenuator factor.

The following shows an offset computation example with RF cable loss 4.5 dB and a 10dB attenuator.

Example :

$$\begin{aligned} \text{Offset(dB)} &= \text{RF cable loss(dB)} + \text{attenuator factor(dB)}. \\ &= 4.5 + 10 = 14.5 \text{ (dB)} \end{aligned}$$

4 Conducted Test Result

4.1 Measuring Instruments

See list of measuring instruments of this test report.

4.2 Conducted Output Power and E.R.P./E.I.R.P.

4.2.1 Description of the Conducted Output Power

All LTE bands conducted average power is obtained from the CMW500 telecommunication test set.

The following tests were conducted according to the test requirements outlined in section 6.2 of the 3GPP TS36.101 specification.

UE Power Class: 3 (23 +/- 2dBm). The allowed Maximum Power Reduction (MPR) for the maximum output power due to higher order modulation and transmit bandwidth configuration (resource blocks) is specified in Table 6.2.3-1 of the 3GPP TS36.101.

Table 6.2.3-1: Maximum Power Reduction (MPR) for Power Class 1, 2 and 3

Modulation	Channel bandwidth / Transmission bandwidth (N_{RB})						MPR (dB)
	1.4 MHz	3.0 MHz	5 MHz	10 MHz	15 MHz	20 MHz	
QPSK	> 5	> 4	> 8	> 12	> 16	> 18	≤ 1
16 QAM	≤ 5	≤ 4	≤ 8	≤ 12	≤ 16	≤ 18	≤ 1
16 QAM	> 5	> 4	> 8	> 12	> 16	> 18	≤ 2
64 QAM	≤ 5	≤ 4	≤ 8	≤ 12	≤ 16	≤ 18	≤ 2
64 QAM	> 5	> 4	> 8	> 12	> 16	> 18	≤ 3
256 QAM	≥ 1						≤ 5

4.2.2 Test Procedures

1. The transmitter output port was connected to the system simulator.
2. Set EUT at maximum power through the system simulator.
3. Select lowest, middle, and highest channels for each band and different modulation.
4. Measure and record the power level from the system simulator.

4.2.3 Test Setup

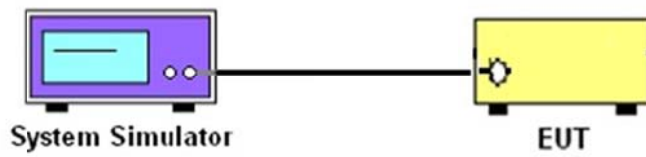

4.2.4 Test Results

Refer to Appendix A of this test report.

4.3 Peak-to-Average Ratio

4.3.1 Description of the PAR Measurement

Power Complementary Cumulative Distribution Function (CCDF) curves provide a means for characterizing the power peaks of a digitally modulated signal on a statistical basis. A CCDF curve depicts the probability of the peak signal amplitude exceeding the average power level. Most contemporary measurement instrumentation include the capability to produce CCDF curves for an input signal provided that the instrument's resolution bandwidth can be set wide enough to accommodate the entire input signal bandwidth.

4.3.2 Limit

In measuring transmissions in this band using an average power technique, the peak-to-average ratio (PAR) of the transmission may not exceed 13 dB.

4.3.3 Test Procedures

1. The testing follows FCC KDB 971168 D01 v03r01 Section 5.7.
2. The EUT was connected to spectrum analyzer and system simulator via a power divider.
3. Set the CCDF (Complementary Cumulative Distribution Function) option in spectrum analyzer.
4. The highest RF powers were measured and recorded the maximum PAPR level associated with a probability of 0.1 %.
5. Record the deviation as Peak to Average Ratio.

4.3.4 Test Setup

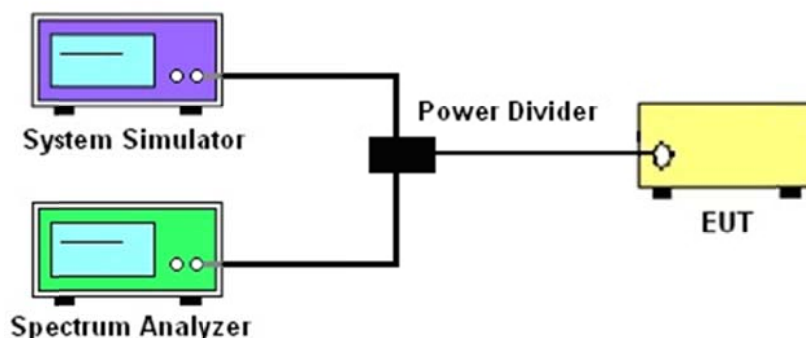

4.3.5 Test Results

Refer to Appendix A of this test report.

4.4 EIRP Power Density

4.4.1 Description of EIRP Power Density

For mobile and portable stations transmitting in the 2305-2315 MHz band or the 2350-2360 MHz band, the average EIRP must not exceed 50 milliwatts within any 1 megahertz of authorized bandwidth, except that for mobile and portable stations compliant with 3GPP LTE standards or another advanced mobile broadband protocol that avoids concentrating energy at the edge of the operating band the average EIRP must not exceed 250 milliwatts within any 5 megahertz of authorized bandwidth but may exceed 50 milliwatts within any 1 megahertz of authorized bandwidth. For mobile and portable stations using time division duplexing (TDD) technology, the duty cycle must not exceed 38 percent in the 2305-2315 MHz and 2350-2360 MHz bands. Mobile and portable stations using FDD technology are restricted to transmitting in the 2305-2315 MHz band. Power averaging shall not include intervals in which the transmitter is off.

4.4.2 Test Procedures

1. Set instrument center frequency to OBW center frequency.
2. Set span to at least 1.5 times the OBW.
3. Set the RBW to the specified reference bandwidth (often 1 MHz).
4. Set VBW $\geq 3 \times$ RBW.
5. Detector = RMS (power averaging).
6. Ensure that the number of measurement points in the sweep $\geq 2 \times$ span/RBW.
7. Sweep time = auto couple.
8. Employ trace averaging (RMS) mode over a minimum of 100 traces.
9. Use the peak marker function to determine the maximum amplitude level within the reference bandwidth (PSD).

4.4.3 Test Setup

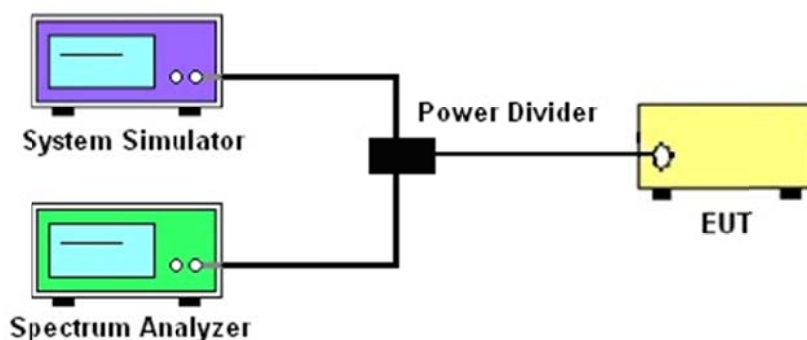

4.4.4 Test Results

Refer to Appendix A of this test report.

4.5 99% Occupied Bandwidth and 26dB Bandwidth Measurement

4.5.1 Description of 99% Occupied Bandwidth and 26dB Bandwidth Measurement

The occupied bandwidth is the width of a frequency band such that, below the lower and above the upper frequency limits, the mean powers emitted are each equal to a specified percentage 0.5% of the total mean transmitted power.

The 26 dB emission bandwidth is defined as the frequency range between two points, one above and one below the carrier frequency, at which the spectral density of the emission is attenuated 26 dB below the maximum in-band spectral density of the modulated signal. Spectral density (power per unit bandwidth) is to be measured with a detector of resolution bandwidth equal to approximately 1.0% of the emission bandwidth.

4.5.2 Limit

For reporting purposes only

4.5.3 Test Procedures

1. The testing follows FCC KDB 971168 v03r01 Section 4 and Subclause 5.4.3 and 5.4.4 of ANSI C63.26-2015
2. The EUT was connected to spectrum analyzer and system simulator via a power divider.
3. The spectrum analyzer center frequency is set to the nominal EUT channel center frequency. The span range for the spectrum analyzer shall be between two and five times the anticipated OBW.
4. The nominal resolution bandwidth (RBW) shall be in the range of 1 to 5 % of the anticipated OBW, and the VBW shall be at least 3 times the RBW.
5. Set the detection mode to peak, and the trace mode to max hold.
6. Determine the reference value: Set the EUT to transmit a modulated signal. Allow the trace to stabilize. Set the spectrum analyzer marker to the highest level of the displayed trace.
(this is the reference value)
7. Determine the “-26 dB down amplitude” as equal to (Reference Value – X).
8. Place two markers, one at the lowest and the other at the highest frequency of the envelope of the spectral display such that each marker is at or slightly below the “-X dB down amplitude” determined in step 6. If a marker is below this “-X dB down amplitude” value it shall be placed as close as possible to this value. The OBW is the positive frequency difference between the two markers.
9. Use the 99 % power bandwidth function of the spectrum analyzer and report the measured bandwidth.

4.5.4 Test Setup

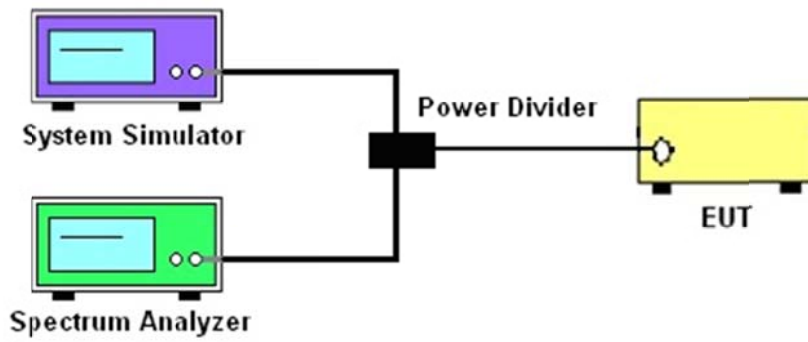

4.5.5 Test Results

Refer to Appendix A of this test report.

4.6 Conducted Band Edge and Emission Mask

4.6.1 Description of Conducted Band Edge and Emission Measurement

Measurement the power of any emission outside of the authorized operating frequency ranges must be attenuated below the transmitting power (P) by a factor.

4.6.2 Limit

FCC: §27.53(a)(4)

For mobile and portable stations operating in the 2305-2315 MHz and 2350-2360 MHz bands:

(i) By a factor of not less than: $43 + 10 \log (P)$ dB on all frequencies between 2305 and 2320 MHz and on all frequencies between 2345 and 2360 MHz that are outside the licensed band(s) of operation, not less than $55 + 10 \log (P)$ dB on all frequencies between 2320 and 2324 MHz and on all frequencies between 2341 and 2345 MHz, not less than $61 + 10 \log (P)$ dB on all frequencies between 2324 and 2328 MHz and on all frequencies between 2337 and 2341 MHz, and not less than $67 + 10 \log (P)$ dB on all frequencies between 2328 and 2337 MHz;

(ii) By a factor of not less than $43 + 10 \log (P)$ dB on all frequencies between 2300 and 2305 MHz, $55 + 10 \log (P)$ dB on all frequencies between 2296 and 2300 MHz, $61 + 10 \log (P)$ dB on all frequencies between 2292 and 2296 MHz, $67 + 10 \log (P)$ dB on all frequencies between 2288 and 2292 MHz, and $70 + 10 \log (P)$ dB below 2288 MHz;

(iii) By a factor of not less than $43 + 10 \log (P)$ dB on all frequencies between 2360 and 2365 MHz, and not less than $70 + 10 \log (P)$ dB above 2365 MHz.

4.6.3 Test Procedures

1. The testing follows FCC KDB 971168 D01 v03r01 Section 6.0.
2. The EUT was connected to the spectrum analyzer and system simulator via a power divider.
3. The band edges of low and high channels for the highest RF powers were measured.
4. Set RBW \geq 1% EBW in the 1MHz band immediately outside and adjacent to the band edge.
5. Beyond the 1 MHz band from the band edge, RBW=1MHz was used.
6. Set spectrum analyzer with RMS detector.
7. Offset has included the duty factor for LTE Band 40. Duty factor = $10 \log (1/x)$, where x is the measured duty cycle.
8. The RF fundamental frequency should be excluded against the limit line in the operating frequency band.
9. Checked that all the results comply with the emission limit line.

Example:

The limit line is derived from $43 + 10\log(P)$ dB below the transmitter power P(Watts)

$$= P(W) - [43 + 10\log(P)] \text{ (dB)}$$

$$= [30 + 10\log(P)] \text{ (dBm)} - [43 + 10\log(P)] \text{ (dB)}$$

$$= -13\text{dBm.}$$

For LTE Band 7, 38, 41, the other 40 dB, and 55 dB have additionally applied same calculation above.

4.6.4 Test Setup

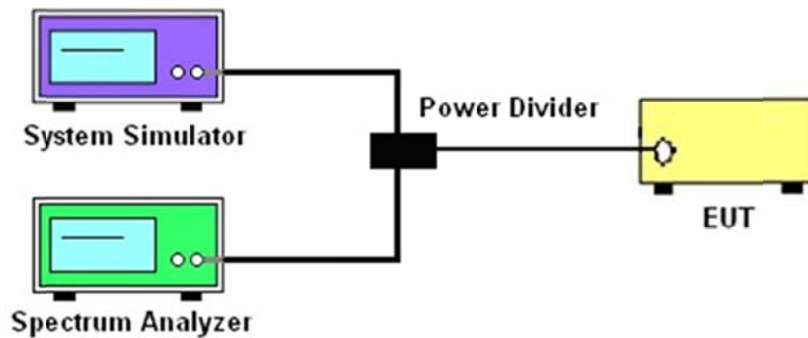

4.6.5 Test Results

Refer to Appendix A of this test report.

4.7 Conducted Spurious Emission

4.7.1 Description of Conducted Spurious Emission Measurement

The power of any emission outside of the authorized operating frequency ranges must be lower than the transmitter power (P) by a factor of at least $70 + 10 \log (P)$ dB.

It is measured by means of a calibrated spectrum analyzer and scanned from 30 MHz up to a frequency including its 10th harmonic.

4.7.2 Limit

The power of any emission outside of the authorized operating frequency ranges must be attenuated below the transmitting power (P) by a factor of at least $43 + 10 \log (P)$ dB.

§27.53(a)(4) For mobile and portable stations operating in the 2305-2315 MHz: by a factor of not less than $43 + 10 \log (P)$ dB on all frequencies between 2360 and 2365 MHz, and not less than $70 + 10 \log (P)$ dB above 2365 MHz.

4.7.3 Test Procedures

1. The testing follows FCC KDB 971168 D01 v03r01 Section 6.0.
2. The EUT was connected to the spectrum analyzer and system simulator via a power divider.
3. The RF output of EUT was connected to the spectrum analyzer by an RF cable and attenuator. The path loss was compensated to the results for each measurement.
4. The middle channel for the highest RF power within the transmitting frequency was measured.
5. The conducted spurious emission for the whole frequency range was taken.
6. Make the measurement with the spectrum analyzer's RBW = 1MHz, VBW = 3MHz.
7. Set spectrum analyzer with RMS detector.
8. Taking the record of maximum spurious emission.
9. Offset has included the duty factor for LTE Band 40. Duty factor = $10 \log (1/x)$, where x is the measured duty cycle.
10. The RF fundamental frequency should be excluded against the limit line in the operating frequency band.
11. The limit line is derived from $70 + 10 \log (P)$ dB below the transmitter power P(Watts)
= $P(W) - [70 + 10 \log (P)]$ (dB)
= $[30 + 10 \log (P)]$ (dBm) - $[70 + 10 \log (P)]$ (dB)
= -40dBm.

4.7.4 Test Setup

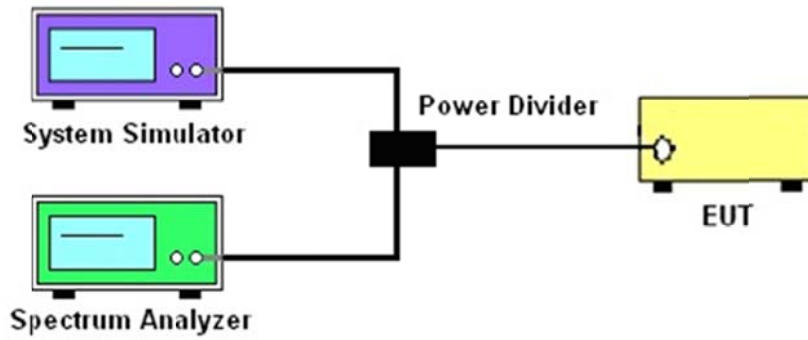

4.7.5 Test Results

Refer to Appendix A of this test report.

4.8 Frequency Stability

4.8.1 Description of Frequency Stability Measurement

The frequency stability shall be measured by variation of ambient temperature and variation of primary supply voltage to ensure that the fundamental emission stays within the authorized frequency block.

FCC §22.355

The carrier frequency shall not depart from the reference frequency in excess of ± 2.5 ppm for mobile stations.

FCC §24.235 & §27.54

The frequency stability shall be sufficient to ensure that the fundamental emission stays within the authorized frequency block.

4.8.2 Test Condition

Temp. = -30° to $+50^{\circ}$ C

Voltage = (85% - 115%)

4.8.3 Test Procedures for Temperature Variation

1. The testing follows FCC KDB 971168 D01 v03r01 Section 9.0.
2. The EUT was set up in the thermal chamber and connected with the system simulator.
3. With power OFF, the temperature was decreased to -30° C and the EUT was stabilized before testing. Power was applied and the maximum change in frequency was recorded within one minute.
4. With power OFF, the temperature was raised in 10° C steps up to 50° C. The EUT was stabilized at each step for at least half an hour. Power was applied and the maximum frequency change was recorded within one minute.

4.8.4 Test Procedures for Voltage Variation

1. The testing follows FCC KDB 971168 D01 v03r01 Section 9.0.
2. The EUT was placed in a temperature chamber at $25 \pm 5^{\circ}$ C and connected with the system simulator.
3. The power supply voltage to the EUT was varied from 85% to 115% of the nominal value measured at the input to the EUT.
4. The variation in frequency was measured for the worst case.

4.8.5 Test Setup

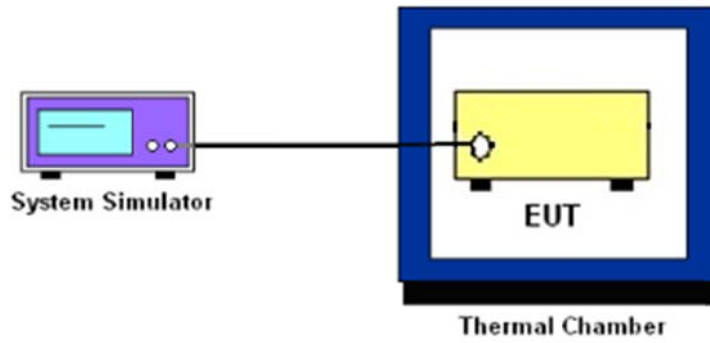

4.8.6 Test Results

Refer to Appendix A of this test report.

5 Radiated Test Items

5.1 Measuring Instruments

See list of measuring instruments of this test report.

5.2 Radiated Spurious Emission

5.2.1 Description of the Radiated Spurious Emission

The radiated spurious emission was measured by substitution method according to ANSI / TIA / EIA-603-E-2016. The power of any emission outside of the authorized operating frequency ranges must be attenuated below the transmitter power (P) by a factor of at least $70 + 10 \log (P)$ dB.

The spectrum is scanned from 30 MHz up to a frequency including its 10th harmonic.

5.2.2 Test Procedures

1. The testing follows FCC KDB 971168 D01 v03r01 Section 5.8. and ANSI / TIA-603-E-2016 Section 2.2.12.
2. The EUT was placed on a turntable with 0.8 meter height for frequency below 1GHz and 1.5 meter height for frequency above 1GHz respectively above ground.
3. The EUT was set 3 meters from the receiving antenna mounted on the antenna tower.
4. The table was rotated 360 degrees to determine the position of the highest spurious emission.
5. The height of the receiving antenna is varied between 1m to 4m to search the maximum spurious emission for both horizontal and vertical polarizations.
6. During the measurement, the system simulator parameters were set to force the EUT transmitting at maximum output power.
7. Offset has included the duty factor for LTE Band 40. Duty factor = $10 \log (1/x)$, where x is the measured duty cycle
8. Make the measurement with the spectrum analyzer's RBW = 1MHz, VBW = 3MHz, taking the record of maximum spurious emission.
9. A horn antenna was substituted in place of the EUT and was driven by a signal generator.
10. Tune the output power of signal generator to the same emission level with EUT maximum spurious emission.
11. $EIRP (dBm) = S.G. Power - Tx Cable Loss + Tx Antenna Gain.$
12. $ERP (dBm) = EIRP - 2.15$
13. The RF fundamental frequency should be excluded against the limit line in the operating frequency band.

The limit line is derived from $70 + 10\log(P)$ dB below the transmitter power P(Watts)

$$= P(W) - [70 + 10\log(P)] (dB)$$

$$= [30 + 10\log(P)] (dBm) - [70 + 10\log(P)] (dB)$$

$$= -40dBm.$$

5.2.3 Test Setup

For radiated test from 30MHz to 1GHz

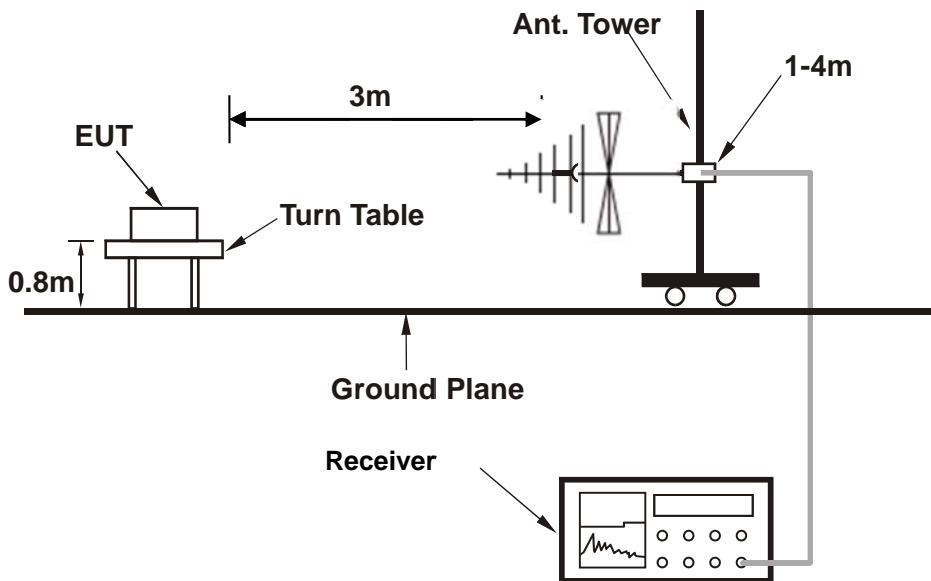

For radiated test above 1GHz

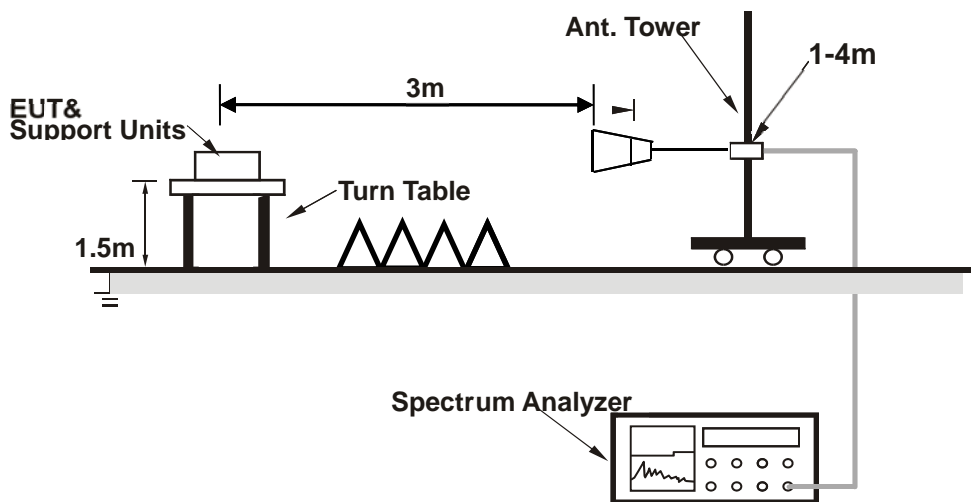

5.2.4 Test Results

Refer to Appendix B of this test report.

6 List of Measuring Equipment

Instrument	Manufacturer	Model No.	Serial No.	Calibration Date	Due Date	Remark
Spectrum Analyzer	Keysight	N9010A	MY56070788	2018/3/2	2019/3/1	Conducted
Base Station	R&S	CMW500	164998	2018/3/17	2019/3/16	Conducted
Thermal Chamber	Sanmtest	SMC-408-CD	2435	2018/7/05	2019/7/04	Conducted
Signal Generator (Interferer)	Keysight	N5182B	MY56200384	2018/4/10	2019/4/09	Conducted
Signal Generator (Blocker)	Keysight	N5171B	MY56200661	2018/3/2	2019/3/1	Conducted

Instrument	Manufacturer	Model No.	Serial No.	Calibration Date	Due Date	Remark
Spectrum Analyzer	R&S	FSV 40	101433	2018/3/14	2019/3/13	Radiation
Amplifier	Sonoma	310	363917	2018/3/6	2019/3/5	Radiation
Amplifier	Schwarzbeck	BBV 9718	327	2018/3/14	2019/3/13	Radiation
Amplifier	Narda	TTA1840-35-HG	2034380	2018-07-18	2019-07-17	Radiation
Loop Antenna	Schwarzbeck	FMZB 1519 B	1519B-051	2017/3/3	2020/3/2	Radiation
Broadband Antenna	Schwarzbeck	VULB 9168	9168-757	2017/3/3	2020/3/2	Radiation
Horn Antenna	Schwarzbeck	BBHA 9120 D	1677	2017/3/3	2020/3/2	Radiation
Horn Antenna	COM-POWER	AH-1840	101117	2018-06-20	2021-06-19	Radiation
Signal Generator (Blocker)	R&S	SMB100A	180717	2018/3/15	2019/3/14	Radiation
Test Software	Auidx	E3	6.111221a	N/A	N/A	Radiation

N/A: No Calibration Required

7 Uncertainty of Evaluation

Uncertainty of Radiated Emission Measurement (30 MHz ~ 1000 MHz)

Measuring Uncertainty for a Level of Confidence of 95% ($U = 2Uc(y)$)	2.5 dB
---	--------

Uncertainty of Radiated Emission Measurement (1GHz ~ 18GHz)

Measuring Uncertainty for a Level of Confidence of 95% ($U = 2Uc(y)$)	3.51dB
---	--------

Uncertainty of Radiated Emission Measurement (18GHz ~ 40GHz)

Measuring Uncertainty for a Level of Confidence of 95% ($U = 2Uc(y)$)	3.96dB
---	--------

Appendix A: Test Results

Conducted Output Power(Average power)

Band	Bandwidth	Modulation	Channel	RB Configuration	Result(dBm)
Band40	5MHz	QPSK	38725	1RB#0	19.11
Band40	5MHz	QPSK	38725	1RB#12	19.2
Band40	5MHz	QPSK	38725	1RB#24	19.53
Band40	5MHz	QPSK	38725	12RB#0	18.12
Band40	5MHz	QPSK	38725	12RB#6	18.1
Band40	5MHz	QPSK	38725	12RB#13	18.27
Band40	5MHz	QPSK	38725	25RB#0	18.2
Band40	5MHz	QPSK	38750	1RB#0	19.26
Band40	5MHz	QPSK	38750	1RB#12	19.48
Band40	5MHz	QPSK	38750	1RB#24	19.47
Band40	5MHz	QPSK	38750	12RB#0	18.29
Band40	5MHz	QPSK	38750	12RB#6	18.29
Band40	5MHz	QPSK	38750	12RB#13	18.51
Band40	5MHz	QPSK	38750	25RB#0	18.51
Band40	5MHz	QPSK	38775	1RB#0	19.5
Band40	5MHz	QPSK	38775	1RB#12	19.39
Band40	5MHz	QPSK	38775	1RB#24	19.45
Band40	5MHz	QPSK	38775	12RB#0	18.4
Band40	5MHz	QPSK	38775	12RB#6	18.4
Band40	5MHz	QPSK	38775	12RB#13	18.42
Band40	5MHz	QPSK	38775	25RB#0	18.42
Band40	5MHz	QPSK	39175	1RB#0	19.93
Band40	5MHz	QPSK	39175	1RB#12	19.79
Band40	5MHz	QPSK	39175	1RB#24	19.72
Band40	5MHz	QPSK	39175	12RB#0	18.96
Band40	5MHz	QPSK	39175	12RB#6	18.96
Band40	5MHz	QPSK	39175	12RB#13	18.91
Band40	5MHz	QPSK	39175	25RB#0	18.9
Band40	5MHz	QPSK	39200	1RB#0	19.82
Band40	5MHz	QPSK	39200	1RB#12	19.64
Band40	5MHz	QPSK	39200	1RB#24	19.7

Band40	5MHz	QPSK	39200	12RB#0	18.74
Band40	5MHz	QPSK	39200	12RB#6	18.74
Band40	5MHz	QPSK	39200	12RB#13	18.73
Band40	5MHz	QPSK	39200	25RB#0	18.75
Band40	5MHz	QPSK	39225	1RB#0	19.66
Band40	5MHz	QPSK	39225	1RB#12	19.6
Band40	5MHz	QPSK	39225	1RB#24	19.66
Band40	5MHz	QPSK	39225	12RB#0	18.7
Band40	5MHz	QPSK	39225	12RB#6	18.71
Band40	5MHz	QPSK	39225	12RB#13	18.75
Band40	5MHz	QPSK	39225	25RB#0	18.71
Band40	5MHz	16QAM	38725	1RB#0	18.1
Band40	5MHz	16QAM	38725	1RB#12	18.2
Band40	5MHz	16QAM	38725	1RB#24	18.49
Band40	5MHz	16QAM	38725	12RB#0	17.05
Band40	5MHz	16QAM	38725	12RB#6	17.04
Band40	5MHz	16QAM	38725	12RB#13	17.23
Band40	5MHz	16QAM	38725	25RB#0	17.16
Band40	5MHz	16QAM	38750	1RB#0	18.47
Band40	5MHz	16QAM	38750	1RB#12	18.65
Band40	5MHz	16QAM	38750	1RB#24	18.65
Band40	5MHz	16QAM	38750	12RB#0	17.29
Band40	5MHz	16QAM	38750	12RB#6	17.29
Band40	5MHz	16QAM	38750	12RB#13	17.52
Band40	5MHz	16QAM	38750	25RB#0	17.44
Band40	5MHz	16QAM	38775	1RB#0	18.5
Band40	5MHz	16QAM	38775	1RB#12	18.4
Band40	5MHz	16QAM	38775	1RB#24	18.47
Band40	5MHz	16QAM	38775	12RB#0	17.39
Band40	5MHz	16QAM	38775	12RB#6	17.39
Band40	5MHz	16QAM	38775	12RB#13	17.42
Band40	5MHz	16QAM	38775	25RB#0	17.43
Band40	5MHz	16QAM	39175	1RB#0	18.98
Band40	5MHz	16QAM	39175	1RB#12	18.83
Band40	5MHz	16QAM	39175	1RB#24	18.74
Band40	5MHz	16QAM	39175	12RB#0	18.01

Band40	5MHz	16QAM	39175	12RB#6	18.01
Band40	5MHz	16QAM	39175	12RB#13	17.96
Band40	5MHz	16QAM	39175	25RB#0	17.97
Band40	5MHz	16QAM	39200	1RB#0	19.04
Band40	5MHz	16QAM	39200	1RB#12	18.86
Band40	5MHz	16QAM	39200	1RB#24	18.93
Band40	5MHz	16QAM	39200	12RB#0	17.86
Band40	5MHz	16QAM	39200	12RB#6	17.85
Band40	5MHz	16QAM	39200	12RB#13	17.84
Band40	5MHz	16QAM	39200	25RB#0	17.8
Band40	5MHz	16QAM	39225	1RB#0	18.7
Band40	5MHz	16QAM	39225	1RB#12	18.63
Band40	5MHz	16QAM	39225	1RB#24	18.69
Band40	5MHz	16QAM	39225	12RB#0	17.8
Band40	5MHz	16QAM	39225	12RB#6	17.8
Band40	5MHz	16QAM	39225	12RB#13	17.85
Band40	5MHz	16QAM	39225	25RB#0	17.81
Band40	10MHz	QPSK	38750	1RB#0	19.3
Band40	10MHz	QPSK	38750	1RB#24	19.58
Band40	10MHz	QPSK	38750	1RB#49	19.57
Band40	10MHz	QPSK	38750	25RB#0	18.33
Band40	10MHz	QPSK	38750	25RB#12	18.32
Band40	10MHz	QPSK	38750	25RB#25	18.53
Band40	10MHz	QPSK	38750	50RB#0	18.66
Band40	10MHz	QPSK	39200	1RB#0	19.79
Band40	10MHz	QPSK	39200	1RB#24	19.42
Band40	10MHz	QPSK	39200	1RB#49	19.71
Band40	10MHz	QPSK	39200	25RB#0	18.57
Band40	10MHz	QPSK	39200	25RB#12	18.55
Band40	10MHz	QPSK	39200	25RB#25	18.62
Band40	10MHz	QPSK	39200	50RB#0	18.57
Band40	10MHz	16QAM	38750	1RB#0	18.5
Band40	10MHz	16QAM	38750	1RB#24	18.73
Band40	10MHz	16QAM	38750	1RB#49	18.74
Band40	10MHz	16QAM	38750	25RB#0	17.24
Band40	10MHz	16QAM	38750	25RB#12	17.23



Band40	10MHz	16QAM	38750	25RB#25	17.47
Band40	10MHz	16QAM	38750	50RB#0	17.61
Band40	10MHz	16QAM	39200	1RB#0	19.03
Band40	10MHz	16QAM	39200	1RB#24	18.66
Band40	10MHz	16QAM	39200	1RB#49	18.91
Band40	10MHz	16QAM	39200	25RB#0	17.54
Band40	10MHz	16QAM	39200	25RB#12	17.52
Band40	10MHz	16QAM	39200	25RB#25	17.58
Band40	10MHz	16QAM	39200	50RB#0	17.55

Effective (Isotropic) Radiated Power Output Data

Band	Bandwidth	Modulation	Channel	RB Configuration	Result(dBm)	Verdict
Band40	5MHz	QPSK	38725	1RB#0	18.73	PASS
Band40	5MHz	QPSK	38725	1RB#12	18.82	PASS
Band40	5MHz	QPSK	38725	1RB#24	19.15	PASS
Band40	5MHz	QPSK	38725	12RB#0	17.74	PASS
Band40	5MHz	QPSK	38725	12RB#6	17.72	PASS
Band40	5MHz	QPSK	38725	12RB#13	17.89	PASS
Band40	5MHz	QPSK	38725	25RB#0	17.82	PASS
Band40	5MHz	QPSK	38750	1RB#0	18.88	PASS
Band40	5MHz	QPSK	38750	1RB#12	19.1	PASS
Band40	5MHz	QPSK	38750	1RB#24	19.09	PASS
Band40	5MHz	QPSK	38750	12RB#0	17.91	PASS
Band40	5MHz	QPSK	38750	12RB#6	17.91	PASS
Band40	5MHz	QPSK	38750	12RB#13	18.13	PASS
Band40	5MHz	QPSK	38750	25RB#0	18.13	PASS
Band40	5MHz	QPSK	38775	1RB#0	19.12	PASS
Band40	5MHz	QPSK	38775	1RB#12	19.01	PASS
Band40	5MHz	QPSK	38775	1RB#24	19.07	PASS
Band40	5MHz	QPSK	38775	12RB#0	18.02	PASS
Band40	5MHz	QPSK	38775	12RB#6	18.02	PASS
Band40	5MHz	QPSK	38775	12RB#13	18.04	PASS
Band40	5MHz	QPSK	38775	25RB#0	18.04	PASS
Band40	5MHz	QPSK	39175	1RB#0	19.55	PASS
Band40	5MHz	QPSK	39175	1RB#12	19.41	PASS
Band40	5MHz	QPSK	39175	1RB#24	19.34	PASS
Band40	5MHz	QPSK	39175	12RB#0	18.58	PASS
Band40	5MHz	QPSK	39175	12RB#6	18.58	PASS
Band40	5MHz	QPSK	39175	12RB#13	18.53	PASS
Band40	5MHz	QPSK	39175	25RB#0	18.52	PASS
Band40	5MHz	QPSK	39200	1RB#0	19.44	PASS
Band40	5MHz	QPSK	39200	1RB#12	19.26	PASS
Band40	5MHz	QPSK	39200	1RB#24	19.32	PASS
Band40	5MHz	QPSK	39200	12RB#0	18.36	PASS
Band40	5MHz	QPSK	39200	12RB#6	18.36	PASS

Band40	5MHz	QPSK	39200	12RB#13	18.35	PASS
Band40	5MHz	QPSK	39200	25RB#0	18.37	PASS
Band40	5MHz	QPSK	39225	1RB#0	19.28	PASS
Band40	5MHz	QPSK	39225	1RB#12	19.22	PASS
Band40	5MHz	QPSK	39225	1RB#24	19.28	PASS
Band40	5MHz	QPSK	39225	12RB#0	18.32	PASS
Band40	5MHz	QPSK	39225	12RB#6	18.33	PASS
Band40	5MHz	QPSK	39225	12RB#13	18.37	PASS
Band40	5MHz	QPSK	39225	25RB#0	18.33	PASS
Band40	5MHz	16QAM	38725	1RB#0	17.72	PASS
Band40	5MHz	16QAM	38725	1RB#12	17.82	PASS
Band40	5MHz	16QAM	38725	1RB#24	18.11	PASS
Band40	5MHz	16QAM	38725	12RB#0	16.67	PASS
Band40	5MHz	16QAM	38725	12RB#6	16.66	PASS
Band40	5MHz	16QAM	38725	12RB#13	16.85	PASS
Band40	5MHz	16QAM	38725	25RB#0	16.78	PASS
Band40	5MHz	16QAM	38750	1RB#0	18.09	PASS
Band40	5MHz	16QAM	38750	1RB#12	18.27	PASS
Band40	5MHz	16QAM	38750	1RB#24	18.27	PASS
Band40	5MHz	16QAM	38750	12RB#0	16.91	PASS
Band40	5MHz	16QAM	38750	12RB#6	16.91	PASS
Band40	5MHz	16QAM	38750	12RB#13	17.14	PASS
Band40	5MHz	16QAM	38750	25RB#0	17.06	PASS
Band40	5MHz	16QAM	38775	1RB#0	18.12	PASS
Band40	5MHz	16QAM	38775	1RB#12	18.02	PASS
Band40	5MHz	16QAM	38775	1RB#24	18.09	PASS
Band40	5MHz	16QAM	38775	12RB#0	17.01	PASS
Band40	5MHz	16QAM	38775	12RB#6	17.01	PASS
Band40	5MHz	16QAM	38775	12RB#13	17.04	PASS
Band40	5MHz	16QAM	38775	25RB#0	17.05	PASS
Band40	5MHz	16QAM	39175	1RB#0	18.6	PASS
Band40	5MHz	16QAM	39175	1RB#12	18.45	PASS
Band40	5MHz	16QAM	39175	1RB#24	18.36	PASS
Band40	5MHz	16QAM	39175	12RB#0	17.63	PASS
Band40	5MHz	16QAM	39175	12RB#6	17.63	PASS
Band40	5MHz	16QAM	39175	12RB#13	17.58	PASS

Band40	5MHz	16QAM	39175	25RB#0	17.59	PASS
Band40	5MHz	16QAM	39200	1RB#0	18.66	PASS
Band40	5MHz	16QAM	39200	1RB#12	18.48	PASS
Band40	5MHz	16QAM	39200	1RB#24	18.55	PASS
Band40	5MHz	16QAM	39200	12RB#0	17.48	PASS
Band40	5MHz	16QAM	39200	12RB#6	17.47	PASS
Band40	5MHz	16QAM	39200	12RB#13	17.46	PASS
Band40	5MHz	16QAM	39200	25RB#0	17.42	PASS
Band40	5MHz	16QAM	39225	1RB#0	18.32	PASS
Band40	5MHz	16QAM	39225	1RB#12	18.25	PASS
Band40	5MHz	16QAM	39225	1RB#24	18.31	PASS
Band40	5MHz	16QAM	39225	12RB#0	17.42	PASS
Band40	5MHz	16QAM	39225	12RB#6	17.42	PASS
Band40	5MHz	16QAM	39225	12RB#13	17.47	PASS
Band40	5MHz	16QAM	39225	25RB#0	17.43	PASS
Band40	10MHz	QPSK	38750	1RB#0	18.92	PASS
Band40	10MHz	QPSK	38750	1RB#24	19.2	PASS
Band40	10MHz	QPSK	38750	1RB#49	19.19	PASS
Band40	10MHz	QPSK	38750	25RB#0	17.95	PASS
Band40	10MHz	QPSK	38750	25RB#12	17.94	PASS
Band40	10MHz	QPSK	38750	25RB#25	18.15	PASS
Band40	10MHz	QPSK	38750	50RB#0	18.28	PASS
Band40	10MHz	QPSK	39200	1RB#0	19.41	PASS
Band40	10MHz	QPSK	39200	1RB#24	19.04	PASS
Band40	10MHz	QPSK	39200	1RB#49	19.33	PASS
Band40	10MHz	QPSK	39200	25RB#0	18.19	PASS
Band40	10MHz	QPSK	39200	25RB#12	18.17	PASS
Band40	10MHz	QPSK	39200	25RB#25	18.24	PASS
Band40	10MHz	QPSK	39200	50RB#0	18.19	PASS
Band40	10MHz	16QAM	38750	1RB#0	18.12	PASS
Band40	10MHz	16QAM	38750	1RB#24	18.35	PASS
Band40	10MHz	16QAM	38750	1RB#49	18.36	PASS
Band40	10MHz	16QAM	38750	25RB#0	16.86	PASS
Band40	10MHz	16QAM	38750	25RB#12	16.85	PASS
Band40	10MHz	16QAM	38750	25RB#25	17.09	PASS
Band40	10MHz	16QAM	38750	50RB#0	17.23	PASS



Band40	10MHz	16QAM	39200	1RB#0	18.65	PASS
Band40	10MHz	16QAM	39200	1RB#24	18.28	PASS
Band40	10MHz	16QAM	39200	1RB#49	18.53	PASS
Band40	10MHz	16QAM	39200	25RB#0	17.16	PASS
Band40	10MHz	16QAM	39200	25RB#12	17.14	PASS
Band40	10MHz	16QAM	39200	25RB#25	17.2	PASS
Band40	10MHz	16QAM	39200	50RB#0	17.17	PASS

Peak-to-Average Ratio(CCDF)

Test Result

Band	Bandwidth	Modulation	Channel	RB Configuration	Result(dB)	Limit(dB)	Verdict
Band40	5MHz	QPSK	38725	1RB#0	7.83	13	PASS
Band40	5MHz	QPSK	38725	25RB#0	9.19	13	PASS
Band40	5MHz	QPSK	38750	1RB#0	8.72	13	PASS
Band40	5MHz	QPSK	38750	25RB#0	9.19	13	PASS
Band40	5MHz	QPSK	38775	1RB#0	8.41	13	PASS
Band40	5MHz	QPSK	38775	25RB#0	9.22	13	PASS
Band40	5MHz	QPSK	39175	1RB#0	8.52	13	PASS
Band40	5MHz	QPSK	39175	25RB#0	9.10	13	PASS
Band40	5MHz	QPSK	39200	1RB#0	8.67	13	PASS
Band40	5MHz	QPSK	39200	25RB#0	9.16	13	PASS
Band40	5MHz	QPSK	39225	1RB#0	8.46	13	PASS
Band40	5MHz	QPSK	39225	25RB#0	9.13	13	PASS
Band40	5MHz	16QAM	38725	1RB#0	9.13	13	PASS
Band40	5MHz	16QAM	38725	25RB#0	9.83	13	PASS
Band40	5MHz	16QAM	38750	1RB#0	9.30	13	PASS
Band40	5MHz	16QAM	38750	25RB#0	9.83	13	PASS
Band40	5MHz	16QAM	38775	1RB#0	9.04	13	PASS
Band40	5MHz	16QAM	38775	25RB#0	9.94	13	PASS
Band40	5MHz	16QAM	39175	1RB#0	8.93	13	PASS
Band40	5MHz	16QAM	39175	25RB#0	10.09	13	PASS
Band40	5MHz	16QAM	39200	1RB#0	9.25	13	PASS
Band40	5MHz	16QAM	39200	25RB#0	9.74	13	PASS
Band40	5MHz	16QAM	39225	1RB#0	9.01	13	PASS
Band40	5MHz	16QAM	39225	25RB#0	9.97	13	PASS
Band40	10MHz	QPSK	38750	1RB#0	8.26	13	PASS
Band40	10MHz	QPSK	38750	50RB#0	8.90	13	PASS
Band40	10MHz	QPSK	39200	1RB#0	8.75	13	PASS
Band40	10MHz	QPSK	39200	50RB#0	8.87	13	PASS
Band40	10MHz	16QAM	38750	1RB#0	9.51	13	PASS
Band40	10MHz	16QAM	38750	50RB#0	9.74	13	PASS
Band40	10MHz	16QAM	39200	1RB#0	9.42	13	PASS
Band40	10MHz	16QAM	39200	50RB#0	9.68	13	PASS

Test Graphs

Band40_5MHz_QPSK_38725_1RB#0

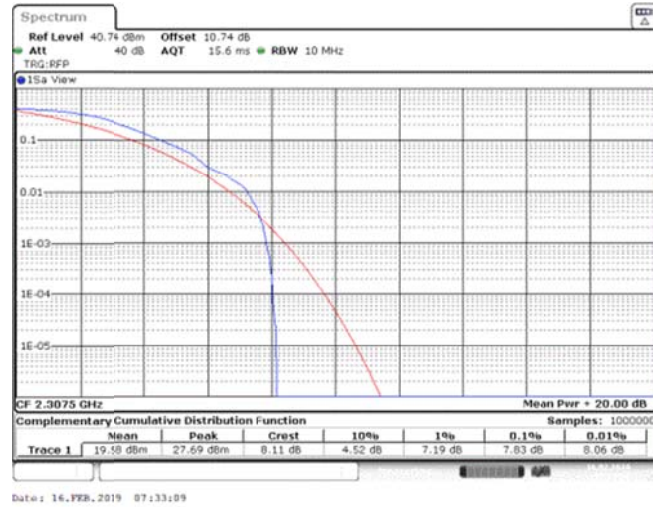

Date: 16.FEB.2019 07:33:09

Band40_5MHz_QPSK_38725_25RB#0

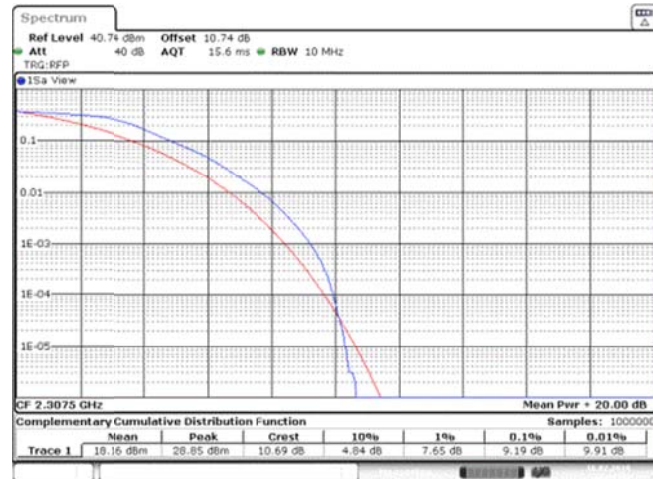

Date: 16.FEB.2019 07:33:33

Band40_5MHz_QPSK_38750_1RB#0

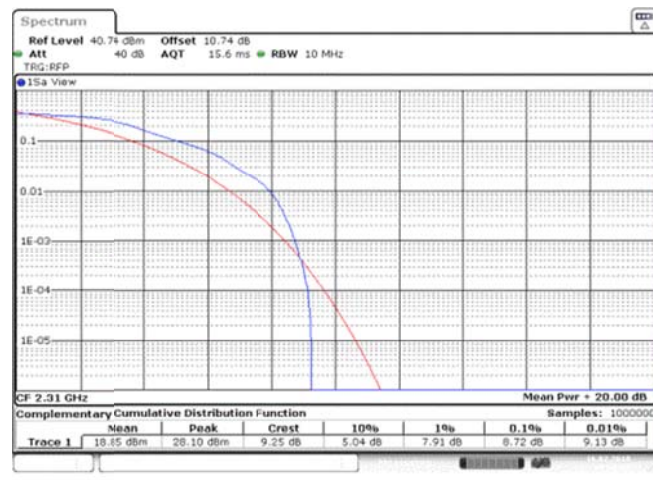

Date: 16.FEB.2019 07:33:57

Band40_5MHz_QPSK_38750_25RB#0

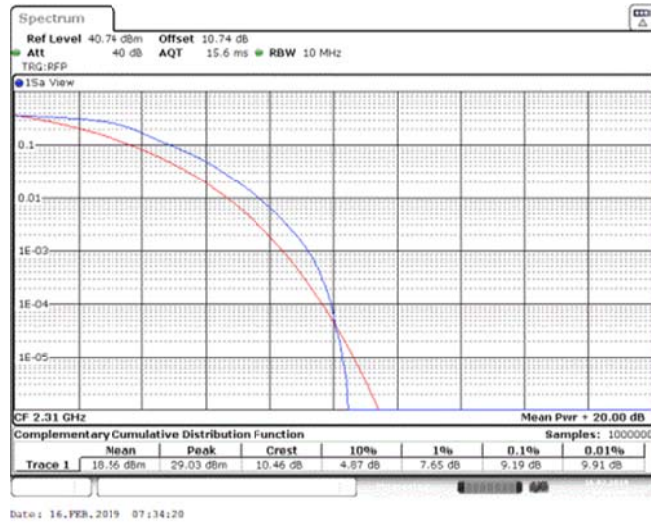

Band40_5MHz_QPSK_38775_1RB#0

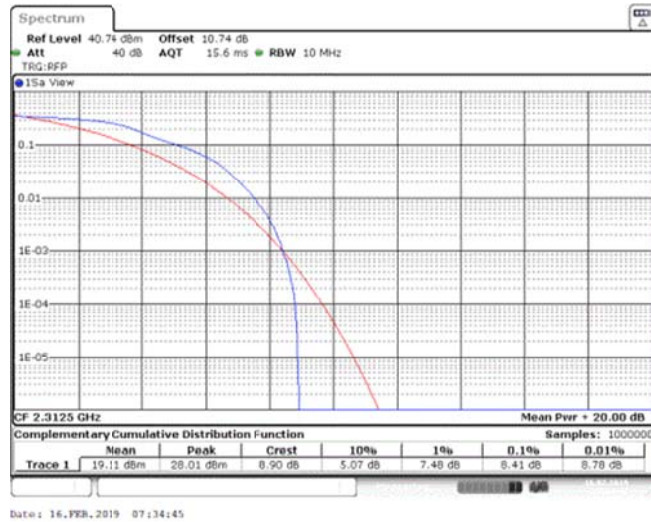

Band40_5MHz_QPSK_38775_25RB#0

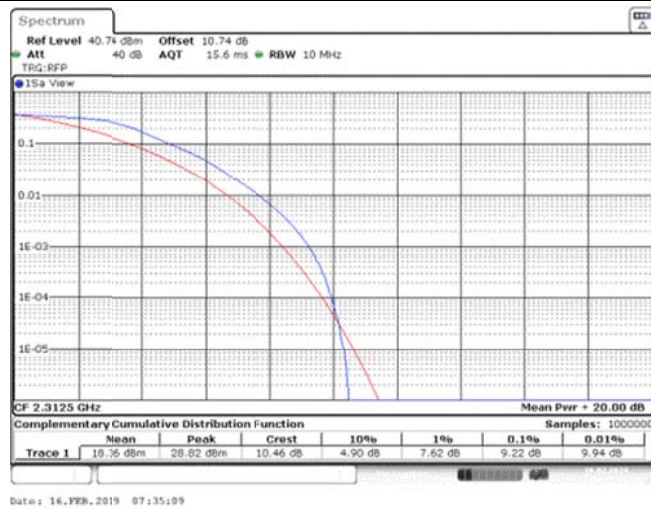

Band40_5MHz_QPSK_39175_1RB#0

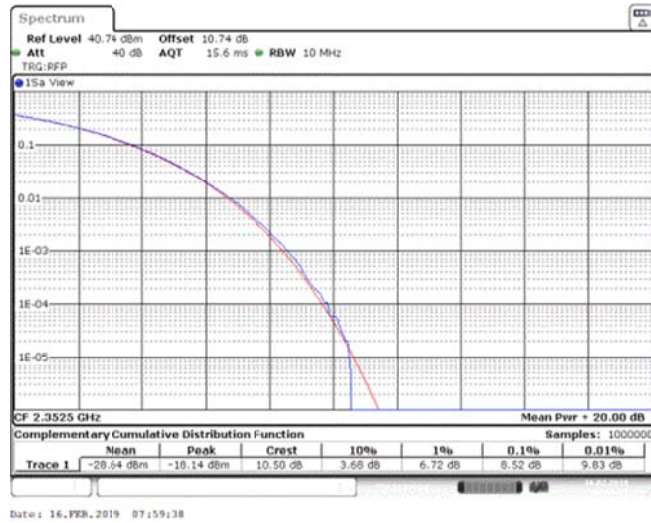

Band40_5MHz_QPSK_39175_25RB#0

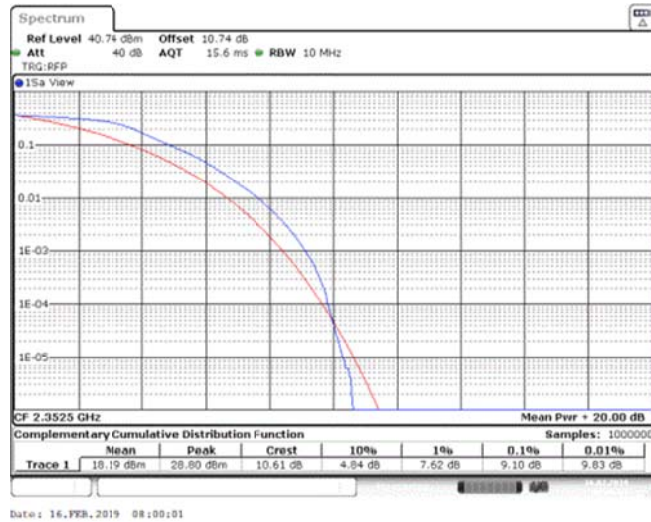

Band40_5MHz_QPSK_39200_1RB#0

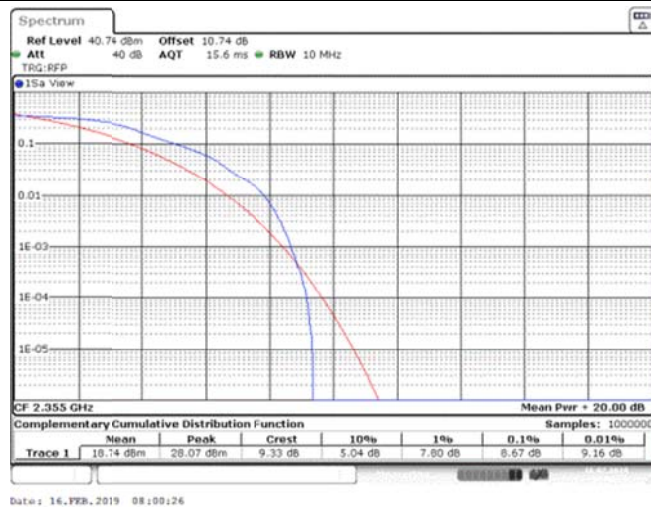

Band40_5MHz_QPSK_39200_25RB#0

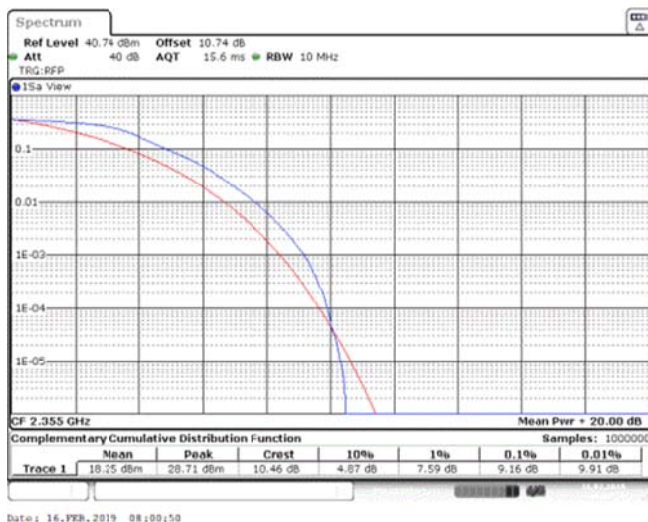

Band40_5MHz_QPSK_39225_1RB#0

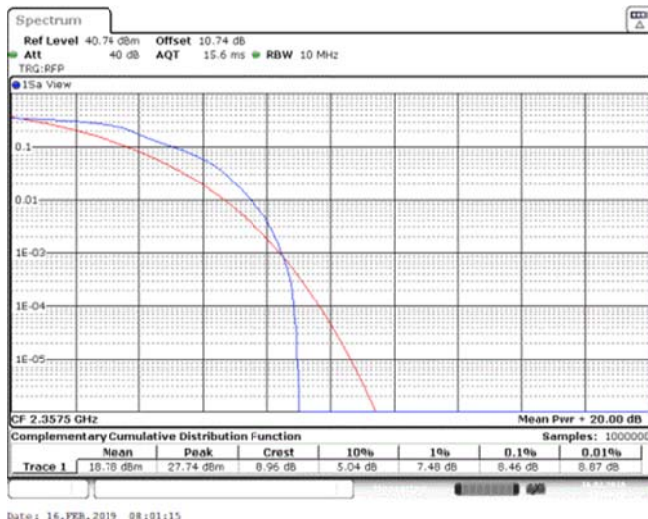

Band40_5MHz_QPSK_39225_25RB#0

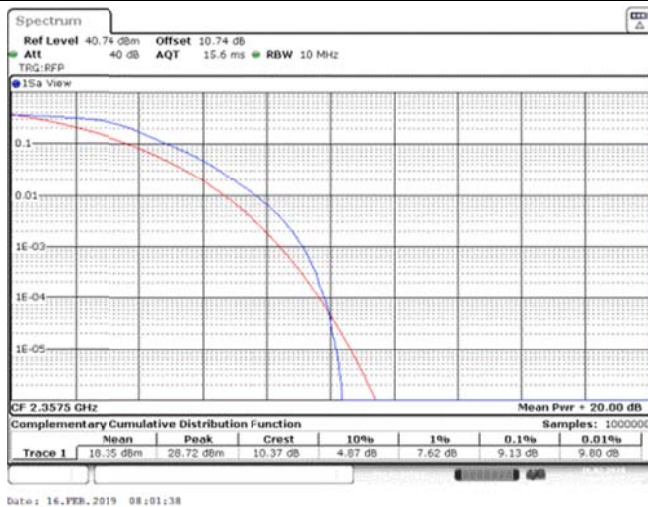

Band40_5MHz_16QAM_38725_1RB#0

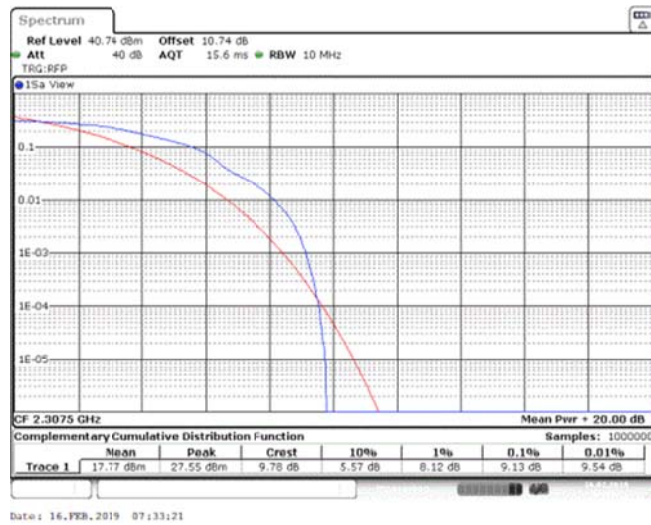

Band40_5MHz_16QAM_38725_25RB#0

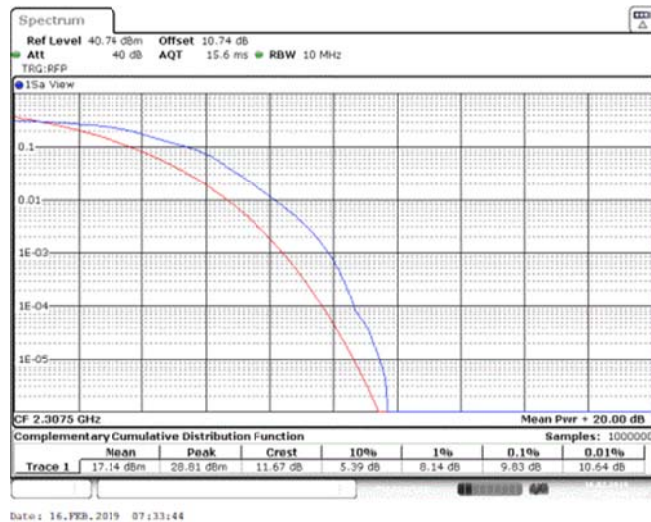

Band40_5MHz_16QAM_38750_1RB#0

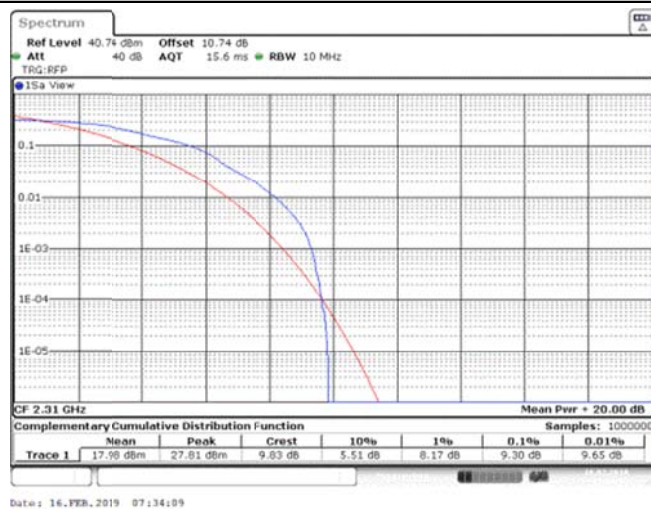

Band40_5MHz_16QAM_38750_25RB#0

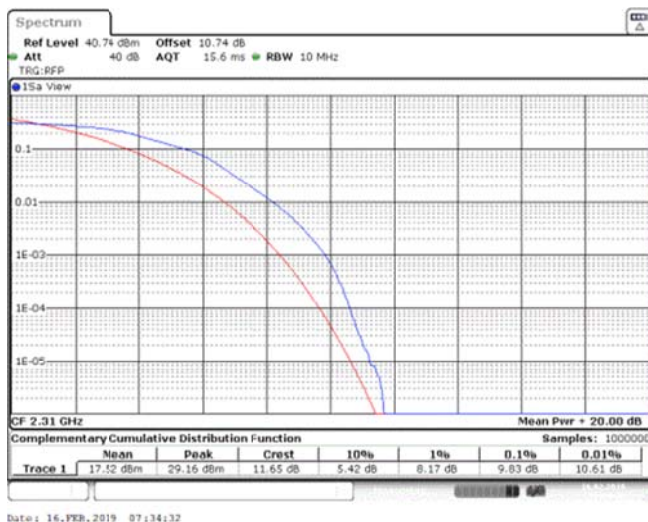

Band40_5MHz_16QAM_38775_1RB#0

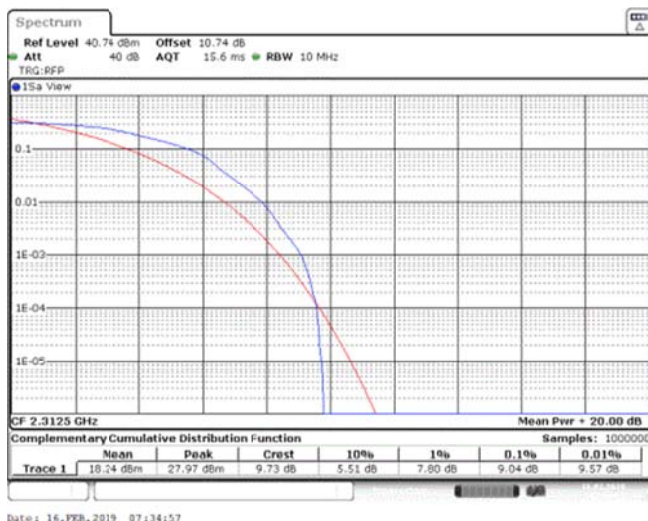

Band40_5MHz_16QAM_38775_25RB#0

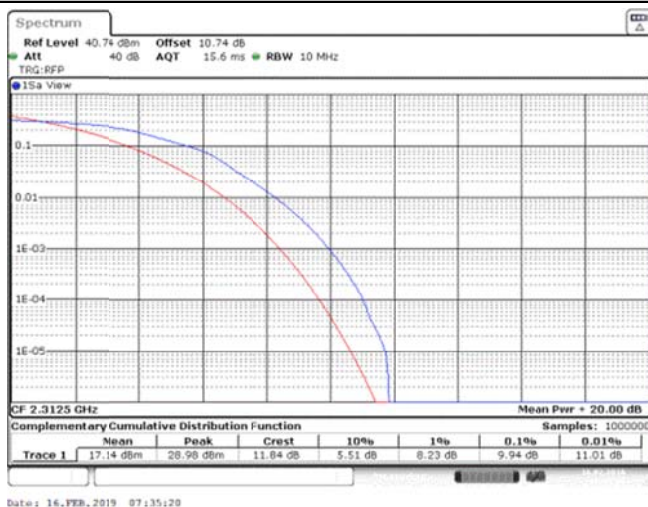

Band40_5MHz_16QAM_39175_1RB#0

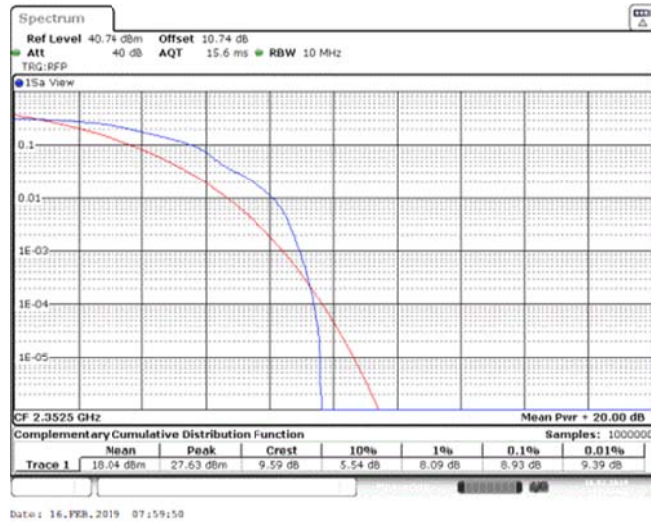

Date: 16.FEB.2019 07:59:58

Band40_5MHz_16QAM_39175_25RB#0

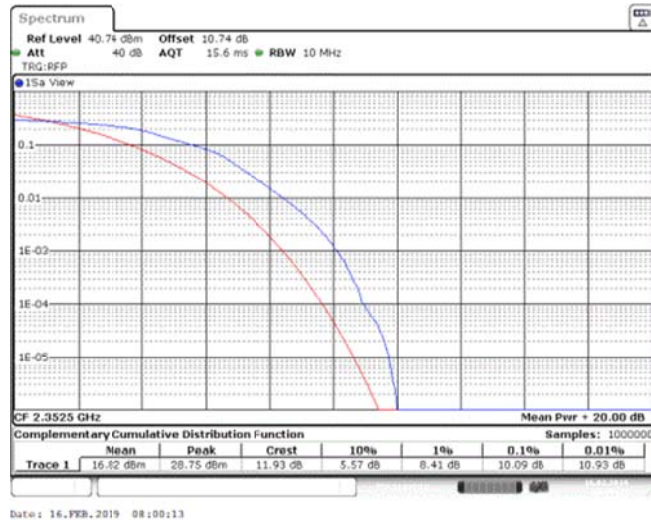

Date: 16.FEB.2019 08:00:13

Band40_5MHz_16QAM_39200_1RB#0

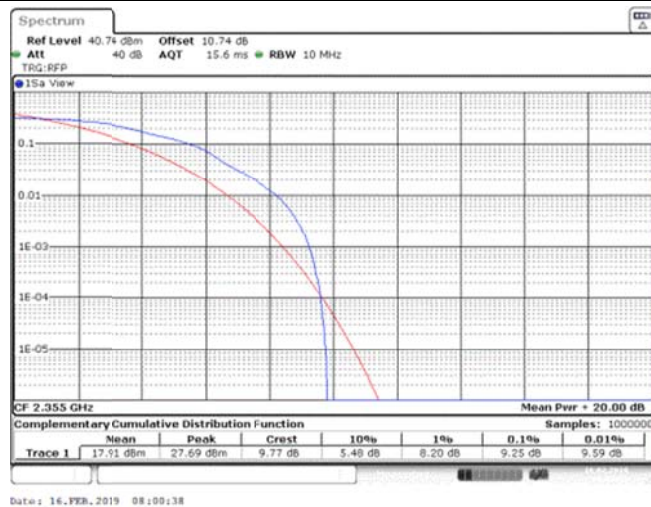

Date: 16.FEB.2019 08:00:38

Band40_5MHz_16QAM_39200_25RB#0

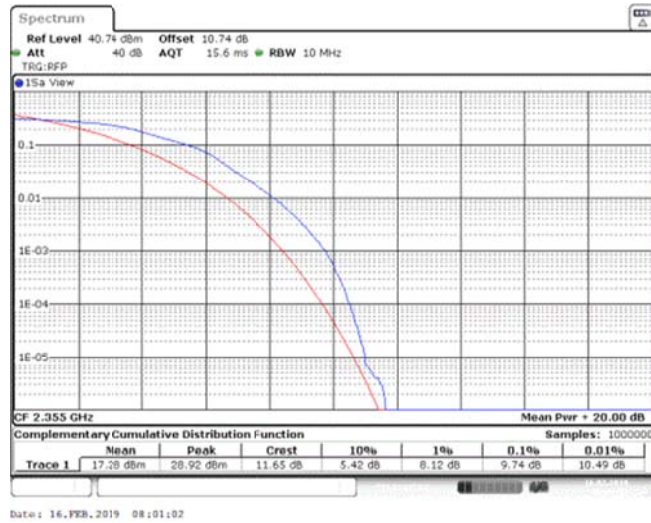

Band40_5MHz_16QAM_39225_1RB#0

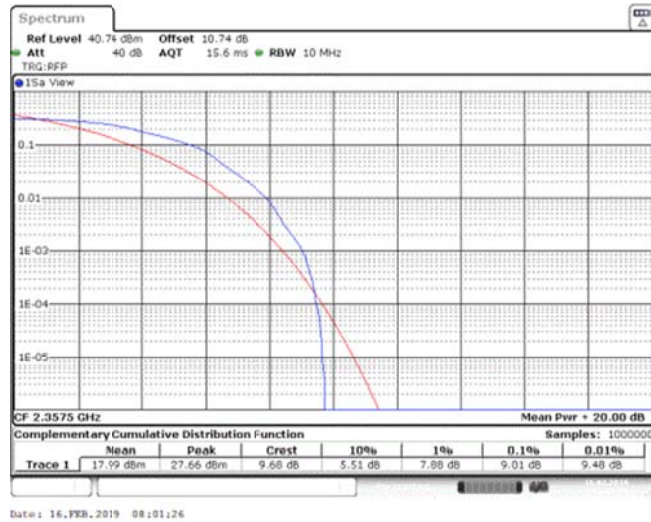

Band40_5MHz_16QAM_39225_25RB#0

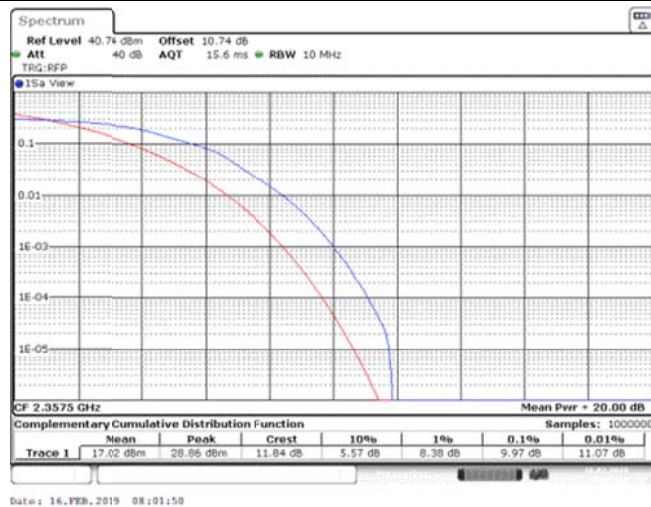

Band40_10MHz_QPSK_38750_1RB#0

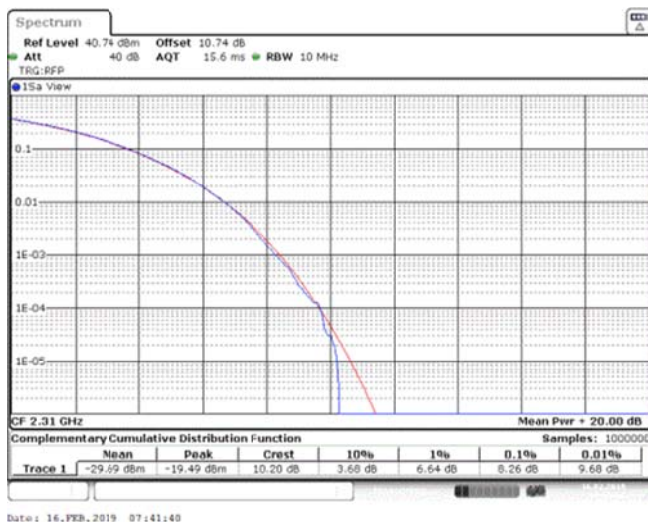

Band40_10MHz_QPSK_38750_50RB#0

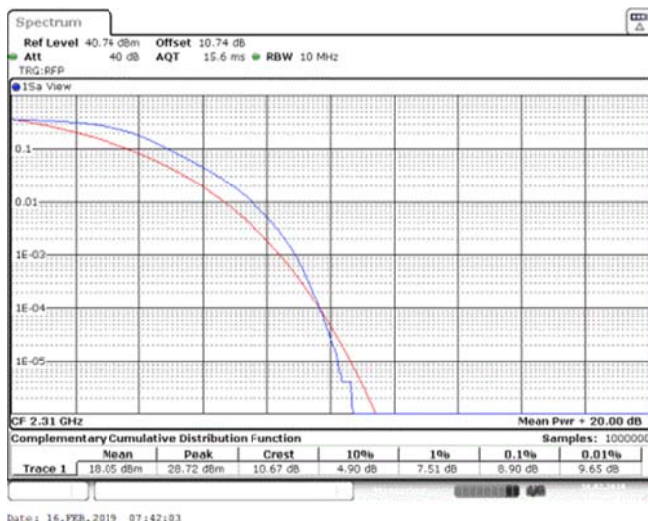

Band40_10MHz_QPSK_39200_1RB#0

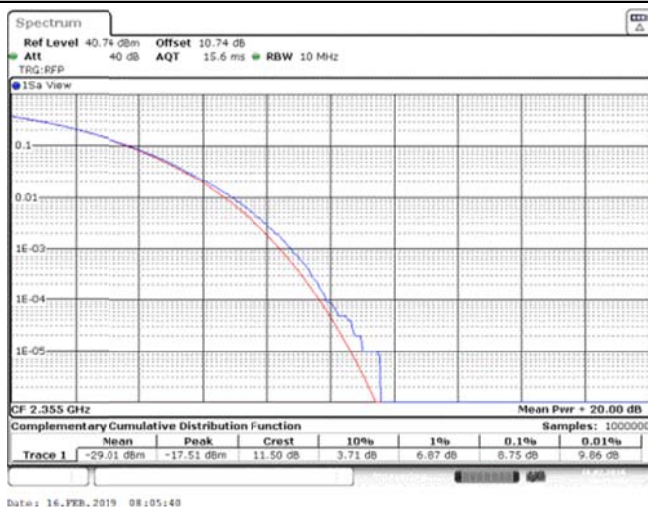

Band40_10MHz_QPSK_39200_50RB#0

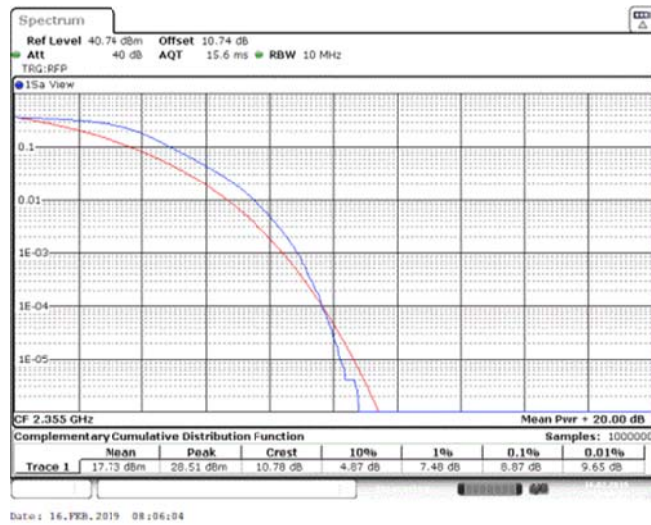

Band40_10MHz_16QAM_38750_1RB#0

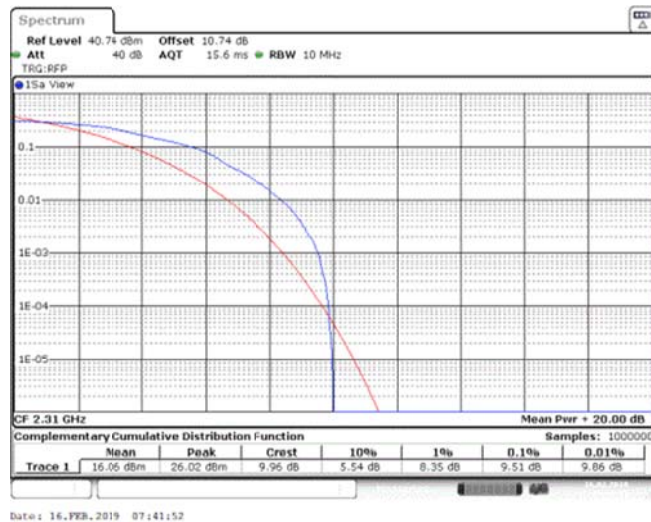

Band40_10MHz_16QAM_38750_50RB#0

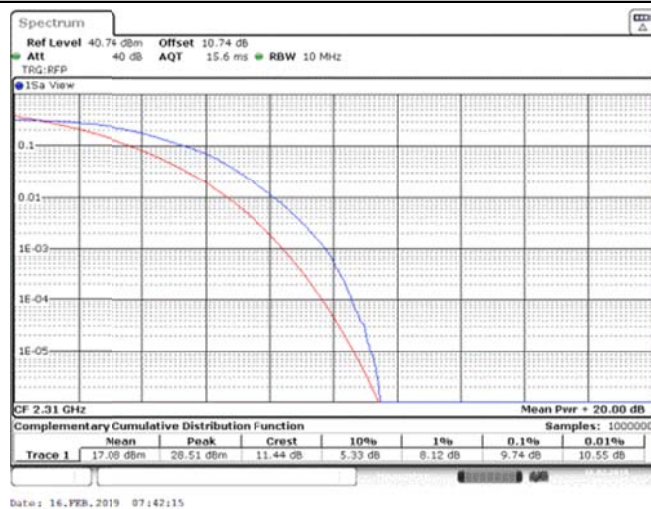

Band40_10MHz_16QAM_39200_1RB#0

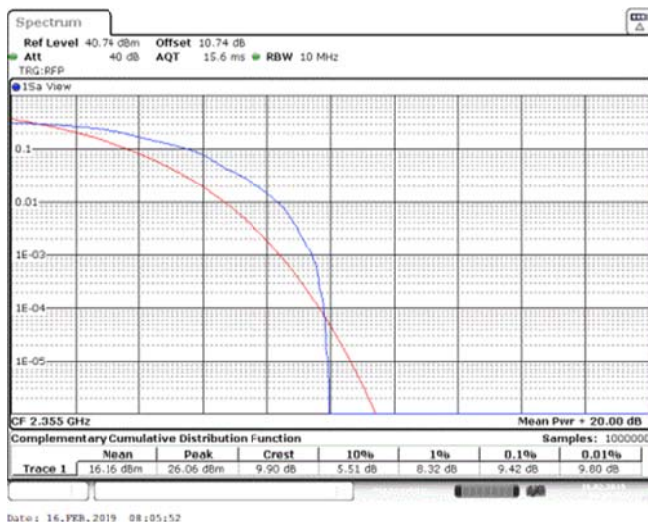

Band40_10MHz_16QAM_39200_50RB#0

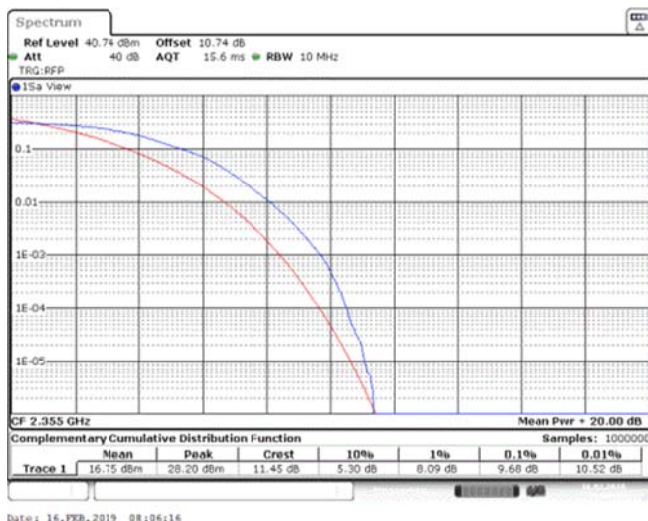

26dB Bandwidth and Occupied Bandwidth
Test Result

Band	Bandwidth	Modulation	Channel	RB Configuration	Occupied Bandwidth (MHz)	26dB Bandwidth (MHz)	Verdict
Band40	5MHz	QPSK	38725	25RB#0	4.496	5.260	PASS
Band40	5MHz	QPSK	38750	25RB#0	4.486	5.250	PASS
Band40	5MHz	QPSK	38775	25RB#0	4.476	5.160	PASS
Band40	5MHz	QPSK	39175	25RB#0	4.486	5.280	PASS
Band40	5MHz	QPSK	39200	25RB#0	4.486	5.200	PASS
Band40	5MHz	QPSK	39225	25RB#0	4.496	5.150	PASS
Band40	5MHz	16QAM	38725	25RB#0	4.486	5.200	PASS
Band40	5MHz	16QAM	38750	25RB#0	4.476	5.200	PASS
Band40	5MHz	16QAM	38775	25RB#0	4.486	5.220	PASS
Band40	5MHz	16QAM	39175	25RB#0	4.486	5.230	PASS
Band40	5MHz	16QAM	39200	25RB#0	4.496	5.220	PASS
Band40	5MHz	16QAM	39225	25RB#0	4.486	5.270	PASS
Band40	10MHz	QPSK	38750	50RB#0	8.971	10.300	PASS
Band40	10MHz	16QAM	38750	50RB#0	8.951	10.340	PASS
Band40	10MHz	QPSK	39200	50RB#0	8.985	10.533	PASS
Band40	10MHz	16QAM	39200	50RB#0	8.985	10.133	PASS

Test Graphs

Band40_5MHz_QPSK_38725_25RB#0

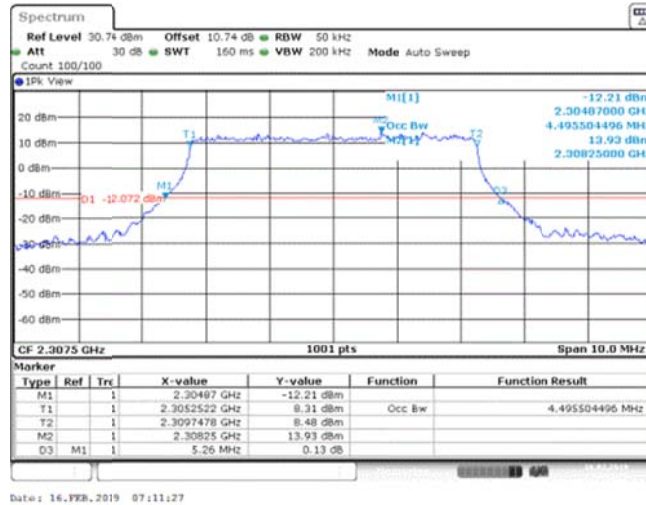

Band40_5MHz_QPSK_38750_25RB#0

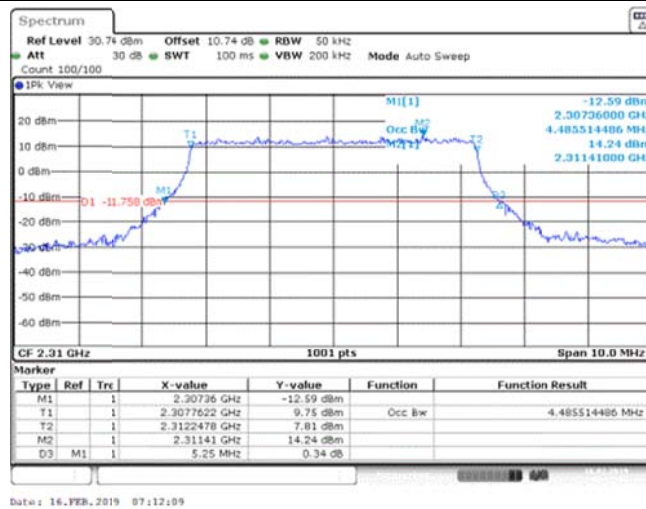

Band40_5MHz_QPSK_38775_25RB#0

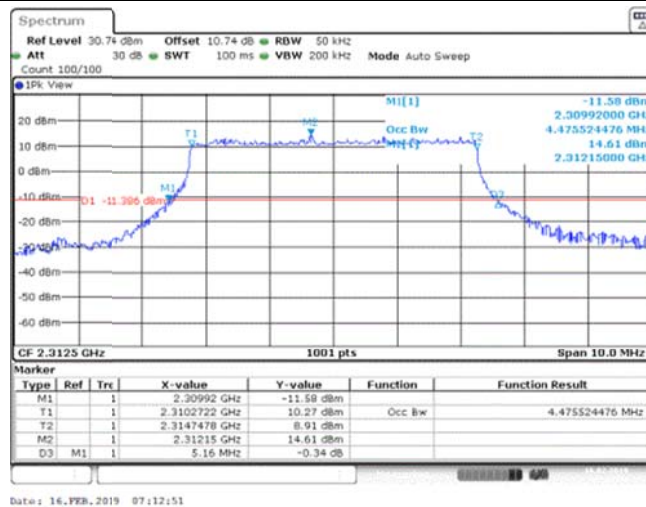

Band40_5MHz_QPSK_39175_25RB#0

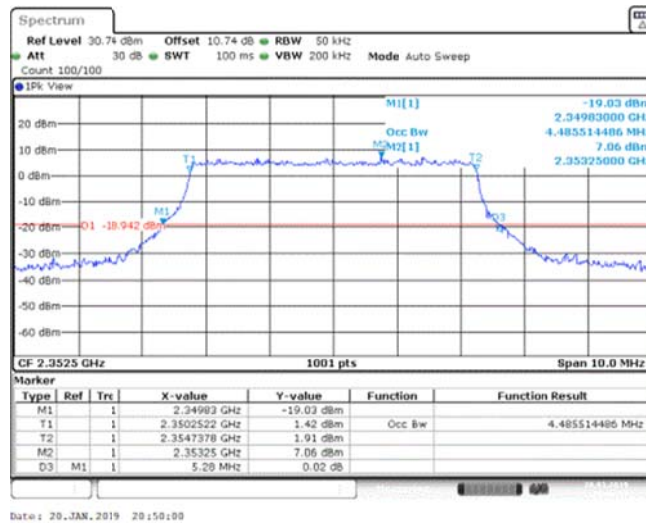

Band40_5MHz_QPSK_39200_25RB#0

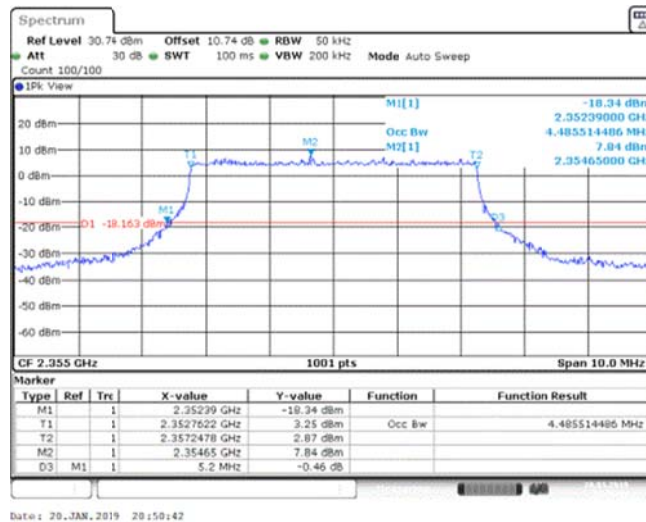

Band40_5MHz_QPSK_39225_25RB#0

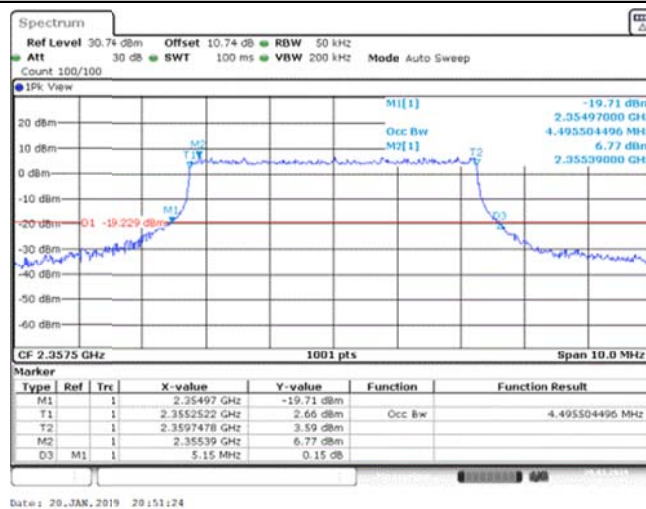

Band40_5MHz_16QAM_38725_25RB#0

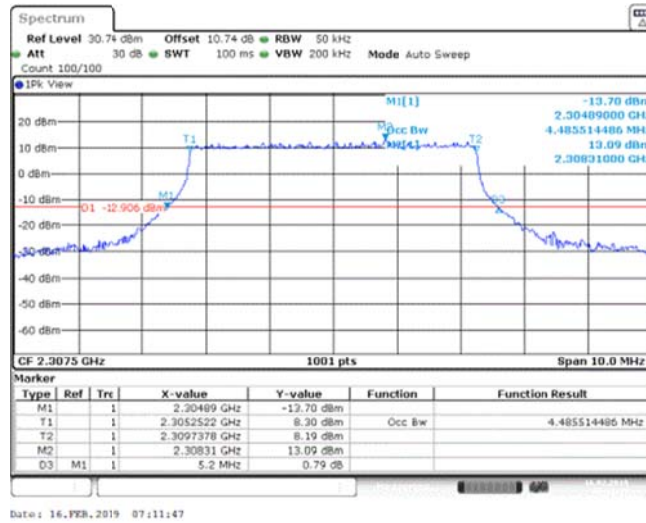

Date: 16.FEB.2019 07:11:47

Band40_5MHz_16QAM_38750_25RB#0

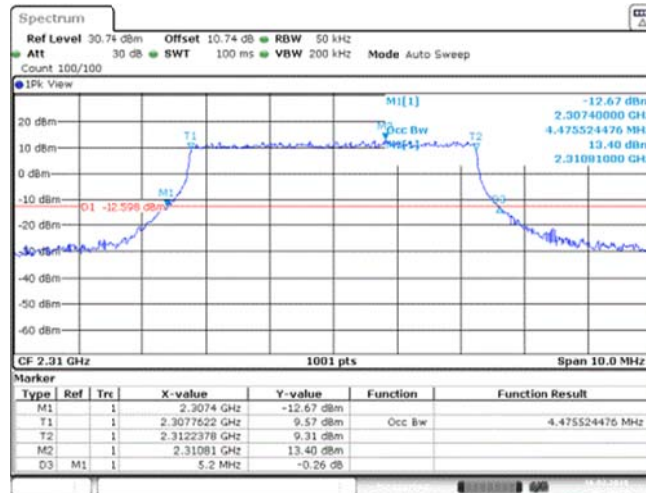

Date: 16.FEB.2019 07:12:29

Band40_5MHz_16QAM_38775_25RB#0

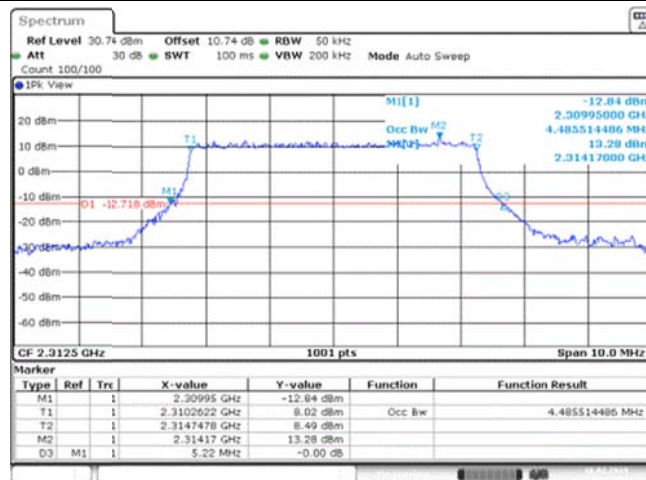

Date: 16.FEB.2019 07:13:11

Band40_5MHz_16QAM_39175_25RB#0

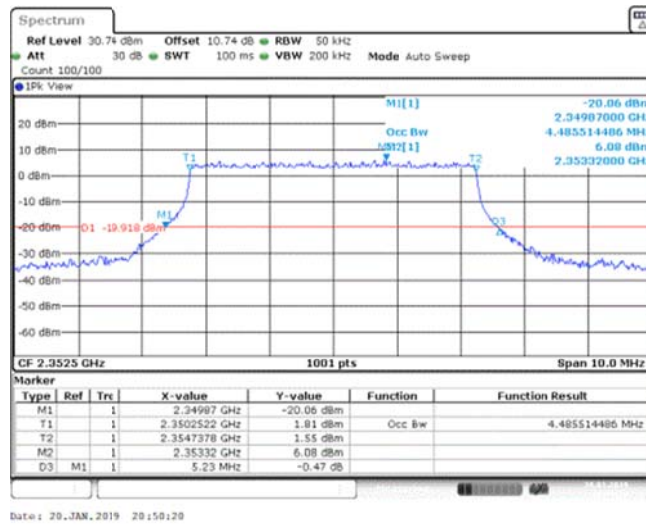

Date: 20.JAN.2019 20:50:28

Band40_5MHz_16QAM_39200_25RB#0

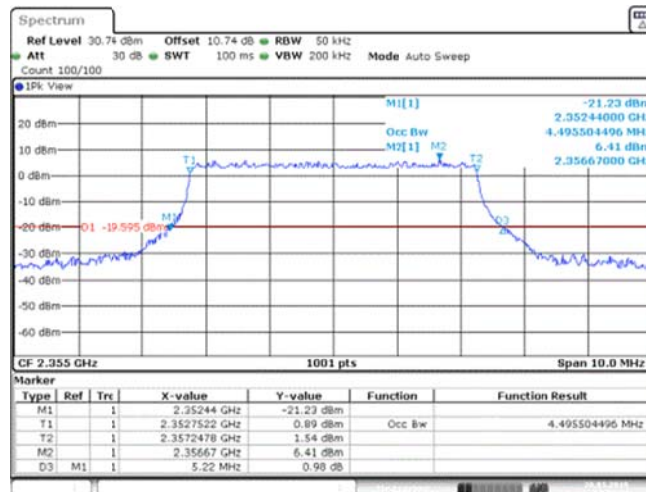

Date: 20.JAN.2019 20:51:02

Band40_5MHz_16QAM_39225_25RB#0

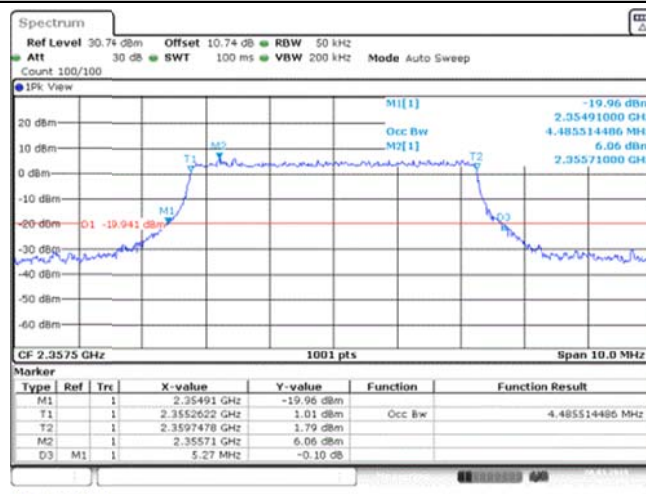

Date: 20.JAN.2019 20:51:45

Band40_10MHz_QPSK_38750_50RB#0

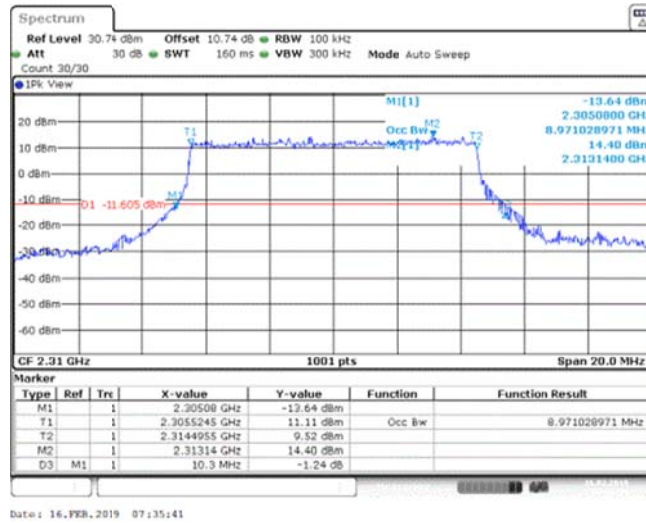

Band40_10MHz_16QAM_38750_50RB#0

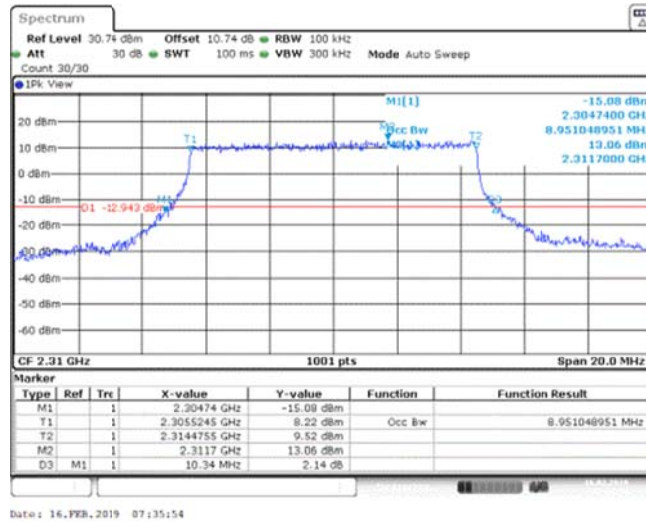

Band40_10MHz_QPSK_39200_50RB#0

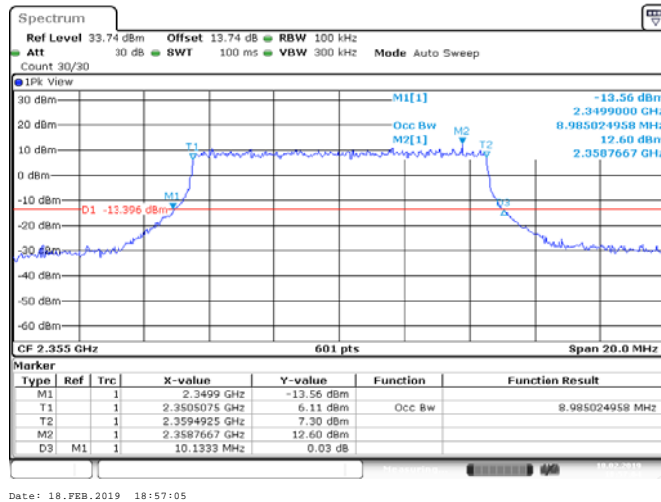

Band40_10MHz_16QAM_39200_50RB#0

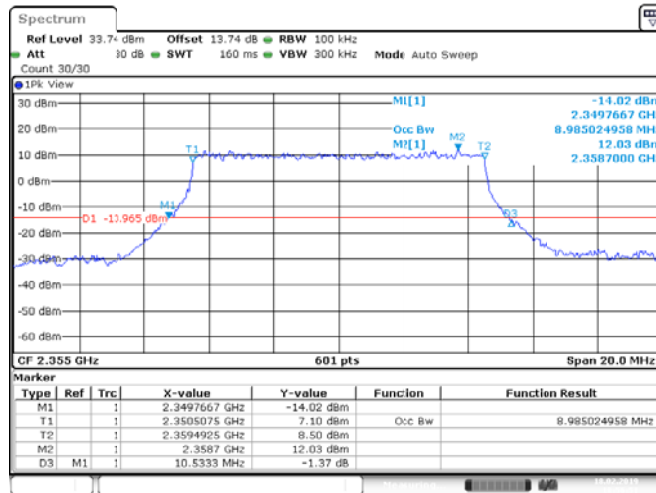

Date: 18.FEB.2019 18:56:51

Conducted Band Edge

Band40_5MHz_QPSK_38725_25RB#0

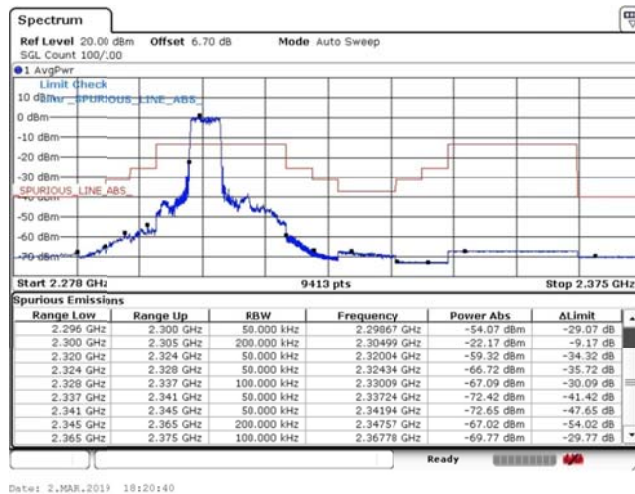

Date: 2.MAR.2019 18:20:40

Band40_5MHz_QPSK_38750_25RB#0

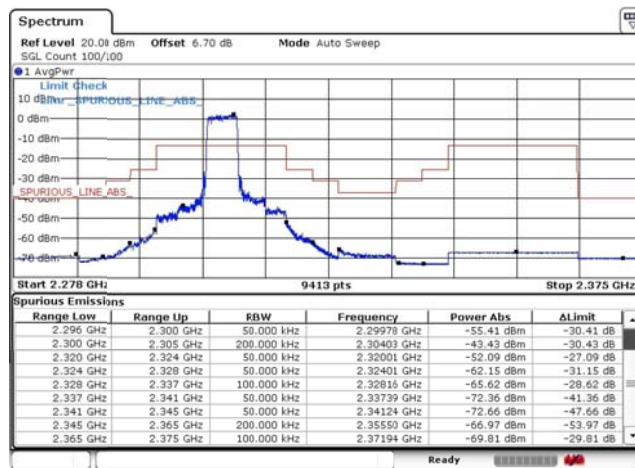

Date: 2.MAR.2019 18:09:59

Band40_5MHz_QPSK_38775_25RB#0

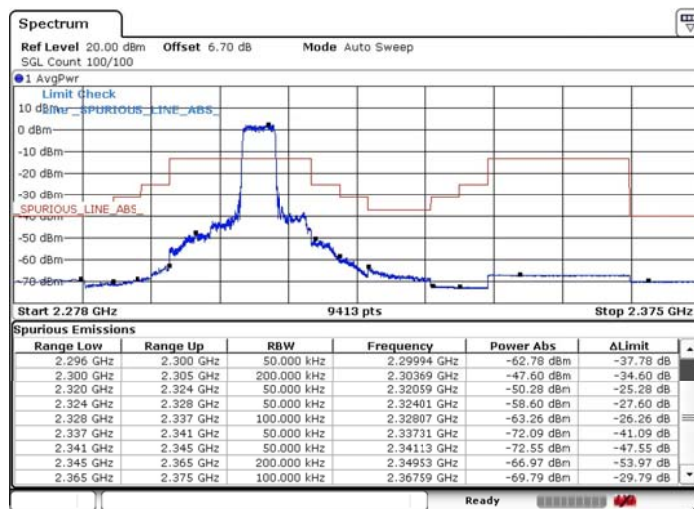

Date: 2.MAR.2019 18:24:04

Band40_5MHz_16QAM_38725_25RB#0

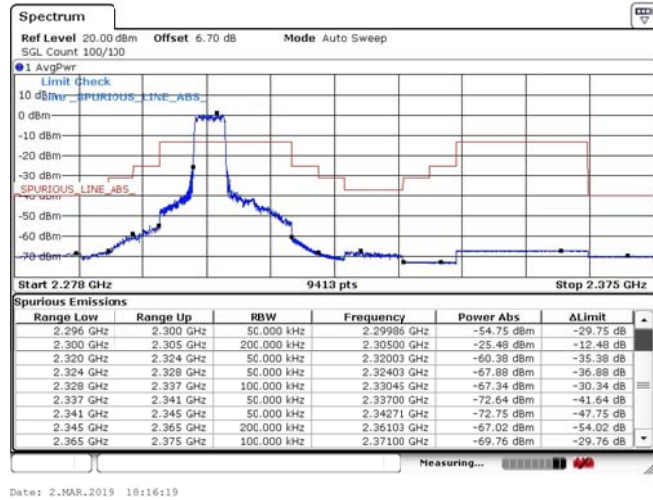

Band40_5MHz_16QAM_38750_25RB#0

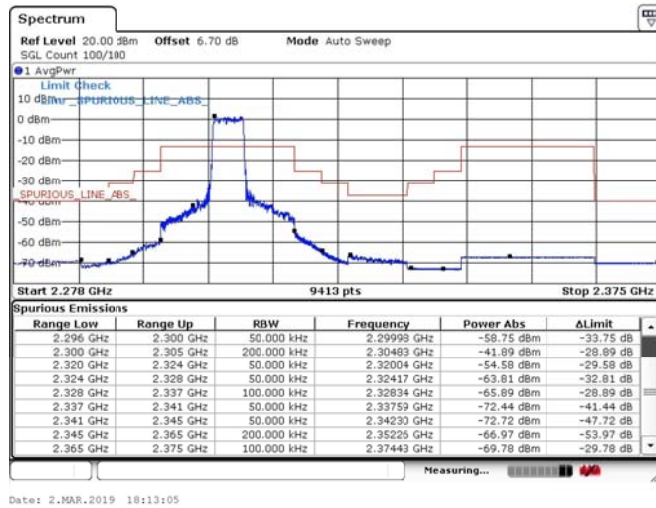

Band40_5MHz_16QAM_39775_25RB#0

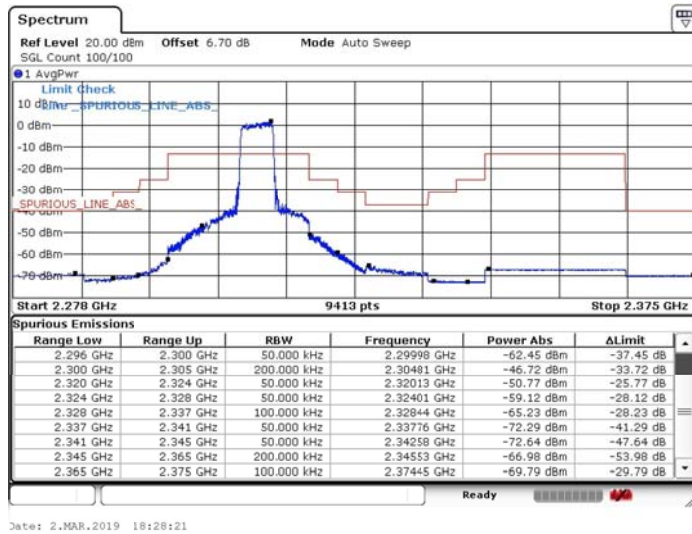

Band40_5MHz_QPSK_39175_25RB#0

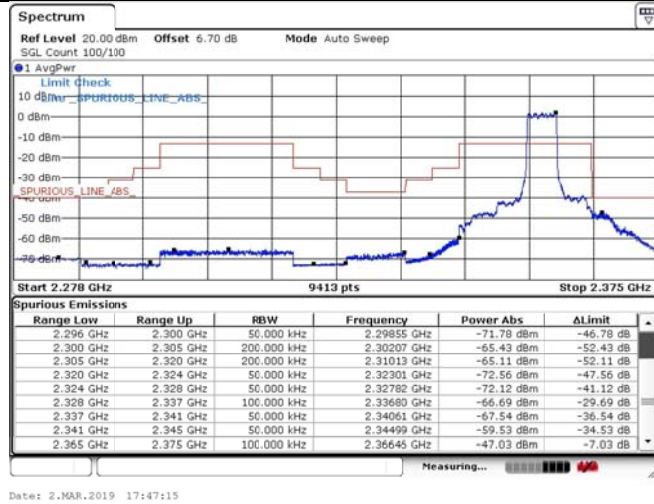

Band40_5MHz_QPSK_39200_25RB#0

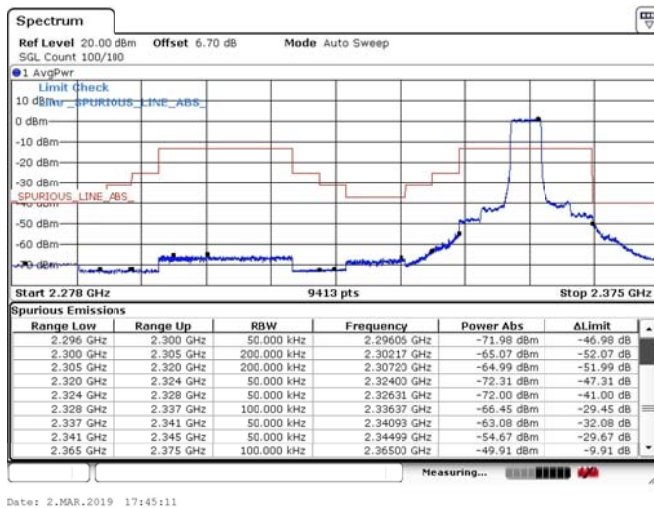

Band40_5MHz_QPSK_39225_1RB#24

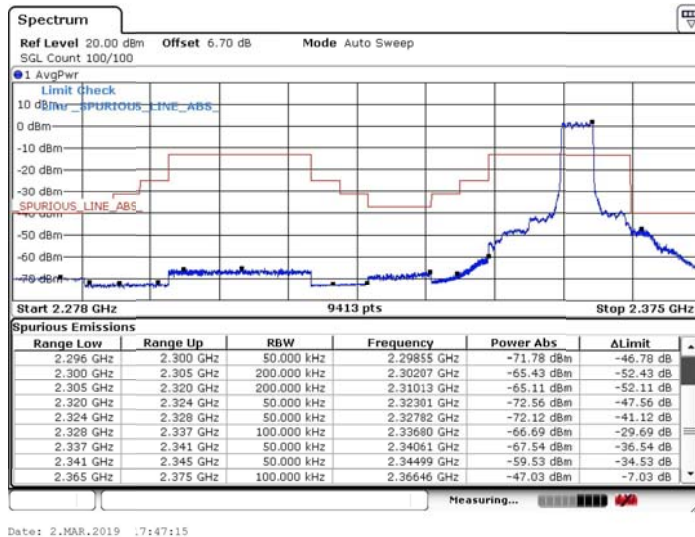

Band40_5MHz_16QAM_39175_25RB#0

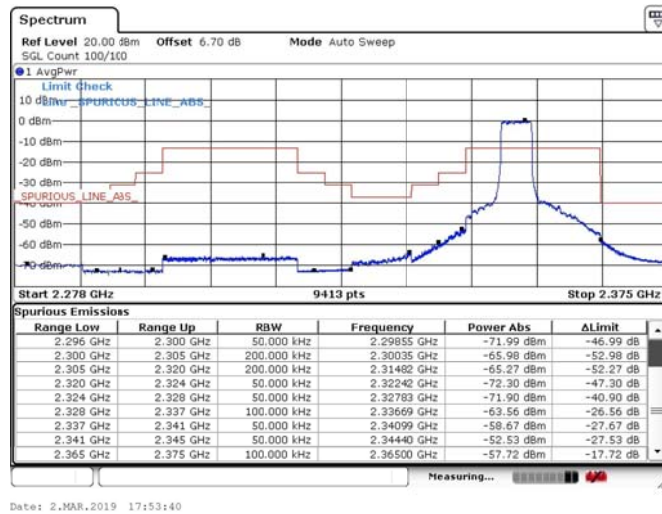

Band40_5MHz_16QAM_39200_25RB#0

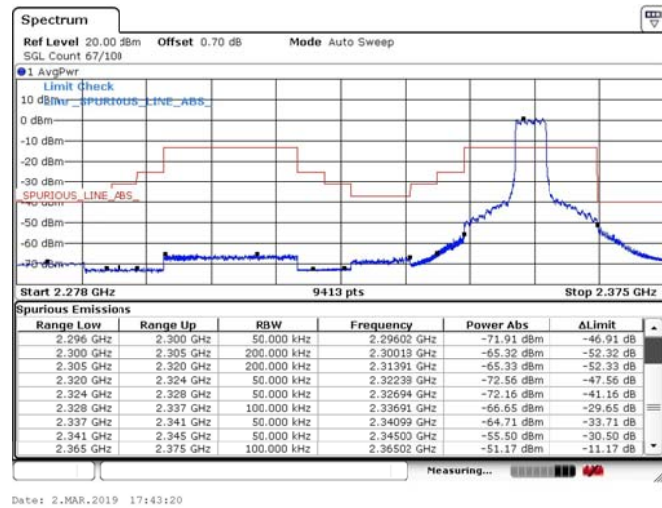

Band40_5MHz_16QAM_39225_1RB#0

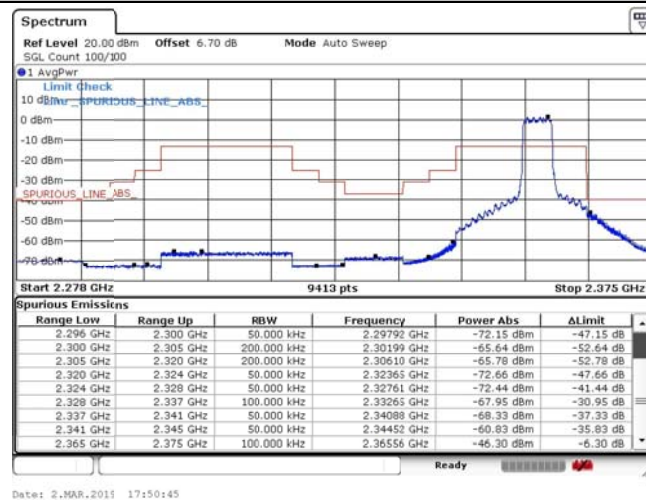

Band40_10MHz_QPSK_38750_50RB#0

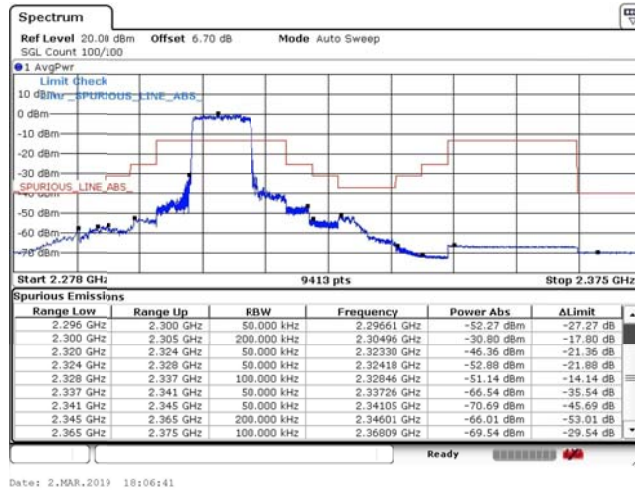

Band40_10MHz_16QAM_38750_50RB#0

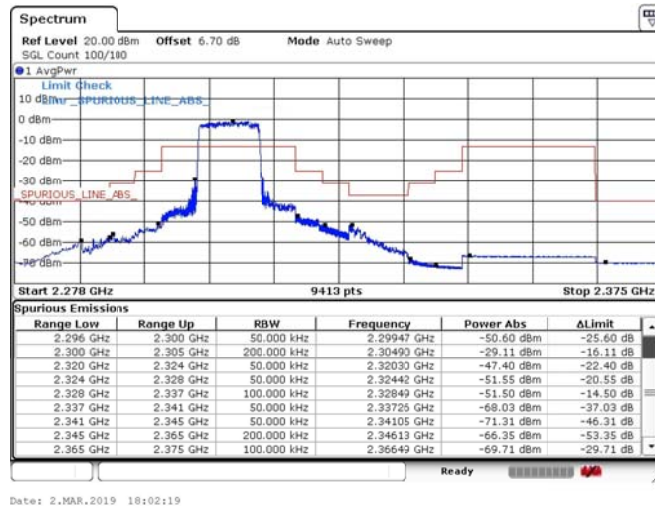

Band40_10MHz_QPSK_39200_50RB#0

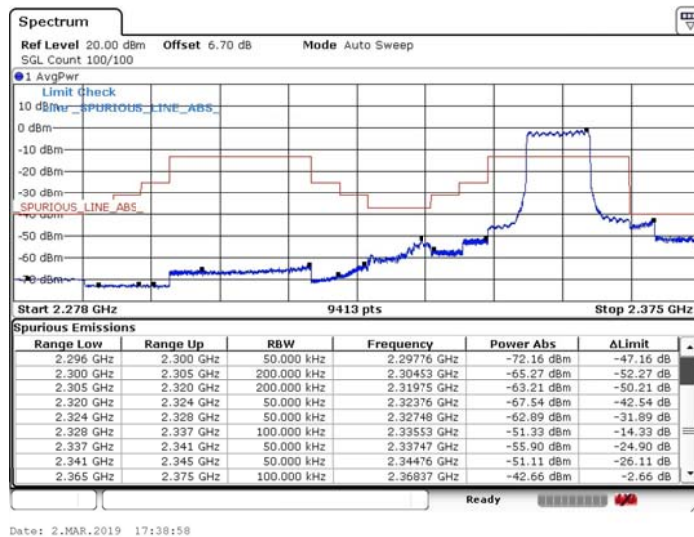

Band40_10MHz_16QAM_39200_50RB#0

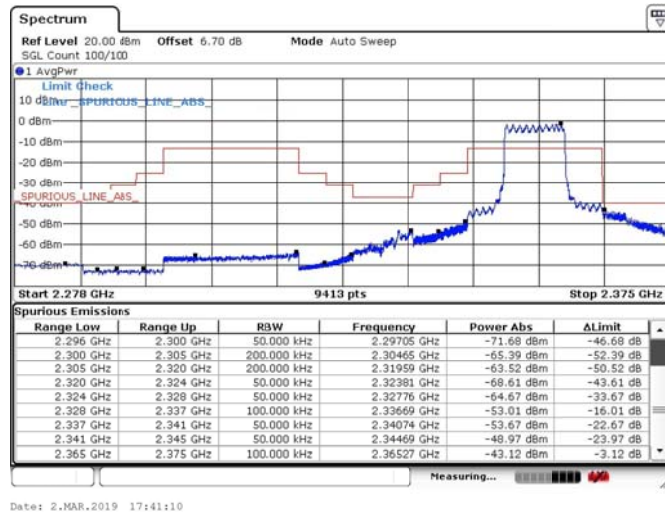

Conducted Spurious Emission

Test Result

Band	Bandwidth	Modulation	Channel	RB Configuration	Frequency Range	Result (dBm)	Verdict
Band40	5MHz	QPSK	38725	25RB#0	Range1:30~1000MHz	-63.84	PASS
Band40	5MHz	QPSK	38725	25RB#0	Range2:1000~5000MHz	-58.04	PASS
Band40	5MHz	QPSK	38725	25RB#0	Range3:5000~12000MHz	-52.89	PASS
Band40	5MHz	QPSK	38725	25RB#0	Range4:12000~26500MHz	-44.95	PASS
Band40	5MHz	QPSK	38750	25RB#0	Range1:30~1000MHz	-63.65	PASS
Band40	5MHz	QPSK	38750	25RB#0	Range2:1000~5000MHz	-58.01	PASS
Band40	5MHz	QPSK	38750	25RB#0	Range3:5000~12000MHz	-52.9	PASS
Band40	5MHz	QPSK	38750	25RB#0	Range4:12000~26500MHz	-44.98	PASS
Band40	5MHz	QPSK	38775	25RB#0	Range1:30~1000MHz	-64.26	PASS
Band40	5MHz	QPSK	38775	25RB#0	Range2:1000~5000MHz	-57.93	PASS
Band40	5MHz	QPSK	38775	25RB#0	Range3:5000~12000MHz	-52.88	PASS
Band40	5MHz	QPSK	38775	25RB#0	Range4:12000~26500MHz	-44.99	PASS
Band40	5MHz	QPSK	39175	25RB#0	Range1:30~1000MHz	-64.19	PASS
Band40	5MHz	QPSK	39175	25RB#0	Range2:1000~5000MHz	-58.02	PASS
Band40	5MHz	QPSK	39175	25RB#0	Range3:5000~12000MHz	-52.85	PASS
Band40	5MHz	QPSK	39175	25RB#0	Range4:12000~26500MHz	-45.01	PASS
Band40	5MHz	QPSK	39200	25RB#0	Range1:30~1000MHz	-63.6	PASS
Band40	5MHz	QPSK	39200	25RB#0	Range2:1000~5000MHz	-57.98	PASS
Band40	5MHz	QPSK	39200	25RB#0	Range3:5000~12000MHz	-52.91	PASS
Band40	5MHz	QPSK	39200	25RB#0	Range4:12000~26500MHz	-44.99	PASS
Band40	5MHz	QPSK	39225	25RB#0	Range1:30~1000MHz	-63.34	PASS
Band40	5MHz	QPSK	39225	25RB#0	Range2:1000~5000MHz	-58.02	PASS
Band40	5MHz	QPSK	39225	25RB#0	Range3:5000~12000MHz	-52.91	PASS
Band40	5MHz	QPSK	39225	25RB#0	Range4:12000~26500MHz	-44.96	PASS
Band40	5MHz	16QAM	38725	25RB#0	Range1:30~1000MHz	-63.95	PASS
Band40	5MHz	16QAM	38725	25RB#0	Range2:1000~5000MHz	-58.02	PASS
Band40	5MHz	16QAM	38725	25RB#0	Range3:5000~12000MHz	-52.88	PASS
Band40	5MHz	16QAM	38725	25RB#0	Range4:12000~26500MHz	-44.96	PASS
Band40	5MHz	16QAM	38750	25RB#0	Range1:30~1000MHz	-64.19	PASS
Band40	5MHz	16QAM	38750	25RB#0	Range2:1000~5000MHz	-58	PASS
Band40	5MHz	16QAM	38750	25RB#0	Range3:5000~12000MHz	-52.86	PASS
Band40	5MHz	16QAM	38750	25RB#0	Range4:12000~26500MHz	-44.92	PASS

Band40	5MHz	16QAM	38775	25RB#0	Range1:30~1000MHz	-63.4	PASS
Band40	5MHz	16QAM	38775	25RB#0	Range2:1000~5000MHz	-58.01	PASS
Band40	5MHz	16QAM	38775	25RB#0	Range3:5000~12000MHz	-52.91	PASS
Band40	5MHz	16QAM	38775	25RB#0	Range4:12000~26500MHz	-44.97	PASS
Band40	5MHz	16QAM	39175	25RB#0	Range1:30~1000MHz	-63.92	PASS
Band40	5MHz	16QAM	39175	25RB#0	Range2:1000~5000MHz	-58.03	PASS
Band40	5MHz	16QAM	39175	25RB#0	Range3:5000~12000MHz	-52.91	PASS
Band40	5MHz	16QAM	39175	25RB#0	Range4:12000~26500MHz	-45.05	PASS
Band40	5MHz	16QAM	39200	25RB#0	Range1:30~1000MHz	-64.48	PASS
Band40	5MHz	16QAM	39200	25RB#0	Range2:1000~5000MHz	-58.01	PASS
Band40	5MHz	16QAM	39200	25RB#0	Range3:5000~12000MHz	-52.87	PASS
Band40	5MHz	16QAM	39200	25RB#0	Range4:12000~26500MHz	-45.02	PASS
Band40	5MHz	16QAM	39225	25RB#0	Range1:30~1000MHz	-64.38	PASS
Band40	5MHz	16QAM	39225	25RB#0	Range2:1000~5000MHz	-58.05	PASS
Band40	5MHz	16QAM	39225	25RB#0	Range3:5000~12000MHz	-52.92	PASS
Band40	5MHz	16QAM	39225	25RB#0	Range4:12000~26500MHz	-45.06	PASS
Band40	10MHz	QPSK	38750	50RB#0	Range1:30~1000MHz	-64.58	PASS
Band40	10MHz	QPSK	38750	50RB#0	Range2:1000~5000MHz	-58	PASS
Band40	10MHz	QPSK	38750	50RB#0	Range3:5000~12000MHz	-52.88	PASS
Band40	10MHz	QPSK	38750	50RB#0	Range4:12000~26500MHz	-44.96	PASS
Band40	10MHz	QPSK	39200	50RB#0	Range1:30~1000MHz	-64.26	PASS
Band40	10MHz	QPSK	39200	50RB#0	Range2:1000~5000MHz	-58.04	PASS
Band40	10MHz	QPSK	39200	50RB#0	Range3:5000~12000MHz	-52.93	PASS
Band40	10MHz	QPSK	39200	50RB#0	Range4:12000~26500MHz	-45.05	PASS
Band40	10MHz	16QAM	38750	50RB#0	Range1:30~1000MHz	-63.82	PASS
Band40	10MHz	16QAM	38750	50RB#0	Range2:1000~5000MHz	-58.04	PASS
Band40	10MHz	16QAM	38750	50RB#0	Range3:5000~12000MHz	-52.91	PASS
Band40	10MHz	16QAM	38750	50RB#0	Range4:12000~26500MHz	-45.02	PASS
Band40	10MHz	16QAM	39200	50RB#0	Range1:30~1000MHz	-63.75	PASS
Band40	10MHz	16QAM	39200	50RB#0	Range2:1000~5000MHz	-58	PASS
Band40	10MHz	16QAM	39200	50RB#0	Range3:5000~12000MHz	-52.88	PASS
Band40	10MHz	16QAM	39200	50RB#0	Range4:12000~26500MHz	-44.97	PASS

Test Graphs

Band40_5MHz_QPSK_38725_25RB#0

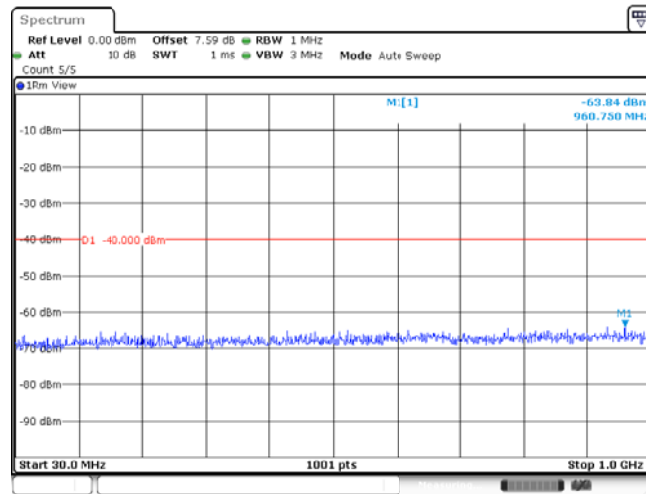

Date: 4.MAR.2019 22:12:20

Band40_5MHz_QPSK_38725_25RB#0

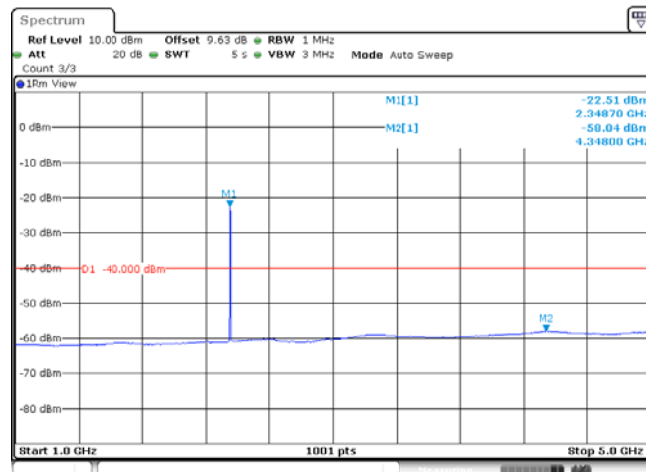

Date: 4.MAR.2019 22:12:46

Band40_5MHz_QPSK_38725_25RB#0

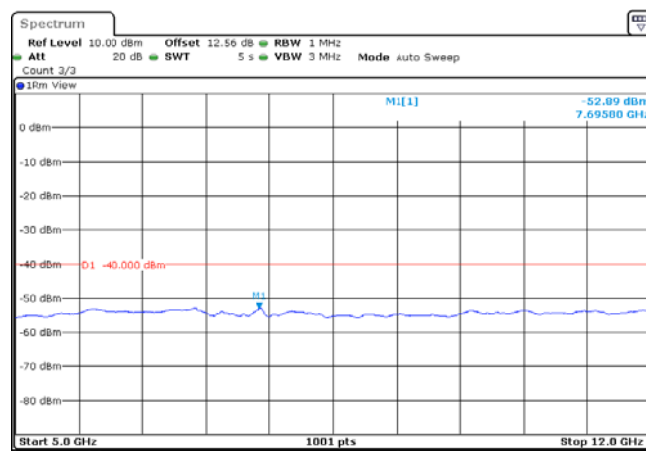

Date: 4.MAR.2019 22:13:11

Band40_5MHz_QPSK_38725_25RB#0

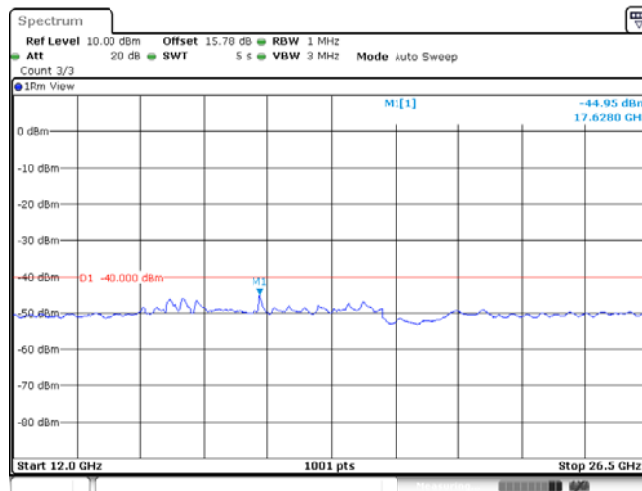

Date: 4.MAR.2019 22:13:36

Band40_5MHz_QPSK_38750_25RB#0

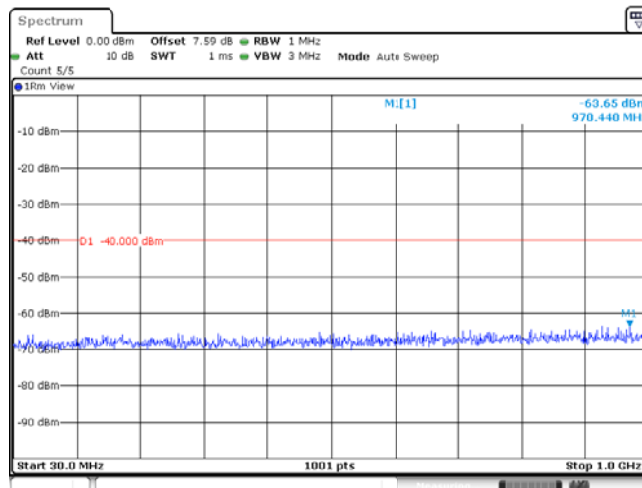

Date: 4.MAR.2019 22:15:18

Band40_5MHz_QPSK_38750_25RB#0

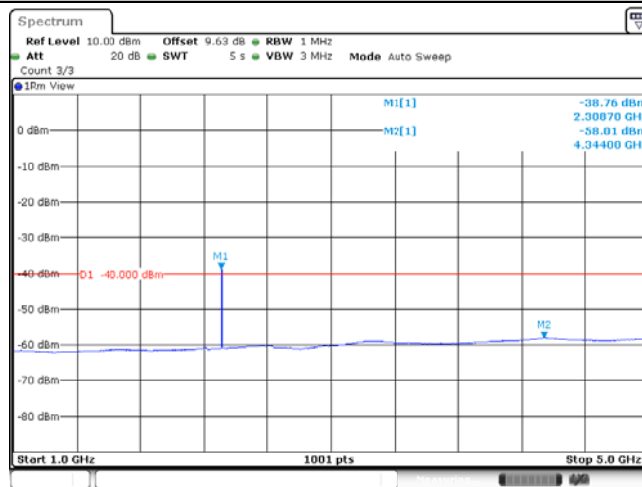

Date: 4.MAR.2019 22:15:44

Band40_5MHz_QPSK_38750_25RB#0

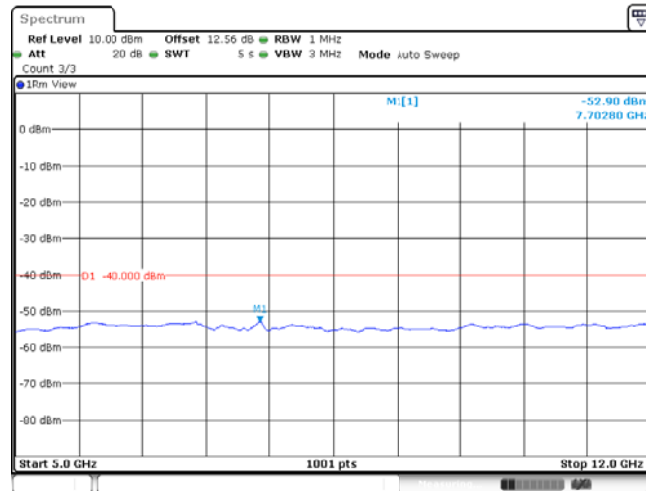

Date: 4.MAR.2019 22:16:09

Band40_5MHz_QPSK_38750_25RB#0

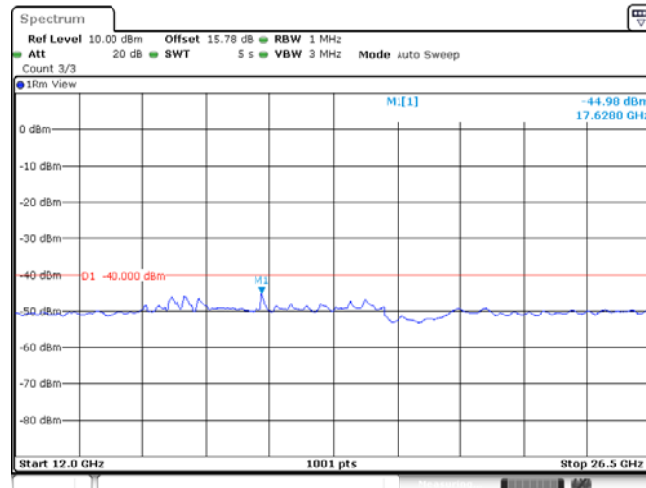

Date: 4.MAR.2019 22:16:35

Band40_5MHz_QPSK_38775_25RB#0

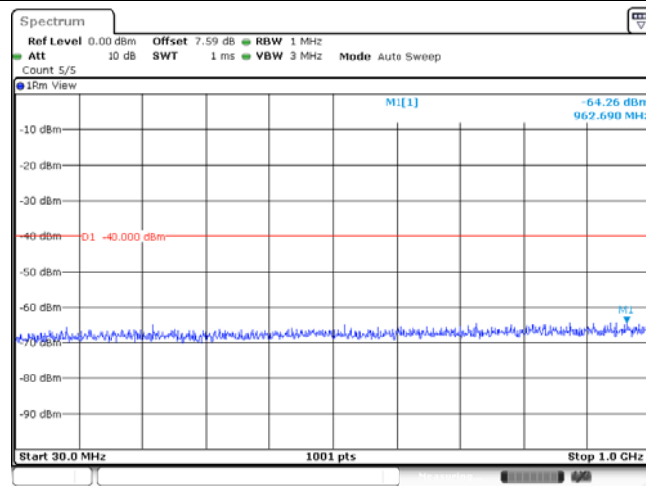

Date: 4.MAR.2019 22:18:17

Band40_5MHz_QPSK_38775_25RB#0

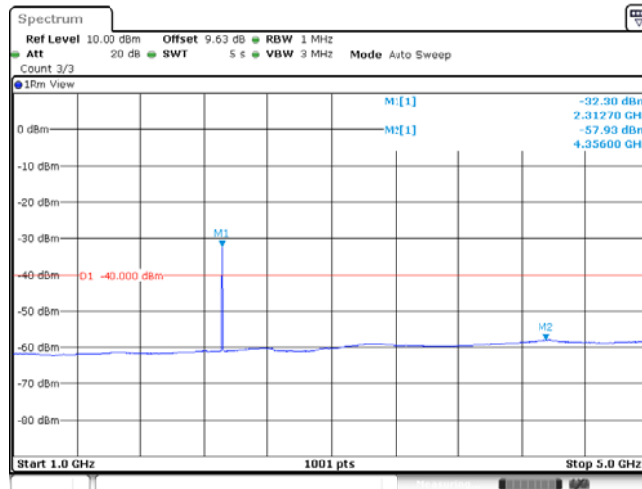

Date: 4.MAR.2019 22:18:43

Band40_5MHz_QPSK_38775_25RB#0

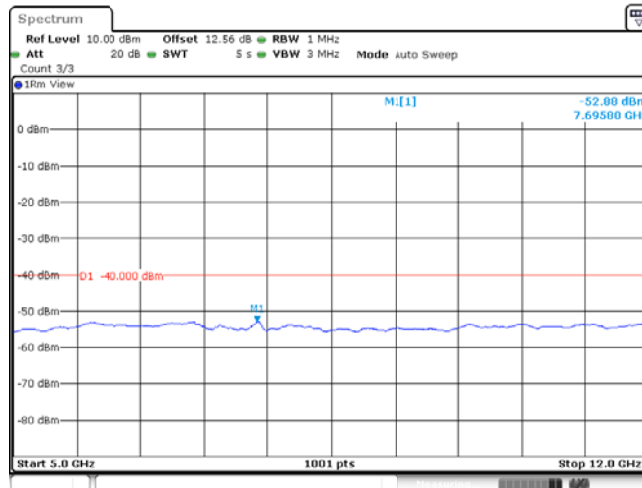

Date: 4.MAR.2019 22:19:08

Band40_5MHz_QPSK_38775_25RB#0

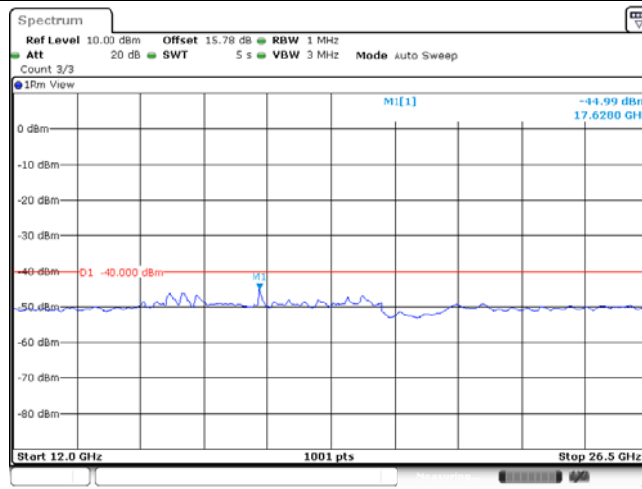

Date: 4.MAR.2019 22:19:34

Band40_5MHz_QPSK_39175_25RB#0

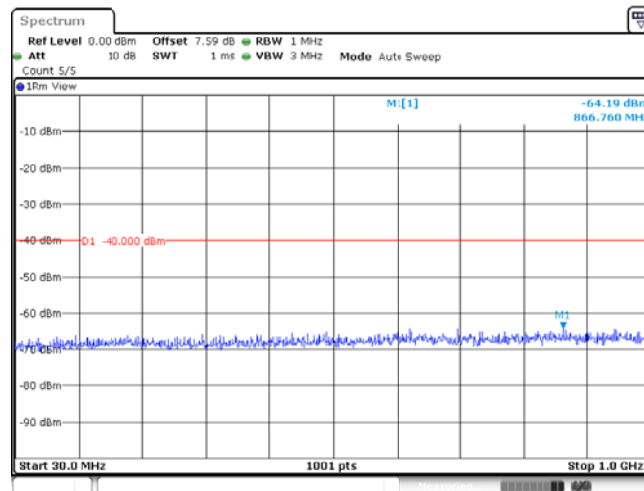

Date: 4.MAR.2019 22:34:01

Band40_5MHz_QPSK_39175_25RB#0

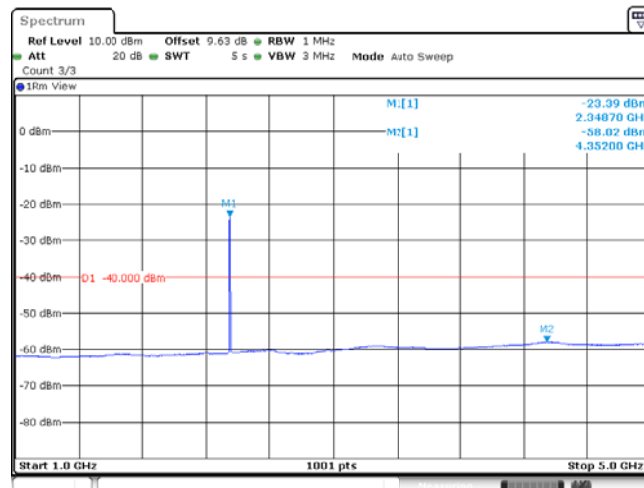

Date: 4.MAR.2019 22:34:27

Band40_5MHz_QPSK_39175_25RB#0

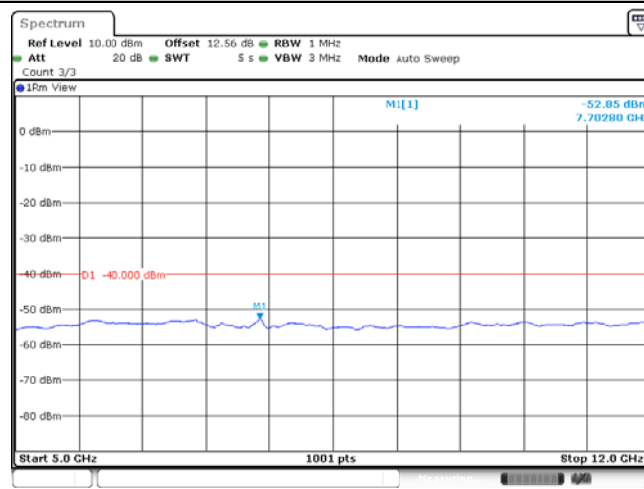

Date: 4.MAR.2019 22:34:52

Band40_5MHz_QPSK_39175_25RB#0

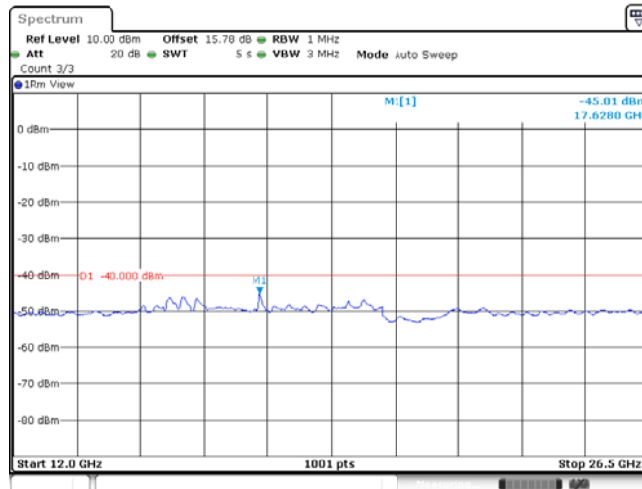

Date: 4.MAR.2019 22:35:18

Band40_5MHz_QPSK_39200_25RB#0

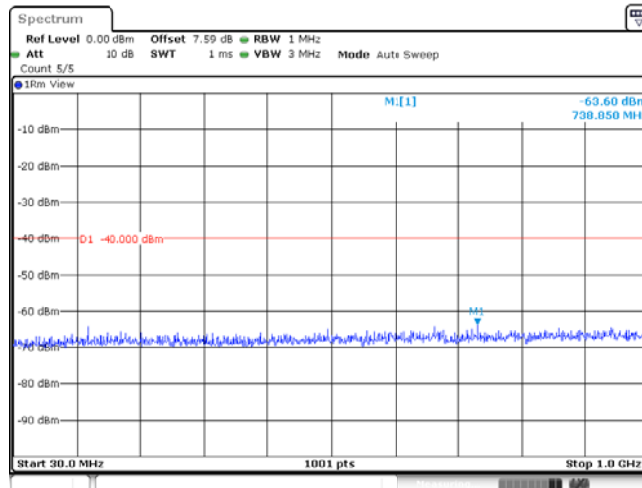

Date: 4.MAR.2019 22:37:03

Band40_5MHz_QPSK_39200_25RB#0

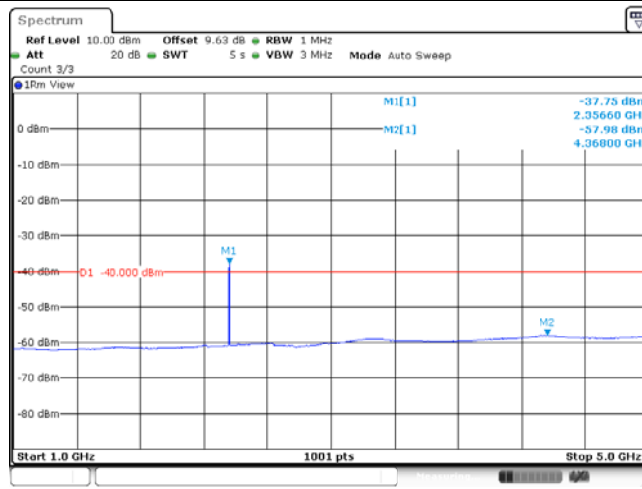

Date: 4.MAR.2019 22:37:29

Band40_5MHz_QPSK_39200_25RB#0

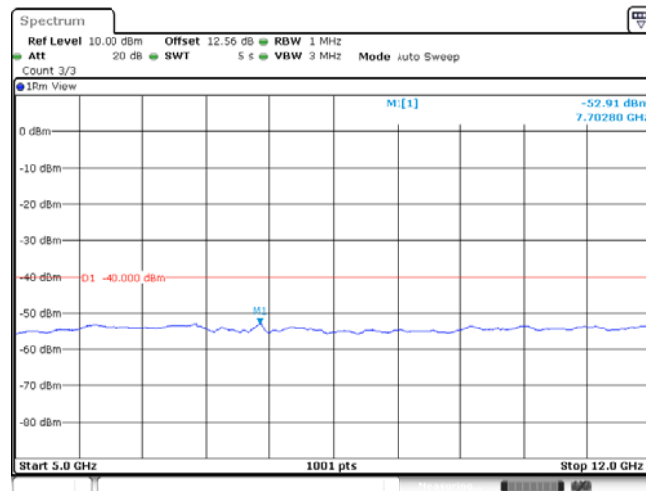

Date: 4.MAR.2019 22:37:54

Band40_5MHz_QPSK_39200_25RB#0

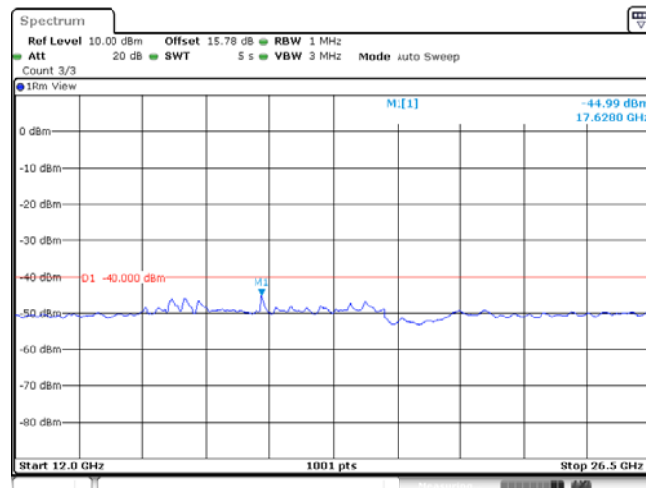

Date: 4.MAR.2019 22:38:19

Band40_5MHz_QPSK_39225_25RB#0

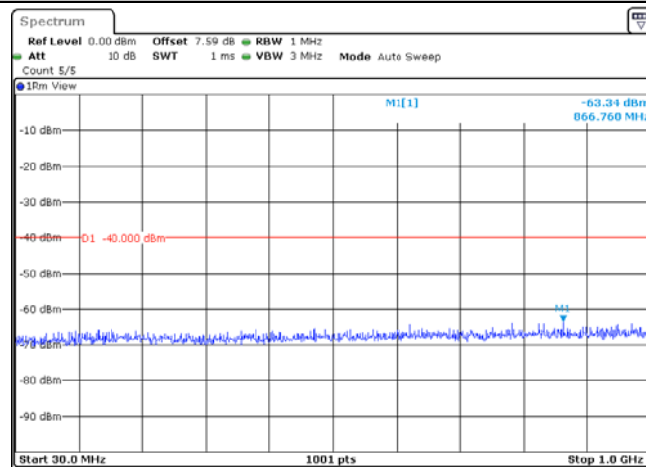

Date: 4.MAR.2019 22:40:00

Band40_5MHz_QPSK_39225_25RB#0

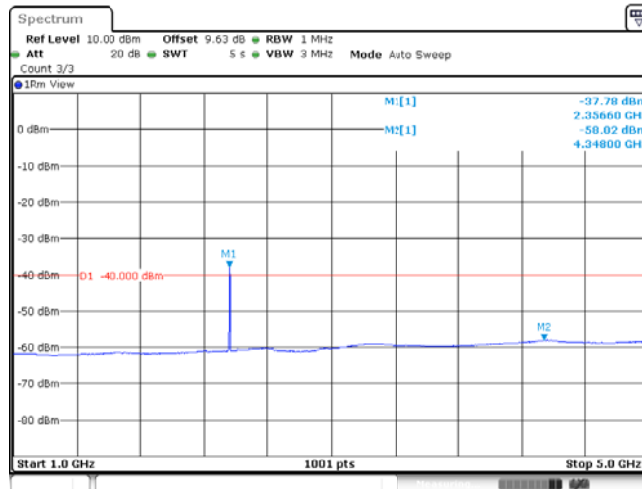

Date: 4.MAR.2019 22:40:26

Band40_5MHz_QPSK_39225_25RB#0

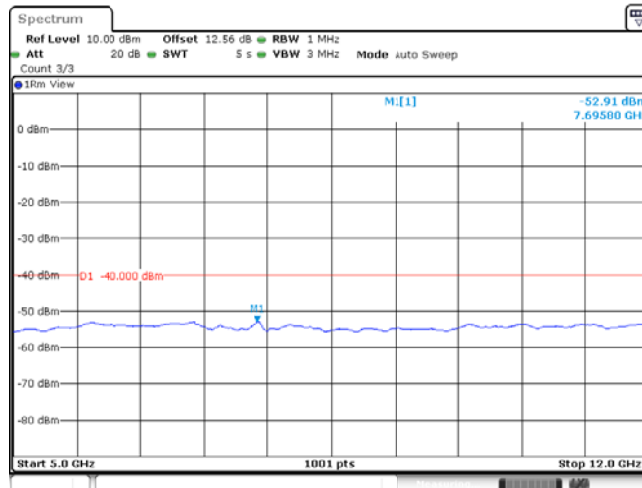

Date: 4.MAR.2019 22:40:52

Band40_5MHz_QPSK_39225_25RB#0

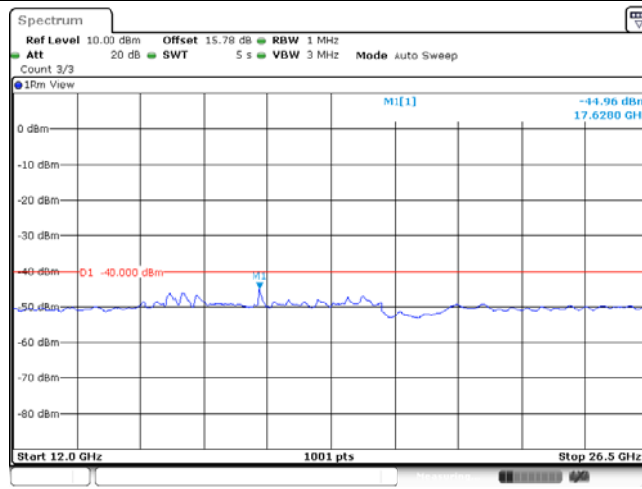

Date: 4.MAR.2019 22:41:17

Band40_5MHz_16QAM_38725_25RB#0

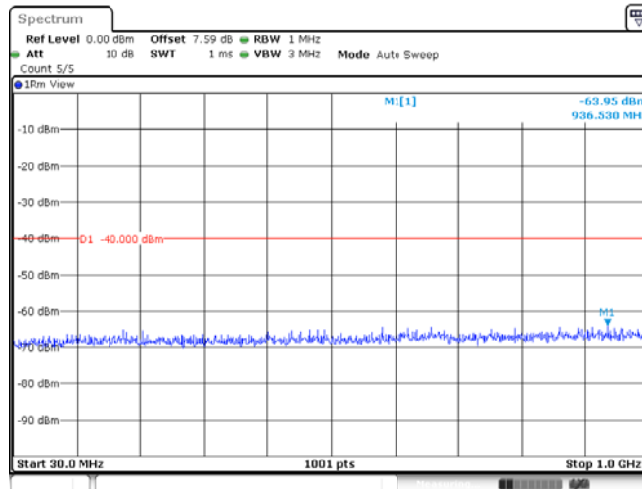

Date: 4.MAR.2019 22:13:49

Band40_5MHz_16QAM_38725_25RB#0

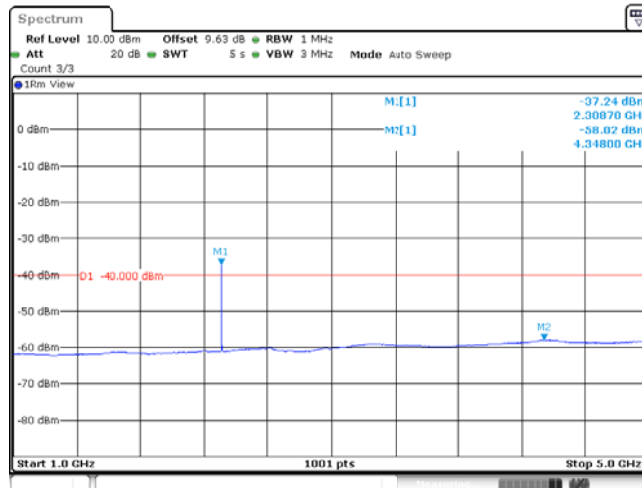

Date: 4.MAR.2019 22:14:15

Band40_5MHz_16QAM_38725_25RB#0

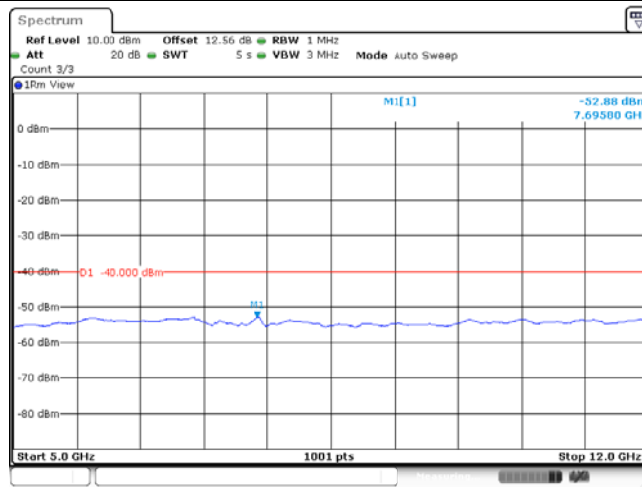

Date: 4.MAR.2019 22:14:40

Band40_5MHz_16QAM_38725_25RB#0

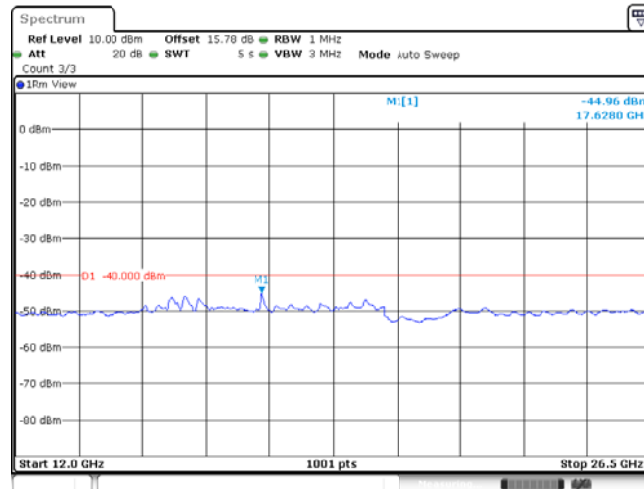

Date: 4.MAR.2019 22:15:06

Band40_5MHz_16QAM_38750_25RB#0

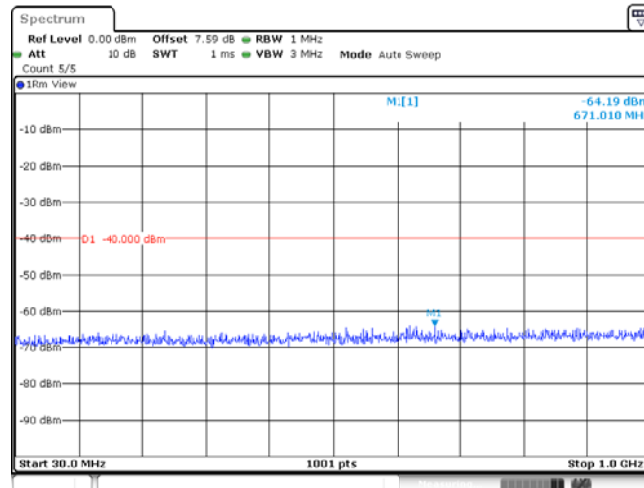

Date: 4.MAR.2019 22:16:47

Band40_5MHz_16QAM_38750_25RB#0

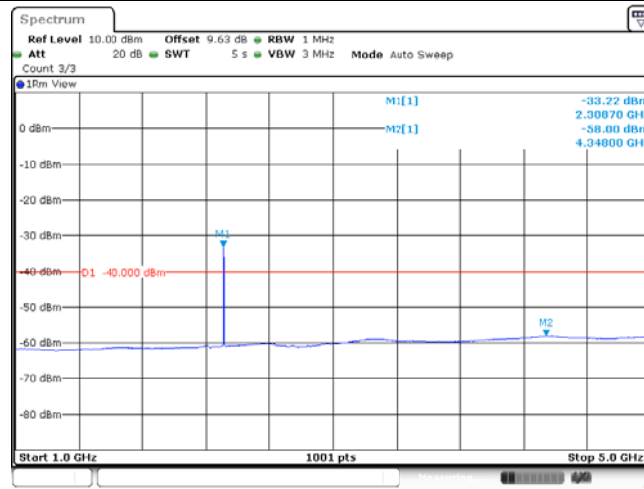

Date: 4.MAR.2019 22:17:13

Band40_5MHz_16QAM_38750_25RB#0

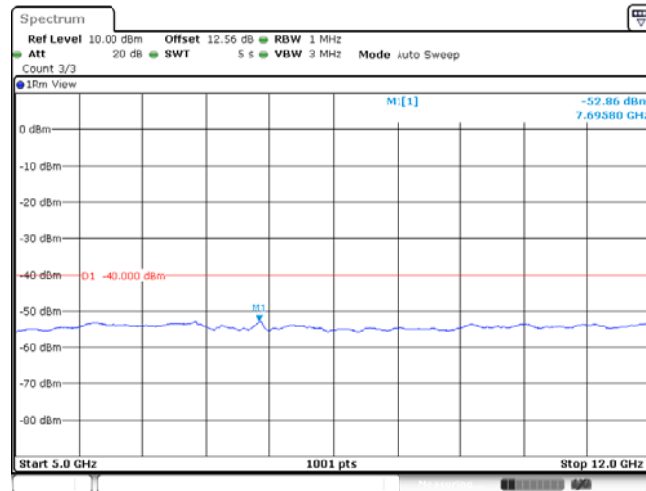

Date: 4.MAR.2019 22:17:38

Band40_5MHz_16QAM_38750_25RB#0

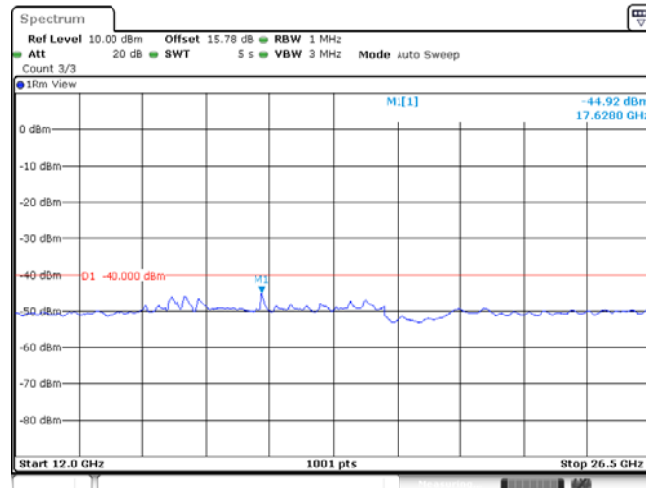

Date: 4.MAR.2019 22:18:04

Band40_5MHz_16QAM_38775_25RB#0

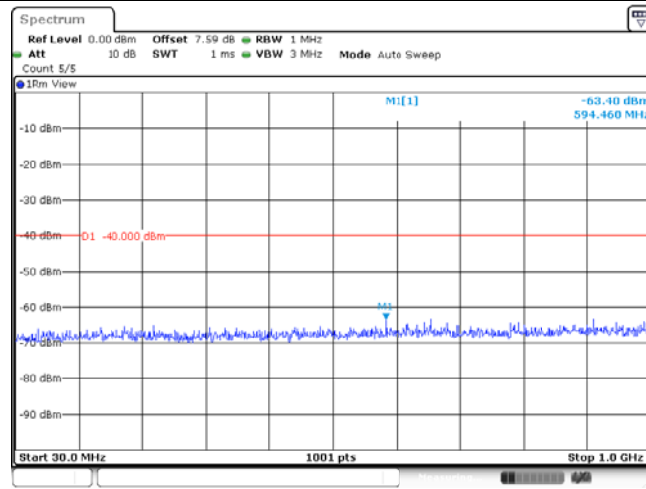

Date: 4.MAR.2019 22:19:46

Band40_5MHz_16QAM_38775_25RB#0

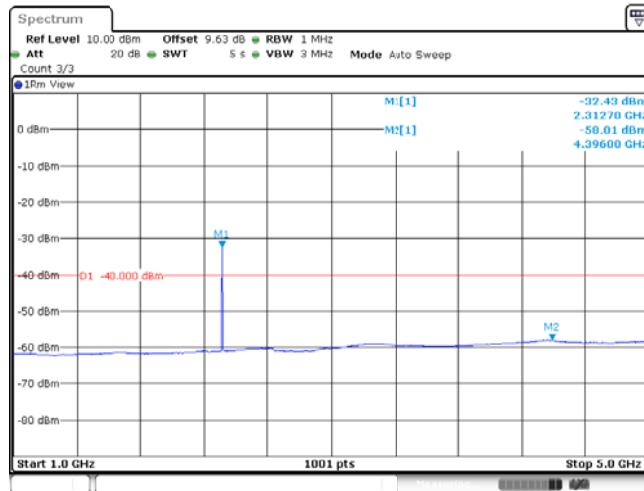

Date: 4.MAR.2019 22:20:11

Band40_5MHz_16QAM_38775_25RB#0

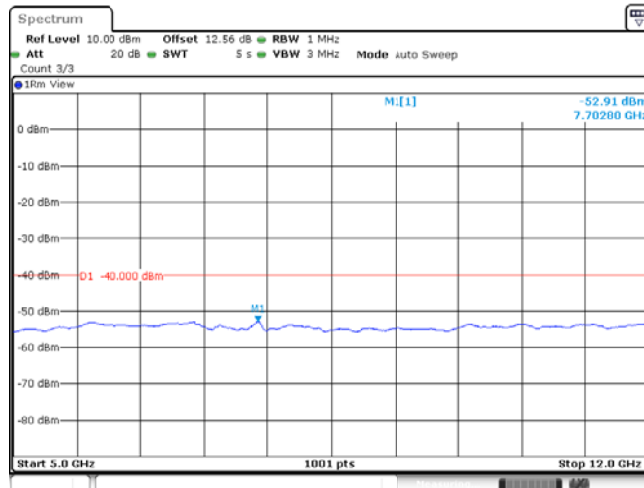

Date: 4.MAR.2019 22:20:37

Band40_5MHz_16QAM_38775_25RB#0

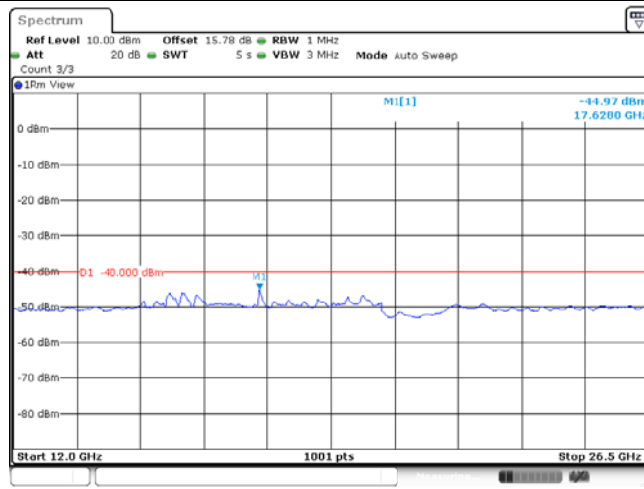

Date: 4.MAR.2019 22:21:02

Band40_5MHz_16QAM_39175_25RB#0

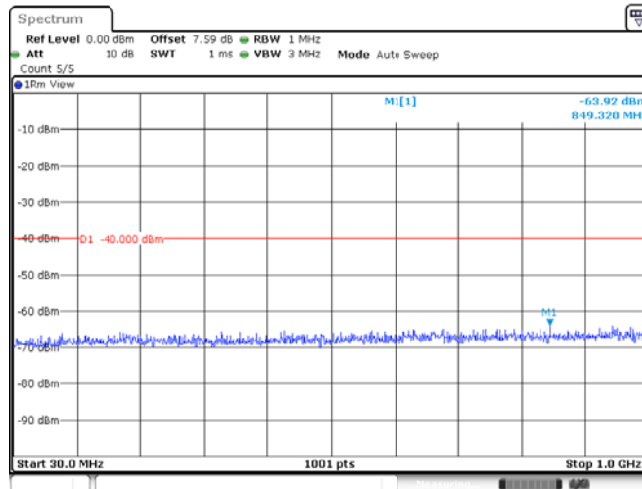

Date: 4.MAR.2019 22:35:34

Band40_5MHz_16QAM_39175_25RB#0

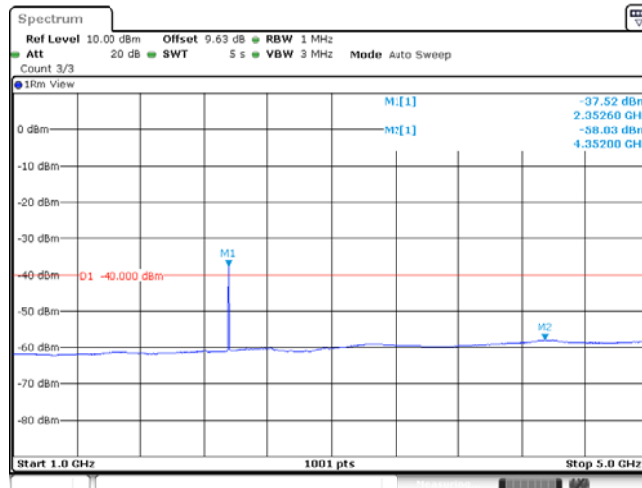

Date: 4.MAR.2019 22:36:00

Band40_5MHz_16QAM_39175_25RB#0

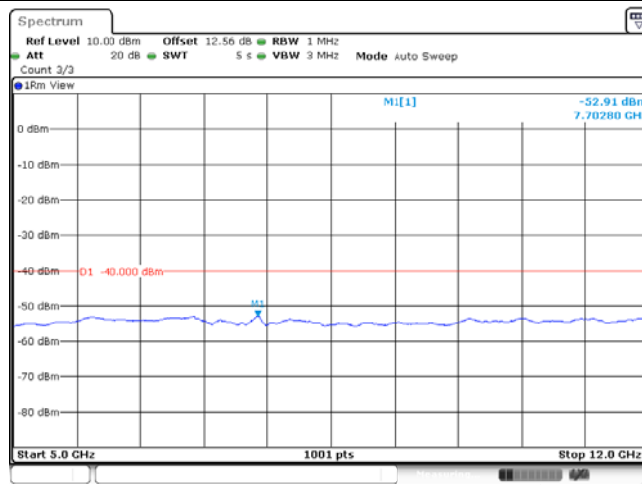

Date: 4.MAR.2019 22:36:25

Band40_5MHz_16QAM_39175_25RB#0

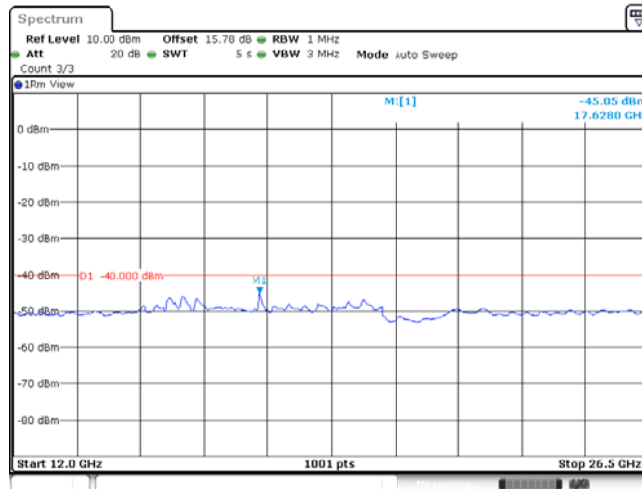

Date: 4.MAR.2019 22:36:50

Band40_5MHz_16QAM_39200_25RB#0

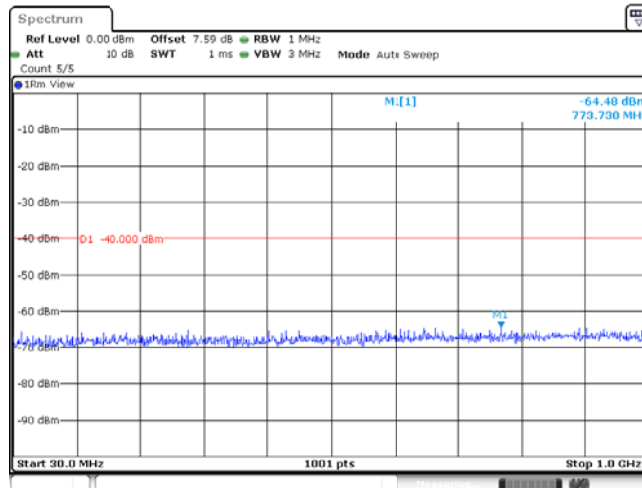

Date: 4.MAR.2019 22:38:31

Band40_5MHz_16QAM_39200_25RB#0

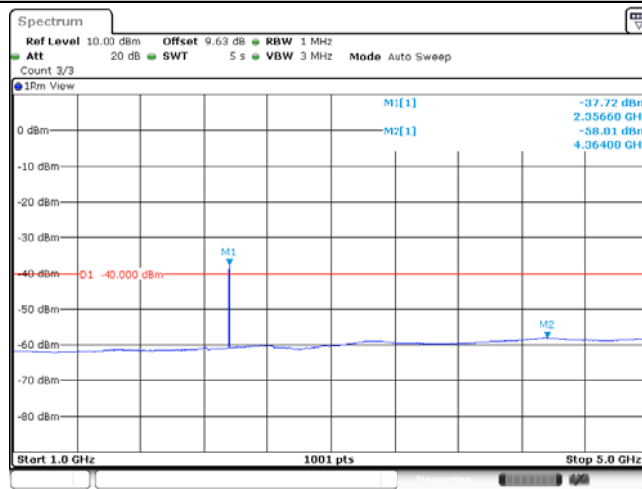

Date: 4.MAR.2019 22:38:57

Band40_5MHz_16QAM_39200_25RB#0

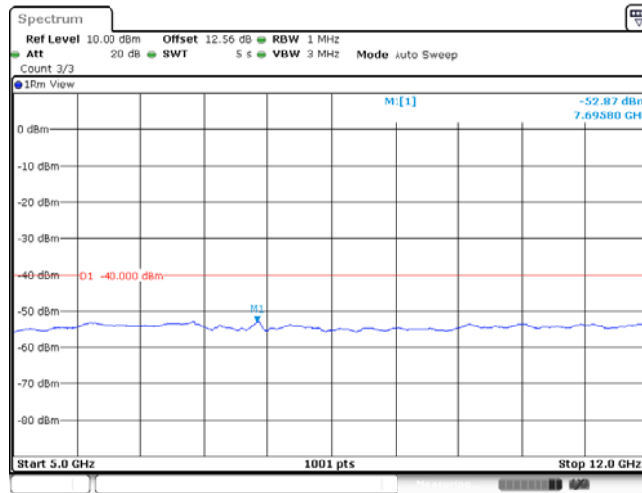

Date: 4.MAR.2019 22:39:23

Band40_5MHz_16QAM_39200_25RB#0

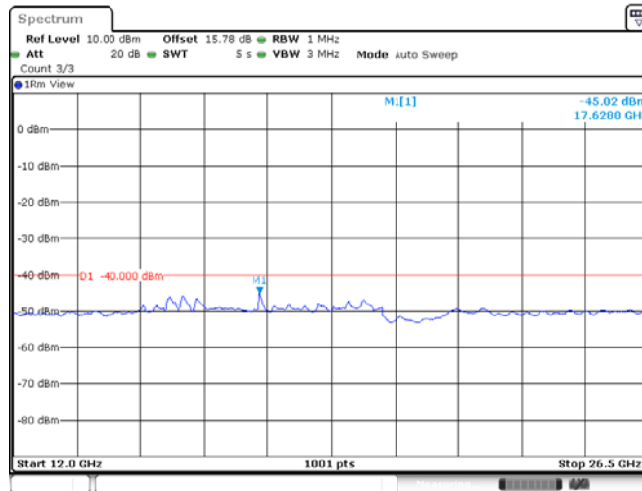

Date: 4.MAR.2019 22:39:48

Band40_5MHz_16QAM_39225_25RB#0

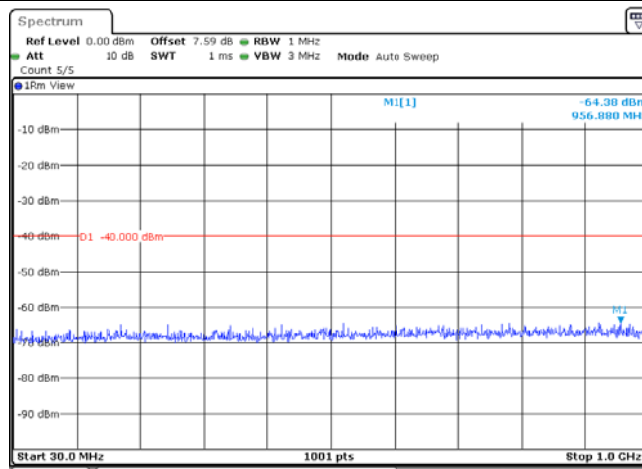

Date: 4.MAR.2019 22:41:29

Band40_5MHz_16QAM_39225_25RB#0

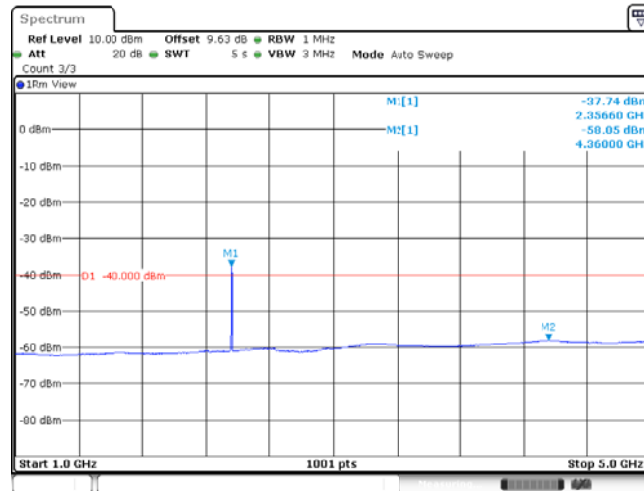

Date: 4.MAR.2019 22:41:55

Band40_5MHz_16QAM_39225_25RB#0

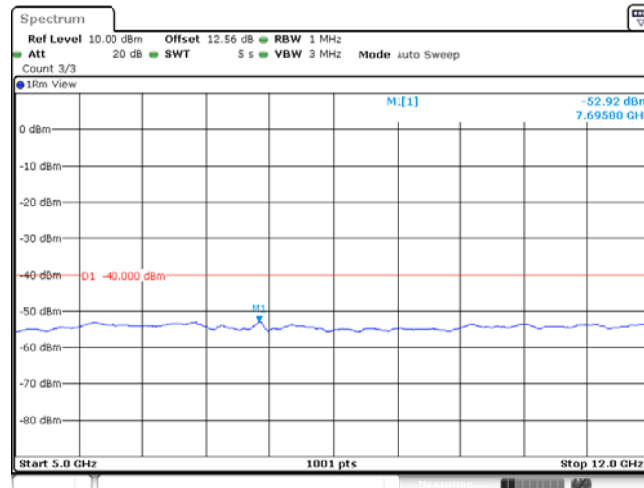

Date: 4.MAR.2019 22:42:21

Band40_5MHz_16QAM_39225_25RB#0

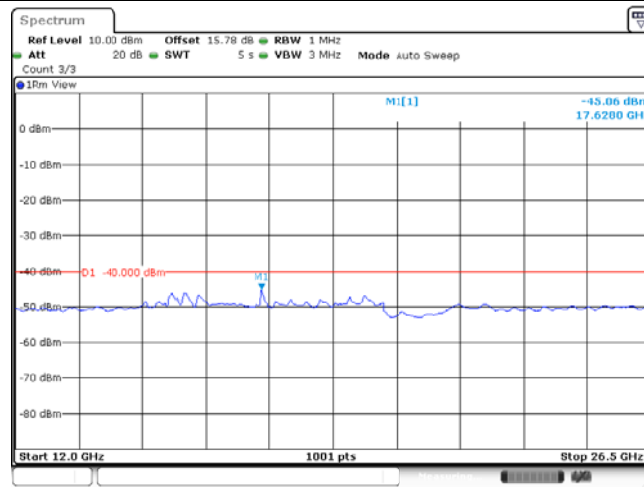

Date: 4.MAR.2019 22:42:46

Band40_10MHz_QPSK_38750_50RB#0

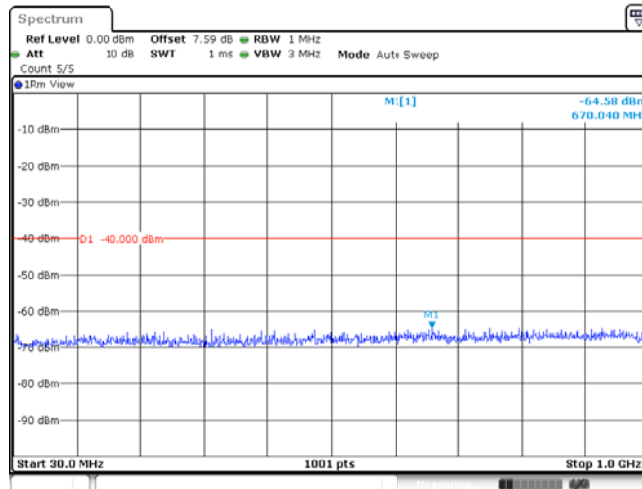

Date: 4.MAR.2019 22:23:07

Band40_10MHz_QPSK_38750_50RB#0

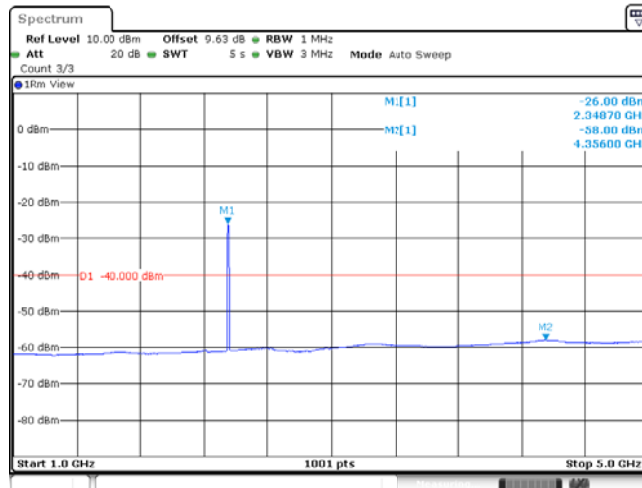

Date: 4.MAR.2019 22:23:33

Band40_10MHz_QPSK_38750_50RB#0

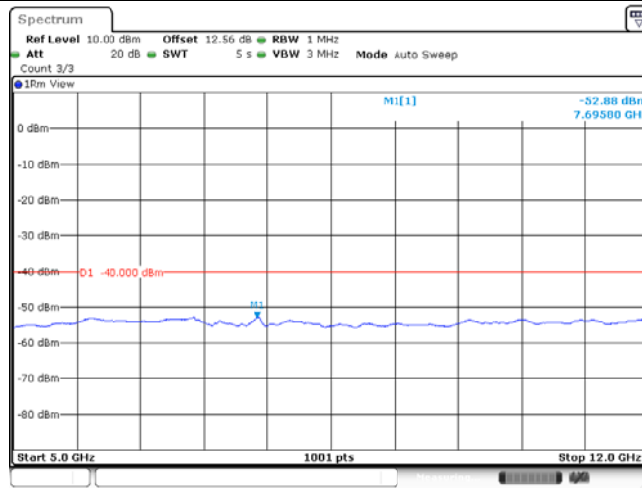

Date: 4.MAR.2019 22:23:58

Band40_10MHz_QPSK_38750_50RB#0

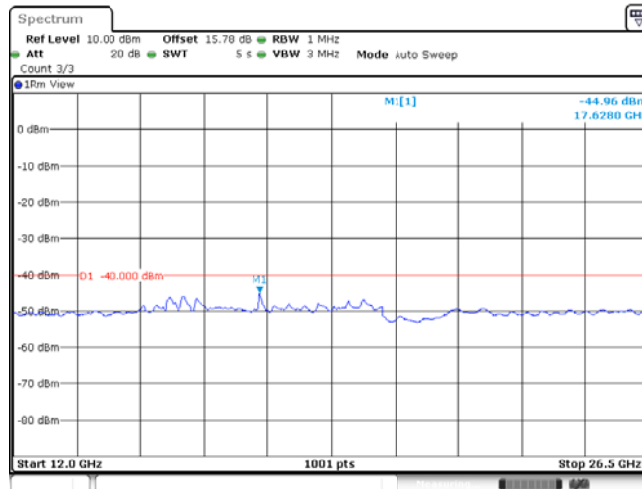

Date: 4.MAR.2019 22:24:23

Band40_10MHz_QPSK_39200_50RB#0

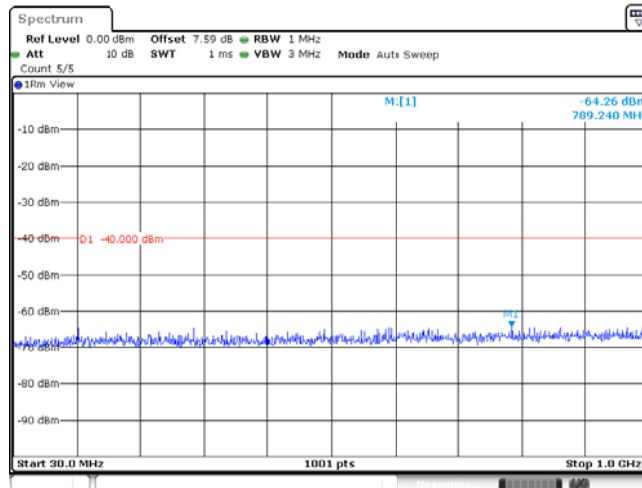

Date: 4.MAR.2019 22:43:03

Band40_10MHz_QPSK_39200_50RB#0

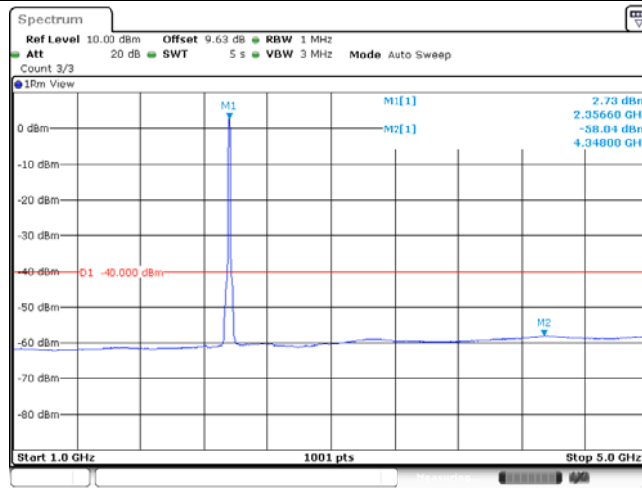

Date: 4.MAR.2019 22:43:29

Band40_10MHz_QPSK_39200_50RB#0

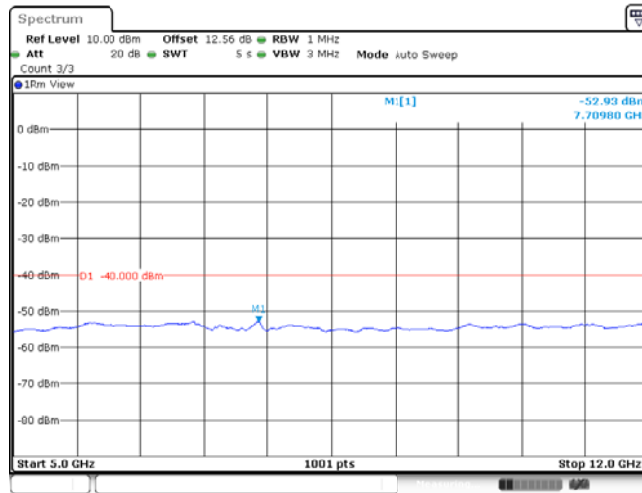

Date: 4.MAR.2019 22:43:55

Band40_10MHz_QPSK_39200_50RB#0

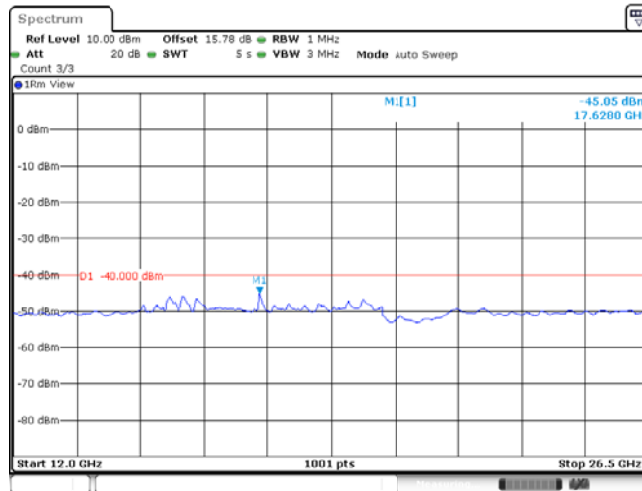

Date: 4.MAR.2019 22:44:20

Band40_10MHz_16QAM_38750_50RB#0

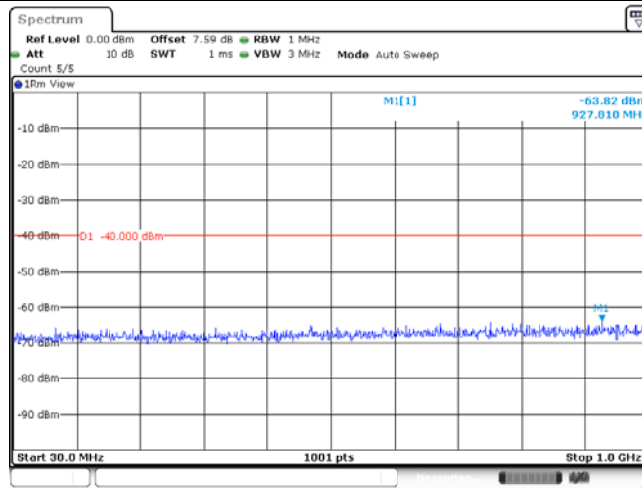

Date: 4.MAR.2019 22:24:36

Band40_10MHz_16QAM_38750_50RB#0

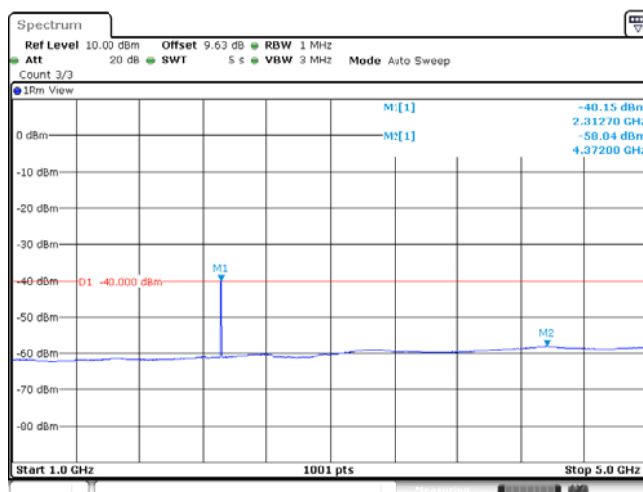

Date: 4.MAR.2019 22:25:02

Band40_10MHz_16QAM_38750_50RB#0

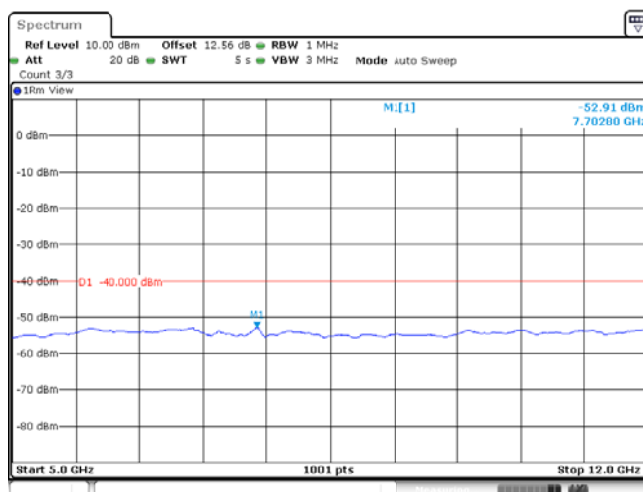

Date: 4.MAR.2019 22:25:27

Band40_10MHz_16QAM_38750_50RB#0

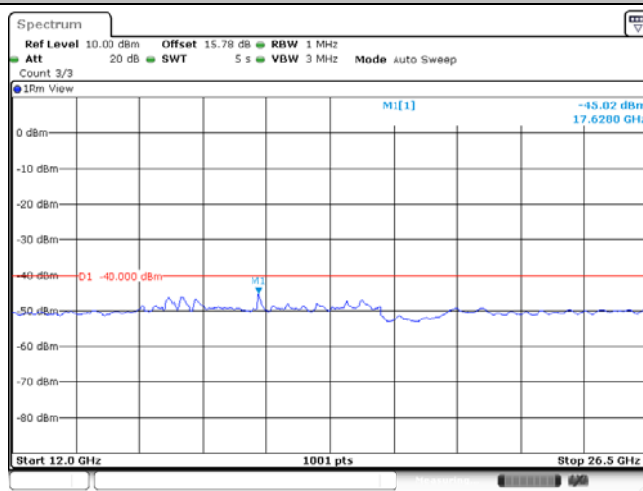

Date: 4.MAR.2019 22:25:53

Band40_10MHz_16QAM_39200_50RB#0

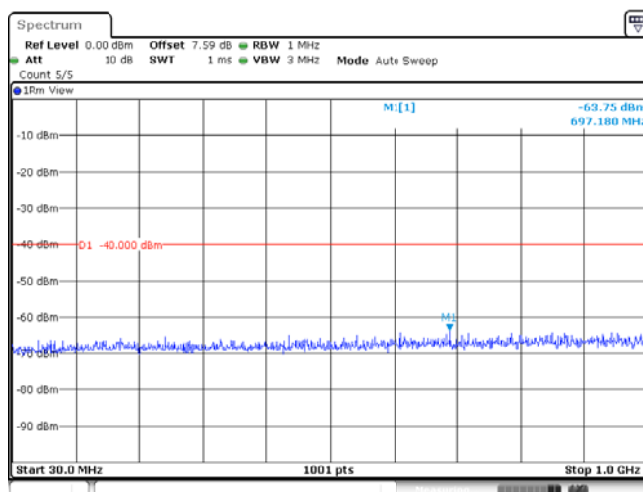

Date: 4.MAR.2019 22:44:32

Band40_10MHz_16QAM_39200_50RB#0

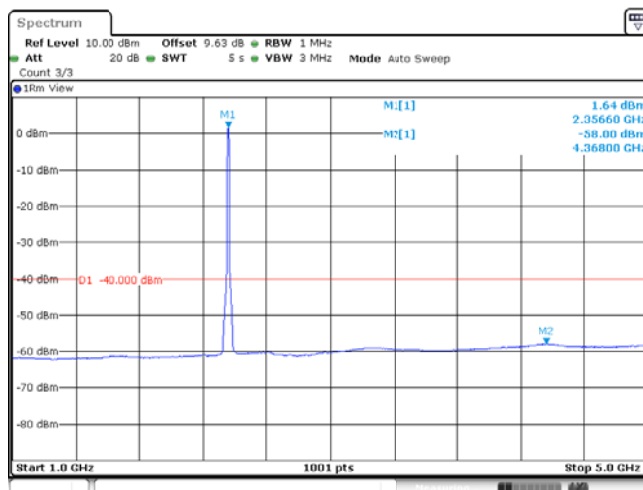

Date: 4.MAR.2019 22:44:58

Band40_10MHz_16QAM_39200_50RB#0

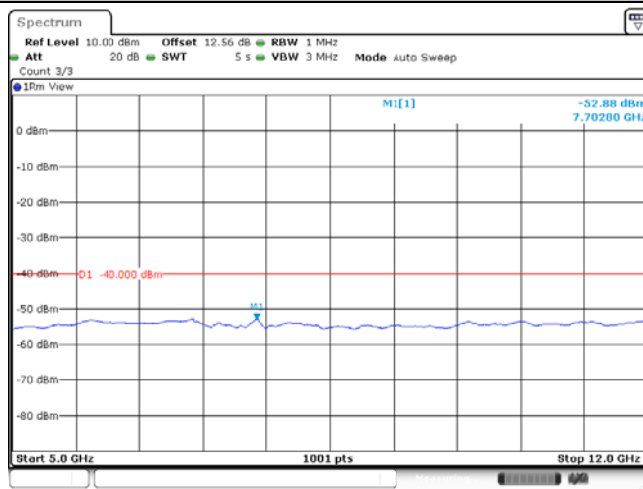

Date: 4.MAR.2019 22:45:23

Band40_10MHz_16QAM_39200_50RB#0

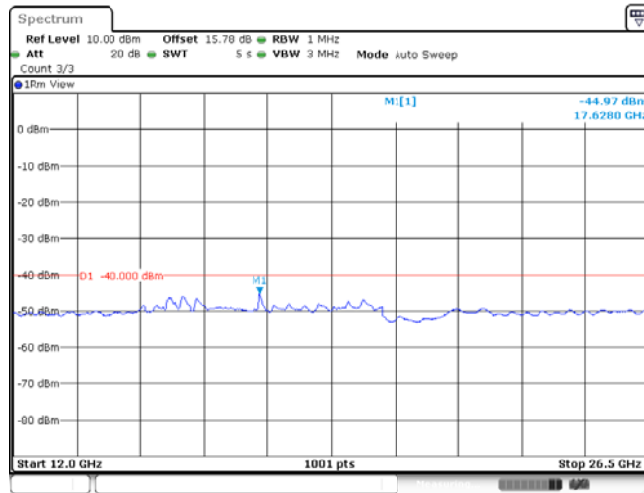

Date: 4.MAR.2019 22:45:48

Frequency Stability

Voltage										
Band	Bandwidth	Modulation	Channel	RB Configure	Voltage [Vdc]	Temperature (°C)	Deviation (Hz)	Deviation (ppm)	Limit (ppm)	Verdict
Band40	5MHz	QPSK	38725	25RB#0	VL	NT	-37.21	-0.016126	±2.5	PASS
Band40	5MHz	QPSK	38725	25RB#0	VN	NT	-59.22	-0.025664	±2.5	PASS
Band40	5MHz	QPSK	38725	25RB#0	VH	NT	-23.47	-0.010171	±2.5	PASS
Band40	5MHz	QPSK	38750	25RB#0	VL	NT	-43.26	-0.018727	±2.5	PASS
Band40	5MHz	QPSK	38750	25RB#0	VN	NT	-39.78	-0.017221	±2.5	PASS
Band40	5MHz	QPSK	38750	25RB#0	VH	NT	-43.27	-0.018732	±2.5	PASS
Band40	5MHz	QPSK	38775	25RB#0	VL	NT	-41.06	-0.017756	±2.5	PASS
Band40	5MHz	QPSK	38775	25RB#0	VN	NT	-50.35	-0.021773	±2.5	PASS
Band40	5MHz	QPSK	38775	25RB#0	VH	NT	-39.91	-0.017258	±2.5	PASS
Band40	5MHz	QPSK	39175	25RB#0	VL	NT	-34.22	-0.014546	±2.5	PASS
Band40	5MHz	QPSK	39175	25RB#0	VN	NT	-34.45	-0.014644	±2.5	PASS
Band40	5MHz	QPSK	39175	25RB#0	VH	NT	-47.25	-0.020085	±2.5	PASS
Band40	5MHz	QPSK	39200	25RB#0	VL	NT	-44.55	-0.018917	±2.5	PASS
Band40	5MHz	QPSK	39200	25RB#0	VN	NT	-34.02	-0.014446	±2.5	PASS
Band40	5MHz	QPSK	39200	25RB#0	VH	NT	-36.89	-0.015665	±2.5	PASS
Band40	5MHz	QPSK	39225	25RB#0	VL	NT	-32.94	-0.013972	±2.5	PASS
Band40	5MHz	QPSK	39225	25RB#0	VN	NT	-51.71	-0.021934	±2.5	PASS
Band40	5MHz	QPSK	39225	25RB#0	VH	NT	-32.16	-0.013642	±2.5	PASS
Band40	5MHz	16QAM	38725	25RB#0	VL	NT	-26.54	-0.011502	±2.5	PASS
Band40	5MHz	16QAM	38725	25RB#0	VN	NT	-12.33	-0.005343	±2.5	PASS
Band40	5MHz	16QAM	38725	25RB#0	VH	NT	-33.39	-0.014470	±2.5	PASS
Band40	5MHz	16QAM	38750	25RB#0	VL	NT	-26.28	-0.011377	±2.5	PASS
Band40	5MHz	16QAM	38750	25RB#0	VN	NT	-26.26	-0.011368	±2.5	PASS
Band40	5MHz	16QAM	38750	25RB#0	VH	NT	-28.75	-0.012446	±2.5	PASS
Band40	5MHz	16QAM	38775	25RB#0	VL	NT	-32.52	-0.014063	±2.5	PASS
Band40	5MHz	16QAM	38775	25RB#0	VN	NT	-25.73	-0.011126	±2.5	PASS
Band40	5MHz	16QAM	38775	25RB#0	VH	NT	-30.50	-0.013189	±2.5	PASS
Band40	5MHz	16QAM	39175	25RB#0	VL	NT	-34.59	-0.014704	±2.5	PASS
Band40	5MHz	16QAM	39175	25RB#0	VN	NT	-32.40	-0.013773	±2.5	PASS
Band40	5MHz	16QAM	39175	25RB#0	VH	NT	-44.66	-0.018984	±2.5	PASS
Band40	5MHz	16QAM	39200	25RB#0	VL	NT	-33.07	-0.014042	±2.5	PASS
Band40	5MHz	16QAM	39200	25RB#0	VN	NT	-17.18	-0.007295	±2.5	PASS
Band40	5MHz	16QAM	39200	25RB#0	VH	NT	-36.15	-0.015350	±2.5	PASS
Band40	5MHz	16QAM	39225	25RB#0	VL	NT	-38.47	-0.016318	±2.5	PASS
Band40	5MHz	16QAM	39225	25RB#0	VN	NT	-36.96	-0.015678	±2.5	PASS
Band40	5MHz	16QAM	39225	25RB#0	VH	NT	-35.81	-0.015190	±2.5	PASS
Band40	10MHz	QPSK	38750	50RB#0	VL	NT	-40.87	-0.017693	±2.5	PASS
Band40	10MHz	QPSK	38750	50RB#0	VN	NT	-39.41	-0.017061	±2.5	PASS
Band40	10MHz	QPSK	38750	50RB#0	VH	NT	-38.38	-0.016615	±2.5	PASS
Band40	10MHz	16QAM	38750	50RB#0	VL	NT	-31.41	-0.013597	±2.5	PASS
Band40	10MHz	16QAM	38750	50RB#0	VN	NT	-18.30	-0.007922	±2.5	PASS
Band40	10MHz	16QAM	38750	50RB#0	VH	NT	-29.70	-0.012857	±2.5	PASS

Appendix B: Test Results of Radiated Test

LTE Band 40 5MHz Bandwidth									
Channel	Frequency (MHz)	ERP (dBm)	Limit (dBm)	Over Limit (dB)	SPA Reading (dBm)	S.G. Power (dBm)	TX Cable loss (dB)	TX Antenna Gain (dBi)	Polarization (H/V)
Lowest	4615	-52.84	-40	-12.84	-68.71	-60.31	5.23	12.70	H
	6922.5	-45.82	-40	-5.82	-69.59	-50.60	6.92	11.70	H
	9230	-44.08	-40	-4.08	-71.17	-48.15	7.83	11.90	H
	4615	-53.39	-40	-13.39	-68.85	-60.86	5.23	12.70	V
	6922.5	-45.44	-40	-5.44	-68.56	-50.22	6.92	11.70	V
	9230	-44.35	-40	-4.35	-71.43	-48.42	7.83	11.90	V
Middle	4620	-52.55	-40	-12.55	-68.43	-60.02	5.23	12.70	H
	6930	-45.52	-40	-5.52	-69.31	-50.30	6.92	11.70	H
	9240	-43.10	-40	-3.10	-70.21	-47.17	7.83	11.90	H
	4620	-52.97	-40	-12.97	-68.43	-60.44	5.23	12.70	V
	6930	-46.31	-40	-6.31	-69.46	-51.09	6.92	11.70	V
	9240	-43.46	-40	-3.46	-70.56	-47.53	7.83	11.90	V
Highest	4625	-58.16	-40	-18.16	-71.04	-65.63	5.23	12.70	H
	6937.5	-50.82	-40	-10.82	-71.64	-55.60	6.92	11.70	H
	9250	-48.74	-40	-8.74	-72.87	-52.81	7.83	11.90	H
	4625	-57.72	-40	-17.72	-70.19	-65.19	5.23	12.70	V
	6937.5	-51.40	-40	-11.40	-71.59	-56.18	6.92	11.70	V
	9250	-48.83	-40	-8.83	-72.94	-52.90	7.83	11.90	V

Remark: Spurious emissions within 30-1000MHz were found more than 20dB below limit line.

LTE Band 41 10MHz Bandwidth									
Channel	Frequency (MHz)	EIRP (dBm)	Limit (dBm)	Over Limit (dB)	SPA Reading (dBm)	S.G. Power (dBm)	TX Cable loss (dB)	TX Antenna Gain (dBi)	Polarization (H/V)
Middle	4620	-52.43	-40	-12.43	-68.31	-59.90	5.23	12.70	H
	6930	-45.33	-40	-5.33	-69.12	-50.11	6.92	11.70	H
	9240	-43.11	-40	-3.11	-70.22	-47.18	7.83	11.90	H
	4620	-52.80	-40	-12.80	-68.26	-60.27	5.23	12.70	V
	6930	-46.47	-40	-6.47	-69.62	-51.25	6.92	11.70	V
	9240	-42.79	-40	-2.79	-69.89	-46.86	7.83	11.90	V

Remark: Spurious emissions within 30-1000MHz were found more than 20dB below limit line.

LTE Band 40 5MHz Bandwidth									
Channel	Frequency (MHz)	ERP (dBm)	Limit (dBm)	Over Limit (dB)	SPA Reading (dBm)	S.G. Power (dBm)	TX Cable loss (dB)	TX Antenna Gain (dBi)	Polarization (H/V)
Lowest	4705	-57.75	-40	-17.75	-68.65	-65.13	5.32	12.70	H
	7057.5	-56.37	-40	-16.37	-70.57	-61.13	6.94	11.70	H
	9410	-51.12	-40	-11.12	-70.63	-55.00	8.02	11.90	H
	4705	-58.29	-40	-18.29	-68.78	-65.67	5.32	12.70	V
	7057.5	-55.41	-40	-15.41	-70.06	-60.17	6.94	11.70	V
	9410	-53.75	-40	-13.75	-70.16	-57.63	8.02	11.90	V
Middle	4710	-58.31	-40	-18.31	-69.80	-65.69	5.32	12.70	H
	7065	-56.56	-40	-16.56	-69.24	-61.32	6.94	11.70	H
	9420	-54.95	-40	-14.95	-68.38	-58.83	8.02	11.90	H
	4710	-59.15	-40	-19.15	-68.05	-66.53	5.32	12.70	V
	7065	-57.08	-40	-17.08	-69.3	-61.84	6.94	11.70	V
	9420	-55.22	-40	-15.22	-68.75	-59.10	8.02	11.90	V
Highest	4715	-62.85	-40	-22.85	-67.75	-70.23	5.32	12.70	H
	7072.5	-56.36	-40	-16.36	-69.60	-61.12	6.94	11.70	H
	9430	-52.64	-40	-12.64	-69.20	-56.52	8.02	11.90	H
	4715	-63.13	-40	-23.13	-67.62	-70.51	5.32	12.70	V
	7072.5	-56.65	-40	-16.65	-69.36	-61.41	6.94	11.70	V
	9430	-52.59	-40	-12.59	-69.04	-56.47	8.02	11.90	V

Remark: Spurious emissions within 30-1000MHz were found more than 20dB below limit line.

LTE Band 41 10MHz Bandwidth									
Channel	Frequency (MHz)	EIRP (dBm)	Limit (dBm)	Over Limit (dB)	SPA Reading (dBm)	S.G. Power (dBm)	TX Cable loss (dB)	TX Antenna Gain (dBi)	Polarization (H/V)
Middle	4710	-62.74	-40	-22.74	-70.64	-70.12	5.32	12.70	H
	7065	-55.81	-40	-15.81	-72.03	-60.57	6.94	11.70	H
	9420	-52.16	-40	-12.16	-71.69	-56.04	8.02	11.90	H
	4710	-63.53	-40	-23.53	-71.02	-70.91	5.32	12.70	V
	7065	-60.63	-40	-20.63	-72.31	-65.39	6.94	11.70	V
	9420	-55.69	-40	-15.69	-71.12	-59.57	8.02	11.90	V

Remark: Spurious emissions within 30-1000MHz were found more than 20dB below limit line.

-----End of the report-----