



FCC RF Test Report

APPLICANT : Mikrotiks SIA
EQUIPMENT : R11e-LTE-US
BRAND NAME : MikroTik
MODEL NAME : R11e-LTE-US
FCC ID : TV7R11ELTE
STANDARD : FCC 47 CFR Part 2, 22(H), 24(E)
CLASSIFICATION : PCS Licensed Transmitter (PCB)

The product was received on Jun. 16, 2017 and testing was completed on Jul. 12, 2017. We, SPORTON INTERNATIONAL INC., would like to declare that the tested sample has been evaluated in accordance with the test procedures given in ANSI / TIA / EIA-603-E-2016 and has been in compliance with the applicable technical standards.

The test results in this report apply exclusively to the tested model / sample. Without written approval of SPORTON INTERNATIONAL INC., the test report shall not be reproduced except in full.

Reviewed by: Joseph Lin / Supervisor

Approved by: Jones Tsai / Manager



SPORTON INTERNATIONAL INC.

No. 52, Hwa Ya 1st Rd., Hwa Ya Technology Park, Kwei-Shan District, Tao Yuan City, Taiwan, R.O.C.

SPORTON INTERNATIONAL INC.

TEL : 886-3-327-3456

FAX : 886-3-328-4978

FCC ID : TV7R11ELTE

Page Number : 1 of 19

Report Issued Date : Sep. 26, 2017

Report Version : Rev. 01

Report Template No.: BU5-FG22/24/27 Version 2.0



TABLE OF CONTENTS

REVISION HISTORY..... 3

SUMMARY OF TEST RESULT 4

1 GENERAL DESCRIPTION 5

 1.1 Applicant..... 5

 1.2 Manufacturer 5

 1.3 Product Feature of Equipment Under Test 5

 1.4 Modification of EUT 5

 1.5 Testing Location 6

 1.6 Applicable Standards 6

2 TEST CONFIGURATION OF EQUIPMENT UNDER TEST 7

 2.1 Test Mode..... 7

 2.2 Connection Diagram of Test System 7

 2.3 Support Unit used in test configuration 8

 2.4 Measurement Results Explanation Example 8

 2.5 Frequency List of Low/Middle/High Channels..... 8

3 CONDUCTED TEST RESULT..... 9

 3.1 Measuring Instruments..... 9

 3.2 Test Setup 9

 3.3 Test Result of Conducted Test..... 9

 3.4 Conducted Output Power and ERP/EIRP 10

 3.5 Peak-to-Average Ratio 11

 3.6 99% Occupied Bandwidth and 26dB Bandwidth Measurement..... 12

 3.7 Conducted Band Edge 13

 3.8 Conducted Spurious Emission 14

 3.9 Frequency Stability..... 15

4 RADIATED TEST ITEMS 16

 4.1 Measuring Instruments..... 16

 4.2 Test Setup 16

 4.3 Test Result of Radiated Test..... 16

 4.4 Field Strength of Spurious Radiation Measurement 17

5 LIST OF MEASURING EQUIPMENT 18

6 UNCERTAINTY OF EVALUATION 19

APPENDIX A. TEST RESULTS OF CONDUCTED TEST

APPENDIX B. TEST RESULTS OF RADIATED TEST

APPENDIX C. TEST SETUP PHOTOGRAPHS



REVISION HISTORY

REPORT NO.	VERSION	DESCRIPTION	ISSUED DATE
FG761625	Rev. 01	Initial issue of report	Sep. 26, 2017



SUMMARY OF TEST RESULT

Report Section	FCC Rule	Description	Limit	Result	Remark
3.4	§2.1046	Conducted Output Power	Reporting Only	PASS	-
	§22.913(a)(2)	Effective Radiated Power	< 7 Watts	PASS	-
	§24.232(c)	Equivalent Isotropic Radiated Power	< 2 Watts	PASS	-
3.5	§24.232(d)	Peak-to-Average Ratio	< 13 dB	PASS	-
3.6	§2.1049 §22.917(b) §24.238(b)	Occupied Bandwidth	Reporting Only	PASS	-
3.7	§2.1051 §22.917(a) §24.238(a)	Band Edge Measurement	< 43+10log10(P[Watts])	PASS	-
3.8	§2.1051 §22.917(a) §24.238(a)	Conducted Emission	< 43+10log10(P[Watts])	PASS	-
3.9	§2.1055 §22.355	Frequency Stability for Temperature & Voltage	< 2.5 ppm for Part 22	PASS	-
	§2.1055 §24.235		Within Authorized Band		
4.4	§2.1053 §22.917(a) §24.238(a)	Field Strength of Spurious Radiation	< 43+10log10(P[Watts])	PASS	Under limit 34.39 dB at 5555.000 MHz



1 General Description

1.1 Applicant

Mikrotikls SIA
Pernavas 46 street

1.2 Manufacturer

Mikrotikls SIA
Pernavas 46 street

1.3 Product Feature of Equipment Under Test

WCDMA/LTE

Product Specification subjective to this standard	
Antenna Type	WWAN: Fixed External Antenna

1.4 Modification of EUT

No modifications are made to the EUT during all test items.

1.5 Testing Location

Sporton Lab is accredited to ISO 17025 by Taiwan Accreditation Foundation (TAF code : 1190) and the FCC designation No. TW0007 under the FCC 2.948(e) by Mutual Recognition Agreement (MRA) in FCC Test.

Test Site	SPORTON INTERNATIONAL INC.
Test Site Location	No. 52, Hwa Ya 1 st Rd., Hwa Ya Technology Park, Kwei-Shan District, Tao Yuan City, Taiwan, R.O.C. TEL: +886-3-327-3456 FAX: +886-3-328-4978
Test Site No.	Sporton Site No.
	TH03-HY

Test Site	SPORTON INTERNATIONAL INC.
Test Site Location	No.58, Aly. 75, Ln. 564, Wenhua 3rd Rd. Guishan Dist, Taoyuan City, Taiwan (R.O.C.) TEL: +886-3-327-0868 FAX: +886-3-327-0855
Test Site No.	Sporton Site No.
	03CH12-HY

1.6 Applicable Standards

According to the specifications of the manufacturer, the EUT must comply with the requirements of the following standards:

- ♦ 47 CFR Part 2, 22(H), 24(E)
- ♦ ANSI / TIA / EIA-603-E-2016
- ♦ FCC KDB 971168 D01 Power Meas. License Digital Systems v02r02
- ♦ FCC KDB 412172 D01 Determining ERP and EIRP v01r01

Remark:

1. All test items were verified and recorded according to the standards and without any deviation during the test.
2. This EUT has also been tested and complied with the requirements of FCC Part 15, Subpart B, recorded in a separate test report.

2 Test Configuration of Equipment Under Test

2.1 Test Mode

Antenna port conducted and radiated test items were performed according to KDB 971168 D01 Power Meas. License Digital Systems v02r02 with maximum output power.

Radiated emissions were investigated as following frequency range:

1. 30 MHz to 9000 MHz for WCDMA Band V.
2. 30 MHz to 19100 MHz for WCDMA Band II.

All modes and data rates and positions were investigated.

Test modes are chosen to be reported as the worst case configuration below:

Test Modes		
Band	Radiated TCs	Conducted TCs
WCDMA Band V	■ RMC 12.2Kbps Link	■ RMC 12.2Kbps Link
WCDMA Band II	■ RMC 12.2Kbps Link	■ RMC 12.2Kbps Link

2.2 Connection Diagram of Test System

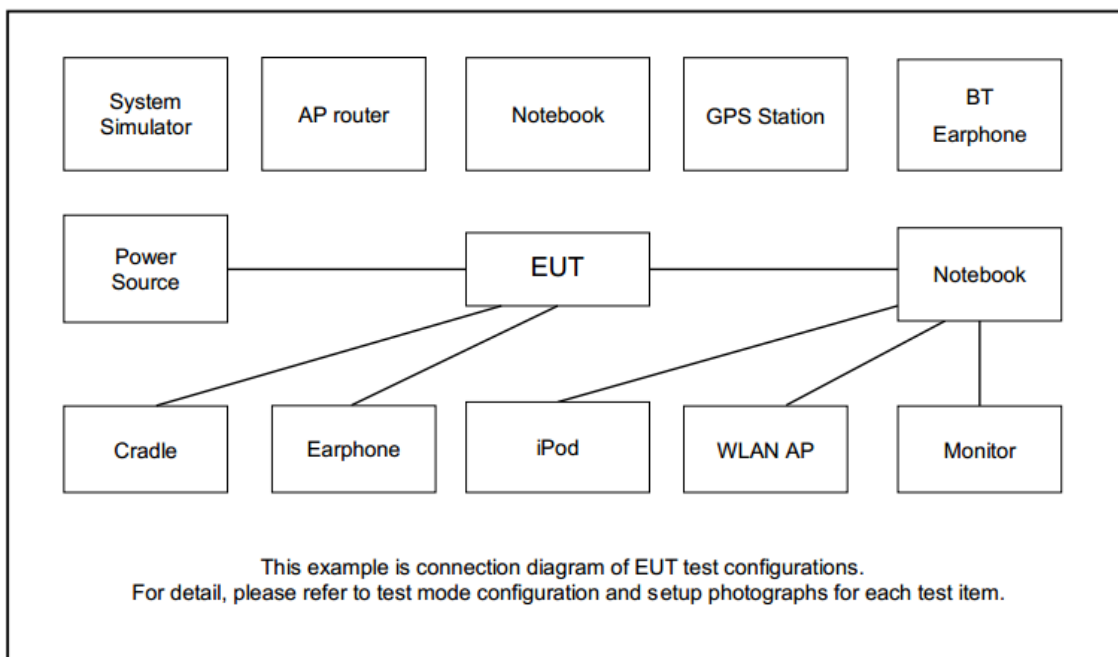



2.3 Support Unit used in test configuration

Item	Equipment	Trade Name	Model No.	FCC ID	Data Cable	Power Cord
1.	System Simulator	R&S	CMU 200	N/A	N/A	Unshielded, 1.8 m

2.4 Measurement Results Explanation Example

For all conducted test items:

The offset level is set in the spectrum analyzer to compensate the RF cable loss and attenuator factor between RF conducted output port and spectrum analyzer. With the offset compensation, the spectrum analyzer reading level will be exactly the RF output level.

The spectrum analyzer offset is derived from RF cable loss and attenuator factor.

$$\text{Offset} = \text{RF cable loss} + \text{attenuator factor}.$$

The following shows an offset computation example with RF cable loss 4.2 dB and a 10dB attenuator.

Example :

$$\begin{aligned} \text{Offset(dB)} &= \text{RF cable loss(dB)} + \text{attenuator factor(dB)}. \\ &= 4.2 + 10 = 14.2 \text{ (dB)} \end{aligned}$$

2.5 Frequency List of Low/Middle/High Channels

Frequency List				
Band	Channel/Frequency(MHz)	Lowest	Middle	Highest
WCDMA Band V	Channel	4132	4182	4233
	Frequency	826.4	836.4	846.6
WCDMA Band II	Channel	9262	9400	9538
	Frequency	1852.4	1880.0	1907.6

3 Conducted Test Result

3.1 Measuring Instruments

See list of measuring instruments of this test report.

3.2 Test Setup

3.2.1 Conducted Output Power

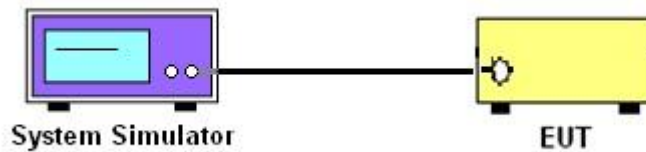

3.2.2 Peak-to-Average Ratio, Occupied Bandwidth, Conducted Band-Edge and Conducted Spurious Emission

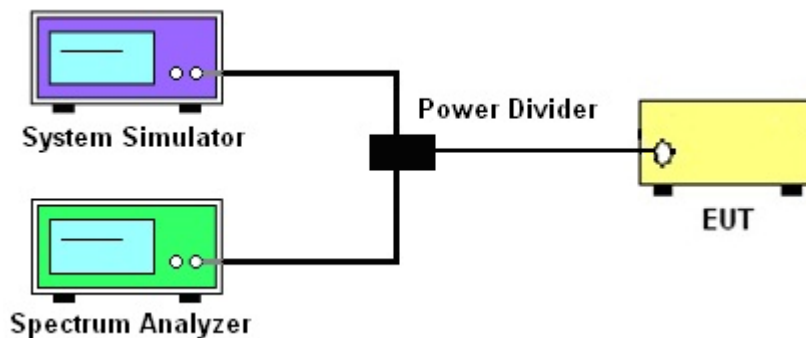

3.2.3 Frequency Stability

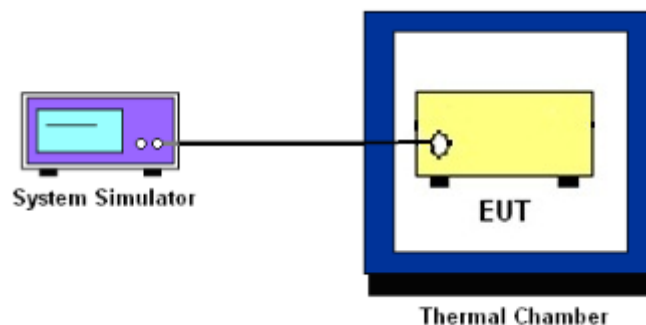

3.3 Test Result of Conducted Test

Please refer to Appendix A.



3.4 Conducted Output Power and ERP/EIRP

3.4.1 Description of the Conducted Output Power and ERP/EIRP

A system simulator was used to establish communication with the EUT. Its parameters were set to enforce EUT transmitting at the maximum power. The measured power in the radio frequency on the transmitter output terminals shall be reported.

The ERP of mobile transmitters must not exceed 7 Watts for WCDMA Band V.

The EIRP of mobile transmitters must not exceed 2 Watts for WCDMA Band II.

According to KDB 412172 D01 Power Approach,

$EIRP = P_T + G_T - L_C$, $ERP = EIRP - 2.15$, where

P_T = transmitter output power in dBm

G_T = gain of the transmitting antenna in dBi

L_C = signal attenuation in the connecting cable between the transmitter and antenna in dB

3.4.2 Test Procedures

1. The transmitter output port was connected to the system simulator.
2. Set EUT at maximum power through system simulator.
3. Select lowest, middle, and highest channels for each band and different modulation.
4. Measure the maximum burst average power for GSM and maximum average power for other modulation signal.



3.5 Peak-to-Average Ratio

3.5.1 Description of the PAR Measurement

The peak-to-average ratio (PAR) of the transmission may not exceed 13 dB.

3.5.2 Test Procedures

1. The testing follows FCC KDB 971168 D01 v02r02 Section 5.7.1.
2. The EUT was connected to spectrum analyzer and system simulator via a power divider.
3. Set EUT to transmit at maximum output power.
4. When the duty cycle is less than 98%, then signal gating will be implemented on the spectrum analyzer by triggering from the system simulator.
5. Set the CCDF (Complementary Cumulative Distribution Function) option of the spectrum analyzer.
Record the maximum PAPR level associated with a probability of 0.1%.



3.6 99% Occupied Bandwidth and 26dB Bandwidth Measurement

3.6.1 Description of 99% Occupied Bandwidth and 26dB Bandwidth Measurement

The occupied bandwidth is the width of a frequency band such that, below the lower and above the upper frequency limits, the mean powers emitted are each equal to a specified percentage 0.5% of the total mean transmitted power.

The 26 dB emission bandwidth is defined as the frequency range between two points, one above and one below the carrier frequency, at which the spectral density of the emission is attenuated 26 dB below the maximum in-band spectral density of the modulated signal. Spectral density (power per unit bandwidth) is to be measured with a detector of resolution bandwidth equal to approximately 1.0% of the emission bandwidth.

3.6.2 Test Procedures

1. The testing follows FCC KDB 971168 v02r02 Section 4.2.
2. The EUT was connected to spectrum analyzer and system simulator via a power divider.
3. The spectrum analyzer center frequency is set to the nominal EUT channel center frequency. The span range for the spectrum analyzer shall be between two and five times the anticipated OBW.
4. The nominal resolution bandwidth (RBW) shall be in the range of 1 to 5 % of the anticipated OBW, and the VBW shall be at least 3 times the RBW.
5. Set the detection mode to peak, and the trace mode to max hold.
6. Determine the reference value: Set the EUT to transmit a modulated signal. Allow the trace to stabilize. Set the spectrum analyzer marker to the highest level of the displayed trace.
(this is the reference value)
7. Determine the “-26 dB down amplitude” as equal to (Reference Value – X).
8. Place two markers, one at the lowest and the other at the highest frequency of the envelope of the spectral display such that each marker is at or slightly below the “-X dB down amplitude” determined in step 6. If a marker is below this “-X dB down amplitude” value it shall be placed as close as possible to this value. The OBW is the positive frequency difference between the two markers.
9. Use the 99 % power bandwidth function of the spectrum analyzer and report the measured bandwidth.



3.7 Conducted Band Edge

3.7.1 Description of Conducted Band Edge Measurement

The power of any emission outside of the authorized operating frequency ranges must be lower than the transmitter power (P) by a factor of at least $43 + 10 \log (P)$ dB.

3.7.2 Test Procedures

1. The testing follows FCC KDB 971168 D01 v02r02 Section 6.0.
2. The EUT was connected to the spectrum analyzer and system simulator via a power divider.
3. The RF output of EUT was connected to the spectrum analyzer by an RF cable and attenuator. The path loss was compensated to the results for each measurement.
4. The band edges of low and high channels for the highest RF powers were measured.
5. The RF fundamental frequency should be excluded against the limit line in the operating frequency band.
6. The limit line is derived from $43 + 10\log(P)$ dB below the transmitter power P(Watts)



3.8 Conducted Spurious Emission

3.8.1 Description of Conducted Spurious Emission Measurement

The power of any emission outside of the authorized operating frequency ranges must be lower than the transmitter power (P) by a factor of at least $43 + 10 \log (P)$ dB.

It is measured by means of a calibrated spectrum analyzer and scanned from 30 MHz up to a frequency including its 10th harmonic.

3.8.2 Test Procedures

1. The testing follows FCC KDB 971168 D01 v02r02 Section 6.0.
2. The EUT was connected to the spectrum analyzer and system simulator via a power divider.
3. The RF output of EUT was connected to the spectrum analyzer by an RF cable and attenuator. The path loss was compensated to the results for each measurement.
4. The middle channel for the highest RF power within the transmitting frequency was measured.
5. The conducted spurious emission for the whole frequency range was taken.
6. The RF fundamental frequency should be excluded against the limit line in the operating frequency band.
7. The limit line is derived from $43 + 10\log(P)$ dB below the transmitter power P(Watts)



3.9 Frequency Stability

3.9.1 Description of Frequency Stability Measurement

The frequency stability shall be measured by variation of ambient temperature and variation of primary supply voltage to ensure that the fundamental emission stays within the authorized frequency block. The frequency stability of the transmitter shall be maintained within $\pm 0.00025\%$ ($\pm 2.5\text{ppm}$) of the center frequency.

3.9.2 Test Procedures for Temperature Variation

1. The testing follows FCC KDB 971168 D01 v02r02 Section 9.0.
2. The EUT was set up in the thermal chamber and connected with the system simulator.
3. With power OFF, the temperature was decreased to -30°C and the EUT was stabilized before testing. Power was applied and the maximum change in frequency was recorded within one minute.
4. With power OFF, the temperature was raised in 10°C steps up to 50°C . The EUT was stabilized at each step for at least half an hour. Power was applied and the maximum frequency change was recorded within one minute.

3.9.3 Test Procedures for Voltage Variation

1. The testing follows FCC KDB 971168 D01 v02r02 Section 9.0.
2. The EUT was placed in a temperature chamber at $20\pm 5^{\circ}\text{C}$ and connected with the system simulator.
3. The power supply voltage to the EUT was varied from 85% to 115% of the nominal value measured at the input to the EUT.
4. The variation in frequency was measured for the worst case.

4 Radiated Test Items

4.1 Measuring Instruments

See list of measuring instruments of this test report.

4.2 Test Setup

4.2.1 For radiated test from 30MHz to 1GHz

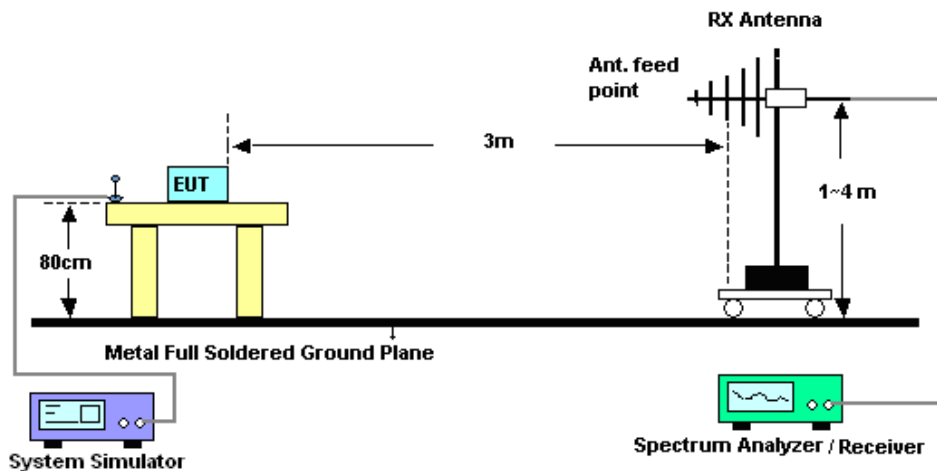

4.2.2 For radiated test above 1GHz

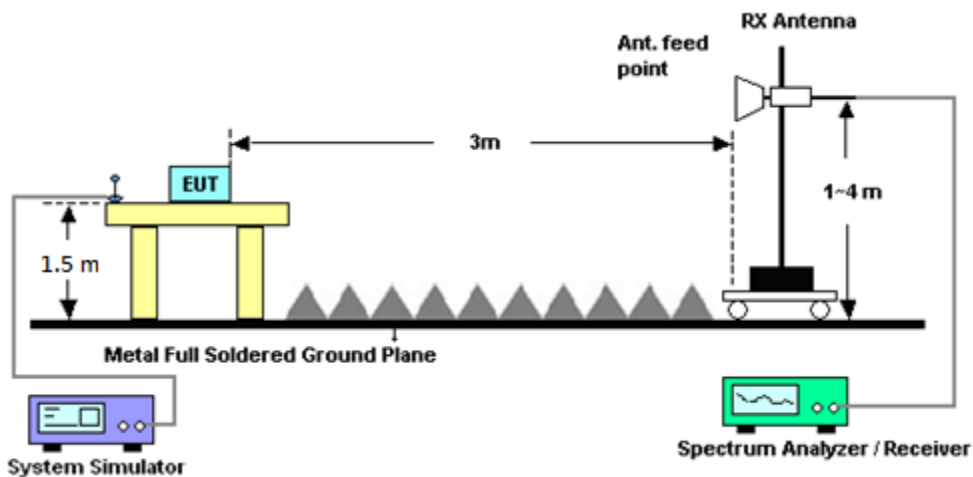

4.3 Test Result of Radiated Test

Please refer to Appendix B.



4.4 Field Strength of Spurious Radiation Measurement

4.4.1 Description of Field Strength of Spurious Radiated Measurement

The power of any emission outside of the authorized operating frequency ranges must be attenuated below the transmitter power (P) by a factor of at least $43 + 10 \log (P)$ dB. The spectrum is scanned from 30 MHz up to a frequency including its 10th harmonic.

4.4.2 Test Procedures

1. The testing follows FCC KDB 971168 D01 v02r02 Section 5.8 and ANSI / TIA-603-E-2016 Section 2.2.12.
2. The EUT was placed on a rotatable wooden table 0.8 meters for frequency below 1GHz and 1.5 meter for frequency above 1GHz above the ground.
3. The EUT was set 3 meters from the receiving antenna, which was mounted on the antenna tower.
4. The table was rotated 360 degrees to determine the position of the highest spurious emission.
5. The height of the receiving antenna is varied between one meter and four meters to search for the maximum spurious emission for both horizontal and vertical polarizations.
6. Make the measurement with the spectrum analyzer's RBW = 1MHz, VBW = 3MHz, taking record of maximum spurious emission.
7. A horn antenna was substituted in place of the EUT and was driven by a signal generator.
8. Tune the output power of signal generator to the same emission level with EUT maximum spurious emission.
9. Taking the record of output power at antenna port.
10. Repeat step 7 to step 8 for another polarization.
11. $EIRP \text{ (dBm)} = S.G. \text{ Power} - Tx \text{ Cable Loss} + Tx \text{ Antenna Gain}$
12. $ERP \text{ (dBm)} = EIRP - 2.15$
13. The RF fundamental frequency should be excluded against the limit line in the operating frequency band.
14. The limit line is derived from $43 + 10\log(P)$ dB below the transmitter power P(Watts)



5 List of Measuring Equipment

Instrument	Manufacturer	Model No.	Serial No.	Characteristics	Calibration Date	Test Date	Due Date	Remark
Spectrum Analyzer	Rohde & Schwarz	FSP30	101329	9kHz~30GHz	Jun. 26, 2017	Jun. 27, 2017	Jun. 25, 2018	Conducted (TH03-HY)
Temperature Chamber	ESPEC	SU-641	92013721	-30℃ ~70℃	Nov. 16, 2016	Jun. 27, 2017	Nov. 15, 2017	Conducted (TH03-HY)
Programmable Power Supply	GW Instek	PSS-2005	EL883644	Voltage:0~20V; Current:0~5A	Nov. 22, 2016	Jun. 27, 2017	Nov. 21, 2017	Conducted (TH03-HY)
Base Station (Measure)	Rohde & Schwarz	CMU200	117997	GSM / GPRS / WCDMA / CDMA	Aug. 05, 2016	Jun. 27, 2017	Aug. 04, 2017	Conducted (TH03-HY)
Amplifier	MITEQ	TTA1840-35-H G	1871923	18GHz~40GHz, VSWR : 2.5:1 max	Jul. 16, 2016	Jul. 06, 2017 ~ Jul. 12, 2017	Jul. 15, 2017	Radiation (03CH12-HY)
Bilog Antenna	TESEQ	CBL 6111D&00800 N1D01N-06	37059&01	30MHz~1GHz	Oct. 15, 2016	Jul. 06, 2017 ~ Jul. 12, 2017	Oct. 14, 2017	Radiation (03CH12-HY)
EMI Test Receiver	Rohde & Schwarz	ESU26	100390	20Hz~26.5GHz	Dec. 23, 2016	Jul. 06, 2017 ~ Jul. 12, 2017	Dec. 22, 2017	Radiation (03CH12-HY)
Horn Antenna	SCHWARZBE CK	BBHA 9120D	9120D-1328	1GHz ~ 18GHz	Oct. 25, 2016	Jul. 06, 2017 ~ Jul. 12, 2017	Oct. 24, 2017	Radiation (03CH12-HY)
Preamplifier	COM-POWER	PA-103	161075	10MHz~1GHz	Mar. 23, 2017	Jul. 06, 2017 ~ Jul. 12, 2017	Mar. 22, 2018	Radiation (03CH12-HY)
Preamplifier	MITEQ	AMF-7D-0010 1800-30-10P	1815698	1GHz~18GHz	Dec. 01, 2016	Jul. 06, 2017 ~ Jul. 12, 2017	Nov. 30, 2017	Radiation (03CH12-HY)
Controller	EMEC	EM1000	N/A	Control Turn table & Ant Mast	N/A	Jul. 06, 2017 ~ Jul. 12, 2017	N/A	Radiation (03CH12-HY)
Antenna Mast	EMEC	AM-BS-4500-B	N/A	1m~4m	N/A	Jul. 06, 2017 ~ Jul. 12, 2017	N/A	Radiation (03CH12-HY)
Turn Table	EMEC	TT2000	N/A	0~360 Degree	N/A	Jul. 06, 2017 ~ Jul. 12, 2017	N/A	Radiation (03CH12-HY)
SHF-EHF Horn Antenna	SCHWARZBE CK	BBHA 9170	BBHA917057 6	18GHz ~ 40GHz	Apr. 27, 2017	Jul. 06, 2017 ~ Jul. 12, 2017	Apr. 26, 2018	Radiation (03CH12-HY)
SHF-EHF Horn Antenna	SCHWARZBE CK	BBHA 9170	BBHA917058 4	18GHz- 40GHz	Nov. 08, 2016	Jul. 06, 2017 ~ Jul. 12, 2017	Nov. 07, 2017	Radiation (03CH12-HY)
Signal Generator	Anritsu	MG3694C	163401	0.1Hz~40GHz	Jan. 04, 2017	Jul. 06, 2017 ~ Jul. 12, 2017	Jan. 03, 2018	Radiation (03CH12-HY)
Horn Antenna	SCHWARZBE CK	BBHA 9120 D	9120D-1522	1G~18GHz	Mar. 17, 2017	Jul. 06, 2017 ~ Jul. 12, 2017	Mar. 16, 2018	Radiation (03CH12-HY)



6 Uncertainty of Evaluation

Uncertainty of Radiated Emission Measurement (30 MHz ~ 1000 MHz)

Measuring Uncertainty for a Level of Confidence of 95% ($U = 2Uc(y)$)	5.10
---	------

Uncertainty of Radiated Emission Measurement (1 GHz ~ 40 GHz)

Measuring Uncertainty for a Level of Confidence of 95% ($U = 2Uc(y)$)	5.20
---	------



Appendix A. Test Results of Conducted Test

Conducted Output Power(Average power)

Conducted Power (*Unit: dBm)						
Band	WCDMA Band V			WCDMA Band II		
Channel	4132	4182	4233	9262	9400	9538
Frequency	826.4	836.4	846.6	1852.4	1880	1907.6
RMC 12.2K	23.31	23.57	23.53	23.15	23.35	23.55
HSDPA Subtest-1	22.24	22.21	22.09	22.21	22.51	22.62
HSDPA Subtest-2	22.16	22.29	22.11	22.24	22.51	22.69
HSDPA Subtest-3	21.76	21.80	21.63	21.76	22.03	22.23
HSDPA Subtest-4	21.76	21.70	21.62	21.75	22.02	22.21
HSUPA Subtest-1	22.09	21.71	21.61	22.44	22.16	22.72
HSUPA Subtest-2	20.75	20.76	20.75	21.00	21.08	21.47
HSUPA Subtest-3	20.45	20.33	21.04	21.08	21.18	21.20
HSUPA Subtest-4	21.24	21.73	21.72	21.14	21.45	21.73
HSUPA Subtest-5	22.40	22.30	22.30	22.20	22.50	22.60



A2. WCDMA

Peak-to-Average Ratio

Mode	WCDMA Band V	WCDMA Band II		Limit: 13dB
Mod.	RMC 12.2Kbps	RMC 12.2Kbps		Result
Lowest CH	3.12	3.16		PASS
Middle CH	3.40	2.96		
Highest CH	3.12	2.96		

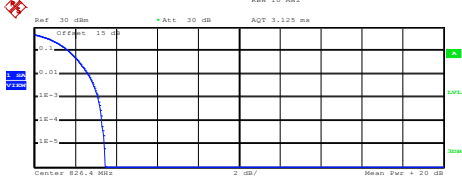
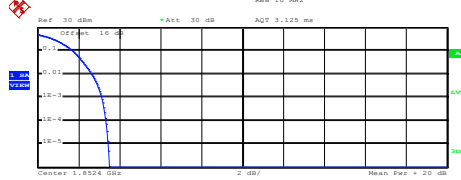
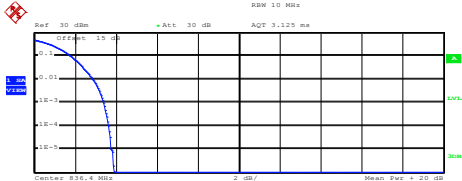
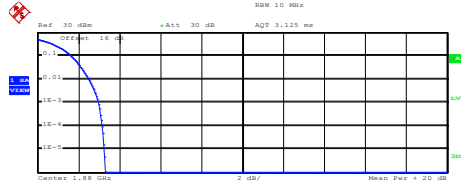
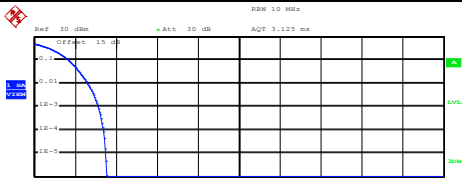
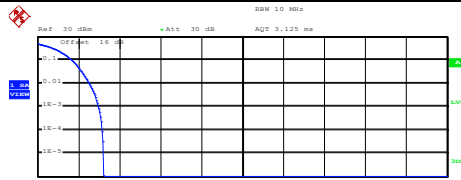

WCDMA Band V (RMC 12.2Kbps)	WCDMA Band II (RMC 12.2Kbps)																
<p style="text-align: center;">Lowest Channel</p>  <p>Center 826.4 MHz 2 dB/ Mean Pwr + 20 dB</p> <p>Complementary Cumulative Distribution Function (100000 samples) Trace 1 Mean 22.08 dBm Peak 25.53 dBm Crest 3.45 dB</p> <table border="1"> <tr><td>10 %</td><td>1.68 dB</td></tr> <tr><td>1 %</td><td>2.64 dB</td></tr> <tr><td>.1 %</td><td>3.12 dB</td></tr> <tr><td>.01 %</td><td>3.32 dB</td></tr> </table> <p>Date: 27.JUN.2017 16:57:52</p>	10 %	1.68 dB	1 %	2.64 dB	.1 %	3.12 dB	.01 %	3.32 dB	<p style="text-align: center;">Lowest Channel</p>  <p>Center 1.8524 GHz 2 dB/ Mean Pwr + 20 dB</p> <p>Complementary Cumulative Distribution Function (100000 samples) Trace 1 Mean 21.24 dBm Peak 24.75 dBm Crest 3.51 dB</p> <table border="1"> <tr><td>10 %</td><td>1.72 dB</td></tr> <tr><td>1 %</td><td>2.64 dB</td></tr> <tr><td>.1 %</td><td>3.16 dB</td></tr> <tr><td>.01 %</td><td>3.36 dB</td></tr> </table> <p>Date: 27.JUN.2017 16:36:11</p>	10 %	1.72 dB	1 %	2.64 dB	.1 %	3.16 dB	.01 %	3.36 dB
10 %	1.68 dB																
1 %	2.64 dB																
.1 %	3.12 dB																
.01 %	3.32 dB																
10 %	1.72 dB																
1 %	2.64 dB																
.1 %	3.16 dB																
.01 %	3.36 dB																
<p style="text-align: center;">Middle Channel</p>  <p>Center 830.4 MHz 2 dB/ Mean Pwr + 20 dB</p> <p>Complementary Cumulative Distribution Function (100000 samples) Trace 1 Mean 21.99 dBm Peak 25.88 dBm Crest 3.89 dB</p> <table border="1"> <tr><td>10 %</td><td>1.80 dB</td></tr> <tr><td>1 %</td><td>2.88 dB</td></tr> <tr><td>.1 %</td><td>3.40 dB</td></tr> <tr><td>.01 %</td><td>3.64 dB</td></tr> </table> <p>Date: 27.JUN.2017 16:58:01</p>	10 %	1.80 dB	1 %	2.88 dB	.1 %	3.40 dB	.01 %	3.64 dB	<p style="text-align: center;">Middle Channel</p>  <p>Center 1.88 GHz 2 dB/ Mean Pwr + 20 dB</p> <p>Complementary Cumulative Distribution Function (100000 samples) Trace 1 Mean 21.46 dBm Peak 24.75 dBm Crest 3.29 dB</p> <table border="1"> <tr><td>10 %</td><td>1.64 dB</td></tr> <tr><td>1 %</td><td>2.52 dB</td></tr> <tr><td>.1 %</td><td>2.96 dB</td></tr> <tr><td>.01 %</td><td>3.16 dB</td></tr> </table> <p>Date: 27.JUN.2017 16:36:21</p>	10 %	1.64 dB	1 %	2.52 dB	.1 %	2.96 dB	.01 %	3.16 dB
10 %	1.80 dB																
1 %	2.88 dB																
.1 %	3.40 dB																
.01 %	3.64 dB																
10 %	1.64 dB																
1 %	2.52 dB																
.1 %	2.96 dB																
.01 %	3.16 dB																
<p style="text-align: center;">Highest Channel</p>  <p>Center 846.6 MHz 2 dB/ Mean Pwr + 20 dB</p> <p>Complementary Cumulative Distribution Function (100000 samples) Trace 1 Mean 22.07 dBm Peak 25.60 dBm Crest 3.53 dB</p> <table border="1"> <tr><td>10 %</td><td>1.68 dB</td></tr> <tr><td>1 %</td><td>2.60 dB</td></tr> <tr><td>.1 %</td><td>3.12 dB</td></tr> <tr><td>.01 %</td><td>3.40 dB</td></tr> </table> <p>Date: 27.JUN.2017 16:58:09</p>	10 %	1.68 dB	1 %	2.60 dB	.1 %	3.12 dB	.01 %	3.40 dB	<p style="text-align: center;">Highest Channel</p>  <p>Center 1.9076 GHz 2 dB/ Mean Pwr + 20 dB</p> <p>Complementary Cumulative Distribution Function (100000 samples) Trace 1 Mean 21.52 dBm Peak 24.75 dBm Crest 3.23 dB</p> <table border="1"> <tr><td>10 %</td><td>1.68 dB</td></tr> <tr><td>1 %</td><td>2.52 dB</td></tr> <tr><td>.1 %</td><td>2.96 dB</td></tr> <tr><td>.01 %</td><td>3.16 dB</td></tr> </table> <p>Date: 27.JUN.2017 16:36:31</p>	10 %	1.68 dB	1 %	2.52 dB	.1 %	2.96 dB	.01 %	3.16 dB
10 %	1.68 dB																
1 %	2.60 dB																
.1 %	3.12 dB																
.01 %	3.40 dB																
10 %	1.68 dB																
1 %	2.52 dB																
.1 %	2.96 dB																
.01 %	3.16 dB																



26dB Bandwidth

Mode	WCDMA Band V	WCDMA Band II	
Mod.	RMC 12.2Kbps	RMC 12.2Kbps	
Lowest CH	4.71	4.70	
Middle CH	4.69	4.72	
Highest CH	4.71	4.71	

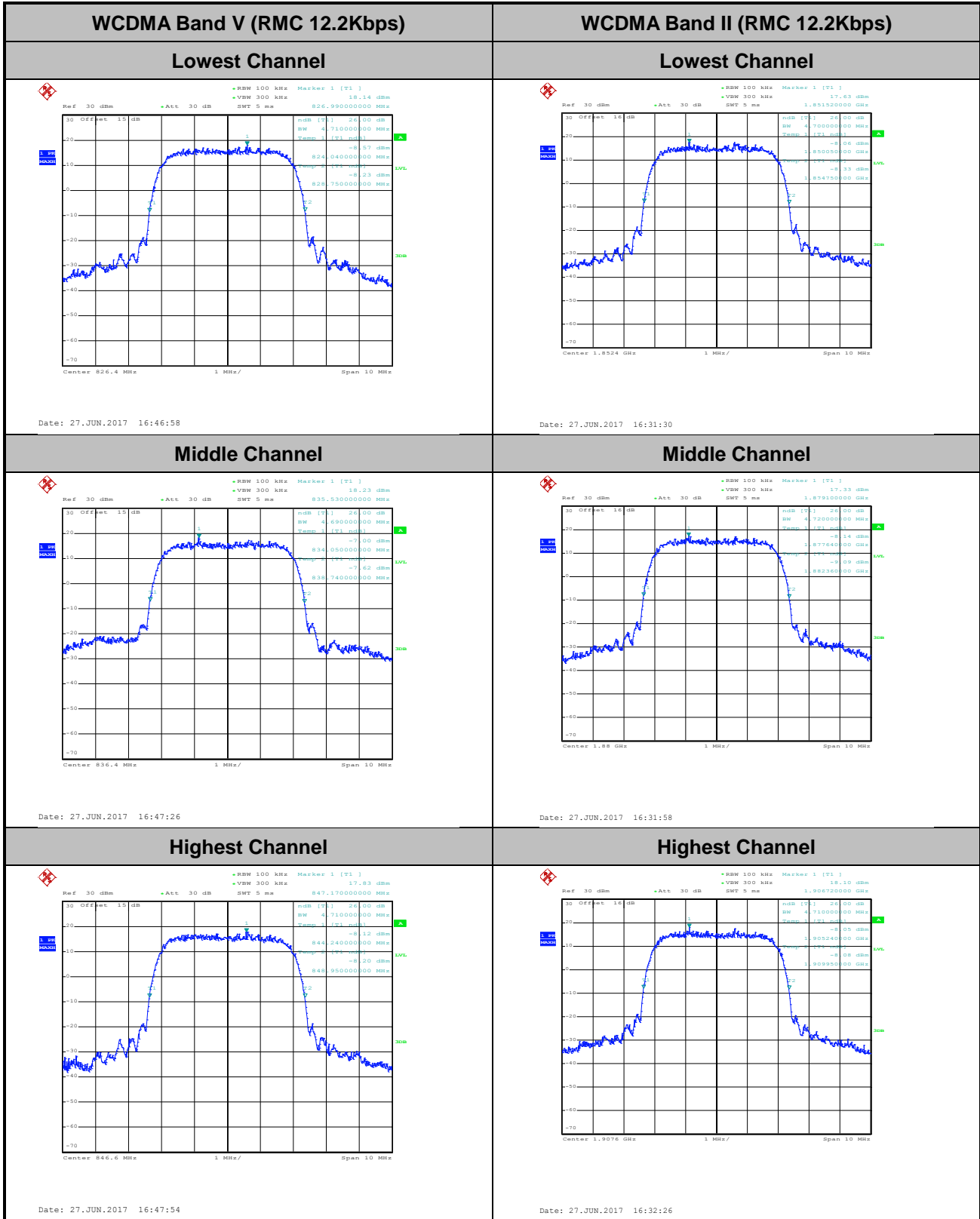



Occupied Bandwidth

Mode	WCDMA Band V	WCDMA Band II	
Mod.	RMC 12.2Kbps	RMC 12.2Kbps	
Lowest CH	4.12	4.14	
Middle CH	4.12	4.14	
Highest CH	4.14	4.14	

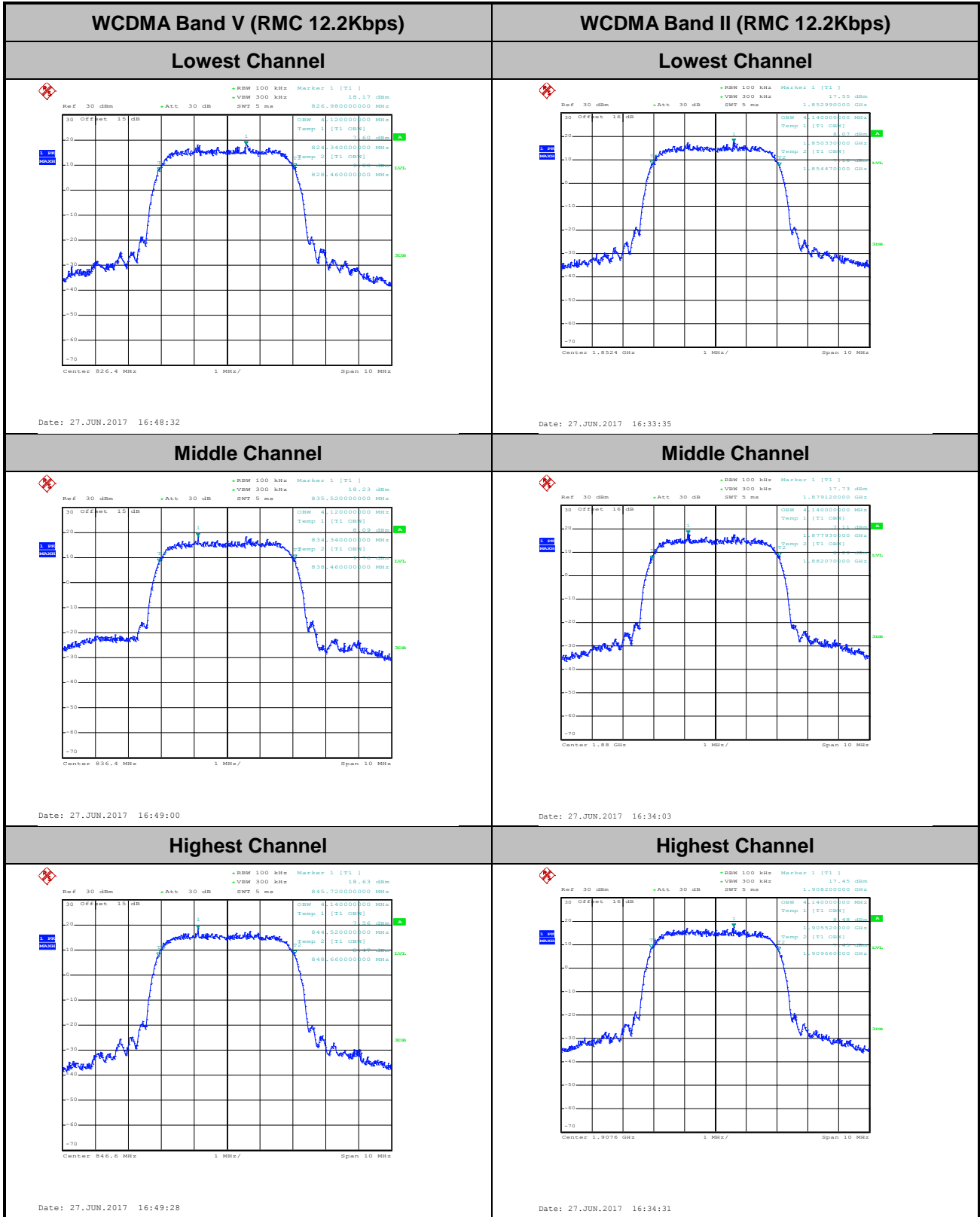



Conducted Band Edge



WCDMA Band V (RMC 12.2Kbps)

Lowest Band Edge

Highest Band Edge

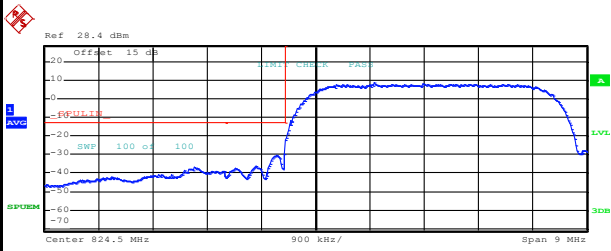

Start [Hz]	Stop [Hz]	RBW [Hz]	Freq [Hz]	PwrAbs [dBm]	ΔLimit [dB]
820.000 M	823.000 M	100.00 k	822.490000 M	-37.06	-24.06
823.000 M	824.000 M	50.00 k	823.996000 M	-30.08	-17.08
824.000 M	829.000 M	100.00 k	825.465000 M	8.57	-26.43

Date: 27.JUN.2017 16:52:12

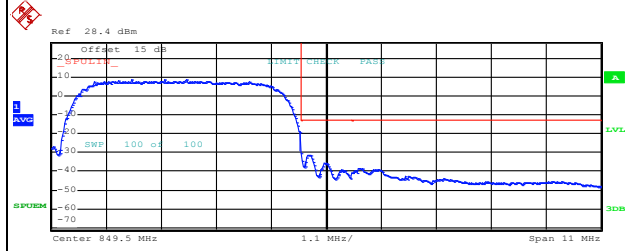

Start [Hz]	Stop [Hz]	RBW [Hz]	Freq [Hz]	PwrAbs [dBm]	ΔLimit [dB]
844.000 M	849.000 M	100.00 k	846.255000 M	8.80	-26.20
849.000 M	850.000 M	50.00 k	849.004000 M	-30.68	-17.68
850.000 M	855.000 M	100.00 k	850.220000 M	-38.57	-25.57

Date: 27.JUN.2017 16:54:53



WCDMA Band II (RMC 12.2Kbps)

Lowest Band Edge

Highest Band Edge

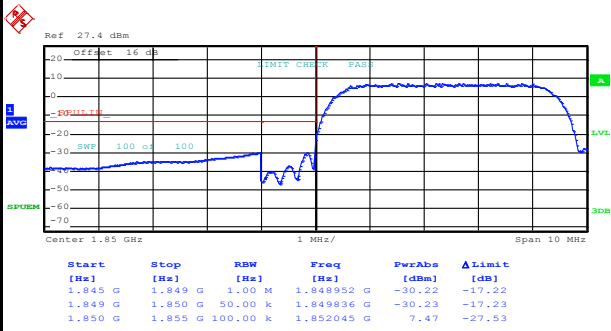

Date: 27.JUN.2017 16:41:56

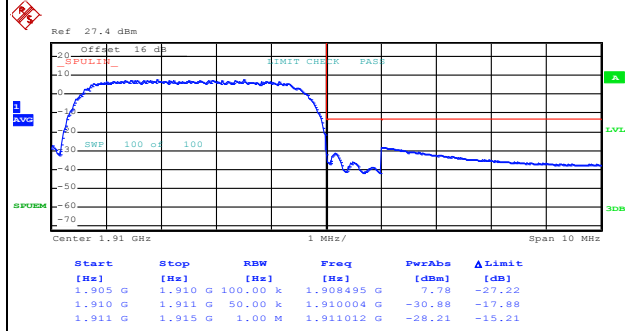

Date: 27.JUN.2017 16:44:38



Conducted Spurious Emission

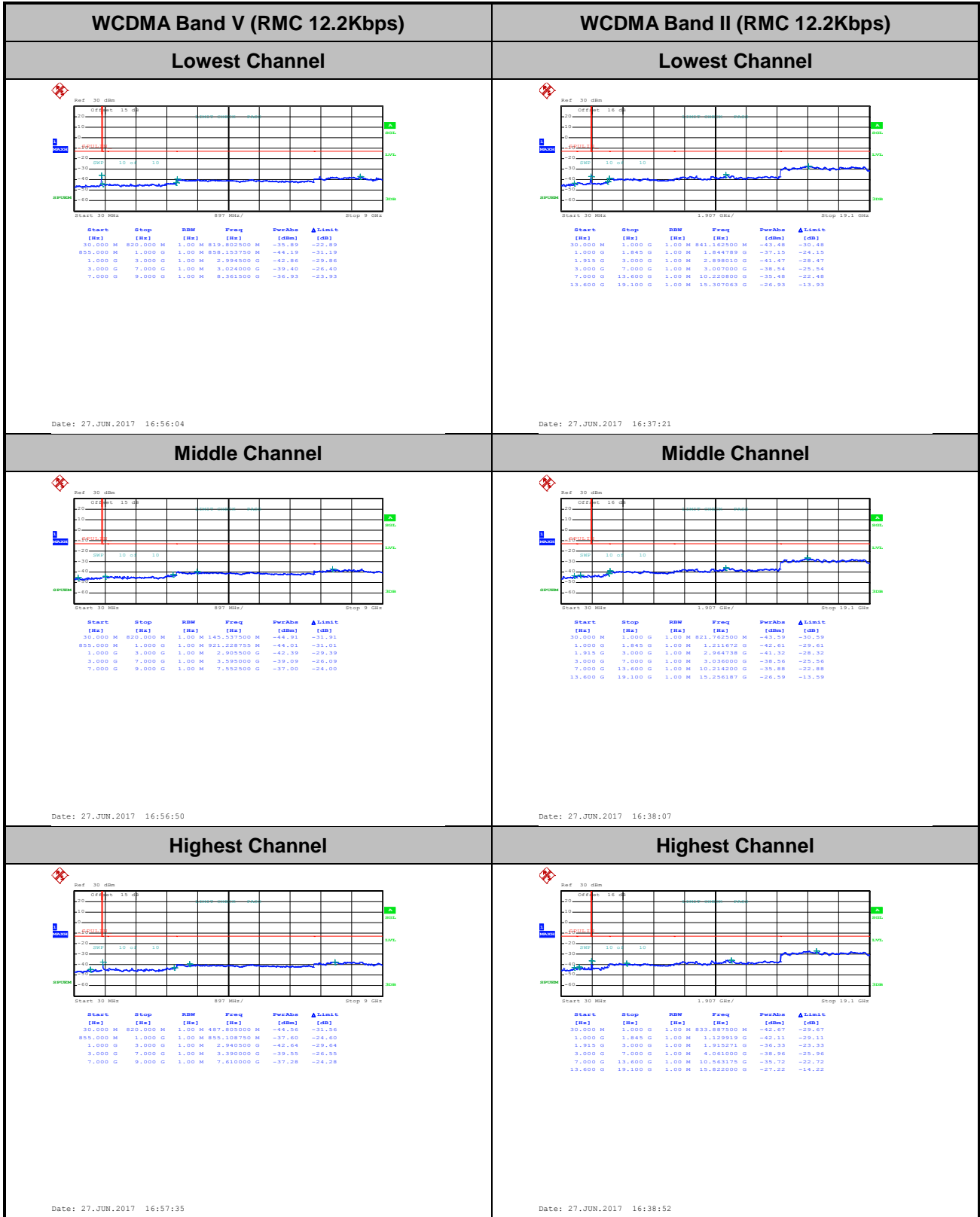



Frequency Stability

Test Conditions	Middle Channel	WCDMA Band V (RMC 12.2Kbps)	Limit 2.5ppm
Temperature (°C)	Voltage (Volt)	Deviation (ppm)	Result
50	Normal Voltage	0.0012	PASS
40	Normal Voltage	0.0012	
30	Normal Voltage	0.0000	
20(Ref.)	Normal Voltage	0.0000	
10	Normal Voltage	0.0024	
0	Normal Voltage	0.0036	
-10	Normal Voltage	0.0155	
-20	Normal Voltage	0.0143	
-30	Normal Voltage	0.0024	
20	Maximum Voltage	0.0012	
20	Normal Voltage	0.0012	
20	Battery End Point	0.0000	



Test Conditions	Middle Channel	WCDMA Band II (RMC 12.2Kbps)	Limit Note 2.
Temperature (°C)	Voltage (Volt)	Deviation (ppm)	Result
50	Normal Voltage	0.0011	PASS
40	Normal Voltage	0.0005	
30	Normal Voltage	0.0005	
20(Ref.)	Normal Voltage	0.0000	
10	Normal Voltage	0.0011	
0	Normal Voltage	0.0021	
-10	Normal Voltage	0.0032	
-20	Normal Voltage	0.0096	
-30	Normal Voltage	0.0085	
20	Maximum Voltage	0.0005	
20	Normal Voltage	0.0005	
20	Battery End Point	0.0021	

Note:

1. Normal Voltage = 3.3V. ; Battery End Point (BEP) = 3.3 V. ; Maximum Voltage =3.3 V
2. The frequency fundamental emissions stay within the authorized frequency block based on the frequency deviation measured is small.



Appendix B. Test Results of ERP/EIRP and Radiated Test

ERP/EIRP

Channel	Mode	Conducted		ERP	
		Power (dBm)	Power (Watts)	ERP(dBm)	ERP(W)
Lowest	WCDMA Band V	23.31	0.2143	17.66	0.0583
Middle	RMC 12.2Kbps	23.57	0.2275	17.92	0.0619
Highest	(GT - LC = -3.5 dB)	23.53	0.2254	17.88	0.0614
Limit	ERP < 7W	Result		PASS	

Channel	Mode	Conducted		EIRP	
		Power (dBm)	Power (Watts)	EIRP(dBm)	EIRP(W)
Lowest	WCDMA Band II	23.15	0.2065	23.75	0.2371
Middle	RMC 12.2Kbps	23.35	0.2163	23.95	0.2483
Highest	(GT - LC = 0.6 dB)	23.55	0.2265	24.15	0.2600
Limit	EIRP < 2W	Result		PASS	



Radiated Spurious Emission



Part22H WCDMA 850

Mode 1_WCDMA 850									
Channel	Frequency (MHz)	ERP (dBm)	Limit (dBm)	Over Limit (dB)	SPA Reading (dBm)	S.G. Power (dBm)	TX Cable loss (dB)	TX Antenna Gain (dBi)	Polarization (H/V)
Lowest	1656	-58.64	-13	-45.64	-45.4	-60.37	0.98	4.86	H
	2472	-60.95	-13	-47.95	-51.46	-62.83	1.28	5.32	H
	3312	-60.82	-13	-47.82	-53.8	-64.30	1.55	7.17	H
	4136	-50.17	-13	-37.17	-44.8	-54.81	1.84	8.63	H
	4960	-62.29	-13	-49.29	-61.17	-67.45	2.31	9.62	H
									H
									H
	1656	-65.20	-13	-52.20	-52.1	-66.93	0.98	4.86	V
	2472	-61.33	-13	-48.33	-51.86	-63.21	1.28	5.32	V
	3312	-59.99	-13	-46.99	-52.74	-63.47	1.55	7.17	V
	4136	-48.58	-13	-35.58	-43.02	-53.22	1.84	8.63	V
	4960	-62.72	-13	-49.72	-61.37	-67.88	2.31	9.62	V
									V
									V
Middle	1672	-56.58	-13	-43.58	-43.42	-58.26	0.99	4.82	H
	2504	-61.82	-13	-48.82	-52.4	-63.78	1.29	5.40	H
	3352	-64.42	-13	-51.42	-57.47	-68.06	1.56	7.35	H
	4176	-50.38	-13	-37.38	-45.23	-55.00	1.86	8.64	H
									H
									H
									H
	1672	-63.96	-13	-50.96	-50.9	-65.64	0.99	4.82	V
	2504	-61.13	-13	-48.13	-51.75	-63.09	1.29	5.40	V
	3352	-63.82	-13	-50.82	-56.62	-67.46	1.56	7.35	V
	4184	-48.06	-13	-35.06	-42.7	-52.68	1.87	8.64	V
									V
									V



Highest	1696	-56.54	-13	-43.54	-43.46	-58.14	1.00	4.75	H
	2544	-64.67	-13	-51.67	-55.43	-66.65	1.30	5.44	H
	3384	-62.11	-13	-49.11	-55.23	-65.88	1.57	7.49	H
	4224	-52.34	-13	-39.34	-47.4	-56.94	1.89	8.64	H
									H
									H
									H
	1688	-61.13	-13	-48.13	-48.07	-62.76	1.00	4.77	V
	2536	-61.67	-13	-48.67	-52.4	-63.65	1.30	5.43	V
	3384	-60.94	-13	-47.94	-53.8	-64.71	1.57	7.49	V
	4224	-48.97	-13	-35.97	-43.81	-53.57	1.89	8.64	V
									V
									V
									V

Remark: Spurious emissions within 30-1000MHz were found more than 20dB below limit line.



Part24E WCDMA 1900

Mode 1_WCDMA 1900									
Channel	Frequency (MHz)	EIRP (dBm)	Limit (dBm)	Over Limit (dB)	SPA Reading (dBm)	S.G. Power (dBm)	TX Cable loss (dB)	TX Antenna Gain (dBi)	Polarization (H/V)
Lowest	3700	-54.36	-13	-41.36	-48.02	-60.93	1.67	8.24	H
	5555	-49.81	-13	-36.81	-50.36	-56.87	2.66	9.72	H
	7410	-59.20	-13	-46.20	-65.18	-68.36	2.46	11.62	H
									H
									H
									H
									H
	3700	-53.63	-13	-40.63	-47.04	-60.20	1.67	8.24	V
	5555	-47.39	-13	-34.39	-47.9	-54.46	2.66	9.72	V
	7410	-58.78	-13	-45.78	-65.06	-67.94	2.46	11.62	V
									V
									V
									V
									V
Middle	3763	-59.20	-13	-46.20	-52.95	-65.83	1.69	8.32	H
	5639	-51.50	-13	-38.50	-52.25	-58.55	2.71	9.76	H
	7522	-58.92	-13	-45.92	-65.19	-68.31	2.42	11.81	H
									H
									H
									H
									H
	3763	-57.34	-13	-44.34	-50.87	-63.97	1.69	8.32	V
	5646	-48.59	-13	-35.59	-49.28	-55.64	2.71	9.76	V
	7522	-58.38	-13	-45.38	-64.93	-67.77	2.42	11.81	V
									V
									V
									V
									V



Highest	3819	-58.62	-13	-45.62	-52.44	-65.30	1.70	8.38	H
	5723	-49.69	-13	-36.69	-50.64	-56.73	2.75	9.79	H
	7627	-58.68	-13	-45.68	-65.16	-68.17	2.39	11.88	H
									H
									H
									H
									H
	3819	-57.39	-13	-44.39	-51.01	-64.07	1.70	8.38	V
	5723	-47.86	-13	-34.86	-48.74	-54.90	2.75	9.79	V
	7627	-56.87	-13	-43.87	-63.59	-66.36	2.39	11.88	V
									V
									V
									V
									V

Remark: Spurious emissions within 30-1000MHz were found more than 20dB below limit line.