

Submittal Application Report

For
Grant of Certification

FOR

Model: RBLHG-5nD-US
5180-5240, and 5745-5825 MHz
Unlicensed National Information Infrastructure
(U-NII) Device

U-NII-1, U-NII-3 Operation (New Rules)

FCC ID: TV7LHG5ND

IC: 7442A-LHG5ND

FOR

Mikrotiks SIA

Pernavas 46

Riga, Latvia LV-1009

Test Report Number: 160414A
IC Test Site Registration: 3041A-1

Authorized Signatory: *Scot D. Rogers*
Scot D. Rogers

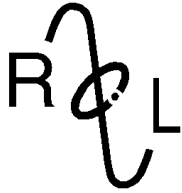

ROGERS LABS, INC.

4405 West 259th Terrace
Louisburg, KS 66053
Phone / Fax (913) 837-3214

Engineering Test Report for Grant of Certification Application

FOR

Unlicensed National Information Infrastructure
(U-NII) Device

CFR 47, Part 15E 15.407

Industry Canada RSS-247 Issue 1

License Exempt Intentional Radiator

For

Mikrotiks SIA

Pernavas 46
Riga, Latvia LV-1009

Broadband Digital Transmission System
U-NII-1 and U-NII-3 operation

Product Code: RBLHG-5nD-US, Model RouterBOARD LHG 5nD
Frequency Range 5180-5240 and 5745-5825 MHz
FCC ID#: TV7LHG5ND
IC: 7442A-LHG5ND

Test Date: April 14, 2016

Certifying Engineer: *Scot D. Rogers*

Scot D. Rogers
Rogers Labs, Inc.
4405 West 259th Terrace
Louisburg, KS 66053
Telephone/Facsimile: (913) 837-3214

This report shall not be reproduced except in full, without the written approval of the laboratory.
This report must not be used by the client to claim product certification, approval, or
endorsement by NVLAP, NIST, or any agency of the Federal Government.

Rogers Labs, Inc.
4405 W. 259th Terrace
Louisburg, KS 66053
Phone/Fax: (913) 837-3214
Revision 2

Mikrotiks SIA
Model: RouterBOARD LHG-5nD
Test #: 160414a
Test to: 47CFR, 15.407, RSS-247
File: Mikrotik RBLHG5nDUS TstRpt 160414a 160625 r2

S/N: 66750503D06F/548
FCC ID#: TV7LHG5ND
IC: 7442A-LHG5ND
Date: June 30, 2016

Page 2 of 52

Table Of Contents

TABLE OF CONTENTS.....	3
REVISIONS.....	5
FORWARD	6
OPINION / INTERPRETATION OF RESULTS	6
EQUIPMENT TESTED.....	6
EQUIPMENT FUNCTION AND CONFIGURATION.....	7
Equipment Configuration.....	8
APPLICANT COMPANY INFORMATION	8
Equipment information	8
Product Details	9
Antenna and Bandwidth.....	10
IEEE 11a/n Spec.....	10
Accessories	10
Table for Filed Antennas	10
Table for Carrier Frequencies	10
Table for Test Modes	11
Test Result of 26dB Bandwidth and 99% Occupied Bandwidth	12
APPLICATION FOR CERTIFICATION.....	13
APPLICABLE STANDARDS & TEST PROCEDURES	14
EQUIPMENT TESTING PROCEDURES	14
AC Line Conducted Emission Test Procedure	14
Radiated Emission Test Procedure.....	14
Diagram 1 Test arrangement for Conducted emissions	15
Diagram 2 Test arrangement for radiated emissions of tabletop equipment.....	16

Diagram 3 Test arrangement for radiated emissions tested on Open Area Test Site (OATS)17

TEST SITE LOCATIONS 17

LIST OF TEST EQUIPMENT 18

UNITS OF MEASUREMENTS 19

ENVIRONMENTAL CONDITIONS..... 19

INTENTIONAL RADIATORS..... 19

Antenna Requirements19

Restricted Bands of Operation.....19

 Table 1 Radiated Emissions in Restricted Bands Data (Band Edges and Harmonics)20

 Table 2 Radiated Emissions in Restricted Bands Data (General Emissions).....21

Summary of Results for Radiated Emissions in Restricted Bands21

AC Line Conducted Emissions Procedure22

 Figure 1 AC Line Conducted Emissions Line 123

 Figure 2 AC Line Conducted Emissions Line 223

 Table 3 AC Line Conducted Emissions Data (Highest Emissions Line L1)24

 Table 4 AC Line Conducted Emissions Data (Highest Emissions Line L2)24

Summary of Results for AC Line Conducted Emissions24

General Radiated Emissions Procedure25

 Table 5 General Radiated Emissions from EUT Data (Highest Emissions)26

Summary of Results for General Radiated Emissions26

Operation in the 5150-5250 and 5725-5850 MHz Frequency Band27

 Figure 3 Plot of Transmitter Emissions (Across 5150-5250 MHz Band, 20 MHz Channel)28

 Figure 4 Plot of Transmitter Emissions (Across 5150-5250 MHz Band, 40 MHz Channel)28

 Figure 5 Plot of Transmitter Low Band Edge (5150-5250 MHz Band, 20 MHz Channel)29

 Figure 6 Plot of Transmitter Low Band Edge (5150-5250 MHz Band, 40 MHz Channel)29

 Figure 7 Plot of Transmitter High Band Edge (5150-5250 MHz Band, 20 MHz Channel)30

 Figure 8 Plot of Transmitter High Band Edge (5150-5250 MHz Band, 40 MHz Channel)30

 Figure 9 Plot of Transmitter Emissions (5150-5250 MHz Band, 20 MHz Channel, 99% OBW)31

 Figure 10 Plot of Transmitter Emissions (5150-5250 MHz Band, 40 MHz Channel, 99% OBW)31

 Figure 11 Plot of Transmitter Emissions (Across 5725-5850 MHz Band, 20 MHz Channel)32

Figure 12 Plot of Transmitter Emissions (Across 5725-5850 MHz Band, 40 MHz Channel)32

Figure 13 Plot of Transmitter Low Band Edge (5725-5850 MHz Band, 20 MHz Channel)33

Figure 14 Plot of Transmitter Low Band Edge (5725-5850 MHz Band, 40 MHz Channel)33

Figure 15 Plot of Transmitter High Band Edge (5725-5850 MHz Band, 20 MHz Channel)34

Figure 16 Plot of Transmitter High Band Edge (5725-5850 MHz Band, 40 MHz Channel)34

Figure 17 Plot of Transmitter Emissions (5725-5850 MHz Band, 20 MHz Channel, 99% OBW)35

Figure 18 Plot of Transmitter Emissions (5725-5850 MHz Band, 40 MHz Channel, 99% OBW)35

Figure 19 Plot of Transmitter Emissions (5725-5850 MHz Band, 20 MHz Channel, 6-dB OBW)36

Figure 20 Plot of Transmitter Emissions (5725-5850 MHz Band, 40 MHz Channel, 6-dB OBW)36

Transmitter Emissions Data.....37

Table 6 Transmitter Radiated Emission (5150-5250 MHz Band, 802.11a, 20 MHz Channel)37

Table 7 Transmitter Radiated Emission (5725-5850 MHz Band, 802.11a, 20 MHz Channel)38

Table 8 Transmitter Radiated Emission (5150-5250 MHz Band, 802.11n, 20 MHz Channel)39

Table 9 Transmitter Radiated Emission (5725-5850 MHz Band, 802.11n, 20 MHz Channel)40

Table 10 Transmitter Radiated Emission (5180-5250 MHz Band, 802.11n, 40 MHz Channel)41

Table 11 Transmitter Radiated Emission (5725-5850 MHz Band, 802.11n, 40 MHz Channel)42

Table 12 Transmitter Power and Emissions Chain 043

Table 13 Transmitter Power and Emissions Chain 144

Table 14 Transmitter Power and Emissions Both Chains Active45

Measurement of emission at elevation angle higher than 30° from horizon.....46

Summary of Results for Transmitter Radiated Emissions of Intentional Radiator46

STATEMENT OF MODIFICATIONS AND DEVIATIONS 46

ANNEX..... 47

Annex A Measurement Uncertainty Calculations.....48

Annex B Rogers Labs Test Equipment List.....49

Annex C Rogers Qualifications50

Annex D FCC Site Registration Letter.....51

Annex E Industry Canada Site Registration Letter52

Revisions

Revision 2 Issued June 30, 2016 – added band edge compliance data (pages 33, 34, 38, 40, and 42)

Revision 1 Issued June 28, 2016 – added mode specific (802.11a and n) data and report corrected

Forward

The following information is submitted for consideration in obtaining Grant of Certification for License Exempt, Unlicensed National Information Infrastructure (U-NII) Intentional Radiator operating under 47CFR Paragraph 15E (15.407) [U-NII-1 and U-NII-3 new rules, 5180-5240, and 5745-5825 MHz bands], Industry Canada RSS-GEN Issue 4, and RSS-247 Issue 1, LE-LAN Outdoor access point transmitter operation in the 5745-5825 MHz band.

Name of Applicant: Mikrotiks SIA FRN: 0014 43 1100
 Pernavas 46
 Riga, Latvia LV-1009

Model: RBLHG-5nD-US

FCC ID: TV7LHG5ND IC: 7442A-LHG5ND

Frequency Range: US: 5180-5240 MHz and 5745-5825 MHz (U-NII-1 and U-NII-3 under new rules 15.407, 802.11a/n 20 MHz and 40 MHz channels) and restricted frequency band of operation for Canada: 5745-5825 MHz

Total Operating Power: Maximum 0.001-watt total output power (with 24-dBi gain integral antenna), OBW 17,610, or 37,850 kHz

Opinion / Interpretation of Results

Tests Performed	Margin (dB)	Results
Restricted Frequency Bands 15.205, RSS-GEN 8.10	-1.8	Complies
AC Line Conducted 15.207, RSS-GEN 7.2.4	-10.8	Complies
Radiated Emissions 15.209, RSS-GEN 7.2.5	-4.2	Complies
Harmonic Emissions per 15.407, RSS-247	-23.9	Complies
Power Spectral Density per 15.407, RS-247	-11.05	Complies

Equipment Tested

<u>Equipment</u>	<u>Model</u>	<u>FCC I.D.</u>
EUT	RBLHG-5nD-US	TV7LHG5ND
AC Adapter	FLD301-240120-U	N/A
Power Adapter	POE	N/A
Dell Studio XPS	921LBN1	N/A

Test results in this report relate only to the items tested.

Equipment Function and Configuration

The EUT is a Digital Transmission System offering operational capabilities across the 5180-5240 and 5745-5825 MHz frequency bands. The design provides operational capabilities for United States operation in the authorized U-NII-1 and U-NII-3 services (5180-5240 MHz and 5745-5825 MHz). The design provides operational use in Canada as LE-LAN Outdoor access point operation in the 5725-5850 MHz band only. The configuration software restricts use to the 5725-5850 MHz band when Canada is selected as the location. The EUT offers broadband wireless connectivity to transmit and receive data. The design utilizes fixed antenna system and offers no provision for antenna replacement or modification. The design utilizes Multiple-Input-Multiple-Output (MIMO) operational capability utilizing signals correlated between chains. The product supports spatial multiplexing/cyclic delay diversity in the MIMO configurations and single stream legacy modes. Antenna gains for both chains are identical. The equipment is marketed for use to provide a wireless link to exchange data information from point to point. For testing purposes, the EUT transceiver was connected to the manufacturer supplied AC/DC supply and communicating to the laptop computer through Ethernet network interface. This configuration provided operational control of the EUT and communications over the network interface between the EUT and supporting computer system. The design provides connections points for network interface only requiring Power-Over-Ethernet (POE) and AC/DC adapter for power. The design provides no other interfacing options. For testing purposes, the RBLHG-5nD-US was configured to transmit in available data modes receiving power from the manufacturer provided AC/DC power adapter and POE. The antenna system complies with requirements for unique antenna connection port.

Equipment Configuration

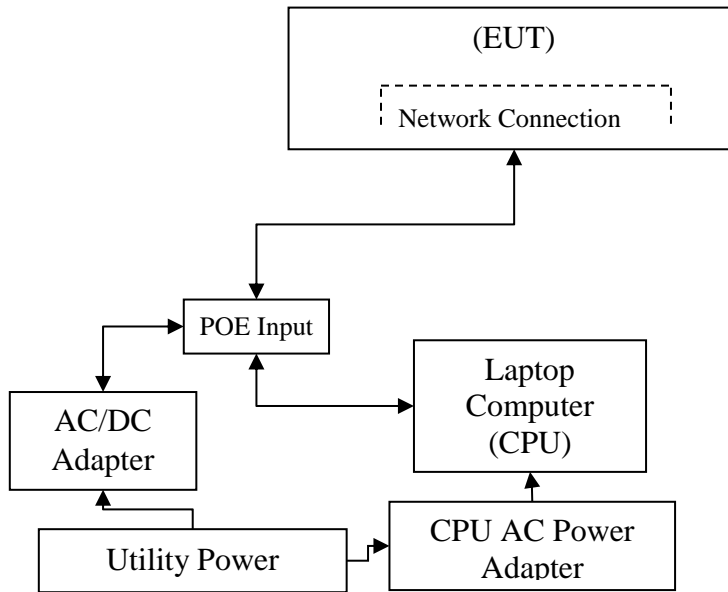

Applicant Company information

Applicants Company	MikroTik (“Mikrotīkls, SIA”)
Applicants Address	Pernavas 46, Riga, Latvia LV-1009
FCC Identifier	TV7LHG5ND
Industry Canada Identifier	7442A-LHG5ND
Manufacturer Company	MikroTik (“Mikrotīkls, SIA”)
Manufacturer Address	Pernavas 46, Riga, Latvia LV-1009

Equipment information

Product Marketing Name (PMN) : The PMN is the name or model number under which the product will be marketed/offered for sale in Canada. If the product has PMN, it must be provided.	LHG 5
Unique Product Number (UPN): The applicant, made up of a maximum of 11 alphanumeric characters (A-Z, 0-9), assigns the UPN.	66750503D06F
Hardware Version Identification Number (HVIN): The HVIN identifies hardware specifications of a product version. The HVIN replaces the ISED Model Number in the legacy E-filing System. An HVIN is required for all products for certification applications.	r4.0
Host Marketing Name (HMN) (if applicable): The HMN is the name or model number of a final product, which contains a certified radio module.	n/a

Brand Name	RouterBOARD
Model Number	RBLHG-5nD-US
Test Rule Part(s)	Under 15.407, PART 15E U-NII-1 & 3, Industry Canada RSS-247
Test Frequency Range	5.15-5.25 and 5.725-5.85GHz
Project Number	160414a
Submission Type	Certification

Product Details

Items	Description
Product Type	WLAN [2x2 mimo, (2TX, 2RX)]
Radio Type	Intentional Transceiver
Power Type	External Power Supply and POE adapter
Modulation	IEEE 802.11a: OFDM IEEE 802.11a/n: see the below table
Data Modulation	IEEE 802.11 a/n: OFDM (BPSK/QPSK/16QAM/64QAM) IEEE 802.11a/c: OFDM (BPSK/QPSK/16QAM/64QAM/256QAM)
Data Rate (Mbps)	IEEE 802.11a: OFDM (6/9/12/18/24/36/48/54) IEEE 802.11a/n: see the below table
Frequency Range	5150-5250 MHz; 5725-5850 MHz US and 5725-5850 Canada
Channel Number	9 for 20 MHz bandwidth; 4 for 40MHz bandwidth
Channel Band Width (99%)	Band U-NII-1: IEEE 802.11a: 17.610 MHz IEEE 802.11a/n MCS0/Nss1 (VHT20): 17.610 MHz IEEE 802.11a/n MCS0/Nss1 (VHT40): 37.820 MHz Band U-NII-3: IEEE 802.11a: 17.220 MHz IEEE 802.11a/n MCS0/Nss1 (VHT20): 17.220 MHz IEEE 802.11 a/n MCS0/Nss1 (VHT40): 37.850 MHz
Maximum Conducted Output Power	Band U-NII-1: IEEE 802.11a: 0.001 Watts IEEE 802.11a/n MCS0/Nss1 (VHT20): 0.001 Watts IEEE 802.11a/n MCS0/Nss1 (VHT40): 0.001 Watts IEEE 802.11ac MCS0/Nss1 (VHT80): N/A Band U-NII-3: IEEE 802.11a: 0.001 Watts IEEE 802.11a/n MCS0/Nss1 (VHT20): 0.001 Watts IEEE 802.11a/n MCS0/Nss1 (VHT40): 0.001 Watts
Carrier Frequencies	Please refer to Table for Carrier Frequencies
Antenna	Please refer to Table for Filed Antenna
Communication Mode	IP Based (Load Based) Framed Based
Beamforming Function	As presented in operational description exhibit
Operating Mode	Outdoor access point, Fixed point-to-point access points

Antenna and Bandwidth

Antenna	TX chains		
Bandwidth Mode	20 MHz	40 MHz	80 MHz
IEEE 802.11a	24 dBi Dish, 2x2	24 dBi Dish, 2x2	N/A
IEEE 802.11n	24 dBi Dish, 2x2	24 dBi Dish, 2x2	N/A
IEEE 802.11ac	N/A	N/A	N/A

IEEE 11a/n Spec.

Protocol	Number of Transmit Chains (NTX)	Data Rate/MCS
802.11a (HT20)	2	MCS 0-23
802.11n (HT40)	2	MCS 0-23
802.11a/n (VHT20)	2	MCS 0-9/Nss1-3
802.11a/n (VHT40)	2	MCS 0-9/Nss1-3

Note 1: IEEE Std. 802.11a/n modulation consists of HT20 and HT40 (HT: High Throughput). The EUT supports HT20 and HT40.

Note 2: IEEE Std. 802.11ac modulation consists of VHT20, VHT40, VHT80, and VHT160 (VHT: Very High Throughput). The EUT does not support 802.11ac.

Note 3: Modulation modes consist of below configuration:
IEEE 802.11a/n : HT20/HT40; IEEE 802.11a/n: VHT20/VHT40

Accessories

AC Power Adapter	FLD301-240120-U
Power Over Ethernet (POE) adapter	POE

Table for Filed Antennas

Ant.	Brand	Model Name	P/N	Antenna Type	Connector	Gain (dBi)	
						2.4GHZ	5GHZ
1							
2							

Table for Carrier Frequencies

There are two bandwidth systems:

For 20MHz bandwidth systems, use Channel 36, 40, 44, 48, 149, 153, 157, 161, 165.

For 40MHz bandwidth systems, use Channel 38, 46, 151, 159.

Frequency Band	Channel No.	Frequency	Channel No.	Frequency
5150-5250MHz U-NII-1	36	5180MHz	44	5220MHz
	38	5190MHz	46	5230MHz
	40	5200MHz	48	5240MHz
	42	5210MHz	-	-
5725-5850MHz U-NII-3	149	5745MHz	157	5785MHz
	151	5755MHz	159	5795MHz
	153	5765MHz	161	5805MHz
	155	5775MHz	165	5825MHz

Table for Test Modes

Preliminary tests were performed using different data rates to identify the worst radiated emission. Investigation has been performed on the possible configurations during the investigation searching for the worst emissions. The following table is a list of the test modes investigated for this report.

Test Items	Mode		Data Rate	Channel	Chain
Max. Conducted Output Power	11 a BPSK	Band U-NII-1&4	6Mbps	36/40/48/149/157/165	1+2
	11a/n VHT20	Band U-NII-1&4	MCS0/Nss1	36/40/48/149/157/165	1+2
	11a/n VHT40	Band U-NII-1&4	MCS0/Nss1	38/46/151/159	1+2
Power Spectral Density	11a BPSK	Band U-NII-1&4	6Mbps	36//40/48/149/157/165	1+2
	11a/n VHT20	Band U-NII-1&4	MCS0/Nss1	36/40/48/149/157/165	1+2
	11a/n VHT40	Band U-NII-1&4	MCS0/Nss1	38/46/151/159	1+2
26dB Spectrum Bandwidth & 99% Occupied Bandwidth Measurement	11a BPSK	Band U-NII-1&4	6Mbps	36/40/48/149/157/165	1+2
	11a/n VHT20	Band U-NII-1&4	MCS0/Nss1	36/40/48/149/157/165	1+2
	11a/n VHT40	Band U-NII-1&4	MCS0/Nss1	38/46/151/159	1+2
6dB Spectrum Bandwidth Measurement	11a BPSK	Band U-NII-3	6Mbps	149/157/165	1+2
	11a/n VHT20	Band U-NII-3	MCS0/Nss1	149/157/165	1+2
	11a/n VHT40	Band U-NII-3	MCS0/Nss1	151/159	1+2
Radiated Emission Below 1GHz			-	-	-
Radiated Emission Above 1GHz	11a BPSK	Band U-NII-1&4	6Mbps	36/40/48/149/157/165	1+2
	11a/n VHT20	Band U-NII-1&4	MCS0/Nss1	36/40/48/149/157/165	1+2
	11a/n VHT40	Band U-NII-1&4	MCS0/Nss1	38/46/151/159	1+2

Band Edge Emission	11a BPSK	Band U-NII-1&4	6Mbps	36/40/48/149/157/165	1+2
	11a/n VHT20	Band U-NII-1&4	MCS0/Nss1	36/40/48/149/157/165	1+2
	11a/n VHT40	Band U-NII-1&4	MCS0/Nss1	38/46/151/159	1+2
Frequency Stability	20MHz	Band U-NII-1&4	-	40/157	1
	40MHz	Band U-NII-1&4	-	38/151	1

Test Result of 26dB Bandwidth and 99% Occupied Bandwidth

Mode	Frequency	26dB Bandwidth (MHz)	6dB Bandwidth (MHz)	99% Occupied Bandwidth (MHz)
802.11a	5180 MHz	21.960 MHz	N/A	17.610 MHz
	5200 MHz	21.960 MHz	N/A	17.610 MHz
	5240 MHz	21.960 MHz	N/A	17.610 MHz
	5745 MHz	22.400 MHz	17.150 MHz	17.220 MHz
	5785 MHz	22.400 MHz	17.150 MHz	17.220 MHz
	5825 MHz	22.400 MHz	17.150 MHz	17.220 MHz
802.11a/n MCS0/Nss1 VHT20	5180 MHz	21.960 MHz	N/A	17.610 MHz
	5200 MHz	21.960 MHz	N/A	17.610 MHz
	5240 MHz	21.960 MHz	N/A	17.610 MHz
	5745 MHz	22.400 MHz	17.150 MHz	17.220 MHz
	5785 MHz	22.400 MHz	17.150 MHz	17.220 MHz
	5825 MHz	22.400 MHz	17.150 MHz	17.220 MHz
802.11a/n MCS0/Nss1 VHT40	5190 MHz	46.810 MHz	34.865 MHz	37.820 MHz
	5230 MHz	46.810 MHz	34.865 MHz	37.820 MHz
	5755 MHz	46.850 MHz	35.322 MHz	37.850 MHz
	5795 MHz	46.850 MHz	35.417 MHz	37.850 MHz

Application for Certification

- (1) Manufacturer: Mikrotikls SIA
 Pernavas 46
 Riga, Latvia LV-1009
- (2) Identification: Model: RBLHG-5nD-US
 FCC I.D.: TV7LHG5ND IC: 7442A-LHG5ND
- (3) Instruction Book:
 Refer to Exhibit for Instruction Manual.
- (4) Description of Circuit Functions:
 Refer to Exhibit of Operational Description.
- (5) Block Diagram with Frequencies:
 Refer to Exhibit of Operational Description.
- (6) Report of Measurements:
 Report of measurements follows in this Report.
- (7) Photographs: Construction, Component Placement, etc.:
 Refer to Exhibit for photographs of equipment.
- (8) List of Peripheral Equipment Necessary for operation. The equipment operates from power received from authorized AC/DC power adapter. The EUT provides single Ethernet input port for communications and power. During testing, the EUT was powered from AC/DC power supply, POE, and connected to CPU through network cable.
- (9) Transition Provisions of 47CFR 15.37 are not requested
- (10) Not Applicable. The unit is not a scanning receiver.
- (11) Not Applicable. The EUT does not operate in the 59 – 64 GHz frequency band.
- (12) The equipment is not software defined and this section is not applicable.
- (13) Applications for certification of U-NII devices in the 5.15-5.35 GHz and the 5.47-5.85 GHz bands must include a high-level operational description of the security procedures that control the radio frequency operating parameters and ensure that unauthorized modifications cannot be made. The required information has been provided in Operational Description Exhibit filed with the application.
- (14) Contain at least one drawing or photograph showing the test set-up for each of the required types of tests applicable to the device for which certification is requested. These drawings or photographs must show enough detail to confirm other information contained in the test report. Any photographs used must be focused originals without glare or dark spots and must clearly show the test configuration used. This information is provide in this report and Test Setup Exhibits provided with the application filing.

Applicable Standards & Test Procedures

The following information is submitted in accordance with e-CFR dated June 6, 2016, Part 2, Subpart J, Part 15, Subpart 15E, Industry Canada RSS-GEN issue 4, and RSS-247 issue 1. Test procedures used are the established Methods of Measurement of Radio-Noise Emissions as described in ANSI C63.10-2013, KDB 789033 D02 v01r02, KDB 412172 D01 v01r01, KDB 662911 D01 v02r01, KDB 926956 D01 v01r06, RSS-247 Issue 1, and RSS-GEN Issue 4. The following information is submitted for processing applications for Certification.

Equipment Testing Procedures

AC Line Conducted Emission Test Procedure

Testing for the AC line-conducted emissions was performed as defined in ANSI C63.10-2013. The test setup, including the EUT, was arranged in the test configurations as presented during testing. The test configuration was placed on a 1 x 1.5-meter wooden bench, 0.8 meters high located in a screen room. The power lines of the system were isolated from the power source using a standard LISN with a 50- μ Hy choke. EMI was coupled to the spectrum analyzer through a 0.1 μ F capacitor internal to the LISN. The LISN was positioned on the floor beneath the wooden bench supporting the EUT. The power lines and cables were draped over the back edge of the table. Refer to diagram one showing typical test arrangement and photographs in exhibits for EUT placement used during testing.

Radiated Emission Test Procedure

Radiated emission testing was performed as required and specified in ANSI C63.10-2013 and applicable KDB documents. The EUT was placed on a rotating 0.9 x 1.2-meter platform, elevated as required above the ground plane at a distance of 3 meters from the FSM antenna. The table permitted orientation of the EUT in each of three orthogonal axis positions if necessary. EMI energy was maximized by equipment placement, raising and lowering the FSM antenna, changing the antenna polarization, and by rotating the turntable. Each emission was maximized before data was taken using a spectrum analyzer. The frequency spectrum from 9 kHz to 50,000 MHz was searched for during preliminary investigation. Refer to diagrams two and three showing typical test arrangement and photographs in the test setup exhibits for specific EUT placement during testing.

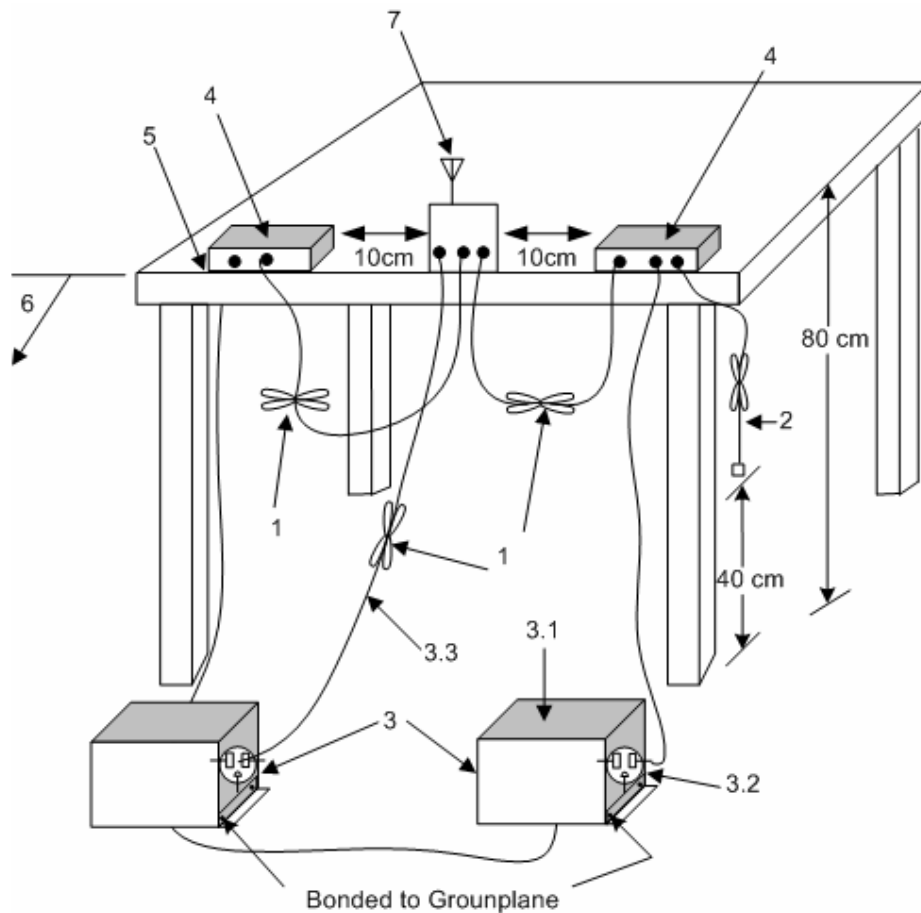

1. Interconnecting cables that hang closer than 40 cm to the ground plane shall be folded back and forth in the center forming a bundle 30 cm to 40 cm long see (see 6.2.3.2).
2. The I/O cables that are not connected to an accessory shall be bundled in the center. The end of the cable may be terminated, if required, using the correct terminating impedance. The overall length shall not exceed 1 m (see 6.2.2).
3. EUT connected to one LISN. Unused LISN measuring port connectors shall be terminated in 50 Ω loads. LISN may be placed on top of, or immediately beneath, reference ground plane (see 6.2.2 and 6.2.3).
 - 3.1 All other equipment powered from additional LISN(s).
 - 3.2 Multiple-outlet strip can be used for multiple power cords of non-EUT equipment.
 - 3.3 LISN at least 80 cm from nearest part of EUT chassis
4. Non-EUT components of EUT system being tested
5. Rear of EUT, including peripherals, shall all be aligned and flush with edge of tabletop (see 6.2.3.2).
6. Edge of tabletop shall be 40 cm removed from a vertical conducting plane that is bonded to the ground plane (see 6.2.2 for options).
7. Antenna may be integral or detachable. If detachable, the antenna shall be attached for this test.

Diagram 1 Test arrangement for Conducted emissions

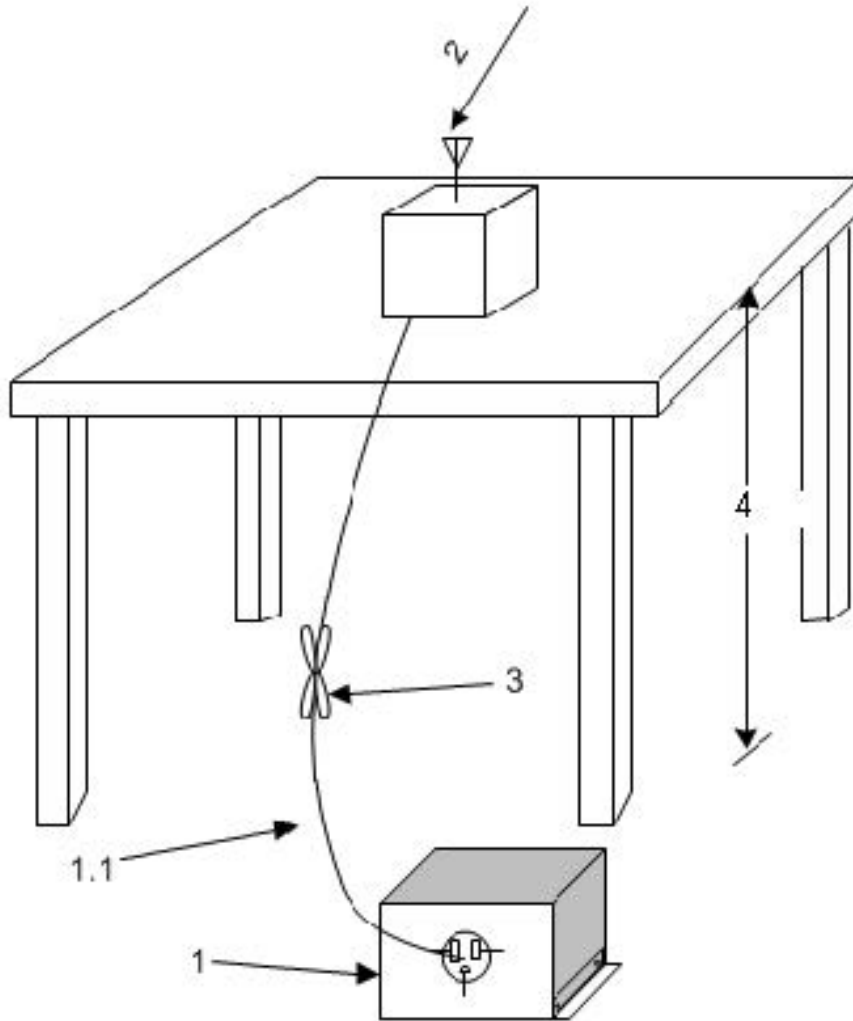

1. A LISN is optional for radiated measurements between 30 MHz and 1000 MHz but not allowed for measurements below 30 MHz and above 1000 MHz (see 6.3.1). If used, then connect EUT to one LISN. Unused LISN measuring port connectors shall be terminated in 50 Ω loads. The LISN may be placed on top of, or immediately beneath, the reference ground plane (see 6.2.2 and 6.2.3.2).
 - 1.1 LISN spaced at least 80 cm from nearest part of EUT chassis.
2. Antenna can be integral or detachable, depending on the EUT (see 6.3.1).
3. Interconnecting cables that hang closer than 40 cm to the ground plane shall be folded back and forth in the center forming a bundle 30 cm to 40 cm long (see 6.3.1).
4. For emission measurements at or below 1 GHz, the table height shall be 80 cm. For emission measurements above 1 GHz, the table height shall be 1.5 m for measurements, except as otherwise specified (see 6.3.1 and 6.6.3.1).

Diagram 2 Test arrangement for radiated emissions of tabletop equipment

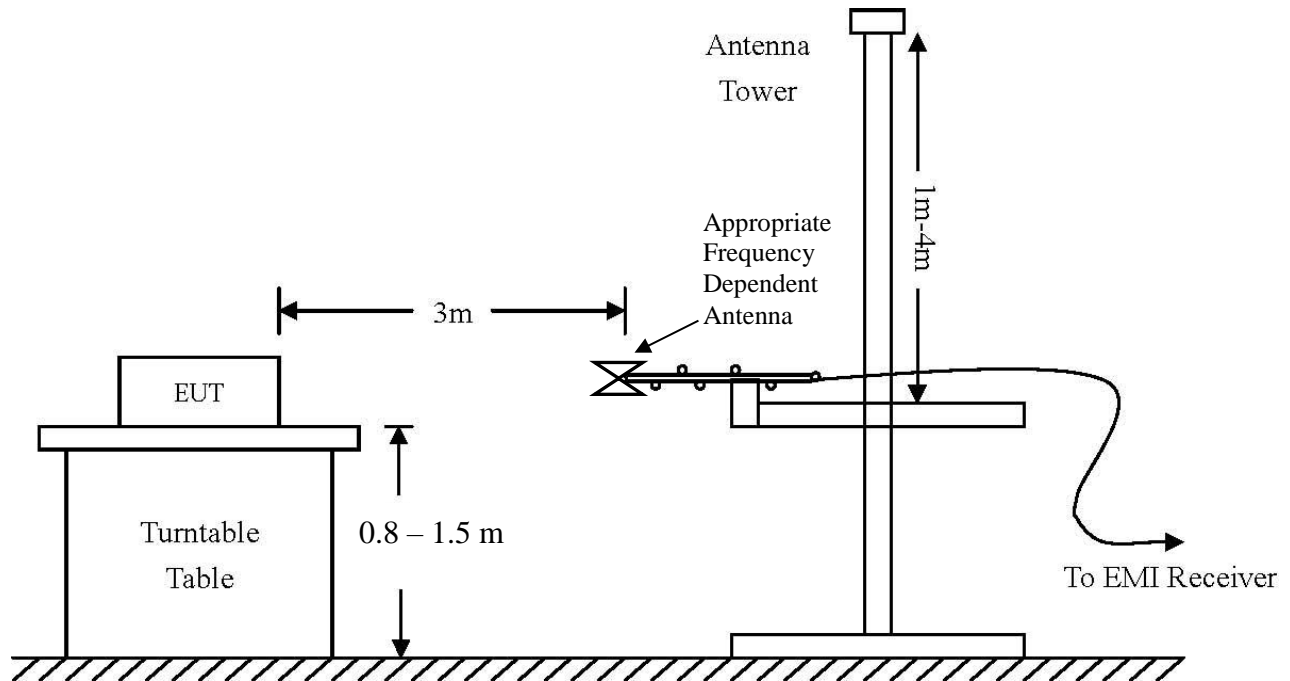

Frequency: 9 kHz-30 MHz	Frequency: 30 MHz- 1 GHZ	Frequency: Above 1 GHz
Loop Antenna	Broadband Biconilog	Horn
RBW = 9 kHz	RBW = 120 kHz	RBW = 1 MHz
VBW = 30 kHz	VBW = 120 kHz	VBW = 1 MHz
Sweep time = Auto	Sweep time = Auto	Sweep time = Auto
Detector = PK, QP	Detector = PK, QP	Detector = PK, AV
Antenna Height 1m	Antenna Height 1-4m	Antenna Height 1-4m

Diagram 3 Test arrangement for radiated emissions tested on Open Area Test Site (OATS)

Test Site Locations

Conducted EMI The AC power line conducted emissions testing performed in a shielded screen room located at Rogers Labs, Inc., 4405 West 259th Terrace, Louisburg, KS

Radiated EMI The radiated emissions tests were performed at the 3 meters, Open Area Test Site (OATS) located at Rogers Labs, Inc., 4405 West 259th Terrace, Louisburg, KS

Site Registration Refer to Annex for Site Registration Letters

NVLAP Accreditation Lab code 200087-0

List of Test Equipment

A Rohde and Schwarz ESU40 and/or Hewlett Packard 8591EM was used as the measuring device for the emissions testing of frequencies below 1 GHz. A Rohde and Schwarz ESU40 and/or Hewlett Packard 8562A Spectrum Analyzer was used as the measuring device for testing the emissions at frequencies above 1 GHz. The analyzer settings used are described in the following table. Refer to the appendix for a complete list of test equipment.

AC Line Conducted Emissions (0.150 -30 MHz)		
RBW	AVG. BW	Detector Function
9 kHz	30 kHz	Peak / Quasi Peak
Emissions (30-1000 MHz)		
RBW	AVG. BW	Detector Function
120 kHz	300 kHz	Peak / Quasi Peak
Emissions (Above 1000 MHz)		
RBW	Video BW	Detector Function
100 kHz	100 kHz	Peak
1 MHz	1 MHz	Peak / Average

Equipment	Manufacturer	Model (SN)	Band	Cal Date	Due
<input checked="" type="checkbox"/> LISN	FCC	FCC-LISN-50-2-10(1PA) (160611)	.15-30MHz	6/15	5/16
<input checked="" type="checkbox"/> Cable	Time Microwave	750HF290-750 (L10M)	9kHz-40 GHz	10/15	10/16
<input checked="" type="checkbox"/> Cable	Belden	RG-58 (L1-CAT3-11509)	9kHz-30 MHz	10/15	10/16
<input checked="" type="checkbox"/> Cable	Belden	RG-58 (L2-CAT3-11509)	9kHz-30 MHz	10/15	10/16
<input type="checkbox"/> Antenna	ARA	BCD-235-B (169)	20-350MHz	10/15	10/16
<input type="checkbox"/> Antenna	EMCO	3147 (40582)	200-1000MHz	10/15	10/16
<input checked="" type="checkbox"/> Antenna	ETS-Lindgren	3117 (200389)	1-18 GHz	5/15	5/17
<input type="checkbox"/> Antenna	Com Power	AH-118 (10110)	1-18 GHz	10/15	10/16
<input checked="" type="checkbox"/> Antenna	Com Power	AH-840 (101046)	18-40 GHz	5/15	5/17
<input checked="" type="checkbox"/> Antenna	EMCO	6509 (9502-1374)	.001-30 MHz	10/15	10/16
<input checked="" type="checkbox"/> Antenna	Sunol	JB-6 (A100709)	30-1000 MHz	10/15	10/16
<input checked="" type="checkbox"/> Antenna	EMCO	3143 (9607-1277)	20-1200 MHz	5/15	5/16
<input type="checkbox"/> Analyzer	HP	8591EM (3628A00871)	9kHz-1.8GHz	5/15	5/16
<input checked="" type="checkbox"/> Analyzer	HP	8562A (3051A05950)	9kHz-110GHz	5/15	5/16
<input checked="" type="checkbox"/> Analyzer	HP External Mixers	11571, 11970	40GHz-110GHz	5/15	5/16
<input checked="" type="checkbox"/> Analyzer	Rohde & Schwarz	ESU40 (100108)	20Hz-40GHz	5/15	5/16
<input checked="" type="checkbox"/> Amplifier	Com-Power	PA-010 (171003)	100Hz-30MHz	10/15	10/16
<input checked="" type="checkbox"/> Amplifier	Com-Power	CPPA-102 (01254)	1-1000 MHz	10/15	10/16
<input checked="" type="checkbox"/> Amplifier	Com-Power	PAM-118A (551014)	0.5-18 GHz	10/15	10/16

Units of Measurements

Conducted EMI Data is in dB μ V; dB referenced to one microvolt

Radiated EMI Data is in dB μ V/m; dB/m referenced to one microvolt per meter

Sample Calculation:

RFS = Radiated Field Strength, FSM = Field Strength Measured

A.F. = Receive antenna factor, Gain = amplification gains and/or cable losses

RFS (dB μ V/m @ 3m) = FSM (dB μ V) + A.F. (dB) - Gain (dB)

Environmental Conditions

Ambient Temperature	20.1° C
Relative Humidity	31%
Atmospheric Pressure	1020.5 mb

Intentional Radiators

As per 47CFR part 15 subpart E and Industry Canada RSS-247, Issue 1, the following information is submitted for consideration and demonstration of compliance with regulation and standards.

Antenna Requirements

The EUT incorporates integral antenna system and offers no provision for connection to alternate system. The EUT utilizes permanently attached antenna structure mounted to the printed circuit board. This antenna broadcasts to the attached parabolic dish structure incorporating the transmitter. The antenna connection point complies with requirements. The antenna connection point requirements are fulfilled there are no deviations or exceptions to the specification.

Restricted Bands of Operation

Spurious emissions falling in the restricted frequency bands of operation were measured on the OATS. The EUT utilizes frequency, determining circuitry, which generates harmonics falling in restricted bands. Emissions were investigated while the EUT was located on the OATS using appropriate antennas or pyramidal horns, amplification stages, and spectrum analyzer receiver. Peak and average amplitudes of frequencies above 1000 MHz were compared to the required limits with worst-case data presented below. Test procedures of ANSI C63.10-2013 were used during testing. No other significant emission was observed which fell into the restricted bands of operation. Computed radiated emission values take into account the measured radiated field strength, receive antenna correction factor, amplifier gain stage, and test system cable losses.

Table 1 Radiated Emissions in Restricted Bands Data (Band Edges and Harmonics)

Frequency in MHz	Horizontal Peak (dBµV/m)	Horizontal Average (dBµV/m)	Vertical Peak (dBµV/m)	Vertical Average (dBµV/m)	Peak Limit @ 3m (dBµV/m)	Average Limit @ 3m (dBµV/m)	Horizontal Peak Margin (dB)	Vertical Peak Margin (dB)	Horizontal Average Margin (dB)	Vertical Average Margin (dB)
5180 – 5240 MHz 802.11a										
5150.0	60.5	52.2	56.1	49.0	74	54.0	-13.5	-17.9	-1.8	-5.0
5350.0	56.3	52.2	53.2	48.3	74	54.0	-17.7	-20.8	-1.8	-5.7
15540.0	54.2	40.8	53.2	40.8	74	54.0	-19.8	-20.8	-13.2	-13.2
15600.0	53.5	40.7	53.3	40.7	74	54.0	-20.5	-20.7	-13.3	-13.3
15720.0	54.3	42.0	54.6	41.9	74	54.0	-19.7	-19.4	-12.0	-12.1
20720.0	50.8	37.8	51.4	37.8	74	54.0	-23.3	-22.7	-16.3	-16.3
20800.0	50.4	37.4	50.5	37.4	74	54.0	-23.7	-23.6	-16.7	-16.7
20960.0	49.9	37.3	50.0	37.2	74	54.0	-24.2	-24.1	-16.8	-16.9
5745 – 5825 MHz 802.11a										
11490.0	49.5	36.4	49.4	36.4	74	54.0	-24.5	-24.6	-17.6	-17.6
11570.0	49.9	36.5	49.7	36.6	74	54.0	-24.1	-24.3	-17.5	-17.4
11650.0	49.6	36.6	49.7	36.6	74	54.0	-24.4	-24.3	-17.4	-17.4
22980.0	50.5	37.8	50.9	37.3	74	54.0	-23.5	-23.1	-16.2	-16.7
5180 – 5240 MHz 802.11n (20 MHz Channel)										
5150.0	60.3	51.9	55.8	48.7	74	54.0	-13.7	-18.2	-2.1	-5.3
5350.0	55.3	51.6	52.8	47.5	74	54.0	-18.7	-21.2	-2.4	-6.5
15540.0	53.1	39.7	52.0	39.6	74	54.0	-20.9	-22.0	-14.3	-14.4
15600.0	52.3	39.6	52.2	39.6	74	54.0	-21.7	-21.8	-14.4	-14.4
15720.0	53.1	41.0	53.1	41.0	74	54.0	-20.9	-20.9	-13.0	-13.0
20720.0	49.5	36.7	49.6	36.7	74	54.0	-24.5	-24.4	-17.3	-17.3
20800.0	50.3	37.4	50.4	37.4	74	54.0	-23.8	-23.7	-16.7	-16.7
20960.0	50.0	37.3	50.2	37.2	74	54.0	-24.1	-23.9	-16.8	-16.9
5745 – 5825 MHz 802.11n (20 MHz Channel)										
11490.0	48.8	35.9	48.5	36.1	74	54.0	-25.2	-25.5	-18.1	-17.9
11570.0	49.6	36.0	49.6	36.5	74	54.0	-24.4	-24.4	-18.0	-17.5
11650.0	49.5	35.9	49.3	36.0	74	54.0	-24.5	-24.7	-18.1	-18.0
22980.0	50.6	37.7	50.8	37.2	74	54.0	-23.4	-23.2	-16.3	-16.8
5190 – 5230 MHz 802.11n (40 MHz Channel)										
5150.0	60.1	51.5	55.8	48.5	74	54.0	-13.9	-18.2	-2.5	-5.5
5350.0	55.1	51.0	52.3	47.2	74	54.0	-18.9	-21.7	-3.0	-6.8
15570.0	54.1	41.1	53.6	40.9	74	54.0	-19.9	-20.4	-12.9	-13.1
15690.0	53.3	41.0	53.6	40.8	74	54.0	-20.7	-20.4	-13.0	-13.2
20760.0	50.6	37.6	50.9	37.9	74	54.0	-23.5	-23.2	-16.5	-16.2
20920.0	49.9	37.9	50.4	37.8	74	54.0	-24.2	-23.7	-16.2	-16.3
5150.0	60.1	51.5	55.8	48.5	74	54.0	-13.9	-18.2	-2.5	-5.5
5350.0	55.1	51.0	52.3	47.2	74	54.0	-18.9	-21.7	-3.0	-6.8
5755 – 5795MHz 802.11n (40 MHz Channel)										
11510.0	50.0	37.0	50.1	36.9	74	54.0	-24.0	-23.9	-17.0	-17.1
11590.0	49.7	36.3	48.7	36.5	74	54.0	-24.3	-25.3	-17.7	-17.5
23020.0	50.1	37.5	50.7	37.4	74	54.0	-23.9	-23.3	-16.5	-16.6

Other emissions present had amplitudes at least 20 dB below the limit. Peak and Quasi-Peak amplitude emissions are recorded above for frequency range below 1000 MHz. Peak and Average amplitude emissions are recorded above for frequency range above 1000 MHz.

Table 2 Radiated Emissions in Restricted Bands Data (General Emissions)

Frequency in MHz	Horizontal Peak (dBµV/m)	Horizontal Average (dBµV/m)	Vertical Peak (dBµV/m)	Vertical Average (dBµV/m)	Peak Limit @ 3m (dBµV/m)	Average Limit @ 3m (dBµV/m)	Horizontal Peak Margin (dB)	Vertical Peak Margin (dB)	Horizontal Average Margin (dB)	Vertical Average Margin (dB)
General Emissions in Restricted Bands (worst-case operational mode)										
4735.0	44.5	31.1	55.8	36.4	74	54.0	-29.5	-18.2	-22.9	-17.6
5029.0	62.9	48.3	68.8	49.4	74	54.0	-11.1	-5.2	-5.7	-4.6
5072.0	66.0	47.9	68.4	48.7	74	54.0	-8.0	-5.6	-6.1	-5.3
5149.0	69.0	51.8	67.6	48.1	74	54.0	-5.0	-6.4	-2.2	-5.9

Other emissions present had amplitudes at least 20 dB below the limit. Peak and Quasi-Peak amplitude emissions are recorded above for frequency range below 1000 MHz. Peak and Average amplitude emissions are recorded above for frequency range above 1000 MHz.

Summary of Results for Radiated Emissions in Restricted Bands

The EUT demonstrated compliance with the emissions requirements of 47CFR 15.205, RSS-GEN and RSS-247, Issue 1 Intentional Radiators. The EUT provided a worst-case minimum margin of -1.8 dB below the average emissions requirements in restricted frequency bands. Peak, Quasi-peak, and average amplitudes were checked for compliance with the regulations. Worst-case emissions are reported with other emissions found in the restricted frequency bands at least 20 dB below the requirements.

AC Line Conducted Emissions Procedure

The EUT was arranged in a typical equipment configuration and placed on a 1 x 1.5-meter wooden bench 80 cm above the conducting ground plane, floor of a screen room. The bench was positioned 40 cm away from the wall of the screen room. The LISN was positioned on the floor of the screen room 80-cm from the rear of the EUT. The manufacturer supplied supporting equipment, which provided direct current power to the EUT and was connected to the LISN. A second LISN was positioned on the floor of the screen room 80-cm from the rear of the supporting equipment of the EUT. All power cords except the EUT support equipment power the EUT were then powered from the second LISN. EMI was coupled to the spectrum analyzer through a 0.1 μ F capacitor, internal to the LISN. Power line conducted emissions testing were carried out individually for each current carrying conductor of the EUT support equipment. The excess length of lead between the system and the LISN receptacle was folded back and forth to form a bundle not exceeding 40 cm in length. The screen room, conducting ground plane, analyzer, and LISN were bonded together to the protective earth ground. Preliminary testing was performed to identify the frequency of each emission displaying the highest amplitude. The cables were repositioned to obtain maximum amplitude of measured EMI level. Once the worst-case configuration was identified, plots were made of the EMI from 0.15 MHz to 30 MHz then the data was recorded with maximum conducted emissions levels. Refer to figures one and two for plots of the EUT support equipment AC Line Conducted emissions.

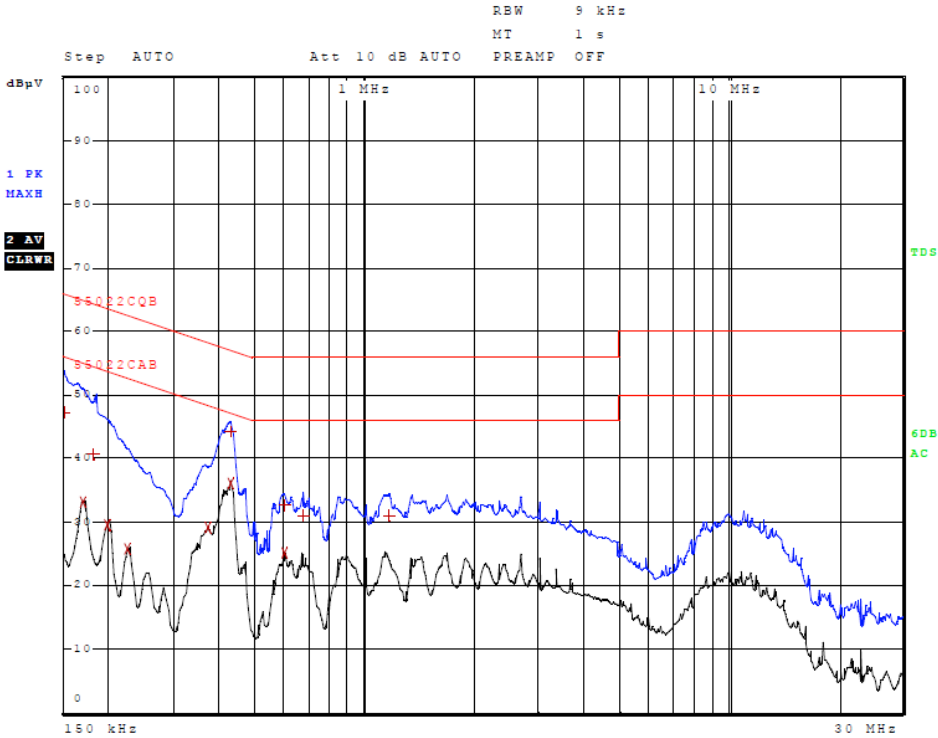

Figure 1 AC Line Conducted Emissions Line 1

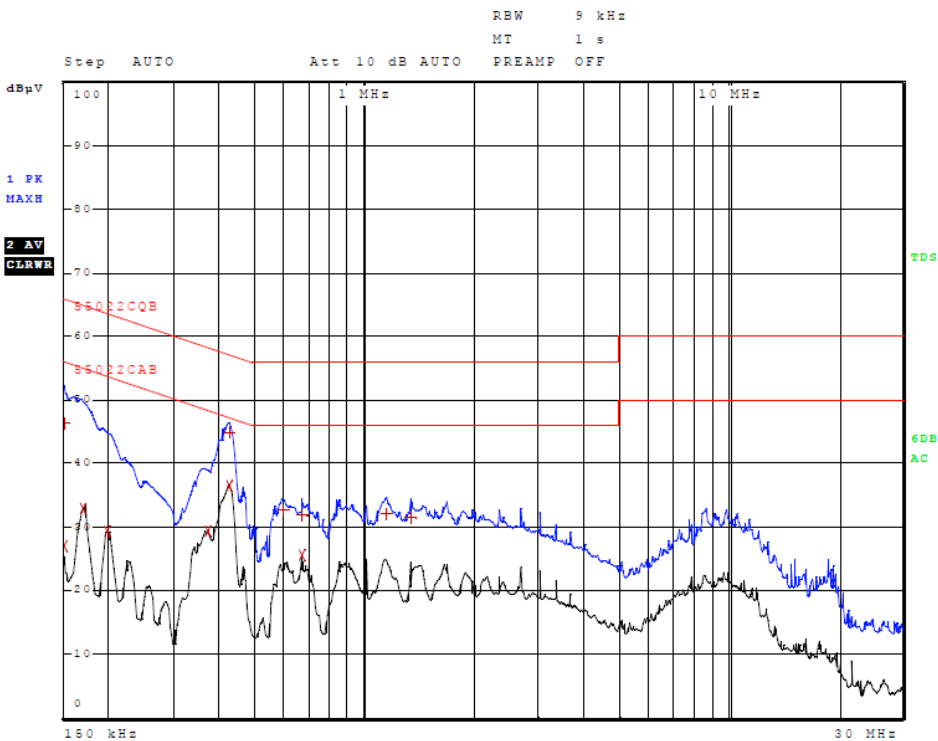

Figure 2 AC Line Conducted Emissions Line 2

Table 3 AC Line Conducted Emissions Data (Highest Emissions Line L1)

Trace	Frequency	Level (dBµV)	Detector	Delta Limit/dB
1	150.000000000 kHz	47.08	Quasi Peak	-18.92
2	170.000000000 kHz	33.17	Average	-21.79
1	182.000000000 kHz	40.68	Quasi Peak	-23.71
2	198.000000000 kHz	29.61	Average	-24.08
2	226.000000000 kHz	25.65	Average	-26.94
2	370.000000000 kHz	29.08	Average	-19.42
2	426.000000000 kHz	36.02	Average	-11.31
1	426.000000000 kHz	44.17	Quasi Peak	-13.16
1	598.000000000 kHz	32.68	Quasi Peak	-23.32
2	602.000000000 kHz	25.09	Average	-20.91
1	674.000000000 kHz	30.95	Quasi Peak	-25.05
1	1.170000000 MHz	31.07	Quasi Peak	-24.93

Other emissions present had amplitudes at least 20 dB below the limit.

Table 4 AC Line Conducted Emissions Data (Highest Emissions Line L2)

Trace	Frequency	Level (dBµV)	Detector	Delta Limit/dB
1	150.000000000 kHz	46.37	Quasi Peak	-19.63
2	150.000000000 kHz	26.90	Average	-29.10
2	170.000000000 kHz	32.91	Average	-22.05
2	198.000000000 kHz	29.34	Average	-24.36
2	370.000000000 kHz	29.25	Average	-19.25
2	422.000000000 kHz	36.54	Average	-10.87
1	422.000000000 kHz	44.87	Quasi Peak	-12.54
1	594.000000000 kHz	32.64	Quasi Peak	-23.36
2	670.000000000 kHz	25.61	Average	-20.39
1	670.000000000 kHz	31.75	Quasi Peak	-24.25
1	1.146000000 MHz	32.06	Quasi Peak	-23.94
1	1.342000000 MHz	31.34	Quasi Peak	-24.66

Other emissions present had amplitudes at least 20 dB below the limit.

Summary of Results for AC Line Conducted Emissions

The EUT test system demonstrated compliance to the conducted emissions requirements of 47CFR 15.207, RSS-247 Issue 1 and RSS-GEN. The EUT demonstrated minimum margin of -10.8 dB below the limit. Measurements were taken using the peak, quasi peak, and average, measurement function for each emissions amplitude and were below the limits stated in the specification. Other emissions were present with recorded data representing worst-case amplitudes.

General Radiated Emissions Procedure

The EUT was arranged in a typical equipment configuration and operated through all available modes with worst-case data recorded. Preliminary testing was performed in a screen room with the EUT positioned 1 meter from the FSM. Radiated emissions measurements were performed to identify the frequencies, which produced the highest emissions. Each radiated emission was then maximized at the OATS location before final radiated emissions measurements were performed. Final data was taken with the EUT located at the OATS at a distance of 3 meters between the EUT and the receiving antenna. The frequency spectrum from 9 kHz to 60,000 MHz was searched for general radiated emissions. Measured emission levels were maximized by EUT placement on the table, rotating the turntable through 360 degrees, varying the antenna height between 1 and 4 meters above the ground plane and changing antenna position between horizontal and vertical polarization. Antennas used were Loop from 9 kHz to 30 MHz, Broadband Biconical from 30 to 200 MHz, Biconilog from 30 to 1000 MHz, Log Periodic from 200 MHz to 1 GHz and or Double Ridge or pyramidal horns and mixers above 1 GHz, notch filters, and appropriate amplifiers and external mixers were utilized.

Table 5 General Radiated Emissions from EUT Data (Highest Emissions)

Frequency in MHz	Horizontal Peak (dBµV/m)	Horizontal Quasi-Peak (dBµV/m)	Horizontal Average (dBµV/m)	Vertical Peak (dBµV/m)	Vertical Quasi-Peak (dBµV/m)	Vertical Average (dBµV/m)	Limit @ 3m (dBµV/m)	Horizontal Margin (dB)	Vertical Margin (dB)
50.4	35.5	27.3	N/A	36.0	33.2	N/A	40.0	-12.7	-6.8
58.8	33.5	25.6	N/A	35.2	31.5	N/A	40.0	-14.4	-8.5
64.8	30.9	24.3	N/A	35.2	33.8	N/A	40.0	-15.7	-6.2
115.6	32.6	27.3	N/A	27.8	22.6	N/A	43.5	-16.2	-20.9
117.1	32.5	27.0	N/A	34.1	21.6	N/A	43.5	-16.5	-21.9
125.0	29.3	26.3	N/A	32.5	22.6	N/A	43.5	-17.2	-20.9
148.1	33.7	30.5	N/A	33.1	29.5	N/A	43.5	-13.0	-14.0
258.4	34.8	31.1	N/A	34.7	31.0	N/A	46.0	-14.9	-15.0
271.7	25.3	21.5	N/A	26.2	20.9	N/A	46.0	-24.5	-25.1
280.3	23.7	18.2	N/A	23.0	17.5	N/A	46.0	-27.8	-28.5
473.5	44.5	31.1	N/A	55.8	36.4	N/A	46.0	-14.9	-9.6
502.9	52.9	38.3	N/A	58.8	39.4	N/A	46.0	-7.7	-6.6
507.2	56.0	37.9	N/A	58.4	38.7	N/A	46.0	-8.1	-7.3
514.9	59.0	41.8	N/A	57.6	38.1	N/A	46.0	-4.2	-7.9
551.4	51.4	36.2	N/A	58.1	38.2	N/A	46.0	-9.8	-7.8

Other emissions present had amplitudes at least 20 dB below the limit. Peak and Quasi-Peak amplitude emissions are recorded above for frequency range below 1000 MHz. Peak and Average amplitude emissions are recorded above for frequency range above 1000 MHz.

Summary of Results for General Radiated Emissions

The EUT demonstrated compliance with the radiated emissions requirements of 47CFR part 15 and Industry Canada RSS-247 Issue 1 Intentional Radiators. The EUT demonstrated a minimum margin of -4.2 dB below the requirements. Other emissions were present with amplitudes at least 20 dB below the Limits.

Operation in the 5150-5250 and 5725-5850 MHz Frequency Band

Radiated emissions were measured on the Open Area Test Site (OATS) at a three-meter distance. Testing followed FCC KDB 789033 D02 General U-NII Test Procedures New Rules v01r02. The EUT was placed on a turntable elevated as required above the ground plane as required at a distance of 3 meters from the FSM antenna located on the OATS. The peak and quasi-peak amplitude of the frequencies below 1000 MHz were measured using a spectrum analyzer. The peak and average amplitude of emissions above 1000 MHz were measured using a spectrum analyzer. Emissions data was recorded from the measurement results. Data presented reflects measurement result corrected to account for measurement system gains and losses. Plots were made of transmitter performance for reference purposes. Refer to figures three through twenty showing plots of the EUT performance demonstrating compliance with the specifications.

This product utilizes permanently attached antenna system and offers no provision for antenna port conducted measurements. As such, the testing procedures as defined in publications ANSI C63.10-2013, KDB 789033 D02 v01r02, KDB 412172 v01r01, and KDB 662911 D01 and D02 and were utilized during compliance testing. These procedures provide for antenna port measurement or measurement of maximum field strength and conversion calculations for comparison with requirements as described in KDB 412172 D01 Determining ERP and EIRP v01r01.

1. Calculate the transmitter's peak power using the following equations:
 Measure and Sum emissions in both polarizations, convert to power based on antenna gain, and sum the power across the two polarizations.

$$P = (E * d)^2 / (30 * G)$$
 Where: E = the measured maximum field strength in V/m.
 G = the numeric gain of the transmitting antenna over an isotropic radiator.
 d = the distance in meters from which the field strength was measured.
 P = the power in watts
 Setting the RBW > 6dB bandwidth of the emission or using a peak power meter
 Measured power with power meter, summed power across both polarizations and accounting for antenna gain per KDB 662911 provided calculated output power as presented in the table below
2. Emission Bandwidth was measured in compliance with KDB 789033 II C and II D.
3. Maximum Output Power was measured in compliance with KDB 789033 II E 2 (a) and E 3.
4. Maximum Power Spectral Density was measured in compliance with KDB 789033 II F.
5. Maximum Unwanted Emissions Levels were measured in compliance with KDB 789033 II G.

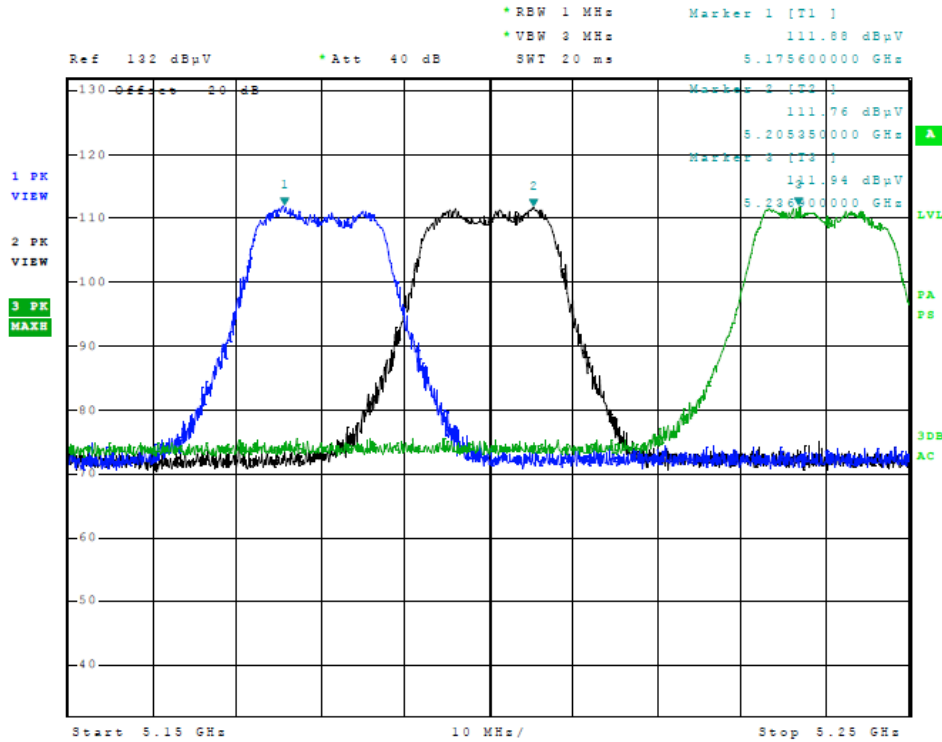

Figure 3 Plot of Transmitter Emissions (Across 5150-5250 MHz Band, 20 MHz Channel)

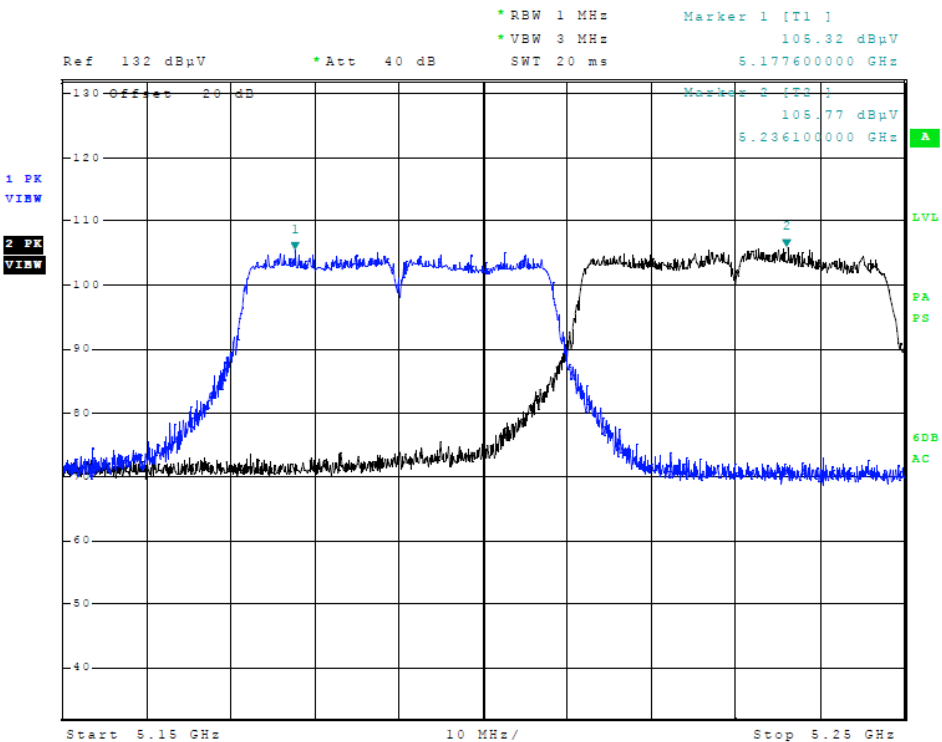

Figure 4 Plot of Transmitter Emissions (Across 5150-5250 MHz Band, 40 MHz Channel)

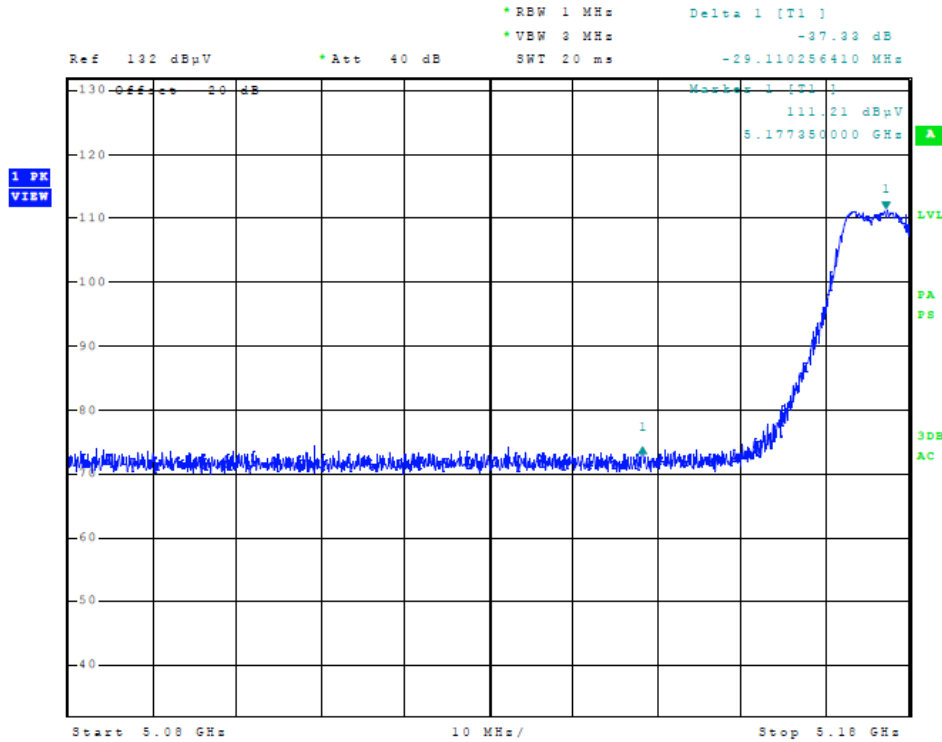

Figure 5 Plot of Transmitter Low Band Edge (5150-5250 MHz Band, 20 MHz Channel)

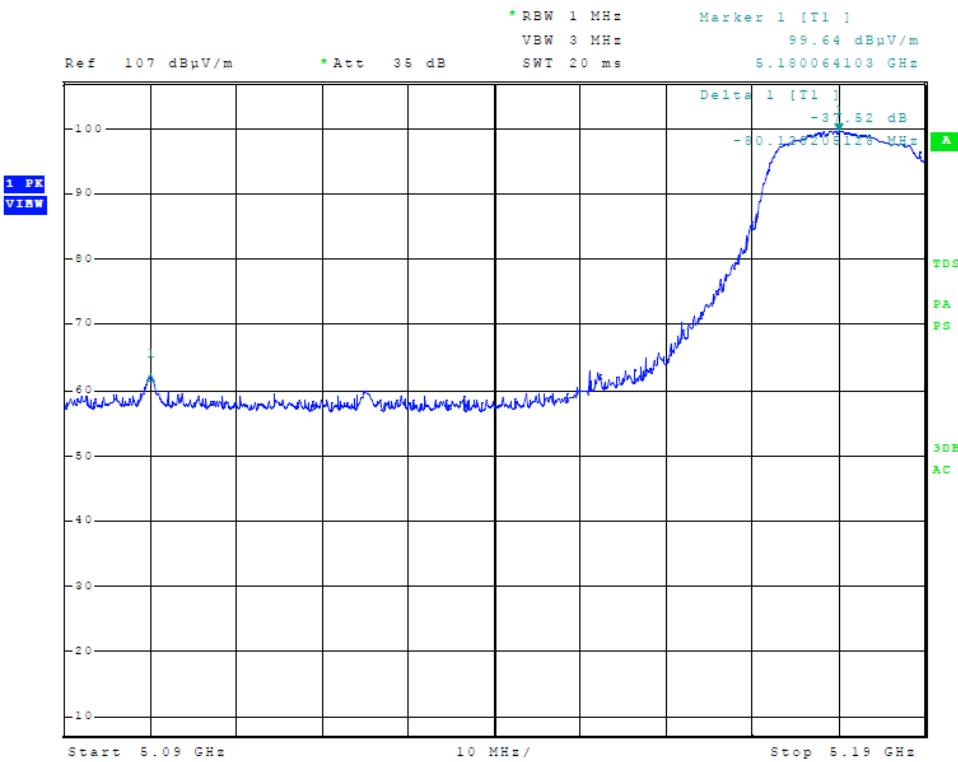

Figure 6 Plot of Transmitter Low Band Edge (5150-5250 MHz Band, 40 MHz Channel)

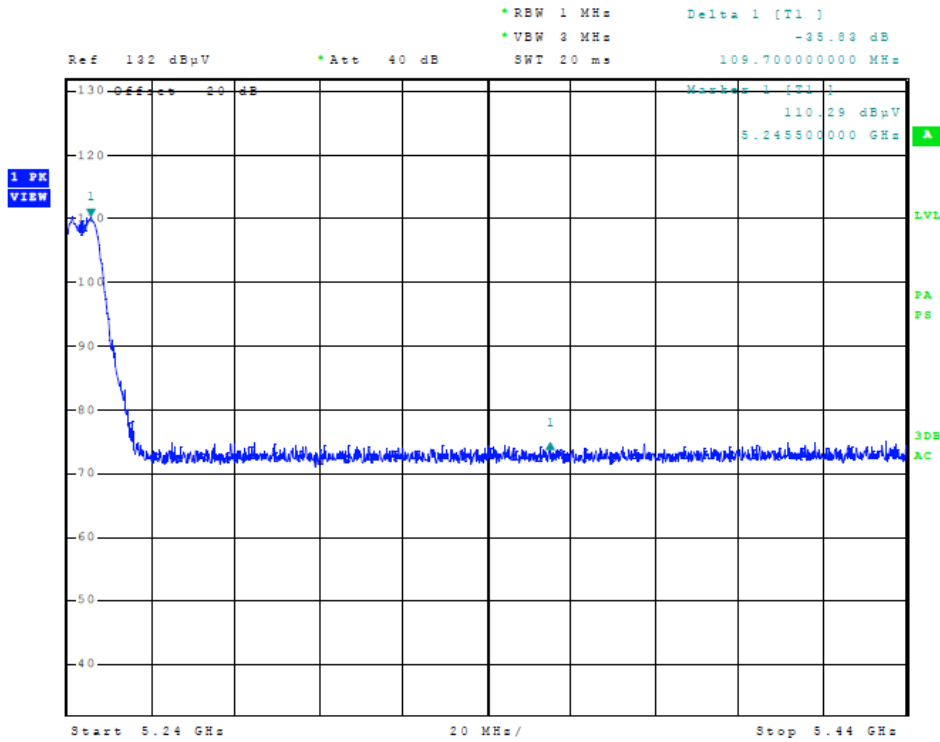

Figure 7 Plot of Transmitter High Band Edge (5150-5250 MHz Band, 20 MHz Channel)

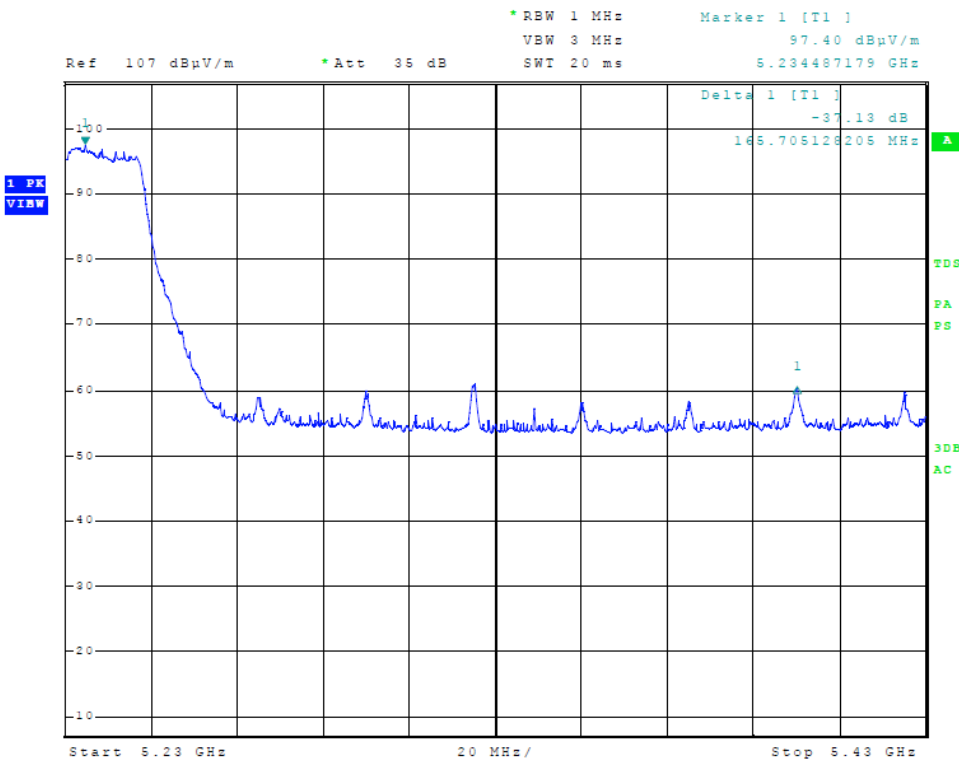

Figure 8 Plot of Transmitter High Band Edge (5150-5250 MHz Band, 40 MHz Channel)

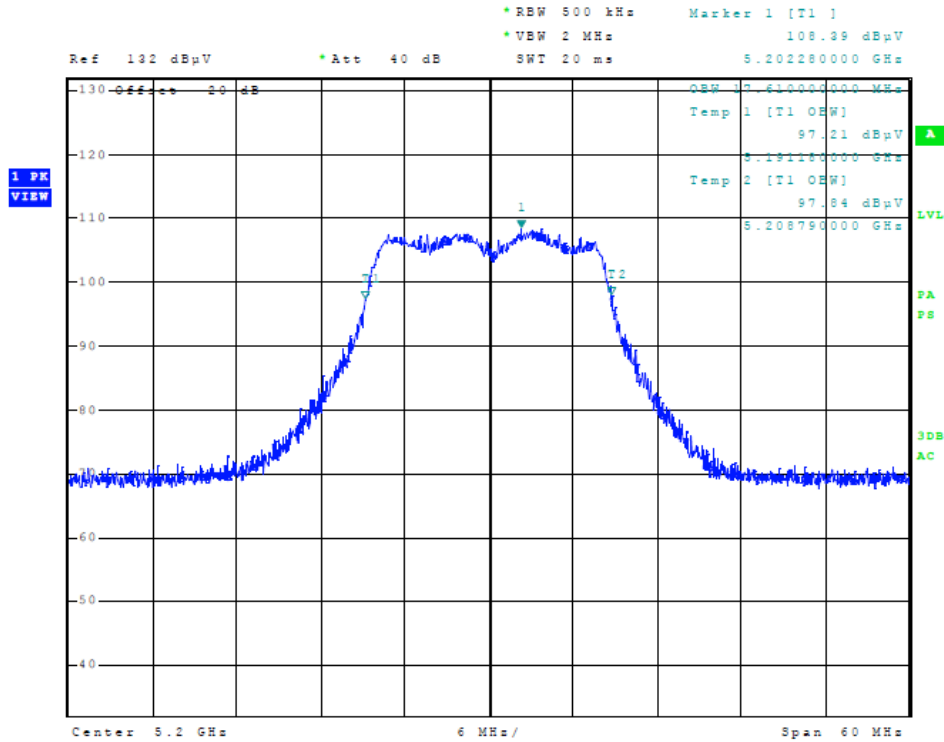

Figure 9 Plot of Transmitter Emissions (5150-5250 MHz Band, 20 MHz Channel, 99% OBW)

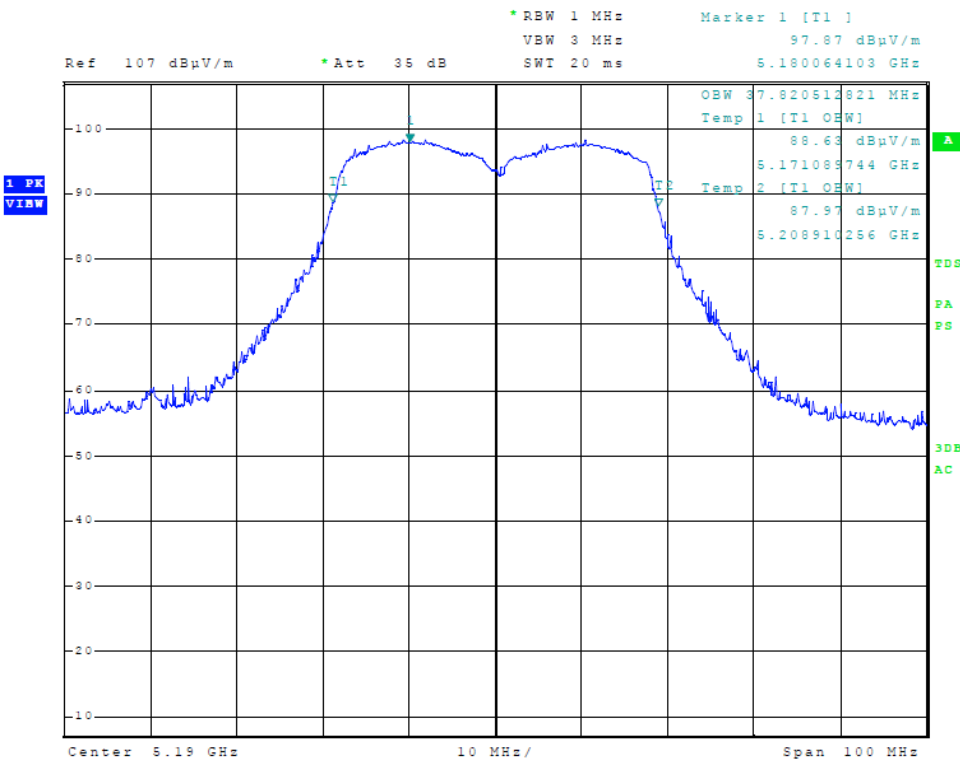

Figure 10 Plot of Transmitter Emissions (5150-5250 MHz Band, 40 MHz Channel, 99% OBW)

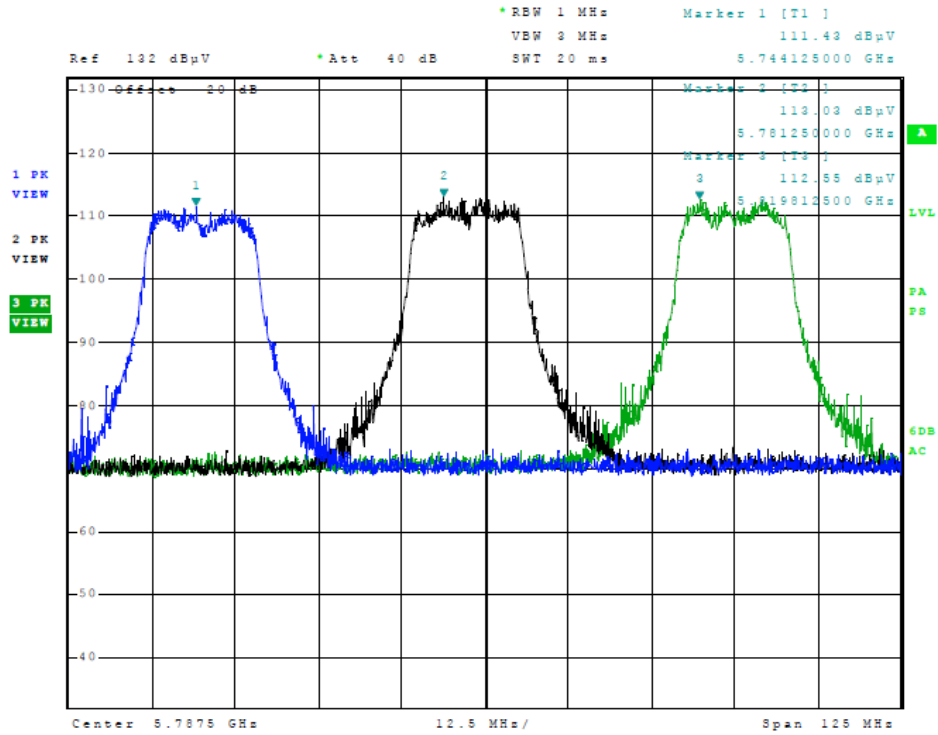

Figure 11 Plot of Transmitter Emissions (Across 5725-5850 MHz Band, 20 MHz Channel)

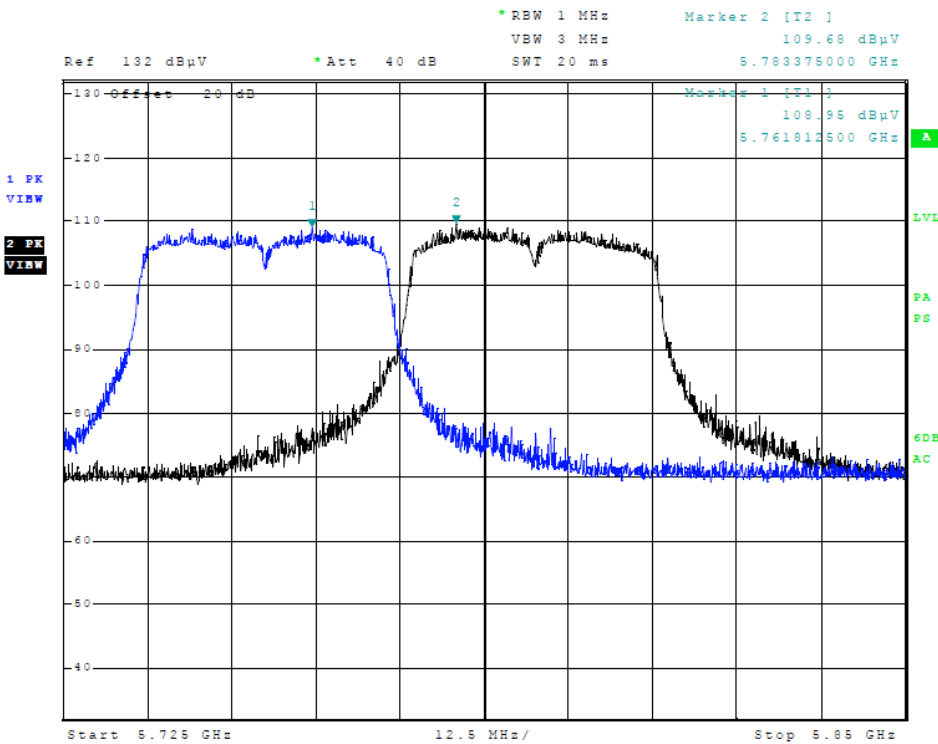

Figure 12 Plot of Transmitter Emissions (Across 5725-5850 MHz Band, 40 MHz Channel)

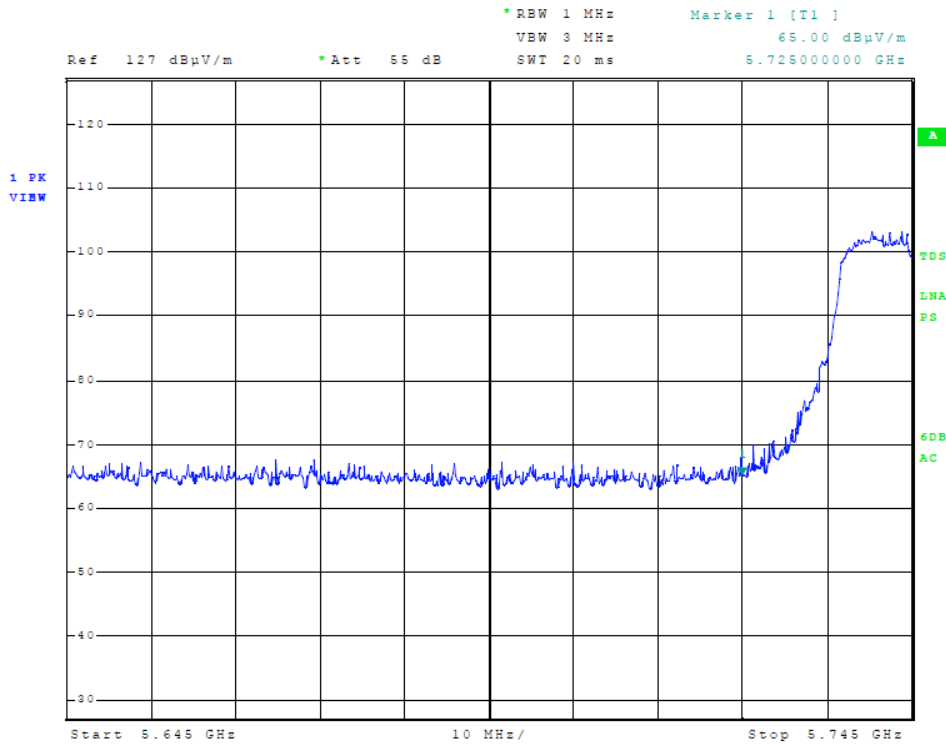

Figure 13 Plot of Transmitter Low Band Edge (5725-5850 MHz Band, 20 MHz Channel)

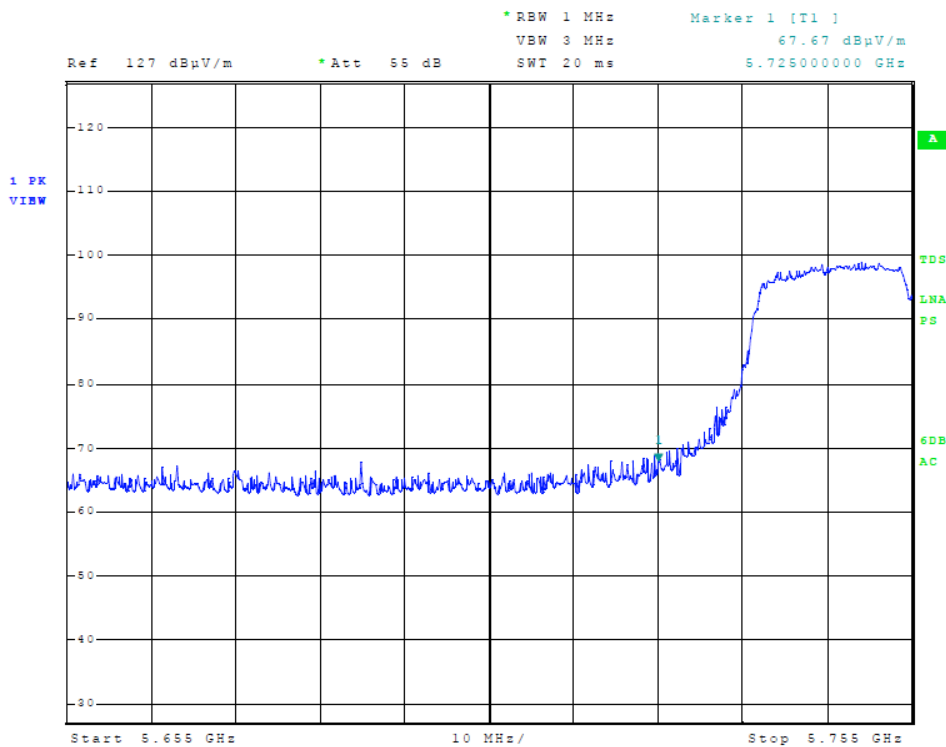

Figure 14 Plot of Transmitter Low Band Edge (5725-5850 MHz Band, 40 MHz Channel)

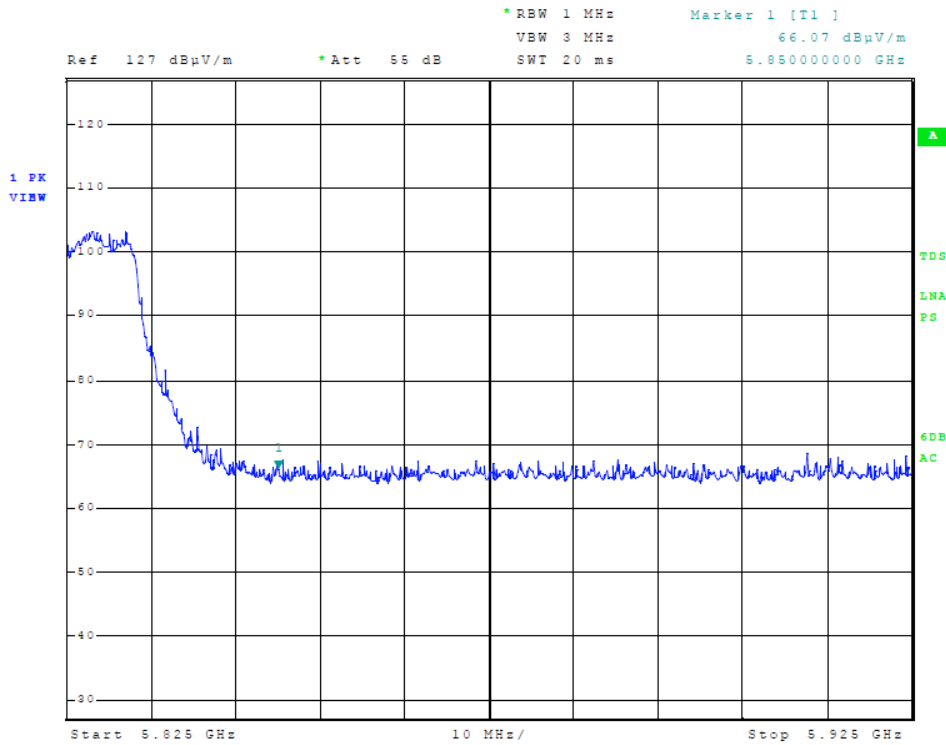

Figure 15 Plot of Transmitter High Band Edge (5725-5850 MHz Band, 20 MHz Channel)

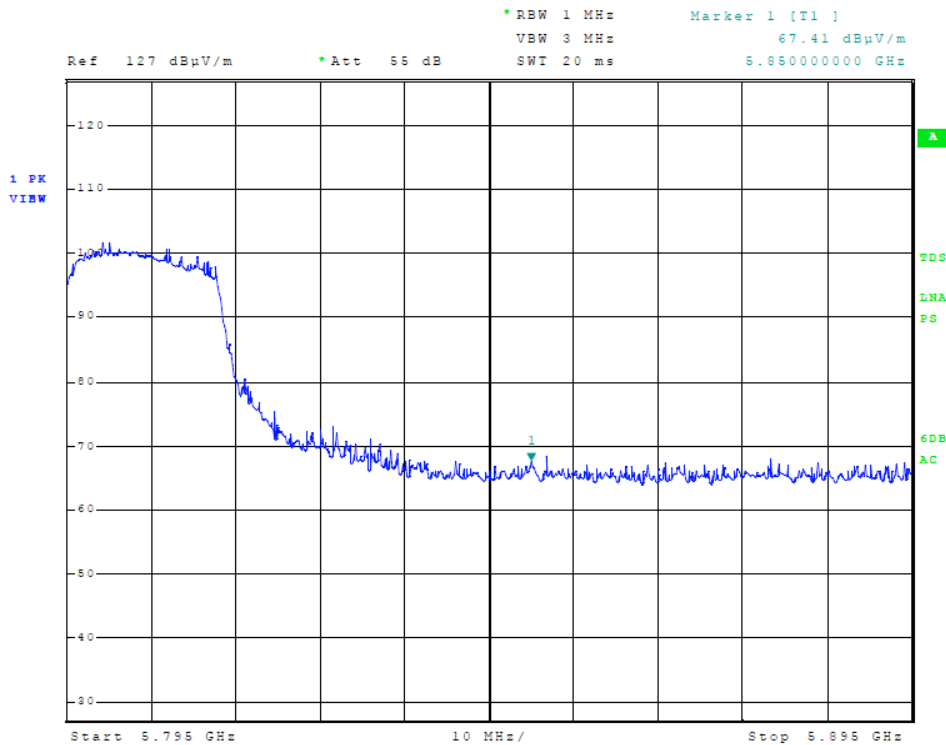

Figure 16 Plot of Transmitter High Band Edge (5725-5850 MHz Band, 40 MHz Channel)

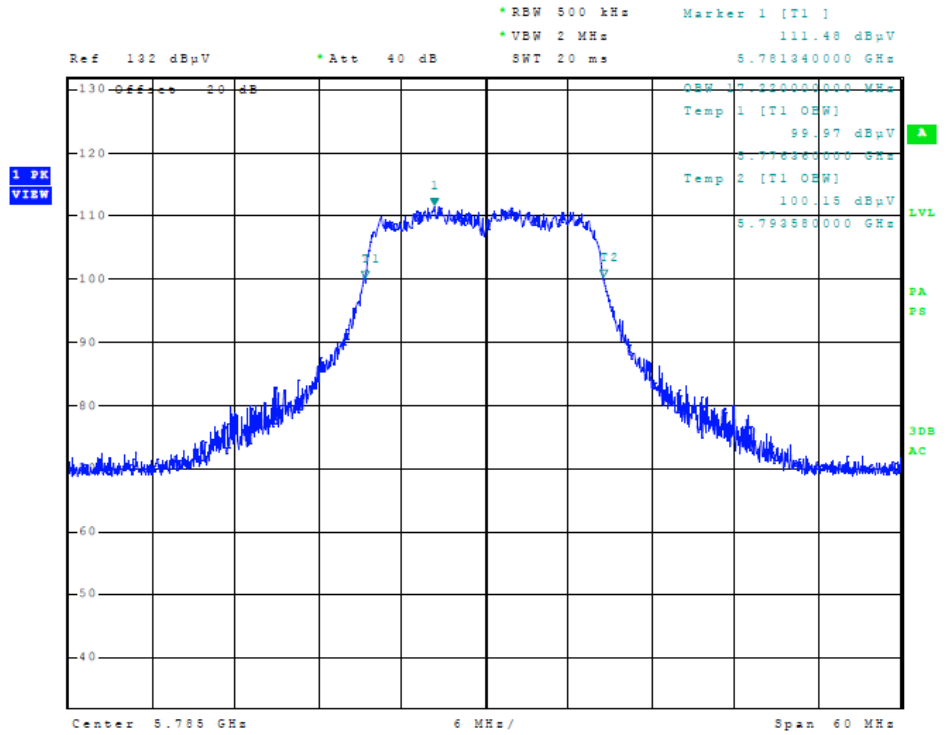

Figure 17 Plot of Transmitter Emissions (5725-5850 MHz Band, 20 MHz Channel, 99% OBW)

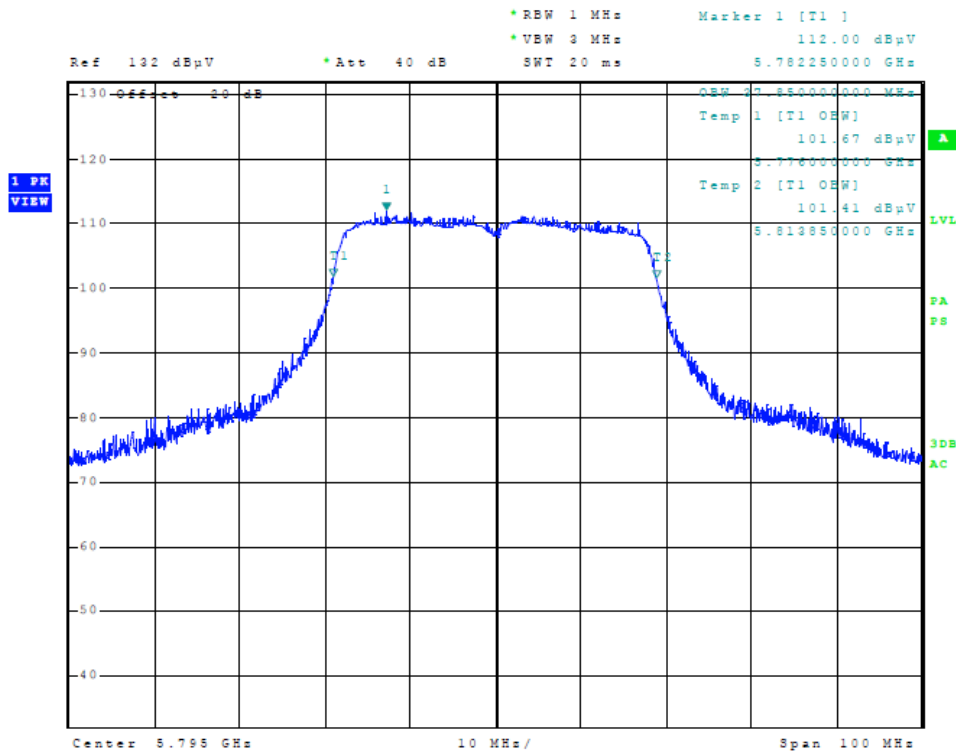

Figure 18 Plot of Transmitter Emissions (5725-5850 MHz Band, 40 MHz Channel, 99% OBW)

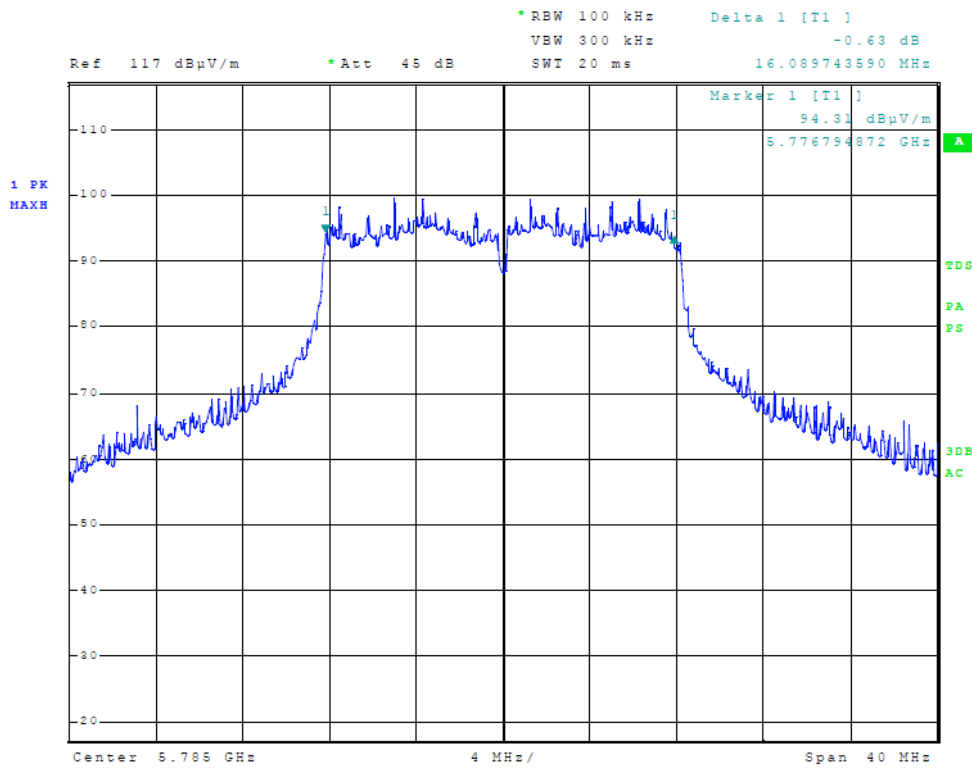

Figure 19 Plot of Transmitter Emissions (5725-5850 MHz Band, 20 MHz Channel, 6-dB OBW)

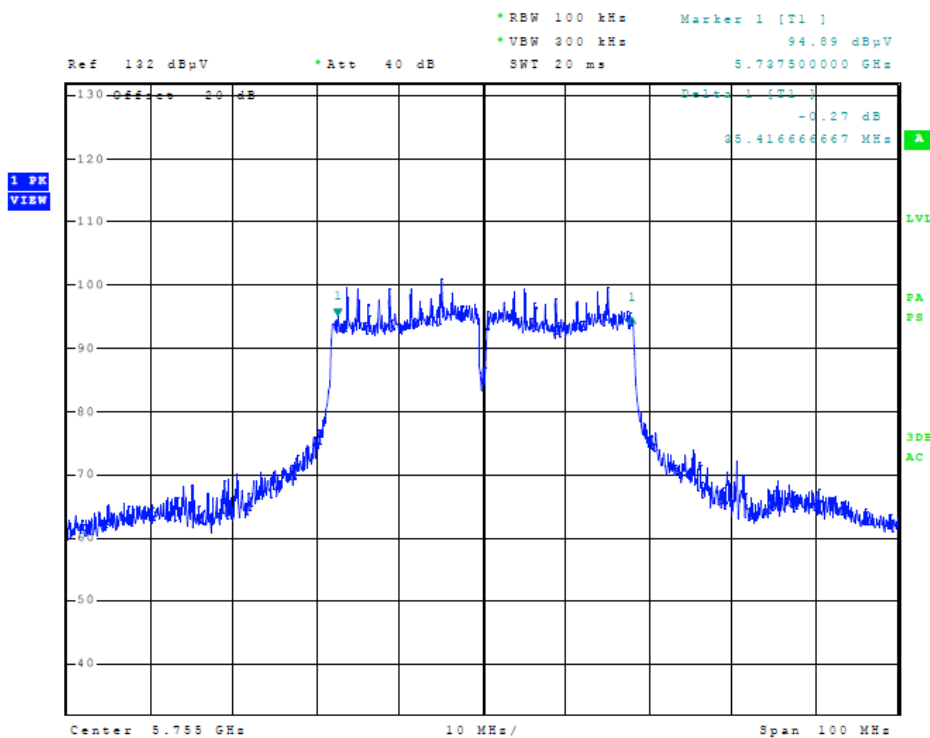

Figure 20 Plot of Transmitter Emissions (5725-5850 MHz Band, 40 MHz Channel, 6-dB OBW)

Transmitter Emissions Data

Table 6 Transmitter Radiated Emission (5150-5250 MHz Band, 802.11a, 20 MHz Channel)

Frequency in MHz	Horizontal Peak (dB μ V/m)	Horizontal Average (dB μ V/m)	Vertical Peak (dB μ V/m)	Vertical Average (dB μ V/m)	Limit @ 3m (dB μ V/m)	Horizontal Margin	Vertical Margin
5180.0	114.5	99.4	116.2	100.4	--		
10360.0	49.0	36.1	48.7	36.1	68.3	-32.2	-32.2
15540.0	54.2	40.8	53.2	40.8	68.3	-27.5	-27.5
20720.0	50.8	37.8	51.4	37.8	68.3	-30.6	-30.6
25900.0	52.0	38.9	51.7	38.5	68.3	-29.4	-29.8
5200.0	113.9	97.5	116.8	102.1	--		
10400.0	48.1	35.4	48.1	35.4	68.3	-32.9	-32.9
15600.0	53.5	40.7	53.3	40.7	68.3	-27.6	-27.6
20800.0	50.4	37.4	50.5	37.4	68.3	-31.0	-31.0
26000.0	53.0	40.1	53.0	40.1	68.3	-28.2	-28.2
5240.0	115.3	99.7	115.5	99.5	--		
10480.0	48.9	35.8	48.9	36.0	68.3	-32.5	-32.3
15720.0	54.3	42.0	54.6	41.9	68.3	-26.3	-26.4
20960.0	49.9	37.3	50.0	37.2	68.3	-31.1	-31.2
26200.0	53.9	40.8	53.5	40.8	68.3	-27.5	-27.5

Other emissions present had amplitudes at least 20 dB below the limit. Peak and Quasi-Peak amplitude emissions are recorded above for frequency range of 30-1000 MHz. Peak and Average amplitude emissions are recorded above for frequency range above 1000 MHz.

Table 7 Transmitter Radiated Emission (5725-5850 MHz Band, 802.11a, 20 MHz Channel)

Frequency in MHz	Horizontal Peak (dBµV/m)	Horizontal Average (dBµV/m)	Vertical Peak (dBµV/m)	Vertical Average (dBµV/m)	Limit @ 3m (dBµV/m)	Horizontal Margin	Vertical Margin
5745.0	115.3	102.7	116.5	98.5	--		
11490.0	49.5	36.4	49.4	36.4	68.3	-31.9	-31.9
17235.0	56.5	43.6	56.7	43.6	68.3	-24.7	-24.7
22980.0	50.5	37.8	50.9	37.3	68.3	-30.5	-31.0
28725.0	54.6	41.5	55.0	41.5	68.3	-26.8	-26.8
5785.0	115.2	103.8	116.9	100.0	--		
11570.0	49.9	36.5	49.7	36.6	68.3	-31.8	-31.7
17355.0	57.1	44.4	57.3	44.4	68.3	-23.9	-23.9
23140.0	52.3	39.2	52.5	39.2	68.3	-29.1	-29.1
28925.0	55.6	42.6	56.2	42.6	68.3	-25.7	-25.7
5825.0	115.5	103.2	116.0	99.0	--		
11650.0	49.6	36.6	49.7	36.6	68.3	-31.7	-31.7
17475.0	56.4	43.6	57.1	43.7	68.3	-24.7	-24.6
23300.0	51.0	38.1	51.0	38.1	68.3	-30.2	-30.2
29125.0	55.3	41.6	55.0	41.6	68.3	-26.7	-26.7
Band edge Compliance							
5725	65.0	--	64.7	--	68.3	-3.30	-3.60
5850	66.1	--	65.8	--	68.3	-2.20	-2.50

Other emissions present had amplitudes at least 20 dB below the limit. Peak and Quasi-Peak amplitude emissions are recorded for frequency below 1000 MHz. Peak and Average amplitude emissions are recorded for frequency range above 1000 MHz.

Table 8 Transmitter Radiated Emission (5150-5250 MHz Band, 802.11n, 20 MHz Channel)

Frequency in MHz	Horizontal Peak (dBµV/m)	Horizontal Average (dBµV/m)	Vertical Peak (dBµV/m)	Vertical Average (dBµV/m)	Limit @ 3m (dBµV/m)	Horizontal Margin	Vertical Margin
5180.0	114.3	99.4	116.1	100.3	--		
10360.0	48.8	35.5	47.6	35.3	68.3	-32.8	-33.0
15540.0	53.1	39.7	52.0	39.6	68.3	-28.6	-28.7
20720.0	49.5	36.7	49.6	36.7	68.3	-31.6	-31.6
25900.0	50.6	37.7	50.7	37.7	68.3	-30.6	-30.6
5200.0	113.8	97.5	116.5	100.1	--		
10400.0	46.9	34.4	46.9	34.3	68.3	-33.9	-34.0
15600.0	52.3	39.6	52.2	39.6	68.3	-28.7	-28.7
20800.0	50.3	37.4	50.4	37.4	68.3	-31.0	-31.0
26000.0	51.6	39.0	51.4	39.1	68.3	-29.3	-29.2
5240.0	113.8	99.3	116.0	98.8	--		
10480.0	48.7	35.0	47.9	35.5	68.3	-33.3	-32.8
15720.0	53.1	41.0	53.1	41.0	68.3	-27.3	-27.3
20960.0	50.0	37.3	50.2	37.2	68.3	-31.1	-31.2
26200.0	51.8	40.4	52.1	40.4	68.3	-27.9	-27.9

Other emissions present had amplitudes at least 20 dB below the limit. Peak and Quasi-Peak amplitude emissions are recorded above for frequency range of 30-1000 MHz. Peak and Average amplitude emissions are recorded above for frequency range above 1000 MHz.

Table 9 Transmitter Radiated Emission (5725-5850 MHz Band, 802.11n, 20 MHz Channel)

Frequency in MHz	Horizontal Peak (dBµV/m)	Horizontal Average (dBµV/m)	Vertical Peak (dBµV/m)	Vertical Average (dBµV/m)	Limit @ 3m (dBµV/m)	Horizontal Margin	Vertical Margin
5745.0	116.7	102.6	116.5	102.0	--		
11490.0	48.8	35.9	48.5	36.1	68.3	-32.4	-32.2
17235.0	55.6	43.2	56.3	43.5	68.3	-25.1	-24.8
22980.0	50.6	37.7	50.8	37.2	68.3	-30.6	-31.1
28725.0	54.5	41.3	54.9	41.4	68.3	-27.0	-26.9
5785.0	116.1	103.3	116.8	101.9	--		
11570.0	49.6	36.0	49.6	36.5	68.3	-32.3	-31.8
17355.0	57.0	44.2	57.3	43.6	68.3	-24.1	-24.7
23140.0	52.2	39.1	52.4	39.1	68.3	-29.2	-29.2
28925.0	55.1	41.4	55.2	41.6	68.3	-26.9	-26.7
5825.0	116.5	103.1	116.4	101.8	--		
11650.0	49.5	35.9	49.3	36.0	68.3	-32.4	-32.3
17475.0	56.1	43.2	56.8	43.2	68.3	-25.1	-25.1
23300.0	50.8	38.0	50.9	38.0	68.3	-30.3	-30.3
29125.0	54.9	41.4	54.8	41.5	68.3	-26.9	-26.8
Band edge Compliance							
5725	63.5	--	61.6	--	68.3	-4.8	-6.7
5850	64.3	--	60.6	--	68.3	-4.0	-7.6

Other emissions present had amplitudes at least 20 dB below the limit. Peak and Quasi-Peak amplitude emissions are recorded for frequency below 1000 MHz. Peak and Average amplitude emissions are recorded for frequency range above 1000 MHz.

Table 10 Transmitter Radiated Emission (5180-5250 MHz Band, 802.11n, 40 MHz Channel)

Frequency in MHz	Horizontal Peak (dBµV/m)	Horizontal Average (dBµV/m)	Vertical Peak (dBµV/m)	Vertical Average (dBµV/m)	Limit @ 3m (dBµV/m)	Horizontal Margin	Vertical Margin
5190.0	114.9	100.1	115.9	100.9	--		
10380.0	48.1	35.1	48.3	35.2	68.3	-33.2	-33.1
15570.0	54.1	41.1	53.6	40.9	68.3	-27.2	-27.4
20760.0	50.6	37.6	50.9	37.9	68.3	-30.8	-30.5
25950.0	51.2	38.4	51.1	38.6	68.3	-29.9	-29.7
5230.0	114.6	100.3	115.8	100.5	--		
10460.0	48.2	35.7	48.4	35.5	68.3	-32.6	-32.8
15690.0	53.3	41.0	53.6	40.8	68.3	-27.3	-27.5
20920.0	49.9	37.9	50.4	37.8	68.3	-30.5	-30.6
26150.0	51.5	40.5	52.2	40.4	68.3	-27.8	-27.9

Other emissions present had amplitudes at least 20 dB below the limit. Peak and Quasi-Peak amplitude emissions are recorded for frequency below 1000 MHz. Peak and Average amplitude emissions are recorded for frequency range above 1000 MHz.

Table 11 Transmitter Radiated Emission (5725-5850 MHz Band, 802.11n, 40 MHz Channel)

Frequency in MHz	Horizontal Peak (dBµV/m)	Horizontal Average (dBµV/m)	Vertical Peak (dBµV/m)	Vertical Average (dBµV/m)	Limit @ 3m (dBµV/m)	Horizontal Margin	Vertical Margin
5755.0	115.2	101.9	116.0	98.0	--		
11510.0	50.0	37.0	50.1	36.9	68.3	-31.3	-31.4
17265.0	56.3	43.7	56.5	43.3	68.3	-24.6	-25.0
23020.0	50.3	37.7	50.7	37.4	68.3	-30.6	-30.9
28775.0	52.8	41.3	53.0	41.4	68.3	-27.0	-26.9
5795.0	116.0	102.8	116.6	99.5	--		
11590.0	49.7	36.3	48.7	36.5	68.3	-32.0	-31.8
17385.0	55.7	42.7	56.1	43.5	68.3	-25.6	-24.8
23180.0	50.8	37.9	50.9	38.0	68.3	-30.4	-30.3
28975.0	52.3	41.4	53.0	41.5	68.3	-26.9	-26.8
Band edge Compliance							
5725	64.5	--	62.7	--	68.3	-3.80	-5.60
5850	64.4	--	62.6	--	68.3	-3.90	-5.70

Other emissions present had amplitudes at least 20 dB below the limit. Peak and Quasi-Peak amplitude emissions are recorded for frequency below 1000 MHz. Peak and Average amplitude emissions are recorded for frequency range above 1000 MHz.

Table 12 Transmitter Power and Emissions Chain 0

Frequency MHz	Calculated Conducted Antenna Port Output Total (Watts)	99% Occupied Bandwidth kHz	Calculated Power Spectral Density dBm
20 MHz Mode 802.11a (US operation)			
5180	0.00034	17,610.0	-2.30 dBm/1MHz
5200	0.00029	17,610.0	-1.11 dBm/1MHz
5240	0.00040	17,610.0	-3.50 dBm/1MHz
20 MHz Mode 802.11a			
5745	0.00040	17,220.0	-0.85 dBm/500kHz
5785	0.00040	17,220.0	0.20 dBm/500kHz
5825	0.00042	17,220.0	-2.12 dBm/500kHz
20 MHz Mode 802.11n (US operation)			
5180	0.00032	17,600.0	0.95 dBm/1MHz
5200	0.00029	17,600.0	0.80 dBm/1MHz
5240	0.00029	17,600.0	0.80 dBm/1MHz
20 MHz Mode 802.11n			
5745	0.00056	17,220.0	0.40 dBm/500kHz
5785	0.00049	17,220.0	0.35 dBm/500kHz
5825	0.00053	17,220.0	0.46 dBm/500kHz
40 MHz Mode 802.11n (US operation)			
5190	0.00037	37,820.0	-3.75 dBm/1MHz
5230	0.00034	37,820.0	-2.60 dBm/1MHz
40 MHz Mode 802.11n			
5755	0.00040	37,850.0	-2.55 dBm/500kHz
5795	0.00048	37,850.0	-0.50 dBm/500kHz

Table 13 Transmitter Power and Emissions Chain 1

Frequency MHz	Calculated Conducted Antenna Port Output Total (Watts)	99% Occupied Bandwidth kHz	Calculated Power Spectral Density dBm
20 MHz Mode 802.11a (US operation)			
5180	0.00050	17,610.0	0.95 dBm/1MHz
5200	0.00057	17,610.0	0.80 dBm/1MHz
5240	0.00040	17,610.0	0.80 dBm/1MHz
20 MHz Mode 802.11a			
5745	0.00053	17,220.0	2.40 dBm/500kHz
5785	0.00093	17,220.0	2.11dBm/500kHz
5825	0.00075	17,220.0	2.18 dBm/500kHz
20 MHz Mode 802.11n (US operation)			
5180	0.00049	17,610.0	0.95 dBm/1MHz
5200	0.00053	17,610.0	0.80 dBm/1MHz
5240	0.00048	17,610.0	0.80 dBm/1MHz
20 MHz Mode 802.11n			
5745	0.00053	17,220.0	0.40 dBm/500kHz
5785	0.00057	17,220.0	0.35 dBm/500kHz
5825	0.00052	17,220.0	0.46 dBm/500kHz
40 MHz Mode 802.11n (US operation)			
5190	0.00046	37,820.0	-0.50 dBm/1MHz
5230	0.00045	37,820.0	-0.69 dBm/1MHz
40 MHz Mode 802.11n			
5755	0.00048	37,850.0	-0.70 dBm/500kHz
5795	0.00055	37,850.0	-1.41 dBm/500kHz

Table 14 Transmitter Power and Emissions Both Chains Active

Frequency MHz	Calculated Conducted Antenna Port Output Total (Watts)	99% Occupied Bandwidth kHz	Calculated Power Spectral Density
20 MHz Mode 802.11a (US operation)			
5180	0.001	17,610.0	4.95 dBm/1MHz
5200	0.001	17,610.0	4.89 dBm/1MHz
5240	0.001	17,610.0	4.92 dBm/1MHz
20 MHz Mode 802.11a			
5745	0.001	17,220.0	6.40 dBm/500kHz
5785	0.001	17,220.0	6.20 dBm/500kHz
5825	0.001	17,220.0	6.30 dBm/500kHz
20 MHz Mode 802.11n (US operation)			
5180	0.001	17,610.0	4.95 dBm/1MHz
5200	0.001	17,610.0	4.89 dBm/1MHz
5240	0.001	17,610.0	4.92 dBm/1MHz
20 MHz Mode 802.11n			
5745	0.001	17,220.0	6.40 dBm/500kHz
5785	0.001	17,220.0	6.20 dBm/500kHz
5825	0.001	17,220.0	6.30 dBm/500kHz
40 MHz Mode 802.11n (US operation)			
5190	0.001	37,820.0	3.50 dBm/1MHz
5230	0.001	37,820.0	3.40 dBm/1MHz
40 MHz Mode 802.11n			
5755	0.001	37,850.0	4.70 dBm/500kHz
5795	0.001	37,850.0	5.50 dBm/500kHz

Measurement of emission at elevation angle higher than 30° from horizon

The parabolic dish antenna pattern information has been provided with the filing information as required. The design utilizes fixed infrastructure, which is not mechanically, or electrically steerable beam forming.

Summary of Results for Transmitter Radiated Emissions of Intentional Radiator

The EUT demonstrated compliance with the radiated emissions requirements of 47CFR Part 15.407 and Industry Canada RSS-247. The calculated peak power delivered into the antenna port was 0.001-Watt total power. The minimum harmonic radiated emission margin provided -23.9 dB margin below requirements. General radiated emissions of supporting equipment provided -4.2 dB margin. There were no other significantly measurable emissions in the restricted bands other than those recorded in this report. Other emissions were present with amplitudes at least 20 dB below the requirements. There were no other deviations or exceptions to the requirements.

Statement of Modifications and Deviations

No modifications to the EUT were required for the unit to demonstrate compliance with the 47CFR Part 15C and Industry Canada RSS-247 emissions requirements. There were no deviations or modifications to the specifications.

Annex

- Annex A Measurement Uncertainty Calculations
- Annex B Rogers Labs Test Equipment List
- Annex C Rogers Qualifications
- Annex D FCC Site Registration Letter
- Annex E Industry Canada Site Registration Letter

Annex A Measurement Uncertainty Calculations

Measurement uncertainty calculations were made for the laboratory. Result of measurement uncertainty calculations are recorded below for AC line conducted and radiated emission measurements.

Measurement Uncertainty	$U_{(E)}$	$U_{(lab)}$
3 Meter Horizontal 30-200 MHz Measurements	2.08	4.16
3 Meter Vertical 30-200 MHz Measurements	2.16	4.33
3 Meter Vertical Measurements 200-1000 MHz	2.99	5.97
10 Meter Horizontal Measurements 30-200 MHz	2.07	4.15
10 Meter Vertical Measurements 30-200 MHz	2.06	4.13
10 Meter Horizontal Measurements 200-1000 MHz	2.32	4.64
10 Meter Vertical Measurements 200-1000 MHz	2.33	4.66
3 Meter Measurements 1-6 GHz	2.57	5.14
3 Meter Measurements 6-18 GHz	2.58	5.16
AC Line Conducted	1.72	3.43

Annex B Rogers Labs Test Equipment List

List of Test Equipment	Calibration	Date	Due
Spectrum Analyzer: Rohde & Schwarz ESU40		5/15	5/16
Spectrum Analyzer: HP 8562A, HP Adapters: 11518, 11519, and 11520		5/15	5/16
Mixers: 11517A, 11970A, 11970K, 11970U, 11970V, 11970W			
Spectrum Analyzer: HP 8591EM		5/15	5/16
Antenna: EMCO Biconilog Model: 3143		5/15	5/16
Antenna: Sunol Biconilog Model: JB6		10/15	10/16
Antenna: EMCO Log Periodic Model: 3147		10/15	10/16
Antenna: Com Power Model: AH-118		10/15	10/16
Antenna: Com Power Model: AH-840		5/15	5/17
Antenna: Antenna Research Biconical Model: BCD 235		10/15	10/16
Antenna: EMCO 6509		10/15	10/16
LISN: Compliance Design Model: FCC-LISN-2.Mod.cd, 50 µHy/50 ohm/0.1 µf		10/15	10/16
R.F. Preamp CPPA-102		10/15	10/16
Attenuator: HP Model: HP11509A		10/15	10/16
Attenuator: Mini Circuits Model: CAT-3		10/15	10/16
Attenuator: Mini Circuits Model: CAT-3		10/15	10/16
Cable: Belden RG-58 (L1)		10/15	10/16
Cable: Belden RG-58 (L2)		10/15	10/16
Cable: Belden 8268 (L3)		10/15	10/16
Cable: Time Microwave: 4M-750HF290-750		10/15	10/16
Cable: Time Microwave: 10M-750HF290-750		10/15	10/16
Frequency Counter: Leader LDC825		2/16	2/17
Oscilloscope Scope: Tektronix 2230		2/16	2/17
Wattmeter: Bird 43 with Load Bird 8085		2/16	2/17
Power Supplies: Sorensen SRL 20-25, SRL 40-25, DCR 150, DCR 140		2/16	2/17
R.F. Generators: HP 606A, HP 8614A, HP 8640B		2/16	2/17
R.F. Power Amp 65W Model: 470-A-1010		2/16	2/17
R.F. Power Amp 50W M185- 10-501		2/16	2/17
R.F. Power Amp A.R. Model: 10W 1010M7		2/16	2/17
R.F. Power Amp EIN Model: A301		2/16	2/17
LISN: Compliance Eng. Model 240/20		2/16	2/17
LISN: Fischer Custom Communications Model: FCC-LISN-50-16-2-08		2/16	2/17
Antenna: EMCO Dipole Set 3121C		2/16	2/17
Antenna: C.D. B-101		2/16	2/17
Antenna: Solar 9229-1 & 9230-1		2/16	2/17
Audio Oscillator: H.P. 201CD		2/16	2/17
ELGAR Model: 1751		2/16	2/17
ELGAR Model: TG 704A-3D		2/16	2/17
ESD Test Set 2010i		2/16	2/17
Fast Transient Burst Generator Model: EFT/B-101		2/16	2/17
Field Intensity Meter: EFM-018		2/16	2/17
KEYTEK Ecat Surge Generator		2/16	2/17
Shielded Room 5 M x 3 M x 3.0 M			

Annex C Rogers Qualifications

Scot D. Rogers, Engineer

Rogers Labs, Inc.

Mr. Rogers has approximately 17 years' experience in the field of electronics. Engineering experience includes six years in the automated controls industry and remaining years working with the design, development and testing of radio communications and electronic equipment.

Positions Held

Systems Engineer: A/C Controls Mfg. Co., Inc. 6 Years

Electrical Engineer: Rogers Consulting Labs, Inc. 5 Years

Electrical Engineer: Rogers Labs, Inc. Current

Educational Background

- 1) Bachelor of Science Degree in Electrical Engineering from Kansas State University.
- 2) Bachelor of Science Degree in Business Administration Kansas State University.
- 3) Several Specialized Training courses and seminars pertaining to Microprocessors and Software programming.

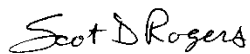

Scot D. Rogers



Annex D FCC Site Registration Letter

FEDERAL COMMUNICATIONS COMMISSION

**Laboratory Division
7435 Oakland Mills Road
Columbia, MD 21046**

April 16, 2015

Registration Number: 90910

Rogers Labs, Inc.
4405 West 259th Terrace
Louisburg, KS 66053

Attention: Scot Rogers,

Re: Measurement facility located at Louisburg
3 & 10 meter site
Date of Renewal: April 16, 2015

Dear Sir or Madam:

Your request for renewal of the registration of the subject measurement facility has been received. The information submitted has been placed in your file and the registration has been renewed. The name of your organization will remain on the list of facilities whose measurement data will be accepted in conjunction with applications for Certification under Parts 15 or 18 of the Commission's Rules. Please note that the file must be updated for any changes made to the facility and the registration must be renewed at least every three years.

Measurement facilities that have indicated that they are available to the public to perform measurement services on a fee basis may be found on the FCC website www.fcc.gov under E-Filing, OET Equipment Authorization Electronic Filing, Test Firms.

Sincerely,

Phyllis Parrish
Industry Analyst



NVLAP Lab Code 200087-0

Annex E Industry Canada Site Registration Letter

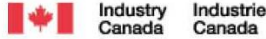

June 08, 2015

OUR FILE: 46405-3041
Authorization No: 010277847-001

Rogers Labs Inc.
4405 West 259th Terrace
Louisburg, KS
USA
66053

Attention: Mr. Scot D. Rogers

Dear Sir:

The Bureau has received your application for the renewal of 3m OATS. Be advised that the information received was satisfactory to Industry Canada. The following number(s) is now associated to the site(s) for which registration / renewal was sought (**Site# 3041A-1**). Please reference the appropriate site number in the body of test reports containing measurements performed on the site. In addition, please keep for your records the following information;

- The company address code associated to the site(s) located at the above address is: **3041A**

Furthermore, to obtain or renew a unique site number, the applicant shall demonstrate that the site has been accredited to ANSI C63.4-2009 or later. A scope of accreditation indicating the accreditation by a recognized accreditation body to ANSI C63.4-2009 or later shall be accepted. Please indicate in a letter the previous assigned site number if applicable and the type of site (example: 3 metre OATS or 3 metre chamber). If the test facility is not accredited to ANSI C63.4-2009 or later, the test facility shall submit test data demonstrating full compliance with the ANSI standard. The Bureau will evaluate the filing to determine if recognition shall be granted.

The frequency for re-validation of the test site and the information that is required to be filed or retained by the testing party shall comply with the requirements established by the accrediting organization. However, in all cases, test site re-validation shall occur on an interval not to exceed **three years**. There is no fee or form associated with an OATS filing. OATS submissions are encouraged to be submitted electronically to the Bureau using the following URL; http://strategis.ic.gc.ca/epic/internet/inceb-bhst.nsf/en/h_tt00052e.html.

If you have any questions, you may contact the Bureau by e-mail at certification.bureau@ic.gc.ca Please reference our file and submission number above for all correspondence.

Yours sincerely,

Bill Payn
For: Wireless Laboratory Manager
Certification and Engineering Bureau
3701 Carling Ave., Building 94
P.O. Box 11490, Station AH@
Ottawa, Ontario K2H 8S2
Email: certification.bureau@ic.gc.ca

Rogers Labs, Inc.
4405 W. 259th Terrace
Louisburg, KS 66053
Phone/Fax: (913) 837-3214
Revision 2

Mikrotikls SIA
Model: RouterBOARD LHG-5nD
Test #: 160414a
Test to: 47CFR, 15.407, RSS-247

S/N: 66750503D06F/548
FCC ID#: TV7LHG5ND
IC: 7442A-LHG5ND
Date: June 30, 2016