

RF MEASUREMENT REPORT

FCC ID: TV7L23AX52
Applicant: Mikrotiks SIA
Product: L23UGSR-5HaxD2HaxD-US
NetMetal ax
Model No.: L23UGSR-5HaxD2HaxD-US
L23UGSR-5HaxD2HaxD-NM-US
Brand Name: MikroTik
FCC Classification: Unlicensed National Information Infrastructure (NII)
FCC Rule Part(s): Part 15 Subpart E (Section 15.407)
Result: Complies
Received Date: 2023-09-01
Test Date: 2023-09-11 ~ 2024-03-24

Reviewed By:

Vincent Yu

Approved By:

Robin Wu



The test results relate only to the samples tested.

This equipment has been shown to be capable of compliance with the applicable technical standards as indicated in the measurement report and was tested in accordance with the measurement procedures specified in KDB789033. Test results reported herein relate only to the item(s) tested.

The test report shall not be reproduced except in full without the written approval of MRT Technology (Suzhou) Co., Ltd.

Revision History

| Report No. | Version | Description | Issue Date | Note |
|---------------|---------|----------------|------------|-------|
| 2308RSU088-U1 | V01 | Initial Report | 2024-04-11 | Valid |
| | | | | |

CONTENTS

| Description | Page |
|--|-----------|
| 1. General Information | 5 |
| 1.1. Applicant | 5 |
| 1.2. Manufacturer..... | 5 |
| 1.3. Testing Facility | 5 |
| 1.4. Product Information | 6 |
| 1.5. Radio Specification under Test..... | 7 |
| 1.6. Working Frequencies..... | 8 |
| 1.7. Antenna Details | 9 |
| 2. Test Configuration | 10 |
| 2.1. Test Mode | 10 |
| 2.2. Test System Connection Diagram | 11 |
| 2.3. Test Software | 11 |
| 2.4. Applied Standards | 12 |
| 2.5. Test Environment Condition..... | 12 |
| 3. Antenna Requirements | 13 |
| 4. Measuring Instrument | 14 |
| 5. Decision Rules and Measurement Uncertainty | 16 |
| 5.1. Decision Rules..... | 16 |
| 5.2. Measurement Uncertainty | 16 |
| 6. Test Result..... | 17 |
| 6.1. Summary | 17 |
| 6.2. Output Power Measurement..... | 18 |
| 6.2.1. Test Limit..... | 18 |
| 6.2.2. Test Procedure | 18 |
| 6.2.3. Test Setting | 18 |
| 6.2.4. Test Setup..... | 18 |
| 6.2.5. Test Result | 18 |
| 6.3. Power Spectral Density Measurement | 19 |
| 6.3.1. Test Limit..... | 19 |
| 6.3.2. Test Procedure | 19 |
| 6.3.3. Test Setting | 19 |
| 6.3.4. Test Setup..... | 20 |
| 6.3.5. Test Result | 20 |
| 6.4. Radiated Spurious Emission Measurement | 21 |
| 6.4.1. Test Limit..... | 21 |

| | | |
|---|---|------------|
| 6.4.2. | Test Procedure | 21 |
| 6.4.3. | Test Setting | 21 |
| 6.4.4. | Test Setup | 23 |
| 6.4.5. | Test Result | 24 |
| 6.5. | Radiated Restricted Band Edge Measurement | 25 |
| 6.5.1. | Test Limit | 25 |
| 6.5.2. | Test Procedure | 27 |
| 6.5.3. | Test Setting | 27 |
| 6.5.4. | Test Setup | 28 |
| 6.5.5. | Test Result | 28 |
| Appendix A – Test Result | | 29 |
| A.1 | Output Power Test Result | 29 |
| A.2 | Power Spectral Density Test Result | 37 |
| A.3 | Radiated Spurious Emission Test Result | 69 |
| A.4 | Radiated Restricted Band Edge Test Result | 227 |
| Appendix B – Test Setup Photograph | | 503 |
| Appendix C – EUT Photograph | | 504 |

1.4. Product Information

| | |
|--|---|
| Product Name | L23UGSR-5HaxD2HaxD-US NetMetal ax |
| Model No. | L23UGSR-5HaxD2HaxD-US L23UGSR-5HaxD2HaxD-NM-US |
| EUT Serial No. | L23UGSR-5HaxD2HaxD-US: HEM08J6X3F6/320 L23UGSR-5HaxD2HaxD-NM-US: HG309XZDC5D/406 |
| Wi-Fi Specification | 802.11a/g/n/ac/ax, VHT |
| Antenna Information | Refer to section 1.7 |
| Power Type | AC/DC Adapter Input or PoE Input |
| Operating Environment | Outdoor Use |
| Accessories | |
| AC/DC Adapter | Model No.: SAW30-240-1200G Input Power: 100 - 240V ~ 50/60Hz, 0.8A Output Power: 24.0V = 1.2A 28.8W |
| Gigabit PoE | Input: 18-57V PIN 4, 5: 18-57V PIN 7, 8 Return |
| Remark: 1. The information of EUT was provided by the manufacturer, and the accuracy of the information shall be the responsibility of the manufacturer. 2. PoE needs to be used with an AC adapter. For this report, we select AC Adapter for testing. 3. For model differences, please refer to the Operation Description document. | |

1.5. Radio Specification under Test

| | | |
|-----------------------------|---|---|
| Frequency Range | For 802.11a/n-HT20/ac-VHT20/ax-HE20: 5180~5240MHz, 5260~5320MHz, 5500~5720MHz, 5745~5825MHz For 802.11n-HT40/ac-VHT40/ax-HE40: 5190~5230MHz, 5270~5310MHz, 5510~5710MHz, 5755~5795MHz For 802.11ac-VHT80/ax-HE80: 5210MHz, 5290MHz, 5530MHz, 5610 MHz, 5690MHz, 5775MHz For 802.11ac-VHT160/ax-HE160: 5250MHz, 5570MHz | |
| Type of Modulation | 802.11a/n/ac: OFDM 802.11ax: OFDMA | |
| Data Rate | 802.11a: 6/9/12/18/24/36/48/54Mbps 802.11n: up to 300Mbps 802.11ac: up to 1732Mbps 802.11ax: up to 2402Mbps | |
| Channel Puncturing Function | <input type="checkbox"/> Supported | <input checked="" type="checkbox"/> Unsupported |
| Support RU | <input checked="" type="checkbox"/> Full RU | <input type="checkbox"/> Partial RU |

1.6. Working Frequencies

802.11a/n-HT20/ac-VHT20/ax-HE20

| Channel | Frequency | Channel | Frequency | Channel | Frequency |
|---------|-----------|---------|-----------|---------|-----------|
| 36 | 5180 MHz | 40 | 5200 MHz | 44 | 5220 MHz |
| 48 | 5240 MHz | 52 | 5260 MHz | 56 | 5280 MHz |
| 60 | 5300 MHz | 64 | 5320 MHz | 100 | 5500 MHz |
| 104 | 5520 MHz | 108 | 5540 MHz | 112 | 5560 MHz |
| 116 | 5580 MHz | 120 | 5600 MHz | 124 | 5620 MHz |
| 128 | 5640 MHz | 132 | 5660 MHz | 136 | 5680 MHz |
| 140 | 5700 MHz | 144 | 5720 MHz | 149 | 5745 MHz |
| 153 | 5765 MHz | 157 | 5785 MHz | 161 | 5805 MHz |
| 165 | 5825 MHz | -- | -- | -- | -- |

802.11n-HT40/ac-VHT40/ax-HE40

| Channel | Frequency | Channel | Frequency | Channel | Frequency |
|---------|-----------|---------|-----------|---------|-----------|
| 38 | 5190 MHz | 46 | 5230 MHz | 54 | 5270 MHz |
| 62 | 5310 MHz | 102 | 5510 MHz | 110 | 5550MHz |
| 118 | 5590 MHz | 126 | 5630 MHz | 134 | 5670 MHz |
| 142 | 5710 MHz | 151 | 5755 MHz | 159 | 5795 MHz |

802.11ac-VHT80/ax-HE80

| Channel | Frequency | Channel | Frequency | Channel | Frequency |
|---------|-----------|---------|-----------|---------|-----------|
| 42 | 5210 MHz | 58 | 5290 MHz | 106 | 5530 MHz |
| 122 | 5610 MHz | 138 | 5690 MHz | 155 | 5775 MHz |

802.11ac-VHT160/ax-HE160

| Channel | Frequency | Channel | Frequency | Channel | Frequency |
|---------|-----------|---------|-----------|---------|-----------|
| 50 | 5250 MHz | 114 | 5570 MHz | -- | -- |

1.7. Antenna Details

| Antenna Type | Antenna Model | Frequency Range (MHz) | Max. PK Gain (dBi) | CDD DG (dBi) | |
|--------------|---------------|-----------------------|--------------------|--------------|---------|
| | | | | For Power | For PSD |
| Dish Antenna | MTAD-5G-30D3 | 5150 ~ 5250 | 28.0 | 28.0 | 31.01 |
| | | 5250 ~ 5850 | 30.0 | 30.0 | 33.01 |

Notes:

1. The EUT only supports Cyclic Delay Diversity (CDD) mode, and CDD signals are correlated.
2. The Maximum antenna gain of any elevation angle above 30 degrees is the same as the gain in the above table.

2. Test Configuration

2.1. Test Mode

| CDD Mode |
|--|
| Mode 1: Transmit by 802.11a_Nss=1 (6Mbps) |
| Mode 2: Transmit by 802.11ac-VHT20_Nss=1 (MCS0) |
| Mode 3: Transmit by 802.11ac-VHT40_Nss=1 (MCS0) |
| Mode 4: Transmit by 802.11ac-VHT80_Nss=1 (MCS0) |
| Mode 5: Transmit by 802.11ac-VHT160_Nss=1 (MCS0) |
| Mode 6: Transmit by 802.11ax-HE20_Nss=1 (MCS0) |
| Mode 7: Transmit by 802.11ax-HE40_Nss=1 (MCS0) |
| Mode 8: Transmit by 802.11ax-HE80_Nss=1 (MCS0) |
| Mode 9: Transmit by 802.11ax-HE160_Nss=1 (MCS0) |
| Notes: <ol style="list-style-type: none">1. The modulation and bandwidth are same for 802.11n mode for 20MHz/40MHz and 802.11ac mode for 20MHz/40MHz. Therefore, 802.11ac mode was selected as representative test mode in this report, and the power level of 802.11n mode will be controlled to be the same as or lower than that of 802.11ac mode.2. All modes of operation and data rates were investigated, so all RF test requirements shall be executed at the worst data rate. |

2.2. Test System Connection Diagram

The device was tested per the guidance ANSI C63.10: 2013 was used to reference the appropriate EUT setup for radiated emissions testing.

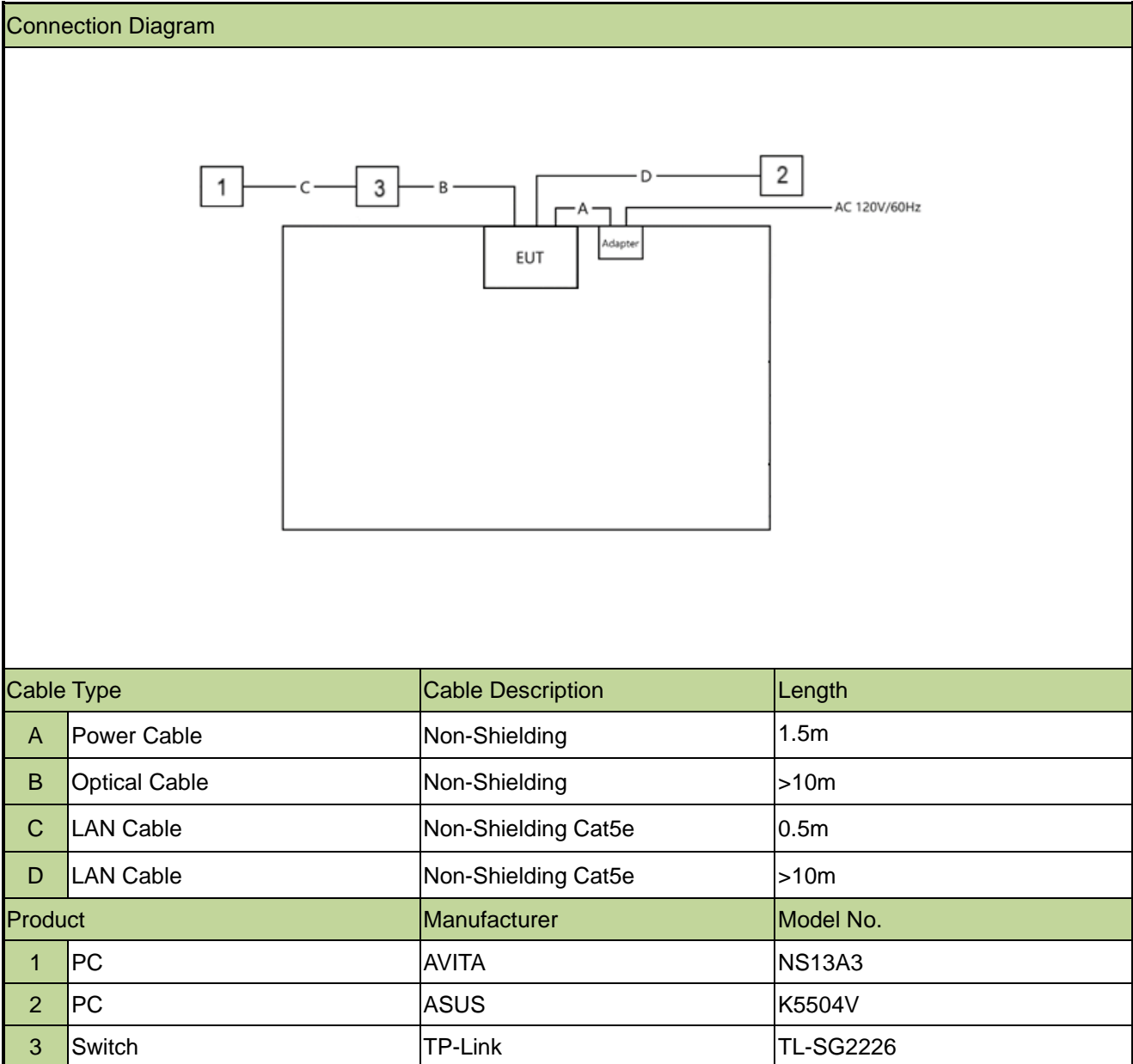

2.3. Test Software

The test utility software used during testing was “winbox.exe”, the version was “3.39” and commands are provided by the manufacturer.

2.4. Applied Standards

According to the specifications of the manufacturer, the EUT must comply with the requirements of the following standards:

- FCC Part 15.407
- KDB 789033 D02v02r01
- KDB 662911 D01v02r01
- ANSI C63.10-2013

2.5. Test Environment Condition

| | |
|---------------------|------------|
| Ambient Temperature | 15 ~ 35°C |
| Relative Humidity | 20 ~ 75%RH |

3. Antenna Requirements

Excerpt from §15.203 of the FCC Rules/Regulations:

“An intentional radiator antenna shall be designed to ensure that no antenna other than that furnished by the responsible party can be used with the device. The use of a permanently attached antenna or of an antenna that uses a unique coupling to the intentional radiator shall be considered sufficient to comply with the provisions of this section.”

- The model L23UGSR-5HaxD2HaxD-US and L23UGSR-5HaxD2HaxD-NM-US use unique antenna connectors.

Conclusion:

The unit complies with the requirement of §15.203.

4. Measuring Instrument

| Instrument | Manufacturer | Model No. | Asset No. | Cali. Interval | Cali. Due Date | Test Site |
|-------------------|--------------|-------------|-------------|----------------|----------------|-----------|
| EMI Test Receiver | R&S | ESR3 | MRTSUE06185 | 1 year | 2023-12-28 | SIP-AC3 |
| | | | | | 2024-12-17 | |
| Preamplifier | EMCI | EMC184045SE | MRTSUE06602 | 1 year | 2023-10-10 | SIP-AC3 |
| | | | | | 2024-10-09 | |
| EMI Test Receiver | R&S | ESR3 | MRTSUE06613 | 1 year | 2024-05-23 | SIP-AC3 |
| Preamplifier | EMCI | EMC001330 | MRTSUE06643 | 1 year | 2024-01-12 | SIP-AC3 |
| | | | | | 2025-01-11 | |
| Loop Antenna | Schwarzbeck | FMZB 1519 B | MRTSUE06937 | 1 year | 2024-02-26 | SIP-AC3 |
| | | | | | 2025-01-27 | |
| Horn Antenna | Schwarzbeck | BBHA 9170 | MRTSUE06599 | 1 year | 2023-10-13 | SIP-AC3 |
| | | | | | 2024-09-24 | |
| Preamplifier | Schwarzbeck | BBV 9721 | MRTSUE06121 | 1 year | 2024-06-07 | SIP-AC3 |
| Horn Antenna | R&S | HF907 | MRTSUE06611 | 1 year | 2024-07-14 | SIP-AC3 |
| Thermohygrometer | testo | 608-H1 | MRTSUE06619 | 1 year | 2023-11-01 | SIP-AC3 |
| | | | | | 2024-10-28 | |
| Preamplifier | EMCI | EMC012645SE | MRTSUE06642 | 1 year | 2024-01-12 | SIP-AC3 |
| | | | | | 2025-01-11 | |
| TRILOG Antenna | Schwarzbeck | VULB 9168 | MRTSUE06646 | 1 year | 2024-08-04 | SIP-AC3 |
| Anechoic Chamber | RIKEN | SIP-AC3 | MRTSUE06782 | 1 year | 2023-12-22 | SIP-AC3 |
| | | | | | 2024-12-21 | |
| Thermohygrometer | testo | 608-H1 | MRTSUE11255 | 1 year | 2024-08-13 | SIP-AC3 |
| Signal Analyzer | Keysight | N9010B | MRTSUE07028 | 1 year | 2023-11-25 | SIP-AC3 |
| | | | | | 2024-10-23 | |
| Loop Antenna | Schwarzbeck | FMZB 1519 | MRTSUE06025 | 1 year | 2023-09-29 | WZ-AC2 |
| | | | | | 2024-09-17 | |
| Horn Antenna | Schwarzbeck | BBHA 9170 | MRTSUE06597 | 1 year | 2023-11-05 | WZ-AC2 |
| | | | | | 2024-11-04 | |
| Preamplifier | EMCI | EMC184045SE | MRTSUE06640 | 1 year | 2024-01-12 | WZ-AC2 |
| | | | | | 2025-01-11 | |
| TRILOG Antenna | Schwarzbeck | VULB 9162 | MRTSUE06022 | 1 year | 2024-05-15 | WZ-AC2 |
| Horn Antenna | Schwarzbeck | BBHA 9120D | MRTSUE06171 | 1 year | 2023-10-13 | WZ-AC2 |
| | | | | | 2024-10-11 | |
| Preamplifier | Schwarzbeck | BBV 9718 | MRTSUE06176 | 1 year | 2024-05-07 | WZ-AC2 |
| Anechoic Chamber | RIKEN | WZ-AC2 | MRTSUE06213 | 1 year | 2024-04-20 | WZ-AC2 |



| Instrument | Manufacturer | Model No. | Asset No. | Cali. Interval | Cali. Due Date | Test Site |
|------------------|--------------|-----------|-------------|----------------|----------------|-----------|
| Thermohygrometer | testo | 608-H1 | MRTSUE11038 | 1 year | 2023-11-01 | WZ-AC2 |
| | | | | | 2024-10-25 | |
| Thermohygrometer | testo | 608-H1 | MRTSUE11263 | 1 year | 2024-11-07 | WZ-AC2 |
| Thermohygrometer | Mingle | ETH529 | MRTSUE06170 | 1 year | 2023-11-27 | WZ-AC2 |
| USB Power Sensor | Keysight | U2021XA | MRTSUE06447 | 1 year | 2024-05-23 | WZ-SR5 |
| USB Power Sensor | Agilent | U2021XA | MRTSUE06030 | 1 year | 2023-10-08 | WZ-SR5 |
| | | | | | 2024-09-27 | |
| Thermohygrometer | testo | 608-H1 | MRTSUE06402 | 1 year | 2024-05-31 | WZ-SR5 |
| Shielding Room | HUAMING | WZ-SR5 | MRTSUE06442 | N/A | N/A | WZ-SR5 |
| Signal Analyzer | Keysight | N9010B | MRTSUE06457 | 1 year | 2024-05-23 | WZ-SR5 |
| Signal Analyzer | Keysight | N9010B | MRTSUE06558 | 1 year | 2024-05-23 | WZ-SR5 |

| Software | Version | Function |
|----------------------|---------|------------------------|
| EMI V3 | V 3.0.0 | EMI Test Software |
| Controller_MF 7802 | 1.02 | RE Antenna & Turntable |
| Controller_MF 7802BS | 1.02 | RE Antenna & Turntable |
| BenchVue Power Meter | 2018.1 | Power |

5. Decision Rules and Measurement Uncertainty

5.1. Decision Rules

The Decision Rule is based on Simple Acceptance in accordance with ISO Guide 98-4: 2012 Clause 8.2. (Measurement uncertainty is not taken into account when stating conformity with a specified requirement.)

5.2. Measurement Uncertainty

Where relevant, the following test uncertainty levels have been estimated for tests performed on the EUT as specified in CISPR 16-4-2. This uncertainty represents an expanded uncertainty expressed at approximately the 95% confidence level using a coverage factor of $k = 2$.

| Radiated Emission Measurement | |
|--|----------------------|
| The maximum measurement uncertainty is evaluated as: | |
| Coaxial: | 9kHz~30MHz: 2.61dB |
| Coplanar: | 9kHz~30MHz: 2.62dB |
| Horizontal: | 30MHz~200MHz: 3.79dB |
| | 200MHz~1GHz: 3.91dB |
| | 1GHz~40GHz: 4.99dB |
| Vertical: | 30MHz~200MHz: 4.06dB |
| | 200MHz~1GHz: 5.21dB |
| | 1GHz~40GHz: 4.90dB |
| Output Power | |
| Measuring Uncertainty for a Level of Confidence of 95% ($U=2Uc(y)$): | |
| 1.4dB | |
| Power Spectrum Density | |
| Measuring Uncertainty for a Level of Confidence of 95% ($U=2Uc(y)$): | |
| 2.2dB | |

6. Test Result

6.1. Summary

| FCC Section(s) | Test Description | Test Condition | Verdict |
|---|---|----------------|---------|
| 15.407(a)(1)(i), (2), (3)(i) | Maximum Conducted Output Power | Conducted | Pass |
| 15.407(a)(1)(i), (2), (3)(i), (13) | Peak Power Spectral Density | | Pass |
| 15.407(b)(1), (2), (3), (4)(i) | Undesirable Emissions | Radiated | Pass |
| 15.205, 15.209 15.407(b)(8), (9), (10) | General Field Strength Limits (Restricted Bands and Radiated Emission Limits) | | Pass |

Remark:

- The analyzer plots shown in this section were all taken with a correction table loaded into the analyzer. The correction table was used to account for the losses of the cables and attenuators used as part of the system to connect the EUT to the analyzer at all frequencies of interest.
- For radiated emission test, every axis (X, Y, Z) was also verified. The test results shown in the following sections represent the worst-case emissions.
- This report is for C2PC application. Based on original application (FCC ID: TV7L23AX52, RF Report No.: 2308RSU089-U2), added a high gain antenna to model L23UGSR-5HaxD2HaxD-US and L23UGSR-5HaxD2HaxD-NM-US. The test evaluation of each model is as follows.
 - Full test was performed on RF Maximum Conducted Output Power, Peak Power Spectral Density, Undesirable Emissions and General Field Strength Limits for L23UGSR-5HaxD2HaxD-US.
 - Full test was performed on RF Maximum Conducted Output Power, Undesirable Emissions and General Field Strength Limits for L23UGSR-5HaxD2HaxD-NM-US.

6.2. Output Power Measurement

6.2.1. Test Limit

For an outdoor access point operating in the band 5.15–5.25 GHz, the maximum conducted output power over the frequency band of operation shall not exceed 1 W provided the maximum antenna gain does not exceed 6 dBi. The maximum e.i.r.p. at any elevation angle above 30 degrees as measured from the horizon must not exceed 125 mW (21 dBm).

For the 5.25-5.35 GHz and 5.47-5.725 GHz bands, the maximum conducted output power over the frequency bands of operation shall not exceed the lesser of 250 mW or $11 \text{ dBm} + 10 \log B$, where B is the 26 dB emission bandwidth in megahertz.

For the band 5.725-5.85 GHz, the maximum conducted output power over the frequency band of operation shall not exceed 1 W (30dBm).

If transmitting antennas of directional gain greater than 6dBi are used, the maximum conducted output power shall be reduced by the amount in dB that the directional gain of the antenna exceeds 6dBi.

6.2.2. Test Procedure

KDB 789033D02v02r01- Section II)E)3)b) Method PM-G

6.2.3. Test Setting

Average Power Measurement

Average power measurements were performed only when the EUT was transmitting at its maximum power control level using a broadband power meter with a pulse sensor. The power meter implemented triggering and gating capabilities which were set up such that power measurements were recorded only during the ON time of the transmitter.

6.2.4. Test Setup

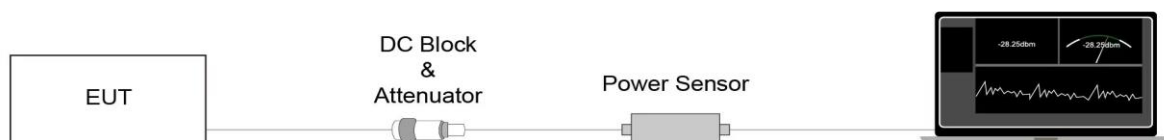

6.2.5. Test Result

Refer to Appendix A.1.

6.3. Power Spectral Density Measurement

6.3.1. Test Limit

For an outdoor access point operating in the band 5.15–5.25 GHz, the maximum power spectral density shall not exceed 17 dBm in any 1 megahertz band.

For the 5.25-5.35 GHz and 5.47-5.725 GHz bands, the maximum power spectral density shall not exceed 11 dBm in any 1 megahertz band.

For the band 5.725-5.85 GHz, the maximum power spectral density shall not exceed 30 dBm in any 500-kHz band.

If transmitting antennas of directional gain greater than 6dBi are used, the peak power spectral density shall be reduced by the amount in dB that the directional gain of the antenna exceeds 6dBi.

6.3.2. Test Procedure

KDB 789033 D02v02r01-Section II)F)

6.3.3. Test Setting

1. Analyzer was set to the center frequency of the UNII channel under investigation
2. Span was set to encompass the entire 26dB EBW of the signal.
3. RBW = 1MHz (510kHz, if measurement bandwidth of Maximum PSD is specified in 500 kHz)
4. VBW = 3 × RBW
5. Number of sweep points $\geq 2 \times (\text{span} / \text{RBW})$
6. Detector = power averaging (Average)
7. Sweep time = auto
8. Trigger = free run
9. Trace average at least 100 traces in power averaging (rms) mode; however, the number of traces to be averaged shall be increased above 100 as needed to ensure that the average accurately represents the true average over the on and off periods of the transmitter.
10. Use the peak search function on the instrument to find the peak of the spectrum and record its value.
11. Add $10 \cdot \log(1/x)$, where x is the duty cycle, to the measured power in order to compute the average power during the actual transmission times (because the measurement represents an average over both the on and off times of the transmission). For example, add $10 \cdot \log(1/0.25) = 6$ dB if the duty cycle is 25 percent.

6.3.4. Test Setup

Spectrum Analyzer

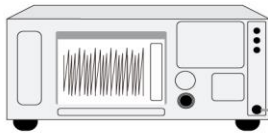

DC Block
&
Attenuator

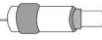

6.3.5. Test Result

Refer to Appendix A.2.

6.4. Radiated Spurious Emission Measurement

6.4.1. Test Limit

All out of band emissions appearing in a restricted band as specified in Section 15.205 of the Title 47 CFR must not exceed the limits shown in Table per Section 15.209.

| FCC Part 15 Subpart C Paragraph 15.209 | | |
|--|--------------------------|-------------------------------|
| Frequency [MHz] | Field Strength [uV/m] | Measured Distance [Meters] |
| 0.009 - 0.490 | 2400/F (kHz) | 300 |
| 0.490 - 1.705 | 24000/F (kHz) | 30 |
| 1.705 - 30 | 30 | 30 |
| 30 - 88 | 100 | 3 |
| 88 - 216 | 150 | 3 |
| 216 - 960 | 200 | 3 |
| Above 960 | 500 | 3 |

6.4.2. Test Procedure

KDB 789033 D02v02r01- Section II)G)

6.4.3. Test Setting

Table 1 - RBW as a function of frequency

| Frequency | RBW |
|---------------|---------------|
| 9 ~ 150 kHz | 200 ~ 300 Hz |
| 0.15 ~ 30 MHz | 9 ~ 10 kHz |
| 30 ~ 1000 MHz | 100 ~ 120 kHz |
| > 1000MHz | 1MHz |

Quasi-Peak Measurements below 1GHz

1. Analyzer center frequency was set to the frequency of the radiated spurious emission of interest
2. Span was set greater than 1MHz
3. RBW = as specified in Table 1
4. Detector = CISPR quasi-peak
5. Sweep time = auto couple
6. Trace was allowed to stabilize

Peak Measurements above 1GHz

1. Analyzer center frequency was set to the frequency of the radiated spurious emission of interest
2. RBW = 1MHz
3. VBW = 3MHz
4. Detector = peak
5. Sweep time = auto couple
6. Trace mode = max hold
7. Trace was allowed to stabilize

Average Measurements above 1GHz (Method VB)

1. Analyzer center frequency was set to the frequency of the radiated spurious emission of interest
2. RBW = 1MHz
3. VBW; If the EUT is configured to transmit with duty cycle $\geq 98\%$, set VBW = 10 Hz.
If the EUT duty cycle is $< 98\%$, set VBW $\geq 1/T$. T is the minimum transmission duration.
4. Detector = Peak
5. Sweep time = auto
6. Trace mode = max hold
7. Trace was allowed to stabilize

6.4.4. Test Setup

Below 30MHz Test Setup:

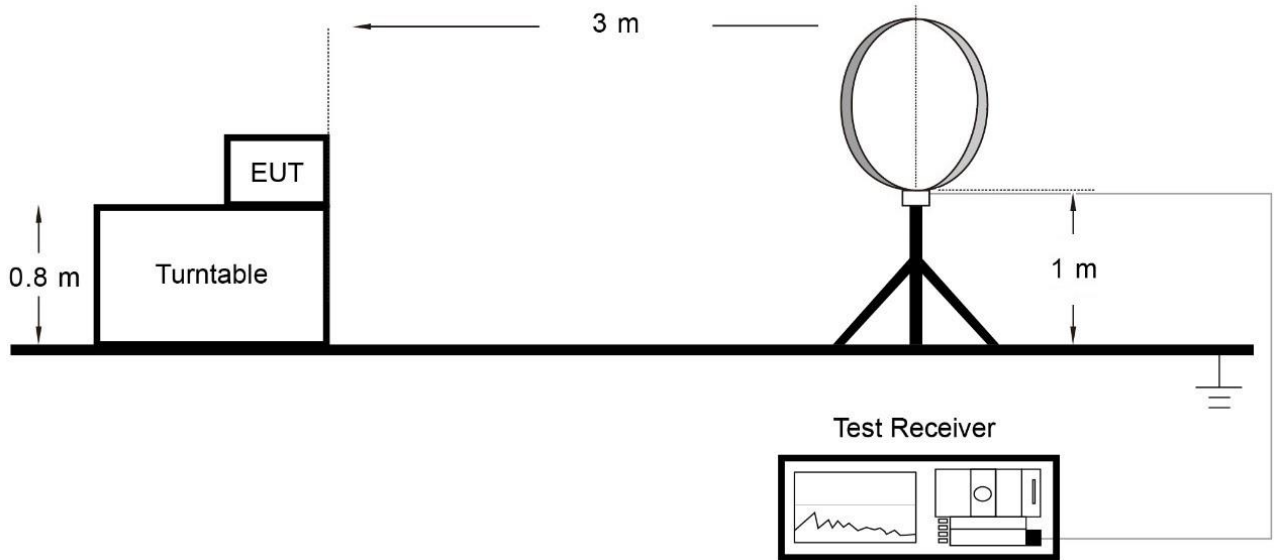

Below 1GHz Test Setup:

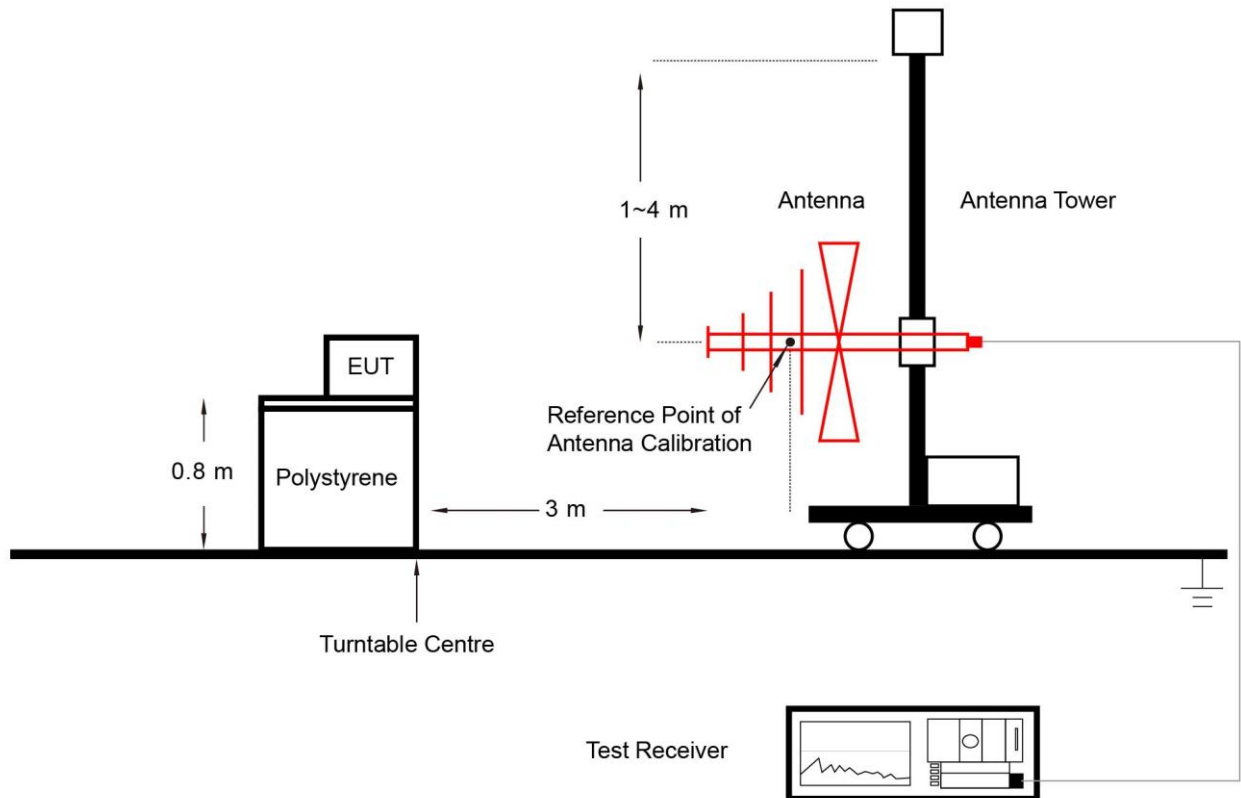

Above 1GHz Test Setup:

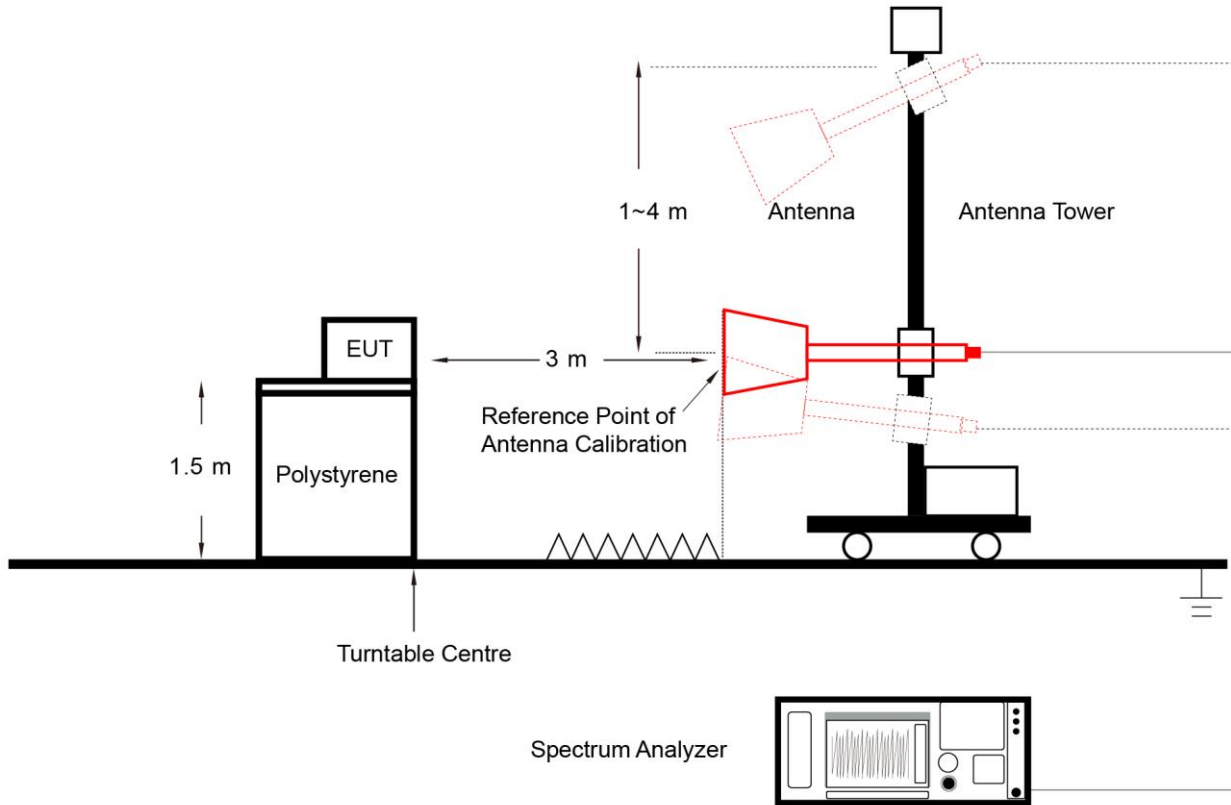

6.4.5. Test Result

Refer to Appendix A.3.

6.5. Radiated Restricted Band Edge Measurement

6.5.1. Test Limit

For 15.205 requirement:

Radiated emissions which fall in the restricted bands, as defined in Section 15.205(a) of FCC part 15, must also comply with the radiated emission limits specified in Section 15.209(a).

| Frequency (MHz) | Frequency (MHz) | Frequency (MHz) | Frequency (GHz) |
|----------------------------|-----------------------|--------------------|--------------------|
| 0.090 - 0.110 | 16.42 - 16.423 | 399.9 - 410 | 4.5 - 5.15 |
| ¹ 0.495 - 0.505 | 16.69475 - 16.69525 | 608 - 614 | 5.35 - 5.46 |
| 2.1735 - 2.1905 | 16.80425 - 16.80475 | 960 - 1240 | 7.25 - 7.75 |
| 4.125 - 4.128 | 25.5 - 25.67 | 1300 - 1427 | 8.025 - 8.5 |
| 4.17725 - 4.17775 | 37.5 - 38.25 | 1435 - 1626.5 | 9.0 - 9.2 |
| 4.20725 - 4.20775 | 73 - 74.6 | 1645.5 - 1646.5 | 9.3 - 9.5 |
| 6.215 - 6.218 | 74.8 - 75.2 | 1660 - 1710 | 10.6 - 12.7 |
| 6.26775 - 6.26825 | 108 - 121.94 | 1718.8 - 1722.2 | 13.25 - 13.4 |
| 6.31175 - 6.31225 | 123 - 138 | 2200 - 2300 | 14.47 - 14.5 |
| 8.291 - 8.294 | 149.9 - 150.05 | 2310 - 2390 | 15.35 - 16.2 |
| 8.362 - 8.366 | 156.52475 - 156.52525 | 2483.5 - 2500 | 17.7 - 21.4 |
| 8.37625 - 8.38675 | 156.7 - 156.9 | 2690 - 2900 | 22.01 - 23.12 |
| 8.41425 - 8.41475 | 162.0125 - 167.17 | 3260 - 3267 | 23.6 - 24.0 |
| 12.29 - 12.293 | 167.72 - 173.2 | 3332 - 3339 | 31.2 - 31.8 |
| 12.51975 - 12.52025 | 240 - 285 | 3345.8 - 3358 | 36.43 - 36.5 |
| 12.57675 - 12.57725 | 322 - 335.4 | 3600 - 4400 | (²) |
| 13.36 - 13.41 | -- | -- | -- |

For 15.407(b) requirement:

For transmitters operating in the 5.15-5.25 GHz band: All emissions outside of the 5.15-5.35 GHz band shall not exceed an e.i.r.p. of -27 dBm/MHz.

For transmitters operating in the 5.25-5.35 GHz band: All emissions outside of the 5.15-5.35 GHz band shall not exceed an e.i.r.p. of -27 dBm/MHz.

For transmitters operating in the 5.47-5.725 GHz band: All emissions outside of the 5.47-5.725 GHz band shall not exceed an e.i.r.p. of -27 dBm/MHz.

For transmitters operating in the 5.725-5.85 GHz band: All emissions shall be limited to a level of -27 dBm/MHz at 75 MHz or more above or below the band edge increasing linearly to 10 dBm/MHz at 25 MHz above or below the band edge, and from 25 MHz above or below the band edge increasing linearly to a level of 15.6 dBm/MHz at 5 MHz above or below the band edge, and from 5 MHz above or below the band edge increasing linearly to a level of 27 dBm/MHz at the band edge.

Refer to KDB 789033 D02v02r01 G)2)c), as specified in § 15.407(b), emissions above 1000 MHz that are outside of the restricted bands are subject to a maximum emission limit of -27 dBm/MHz (or -17 dBm/MHz as specified in § 15.407(b)(4)). However, an out-of-band emission that complies with both the peak and average limits of § 15.209 is not required to satisfy the -27 dBm/MHz or -17 dBm/MHz maximum emission limit.

All out of band emissions appearing in a restricted band as specified in Section 15.205 of the Title 47CFR must not exceed the limits shown in Table per Section 15.209.

| FCC Part 15 Subpart C Paragraph 15.209 | | |
|--|--------------------------|-------------------------------|
| Frequency [MHz] | Field Strength [uV/m] | Measured Distance [Meters] |
| 0.009 - 0.490 | 2400/F (kHz) | 300 |
| 0.490 - 1.705 | 24000/F (kHz) | 30 |
| 1.705 - 30 | 30 | 30 |
| 30 - 88 | 100 | 3 |
| 88 - 216 | 150 | 3 |
| 216 - 960 | 200 | 3 |
| Above 960 | 500 | 3 |

6.5.2. Test Procedure

KDB 789033 D02v02r01- Section II)G)

6.5.3. Test Setting

Peak Measurements above 1GHz

1. Analyzer center frequency was set to the frequency of the radiated spurious emission of interest
2. RBW = 1MHz
3. VBW = 3MHz
4. Detector = Peak
5. Sweep time = Auto couple
6. Trace mode = Max hold
7. Trace was allowed to stabilize

Average Measurements above 1GHz (Method VB)

1. Analyzer center frequency was set to the frequency of the radiated spurious emission of interest
2. RBW = 1MHz
3. VBW; if the EUT is configured to transmit with duty cycle $\geq 98\%$, set VBW = 10Hz
4. If the EUT duty cycle is $< 98\%$, set VBW $\geq 1/T$. T is the minimum transmission duration
5. Detector = Peak
6. Sweep time = Auto
7. Trace mode = Max hold
8. Trace was allowed to stabilize

6.5.4. Test Setup

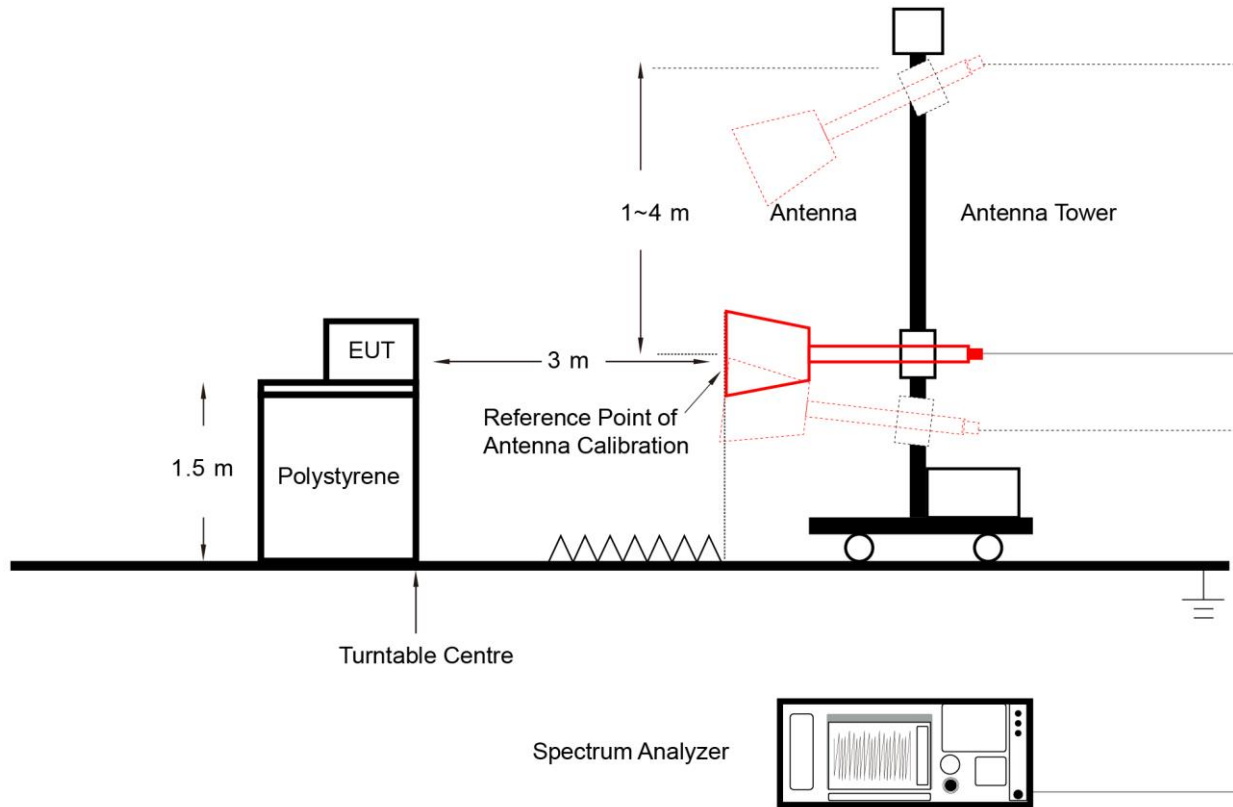

6.5.5. Test Result

Refer to Appendix A.4.

Appendix A – Test Result

A.1 Output Power Test Result

| | | | |
|--------------------|-------------------------------------|---------------|-----------|
| Test Site | WZ-SR5 | Test Engineer | Cloud Guo |
| Test Date | 2023-09-11~2024-03-22 | | |
| Test Configuration | L23UGSR-5HaxD2HaxD-US (UNII-Band 1) | | |

| Test Mode | Data Rate/MCS | Channel No. | Freq. (MHz) | Ant 0 Average Power (dBm) | Ant 1 Average Power (dBm) | Total Average Power (dBm) | Average Power Limit (dBm) | 30 Degree EIRP (dBm) | 30 Degree EIRP Limit (dBm) | Result |
|--------------------------------------|---------------|-------------|-------------|---------------------------|---------------------------|---------------------------|---------------------------|----------------------|----------------------------|--------|
| 11a | 6Mbps | 36 | 5180 | -11.37 | -10.28 | -7.78 | 8.00 | 20.22 | ≤ 21.00 | Pass |
| 11a | 6Mbps | 44 | 5220 | -10.49 | -10.00 | -7.23 | 8.00 | 20.77 | ≤ 21.00 | Pass |
| 11a | 6Mbps | 48 | 5240 | -10.52 | -10.32 | -7.41 | 8.00 | 20.59 | ≤ 21.00 | Pass |
| 11ac-VHT20 | MCS0 | 36 | 5180 | -11.38 | -10.49 | -7.90 | 8.00 | 20.10 | ≤ 21.00 | Pass |
| 11ac-VHT20 | MCS0 | 44 | 5220 | -10.62 | -10.14 | -7.36 | 8.00 | 20.64 | ≤ 21.00 | Pass |
| 11ac-VHT20 | MCS0 | 48 | 5240 | -10.63 | -10.52 | -7.56 | 8.00 | 20.44 | ≤ 21.00 | Pass |
| 11ac-VHT40 | MCS0 | 38 | 5190 | -10.64 | -9.73 | -7.15 | 8.00 | 20.85 | ≤ 21.00 | Pass |
| 11ac-VHT40 | MCS0 | 46 | 5230 | -10.63 | -10.44 | -7.52 | 8.00 | 20.48 | ≤ 21.00 | Pass |
| 11ac-VHT80 | MCS0 | 42 | 5210 | -10.43 | -9.99 | -7.19 | 8.00 | 20.81 | ≤ 21.00 | Pass |
| 11ac-VHT160 Straddle 5.15-5.25GHz | MCS0 | 50 | 5250 | -10.61 | -10.45 | -7.52 | 8.00 | 20.48 | ≤ 21.00 | Pass |
| 11ax-HE20 | MCS0 | 36 | 5180 | -11.21 | -10.44 | -7.80 | 8.00 | 20.20 | ≤ 21.00 | Pass |
| 11ax-HE20 | MCS0 | 44 | 5220 | -10.54 | -10.13 | -7.32 | 8.00 | 20.68 | ≤ 21.00 | Pass |
| 11ax-HE20 | MCS0 | 48 | 5240 | -10.71 | -10.40 | -7.54 | 8.00 | 20.46 | ≤ 21.00 | Pass |
| 11ax-HE40 | MCS0 | 38 | 5190 | -10.55 | -9.87 | -7.19 | 8.00 | 20.81 | ≤ 21.00 | Pass |
| 11ax-HE40 | MCS0 | 46 | 5230 | -10.71 | -10.56 | -7.62 | 8.00 | 20.38 | ≤ 21.00 | Pass |
| 11ax-HE80 | MCS0 | 42 | 5210 | -10.45 | -9.84 | -7.12 | 8.00 | 20.88 | ≤ 21.00 | Pass |
| 11ax-HE160 Straddle 5.15-5.25GHz | MCS0 | 50 | 5250 | -10.62 | -10.39 | -7.49 | 8.00 | 20.51 | ≤ 21.00 | Pass |

Note 1: Total Average Power (dBm) = $10 \cdot \log \{10^{(\text{Ant 0 Average Power} / 10)} + 10^{(\text{Ant 1 Average Power} / 10)}\}$.

Note 2: 30 Degree EIRP (dBm) = Total Average Power (dBm) + 30° Ant Gain(dBi).

| | | | |
|--------------------|--|---------------|-----------|
| Test Site | WZ-SR5 | Test Engineer | Cloud Guo |
| Test Date | 2023-09-11~2024-03-22 | | |
| Test Configuration | L23UGSR-5HaxD2HaxD-US (UNII-2a & UNII-2c & UNII-3) | | |

| Test Mode | Data Rate MCS | Channel No. | Freq. (MHz) | Average Power (dBm) | | Total Average Power (dBm) | Power Limit (dBm) |
|------------|------------------|----------------|----------------|------------------------|--------|---------------------------------|----------------------|
| | | | | Ant 0 | Ant 1 | | |
| 11a | 6Mbps | 52 | 5260 | -9.36 | -9.20 | -6.27 | ≤ -0.32 |
| 11a | 6Mbps | 60 | 5300 | -8.72 | -9.48 | -6.07 | ≤ -0.32 |
| 11a | 6Mbps | 64 | 5320 | -9.39 | -9.85 | -6.60 | ≤ -0.32 |
| 11a | 6Mbps | 100 | 5500 | -8.91 | -9.24 | -6.06 | ≤ -0.32 |
| 11a | 6Mbps | 116 | 5580 | -9.40 | -8.68 | -6.01 | ≤ -0.32 |
| 11a | 6Mbps | 140 | 5700 | -7.94 | -9.07 | -5.46 | ≤ -0.32 |
| 11a | 6Mbps | 144 | 5720 | -8.48 | -10.12 | -6.21 | ≤ -1.43 |
| 11a | 6Mbps | 149 | 5745 | 2.28 | 2.50 | 5.40 | ≤ 6.00 |
| 11a | 6Mbps | 157 | 5785 | 2.41 | 2.65 | 5.54 | ≤ 6.00 |
| 11a | 6Mbps | 165 | 5825 | 2.59 | 2.50 | 5.56 | ≤ 6.00 |
| 11ac-VHT20 | MCS0 | 52 | 5260 | -9.22 | -9.27 | -6.23 | ≤ -0.02 |
| 11ac-VHT20 | MCS0 | 60 | 5300 | -8.61 | -8.14 | -5.36 | ≤ -0.02 |
| 11ac-VHT20 | MCS0 | 64 | 5320 | -8.98 | -9.53 | -6.24 | ≤ -0.02 |
| 11ac-VHT20 | MCS0 | 100 | 5500 | -8.92 | -9.28 | -6.09 | ≤ -0.02 |
| 11ac-VHT20 | MCS0 | 116 | 5580 | -9.44 | -8.21 | -5.77 | ≤ -0.02 |
| 11ac-VHT20 | MCS0 | 140 | 5700 | -7.95 | -9.21 | -5.52 | ≤ -0.02 |
| 11ac-VHT20 | MCS0 | 144 | 5720 | -7.56 | -9.13 | -5.26 | ≤ -1.23 |
| 11ac-VHT20 | MCS0 | 149 | 5745 | 2.17 | 2.62 | 5.41 | ≤ 6.00 |
| 11ac-VHT20 | MCS0 | 157 | 5785 | 2.37 | 2.74 | 5.57 | ≤ 6.00 |
| 11ac-VHT20 | MCS0 | 165 | 5825 | 2.63 | 2.65 | 5.65 | ≤ 6.00 |

| Test Mode | Data Rate MCS | Channel No. | Freq. (MHz) | Average Power (dBm) | | Total Average Power (dBm) | Power Limit (dBm) |
|---|------------------|----------------|----------------|------------------------|--------|---------------------------------|----------------------|
| | | | | Ant 0 | Ant 1 | | |
| | | | | 11ac-VHT40 | MCS0 | 54 | 5270 |
| 11ac-VHT40 | MCS0 | 62 | 5310 | -5.55 | -7.43 | -3.38 | ≤ -0.02 |
| 11ac-VHT40 | MCS0 | 102 | 5510 | -5.89 | -4.95 | -2.38 | ≤ -0.02 |
| 11ac-VHT40 | MCS0 | 110 | 5550 | -6.04 | -4.86 | -2.40 | ≤ -0.02 |
| 11ac-VHT40 | MCS0 | 134 | 5670 | -5.57 | -4.52 | -2.00 | ≤ -0.02 |
| 11ac-VHT40 | MCS0 | 142 | 5710 | -5.90 | -5.71 | -2.79 | ≤ -0.02 |
| 11ac-VHT40 | MCS0 | 151 | 5755 | 2.53 | 2.58 | 5.57 | ≤ 6.00 |
| 11ac-VHT40 | MCS0 | 159 | 5795 | 2.12 | 2.40 | 5.27 | ≤ 6.00 |
| 11ac-VHT80 | MCS0 | 58 | 5290 | -3.40 | -4.13 | -0.74 | ≤ -0.02 |
| 11ac-VHT80 | MCS0 | 106 | 5530 | -3.72 | -2.94 | -0.30 | ≤ -0.02 |
| 11ac-VHT80 | MCS0 | 122 | 5610 | -4.54 | -3.07 | -0.73 | ≤ -0.02 |
| 11ac-VHT80 | MCS0 | 138 | 5690 | -3.77 | -3.21 | -0.47 | ≤ -0.02 |
| 11ac-VHT80 | MCS0 | 155 | 5775 | 2.53 | 2.65 | 5.60 | ≤ 6.00 |
| 11ac-VHT160 | MCS0 | 50 | 5250 | -7.83 | -7.80 | -4.80 | -- |
| 11ac-VHT160 Straddle 5.25-5.35GHz | MCS0 | 50 | 5250 | -11.09 | -11.21 | -8.14 | ≤ -0.02 |
| 11ac-VHT160 | MCS0 | 114 | 5570 | -4.31 | -3.14 | -0.68 | ≤ -0.02 |
| 11ax-HE20 | MCS0 | 52 | 5260 | -8.94 | -9.26 | -6.09 | ≤ -0.02 |
| 11ax-HE20 | MCS0 | 60 | 5300 | -8.91 | -9.53 | -6.20 | ≤ -0.02 |
| 11ax-HE20 | MCS0 | 64 | 5320 | -8.04 | -8.69 | -5.34 | ≤ -0.02 |
| 11ax-HE20 | MCS0 | 100 | 5500 | -7.86 | -6.86 | -4.32 | ≤ -0.02 |
| 11ax-HE20 | MCS0 | 116 | 5580 | -9.66 | -8.21 | -5.86 | ≤ -0.02 |
| 11ax-HE20 | MCS0 | 140 | 5700 | -8.13 | -9.16 | -5.60 | ≤ -0.02 |
| 11ax-HE20 | MCS0 | 144 | 5720 | -7.87 | -9.13 | -5.44 | ≤ -1.14 |
| 11ax-HE20 | MCS0 | 149 | 5745 | 2.10 | 2.73 | 5.44 | ≤ 6.00 |
| 11ax-HE20 | MCS0 | 157 | 5785 | 2.35 | 2.59 | 5.48 | ≤ 6.00 |
| 11ax-HE20 | MCS0 | 165 | 5825 | 2.58 | 2.31 | 5.46 | ≤ 6.00 |

| Test Mode | Data Rate MCS | Channel No. | Freq. (MHz) | Average Power (dBm) | | Total Average Power (dBm) | Power Limit (dBm) |
|--|------------------|----------------|----------------|------------------------|--------|---------------------------------|----------------------|
| | | | | Ant 0 | Ant 1 | | |
| | | | | 11ax-HE40 | MCS0 | 54 | 5270 |
| 11ax-HE40 | MCS0 | 62 | 5310 | -5.49 | -7.35 | -3.31 | ≤ -0.02 |
| 11ax-HE40 | MCS0 | 102 | 5510 | -5.45 | -5.36 | -2.39 | ≤ -0.02 |
| 11ax-HE40 | MCS0 | 110 | 5550 | -6.12 | -5.02 | -2.52 | ≤ -0.02 |
| 11ax-HE40 | MCS0 | 134 | 5670 | -5.63 | -4.67 | -2.11 | ≤ -0.02 |
| 11ax-HE40 | MCS0 | 142 | 5710 | -6.04 | -5.73 | -2.87 | ≤ -0.02 |
| 11ax-HE40 | MCS0 | 151 | 5755 | 2.60 | 2.36 | 5.49 | ≤ 6.00 |
| 11ax-HE40 | MCS0 | 159 | 5795 | 2.40 | 2.62 | 5.52 | ≤ 6.00 |
| 11ax-HE80 | MCS0 | 58 | 5290 | -3.16 | -4.09 | -0.59 | ≤ -0.02 |
| 11ax-HE80 | MCS0 | 106 | 5530 | -3.66 | -2.81 | -0.20 | ≤ -0.02 |
| 11ax-HE80 | MCS0 | 122 | 5610 | -4.43 | -3.02 | -0.66 | ≤ -0.02 |
| 11ax-HE80 | MCS0 | 138 | 5690 | -3.78 | -3.20 | -0.47 | ≤ -0.02 |
| 11ax-HE80 | MCS0 | 155 | 5775 | 2.22 | 2.53 | 5.39 | ≤ 6.00 |
| 11ax-HE160 | MCS0 | 50 | 5250 | -7.86 | -7.79 | -4.81 | -- |
| 11ax-HE160 Straddle 5.25-5.35GHz | MCS0 | 50 | 5250 | -11.14 | -11.26 | -8.19 | ≤ -0.02 |
| 11ax-HE160 | MCS0 | 114 | 5570 | -4.36 | -3.17 | -0.71 | ≤ -0.02 |

Note 1: Total Average Power (dBm) = $10 \cdot \log \{10^{(\text{Ant 0 Average Power} / 10)} + 10^{(\text{Ant 1 Average Power} / 10)}\}$.

Note 2: For 5250-5350MHz & 5470-5725MHz, the conducted power limit is as below.

802.11a: $11 + 10 \log_{10} (18.55) - (\text{Ant Gain} - 6) = -0.32 < -0.02$ dBm.

802.11ac-VHT20: $11 + 10 \log_{10} (19.95) - (\text{Ant Gain} - 6) = 0 > -0.02$ dBm.

802.11ax-HE20: $11 + 10 \log_{10} (20.24) - (\text{Ant Gain} - 6) = 0.06 > -0.02$ dBm.

802.11ac-VHT40/ax-HE40/ac-VHT80/ax-HE80: $11 + 10 \log_{10} B - (\text{Ant Gain} - 6) > -0.02$ dBm.

Note 3: For Band-Crossing channel, Average Power Limit = $(23.98\text{dBm or } 11 + 10 \cdot \log_{10} \text{EBW}_{2c}) - (\text{Ant Gain} - 6)$ which is less.

| | | | |
|--------------------|--|---------------|-----------|
| Test Site | WZ-SR5 | Test Engineer | Cloud Guo |
| Test Date | 2023-09-11~2024-03-22 | | |
| Test Configuration | L23UGSR-5HaxD2HaxD-NM-US (UNII-Band 1) | | |

| Test Mode | Data Rate/MCS | Channel No. | Freq. (MHz) | Ant 0 Average Power (dBm) | Ant 1 Average Power (dBm) | Total Average Power (dBm) | Average Power Limit (dBm) | 30 Degree EIRP (dBm) | 30 Degree EIRP Limit (dBm) | Result |
|-----------------------------------|---------------|-------------|-------------|---------------------------|---------------------------|---------------------------|---------------------------|----------------------|----------------------------|--------|
| 11a | 6Mbps | 36 | 5180 | -10.85 | -11.05 | -7.94 | 8.00 | 20.06 | ≤ 21.00 | Pass |
| 11a | 6Mbps | 44 | 5220 | -10.37 | -10.11 | -7.23 | 8.00 | 20.77 | ≤ 21.00 | Pass |
| 11a | 6Mbps | 48 | 5240 | -10.98 | -10.85 | -7.90 | 8.00 | 20.10 | ≤ 21.00 | Pass |
| 11ac-VHT20 | MCS0 | 36 | 5180 | -11.96 | -11.43 | -8.68 | 8.00 | 19.32 | ≤ 21.00 | Pass |
| 11ac-VHT20 | MCS0 | 44 | 5220 | -10.50 | -10.29 | -7.38 | 8.00 | 20.62 | ≤ 21.00 | Pass |
| 11ac-VHT20 | MCS0 | 48 | 5240 | -11.26 | -10.92 | -8.08 | 8.00 | 19.92 | ≤ 21.00 | Pass |
| 11ac-VHT40 | MCS0 | 38 | 5190 | -10.83 | -10.46 | -7.63 | 8.00 | 20.37 | ≤ 21.00 | Pass |
| 11ac-VHT40 | MCS0 | 46 | 5230 | -11.31 | -11.21 | -8.25 | 8.00 | 19.75 | ≤ 21.00 | Pass |
| 11ac-VHT80 | MCS0 | 42 | 5210 | -10.21 | -10.28 | -7.23 | 8.00 | 20.77 | ≤ 21.00 | Pass |
| 11ac-VHT160 Straddle 5.15-5.25GHz | MCS0 | 50 | 5250 | -11.70 | -12.21 | -8.94 | 8.00 | 19.06 | ≤ 21.00 | Pass |
| 11ax-HE20 | MCS0 | 36 | 5180 | -10.86 | -10.81 | -7.82 | 8.00 | 20.18 | ≤ 21.00 | Pass |
| 11ax-HE20 | MCS0 | 44 | 5220 | -10.39 | -10.29 | -7.33 | 8.00 | 20.67 | ≤ 21.00 | Pass |
| 11ax-HE20 | MCS0 | 48 | 5240 | -11.04 | -10.88 | -7.95 | 8.00 | 20.05 | ≤ 21.00 | Pass |
| 11ax-HE40 | MCS0 | 38 | 5190 | -10.85 | -10.52 | -7.67 | 8.00 | 20.33 | ≤ 21.00 | Pass |
| 11ax-HE40 | MCS0 | 46 | 5230 | -11.38 | -11.27 | -8.31 | 8.00 | 19.69 | ≤ 21.00 | Pass |
| 11ax-HE80 | MCS0 | 42 | 5210 | -10.19 | -10.16 | -7.16 | 8.00 | 20.84 | ≤ 21.00 | Pass |
| 11ax-HE160 Straddle 5.15-5.25GHz | MCS0 | 50 | 5250 | -12.15 | -11.61 | -8.86 | 8.00 | 19.14 | ≤ 21.00 | Pass |

Note 1: Total Average Power (dBm) = $10 \cdot \log \{10^{(\text{Ant 0 Average Power} / 10)} + 10^{(\text{Ant 1 Average Power} / 10)}\}$.

Note 2: 30 Degree EIRP (dBm) = Total Average Power (dBm) + 30° Ant Gain(dBi).

| | | | |
|--------------------|---|---------------|-----------|
| Test Site | WZ-SR5 | Test Engineer | Cloud Guo |
| Test Date | 2023-09-11~2024-03-22 | | |
| Test Configuration | L23UGSR-5HaxD2HaxD-NM-US (UNII-2a & UNII-2c & UNII-3) | | |

| Test Mode | Data Rate MCS | Channel No. | Freq. (MHz) | Average Power (dBm) | | Total Average Power (dBm) | Power Limit (dBm) |
|------------|------------------|----------------|----------------|------------------------|--------|---------------------------------|----------------------|
| | | | | Ant 0 | Ant 1 | | |
| 11a | 6Mbps | 52 | 5260 | -9.63 | -9.29 | -6.45 | ≤ -0.32 |
| 11a | 6Mbps | 60 | 5300 | -9.23 | -8.95 | -6.08 | ≤ -0.32 |
| 11a | 6Mbps | 64 | 5320 | -9.62 | -9.63 | -6.61 | ≤ -0.32 |
| 11a | 6Mbps | 100 | 5500 | -9.56 | -8.69 | -6.09 | ≤ -0.32 |
| 11a | 6Mbps | 116 | 5580 | -9.80 | -9.20 | -6.48 | ≤ -0.32 |
| 11a | 6Mbps | 140 | 5700 | -7.96 | -10.68 | -6.10 | ≤ -0.32 |
| 11a | 6Mbps | 144 | 5720 | -8.65 | -11.78 | -6.93 | ≤ -1.43 |
| 11a | 6Mbps | 149 | 5745 | 2.49 | 1.09 | 4.86 | ≤ 6.00 |
| 11a | 6Mbps | 157 | 5785 | 2.53 | 1.59 | 5.10 | ≤ 6.00 |
| 11a | 6Mbps | 165 | 5825 | 1.36 | 2.38 | 4.91 | ≤ 6.00 |
| 11ac-VHT20 | MCS0 | 52 | 5260 | -9.32 | -9.17 | -6.23 | ≤ -0.02 |
| 11ac-VHT20 | MCS0 | 60 | 5300 | -9.08 | -8.86 | -5.96 | ≤ -0.02 |
| 11ac-VHT20 | MCS0 | 64 | 5320 | -9.40 | -9.23 | -6.30 | ≤ -0.02 |
| 11ac-VHT20 | MCS0 | 100 | 5500 | -9.75 | -9.18 | -6.45 | ≤ -0.02 |
| 11ac-VHT20 | MCS0 | 116 | 5580 | -9.16 | -8.75 | -5.94 | ≤ -0.02 |
| 11ac-VHT20 | MCS0 | 140 | 5700 | -8.05 | -10.76 | -6.19 | ≤ -0.02 |
| 11ac-VHT20 | MCS0 | 144 | 5720 | -7.78 | -10.81 | -6.03 | ≤ -1.23 |
| 11ac-VHT20 | MCS0 | 149 | 5745 | 2.45 | 1.08 | 4.83 | ≤ 6.00 |
| 11ac-VHT20 | MCS0 | 157 | 5785 | 2.46 | 1.54 | 5.03 | ≤ 6.00 |
| 11ac-VHT20 | MCS0 | 165 | 5825 | 1.45 | 2.51 | 5.02 | ≤ 6.00 |

| Test Mode | Data Rate MCS | Channel No. | Freq. (MHz) | Average Power (dBm) | | Total Average Power (dBm) | Power Limit (dBm) |
|---|------------------|----------------|----------------|------------------------|--------|---------------------------------|----------------------|
| | | | | Ant 0 | Ant 1 | | |
| | | | | 11ac-VHT40 | MCS0 | | |
| 11ac-VHT40 | MCS0 | 62 | 5310 | -7.01 | -7.05 | -4.02 | ≤ -0.02 |
| 11ac-VHT40 | MCS0 | 102 | 5510 | -6.16 | -5.65 | -2.89 | ≤ -0.02 |
| 11ac-VHT40 | MCS0 | 110 | 5550 | -6.57 | -6.48 | -3.51 | ≤ -0.02 |
| 11ac-VHT40 | MCS0 | 134 | 5670 | -4.48 | -6.17 | -2.23 | ≤ -0.02 |
| 11ac-VHT40 | MCS0 | 142 | 5710 | -5.41 | -7.38 | -3.27 | ≤ -0.02 |
| 11ac-VHT40 | MCS0 | 151 | 5755 | 2.29 | 1.96 | 5.14 | ≤ 6.00 |
| 11ac-VHT40 | MCS0 | 159 | 5795 | 1.89 | 0.89 | 4.43 | ≤ 6.00 |
| 11ac-VHT80 | MCS0 | 58 | 5290 | -3.91 | -4.58 | -1.22 | ≤ -0.02 |
| 11ac-VHT80 | MCS0 | 106 | 5530 | -5.21 | -2.45 | -0.60 | ≤ -0.02 |
| 11ac-VHT80 | MCS0 | 122 | 5610 | -4.11 | -3.49 | -0.78 | ≤ -0.02 |
| 11ac-VHT80 | MCS0 | 138 | 5690 | -4.04 | -4.70 | -1.35 | ≤ -0.02 |
| 11ac-VHT80 | MCS0 | 155 | 5775 | 2.38 | 2.10 | 5.25 | ≤ 6.00 |
| 11ac-VHT160 | MCS0 | 50 | 5250 | -8.29 | -8.78 | -5.52 | -- |
| 11ac-VHT160 Straddle 5.25-5.35GHz | MCS0 | 50 | 5250 | -10.93 | -11.40 | -8.15 | ≤ -0.02 |
| 11ac-VHT160 | MCS0 | 114 | 5570 | -4.23 | -3.25 | -0.70 | ≤ -0.02 |
| 11ax-HE20 | MCS0 | 52 | 5260 | -9.29 | -8.95 | -6.11 | ≤ -0.02 |
| 11ax-HE20 | MCS0 | 60 | 5300 | -9.45 | -9.51 | -6.47 | ≤ -0.02 |
| 11ax-HE20 | MCS0 | 64 | 5320 | -8.50 | -8.26 | -5.37 | ≤ -0.02 |
| 11ax-HE20 | MCS0 | 100 | 5500 | -7.95 | -7.32 | -4.61 | ≤ -0.02 |
| 11ax-HE20 | MCS0 | 116 | 5580 | -9.73 | -9.07 | -6.38 | ≤ -0.02 |
| 11ax-HE20 | MCS0 | 140 | 5700 | -8.10 | -10.31 | -6.06 | ≤ -0.02 |
| 11ax-HE20 | MCS0 | 144 | 5720 | -7.88 | -10.48 | -5.98 | ≤ -1.14 |
| 11ax-HE20 | MCS0 | 149 | 5745 | 2.53 | 1.91 | 5.24 | ≤ 6.00 |
| 11ax-HE20 | MCS0 | 157 | 5785 | 2.51 | 2.43 | 5.48 | ≤ 6.00 |
| 11ax-HE20 | MCS0 | 165 | 5825 | 1.04 | 2.45 | 4.81 | ≤ 6.00 |

| Test Mode | Data Rate MCS | Channel No. | Freq. (MHz) | Average Power (dBm) | | Total Average Power (dBm) | Power Limit (dBm) |
|--|------------------|----------------|----------------|------------------------|--------|---------------------------------|----------------------|
| | | | | Ant 0 | Ant 1 | | |
| 11ax-HE40 | MCS0 | 54 | 5270 | -7.43 | -7.43 | -4.42 | ≤ -0.02 |
| 11ax-HE40 | MCS0 | 62 | 5310 | -6.76 | -6.85 | -3.79 | ≤ -0.02 |
| 11ax-HE40 | MCS0 | 102 | 5510 | -6.00 | -5.05 | -2.49 | ≤ -0.02 |
| 11ax-HE40 | MCS0 | 110 | 5550 | -6.61 | -5.87 | -3.21 | ≤ -0.02 |
| 11ax-HE40 | MCS0 | 134 | 5670 | -4.70 | -6.44 | -2.47 | ≤ -0.02 |
| 11ax-HE40 | MCS0 | 142 | 5710 | -5.44 | -7.58 | -3.37 | ≤ -0.02 |
| 11ax-HE40 | MCS0 | 151 | 5755 | 1.75 | 1.85 | 4.81 | ≤ 6.00 |
| 11ax-HE40 | MCS0 | 159 | 5795 | 2.03 | 1.97 | 5.01 | ≤ 6.00 |
| 11ax-HE80 | MCS0 | 58 | 5290 | -3.78 | -3.51 | -0.63 | ≤ -0.02 |
| 11ax-HE80 | MCS0 | 106 | 5530 | -5.34 | -2.73 | -0.83 | ≤ -0.02 |
| 11ax-HE80 | MCS0 | 122 | 5610 | -3.98 | -3.52 | -0.73 | ≤ -0.02 |
| 11ax-HE80 | MCS0 | 138 | 5690 | -4.13 | -4.67 | -1.38 | ≤ -0.02 |
| 11ax-HE80 | MCS0 | 155 | 5775 | 2.45 | 1.61 | 5.06 | ≤ 6.00 |
| 11ax-HE160 | MCS0 | 50 | 5250 | -8.48 | -8.52 | -5.49 | -- |
| 11ax-HE160 Straddle 5.25-5.35GHz | MCS0 | 50 | 5250 | -10.92 | -11.46 | -8.17 | ≤ -0.02 |
| 11ax-HE160 | MCS0 | 114 | 5570 | -4.35 | -3.26 | -0.76 | ≤ -0.02 |

Note 1: Total Average Power (dBm) = $10 \cdot \log \{10^{(\text{Ant 0 Average Power} / 10)} + 10^{(\text{Ant 1 Average Power} / 10)}\}$.

Note 2: For 5250-5350MHz & 5470-5725MHz, the conducted power limit is as below.

802.11a: $11 + 10 \log_{10} (18.55) - (\text{Ant Gain} - 6) = -0.32 < -0.02$ dBm.

802.11ac-VHT20: $11 + 10 \log_{10} (19.95) - (\text{Ant Gain} - 6) = 0 > -0.02$ dBm.

802.11ax-HE20: $11 + 10 \log_{10} (20.24) - (\text{Ant Gain} - 6) = 0.06 > -0.02$ dBm.

802.11ac-VHT40/ax-HE40/ac-VHT80/ax-HE80: $11 + 10 \log_{10} B - (\text{Ant Gain} - 6) > -0.02$ dBm.

Note 3: For Band-Crossing channel, Average Power Limit = $(23.98\text{dBm or } 11 + 10 \cdot \log_{10} \text{EBW}_{2c}) - (\text{Ant Gain} - 6)$ which is less.

A.2 Power Spectral Density Test Result

| | | | |
|--------------------|---|---------------|-----------|
| Test Site | WZ-SR5 | Test Engineer | Cloud Guo |
| Test Date | 2023-09-11 ~ 2024-03-22 | | |
| Test Configuration | L23UGSR-5HaxD2HaxD-US (UNII-Band 1 & UNII-2a & UNII-2c) | | |

| Test Mode | Data Rate/ MCS | Channel No. | Freq. (MHz) | AVPSD | (dBm/ MHz) | Duty Cycle (%) | Total PSD (dBm/ MHz) | PSD Limit (dBm/MHz) |
|------------|-------------------|----------------|----------------|---------|---------------|-------------------|----------------------------|---------------------------|
| | | | | Ant 0 | Ant 1 | | | |
| 11a | 6Mbps | 36 | 5180 | -21.632 | -20.756 | 98.80 | -18.16 | ≤ -8.01 |
| 11a | 6Mbps | 44 | 5220 | -20.842 | -20.538 | 98.80 | -17.68 | ≤ -8.01 |
| 11a | 6Mbps | 48 | 5240 | -20.880 | -20.712 | 98.80 | -17.78 | ≤ -8.01 |
| 11a | 6Mbps | 52 | 5260 | -19.144 | -19.365 | 98.80 | -16.24 | ≤ -16.01 |
| 11a | 6Mbps | 60 | 5300 | -19.966 | -20.305 | 98.80 | -17.12 | ≤ -16.01 |
| 11a | 6Mbps | 64 | 5320 | -19.810 | -20.557 | 98.80 | -17.16 | ≤ -16.01 |
| 11a | 6Mbps | 100 | 5500 | -19.115 | -19.789 | 98.80 | -16.43 | ≤ -16.01 |
| 11a | 6Mbps | 116 | 5580 | -19.893 | -18.891 | 98.80 | -16.35 | ≤ -16.01 |
| 11a | 6Mbps | 140 | 5700 | -18.754 | -19.744 | 98.80 | -16.21 | ≤ -16.01 |
| 11a | 6Mbps | 144 | 5720 | -19.264 | -20.857 | 98.80 | -16.98 | ≤ -16.01 |
| 11ac-VHT20 | MCS0 | 36 | 5180 | -22.044 | -21.265 | 99.62 | -18.63 | ≤ -8.01 |
| 11ac-VHT20 | MCS0 | 44 | 5220 | -21.318 | -20.886 | 99.62 | -18.09 | ≤ -8.01 |
| 11ac-VHT20 | MCS0 | 48 | 5240 | -21.308 | -21.185 | 99.62 | -18.24 | ≤ -8.01 |
| 11ac-VHT20 | MCS0 | 52 | 5260 | -19.891 | -20.191 | 99.62 | -17.03 | ≤ -16.01 |
| 11ac-VHT20 | MCS0 | 60 | 5300 | -19.150 | -19.350 | 99.62 | -16.24 | ≤ -16.01 |
| 11ac-VHT20 | MCS0 | 64 | 5320 | -19.356 | -20.268 | 99.62 | -16.78 | ≤ -16.01 |
| 11ac-VHT20 | MCS0 | 100 | 5500 | -19.688 | -20.104 | 99.62 | -16.88 | ≤ -16.01 |
| 11ac-VHT20 | MCS0 | 116 | 5580 | -20.442 | -19.593 | 99.62 | -16.99 | ≤ -16.01 |
| 11ac-VHT20 | MCS0 | 140 | 5700 | -19.578 | -20.379 | 99.62 | -16.95 | ≤ -16.01 |
| 11ac-VHT20 | MCS0 | 144 | 5720 | -18.695 | -20.605 | 99.62 | -16.54 | ≤ -16.01 |
| 11ac-VHT40 | MCS0 | 38 | 5190 | -24.051 | -23.139 | 98.97 | -20.56 | ≤ -8.01 |
| 11ac-VHT40 | MCS0 | 46 | 5230 | -24.109 | -23.956 | 98.97 | -21.02 | ≤ -8.01 |
| 11ac-VHT40 | MCS0 | 54 | 5270 | -19.374 | -20.653 | 98.97 | -16.96 | ≤ -16.01 |
| 11ac-VHT40 | MCS0 | 62 | 5310 | -18.723 | -20.470 | 98.97 | -16.50 | ≤ -16.01 |
| 11ac-VHT40 | MCS0 | 102 | 5510 | -19.870 | -20.694 | 98.97 | -17.25 | ≤ -16.01 |
| 11ac-VHT40 | MCS0 | 110 | 5550 | -19.899 | -18.888 | 98.97 | -16.35 | ≤ -16.01 |
| 11ac-VHT40 | MCS0 | 134 | 5670 | -19.864 | -18.720 | 98.97 | -16.24 | ≤ -16.01 |
| 11ac-VHT40 | MCS0 | 142 | 5710 | -20.020 | -19.548 | 98.97 | -16.77 | ≤ -16.01 |

| Test Mode | Data Rate/ MCS | Channel No. | Freq. (MHz) | AVPSD | (dBm/ MHz) | Duty Cycle (%) | Total PSD (dBm/ MHz) | PSD Limit (dBm/MHz) |
|-------------|-------------------|----------------|----------------|---------|---------------|-------------------|----------------------------|---------------------------|
| | | | | Ant 0 | Ant 1 | | | |
| 11ac-VHT80 | MCS0 | 42 | 5210 | -24.416 | -25.946 | 99.06 | -22.10 | ≤ -8.01 |
| 11ac-VHT80 | MCS0 | 58 | 5290 | -19.036 | -19.989 | 99.06 | -16.48 | ≤ -16.01 |
| 11ac-VHT80 | MCS0 | 106 | 5530 | -20.278 | -19.472 | 99.06 | -16.85 | ≤ -16.01 |
| 11ac-VHT80 | MCS0 | 122 | 5610 | -20.009 | -18.723 | 99.06 | -16.31 | ≤ -16.01 |
| 11ac-VHT80 | MCS0 | 138 | 5690 | -20.455 | -19.975 | 99.06 | -17.20 | ≤ -16.01 |
| 11ac-VHT160 | MCS0 | 50 | 5250 | -26.284 | -26.390 | 99.47 | -23.33 | ≤ -16.01 |
| 11ac-VHT160 | MCS0 | 114 | 5570 | -22.940 | -21.595 | 99.47 | -19.21 | ≤ -16.01 |
| 11ax-HE20 | MCS0 | 36 | 5180 | -22.232 | -21.766 | 99.62 | -18.98 | ≤ -8.01 |
| 11ax-HE20 | MCS0 | 44 | 5220 | -21.504 | -21.211 | 99.62 | -18.34 | ≤ -8.01 |
| 11ax-HE20 | MCS0 | 48 | 5240 | -21.520 | -21.354 | 99.62 | -18.43 | ≤ -8.01 |
| 11ax-HE20 | MCS0 | 52 | 5260 | -19.925 | -19.819 | 99.62 | -16.86 | ≤ -16.01 |
| 11ax-HE20 | MCS0 | 60 | 5300 | -19.743 | -20.131 | 99.62 | -16.92 | ≤ -16.01 |
| 11ax-HE20 | MCS0 | 64 | 5320 | -18.946 | -19.395 | 99.62 | -16.15 | ≤ -16.01 |
| 11ax-HE20 | MCS0 | 100 | 5500 | -19.193 | -19.862 | 99.62 | -16.50 | ≤ -16.01 |
| 11ax-HE20 | MCS0 | 116 | 5580 | -20.748 | -19.845 | 99.62 | -17.26 | ≤ -16.01 |
| 11ax-HE20 | MCS0 | 140 | 5700 | -19.482 | -20.476 | 99.62 | -16.94 | ≤ -16.01 |
| 11ax-HE20 | MCS0 | 144 | 5720 | -19.056 | -20.521 | 99.62 | -16.72 | ≤ -16.01 |
| 11ax-HE40 | MCS0 | 38 | 5190 | -24.016 | -23.379 | 98.94 | -20.68 | ≤ -8.01 |
| 11ax-HE40 | MCS0 | 46 | 5230 | -24.362 | -24.092 | 98.94 | -21.21 | ≤ -8.01 |
| 11ax-HE40 | MCS0 | 54 | 5270 | -19.501 | -20.514 | 98.94 | -16.97 | ≤ -16.01 |
| 11ax-HE40 | MCS0 | 62 | 5310 | -18.923 | -20.636 | 98.94 | -16.69 | ≤ -16.01 |
| 11ax-HE40 | MCS0 | 102 | 5510 | -19.728 | -19.297 | 98.94 | -16.50 | ≤ -16.01 |
| 11ax-HE40 | MCS0 | 110 | 5550 | -20.325 | -19.262 | 98.94 | -16.75 | ≤ -16.01 |
| 11ax-HE40 | MCS0 | 134 | 5670 | -20.223 | -18.929 | 98.94 | -16.52 | ≤ -16.01 |
| 11ax-HE40 | MCS0 | 142 | 5710 | -20.370 | -19.792 | 98.94 | -17.06 | ≤ -16.01 |
| 11ax-HE80 | MCS0 | 42 | 5210 | -26.394 | -25.916 | 99.20 | -23.1 | ≤ -8.01 |
| 11ax-HE80 | MCS0 | 58 | 5290 | -18.863 | -19.610 | 99.20 | -16.21 | ≤ -16.01 |
| 11ax-HE80 | MCS0 | 106 | 5530 | -20.160 | -19.704 | 99.20 | -16.92 | ≤ -16.01 |
| 11ax-HE80 | MCS0 | 122 | 5610 | -20.158 | -18.902 | 99.20 | -16.47 | ≤ -16.01 |
| 11ax-HE80 | MCS0 | 138 | 5690 | -20.546 | -19.795 | 99.20 | -17.14 | ≤ -16.01 |
| 11ax-HE160 | MCS0 | 50 | 5250 | -26.374 | -26.322 | 99.19 | -23.34 | ≤ -16.01 |
| 11ax-HE160 | MCS0 | 114 | 5570 | -22.889 | -21.764 | 99.19 | -19.28 | ≤ -16.01 |

Note 1: When EUT duty cycle ≥ 98%, the total PSD (dBm/MHz) = $10 \cdot \log \{10^{(\text{Ant 0 AVGPSD}/10)} + 10^{(\text{Ant 1 AVGPSD}/10)}\}$.

Note 2:

For 5150 - 5250MHz Band: PSD Limit (dBm/MHz) = 17 - (31.01 - 6) = -8.01dBm/MHz

For 5250 - 5350MHz Band: PSD Limit (dBm/MHz) = 11 - (33.01 - 6) = -16.01dBm/MHz.

For 5470 - 5725MHz Band: PSD Limit (dBm/MHz) = 11 - (33.01 - 6) = -16.01dBm/MHz.

| | | | |
|--------------------|-------------------------------------|---------------|-----------|
| Test Site | WZ-SR5 | Test Engineer | Cloud Guo |
| Test Date | 2024-03-04~2024-03-22 | | |
| Test Configuration | L23UGSR-5HaxD2HaxD-US (UNII-Band 3) | | |

| Test Mode | Data Rate/ MCS | Channel No. | Freq. (MHz) | AVPSD | | Duty Cycle (%) | Total PSD (dBm/ 510kHz) | PSD Limit (dBm/ 500kHz) |
|------------|-------------------|----------------|----------------|---------|---------|-------------------|-------------------------------|-------------------------------|
| | | | | Ant 0 | Ant 1 | | | |
| 11a | 6Mbps | 149 | 5745 | -11.035 | -10.645 | 98.80 | -7.83 | ≤ 2.99 |
| 11a | 6Mbps | 157 | 5785 | -10.479 | -10.402 | 98.80 | -7.43 | ≤ 2.99 |
| 11a | 6Mbps | 165 | 5825 | -10.299 | -10.304 | 98.80 | -7.29 | ≤ 2.99 |
| 11ac-VHT20 | MCS0 | 149 | 5745 | -11.344 | -11.086 | 99.62 | -8.20 | ≤ 2.99 |
| 11ac-VHT20 | MCS0 | 157 | 5785 | -11.038 | -10.788 | 99.62 | -7.90 | ≤ 2.99 |
| 11ac-VHT20 | MCS0 | 165 | 5825 | -10.754 | -10.751 | 99.62 | -7.74 | ≤ 2.99 |
| 11ac-VHT40 | MCS0 | 151 | 5755 | -12.986 | -12.880 | 98.97 | -9.92 | ≤ 2.99 |
| 11ac-VHT40 | MCS0 | 159 | 5795 | -14.090 | -13.468 | 98.97 | -10.76 | ≤ 2.99 |
| 11ac-VHT80 | MCS0 | 155 | 5775 | -16.055 | -15.657 | 99.06 | -12.84 | ≤ 2.99 |
| 11ax-HE20 | MCS0 | 149 | 5745 | -11.260 | -10.894 | 99.62 | -8.06 | ≤ 2.99 |
| 11ax-HE20 | MCS0 | 157 | 5785 | -10.906 | -10.677 | 99.62 | -7.78 | ≤ 2.99 |
| 11ax-HE20 | MCS0 | 165 | 5825 | -10.523 | -10.578 | 99.62 | -7.54 | ≤ 2.99 |
| 11ax-HE40 | MCS0 | 151 | 5755 | -13.191 | -13.149 | 98.94 | -10.16 | ≤ 2.99 |
| 11ax-HE40 | MCS0 | 159 | 5795 | -13.177 | -12.871 | 98.94 | -10.01 | ≤ 2.99 |
| 11ax-HE80 | MCS0 | 155 | 5775 | -16.176 | -15.923 | 99.20 | -13.04 | ≤ 2.99 |

Note 1:

When EUT duty cycle < 98%, the total PSD (dBm/510kHz) = $10 \cdot \log \{10^{(\text{Ant } 0 \text{ AVGPSD}/10)} + 10^{(\text{Ant } 1 \text{ AVGPSD}/10)}\} + 10 \cdot \log (1/\text{Duty cycle})$.

When EUT duty cycle ≥ 98%, the total PSD (dBm/510kHz) = $10 \cdot \log \{10^{(\text{Ant } 0 \text{ AVGPSD}/10)} + 10^{(\text{Ant } 1 \text{ AVGPSD}/10)}\}$.

Note 2: PSD Limit (dBm/500kHz) = 30 - (33.01 - 6) = 2.99 dBm/500kHz.

802.11a Power Spectral Density- Ant 0

Channel 36 (5180MHz)

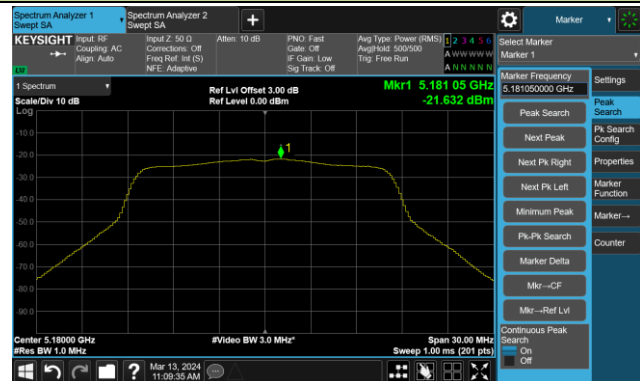

Channel 44 (5220MHz)



Channel 48 (5240MHz)

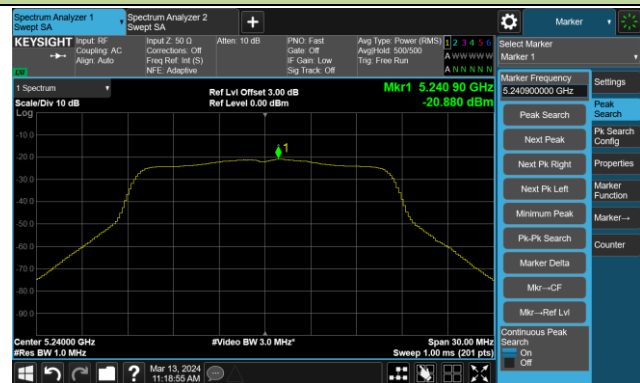

Channel 52 (5260MHz)

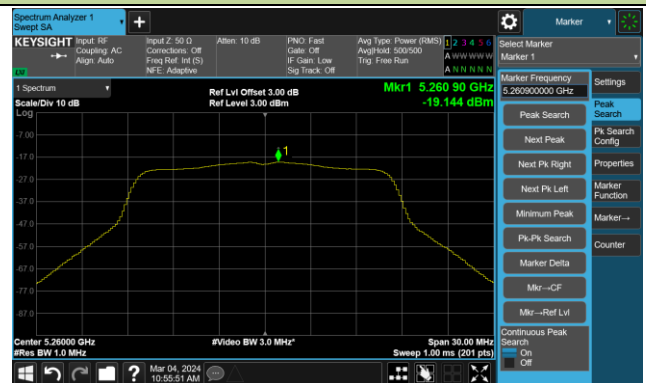

Channel 60 (5300MHz)

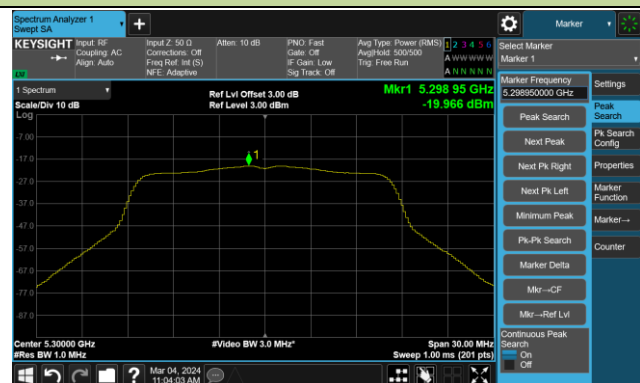

Channel 64 (5320MHz)



Channel 100 (5500MHz)

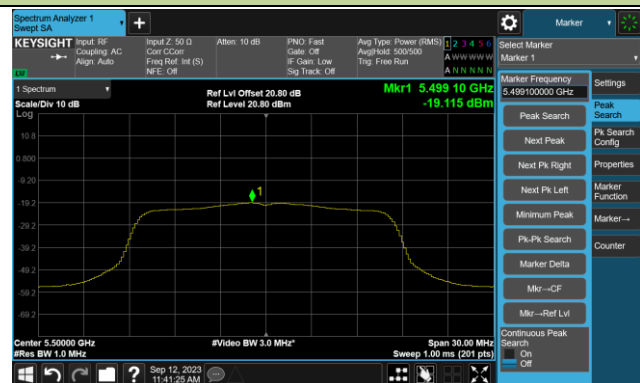

Channel 116 (5580MHz)

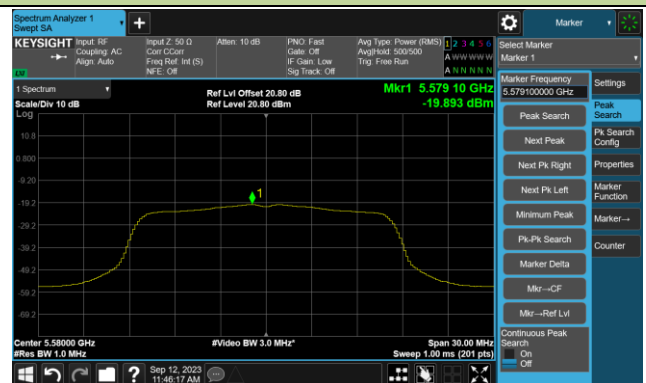

802.11a Power Spectral Density- Ant 0

Channel 140 (5700MHz)



Channel 144(5720MHz)

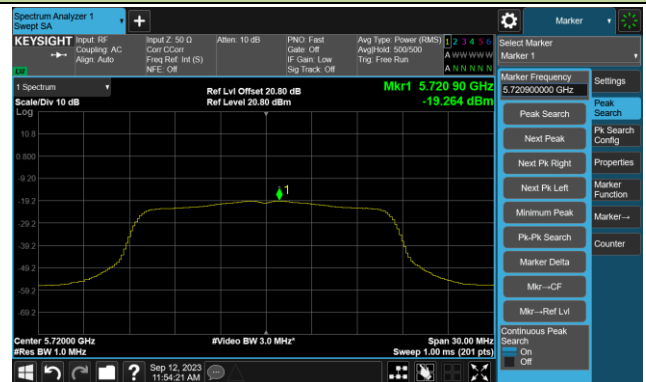

Channel 149 (5745MHz)

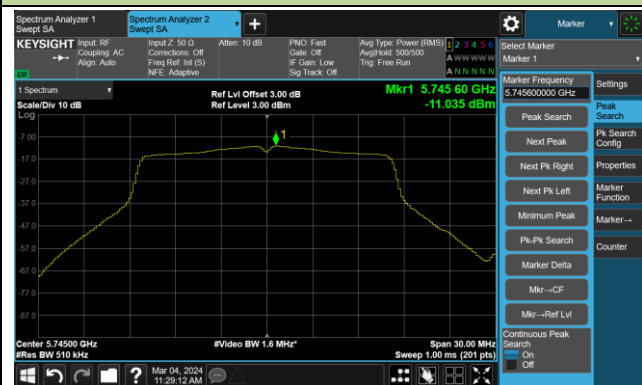

Channel 157 (5785MHz)

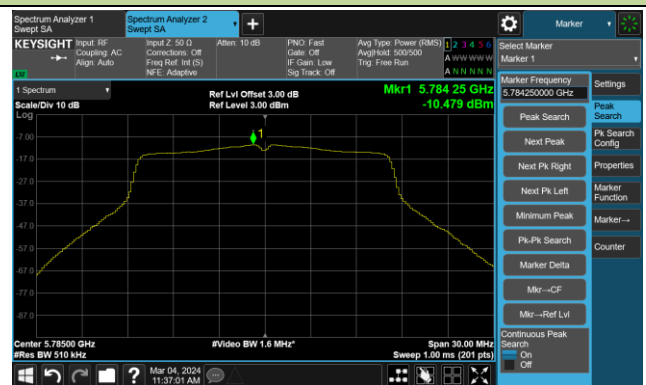

Channel 165 (5825MHz)

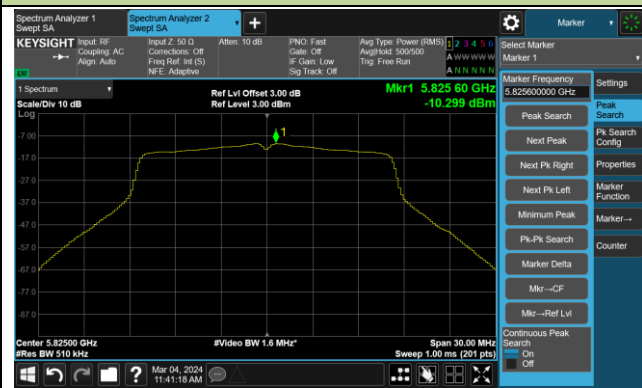

802.11ac-VHT20 Power Spectral Density- Ant 0

Channel 36 (5180MHz)

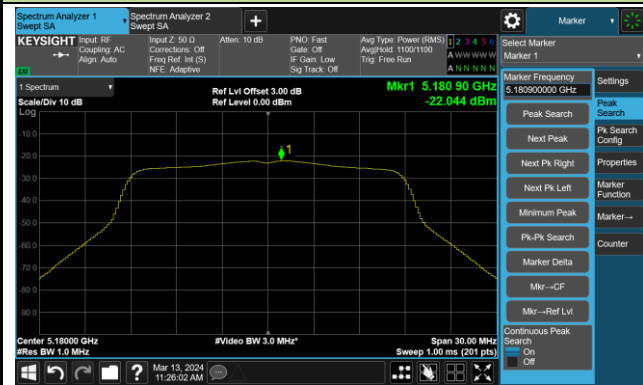

Channel 44 (5220MHz)



Channel 48 (5240MHz)

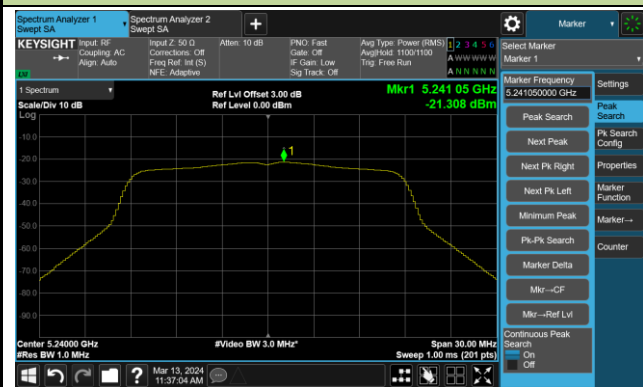

Channel 52 (5260MHz)

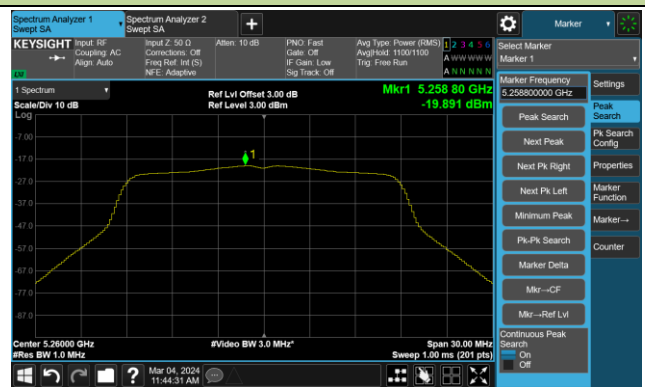

Channel 60 (5300MHz)

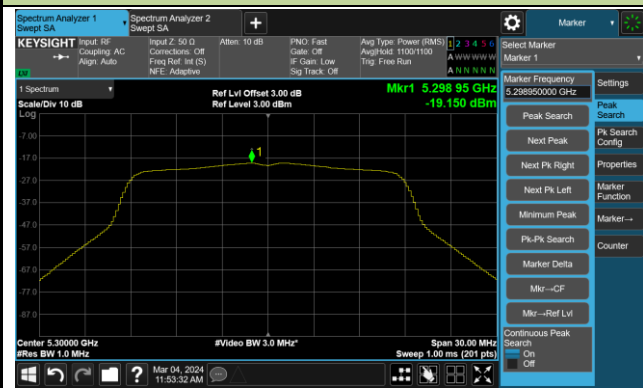

Channel 64 (5320MHz)

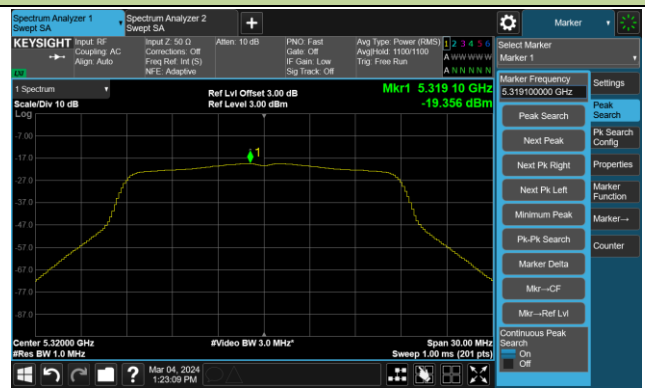

Channel 100 (5500MHz)



Channel 116 (5580MHz)



802.11ac-VHT20 Power Spectral Density- Ant 0

Channel 140 (5700MHz)



Channel 144(5720MHz)

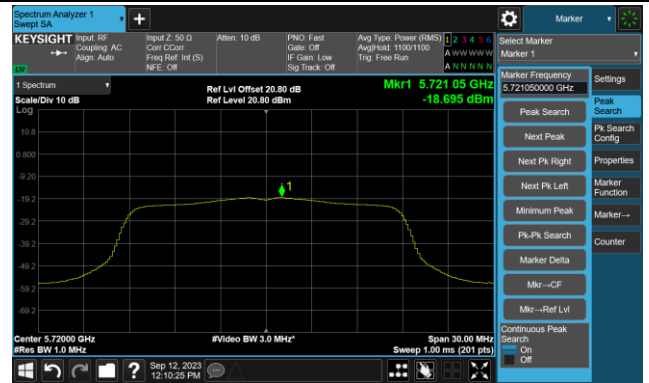

Channel 149 (5745MHz)

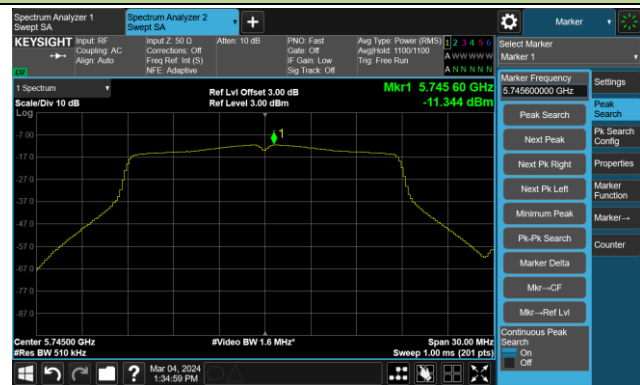

Channel 157 (5785MHz)

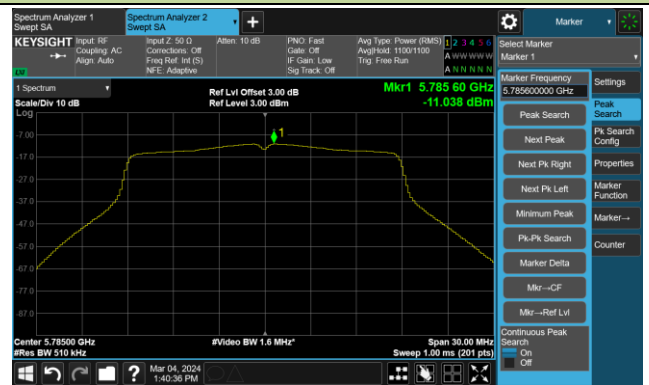

Channel 165 (5825MHz)

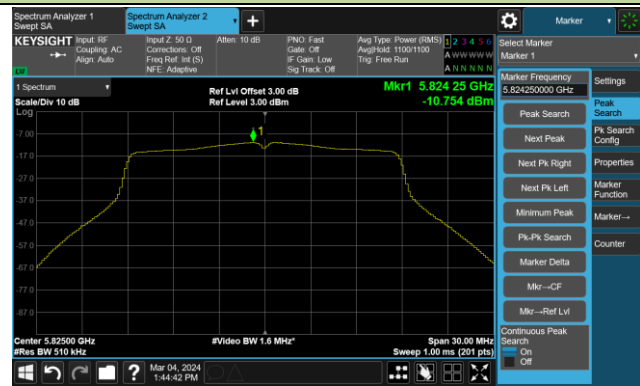

802.11ac-VHT40 Power Spectral Density- Ant 0

Channel 38 (5190MHz)



Channel 46 (5230MHz)



Channel 54 (5270MHz)

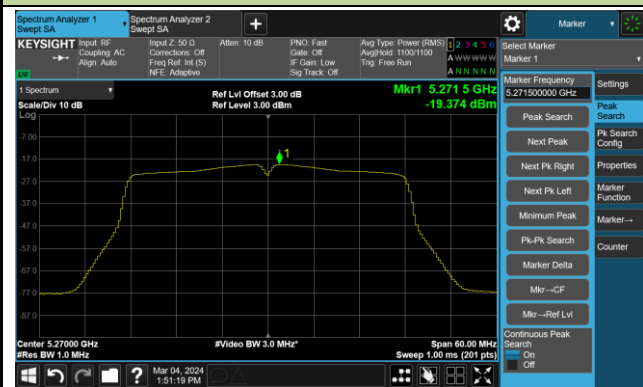

Channel 62 (5310MHz)

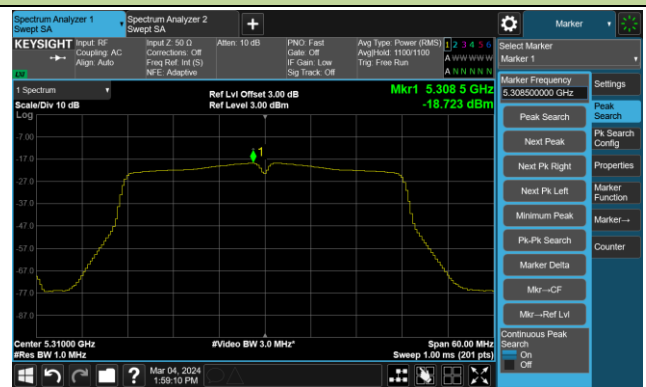

Channel 102 (5510MHz)

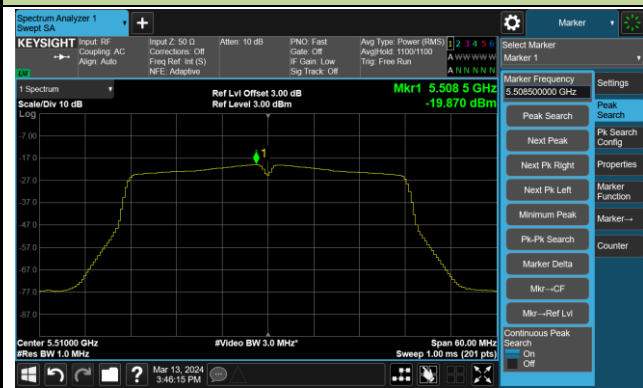

Channel 110 (5550MHz)

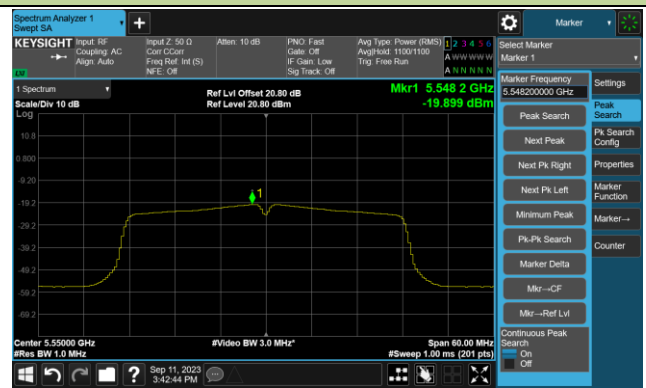

Channel 134 (5670MHz)



Channel 142(5710MHz)



802.11ac-VHT40 Power Spectral Density- Ant 0

Channel 151 (5755MHz)

Channel 159 (5795MHz)



802.11ac-VHT80 Power Spectral Density- Ant 0

Channel 42 (5210MHz)

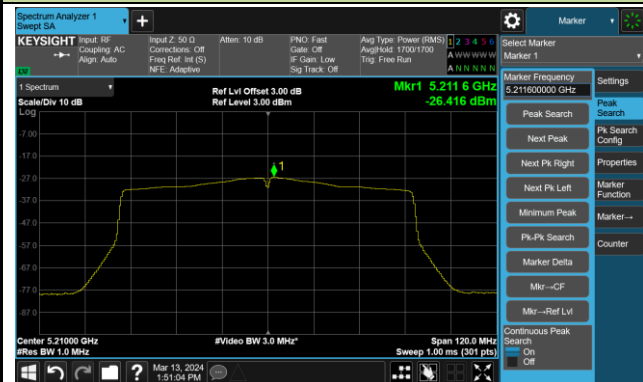

Channel 58 (5290MHz)

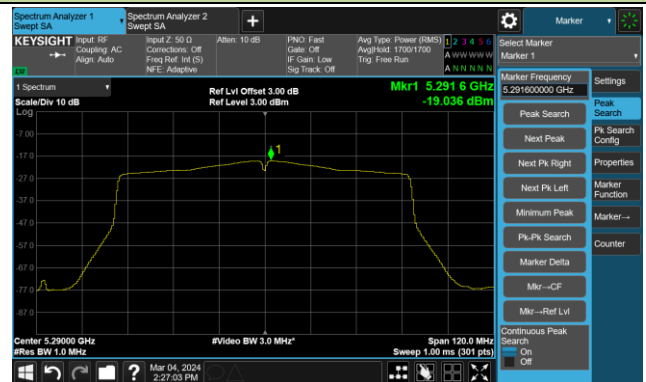

Channel 106 (5530MHz)

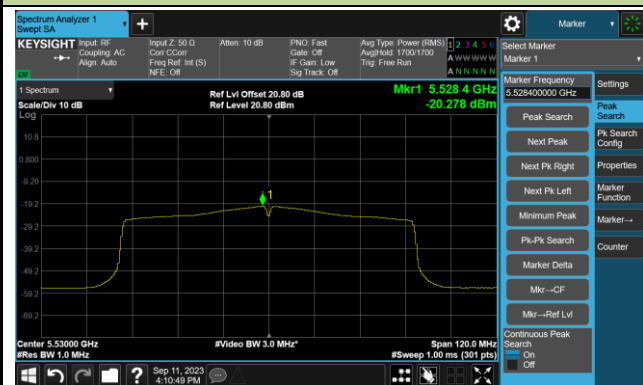

Channel 122 (5610MHz)



Channel 138 (5690MHz)

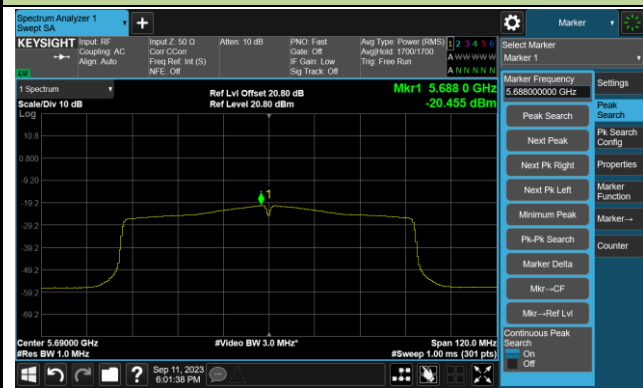

Channel 155 (5775MHz)



802.11ac-VHT160 Power Spectral Density- Ant 0

Channel 50 (5250MHz)

Channel 114 (5570MHz)

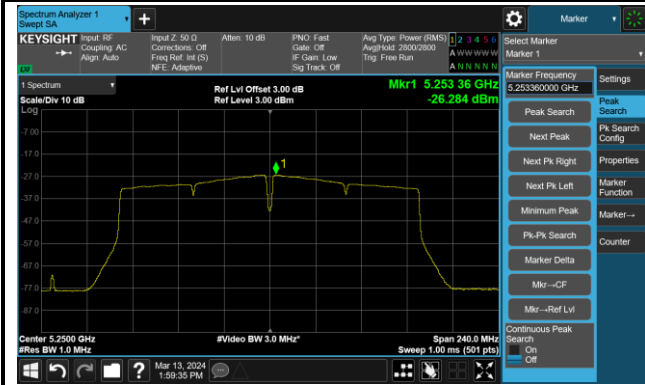

802.11ax-HE20 Power Spectral Density- Ant 0

Channel 36 (5180MHz)

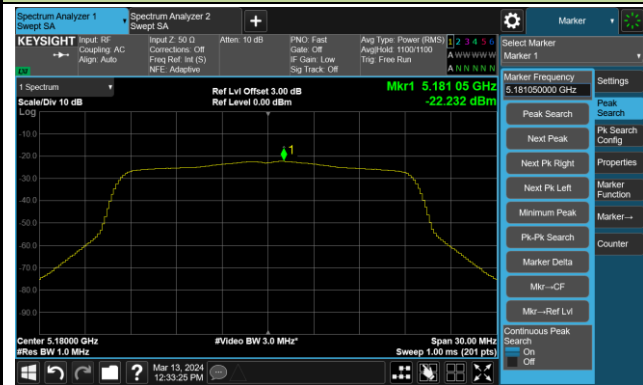

Channel 44 (5220MHz)



Channel 48 (5240MHz)

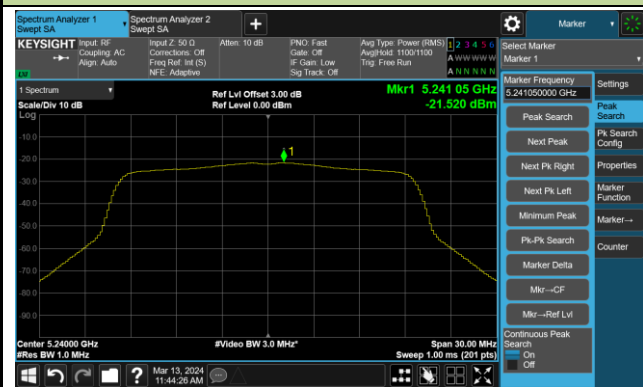

Channel 52 (5260MHz)

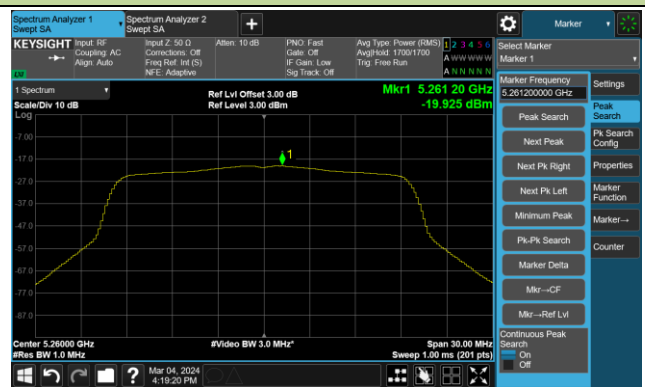

Channel 60 (5300MHz)

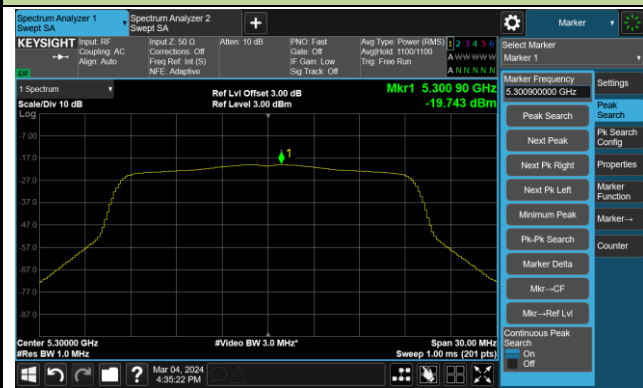

Channel 64 (5320MHz)



Channel 100 (5500MHz)



Channel 116 (5580MHz)

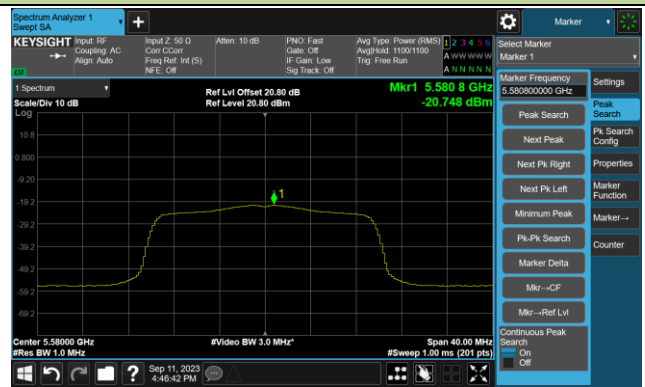

802.11ax-HE20 Power Spectral Density- Ant 0

Channel 140 (5700MHz)



Channel 144(5720MHz)

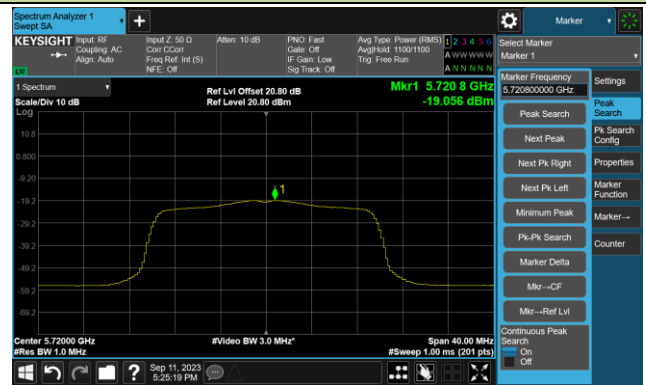

Channel 149 (5745MHz)

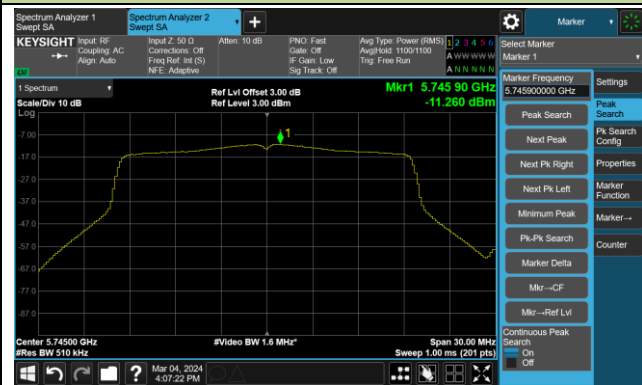

Channel 157 (5785MHz)



Channel 165 (5825MHz)

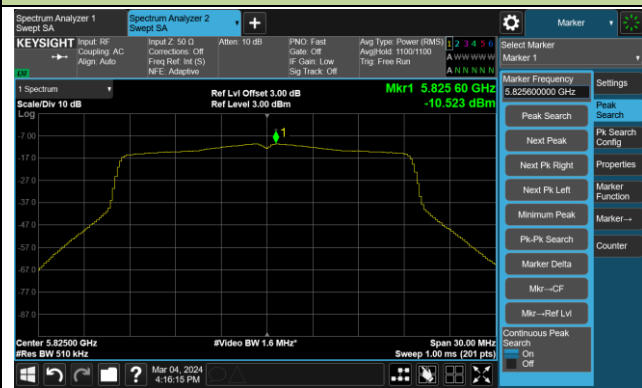

802.11ax-HE40 Power Spectral Density- Ant 0

Channel 38 (5190MHz)



Channel 46 (5230MHz)



Channel 54 (5270MHz)

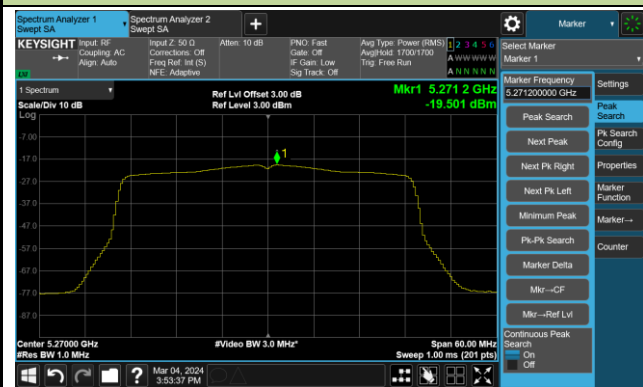

Channel 62 (5310MHz)

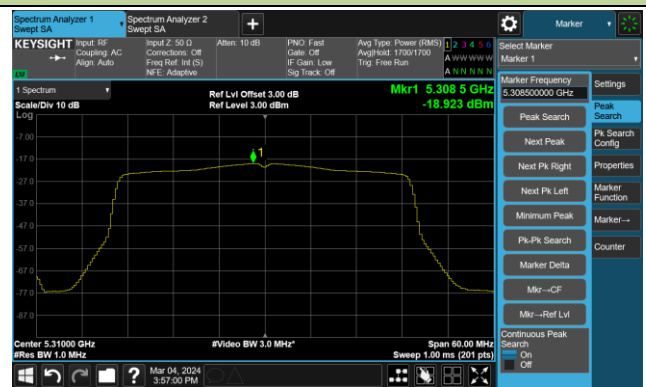

Channel 102 (5510MHz)



Channel 110 (5550MHz)

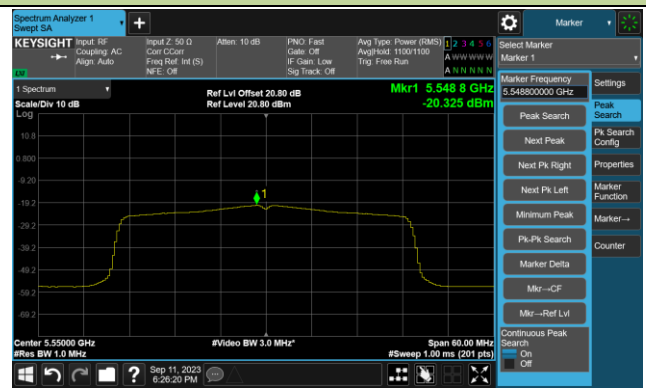

Channel 134 (5670MHz)



Channel 142(5710MHz)



802.11ax-HE40 Power Spectral Density- Ant 0

Channel 151 (5755MHz)

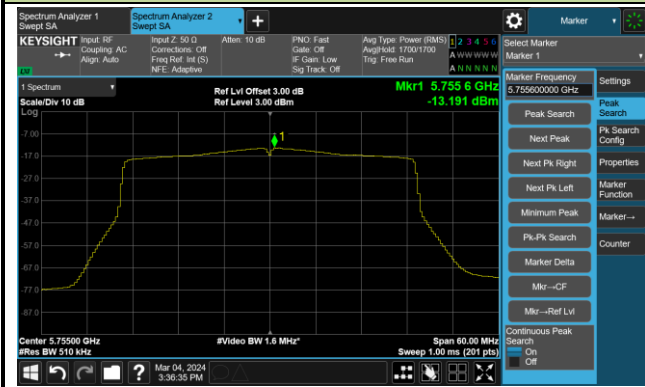

Channel 159 (5795MHz)

