

RF MEASUREMENT REPORT

FCC ID: TV7L23AX52

Applicant: Mikrotiks SIA

Product: mANTBox ax 15s
L23UGSR-5HaxD2HaxD-US
NetMetal ax

Model No.: L22UGS-5HaxD2HaxD-15S-US
L23UGSR-5HaxD2HaxD-US
L23UGSR-5HaxD2HaxD-NM-US

Brand Name: MikroTik

FCC Classification: Digital Transmission System (DTS)

FCC Rule Part(s): Part 15 Subpart C (Section 15.247)

Result: Complies

Received Date: 2023-09-01

Test Date: 2023-09-03 ~ 2024-02-02

Reviewed By:

Vincent Yu

Approved By:

Robin Wu



The test results relate only to the samples tested.

This equipment has been shown to be capable of compliance with the applicable technical standards as indicated in the measurement report and was tested in accordance with the measurement procedures specified in ANSI C63.10-2013. Test results reported herein relate only to the item(s) tested.

The test report shall not be reproduced except in full without the written approval of MRT Technology (Suzhou) Co., Ltd.

Revision History

Report No.	Version	Description	Issue Date	Note
2308RSU089-U1	V01	Initial Report	2024-02-20	Valid

CONTENTS

Description	Page
1. General Information	5
1.1. Applicant	5
1.2. Manufacturer	5
1.3. Testing Facility	5
1.4. Product Information.....	6
1.5. Radio Specification under Test	7
1.6. Working Frequencies	7
1.7. Antenna Details.....	8
2. Test Configuration	9
2.1. Test Mode.....	9
2.2. Test System Connection Diagram.....	10
2.3. Test Software	10
2.4. Applied Standards.....	11
2.5. Test Environment Condition	11
3. Antenna Requirements	12
4. Measuring Instrument	13
5. Decision Rules and Measurement Uncertainty	17
5.1. Decision Rules	17
5.2. Measurement Uncertainty	17
6. Test Result.....	18
6.1. Summary.....	18
6.2. 6dB Bandwidth Measurement.....	19
6.2.1. Test Limit	19
6.2.2. Test Procedure	19
6.2.3. Test Setting	19
6.2.4. Test Setup	19
6.2.5. Test Result	19
6.3. Output Power Measurement	20
6.3.1. Test Limit	20
6.3.2. Test Procedure	20
6.3.3. Test Setting	20
6.3.4. Test Setup	20
6.3.5. Test Result	20
6.4. Power Spectral Density Measurement	21
6.4.1. Test Limit	21

6.4.2.	Test Procedure	21
6.4.3.	Test Setting	21
6.4.4.	Test Setup	21
6.4.5.	Test Result	22
6.5.	Conducted Band Edge and Out-of-Band Emissions Measurement	23
6.5.1.	Test Limit	23
6.5.2.	Test Procedure	23
6.5.3.	Test Setting	23
6.5.4.	Test Setup	23
6.5.5.	Test Result	24
6.6.	Radiated Spurious Emission Measurement.....	25
6.6.1.	Test Limit	25
6.6.2.	Test Procedure	25
6.6.3.	Test Setting	25
6.6.4.	Test Setup	27
6.6.5.	Test Result	28
6.7.	Radiated Restricted Band Edge Measurement	29
6.7.1.	Test Limit	29
6.7.2.	Test Procedure	30
6.7.3.	Test Setting	30
6.7.4.	Test Setup	31
6.7.5.	Test Result	31
6.8.	AC Conducted Emissions Measurement	32
6.8.1.	Test Limit	32
6.8.2.	Test Setup	32
6.8.3.	Test Result	32
Appendix A – Test Result		33
A.1	Duty Cycle Test Result	33
A.2	6dB Bandwidth Test Result	35
A.3	Output Power Test Result	40
A.4	Power Spectral Density Test Result.....	43
A.5	Conducted Band Edge and Out-of-Band Emissions Test Result.....	61
A.6	Radiated Spurious Emission Test Result.....	94
A.7	Radiated Restricted Band Edge Test Result.....	130
A.8	AC Conducted Emissions Test Result	350
Appendix B – Test Setup Photograph		352
Appendix C – EUT Photograph		353

1.4. Product Information

Product Name	L23UGSR-5HaxD2HaxD-US NetMetal ax mANTBox ax 15s
Model No.	L23UGSR-5HaxD2HaxD-US L23UGSR-5HaxD2HaxD-NM-US L22UGS-5HaxD2HaxD-15S-US
EUT Serial No.	L23UGSR-5HaxD2HaxD-US: HEM08J6X3F6/320 L23UGSR-5HaxD2HaxD-NM-US: HER09ACK29G/332 L22UGS-5HaxD2HaxD-15S-US: HFB01TRAQ83 (Radiated Measurement) HFB01P06YS3 (Conducted Measurement)
Wi-Fi Specification	802.11a/b/g/n/ac/ax, VHT
Antenna Information	Refer to section 1.7
Power Type	AC/DC Adapter Input or PoE Input
Operating Environment	Outdoor Use
Accessories	
AC/DC Adapter	Model No.: SAW30-240-1200G Input Power: 100 - 240V ~ 50/60Hz, 0.8A Output Power: 24.0V = 1.2A 28.8W
Gigabit PoE	Input: 18-57V PIN 4, 5: 18-57V PIN 7, 8 Return
Remark: <ol style="list-style-type: none"> The information of EUT was provided by the manufacturer, and the accuracy of the information shall be the responsibility of the manufacturer. PoE needs to be used with an AC adapter. For this report, we select AC Adapter for testing. For detailed model differences, please refer to the Operation Description document. 	

1.5. Radio Specification under Test

Frequency Range	VHT20, 802.11b/g/n-HT20/ax-HE20: 2412 ~ 2462MHz VHT40, 802.11n-HT40/ax-HE40: 2422 ~ 2452MHz	
Channel Number	VHT20, 802.11b/g/n-HT20/ax-HE20: 11 VHT40, 802.11n-HT40/ax-HE40: 7	
Type of Modulation	802.11b: DSSS 802.11g/n: OFDM VHT: OFDM 802.11ax: OFDMA	
Data Rate	802.11b: 1/2/5.5/11Mbps 802.11g: 6/9/12/18/24/36/48/54Mbps 802.11n: up to 300Mbps VHT: up to 400 Mbps 802.11ax: up to 573.6Mbps	
Channel Puncturing Function	<input type="checkbox"/> Supported	<input checked="" type="checkbox"/> Unsupported
Support RU	<input checked="" type="checkbox"/> Full RU	<input type="checkbox"/> Partial RU

1.6. Working Frequencies

VHT20, 802.11b/g/n-HT20/ax-HE20

Channel	Frequency	Channel	Frequency	Channel	Frequency
01	2412 MHz	02	2417 MHz	03	2422 MHz
04	2427 MHz	05	2432 MHz	06	2437 MHz
07	2442 MHz	08	2447 MHz	09	2452 MHz
10	2457 MHz	11	2462 MHz	--	--

VHT40, 802.11n-HT40/ax-HE40

Channel	Frequency	Channel	Frequency	Channel	Frequency
03	2422 MHz	04	2427 MHz	05	2432 MHz
06	2437 MHz	07	2442 MHz	08	2447 MHz
09	2452 MHz	--	--	--	--

1.7. Antenna Details

Product Model No.	Antenna	Frequency Range (MHz)	Tx Paths	Max. PK Gain (dBi)	CDD DG (dBi)	
					For Power	For PSD
L23UGSR-5HaxD2HaxD-US	Omni Antenna	2412 - 2462	2	3.3	3.3	6.31
L23UGSR-5HaxD2HaxD-NM-US						
L22UGS-5HaxD2HaxD-15S-US	Sector Antenna	2412 - 2462	2	12	12	15.01

Notes:

1. The EUT only supports Cyclic Delay Diversity (CDD) mode, and CDD signals are correlated.
2. The antenna information is provided by manufacturer.

2. Test Configuration

2.1. Test Mode

CDD Mode
Mode 1: Transmit by 802.11b _Nss=1 (1Mbps)
Mode 2: Transmit by 802.11g _Nss=1 (6Mbps)
Mode 3: Transmit by 802.11n-HT20 _Nss=1 (MCS0)
Mode 4: Transmit by 802.11n-HT40 _Nss=1 (MCS0)
Mode 5: Transmit by VHT20 _Nss=1 (MCS0)
Mode 6: Transmit by VHT40 _Nss=1 (MCS0)
Mode 7: Transmit by 802.11ax-HE20 _Nss=1 (MCS0)
Mode 8: Transmit by 802.11ax-HE40 _Nss=1 (MCS0)
Notes: <ol style="list-style-type: none">1. EUT supports one configuration only in 802.11ax full RU mode.2. All modes of operation and data rates were investigated, so all RF test requirements shall be executed at the worst data rate.

2.2. Test System Connection Diagram

The device was tested per the guidance ANSI C63.10: 2013 was used to reference the appropriate EUT setup for radiated emissions testing and AC line conducted testing.

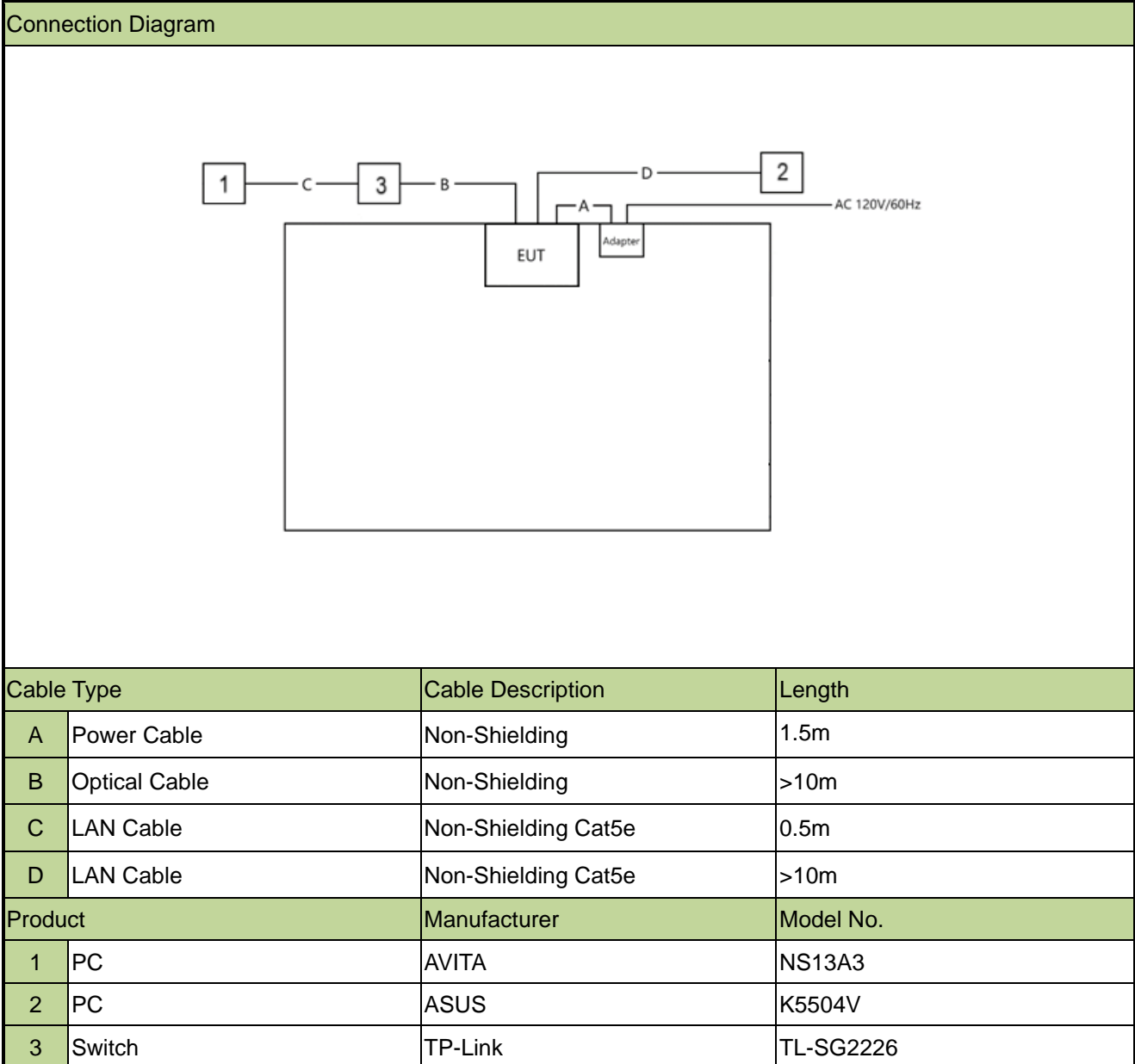

2.3. Test Software

The test utility software used during testing was "winbox.exe", the version was "3.39" and commands are provided by the manufacturer.

2.4. Applied Standards

According to the specifications of the manufacturer, the EUT must comply with the requirements of the following standards:

- FCC Part 15.247
- KDB 558074 D01v05r02
- KDB 662911 D01v02r01
- ANSI C63.10-2013

2.5. Test Environment Condition

Ambient Temperature	15 ~ 35°C
Relative Humidity	20 ~ 75%RH

3. Antenna Requirements

Excerpt from §15.203 of the FCC Rules/Regulations:

“An intentional radiator antenna shall be designed to ensure that no antenna other than that furnished by the responsible party can be used with the device. The use of a permanently attached antenna or of an antenna that uses a unique coupling to the intentional radiator shall be considered sufficient to comply with the provisions of this section.”

- The model L23UGSR-5HaxD2HaxD-US and L23UGSR-5HaxD2HaxD-NM-US use unique antenna connectors.
- The model L22UGS-5HaxD2HaxD-15S-US uses a permanently attached antenna.

Conclusion:

The unit complies with the requirement of §15.203.

4. Measuring Instrument

Instrument	Manufacturer	Model No.	Asset No.	Cali. Interval	Cali. Due Date	Test Site
Anechoic Chamber	RIKEN	SIP-AC1	MRTSUE06554	1 year	2023-12-22	SIP-AC1
					2024-12-21	
Thermohygrometer	testo	608-H1	MRTSUE06616	1 year	2023-10-29	SIP-AC1
					2024-10-28	
Thermohygrometer	testo	608-H1	MRTSUE06620	1 year	2023-11-27	SIP-AC1
					2024-11-03	
TRILOG Antenna	Schwarzbeck	VULB 9168	MRTSUE06645	1 year	2024-07-13	SIP-AC1
Horn Antenna	Schwarzbeck	BBHA 9170	MRTSUE06598	1 year	2023-11-05	SIP-AC2
					2024-11-04	
Preamplifier	EMCI	EMC051845SE	MRTSUE06601	1 year	2023-11-22	SIP-AC2
					2024-11-02	
Thermohygrometer	testo	608-H1	MRTSUE06622	1 year	2023-11-27	SIP-AC2
					2024-11-03	
TRILOG Antenna	Schwarzbeck	VULB 9168	MRTSUE06647	1 year	2024-06-17	SIP-AC2
Anechoic Chamber	RIKEN	SIP-AC2	MRTSUE06781	1 year	2023-12-22	SIP-AC2
					2024-12-21	
Horn Antenna	Schwarzbeck	BBHA 9120D	MRTSUE06648	1 year	2023-10-22	SIP-AC2
					2024-10-21	
EMI Test Receiver	R&S	ESR3	MRTSUE06185	1 year	2023-12-28	SIP-AC1/SIP-AC2
					2024-12-17	/SIP-AC3
Preamplifier	EMCI	EMC184045SE	MRTSUE06602	1 year	2023-10-10	SIP-AC1/SIP-AC2
					2024-10-09	/SIP-AC3
EMI Test Receiver	R&S	ESR3	MRTSUE06613	1 year	2024-05-23	SIP-AC1/SIP-AC2 /SIP-AC3
Preamplifier	EMCI	EMC001330	MRTSUE06643	1 year	2024-01-12	SIP-AC1/SIP-AC2
					2025-01-11	/SIP-AC3
Loop Antenna	Schwarzbeck	FMZB 1519 B	MRTSUE06937	1 year	2024-02-26	SIP-AC1/SIP-AC2 /SIP-AC3
Signal Analyzer	Keysight	N9010B	MRTSUE07028	1 year	2023-11-25	SIP-AC1/SIP-AC2
					2024-10-23	/SIP-AC3
Signal Analyzer	Keysight	N9010B	MRTSUE06559	1 year	2024-05-23	SIP-AC1/SIP-AC2 /SIP-AC3
Signal Analyzer	Keysight	N9010B	MRTSUE06603	1 year	2023-10-25	SIP-AC1/SIP-AC2
					2024-09-27	/SIP-AC3

Instrument	Manufacturer	Model No.	Asset No.	Cali. Interval	Cali. Due Date	Test Site
Horn Antenna	Schwarzbeck	BBHA 9170	MRTSUE06599	1 year	2023-10-13	SIP-AC1/SIP-AC3
					2024-09-24	
Preamplifier	Schwarzbeck	BBV 9721	MRTSUE06121	1 year	2024-06-07	SIP-AC3
Horn Antenna	R&S	HF907	MRTSUE06611	1 year	2024-07-14	SIP-AC3
Thermohygrometer	testo	608-H1	MRTSUE06619	1 year	2023-11-01	SIP-AC3
					2024-10-28	
Preamplifier	EMCI	EMC012645SE	MRTSUE06642	1 year	2024-01-12	SIP-AC3
					2025-01-11	
TRILOG Antenna	Schwarzbeck	VULB 9168	MRTSUE06646	1 year	2024-08-04	SIP-AC3
Anechoic Chamber	RIKEN	SIP-AC3	MRTSUE06782	1 year	2023-12-22	SIP-AC3
					2024-12-21	
Thermohygrometer	testo	608-H1	MRTSUE11255	1 year	2024-08-13	SIP-AC3
Horn Antenna	Schwarzbeck	BBHA 9120D	MRTSUE06023	1 year	2024-08-09	WZ-AC1
Preamplifier	Agilent	83017A	MRTSUE06076	1 year	2024-05-07	WZ-AC1
Anechoic Chamber	TDK	WZ-AC1	MRTSUE06212	1 year	2024-04-20	WZ-AC1
Thermohygrometer	testo	608-H1	MRTSUE06403	1 year	2024-05-31	WZ-AC1
Signal Analyzer	Keysight	N9010B	MRTSUE06607	1 year	2023-12-28	WZ-AC1
					2024-10-23	
Thermohygrometer	testo	608-H1	MRTSUE11039	1 year	2023-11-01	WZ-AC1
					2024-10-25	
Loop Antenna	Schwarzbeck	FMZB 1519	MRTSUE06025	1 year	2023-09-25	WZ-AC2
					2024-09-17	
Horn Antenna	Schwarzbeck	BBHA 9170	MRTSUE06597	1 year	2023-11-05	WZ-AC2
					2024-11-04	
Preamplifier	EMCI	EMC184045SE	MRTSUE06640	1 year	2024-01-12	WZ-AC2
					2025-01-11	
TRILOG Antenna	Schwarzbeck	VULB 9162	MRTSUE06022	1 year	2024-05-15	WZ-AC2
Horn Antenna	Schwarzbeck	BBHA 9120D	MRTSUE06171	1 year	2023-10-13	WZ-AC2
					2024-10-11	
Preamplifier	Schwarzbeck	BBV 9718	MRTSUE06176	1 year	2024-05-07	WZ-AC2
Anechoic Chamber	RIKEN	WZ-AC2	MRTSUE06213	1 year	2024-04-20	WZ-AC2
Thermohygrometer	testo	608-H1	MRTSUE11038	1 year	2023-11-01	WZ-AC2
					2024-10-25	
Thermohygrometer	testo	608-H1	MRTSUE11263	1 year	2024-11-07	WZ-AC2
Thermohygrometer	Mingle	ETH529	MRTSUE06170	1 year	2023-11-27	WZ-AC2

Instrument	Manufacturer	Model No.	Asset No.	Cali. Interval	Cali. Due Date	Test Site
Signal Analyzer	Keysight	N9010B	MRTSUE06607	1 year	2023-12-28	WZ-AC1/WZ-AC2
					2024-10-24	
Two-Line V-Network	R&S	ENV216	MRTSUE06002	1 year	2024-05-23	WZ-SR2
Shielding Room	MIX-BEP	WZ-SR2	MRTSUE06215	5 years	2026-12-20	WZ-SR2
Thermohygrometer	testo	608-H1	MRTSUE06404	1 year	2024-05-31	WZ-SR2
Four-Line V-Network	R&S	ENV432	MRTSUE06615	1 year	2024-09-27	WZ-SR2
EMI Test Receiver	R&S	ESR3	MRTSUE06909	1 year	2024-09-27	WZ-SR2
USB Power Sensor	Keysight	U2021XA	MRTSUE06447	1 year	2024-05-23	WZ-SR5
USB Power Sensor	Agilent	U2021XA	MRTSUE06030	1 year	2023-10-08	WZ-SR5
					2024-09-27	
Thermohygrometer	testo	608-H1	MRTSUE06402	1 year	2024-05-31	WZ-SR5
Shielding Room	HUAMING	WZ-SR5	MRTSUE06442	N/A	N/A	WZ-SR5
Signal Analyzer	Keysight	N9010B	MRTSUE06457	1 year	2024-05-23	WZ-SR5
Signal Analyzer	Keysight	N9010B	MRTSUE06558	1 year	2024-05-23	WZ-SR5
Audio Analyzer	R&S	UPV	MRTSUE06357	1 year	2024-04-27	WZ-SR5
Signal Analyzer	Keysight	N9020B	MRTSUE07037	1 year	2024-02-29	WZ-SR5
Attenuator	MVE	MVE2213	MRTSUE11086	1 year	2024-06-08	WZ-SR5
Attenuator	MVE	MVE2213	MRTSUE11087	1 year	2024-06-08	WZ-SR5
Attenuator	MVE	MVE2213	MRTSUE11088	1 year	2024-06-08	WZ-SR5
Attenuator	MVE	MVE2213	MRTSUE11089	1 year	2024-06-08	WZ-SR5
Attenuator	MVE	MVE2213	MRTSUE11090	1 year	2024-06-08	WZ-SR5
Temperature Chamber	BAOYT	BYG-408CS	MRTSUE06847	1 year	2024-02-12	SIP-TR1
Thermohygrometer	testo	608-H1	MRTSUE11022	1 year	2023-11-01	SIP-TR1
					2024-10-28	
USB Power Sensor	Keysight	U8489A	MRTSUE06448	5 years	2028-07-11	SIP-TR1
Signal Analyzer	Keysight	N9030B	MRTSUE06395	1 year	2024-06-29	SIP-TR1
Signal Analyzer	Keysight	N9030B	MRTSUE06395	1 year	2024-06-29	SIP-TR1
Attenuator	MVE	MVE2213	MRTSUE11099	1 year	2024-06-08	SIP-TR1
Attenuator	MVE	MVE2213	MRTSUE11100	1 year	2024-06-08	SIP-TR1
Attenuator	MVE	MVE2213	MRTSUE11101	1 year	2024-06-08	SIP-TR1
Attenuator	MVE	MVE2213	MRTSUE11103	1 year	2024-06-08	SIP-TR1
Attenuator	MVE	MVE2213	MRTSUE11099	1 year	2024-06-08	SIP-TR1

Software	Version	Function
EMI V3	V 3.0.0	EMI Test Software
Controller_MF 7802	2.03C	RE Antenna & Turntable
Controller_MF 7802	1.02	RE Antenna & Turntable
Controller_MF 7802BS	1.02	RE Antenna & Turntable
BenchVue Power Meter	2018.1	Power

5. Decision Rules and Measurement Uncertainty

5.1. Decision Rules

The Decision Rule is based on Simple Acceptance in accordance with ISO Guide 98-4: 2012 Clause 8.2. (Measurement uncertainty is not taken into account when stating conformity with a specified requirement.)

5.2. Measurement Uncertainty

Where relevant, the following test uncertainty levels have been estimated for tests performed on the EUT as specified in CISPR 16-4-2. This uncertainty represents an expanded uncertainty expressed at approximately the 95% confidence level using a coverage factor of $k = 2$.

AC Conducted Emission Measurement
The maximum measurement uncertainty is evaluated as: 9kHz~150kHz: 3.58dB 150kHz~30MHz: 3.20dB
Radiated Emission Measurement
The maximum measurement uncertainty is evaluated as: Coaxial: 9kHz~30MHz: 2.61dB Coplanar: 9kHz~30MHz: 2.62dB Horizontal: 30MHz~200MHz: 3.79dB 200MHz~1GHz: 3.91dB 1GHz~40GHz: 4.99dB Vertical: 30MHz~200MHz: 4.06dB 200MHz~1GHz: 5.21dB 1GHz~40GHz: 4.90dB
Spurious Emissions, Conducted
Measuring Uncertainty for a Level of Confidence of 95% ($U=2Uc(y)$): 2.2dB
Output Power
Measuring Uncertainty for a Level of Confidence of 95% ($U=2Uc(y)$): 1.4dB
Power Spectrum Density
Measuring Uncertainty for a Level of Confidence of 95% ($U=2Uc(y)$): 2.2dB
Occupied Bandwidth
Measuring Uncertainty for a Level of Confidence of 95% ($U=2Uc(y)$): 2.7%

6. Test Result

6.1. Summary

FCC Section(s)	Test Description	Test Condition	Verdict
15.247(a)(2)	6dB Bandwidth	Conducted	Pass
15.247(b)(3)	Output Power		Pass
15.247(e)	Power Spectral Density		Pass
15.247(d)	Band Edge / Out-of-Band Emissions		Pass
15.205 15.209	General Field Strength (Restricted Bands and Radiated Emission)	Radiated	Pass
15.207	AC Conducted Emissions 150kHz - 30MHz	Line Conducted	Pass

Notes:

- The analyzer plots shown in this section were all taken with a correction table loaded into the analyzer. The correction table was used to account for the losses of the cables and attenuators used as part of the system to connect the EUT to the analyzer at all frequencies of interest.
- For radiated emission tests, every axis (X, Y, Z) was also verified. The test results shown in the following sections represent the worst-case emissions.
- The test evaluation of each model is as follows.
 - The L23UGSR-5HaxD2HaxD-US as a reference device, full test was performed on it.
 - For the 2.4GHz RF part, L23UGSR-5HaxD2HaxD-NM-US and L23UGSR-5HaxD2HaxD-US are identical except the antenna connectors on the PCB board. Therefore, performed full test was performed on RF Output Power and General Field Strength for L23UGSR-5HaxD2HaxD-NM-US.
 - For the 2.4GHz RF Part, L22UGS-5HaxD2HaxD-15S-US and L23UGSR-5HaxD2HaxD-US are identical, except that L22UGS-5HaxD2HaxD-15S-US uses a higher gain antenna. Therefore, full test was performed on Output Power, Power Spectral Density and General Field Strength for L22UGS-5HaxD2HaxD-15S-US.

6.2. 6dB Bandwidth Measurement

6.2.1. Test Limit

The minimum 6dB bandwidth shall be at least 500 kHz.

6.2.2. Test Procedure

ANSI C63.10 - 2013 - Section 11.8

6.2.3. Test Setting

1. The Spectrum's automatic bandwidth measurement capability was used to perform the 6dB bandwidth measurement. The "X" dB bandwidth parameter was set to $X = 6$. The bandwidth measurement was not influenced by any intermediate power nulls in the fundamental emission.
2. Set RBW = 100 kHz
3. VBW $\geq 3 \times$ RBW
4. Detector = Peak
5. Trace mode = Max hold
6. Sweep = Auto couple
7. Allow the trace to stabilize.

6.2.4. Test Setup

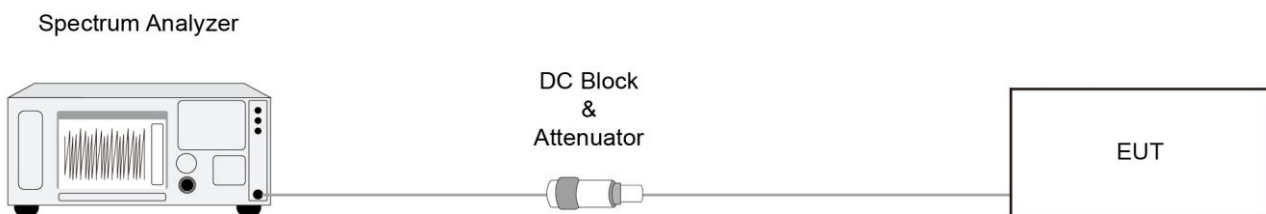

6.2.5. Test Result

Refer to Appendix A.2.

6.3. Output Power Measurement

6.3.1. Test Limit

The maximum output power shall be less 1 Watt (30dBm).

The conducted output power limit specified in paragraph FCC Part 15.247(b) of this section is based on the use of antennas with directional gains that do not exceed 6 dBi. If transmitting antennas of directional gain greater than 6 dBi are used, the conducted output power from the intentional radiator shall be reduced below the stated values in paragraphs FCC Part 15.247(b)(3) of this section, as appropriate, by the amount in dB that the directional gain of the antenna exceeds 6 dBi.

6.3.2. Test Procedure

ANSI C63.10 - 2013 - Section 11.9.2.3.2

6.3.3. Test Setting

Average Power Measurement

Average power measurements were performed only when the EUT was transmitting at its maximum power control level using a broadband power meter with a pulse sensor. The power meter implemented triggering and gating capabilities which were set up such that power measurements were recorded only during the ON time of the transmitter.

6.3.4. Test Setup

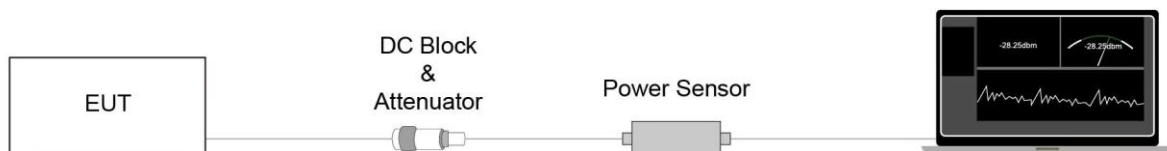

6.3.5. Test Result

Refer to Appendix A.3.

6.4. Power Spectral Density Measurement

6.4.1. Test Limit

The maximum permissible power spectral density is 8dBm in any 3 kHz band.

The same method of determining the conducted output power shall be used to determine the power spectral density.

6.4.2. Test Procedure

ANSI C63.10 - 2013 - Section 11.10.5

6.4.3. Test Setting

1. Measure the duty cycle (x) of the transmitter output signal.
2. Set instrument center frequency to DTS channel center frequency.
3. Set span to at least 1.5 times the OBW.
4. RBW = 10 kHz.
5. VBW = 30 kHz.
6. Detector = RMS.
7. Ensure that the number of measurement points in the sweep $\geq 2 \times \text{span}/\text{RBW}$.
8. Sweep time = auto couple.
9. Don't use sweep triggering. Allow sweep to "free run".
10. Employ trace averaging (RMS) mode over a minimum of 100 traces.
11. Use the peak marker function to determine the maximum amplitude level.
12. Add $10 \log (1/x)$, where x is the duty cycle measured in step (a), to the measured PSD to compute the average PSD during the actual transmission time. If measured value exceeds requirement specified by regulatory agency, then reduce RBW (but no less than 3 kHz) and repeat (note that this may require zooming in on the emission of interest and reducing the span to meet the minimum measurement point requirement as the RBW is reduced).

6.4.4. Test Setup

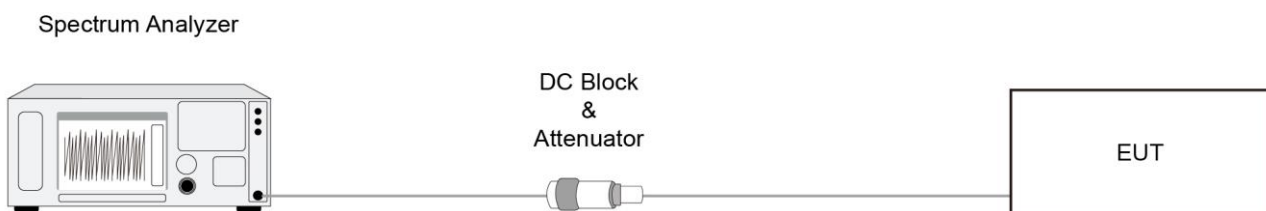

6.4.5. Test Result

Refer to Appendix A.4.

6.5. Conducted Band Edge and Out-of-Band Emissions Measurement

6.5.1. Test Limit

The limit for out-of-band spurious emissions at the band edge is 30dB below the fundamental emission level, as determined from the in-band power measurement of the DTS channel performed in a 100 kHz bandwidth per the PSD procedure.

6.5.2. Test Procedure

ANSI C63.10-2013 - Section 11.11

6.5.3. Test Setting

Reference level measurement

1. Set instrument center frequency to DTS channel center frequency
2. Set the span to ≥ 1.5 times the DTS bandwidth
3. Set the RBW = 100 kHz
4. Set the VBW $\geq 3 \times$ RBW
5. Detector = peak
6. Sweep time = auto couple
7. Trace mode = max hold
8. Allow trace to fully stabilize

Emission level measurement

1. Set the center frequency and span to encompass frequency range to be measured
2. RBW = 100kHz
3. VBW = 300kHz
4. Detector = Peak
5. Trace mode = max hold
6. Sweep time = auto couple
7. The trace was allowed to stabilize

6.5.4. Test Setup

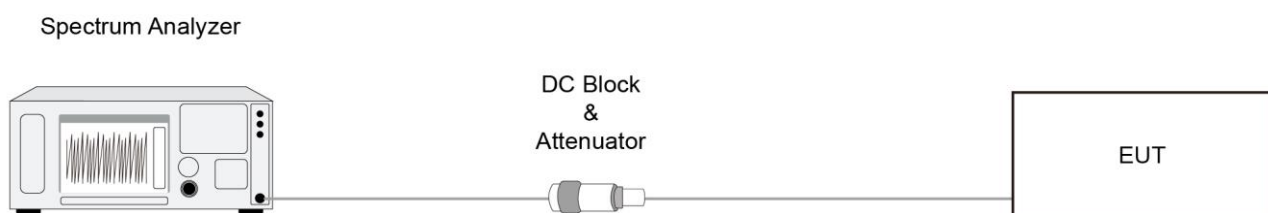

6.5.5. Test Result

Refer to Appendix A.5.

6.6. Radiated Spurious Emission Measurement

6.6.1. Test Limit

All out of band emissions appearing in a restricted band as specified in Section 15.205 of the Title 47 CFR must not exceed the limits shown in Table per Section 15.209.

FCC Part 15 Subpart C Paragraph 15.209		
Frequency [MHz]	Field Strength [$\mu\text{V/m}$]	Measured Distance [Meters]
0.009 - 0.490	2400/F (kHz)	300
0.490 - 1.705	24000/F (kHz)	30
1.705 - 30	30	30
30 - 88	100	3
88 - 216	150	3
216 - 960	200	3
Above 960	500	3

6.6.2. Test Procedure

ANSI C63.10 - 2013 - Section 11.11 & 11.12

ANSI C63.10 - 2013 - Section 6.3 (General Requirements)

ANSI C63.10 - 2013 - Section 6.4 (Standard test method below 30MHz)

ANSI C63.10 - 2013 - Section 6.5 (Standard test method above 30MHz to 1GHz)

ANSI C63.10 - 2013 - Section 6.6 (Standard test method above 1GHz)

6.6.3. Test Setting

Table 1 - RBW as a function of frequency

Frequency	RBW
9 ~ 150 kHz	200 ~ 300 Hz
0.15 ~ 30 MHz	9 ~ 10 kHz
30 ~ 1000 MHz	100 ~ 120 kHz
> 1000MHz	1MHz

Quasi-Peak Measurements below 1GHz

1. Analyzer center frequency was set to the frequency of the radiated spurious emission of interest
2. Span was set greater than 1MHz
3. RBW = as specified in Table 1
4. Detector = CISPR quasi-peak
5. Sweep time = auto couple
6. Trace was allowed to stabilize

Peak Measurements above 1GHz

1. Analyzer center frequency was set to the frequency of the radiated spurious emission of interest
2. RBW = 1MHz
3. VBW = 3MHz
4. Detector = peak
5. Sweep time = auto couple
6. Trace mode = max hold
7. Trace was allowed to stabilize

Average Measurements above 1GHz (Method VB)

1. Analyzer center frequency was set to the frequency of the radiated spurious emission of interest
2. RBW = 1MHz
3. VBW; If the EUT is configured to transmit with duty cycle $\geq 98\%$, set VBW = 10 Hz.
If the EUT duty cycle is $< 98\%$, set VBW $\geq 1/T$. T is the minimum transmission duration.
4. Detector = Peak
5. Sweep time = auto
6. Trace mode = max hold
7. Trace was allowed to stabilize

6.6.4. Test Setup

Below 30MHz Test Setup:

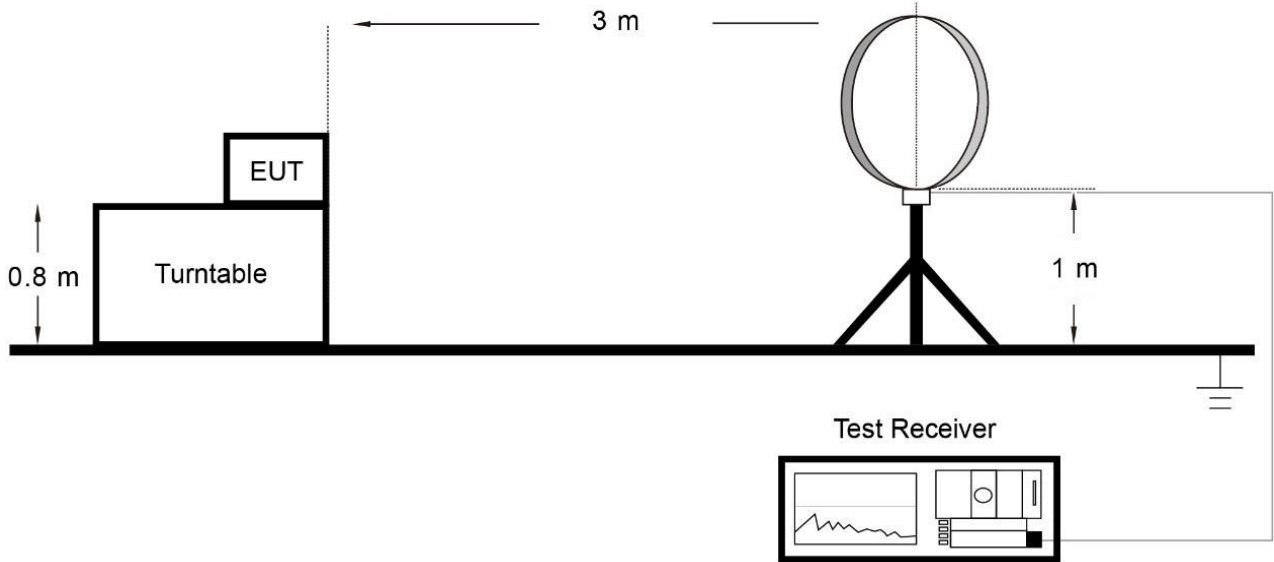

Below 1GHz Test Setup:

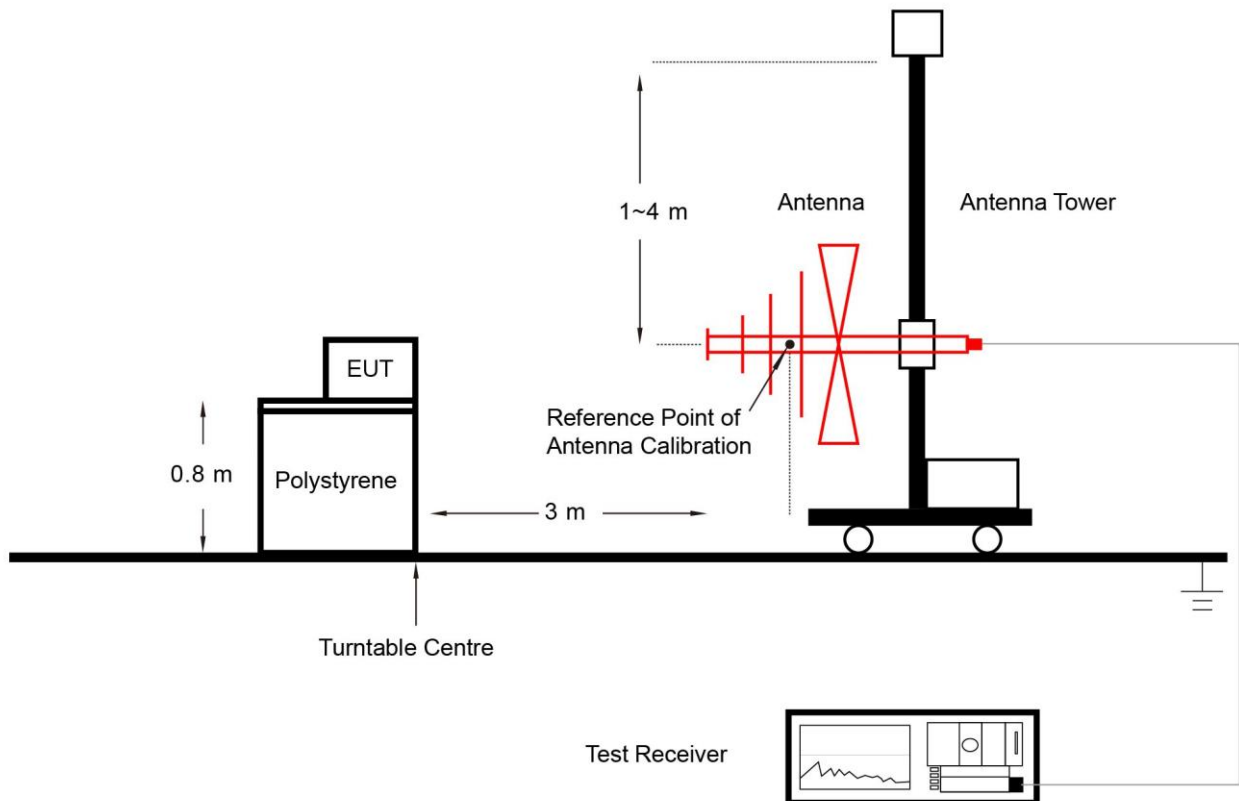

Above 1GHz Test Setup:

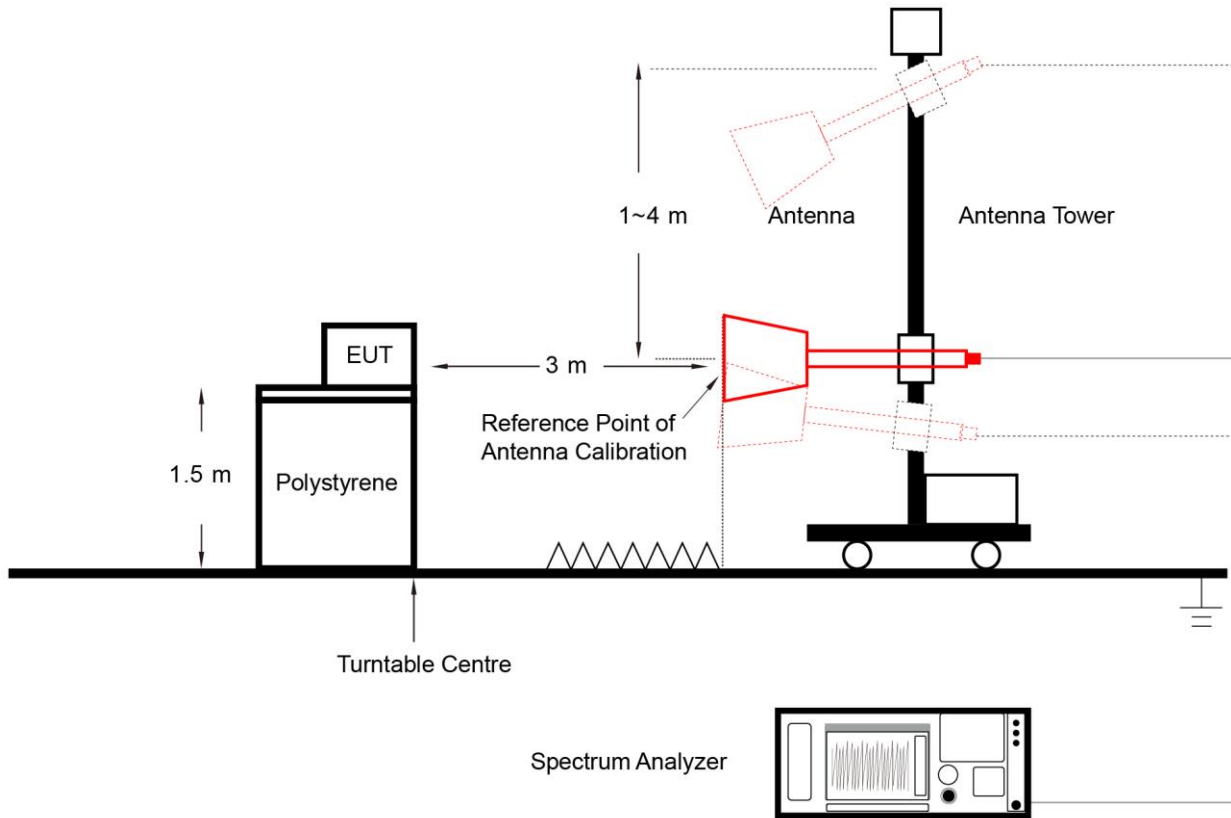

6.6.5. Test Result

Refer to Appendix A.6.

6.7. Radiated Restricted Band Edge Measurement

6.7.1. Test Limit

For 15.205 requirement:

Radiated emissions which fall in the restricted bands, as defined in Section 15.205(a) of FCC part 15, must also comply with the radiated emission limits specified in Section 15.209(a).

Frequency (MHz)	Frequency (MHz)	Frequency (MHz)	Frequency (GHz)
0.090 - 0.110	16.42 - 16.423	399.9 - 410	4.5 - 5.15
¹ 0.495 - 0.505	16.69475 - 16.69525	608 - 614	5.35 - 5.46
2.1735 - 2.1905	16.80425 - 16.80475	960 - 1240	7.25 - 7.75
4.125 - 4.128	25.5 - 25.67	1300 - 1427	8.025 - 8.5
4.17725 - 4.17775	37.5 - 38.25	1435 - 1626.5	9.0 - 9.2
4.20725 - 4.20775	73 - 74.6	1645.5 - 1646.5	9.3 - 9.5
6.215 - 6.218	74.8 - 75.2	1660 - 1710	10.6 - 12.7
6.26775 - 6.26825	108 - 121.94	1718.8 - 1722.2	13.25 - 13.4
6.31175 - 6.31225	123 - 138	2200 - 2300	14.47 - 14.5
8.291 - 8.294	149.9 - 150.05	2310 - 2390	15.35 - 16.2
8.362 - 8.366	156.52475 - 156.52525	2483.5 - 2500	17.7 - 21.4
8.37625 - 8.38675	156.7 - 156.9	2690 - 2900	22.01 - 23.12
8.41425 - 8.41475	162.0125 - 167.17	3260 - 3267	23.6 - 24.0
12.29 - 12.293	167.72 - 173.2	3332 - 3339	31.2 - 31.8
12.51975 - 12.52025	240 - 285	3345.8 - 3358	36.43 - 36.5
12.57675 - 12.57725	322 - 335.4	3600 - 4400	(²)
13.36 - 13.41	--	--	--

All out of band emissions appearing in a restricted band as specified in Section 15.205 of the Title 47CFR must not exceed the limits shown in Table per Section 15.209.

FCC Part 15 Subpart C Paragraph 15.209		
Frequency [MHz]	Field Strength [$\mu\text{V/m}$]	Measured Distance [Meters]
0.009 - 0.490	2400/F (kHz)	300
0.490 - 1.705	24000/F (kHz)	30
1.705 - 30	30	30
30 - 88	100	3
88 - 216	150	3
216 - 960	200	3
Above 960	500	3

6.7.2. Test Procedure

ANSI C63.10-2013 Section 6.3 & 6.6 & 11.13

6.7.3. Test Setting

Peak Field Strength Measurements

1. Analyzer center frequency was set to the frequency of the radiated spurious emission of interest
2. RBW = 1MHz
3. VBW = 3MHz
4. Detector = peak
5. Sweep time = auto couple
6. Trace mode = max hold
7. Trace was allowed to stabilize

Average Field Strength Measurements

1. Analyzer center frequency was set to the frequency of the radiated spurious emission of interest
2. RBW = 1MHz
3. VBW $\geq 1/T$
4. As an alternative, the instrument may be set to linear detector mode. Ensure that video filtering is applied in linear voltage domain (rather than in a log or dB domain). Some instruments require linear display mode in order to accomplish this. Others have a setting for Average-VBW Type, which can be set to "Voltage" regardless of the display mode
5. Detector = Peak
6. Sweep time = auto
7. Trace mode = max hold
8. Allow max hold to run for at least 50 times (1/duty cycle) traces

6.7.4. Test Setup

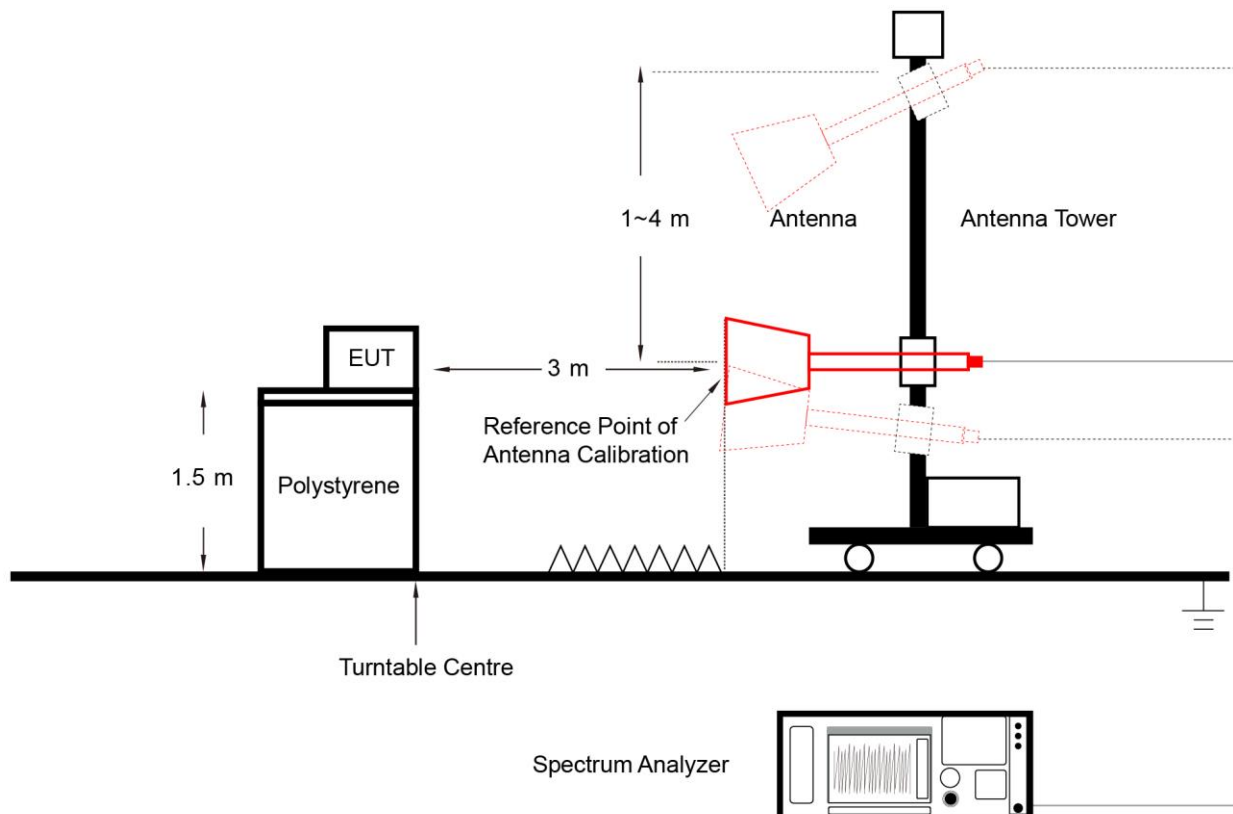

6.7.5. Test Result

Refer to Appendix A.7.

6.8. AC Conducted Emissions Measurement

6.8.1. Test Limit

FCC Part 15 Subpart C Paragraph 15.207 Limits		
Frequency (MHz)	QP (dB μ V)	AV (dB μ V)
0.15 - 0.50	66 - 56	56 - 46
0.50 - 5.0	56	46
5.0 - 30	60	50

Note 1: The lower limit shall apply at the transition frequencies.

Note 2: The limit decreases linearly with the logarithm of the frequency in the range 0.15MHz to 0.5MHz.

6.8.2. Test Setup

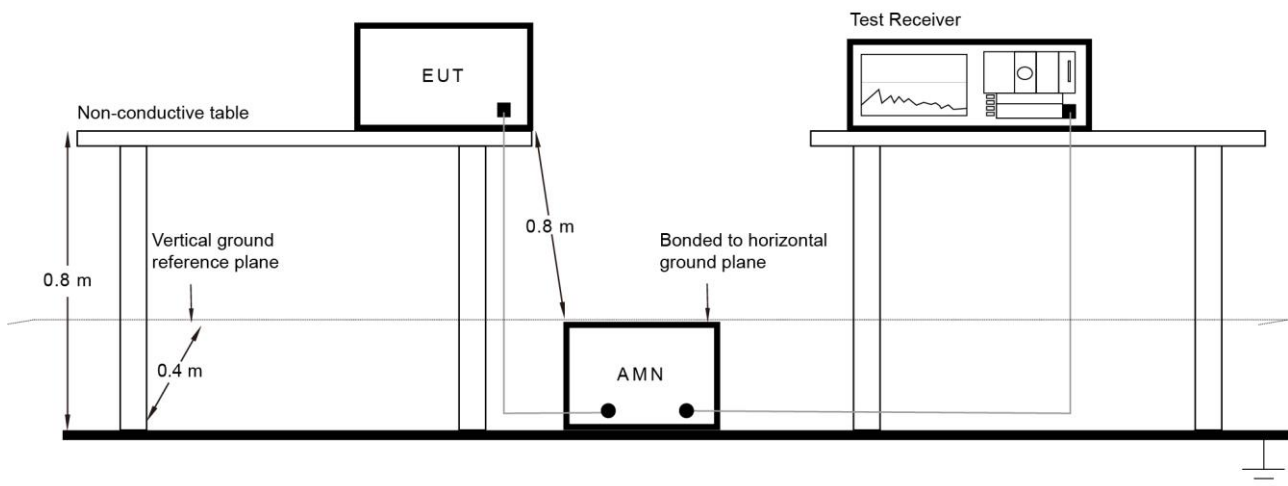

6.8.3. Test Result

Refer to Appendix A.8.

Appendix A – Test Result

A.1 Duty Cycle Test Result

Test Site	SIP-TR1	Test Engineer	Ryan Wang
Test Date	2023-09-07 ~ 2023-10-26		

Test Mode	Duty Cycle
802.11b	97.58%
802.11g	98.91%
802.11n-HT20	99.60%
802.11n-HT40	98.79%
VHT20	99.45%
VHT40	98.92%
802.11ax-HE20	99.47%
802.11ax-HE40	98.79%

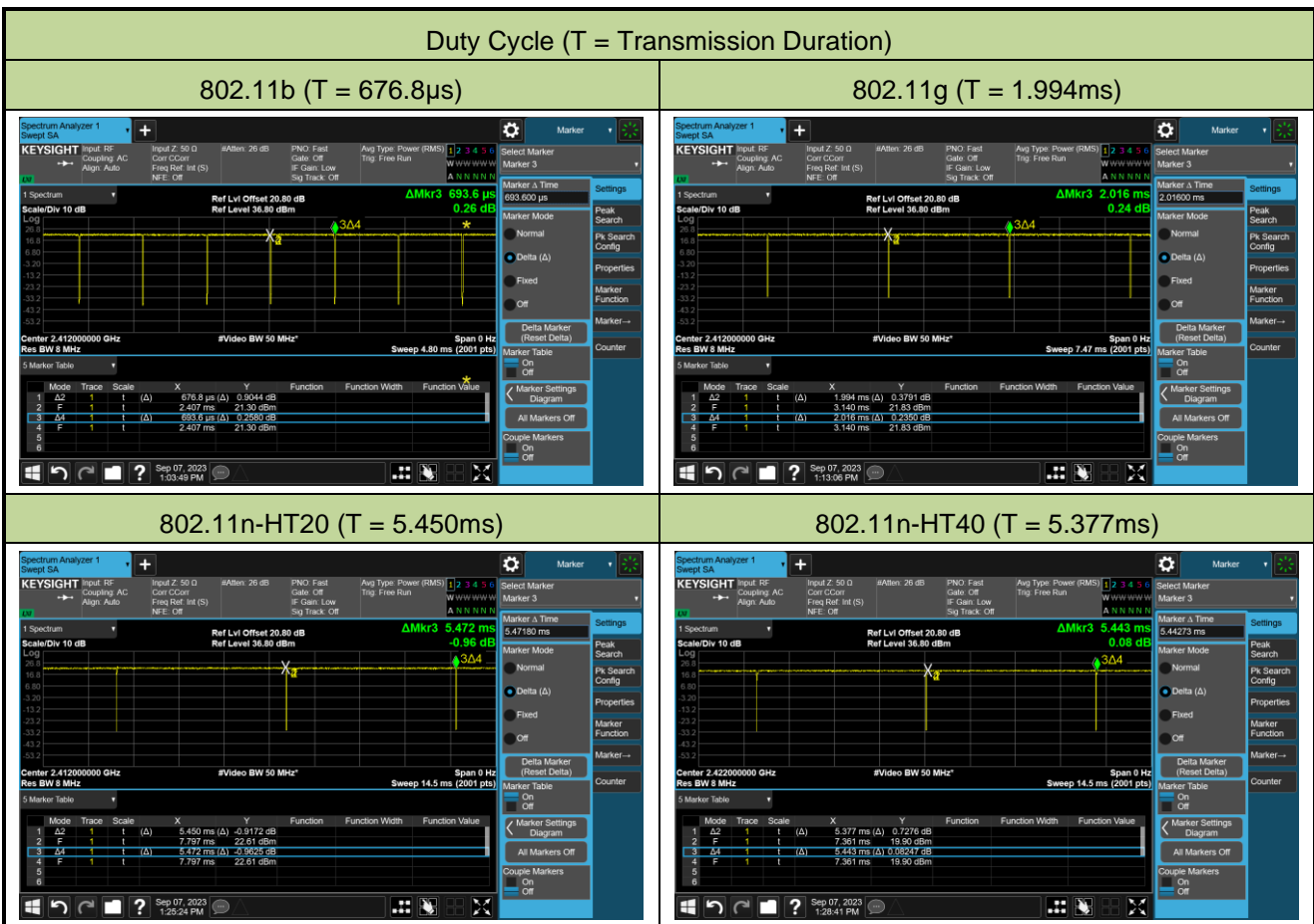

Duty Cycle (T = Transmission Duration)

VHT20 (T = 5.410ms)

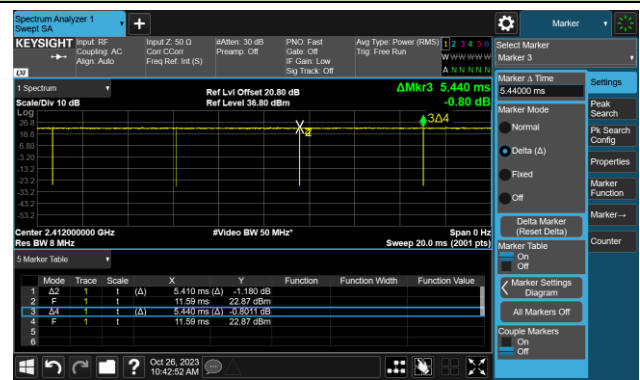

VHT40 (T = 5.385ms)

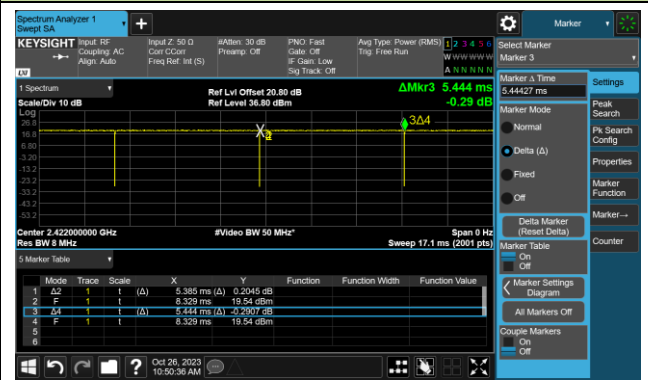

802.11ax-HE20 (T = 5.472ms)

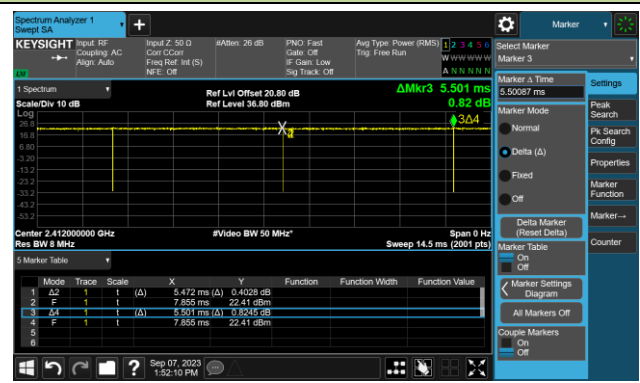

802.11ax-HE40 (T = 5.399ms)

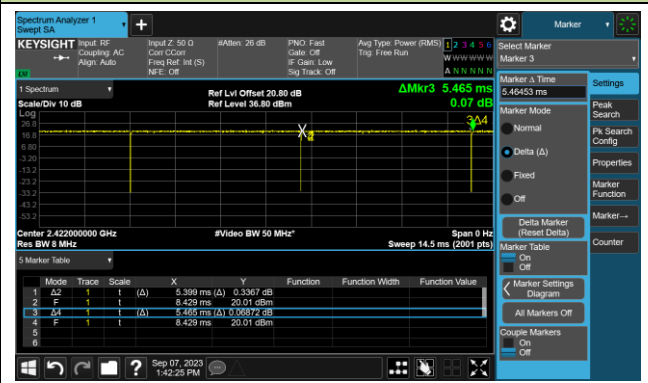

A.2 6dB Bandwidth Test Result

Test Site	SIP-TR1	Test Engineer	Ryan Wang
Test Date	2023-09-14 ~ 2023-10-26		

Test Mode	Data Rate / MCS	Channel No.	Frequency (MHz)	6dB Bandwidth (MHz)	Limit (MHz)
11b	1Mbps	01	2412	7.090	≥ 0.5
11b	1Mbps	06	2437	8.055	≥ 0.5
11b	1Mbps	11	2462	7.591	≥ 0.5
11g	6Mbps	01	2412	15.06	≥ 0.5
11g	6Mbps	06	2437	15.08	≥ 0.5
11g	6Mbps	11	2462	15.02	≥ 0.5
11n-HT20	MCS0	01	2412	15.05	≥ 0.5
11n-HT20	MCS0	06	2437	12.62	≥ 0.5
11n-HT20	MCS0	11	2462	15.08	≥ 0.5
11n-HT40	MCS0	03	2422	31.28	≥ 0.5
11n-HT40	MCS0	06	2437	32.57	≥ 0.5
11n-HT40	MCS0	09	2452	28.83	≥ 0.5
VHT20	MCS0	01	2412	12.66	≥ 0.5
VHT20	MCS0	06	2437	14.03	≥ 0.5
VHT20	MCS0	11	2462	10.34	≥ 0.5
VHT40	MCS0	03	2422	31.32	≥ 0.5
VHT40	MCS0	06	2437	22.65	≥ 0.5
VHT40	MCS0	09	2452	28.82	≥ 0.5
11ax-HE20	MCS0	01	2412	15.06	≥ 0.5
11ax-HE20	MCS0	06	2437	13.83	≥ 0.5
11ax-HE20	MCS0	11	2462	15.07	≥ 0.5
11ax-HE40	MCS0	03	2422	31.32	≥ 0.5
11ax-HE40	MCS0	06	2437	32.57	≥ 0.5
11ax-HE40	MCS0	09	2452	31.37	≥ 0.5

802.11b 6dB Bandwidth

Channel 01 (2412MHz)

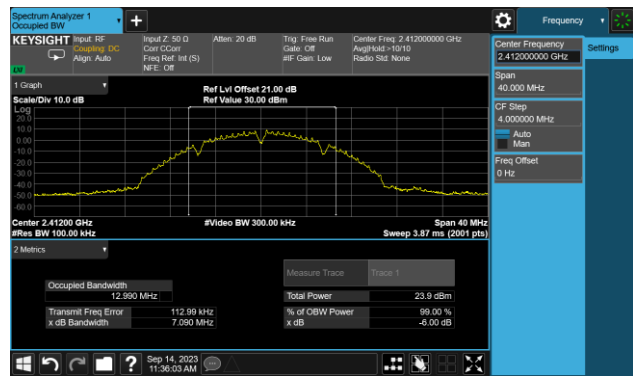

Channel 06 (2437MHz)

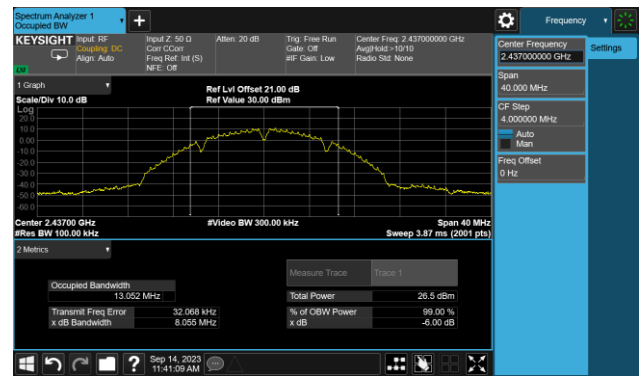

Channel 11 (2462MHz)

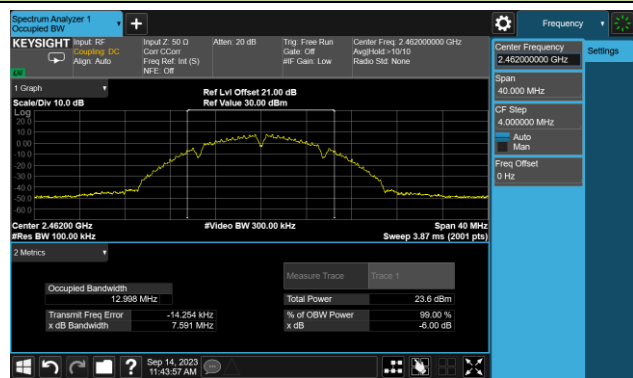

802.11g 6dB Bandwidth

Channel 01 (2412MHz)

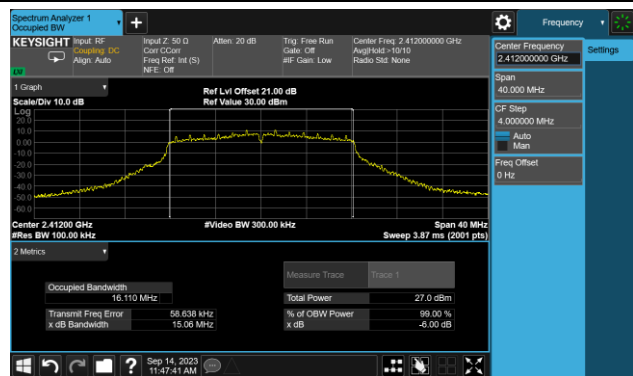

Channel 06 (2437MHz)

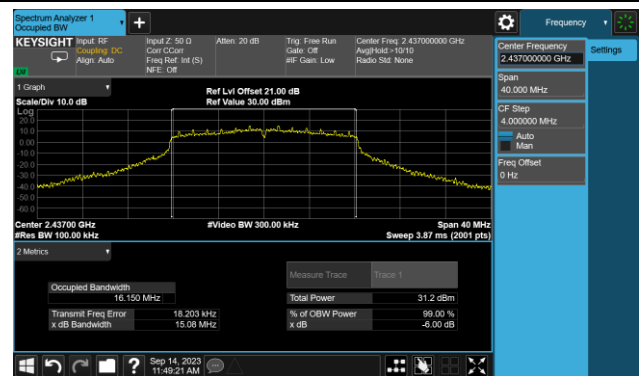

Channel 11 (2462MHz)

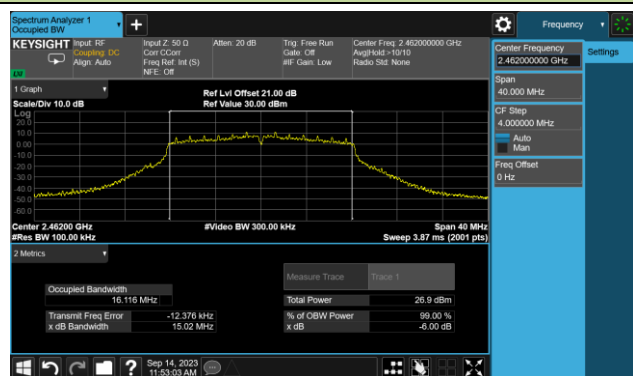

802.11n-HT20 6dB Bandwidth

Channel 01 (2412MHz)

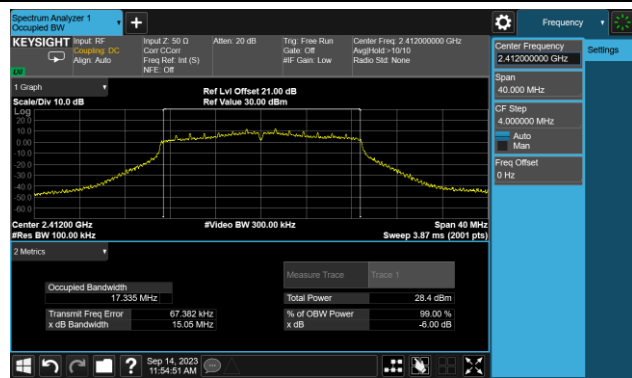

Channel 06 (2437MHz)

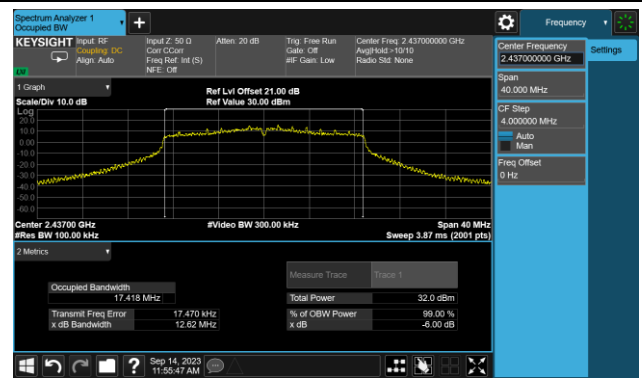

Channel 11 (2462MHz)

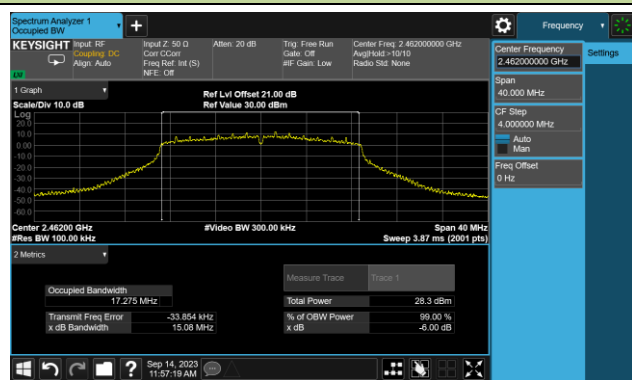

802.11n-HT40 6dB Bandwidth

Channel 03 (2422MHz)

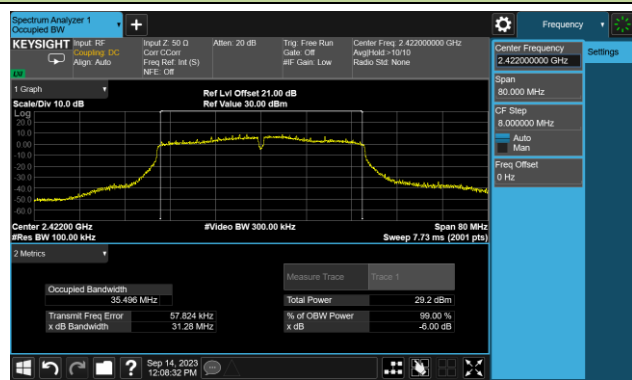

Channel 06 (2437MHz)

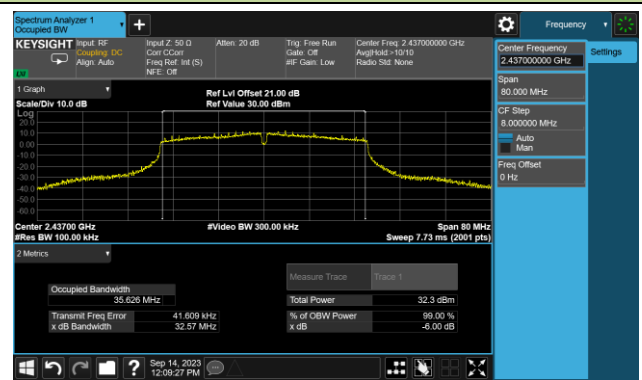

Channel 09 (2452MHz)

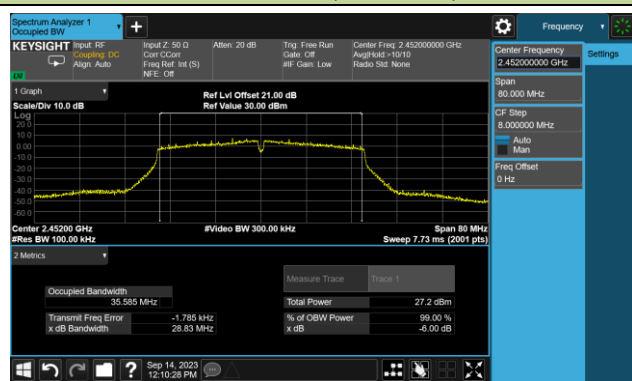

VHT20 6dB Bandwidth

Channel 01 (2412MHz)

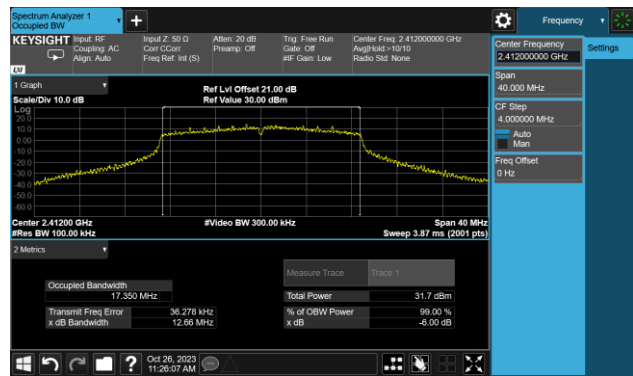

Channel 06 (2437MHz)



Channel 11 (2462MHz)

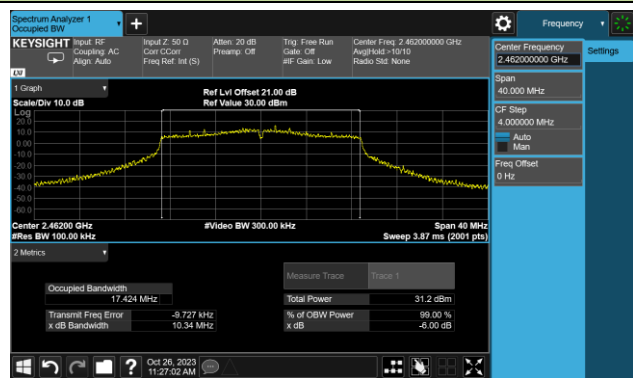

VHT40 6dB Bandwidth

Channel 03 (2422MHz)



Channel 06 (2437MHz)

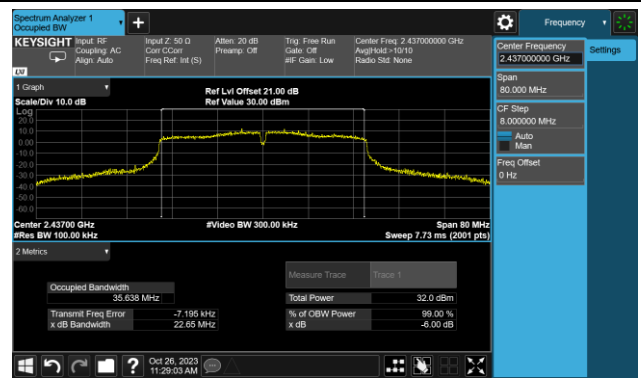

Channel 09 (2452MHz)

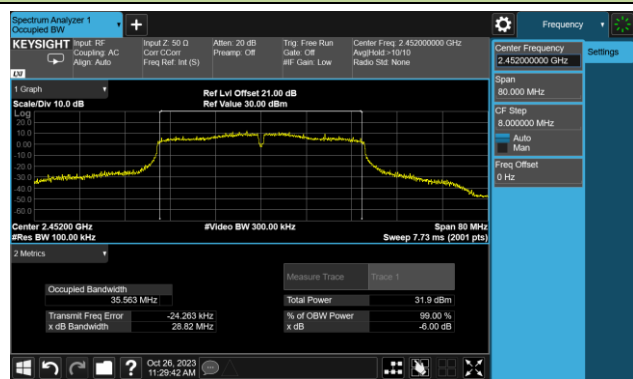

802.1ax-HE20 6dB Bandwidth

Channel 01 (2412MHz)

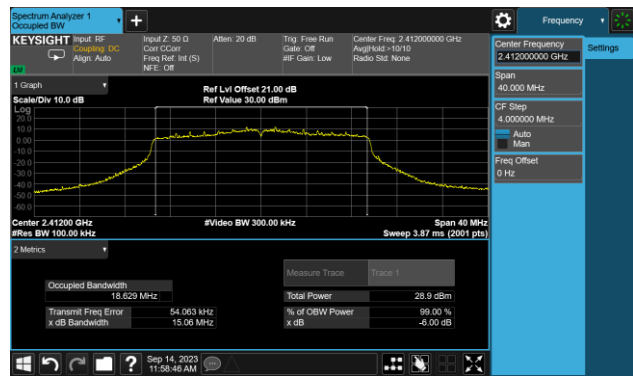

Channel 06 (2437MHz)

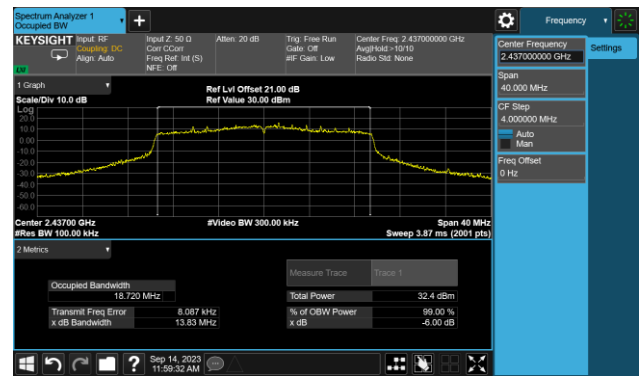

Channel 11 (2462MHz)

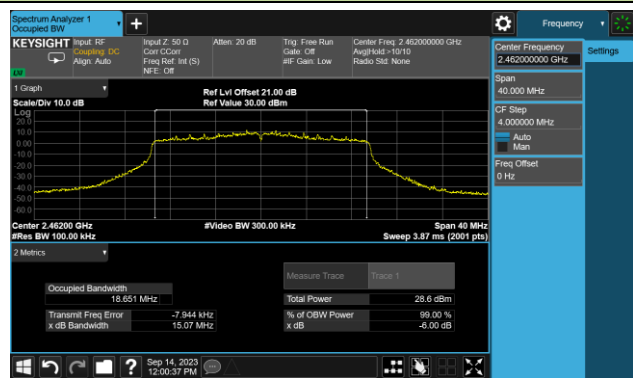

802.11ax-HE40 6dB Bandwidth

Channel 03 (2422MHz)

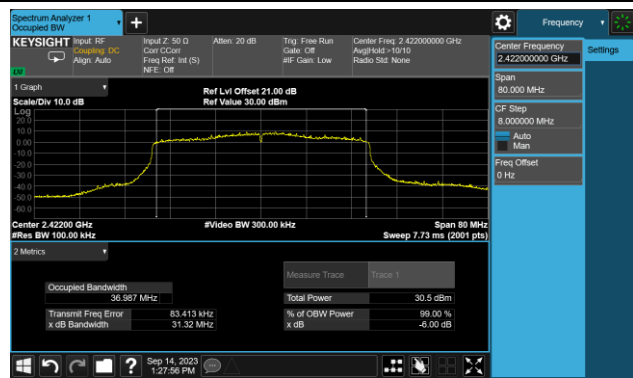

Channel 06 (2437MHz)

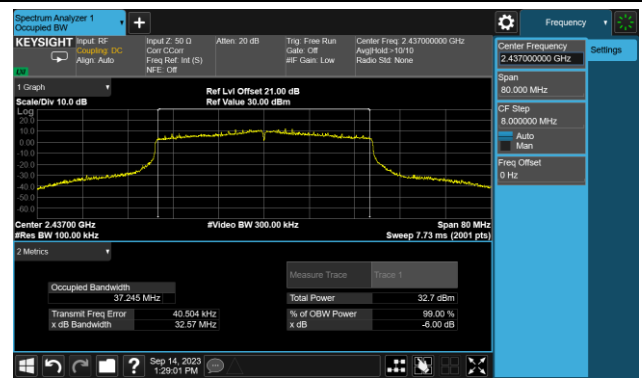

Channel 09 (2452MHz)

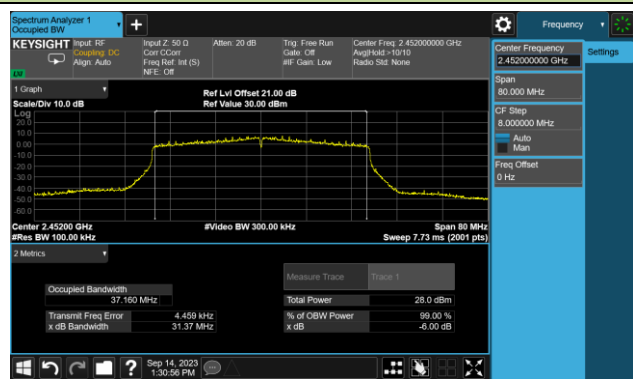

A.3 Output Power Test Result

Test Site	WZ-SR5	Test Engineer	Lynn Yang
Test Date	2023-11-24		
Test Model No.	L22UGS-5HaxD2HaxD-15S-US		

Test Mode	Data Rate / MCS	Channel No.	Freq. (MHz)	Average Power (dBm)		Total Average Power (dBm)	Limit (dBm)
				Ant 0	Ant 1		
11b	1Mbps	01	2412	17.80	18.16	20.99	≤ 24.00
11b	1Mbps	06	2437	18.83	19.20	22.03	≤ 24.00
11b	1Mbps	11	2462	13.90	14.03	16.98	≤ 24.00
11g	6Mbps	01	2412	19.88	20.38	23.15	≤ 24.00
11g	6Mbps	06	2437	20.21	20.28	23.26	≤ 24.00
11g	6Mbps	11	2462	18.42	18.35	21.40	≤ 24.00
11n-HT20	MCS0	01	2412	19.67	20.12	22.91	≤ 24.00
11n-HT20	MCS0	06	2437	19.99	20.03	23.02	≤ 24.00
11n-HT20	MCS0	11	2462	18.94	19.01	21.99	≤ 24.00
11n-HT40	MCS0	03	2422	20.11	20.28	23.21	≤ 24.00
11n-HT40	MCS0	06	2437	20.37	20.47	23.43	≤ 24.00
11n-HT40	MCS0	09	2452	20.22	20.25	23.25	≤ 24.00
VHT20	MCS0	01	2412	19.91	20.38	23.16	≤ 24.00
VHT20	MCS0	06	2437	20.27	20.44	23.37	≤ 24.00
VHT20	MCS0	11	2462	20.15	19.98	23.08	≤ 24.00
VHT40	MCS0	03	2422	20.77	20.99	23.89	≤ 24.00
VHT40	MCS0	06	2437	20.24	20.41	23.34	≤ 24.00
VHT40	MCS0	09	2452	20.11	20.17	23.15	≤ 24.00
11ax-HE20	MCS0	01	2412	20.00	20.46	23.25	≤ 24.00
11ax-HE20	MCS0	06	2437	20.25	20.37	23.32	≤ 24.00
11ax-HE20	MCS0	11	2462	19.18	19.26	22.23	≤ 24.00
11ax-HE40	MCS0	03	2422	19.80	19.97	22.90	≤ 24.00
11ax-HE40	MCS0	06	2437	19.93	20.02	22.99	≤ 24.00
11ax-HE40	MCS0	09	2452	20.63	20.79	23.72	≤ 24.00

Note 1: Total Average Power (dBm) = $10 \cdot \log \{10^{(\text{Ant 0 Average Power} / 10)} + 10^{(\text{Ant 1 Average Power} / 10)}\}$ (dBm).

Note 2: Limit (dBm) = 30 – (12 - 6) = 24 dBm.

Test Site	SIP-TR1	Test Engineer	Ryan Wang
Test Date	2023-09-03 ~ 2023-09-17		
Test Model No.	L23UGSR-5HaxD2HaxD-US		

Test Mode	Data Rate / MCS	Channel No.	Freq. (MHz)	Average Power (dBm)		Total Average Power (dBm)	Limit (dBm)
				Ant 0	Ant 1		
11b	1Mbps	01	2412	16.79	17.02	19.92	≤ 30.00
11b	1Mbps	06	2437	19.75	19.71	22.74	≤ 30.00
11b	1Mbps	11	2462	16.93	16.46	19.71	≤ 30.00
11g	6Mbps	01	2412	19.84	20.05	22.96	≤ 30.00
11g	6Mbps	06	2437	23.92	23.75	26.85	≤ 30.00
11g	6Mbps	11	2462	19.82	19.54	22.69	≤ 30.00
11n-HT20	MCS0	01	2412	20.45	20.57	23.52	≤ 30.00
11n-HT20	MCS0	06	2437	24.62	24.63	27.64	≤ 30.00
11n-HT20	MCS0	11	2462	20.38	20.06	23.23	≤ 30.00
11n-HT40	MCS0	03	2422	21.45	21.32	24.40	≤ 30.00
11n-HT40	MCS0	06	2437	24.95	24.51	27.75	≤ 30.00
11n-HT40	MCS0	09	2452	19.76	19.66	22.72	≤ 30.00
VHT20	MCS0	01	2412	21.56	21.64	24.61	≤ 30.00
VHT20	MCS0	06	2437	24.42	24.62	27.53	≤ 30.00
VHT20	MCS0	11	2462	20.89	21.47	24.20	≤ 30.00
VHT40	MCS0	03	2422	22.62	22.85	25.75	≤ 30.00
VHT40	MCS0	06	2437	24.93	25.04	28.00	≤ 30.00
VHT40	MCS0	09	2452	20.46	20.91	23.70	≤ 30.00
11ax-HE20	MCS0	01	2412	21.12	21.15	24.15	≤ 30.00
11ax-HE20	MCS0	06	2437	25.08	25.02	28.06	≤ 30.00
11ax-HE20	MCS0	11	2462	19.93	19.58	22.77	≤ 30.00
11ax-HE40	MCS0	03	2422	21.06	21.14	24.11	≤ 30.00
11ax-HE40	MCS0	06	2437	24.62	24.53	27.59	≤ 30.00
11ax-HE40	MCS0	09	2452	19.52	19.23	22.39	≤ 30.00

Note: Total Average Power (dBm) = $10 \cdot \log \{ 10^{(\text{Ant 0 Average Power} / 10)} + 10^{(\text{Ant 1 Average Power} / 10)} \}$ (dBm).

Test Site	SIP-TR1	Test Engineer	Ryan Wang
Test Date	2023-11-21		
Test Model No.	L23UGSR-5HaxD2HaxD-NM-US		

Test Mode	Data Rate / MCS	Channel No.	Freq. (MHz)	Average Power (dBm)		Total Average Power (dBm)	Limit (dBm)
				Ant 0	Ant 1		
11b	1Mbps	01	2412	16.84	16.89	19.88	≤ 30.00
11b	1Mbps	06	2437	19.43	19.57	22.51	≤ 30.00
11b	1Mbps	11	2462	16.58	16.51	19.56	≤ 30.00
11g	6Mbps	01	2412	19.27	19.24	22.27	≤ 30.00
11g	6Mbps	06	2437	23.69	23.78	26.75	≤ 30.00
11g	6Mbps	11	2462	18.75	18.89	21.83	≤ 30.00
11n-HT20	MCS0	01	2412	19.73	19.92	22.84	≤ 30.00
11n-HT20	MCS0	06	2437	24.56	24.62	27.60	≤ 30.00
11n-HT20	MCS0	11	2462	19.58	19.68	22.64	≤ 30.00
11n-HT40	MCS0	03	2422	20.57	20.68	23.64	≤ 30.00
11n-HT40	MCS0	06	2437	21.44	21.56	24.51	≤ 30.00
11n-HT40	MCS0	09	2452	18.96	19.16	22.07	≤ 30.00
VHT20	MCS0	01	2412	20.73	20.89	23.82	≤ 30.00
VHT20	MCS0	06	2437	24.39	24.45	27.43	≤ 30.00
VHT20	MCS0	11	2462	20.32	20.46	23.40	≤ 30.00
VHT40	MCS0	03	2422	21.84	21.78	24.82	≤ 30.00
VHT40	MCS0	06	2437	24.63	24.82	27.74	≤ 30.00
VHT40	MCS0	09	2452	19.76	19.94	22.86	≤ 30.00
11ax-HE20	MCS0	01	2412	20.74	20.94	23.85	≤ 30.00
11ax-HE20	MCS0	06	2437	24.69	24.78	27.75	≤ 30.00
11ax-HE20	MCS0	11	2462	19.61	19.73	22.68	≤ 30.00
11ax-HE40	MCS0	03	2422	20.48	20.61	23.56	≤ 30.00
11ax-HE40	MCS0	06	2437	24.36	24.61	27.50	≤ 30.00
11ax-HE40	MCS0	09	2452	18.58	18.82	21.71	≤ 30.00

Note: Total Average Power (dBm) = $10 \cdot \log \{ 10^{(\text{Ant 0 Average Power} / 10)} + 10^{(\text{Ant 1 Average Power} / 10)} \}$ (dBm).

A.4 Power Spectral Density Test Result

Test Site	WZ-SR5	Test Engineer	Lynn Yang
Test Date	2023-11-22 ~ 2023-11-23		
Test Model No.	L22UGS-5HaxD2HaxD-15S-US		

Test Mode	Data Rate/ MCS	Channel No.	Freq. (MHz)	PSD (dBm/10kHz)		Duty Cycle (%)	10*log (1/x)	Total PSD (dBm/10kHz)	Limit (dBm/3kHz)
				Ant 0	Ant 1				
11b	1Mbps	01	2412	-6.29	-5.85	97.58	0.11	-2.95	≤ -1.01
11b	1Mbps	06	2437	-4.81	-4.68	97.58	0.11	-1.63	≤ -1.01
11b	1Mbps	11	2462	-9.99	-9.58	97.58	0.11	-6.67	≤ -1.01
11g	6Mbps	01	2412	-6.44	-6.24	98.91	0.05	-3.33	≤ -1.01
11g	6Mbps	06	2437	-6.17	-5.99	98.91	0.05	-3.07	≤ -1.01
11g	6Mbps	11	2462	-8.23	-8.55	98.91	0.05	-5.38	≤ -1.01
11n-HT20	MCS0	01	2412	-8.04	-7.31	99.60	0.02	-4.65	≤ -1.01
11n-HT20	MCS0	06	2437	-6.98	-6.88	99.60	0.02	-3.92	≤ -1.01
11n-HT20	MCS0	11	2462	-8.86	-8.75	99.60	0.02	-5.80	≤ -1.01
11n-HT40	MCS0	03	2422	-10.12	-10.06	98.79	0.05	-7.08	≤ -1.01
11n-HT40	MCS0	06	2437	-10.21	-9.74	98.79	0.05	-6.96	≤ -1.01
11n-HT40	MCS0	09	2452	-9.52	-9.46	98.79	0.05	-6.48	≤ -1.01
VHT20	MCS0	01	2412	-7.48	-6.56	99.45	0.02	-3.99	≤ -1.01
VHT20	MCS0	06	2437	-7.46	-7.09	99.45	0.02	-4.26	≤ -1.01
VHT20	MCS0	11	2462	-6.74	-7.29	99.45	0.02	-4.00	≤ -1.01
VHT40	MCS0	03	2422	-8.56	-8.38	98.92	0.05	-5.46	≤ -1.01
VHT40	MCS0	06	2437	-9.83	-9.55	98.92	0.05	-6.67	≤ -1.01
VHT40	MCS0	09	2452	-10.10	-10.00	98.92	0.05	-7.04	≤ -1.01
11ax-HE20	MCS0	01	2412	-9.03	-8.07	99.47	0.02	-5.51	≤ -1.01
11ax-HE20	MCS0	06	2437	-8.12	-8.08	99.47	0.02	-5.09	≤ -1.01
11ax-HE20	MCS0	11	2462	-9.74	-9.29	99.47	0.02	-6.50	≤ -1.01
11ax-HE40	MCS0	03	2422	-11.63	-11.54	98.79	0.05	-8.57	≤ -1.01
11ax-HE40	MCS0	06	2437	-11.93	-11.82	98.79	0.05	-8.86	≤ -1.01
11ax-HE40	MCS0	09	2452	-10.30	-10.27	98.79	0.05	-7.27	≤ -1.01

Note 1:

 When EUT duty cycle ≥ 98%, Total PSD (dBm /10kHz) = $10 \cdot \log \{10^{(\text{Ant 0 PSD}/10)} + 10^{(\text{Ant 1 PSD}/10)}\}$ (dBm / 10kHz).

 When EUT duty cycle < 98%, Total PSD (dBm /10kHz) = $10 \cdot \log \{10^{(\text{Ant 0 PSD}/10)} + 10^{(\text{Ant 1 PSD}/10)}\}$ (dBm / 10kHz) + $10 \cdot \log (1/\text{Duty Cycle})$.

Note 2: Limit (dBm/3kHz) = 8 – (15.01-6) = -1.01 dBm/3kHz.

802.11b - AVGPSD - Ant 0

Channel 01 (2412MHz)



Channel 06 (2437MHz)



Channel 11 (2462MHz)



802.11g - AVGPSD - Ant 0

Channel 01 (2412MHz)

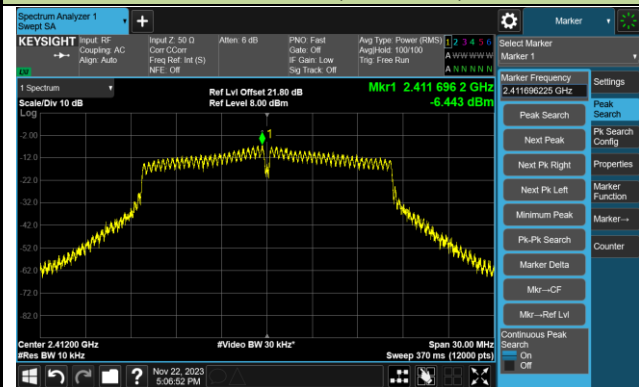

Channel 06 (2437MHz)

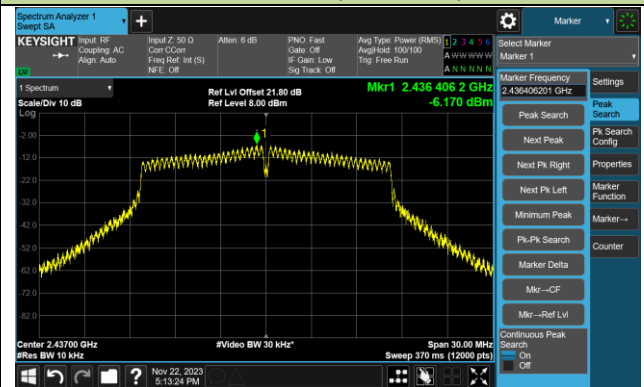

Channel 11 (2462MHz)

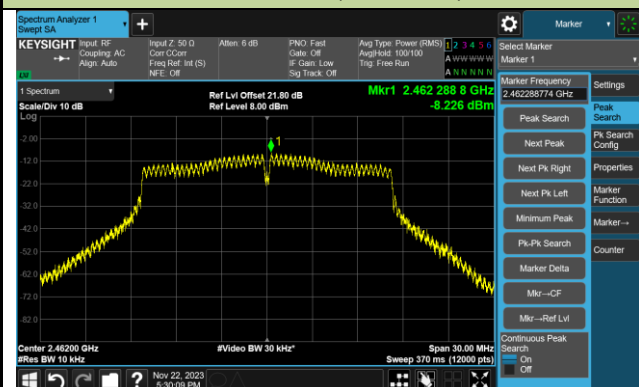

802.11n-HT20 - AVGPSD - Ant 0

Channel 01 (2412MHz)

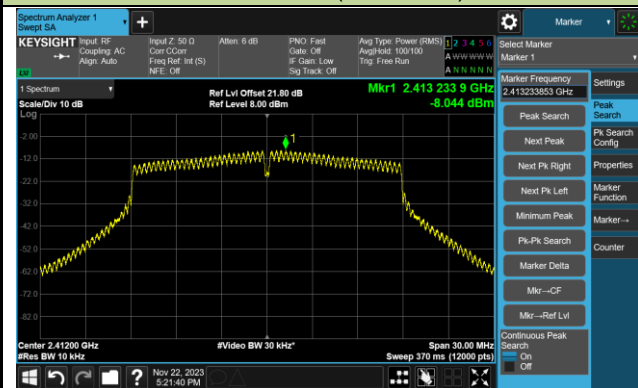

Channel 06 (2437MHz)

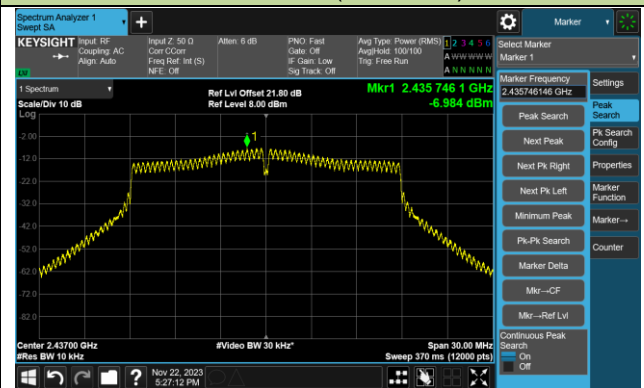

Channel 11 (2462MHz)



802.11n-HT40 - AVGPSD - Ant 0

Channel 03 (2422MHz)



Channel 06 (2437MHz)



Channel 09 (2452MHz)



VHT20 - AVGPDS - Ant 0

Channel 01 (2412MHz)

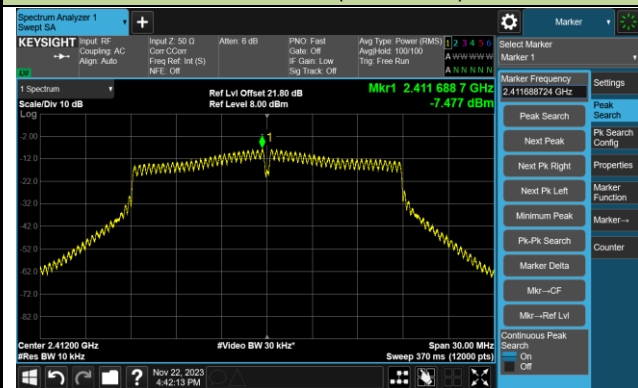

Channel 06 (2437MHz)

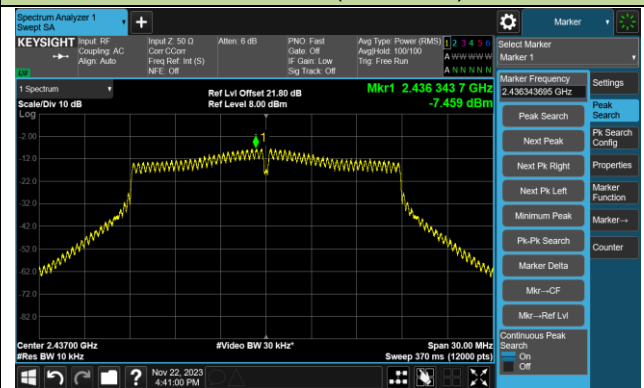

Channel 11 (2462MHz)

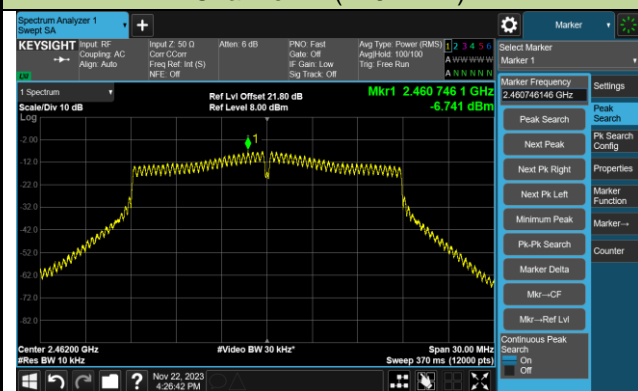

VHT40 - AVGPDS - Ant 0

Channel 03 (2422MHz)



Channel 06 (2437MHz)

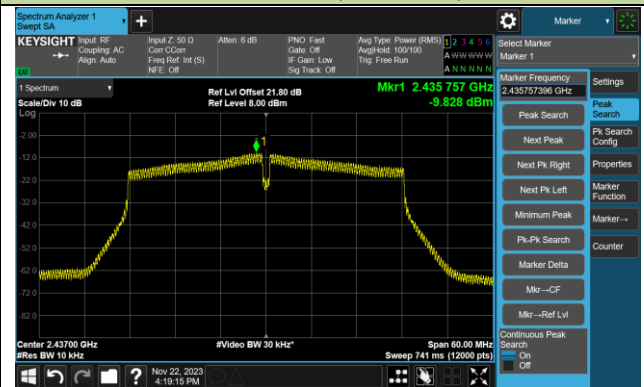

Channel 09 (2452MHz)



802.11ax-HE20 - AVGPDS - Ant 0

Channel 01 (2412MHz)

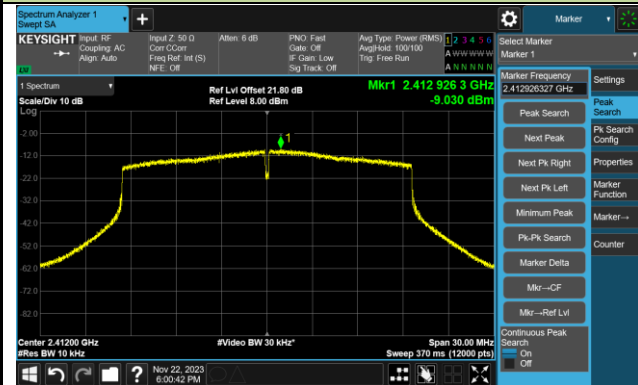

Channel 06 (2437MHz)

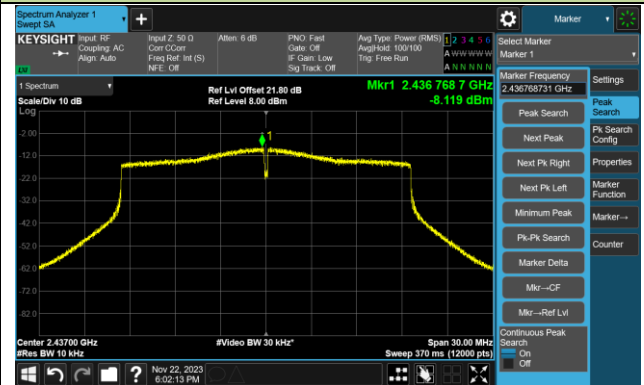

Channel 11 (2462MHz)

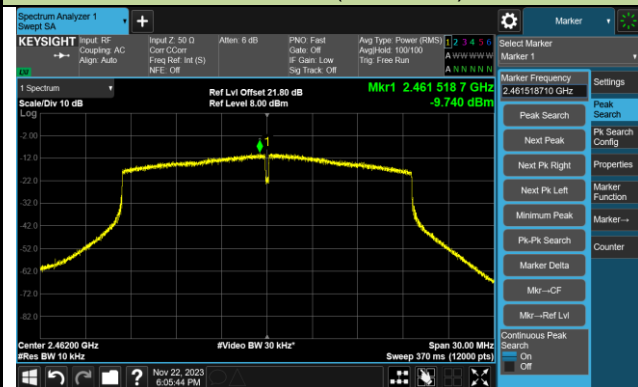

802.11 ax-HE40 - AVGPDS - Ant 0

Channel 03 (2422MHz)

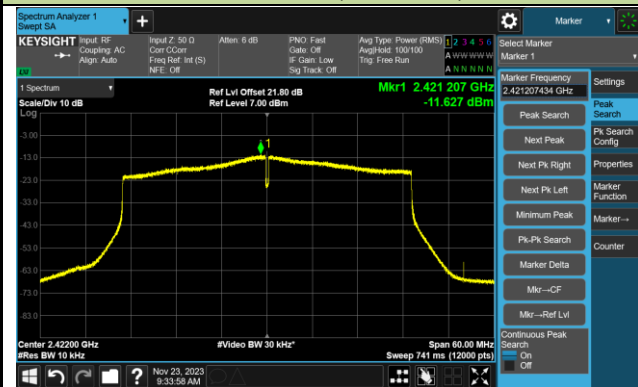

Channel 06 (2437MHz)

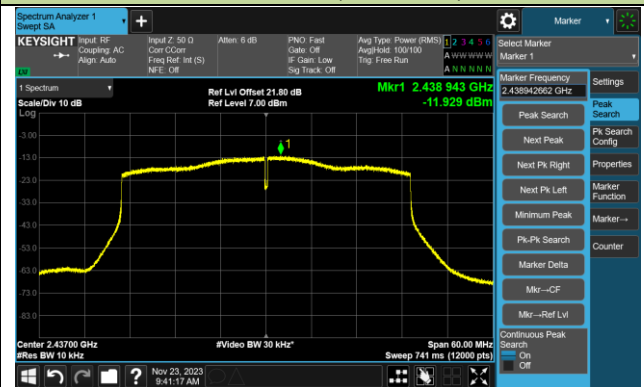

Channel 09 (2452MHz)

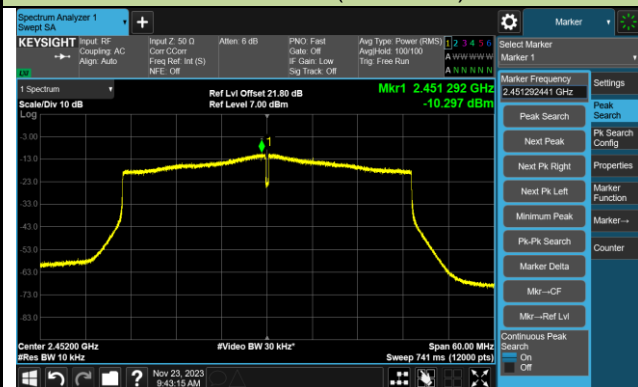

802.11b - AVGPSD - Ant 1

Channel 01 (2412MHz)

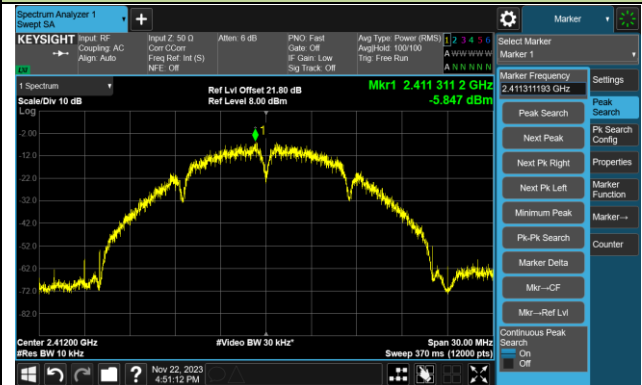

Channel 06 (2437MHz)



Channel 11 (2462MHz)



802.11g - AVGPSD - Ant 1

Channel 01 (2412MHz)

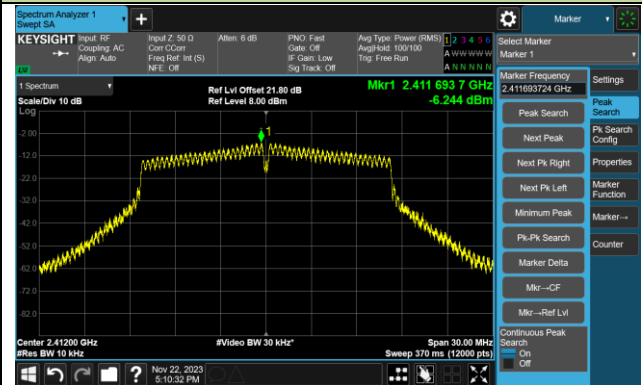

Channel 06 (2437MHz)

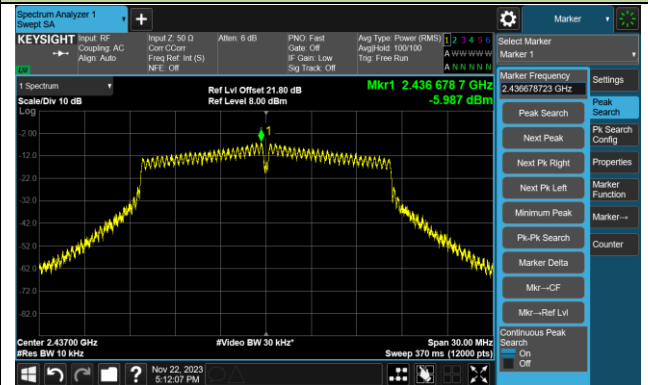

Channel 11 (2462MHz)

