



RADIO TEST REPORT

Report No.: STS2304013W02

Issued for

Mikrotiks SIA

Brivibas gatve 214i, Riga, Latvia, LV-1039

Product Name:	L009UiGS-2HaxD-IN
Brand:	MikroTik
Model Number:	L009UiGS-2HaxD-IN
Series Model(s):	N/A
FCC ID:	TV7L0092AXIN
Test Standard:	FCC Part 15.247

Any reproduction of this document must be done in full. No single part of this document may be reproduced without permission from STS, all test data presented in this report is only applicable to presented test sample.

Shenzhen STS Test Services Co., Ltd.
A 1/F, Building B, Zhuoke Science Park, No.190 Chongqing Road, HepingShequ,
Fuyong Sub-District, Bao'an District, Shenzhen, Guang Dong, China
TEL: +86-755 3688 6288 FAX: +86-755 3688 6277 E-mail: sts@stsapp.com





TEST RESULT CERTIFICATION

Applicant's Name : Mikrotiks SIA
 Address : Brivibas gatve 214i, Riga, Latvia, LV-1039
Manufacturer's Name..... : Mikrotiks SIA
 Address : Brivibas gatve 214i, Riga, Latvia, LV-1039

Product Description

Product Name : L009UiGS-2HaxD-IN
 Brand : MikroTik
 Model Number : L009UiGS-2HaxD-IN
 Series Model(s) : N/A

Test Standards : FCC Part 15.247

Test Procedure..... : ANSI C63.10-2013

This device described above has been tested by STS, the test results show that the equipment under test (EUT) is in compliance with the FCC requirements. And it is applicable only to the tested sample identified in the report.

This report shall not be reproduced except in full, without the written approval of STS, this document only be altered or revised by STS, personal only, and shall be noted in the revision of the document.

Date of Test..... :

Date of receipt of test item..... : 06 Apr. 2023

Date (s) of performance of tests..... : 06 Apr. 2023 ~ 09 May 2023

Date of Issue : 09 May 2023

Test Result : **Pass**

Testing Engineer :

(Chris Chen)

Technical Manager :

(Sean she)

Authorized Signatory :

(Bovey Yang)





Table of Contents	Page
1. SUMMARY OF TEST RESULTS	6
1.1 TEST FACTORY	7
1.2 MEASUREMENT UNCERTAINTY	7
2. GENERAL INFORMATION	8
2.1 GENERAL DESCRIPTION OF THE EUT	8
2.2 DESCRIPTION OF THE TEST MODES	10
2.3 TEST SOFTWARE AND POWER LEVEL	11
2.4 BLOCK DIAGRAM SHOWING THE CONFIGURATION OF SYSTEM TESTED	11
2.5 DESCRIPTION OF NECESSARY ACCESSORIES AND SUPPORT UNITS	12
2.6 EQUIPMENTS LIST FOR ALL TEST ITEMS	13
3. EMC EMISSION TEST	14
3.1 CONDUCTED EMISSION MEASUREMENT	14
3.2 RADIATED EMISSION MEASUREMENT	20
4. CONDUCTED SPURIOUS & BAND EDGE EMISSION	32
4.1 LIMIT	32
4.2 TEST PROCEDURE	32
4.3 DEVIATION FROM STANDARD	32
4.4 TEST SETUP	32
4.5 EUT OPERATION CONDITIONS	32
4.6 TEST RESULTS	32
5. POWER SPECTRAL DENSITY TEST	33
5.1 LIMIT	33
5.2 TEST PROCEDURE	33
5.3 DEVIATION FROM STANDARD	33
5.4 TEST SETUP	33
5.5 EUT OPERATION CONDITIONS	33
5.6 TEST RESULTS	33
6. BANDWIDTH TEST	34
6.1 LIMIT	34
6.2 TEST PROCEDURE	34
6.3 DEVIATION FROM STANDARD	34
6.4 TEST SETUP	34
6.5 EUT OPERATION CONDITIONS	34



Table of Contents	Page
6.6 TEST RESULTS	34
7. PEAK OUTPUT POWER TEST	35
7.1 LIMIT	35
7.2 TEST PROCEDURE	35
7.3 DEVIATION FROM STANDARD	35
7.4 TEST SETUP	36
7.5 EUT OPERATION CONDITIONS	36
7.6 TEST RESULTS	36
8. ANTENNA REQUIREMENT	37
8.1 STANDARD REQUIREMENT	37
8.2 EUT ANTENNA	37
APPENDIX 1-TEST DATA	38
1. DUTY CYCLE	38
2. MAXIMUM AVERAGE CONDUCTED OUTPUT POWER	51
3. MAXIMUM PEAK CONDUCTED OUTPUT POWER	70
4. -6DB BANDWIDTH	89
5. MAXIMUM POWER SPECTRAL DENSITY LEVEL	108
6. BAND EDGE	127
7. CONDUCTED RF SPURIOUS EMISSION	152
APPENDIX 2-PHOTOS OF TEST SETUP	189



Revision History

Rev.	Issue Date	Report No.	Effect Page	Contents
00	09 May 2023	STS2304013W02	ALL	Initial Issue





1. SUMMARY OF TEST RESULTS

Test procedures according to the technical standards:
KDB 558074 D01 15.247 Meas Guidance v05r02.

FCC Part 15.247, Subpart C			
Standard Section	Test Item	Judgment	Remark
15.207	Conducted Emission	PASS	--
15.247 (a)(2)	6dB Bandwidth	PASS	--
15.247 (b)(3)	Output Power	PASS	--
15.209	Radiated Spurious Emission	PASS	--
15.247 (d)	Conducted Spurious & Band Edge Emission	PASS	--
15.247 (e)	Power Spectral Density	PASS	--
15.205	Restricted Band Edge Emission	PASS	--
Part 15.247(d)/ part 15.209(a)	Band Edge Emission	PASS	--
15.203	Antenna Requirement	PASS	--

NOTE:

- (1) 'N/A' denotes test is not applicable in this Test Report.
- (2) All tests are according to ANSI C63.10-2013.



1.1 TEST FACTORY

SHENZHEN STS TEST SERVICES CO., LTD

Add. : A 1/F, Building B, Zhuoke Science Park, No.190 Chongqing Road, HepingShequ, Fuyong Sub-District, Bao'an District, Shenzhen, Guang Dong, China

FCC test Firm Registration Number: 625569

IC test Firm Registration Number: 12108A

A2LA Certificate No.: 4338.01

1.2 MEASUREMENT UNCERTAINTY

The reported uncertainty of measurement $y \pm U$, where expanded uncertainty U is based on a standard uncertainty multiplied by a coverage factor of $k=2$, providing a level of confidence of approximately 95 %.

No.	Item	Uncertainty
1	RF output power, conducted	$\pm 1.197\text{dB}$
2	Unwanted Emissions, conducted	$\pm 2.896\text{dB}$
3	All emissions, radiated 9K-30MHz	$\pm 3.84\text{dB}$
4	All emissions, radiated 30M-1GHz	$\pm 3.94\text{dB}$
5	All emissions, radiated 1G-6GHz	$\pm 4.59\text{dB}$
6	All emissions, radiated >6G	$\pm 5.22\text{dB}$
7	Conducted Emission (9KHz-150KHz)	$\pm 2.14\text{dB}$
8	Conducted Emission (150KHz-30MHz)	$\pm 2.54\text{dB}$



2. GENERAL INFORMATION

2.1 GENERAL DESCRIPTION OF THE EUT

Product Name	L009UiGS-2HaxD-IN	
Brand	MikroTik	
Model Number	L009UiGS-2HaxD-IN	
Series Model(s)	N/A	
Model Difference	N/A	
Product Description	The EUT is a L009UiGS-2HaxD-IN	
	Operation Frequency:	802.11b/g/n/ax 20: 2412~2462 MHz 802.11n/ax(40MHz):2422~2452MHz
	Modulation Type:	802.11b(DSSS):CCK,DQPSK,DBPSK 802.11g(OFDM):BPSK,QPSK,16-QAM,64-QAM 802.11n(OFDM):BPSK,QPSK,16-QAM,64-QAM 802.11ax(OFDM, OFDMA): BPSK,QPSK,16-QAM,64-QAM,256-QAM, 1024QAM
	Bit Rate of Transmitter:	802.11b:11/5.5/2/1 Mbps 802.11g:54/48/36/24/18/12/9/6Mbps 802.11n/ax(20MHz): 65/58.5/52/39/26/19.5/13/6.5Mbps 802.11n/ax(40MHz): 135/121.5/108/81/54/40.5/37/13.5Mbps
	Number of Channel:	802.11b/g/n/ax20: 11CH 802.11n/ax 40: 7CH
	Antenna Type:	External Omni antenna
	Antenna Gain (dBi):	Antenna number: 2 ANT 1: 3.46dBi ANT 2: 3.46dBi MIMO 1+2: 6.47dBi
Channel List	Please refer to the Note 3.	
Adapter	Input: AC 100-240V, 50/60Hz, 1.3A Output: DC 24V 1.5A	
Rating	Input:24-56VDC	
Hardware version number	r2	
Software version number	RouterOS V7	
Connecting I/O Port(s)	Please refer to the Note 1.	

Note:

- For a more detailed features description, please refer to the manufacturer's specifications or the User Manual.
- The antenna information refer the manufacturer provide report, applicable only to the tested sample identified in the report. Due to the incorrect antenna information, a series of problems such as the accuracy of the test results will be borne by the customer.



3. Operation Frequency of channel			
802.11b/g/n/ax (20MHz)		Channel List for 802.11n/ax (40MHz)	
Channel	Frequency	Channel	Frequency
01	2412	03	2422
02	2417	04	2427
03	2422	05	2432
04	2427	06	2437
05	2432	07	2442
06	2437	08	2447
07	2442	09	2452
08	2447		
09	2452		
10	2457		
11	2462		

Note:

In section 15.31(m), regards to the operating frequency range over 10 MHz, the Lowest frequency, the middle frequency, and the highest frequency of channel were selected to perform the test, and the selected channel see below:

Carrier Frequency Channel

2.4GHz Test Frequency:

For 802.11b/g/n/ax (HT20)		For 802.11n/ax (HT40)	
Channel	Freq.(MHz)	Channel	Freq.(MHz)
01	2412	03	2422
06	2437	06	2437
11	2462	09	2452

3. KDB 662911 D01 Multiple Transmitter Output v02r01
- 2) Directional Gain Calculations for In-Band Measurements
- a) Basic methodology with NANT transmit antennas, each with the same directional gain GANT dBi, being driven by NANT transmitter outputs of equal power. Directional gain is to be computed as follows:
- (i) If any transmit signals are correlated with each other,
Directional gain = $GANT + 10 \log(NANT)$ dBi
- (ii) If all transmit signals are completely uncorrelated with each other,
Directional gain = GANT

Antenna number: 2

ANT 1 gain : 3.46dBi

ANT 2 gain : 3.46dBi

MIMO technology Directional gain=6.47dBi

Directional gain= $3.46 + 10 \log 2 = 6.47$



2.2 DESCRIPTION OF THE TEST MODES

Each of these EUT operation mode(s) or test configuration mode(s) mentioned above was evaluated respectively.

Worst Mode	Description	Data Rate
Mode 1	TX IEEE 802.11b CH1	1 Mbps
Mode 2	TX IEEE 802.11b CH6	1 Mbps
Mode 3	TX IEEE 802.11 b CH11	1 Mbps
Mode 4	SISO mode	1 Mbps
Mode 5	TX IEEE 802.11g CH1	6 Mbps
Mode 6	TX IEEE 802.11g CH6	6 Mbps
Mode 7	TX IEEE 802.11g CH11	6 Mbps
Mode 8	SISO mode	6 Mbps
Mode 9	TX IEEE 802.11n HT20 CH1	MCS 0
Mode 10	TX IEEE 802.11n HT20 CH6	MCS 0
Mode 11	TX IEEE 802.11n HT20 CH11	MCS 0
Mode 12	keeping MIMO TX mode	MCS 0
Mode 13	TX IEEE 802.11n HT40 CH3	MCS 0
Mode 14	TX IEEE 802.11n HT40 CH6	MCS 0
Mode 15	TX IEEE 802.11n HT40 CH9	MCS 0
Mode 16	keeping MIMO TX mode	MCS 0
Mode 17	TX IEEE 802.11ax HT20 CH1	MCS 0
Mode 18	TX IEEE 802.11 ax HT20 CH6	MCS 0
Mode 19	TX IEEE 802.11 ax HT20 CH11	MCS 0
Mode 20	keeping MIMO TX mode	MCS 0
Mode 21	TX IEEE 802.11 ax HT40 CH3	MCS 0
Mode 22	TX IEEE 802.11 ax HT40 CH6	MCS 0
Mode 23	TX IEEE 802.11 ax HT40 CH9	MCS 0
Mode 24	keeping MIMO TX mode	MCS 0

Note:

- (1) The measurements are performed at all Bit Rate of Transmitter, the worst data was reported.
- (2) We have be tested for all avaiable U.S. voltage and frequencies(For 120V,50/60Hz and 240V, 50/60Hz) for which the device is capable of operation, and the worst case of 120V /60Hz is shown in the report.
- (3) The battery is fully-charged during the radited and RF conducted test.



AC Conducted Emission

Test Case	
AC Conducted Emission	Mode25: Keeping TX + WLAN Link

2.3 TEST SOFTWARE AND POWER LEVEL

During testing channel & power controlling software provided by the customer was used to control the operating channel as well as the output power level.

RF Function	Type	Mode Or Modulation type	ANT Gain(dBi)	ANT_1 Power Class	ANT_2 Power Class
WIFI(2.4G)	2.4G WIFI	802.11b	ANT 1: 3.46 ANT 2: 3.46 MIMO 1+2: 6.47	default	default
		802.11g		20	20
		802.11n(HT20)		20	20
		802.11n(HT40)		18	18
		802.11ax(HE20)		18	18
		802.11ax(HE40)		18	18

2.4 BLOCK DIAGRAM SHOWING THE CONFIGURATION OF SYSTEM TESTED

Radiation Test Set

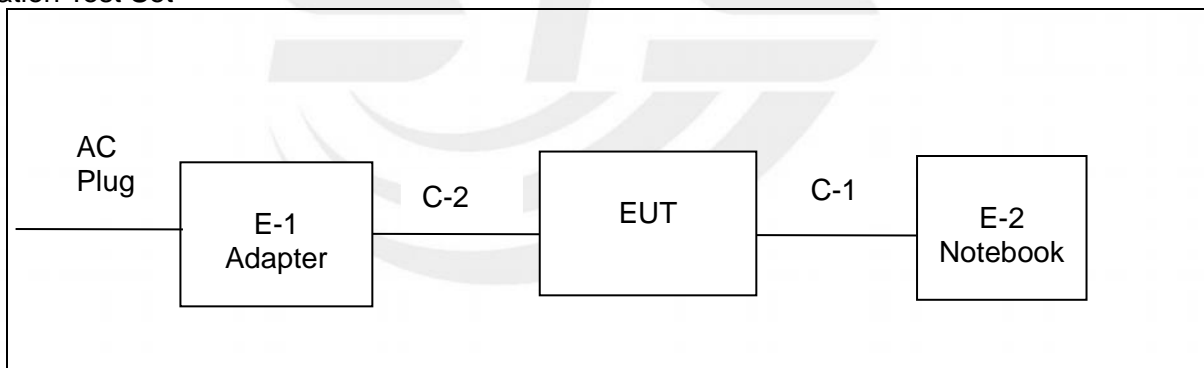

Conduction Test Set

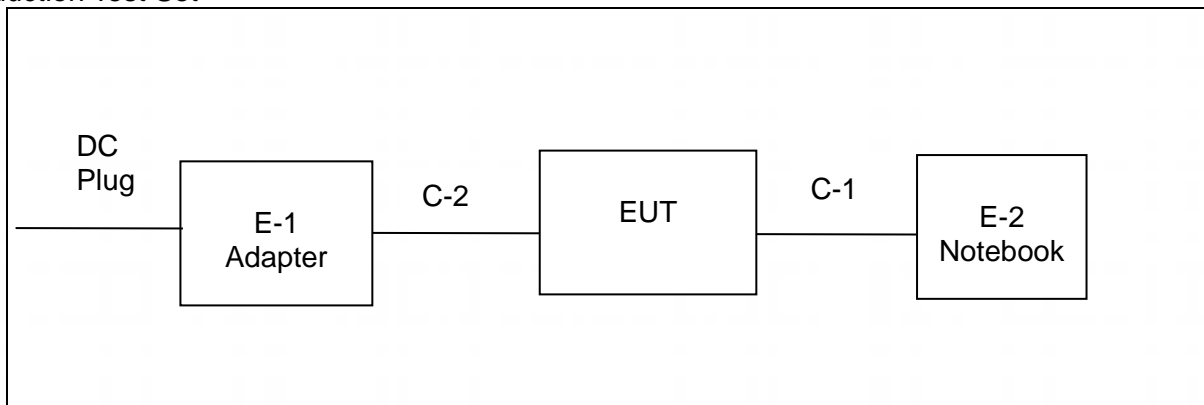



2.5 DESCRIPTION OF NECESSARY ACCESSORIES AND SUPPORT UNITS

The EUT has been tested as an independent unit together with other necessary accessories or support units. The following support units or accessories were used to form a representative test configuration during the tests.

Necessary accessories

Item	Equipment	Mfr/Brand	Model/Type No.	Length	Note
E-3	Adapter	ULL	AW36-240-1500U	N/A	N/A
C-2	DC Cable	N/A	N/A	150cm	NO

Support units

Item	Equipment	Mfr/Brand	Model/Type No.	Length	Note
C-1	LAN Cable	N/A	N/A	120cm	NO
E-1	Notebook	LENOVO	ThinkPad E470	N/A	N/A
E-2	Notebook Adapter	LENOVO	ADLX45DLC3A	N/A	N/A

Note:

- (1) For detachable type I/O cable should be specified the length in cm in 「Length」 column.
- (2) "YES" is means "with core"; "NO" is means "without core".



2.6 EQUIPMENTS LIST FOR ALL TEST ITEMS

RF Radiation Test Equipment					
Kind of Equipment	Manufacturer	Type No.	Serial No.	Last Calibration	Calibrated Until
Temperature & Humidity	SW-108	SuWei	N/A	2023.03.03	2024.03.02
Pre-Amplifier (0.1M-3GHz)	EM	EM330	060665	2022.07.04	2023.07.03
Pre-Amplifier (1G-18GHz)	SKET	LNPA-01018G-45	SK2018080901	2022.09.29	2023.09.28
18GHz-40GHz Filter	XINGBO	XBLBQ-GTA44	22062003-1	2023.03.06	2024.03.05
Pre-mpifier (18G-40G)	SKET	LNPA_1840-50	SK2018101801	2023.03.06	2024.03.05
Positioning Controller	MF	MF-7802	MF-780208587	N/A	N/A
Signal Analyzer	R&S	FSV 40-N	101823	2022.09.29	2023.09.28
Switch Control Box	N/A	N/A	N/A	N/A	N/A
Filter Box	BALUN Technology	SU319E	BL-SZ1530051	N/A	N/A
Active loop Antenna	ZHINAN	ZN30900C	16035	2023.02.28	2024.02.27
Bilog Antenna	TESEQ	CBL6111D	34678	2022.09.30	2024.09.29
Horn Antenna	SCHWARZBECK	BBHA 9120D	02014	2021.10.11	2023.10.10
Horn Antenna	A-INFOMW	LB-180400-KF	J211020657	2021.09.28	2023.09.27
Antenna Mast	MF	MFA-440H	N/A	N/A	N/A
Turn Table	MF	SC100_1	60531	N/A	N/A
AC Power Source	APC	KDF-11010G	F214050035	N/A	N/A
DC Power Supply	Zhaoxin	RXN 605D	20R605D11010081	N/A	N/A
Test SW	EZ-EMC	Ver.STSLAB-03A1 RE			
Conduction Test equipment					
Kind of Equipment	Manufacturer	Type No.	Serial No.	Last calibration	Calibrated until
Test Receiver	R&S	ESCI	101427	2022.09.29	2023.09.28
LISN	R&S	ENV216	101242	2022.09.28	2023.09.27
LISN	EMCO	3810/2NM	23625	2022.09.28	2023.09.27
Temperature & Humidity	HH660	Mieo	N/A	2022.09.30	2023.09.29
Test SW	EZ-EMC	Ver.STSLAB-03A1 CE			
RF Connected Test					
Kind of Equipment	Manufacturer	Type No.	Serial No.	Last calibration	Calibrated until
Signal Analyzer	Agilent	N9020A	MY51510623	2023.03.01	2024.02.28
Switch control box	MW	MW100-RFCB	N/A	N/A	N/A
Temperature & Humidity	HH660	Mieo	N/A	2022.09.30	2023.09.29
Test SW	MW	MTS 8310_2.0.0.0			



3. EMC EMISSION TEST

3.1 CONDUCTED EMISSION MEASUREMENT

3.1.1 POWER LINE CONDUCTED EMISSION LIMITS

The radio frequency voltage that is conducted back onto the AC power line on any frequency or frequencies, within the band 150 kHz to 30 MHz, shall not exceed the limits in the following table.

FREQUENCY (MHz)	Conducted Emission limit (dBuV)	
	Quasi-peak	Average
0.15 -0.5	66 - 56 *	56 - 46 *
0.50 -5.0	56.00	46.00
5.0 -30.0	60.00	50.00

Note:

- (1) The tighter limit applies at the band edges.
- (2) The limit of “ * ” marked band means the limitation decreases linearly with the logarithm of the frequency in the range.

The following table is the setting of the receiver

Receiver Parameters	Setting
Attenuation	10 dB
Start Frequency	0.15 MHz
Stop Frequency	30 MHz
IF Bandwidth	9 kHz

3.1.2 TEST PROCEDURE

- a. The EUT is 0.8 m from the horizontal ground plane and 0.4 m from the vertical ground plane with EUT being connected to the power mains through a line impedance stabilization network (LISN). All other support equipments are powered from additional LISN(s). The LISN provides 50 Ohm/ 50uH of coupling impedance for the measuring instrument.
- b. Interconnecting cables that hang closer than 40 cm to the ground plane shall be folded back and forth in the center forming a bundle 30 to 40 cm long.
- c. I/O cables that are not connected to a peripheral shall be bundled in the center. The end of the cable may be terminated, if required, using the correct terminating impedance. The overall length shall not exceed 1 m.
- d. LISN is at least 80 cm from the nearest part of EUT chassis.
- e. For the actual test configuration, please refer to the related Item –EUT Test Photos.

3.1.3 TEST SETUP

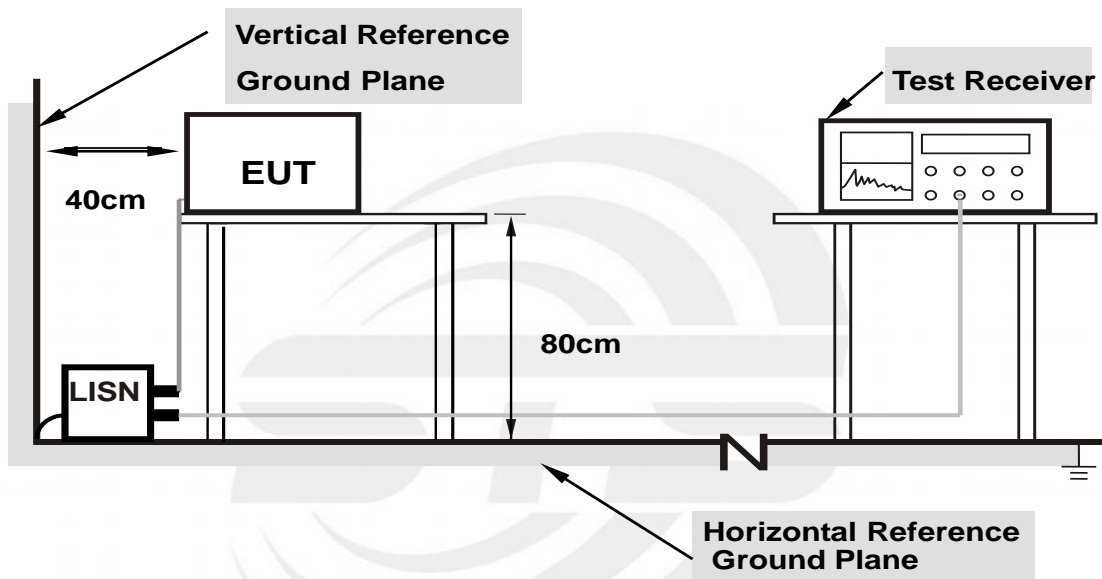

- Note: 1. Support units were connected to second LISN.**
2. Both of LISNs (AMN) are 80 cm from EUT and at least 80 cm from other units and other metal planes support units.

3.1.4 EUT OPERATING CONDITIONS

The EUT was configured for testing in a typical fashion (as a customer would normally use it). The EUT has been programmed to continuously transmit during test. This operating condition was tested and used to collect the included data.



3.1.5 TEST RESULT

Temperature:	24.5(C)	Relative Humidity:	47%RH
Test Voltage:	AC 120V/60Hz	Phase:	L
Test Mode:	Mode 25		

No.	Frequency (MHz)	Reading (dBuV)	Correct Factor(dB)	Result (dBuV)	Limit (dBuV)	Margin (dB)	Remark
1	0.1500	37.39	10.33	47.72	66.00	-18.28	QP
2	0.1500	18.31	10.33	28.64	56.00	-27.36	AVG
3	0.2460	29.18	10.52	39.70	61.89	-22.19	QP
4	0.2460	11.72	10.52	22.24	51.89	-29.65	AVG
5	0.3540	27.62	10.64	38.26	58.87	-20.61	QP
6	0.3540	17.72	10.64	28.36	48.87	-20.51	AVG
7	0.8460	17.15	10.33	27.48	56.00	-28.52	QP
8	0.8460	5.28	10.33	15.61	46.00	-30.39	AVG
9	4.7940	18.87	10.45	29.32	56.00	-26.68	QP
10	4.7940	7.55	10.45	18.00	46.00	-28.00	AVG
11	19.0180	17.44	12.67	30.11	60.00	-29.89	QP
12	19.0180	7.61	12.67	20.28	50.00	-29.72	AVG

Remark:

1. All readings are Quasi-Peak and Average values
2. Margin = Result (Result =Reading + Factor)–Limit
3. Factor=LISN factor+Cable loss+Limiter (10dB)

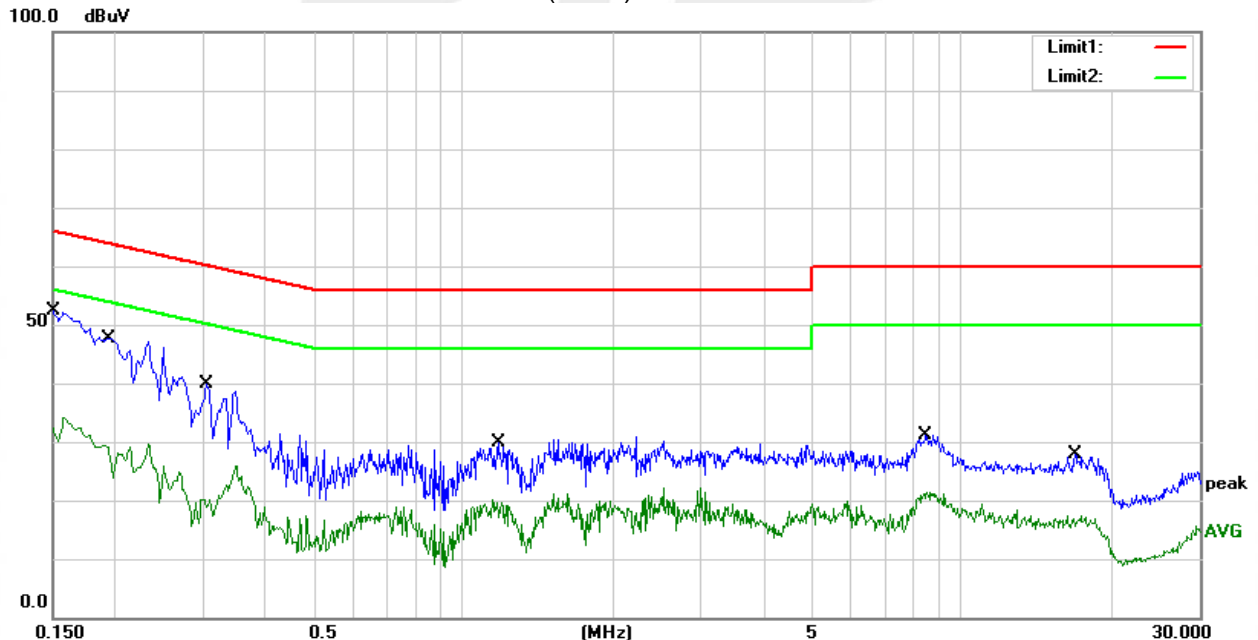



Temperature:	24.5(C)	Relative Humidity:	47%RH
Test Voltage:	AC 120V/60Hz	Phase:	N
Test Mode:	Mode 25		

No.	Frequency (MHz)	Reading (dBuV)	Correct Factor(dB)	Result (dBuV)	Limit (dBuV)	Margin (dB)	Remark
1	0.1500	40.12	10.33	50.45	66.00	-15.55	QP
2	0.1500	19.36	10.33	29.69	56.00	-26.31	AVG
3	0.2180	28.82	10.39	39.21	62.89	-23.68	QP
4	0.2180	13.46	10.39	23.85	52.89	-29.04	AVG
5	0.3660	29.29	10.61	39.90	58.59	-18.69	QP
6	0.3660	21.27	10.61	31.88	48.59	-16.71	AVG
7	1.0660	15.87	10.30	26.17	56.00	-29.83	QP
8	1.0660	6.00	10.30	16.30	46.00	-29.70	AVG
9	9.7660	18.15	11.16	29.31	60.00	-30.69	QP
10	9.7660	8.06	11.16	19.22	50.00	-30.78	AVG
11	18.9620	17.51	12.66	30.17	60.00	-29.83	QP
12	18.9620	7.99	12.66	20.65	50.00	-29.35	AVG

Remark:

1. All readings are Quasi-Peak and Average values
2. Margin = Result (Result =Reading + Factor)–Limit
3. Factor=LISN factor+Cable loss+Limiter (10dB)

100.0 dBuV

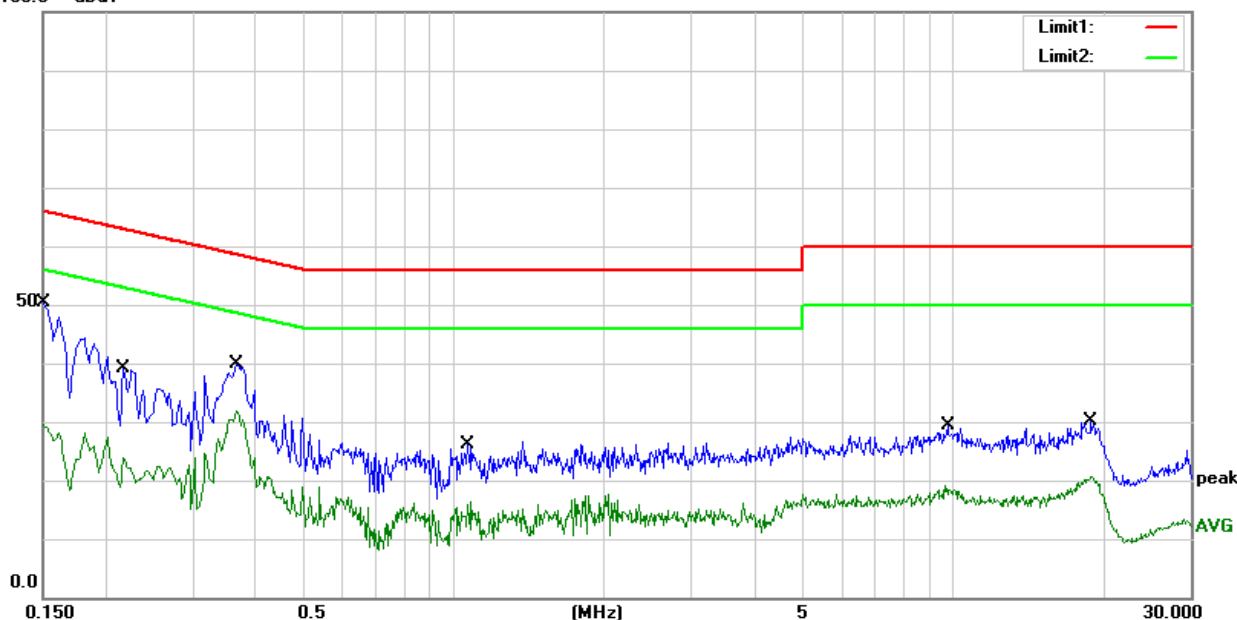



Temperature:	24.5(C)	Relative Humidity:	47%RH
Test Voltage:	AC 120V/60Hz	Phase:	L
Test Mode:	Mode 25		
Description:	POE		

No.	Frequency (MHz)	Reading (dBuV)	Correct Factor(dB)	Result (dBuV)	Limit (dBuV)	Margin (dB)	Remark
1	0.1500	40.99	10.33	51.32	66.00	-14.68	QP
2	0.1500	20.91	10.33	31.24	56.00	-24.76	AVG
3	0.3180	28.62	10.71	39.33	59.76	-20.43	QP
4	0.3180	17.13	10.71	27.84	49.76	-21.92	AVG
5	1.7060	23.43	10.30	33.73	56.00	-22.27	QP
6	1.7060	8.55	10.30	18.85	46.00	-27.15	AVG
7	4.0660	21.14	10.40	31.54	56.00	-24.46	QP
8	4.0660	8.51	10.40	18.91	46.00	-27.09	AVG
9	10.1700	21.44	11.22	32.66	60.00	-27.34	QP
10	10.1700	11.39	11.22	22.61	50.00	-27.39	AVG
11	18.7860	20.06	12.61	32.67	60.00	-27.33	QP
12	18.7860	9.08	12.61	21.69	50.00	-28.31	AVG

Remark:

1. All readings are Quasi-Peak and Average values
2. Margin = Result (Result =Reading + Factor)–Limit
3. Factor=LISN factor+Cable loss+Limiter (10dB)

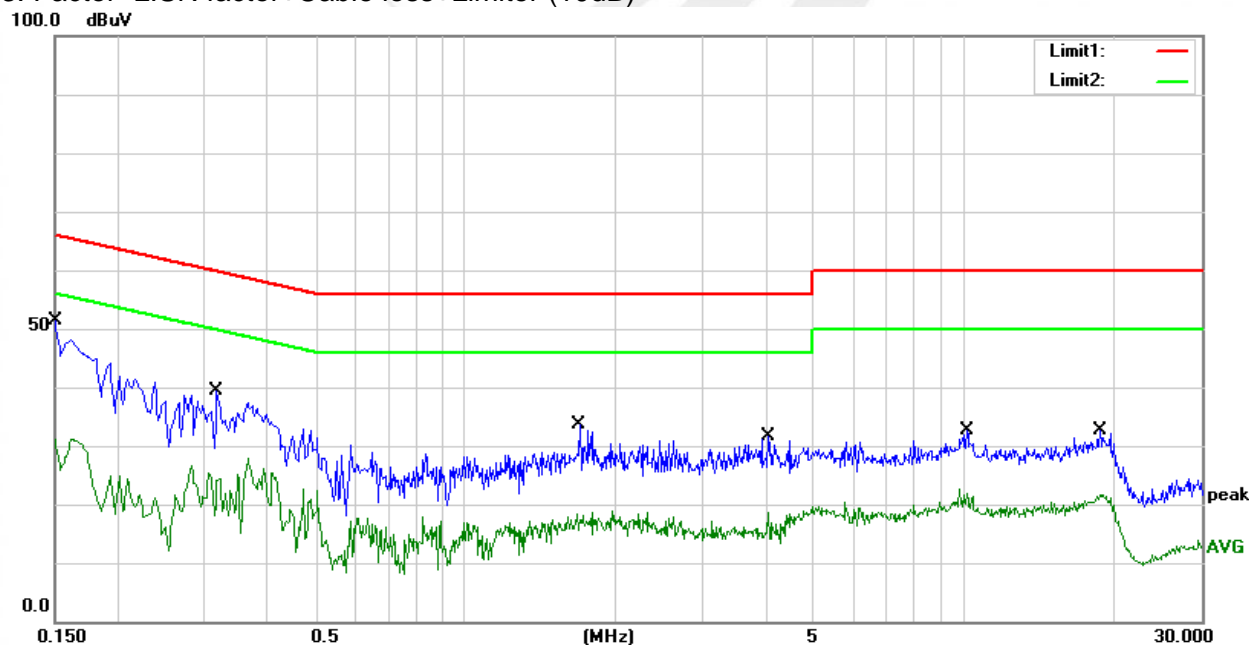



Temperature:	24.5(C)	Relative Humidity:	47%RH
Test Voltage:	AC 120V/60Hz	Phase:	N
Test Mode:	Mode 25		
Description:	POE		

No.	Frequency (MHz)	Reading (dBuV)	Correct Factor(dB)	Result (dBuV)	Limit (dBuV)	Margin (dB)	Remark
1	0.1580	39.94	10.33	50.27	65.57	-15.30	QP
2	0.1580	22.61	10.33	32.94	55.57	-22.63	AVG
3	0.3100	29.53	10.73	40.26	59.97	-19.71	QP
4	0.3100	18.54	10.73	29.27	49.97	-20.70	AVG
5	1.5260	22.24	10.30	32.54	56.00	-23.46	QP
6	1.5260	8.88	10.30	19.18	46.00	-26.82	AVG
7	3.4940	21.05	10.37	31.42	56.00	-24.58	QP
8	3.4940	7.25	10.37	17.62	46.00	-28.38	AVG
9	10.2060	21.71	11.22	32.93	60.00	-27.07	QP
10	10.2060	11.41	11.22	22.63	50.00	-27.37	AVG
11	19.0900	20.69	12.69	33.38	60.00	-26.62	QP
12	19.0900	10.74	12.69	23.43	50.00	-26.57	AVG

Remark:

1. All readings are Quasi-Peak and Average values
2. Margin = Result (Result =Reading + Factor)–Limit
3. Factor=LISN factor+Cable loss+Limiter (10dB)

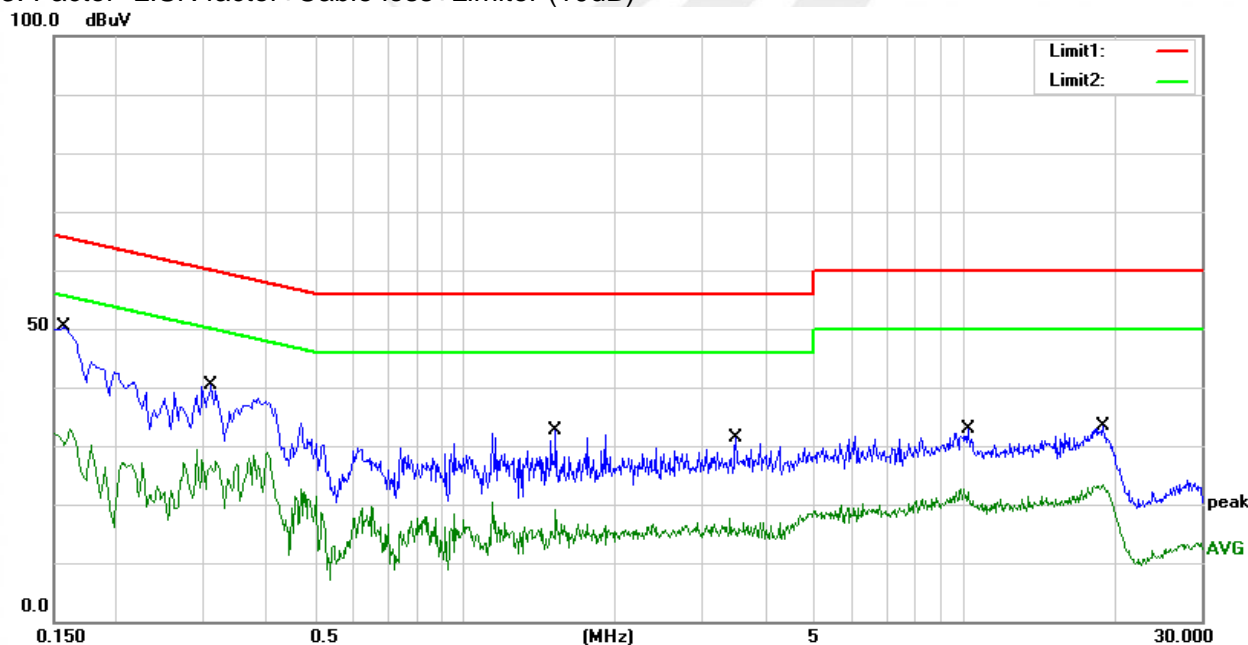



3.2 RADIATED EMISSION MEASUREMENT

3.2.1 RADIATED EMISSION LIMITS

In any 100 kHz bandwidth outside the operating frequency band. In case the emission fall within the Restricted band specified on Part15.205(a)&209(a) limit in the table and according to ANSI C63.10-2013 below has to be followed.

LIMITS OF RADIATED EMISSION MEASUREMENT (0.009MHz - 1000MHz)

Frequencies (MHz)	Field Strength (micovolts/meter)	Measurement Distance (meters)
0.009~0.490	2400/F(KHz)	300
0.490~1.705	24000/F(KHz)	30
1.705~30.0	30	30
30~88	100	3
88~216	150	3
216~960	200	3
Above 960	500	3

LIMITS OF RADIATED EMISSION MEASUREMENT (1000MHz-25GHz)

FREQUENCY (MHz)	(dBuV/m) (at 3M)	
	PEAK	AVERAGE
Above 1000	74	54

Notes:

- (1) The limit for radiated test was performed according to FCC PART 15C.
- (2) The tighter limit applies at the band edges.
- (3) Emission level (dBuV/m)=20log Emission level (uV/m).

LIMITS OF RESTRICTED FREQUENCY BANDS

FREQUENCY (MHz)	FREQUENCY (MHz)	FREQUENCY (MHz)	FREQUENCY (GHz)
0.090-0.110	16.42-16.423	399.9-410	4.5-5.15
0.495-0.505	16.69475-16.69525	608-614	5.35-5.46
2.1735-2.1905	16.80425-16.80475	960-1240	7.25-7.75
4.125-4.128	25.5-25.67	1300-1427	8.025-8.5
4.17725-4.17775	37.5-38.25	1435-1626.5	9.0-9.2
4.20725-4.20775	73-74.6	1645.5-1646.5	9.3-9.5
6.215-6.218	74.8-75.2	1660-1710	10.6-12.7
6.26775-6.26825	108-121.94	1718.8-1722.2	13.25-13.4
6.31175-6.31225	123-138	2200-2300	14.47-14.5
8.291-8.294	149.9-150.05	2310-2390	15.35-16.2
8.362-8.366	156.52475-156.52525	2483.5-2500	17.7-21.4
8.37625-8.38675	156.7-156.9	2690-2900	22.01-23.12
8.41425-8.41475	162.0125-167.17	3260-3267	23.6-24.0
12.29-12.293	167.72-173.2	3332-3339	31.2-31.8
12.51975-12.52025	240-285	3345.8-3358	36.43-36.5
12.57675-12.57725	322-335.4	3600-4400	Above 38.6
13.36-13.41			



For Radiated Emission

Spectrum Parameter	Setting
Attenuation	Auto
Detector	Peak/QP/AV
Start Frequency	9 KHz/150KHz(Peak/QP/AV)
Stop Frequency	150KHz/30MHz(Peak/QP/AV)
RB / VB (emission in restricted band)	200Hz (From 9kHz to 0.15MHz)/ 9KHz (From 0.15MHz to 30MHz); 200Hz (From 9kHz to 0.15MHz)/ 9KHz (From 0.15MHz to 30MHz)

Spectrum Parameter	Setting
Attenuation	Auto
Detector	Peak/QP
Start Frequency	30 MHz(Peak/QP)
Stop Frequency	1000 MHz (Peak/QP)
RB / VB (emission in restricted band)	120 KHz / 300 KHz

Spectrum Parameter	Setting
Attenuation	Auto
Detector	Peak/AV
Start Frequency	1000 MHz(Peak/AV)
Stop Frequency	10th carrier hamonic(Peak/AV)
RB / VB (emission in restricted band)	1 MHz / 3 MHz(Peak) 1 MHz/1/T MHz(AVG)

For Restricted band

Spectrum Parameter	Setting
Detector	Peak/AV
Start/Stop Frequency	Lower Band Edge: 2310 to 2430 MHz Upper Band Edge: 2445 to 2500 MHz
RB / VB	1 MHz / 3 MHz(Peak) 1 MHz/1/T MHz(AVG)



Receiver Parameter	Setting
Start ~ Stop Frequency	9kHz~90kHz / RB 200Hz for PK & AV
Start ~ Stop Frequency	90kHz~110kHz / RB 200Hz for QP
Start ~ Stop Frequency	110kHz~490kHz / RB 200Hz for PK & AV
Start ~ Stop Frequency	490kHz~30MHz / RB 9kHz for QP
Start ~ Stop Frequency	30MHz~1000MHz / RB 120kHz for QP

3.2.2 TEST PROCEDURE

- a. The measuring distance at 3 m shall be used for measurements at frequency 0.009MHz up to 1GHz, and above 1GHz.
- b. The EUT was placed on the top of a rotating table 0.8 m (above 1GHz is 1.5 m) above the ground at a 3 m anechoic chamber test site. The table was rotated 360 degree to determine the position of the highest radiation.
- c. The height of the equipment shall be 0.8 m (above 1GHz is 1.5 m); the height of the test antenna shall vary between 1 m to 4 m. Horizontal and vertical polarization of the antenna are set to make the measurement.
- d. The initial step in collecting conducted emission data is a spectrum analyzer peak detector mode pre-scanning the measurement frequency range. Significant peaks are then marked and QuasiPeak detector mode will be re-measured.
- e. If the Peak Mode measured value is compliance with and lower than Quasi Peak Mode Limit, the EUT shall be deemed to meet QP Limits and no additional QP Mode measurement was performed.
- f. For the actual test configuration, please refer to the related Item –EUT Test Photos.

Note:

Both horizontal and vertical antenna polarities were tested and performed pretest to three orthogonal axis. The worst case emissions were reported.

3.2.3 TEST SETUP

(A) Radiated Emission Test-Up Frequency Below 30MHz

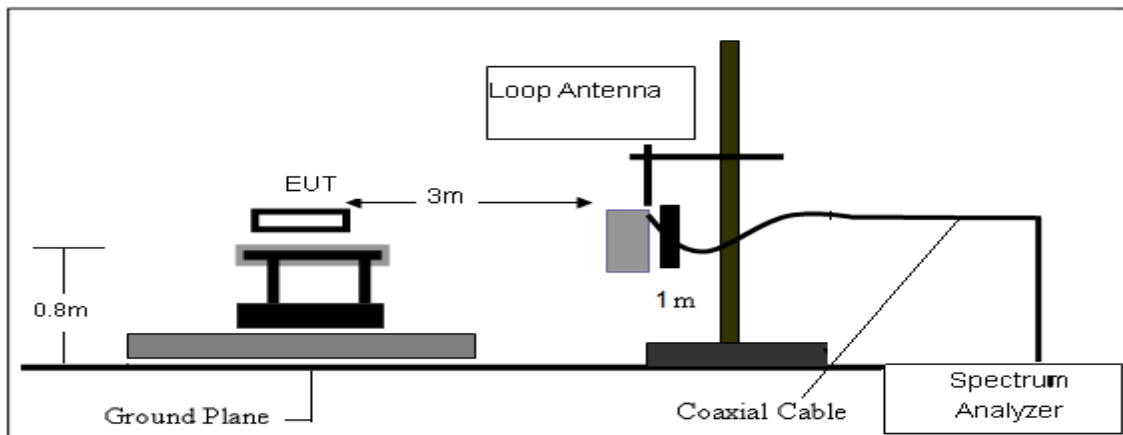

(B) Radiated Emission Test-Up Frequency 30MHz~1GHz

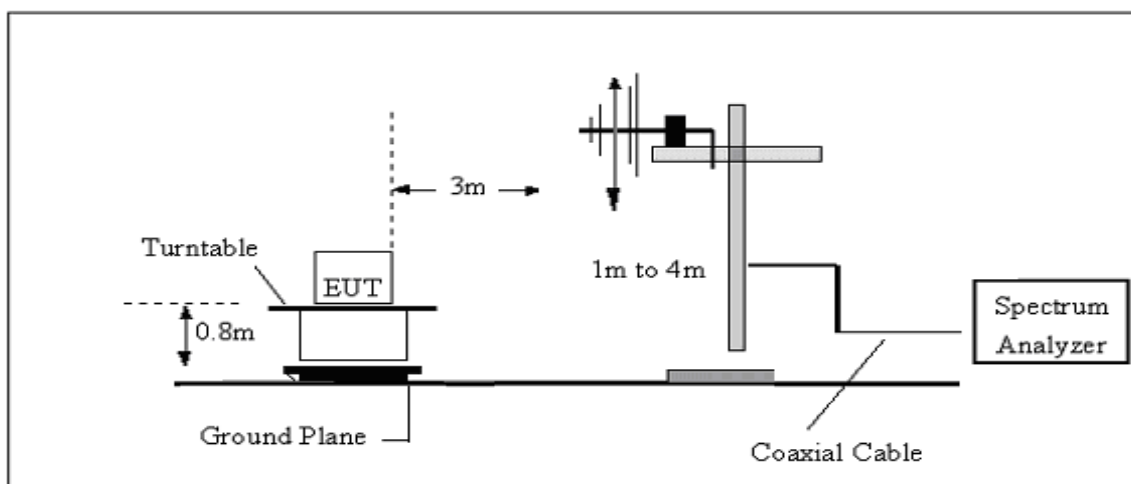

(C) Radiated Emission Test-Up Frequency Above 1GHz

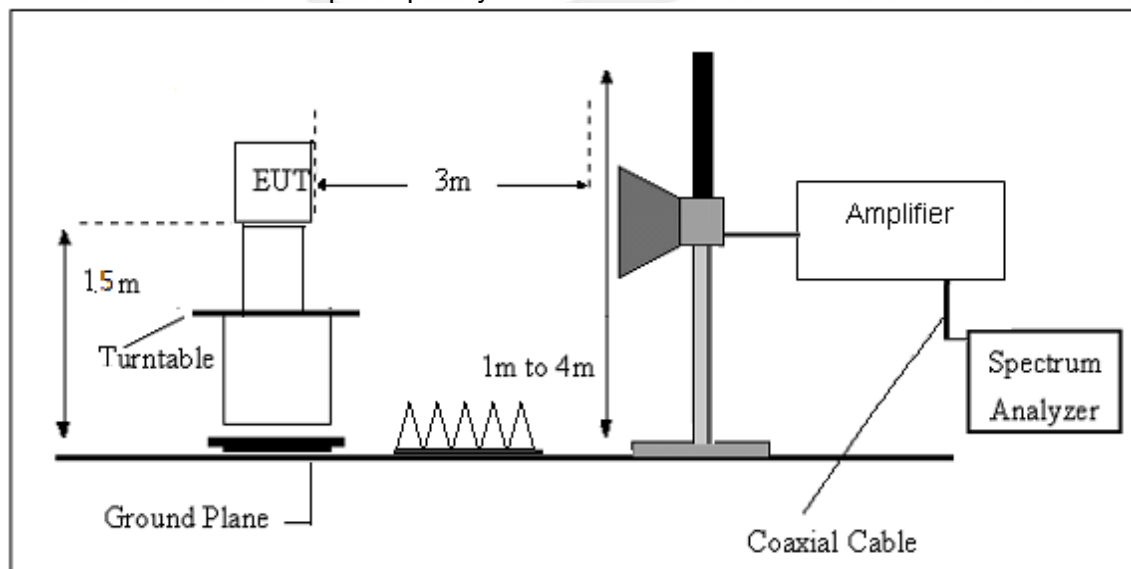

3.2.4 EUT OPERATING CONDITIONS

Please refer to section 3.1.4 of this report.



3.2.5 FIELD STRENGTH CALCULATION

The field strength is calculated by adding the Antenna Factor and Cable Factor and subtracting the Amplifier Gain and Duty Cycle Correction Factor (if any) from the measured reading. The basic equation with a sample calculation is as follows:

$$FS = RA + AF + CL - AG$$

Where

FS = Field Strength

CL = Cable Attenuation Factor (Cable Loss)

RA = Reading Amplitude

AG = Amplifier Gain

AF = Antenna Factor

For example

Frequency (MHz)	FS (dB μ V/m)	RA (dB μ V/m)	AF (dB)	CL (dB)	AG (dB)	Factor (dB)
300	40	58.1	12.2	1.6	31.9	-18.1

$$\text{Factor} = \text{AF} + \text{CL} - \text{AG}$$





3.2.6 TEST RESULT

9KHz-30MHz

Temperature:	23.1(C)	Relative Humidity:	60%RH
Test Voltage:	AC 120V/60Hz	Polarization:	--
Test Mode:	TX Mode		

Freq. (MHz)	Reading (dBuV/m)	Limit (dBuV/m)	Margin (dB)	State P/F	Test Result
--	--	--	--	--	PASS
--	--	--	--	--	PASS

Note:

The amplitude of spurious emissions which are attenuated by more than 20dB below the permissible value has no need to be reported.

Distance extrapolation factor = $40 \log(\text{specific distance}/\text{test distance})$ (dB);

Limit line = specific limits(dBuV) + distance extrapolation factor.



(30MHz - 1000MHz)

Temperature:	23.1(C)	Relative Humidity:	60%RH
Test Voltage:	AC 120V/60Hz	Phase:	Horizontal
Test Mode:	Mode 1-24 (Mode 12 worst mode)		

No.	Frequency (MHz)	Reading (dBuV)	Correct Factor(dB/m)	Result (dBuV/m)	Limit (dBuV/m)	Margin (dB)	Remark
1	35.8200	37.79	-15.91	21.88	40.00	-18.12	peak
2	64.9200	51.06	-25.62	25.44	40.00	-14.56	peak
3	155.1300	49.52	-18.63	30.89	43.50	-12.61	peak
4	182.2900	57.20	-20.19	37.01	43.50	-6.49	peak
5	375.3200	52.34	-12.37	39.97	46.00	-6.03	peak
6	763.3200	40.16	-2.22	37.94	46.00	-8.06	peak

Remark:

- Margin = Result (Result =Reading + Factor)-Limit
- Factor= Antenna factor+Cable attenuation factor(cable loss)-Amplifier gain

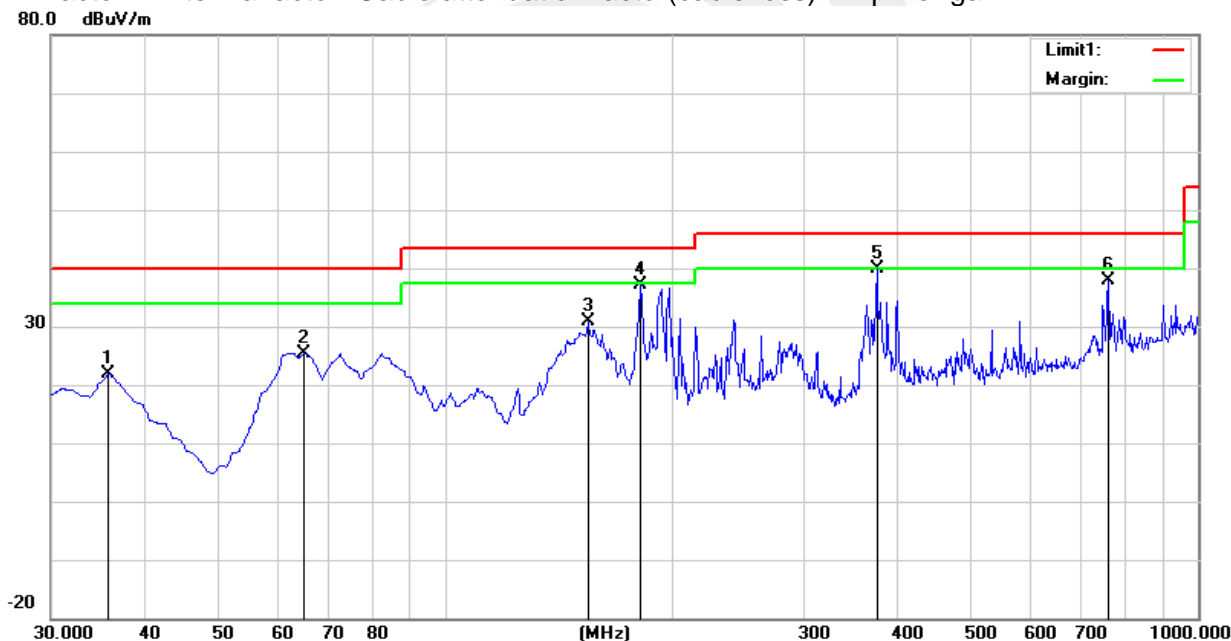



Temperature:	23.1(C)	Relative Humidity:	60%RH
Test Voltage:	AC 120V/60Hz	Phase:	Vertical
Test Mode:	Mode 1-24 (Mode 12 worst mode)		

No.	Frequency (MHz)	Reading (dBuV)	Correct Factor(dB/m)	Result (dBuV/m)	Limit (dBuV/m)	Margin (dB)	Remark
1	35.8200	47.05	-15.91	31.14	40.00	-8.86	peak
2	65.8900	58.34	-25.60	32.74	40.00	-7.26	peak
3	192.9600	56.13	-21.08	35.05	43.50	-8.45	peak
4	374.3500	48.29	-12.39	35.90	46.00	-10.10	peak
5	580.9600	33.67	-5.76	27.91	46.00	-18.09	peak
6	762.3500	37.88	-2.21	35.67	46.00	-10.33	peak

Remark:.

- Margin = Result (Result =Reading + Factor)–Limit
- Factor= Antenna factor+Cable attenuation factor(cable loss)-Amplifier gain

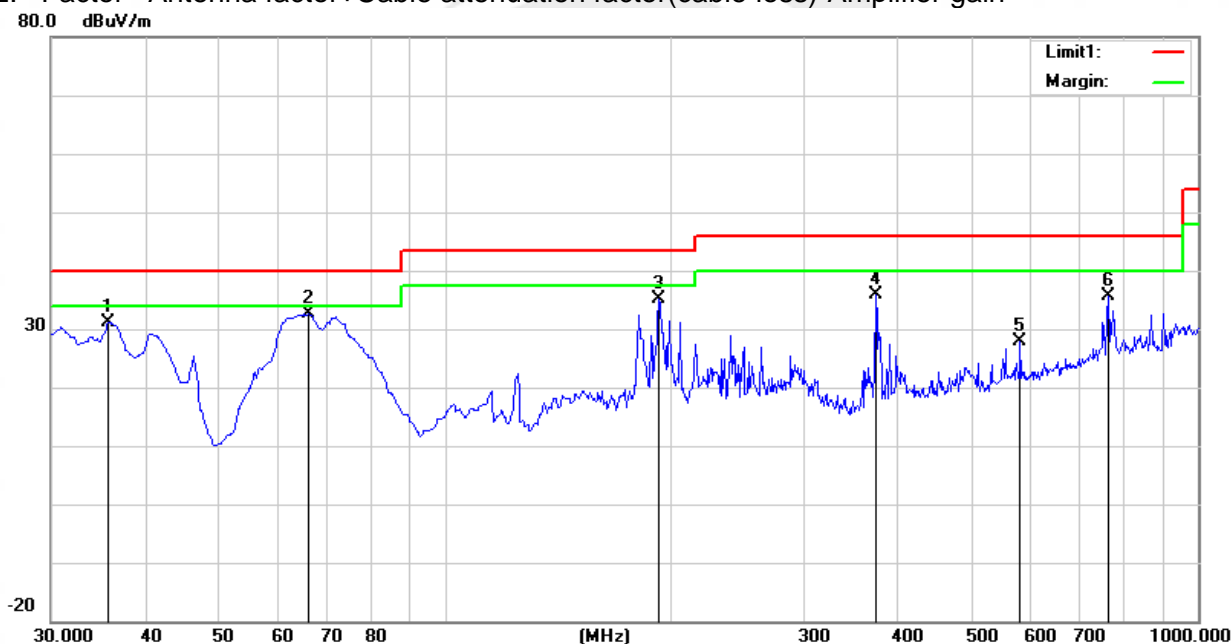



(1000MHz-25GHz) Spurious emission Requirements

802.11n (HT20)

Frequency (MHz)	Meter Reading (dBμV)	Amplifier (dB)	Loss (dB)	Antenna Factor (dB/m)	Corrected Factor (dB)	Emission Level (dBμV/m)	Limits (dBμV/m)	Margin (dB)	Detector Type	Comment
Low Channel (802.11n20/2412 MHz)										
3264.86	62.19	44.70	6.70	28.20	-9.80	52.39	74.00	-21.61	PK	Vertical
3264.86	50.83	44.70	6.70	28.20	-9.80	41.03	54.00	-12.97	AV	Vertical
3264.72	61.20	44.70	6.70	28.20	-9.80	51.40	74.00	-22.60	PK	Horizontal
3264.72	50.43	44.70	6.70	28.20	-9.80	40.63	54.00	-13.37	AV	Horizontal
4824.42	59.29	44.20	9.04	31.60	-3.56	55.73	74.00	-18.27	PK	Vertical
4824.42	49.62	44.20	9.04	31.60	-3.56	46.06	54.00	-7.94	AV	Vertical
4824.61	58.94	44.20	9.04	31.60	-3.56	55.38	74.00	-18.62	PK	Horizontal
4824.61	50.23	44.20	9.04	31.60	-3.56	46.67	54.00	-7.33	AV	Horizontal
5359.89	48.68	44.20	9.86	32.00	-2.34	46.33	74.00	-27.67	PK	Vertical
5359.89	39.63	44.20	9.86	32.00	-2.34	37.29	54.00	-16.71	AV	Vertical
5359.76	48.29	44.20	9.86	32.00	-2.34	45.94	74.00	-28.06	PK	Horizontal
5359.76	39.17	44.20	9.86	32.00	-2.34	36.83	54.00	-17.17	AV	Horizontal
7235.94	53.71	43.50	11.40	35.50	3.40	57.11	74.00	-16.89	PK	Vertical
7235.94	44.30	43.50	11.40	35.50	3.40	47.70	54.00	-6.30	AV	Vertical
7235.70	53.86	43.50	11.40	35.50	3.40	57.26	74.00	-16.74	PK	Horizontal
7235.70	44.30	43.50	11.40	35.50	3.40	47.70	54.00	-6.30	AV	Horizontal
Middle Channel (802.11n20/2437 MHz)										
3264.72	61.61	44.70	6.70	28.20	-9.80	51.81	74.00	-22.19	PK	Vertical
3264.72	51.45	44.70	6.70	28.20	-9.80	41.65	54.00	-12.35	AV	Vertical
3264.75	61.46	44.70	6.70	28.20	-9.80	51.66	74.00	-22.34	PK	Horizontal
3264.75	51.21	44.70	6.70	28.20	-9.80	41.41	54.00	-12.59	AV	Horizontal
4874.35	59.03	44.20	9.04	31.60	-3.56	55.47	74.00	-18.53	PK	Vertical
4874.35	50.15	44.20	9.04	31.60	-3.56	46.59	54.00	-7.41	AV	Vertical
4874.36	58.61	44.20	9.04	31.60	-3.56	55.05	74.00	-18.95	PK	Horizontal
4874.36	50.27	44.20	9.04	31.60	-3.56	46.71	54.00	-7.29	AV	Horizontal
5359.62	48.61	44.20	9.86	32.00	-2.34	46.27	74.00	-27.73	PK	Vertical
5359.62	39.95	44.20	9.86	32.00	-2.34	37.61	54.00	-16.39	AV	Vertical
5359.63	48.10	44.20	9.86	32.00	-2.34	45.76	74.00	-28.24	PK	Horizontal
5359.63	39.31	44.20	9.86	32.00	-2.34	36.97	54.00	-17.03	AV	Horizontal
7310.80	54.58	43.50	11.40	35.50	3.40	57.98	74.00	-16.02	PK	Vertical
7310.80	44.85	43.50	11.40	35.50	3.40	48.25	54.00	-5.75	AV	Vertical
7310.81	54.23	43.50	11.40	35.50	3.40	57.63	74.00	-16.37	PK	Horizontal
7310.81	44.44	43.50	11.40	35.50	3.40	47.84	54.00	-6.16	AV	Horizontal



High Channel (802.11n20/2462 MHz)										
3264.81	61.58	44.70	6.70	28.20	-9.80	51.78	74.00	-22.22	PK	Vertical
3264.81	51.03	44.70	6.70	28.20	-9.80	41.23	54.00	-12.77	AV	Vertical
3264.82	61.53	44.70	6.70	28.20	-9.80	51.73	74.00	-22.27	PK	Horizontal
3264.82	50.78	44.70	6.70	28.20	-9.80	40.98	54.00	-13.02	AV	Horizontal
4924.50	58.51	44.20	9.04	31.60	-3.56	54.95	74.00	-19.05	PK	Vertical
4924.50	50.50	44.20	9.04	31.60	-3.56	46.94	54.00	-7.06	AV	Vertical
4924.47	59.52	44.20	9.04	31.60	-3.56	55.96	74.00	-18.04	PK	Horizontal
4924.47	49.51	44.20	9.04	31.60	-3.56	45.95	54.00	-8.05	AV	Horizontal
5359.76	49.29	44.20	9.86	32.00	-2.34	46.94	74.00	-27.06	PK	Vertical
5359.76	39.78	44.20	9.86	32.00	-2.34	37.44	54.00	-16.56	AV	Vertical
5359.72	47.65	44.20	9.86	32.00	-2.34	45.30	74.00	-28.70	PK	Horizontal
5359.72	39.23	44.20	9.86	32.00	-2.34	36.89	54.00	-17.11	AV	Horizontal
7385.76	54.75	43.50	11.40	35.50	3.40	58.15	74.00	-15.85	PK	Vertical
7385.76	43.70	43.50	11.40	35.50	3.40	47.10	54.00	-6.90	AV	Vertical
7385.84	53.51	43.50	11.40	35.50	3.40	56.91	74.00	-17.09	PK	Horizontal
7385.84	44.92	43.50	11.40	35.50	3.40	48.32	54.00	-5.68	AV	Horizontal

Remark:

- Factor = Antenna Factor + Cable Loss – Pre-amplifier.
- Scan with 802.11b, 802.11g, 802.11n (HT-20), 802.11n (HT-40), 802.11ax (HE-20), 802.11ax (HE-40) all have been tested the antenna 1, antenna 2 and antenna 1+2, the worst case is 802.11n(HT20) of the antenna 1+2.
Emission Level = Reading + Factor
Margin = Emission Level-Limit
- The frequency emission of peak points that did not show above the forms are at least 20dB below the limit, the frequency emission is mainly from the environment noise.



3.2.6 TEST RESULTS(Band edge Requirements)

802.11n (HT20)-Low

Horizontal

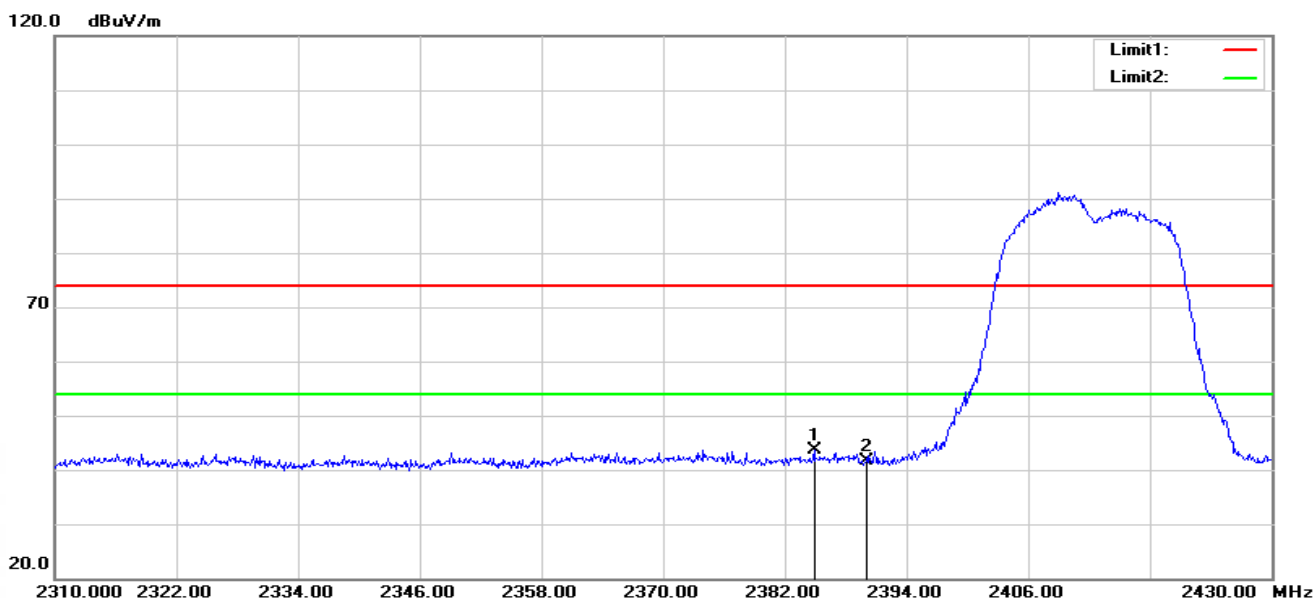

No.	Frequency (MHz)	Reading (dBuV)	Correct Factor(dB/m)	Result (dBuV/m)	Limit (dBuV/m)	Margin (dB)	Remark
1	2384.880	39.44	4.26	43.70	74.00	-30.30	peak
2	2390.000	37.19	4.34	41.53	74.00	-32.47	peak

Vertical

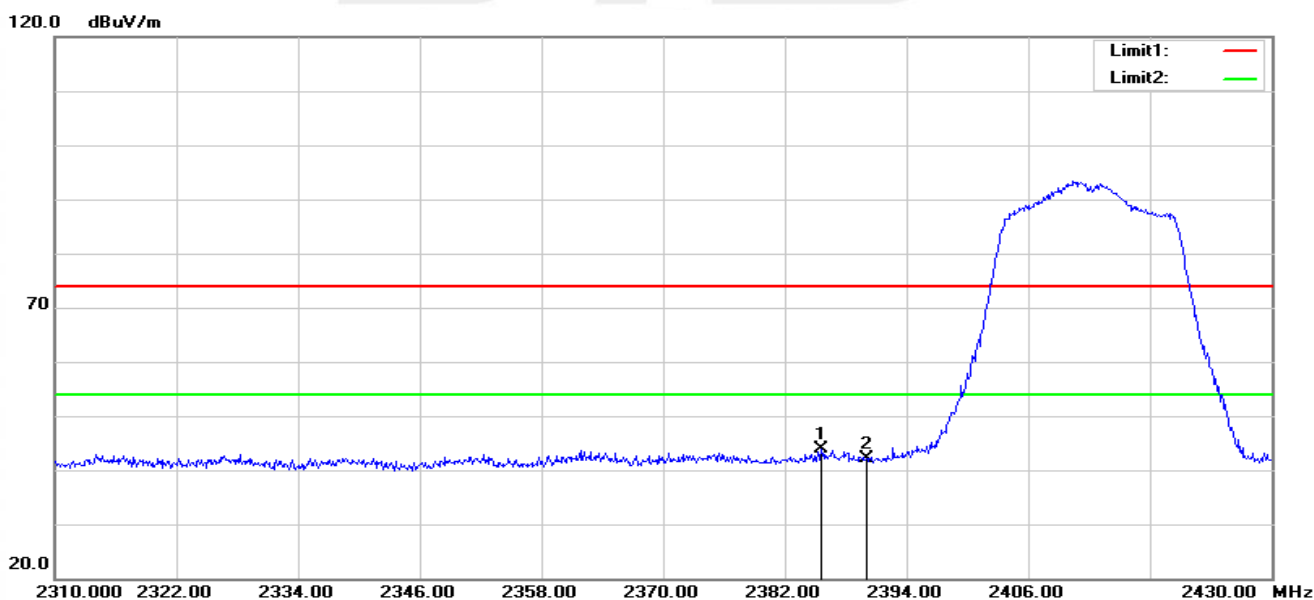

No.	Frequency (MHz)	Reading (dBuV)	Correct Factor(dB/m)	Result (dBuV/m)	Limit (dBuV/m)	Margin (dB)	Remark
1	2385.600	39.53	4.27	43.80	74.00	-30.20	peak
2	2390.000	37.80	4.34	42.14	74.00	-31.86	peak



802.11n (HT20)-High

Horizontal

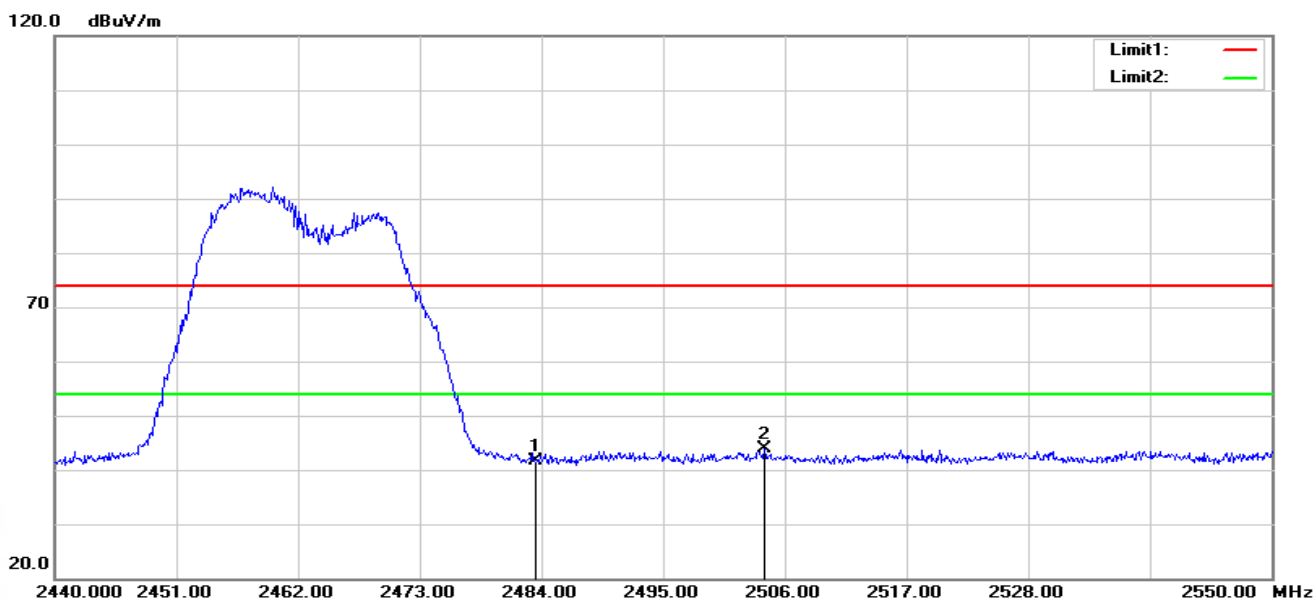

No.	Frequency (MHz)	Reading (dBuV)	Correct Factor(dB/m)	Result (dBuV/m)	Limit (dBuV/m)	Margin (dB)	Remark
1	2483.500	36.98	4.60	41.58	74.00	-32.42	peak
2	2504.130	39.09	4.67	43.76	74.00	-30.24	peak

Vertical

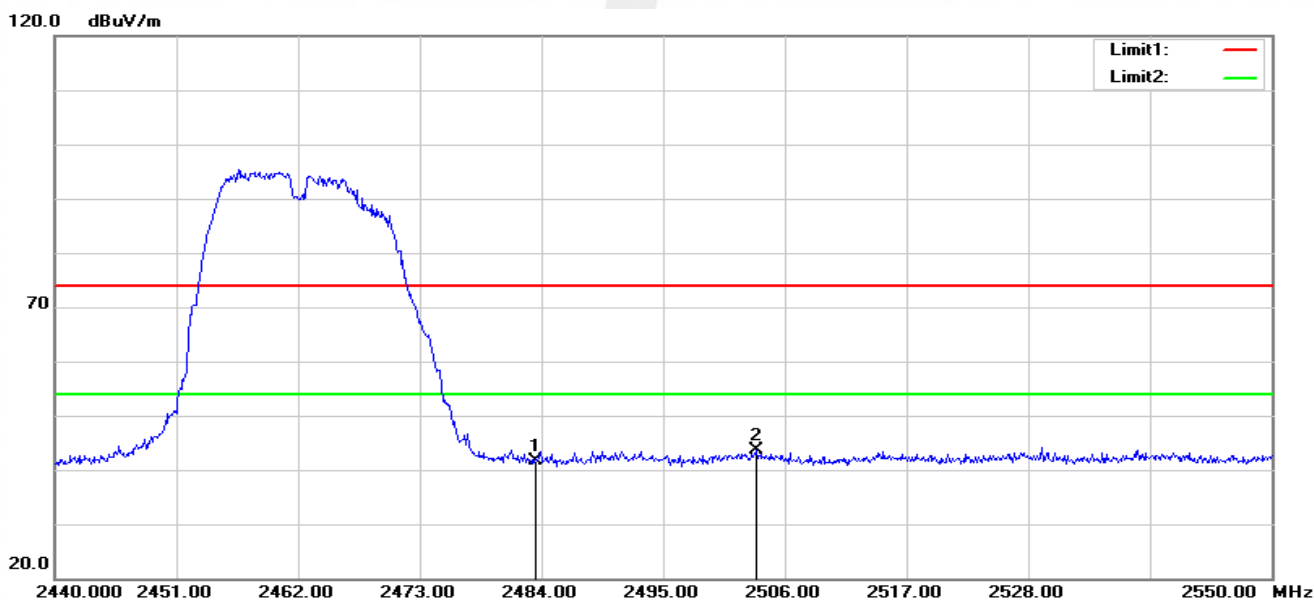

No.	Frequency (MHz)	Reading (dBuV)	Correct Factor(dB/m)	Result (dBuV/m)	Limit (dBuV/m)	Margin (dB)	Remark
1	2483.500	37.08	4.60	41.68	74.00	-32.32	peak
2	2503.470	38.94	4.67	43.61	74.00	-30.39	peak

Note: 802.11b, 802.11g, 802.11n (HT-20), 802.11n (HT-40) ,802.11ax (HE-20), 802.11ax (HE-40)all have been tested the antenna 1, antenna 2 and antenna 1+2, the worst case is 802.11n (HT20) of the antenna 1+2.

4. CONDUCTED SPURIOUS & BAND EDGE EMISSION

4.1 LIMIT

According to FCC section 15.247(d), in any 100kHz bandwidth outside the frequency band in which the spread spectrum or digitally modulated intentional radiator is operating, the radio frequency power that is produced by the intentional radiator shall be at least 20dB below that in the 100kHz bandwidth within the band that contains the highest level of the desired power, based on either an RF conducted or a radiated measurement.

4.2 TEST PROCEDURE

Spectrum Parameter	Setting
Detector	Peak
Start/Stop Frequency	30 MHz to 10th carrier harmonic
RB / VB (emission in restricted band)	100 KHz/300 KHz
Trace-Mode:	Max hold

For Band edge

Spectrum Parameter	Setting
Detector	Peak
Start/Stop Frequency	Lower Band Edge: 2300 to 2432 MHz Upper Band Edge: 2442 to 2500 MHz
RB / VB (emission in restricted band)	100 KHz/300 KHz
Trace-Mode:	Max hold

4.3 DEVIATION FROM STANDARD

No deviation.

4.4 TEST SETUP



The EUT is connected to the Spectrum Analyzer; the RF load attached to the EUT antenna terminal is 50Ohm; the path loss as the factor is calibrated to correct the reading. Make the measurement with the spectrum analyzer's resolution bandwidth (RBW) = 100 kHz. In order to make an accurate measurement, set the span greater than RBW.

4.5 EUT OPERATION CONDITIONS

Please refer to section 3.1.4 of this report.

4.6 TEST RESULTS

Note: 1. ANT 2 Power > ANT 1 Power, Both ANT1 and 2 have been test, Only show the worst data of ANT 2

2. The test data please refer to APPENDIX 1.

5. POWER SPECTRAL DENSITY TEST

5.1 LIMIT

FCC Part15.247 , Subpart C				
Section	Test Item	Limit	Frequency Range (MHz)	Result
15.247(e)	Power Spectral Density	$\leq 8 \text{ dBm}$ (RBW $\geq 3\text{KHz}$)	2400-2483.5	PASS

5.2 TEST PROCEDURE

1. Set analyzer center frequency to DTS channel center frequency.
2. Set the span to 1.5 times the DTS channel bandwidth.
3. Set the $100 \text{ kHz} \geq \text{RBW} \geq 3 \text{ kHz}$.
4. Set the $\text{VBW} \geq 3 \times \text{RBW}$.
5. Detector = peak.
6. Sweep time = auto couple.
7. Trace mode = max hold.
8. Allow trace to fully stabilize.
9. Use the peak marker function to determine the maximum amplitude level.
10. If measured value exceeds limit, reduce RBW (no less than 3 kHz) and repeat.

5.3 DEVIATION FROM STANDARD

No deviation.

5.4 TEST SETUP



5.5 EUT OPERATION CONDITIONS

Please refer to section 3.1.4 of this report.

5.6 TEST RESULTS

Note: The test data please refer to APPENDIX 1.

6. BANDWIDTH TEST

6.1 LIMIT

FCC Part15.247,Subpart C				
Section	Test Item	Limit	Frequency Range (MHz)	Result
15.247(a)(2)	Bandwidth	≥500KHz (6dB bandwidth)	2400-2483.5	PASS

6.2 TEST PROCEDURE

The automatic bandwidth measurement capability of an instrument may be employed using the X dB bandwidth mode with X set to 6 dB, if the functionality described above (i.e., RBW = 100 kHz, VBW≥3RBW, peak detector with maximum hold) is implemented by the instrumentation function. When using this capability, care shall be taken so that the bandwidth measurement is not influenced by any intermediate power nulls in the fundamental emission that might be ≥6 dB.

6.3 DEVIATION FROM STANDARD

No deviation.

6.4 TEST SETUP



6.5 EUT OPERATION CONDITIONS

Please refer to section 3.1.4 of this report.

6.6 TEST RESULTS

Note: 1. ANT 2 Power > ANT 1 Power, Both ANT1 and 2 have been test, Only show the worst data of ANT 2

2. The test data please refer to APPENDIX 1.



7. PEAK OUTPUT POWER TEST

7.1 LIMIT

FCC Part15.247, Subpart C				
Section	Test Item	Limit	Frequency Range (MHz)	Result
15.247(b)(3)	Output Power	1 watt or 30dBm	2400-2483.5	PASS

7.2 TEST PROCEDURE

One of the following procedures may be used to determine the maximum peak conducted output power of a DTS EUT.

RBW \geq DTS bandwidth

The following procedure shall be used when an instrument with a resolution bandwidth that is greater than the DTS bandwidth is available to perform the measurement:

- Set the RBW \geq DTS bandwidth.
- Set VBW \geq [3 \times RBW].
- Set span \geq [3 \times RBW].
- Sweep time = auto couple.
- Detector = peak.
- Trace mode = max hold.
- Allow trace to fully stabilize.
- Use peak marker function to determine the peak amplitude level.

Integrated band power method:

The following procedure can be used when the maximum available RBW of the instrument is less than the

DTS bandwidth:

- Set the RBW = 1 MHz.
- Set the VBW \geq [3 \times RBW].
- Set the span \geq [1.5 \times DTS bandwidth].
- Detector = peak.
- Sweep time = auto couple.
- Trace mode = max hold.
- Allow trace to fully stabilize.
- Use the instrument's band/channel power measurement function with the band limits set equal to the DTS bandwidth edges (for some instruments, this may require a manual override to select the peak detector). If the instrument does not have a band power function, then sum the spectrum levels (in linear power units) at intervals equal to the RBW extending across the DTS channel bandwidth.

PKPM1 Peak power meter method:

The maximum peak conducted output power may be measured using a broadband peak RF power meter. The power meter shall have a video bandwidth that is greater than or equal to the DTS bandwidth and shall use a fast-responding diode detector.

7.3 DEVIATION FROM STANDARD

No deviation.

7.4 TEST SETUP



7.5 EUT OPERATION CONDITIONS

Please refer to section 3.1.4 of this report.

7.6 TEST RESULTS

Note: The test data please refer to APPENDIX 1.

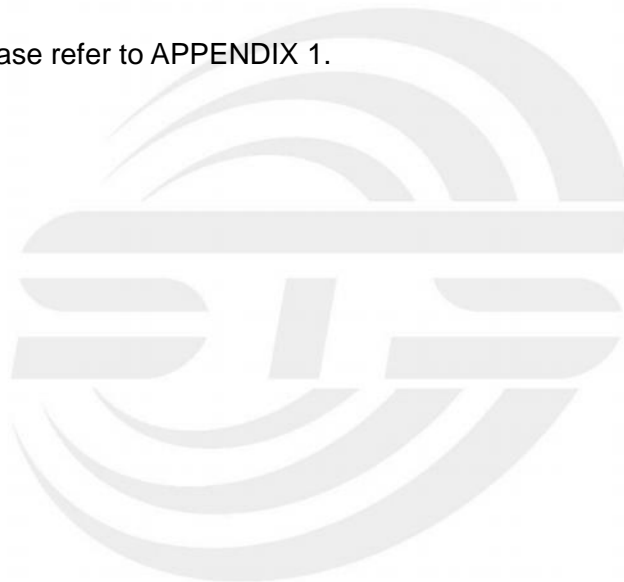



8. ANTENNA REQUIREMENT

8.1 STANDARD REQUIREMENT

15.203 requirement: For intentional device, according to 15.203: an intentional radiator shall be designed to ensure that no antenna other than that furnished by the responsible party shall be used with the device.

8.2 EUT ANTENNA

The EUT antenna is External Omni antenna Antenna. It comply with the standard requirement.





APPENDIX 1-TEST DATA

1. Duty Cycle

Condition	Mode	Frequency (MHz)	Antenna	Duty Cycle (%)	Correction Factor (dB)	1/T (kHz)
NVNT	b	2412	Ant1	98.23	0.08	1.5
NVNT	b	2437	Ant1	98.23	0.08	1.5
NVNT	b	2462	Ant1	98.49	0.07	1.5
NVNT	b	2412	Ant2	98.23	0.08	1.5
NVNT	b	2437	Ant2	98.23	0.08	1.5
NVNT	b	2462	Ant2	98.23	0.08	1.5
NVNT	g	2412	Ant1	99.35	0.03	0.51
NVNT	g	2437	Ant1	99.3	0.03	0.51
NVNT	g	2462	Ant1	99.25	0.03	0.51
NVNT	g	2412	Ant2	99.3	0.03	0.51
NVNT	g	2437	Ant2	88.46	0.53	0.51
NVNT	g	2462	Ant2	99.3	0.03	0.51
NVNT	ax20	2412	Sum	99.75	0.01	0.18
NVNT	ax20	2437	Sum	99.75	0.01	0.18
NVNT	ax20	2462	Sum	99.72	0.01	0.18
NVNT	ax40	2422	Sum	99.72	0.01	0.18
NVNT	ax40	2437	Sum	99.72	0.01	0.18
NVNT	ax40	2452	Sum	99.72	0.01	0.18
NVNT	n20	2412	Sum	99.72	0.01	0.18
NVNT	n20	2437	Sum	99.75	0.01	0.18
NVNT	n20	2462	Sum	99.75	0.01	0.18
NVNT	n40	2422	Sum	99.71	0.01	0.18
NVNT	n40	2437	Sum	95.33	0.21	0.18
NVNT	n40	2452	Sum	99.82	0.01	0.18

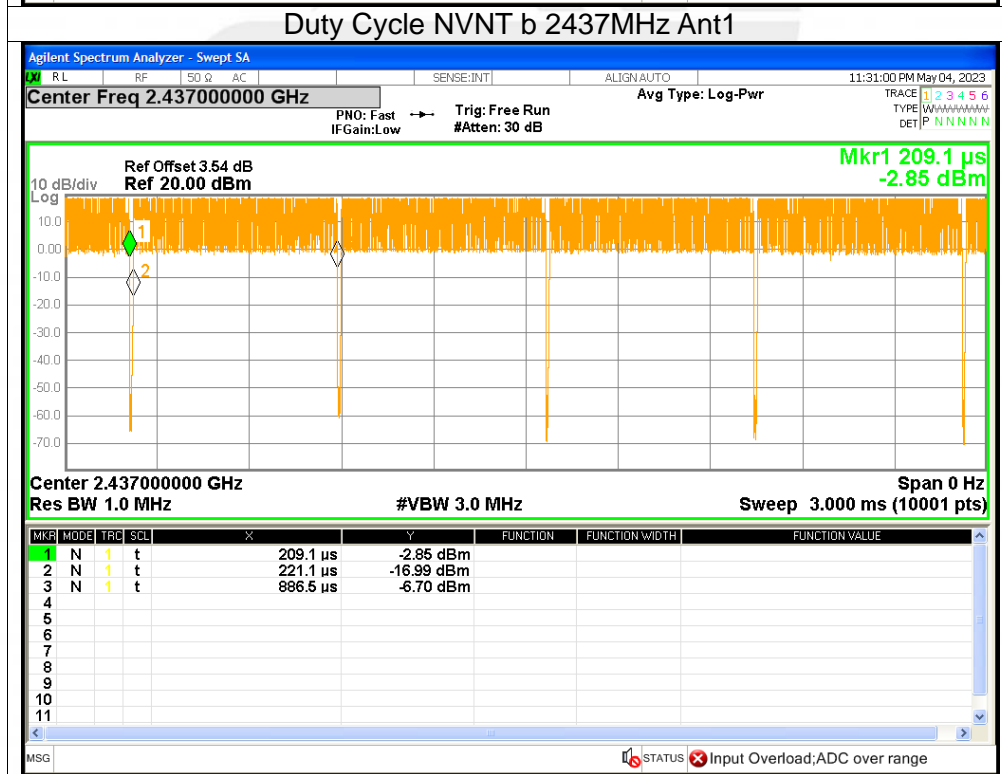
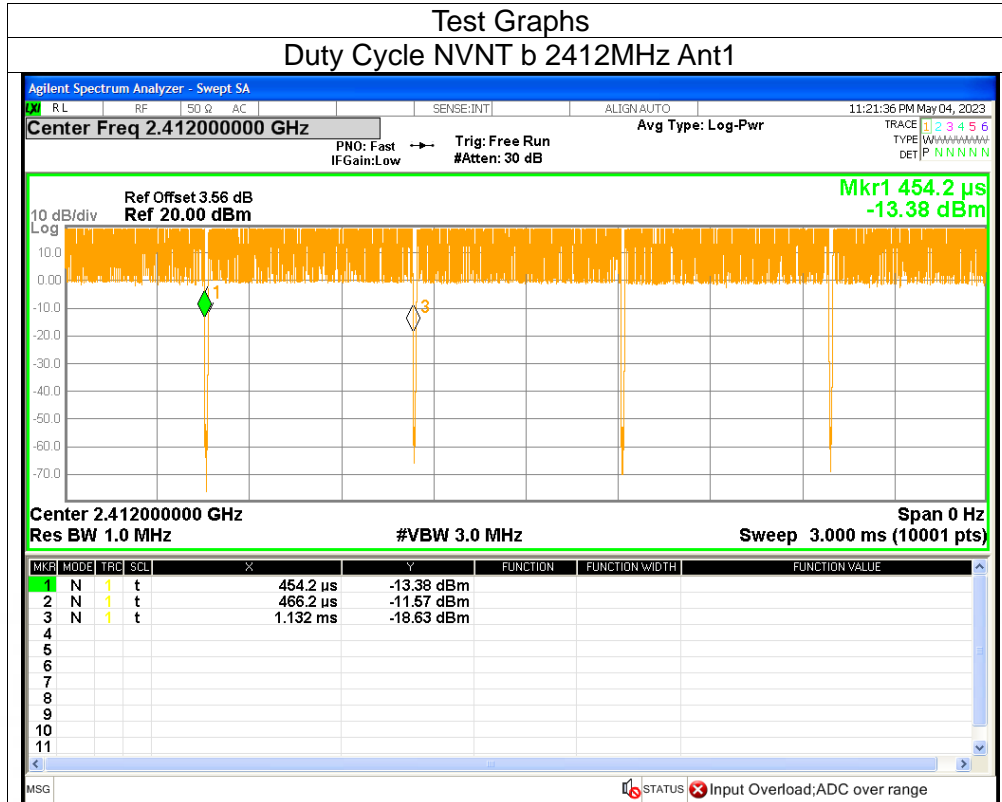



Duty Cycle NVNT b 2462MHz Ant1

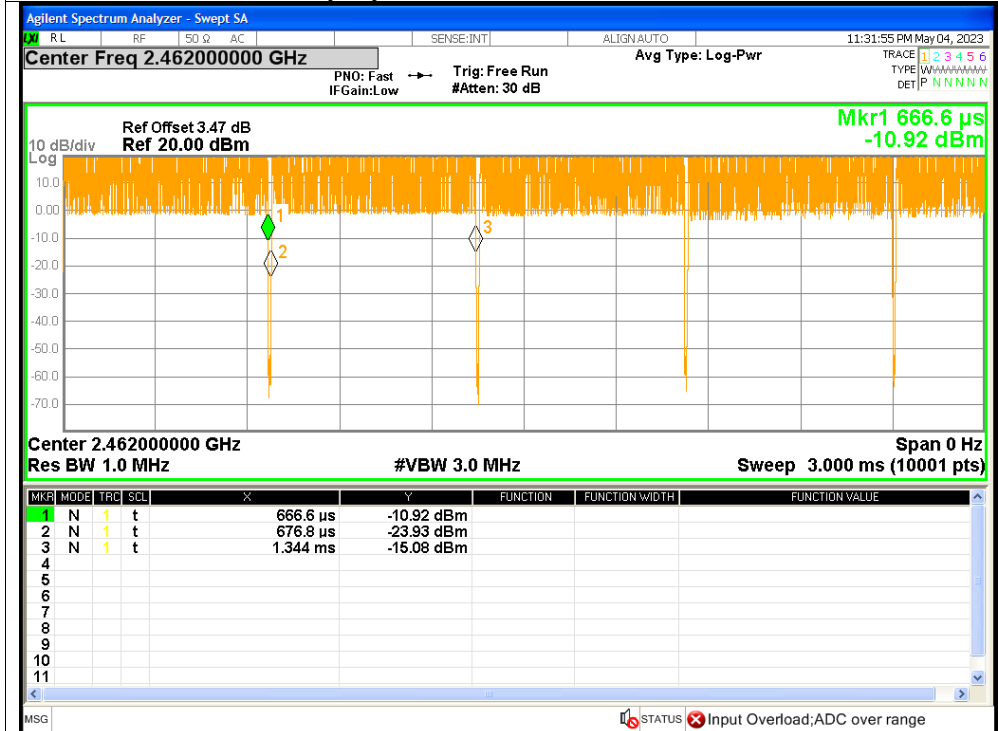

Duty Cycle NVNT b 2412MHz Ant2

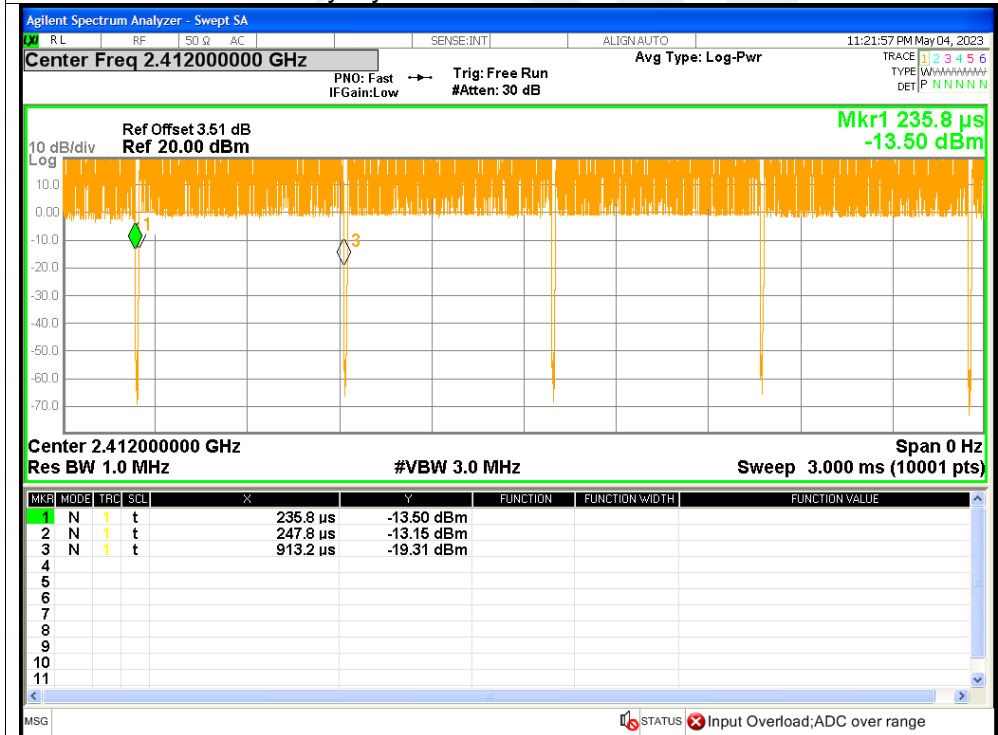

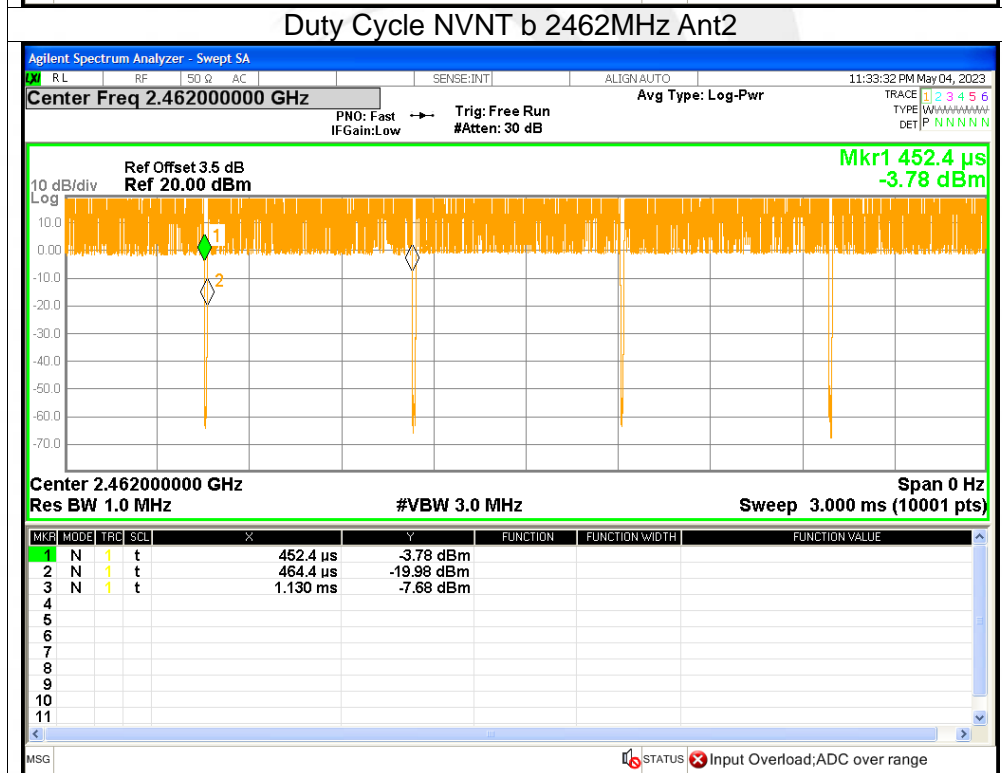
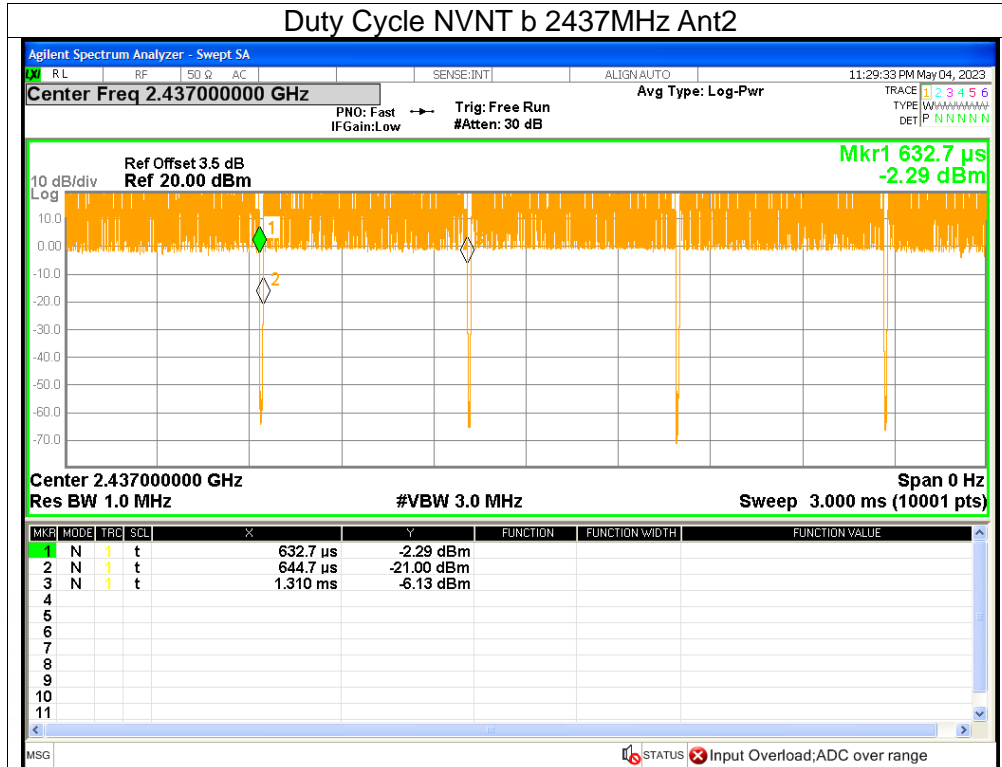

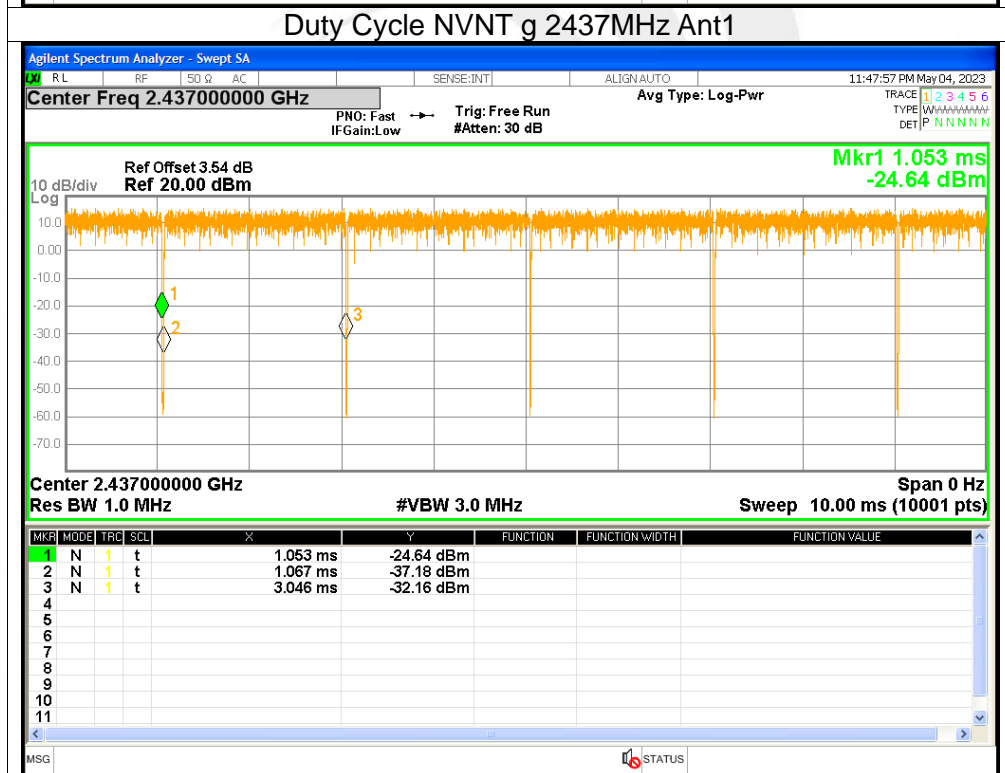
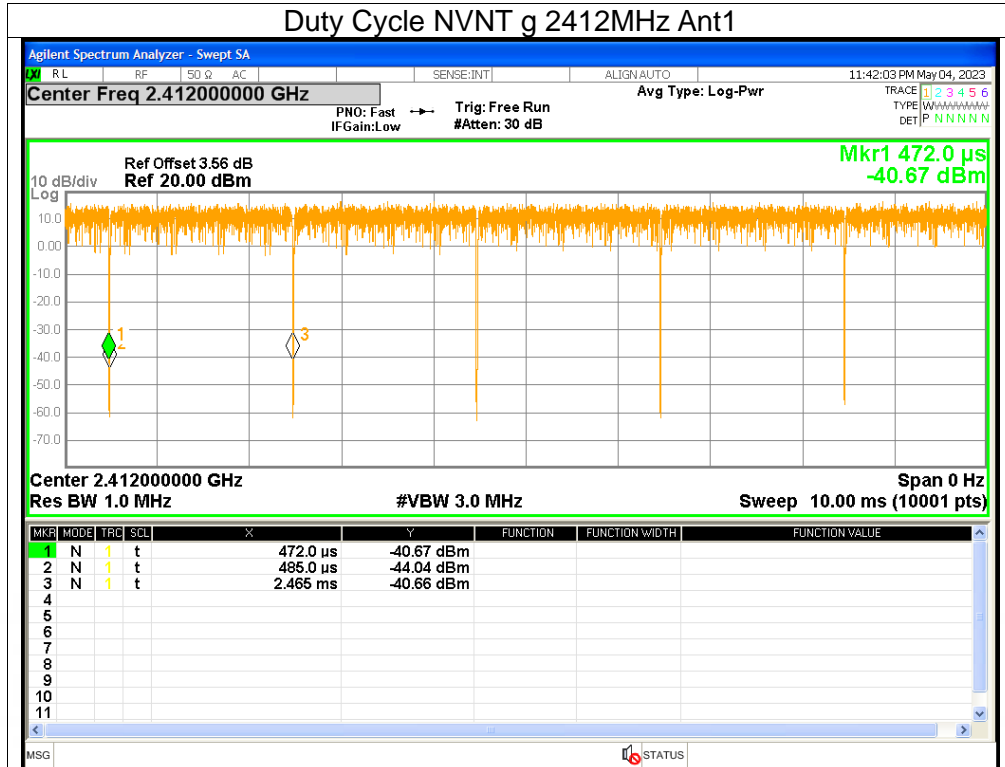



Duty Cycle NVNT g 2462MHz Ant1

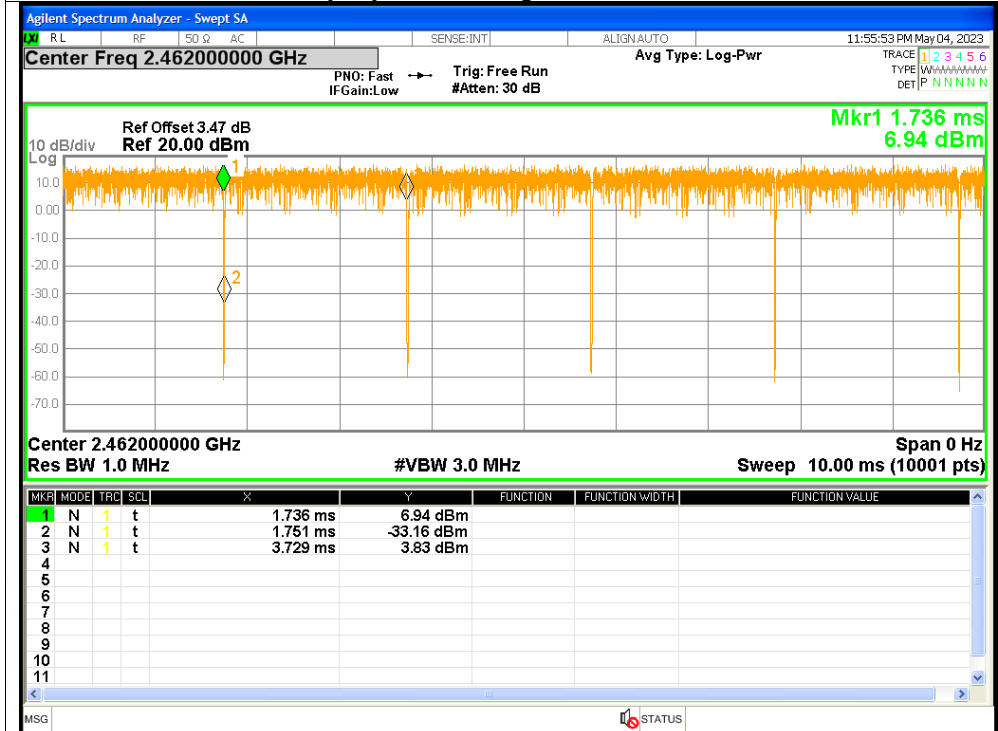

Duty Cycle NVNT g 2412MHz Ant2

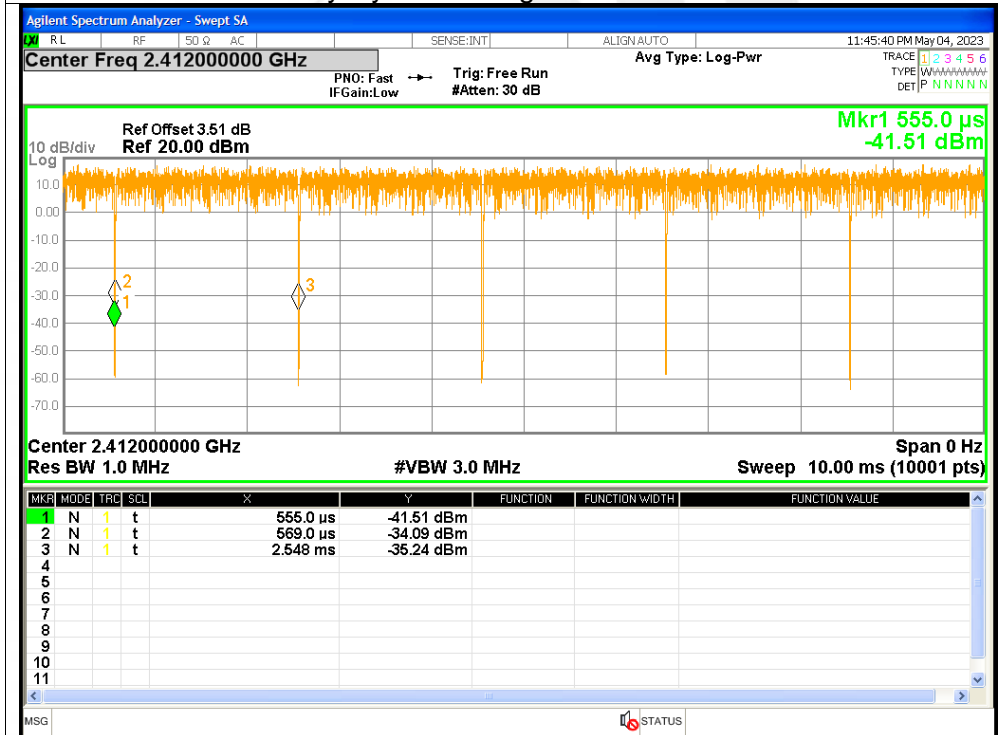



Duty Cycle NVNT g 2437MHz Ant2

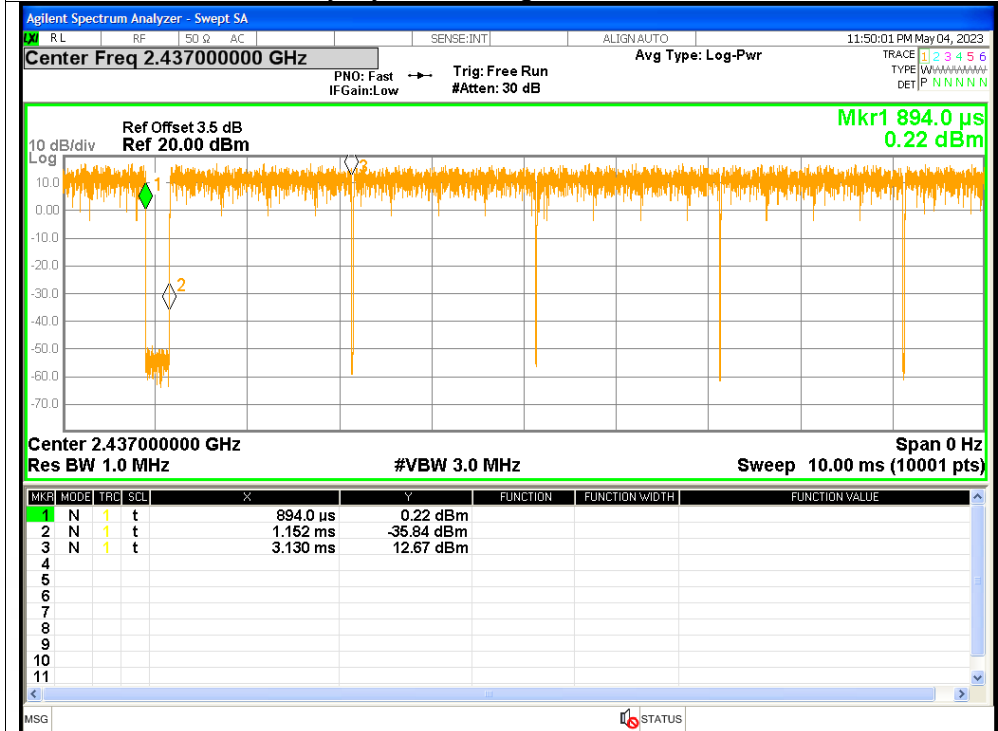

Duty Cycle NVNT g 2462MHz Ant2

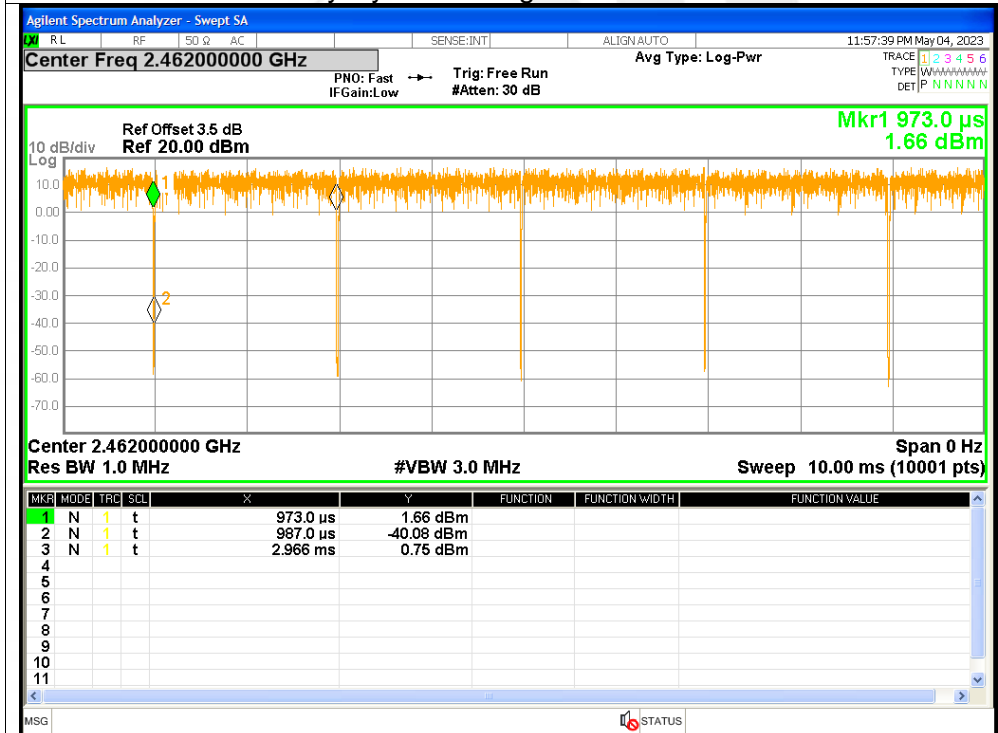

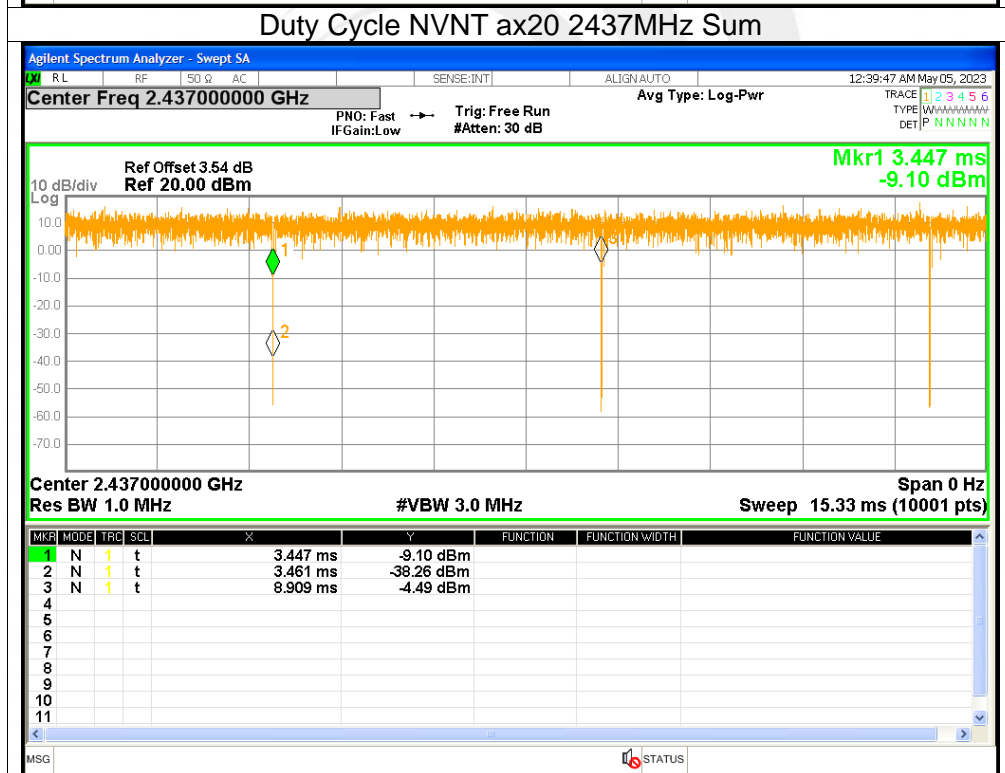
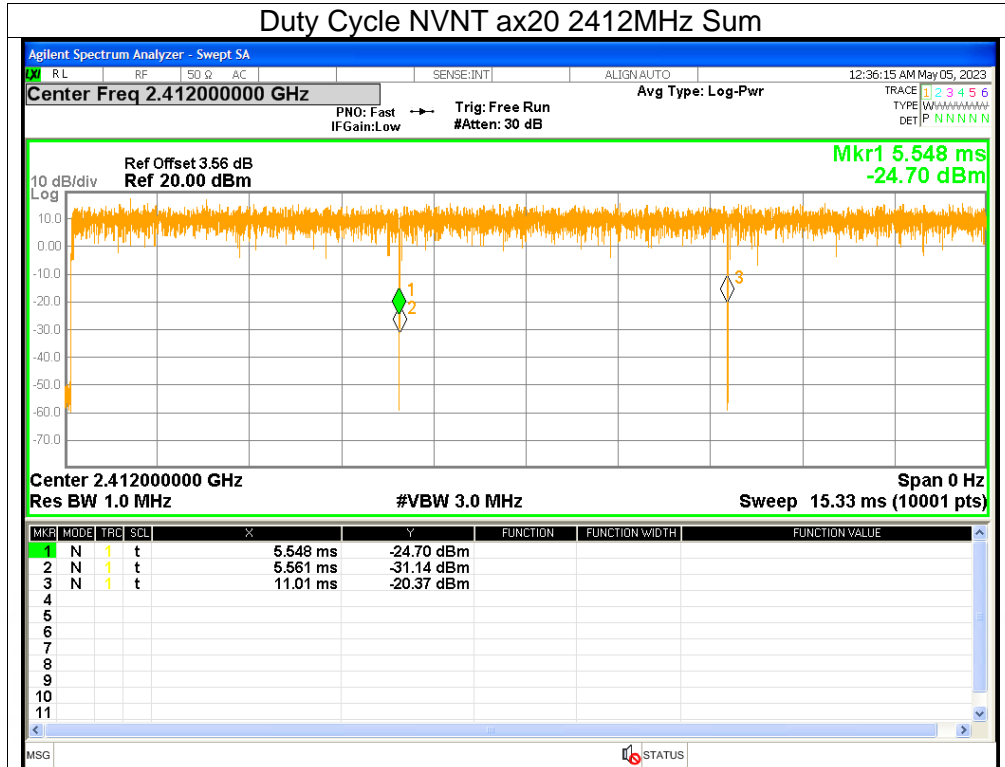



Duty Cycle NVNT ax20 2462MHz Sum

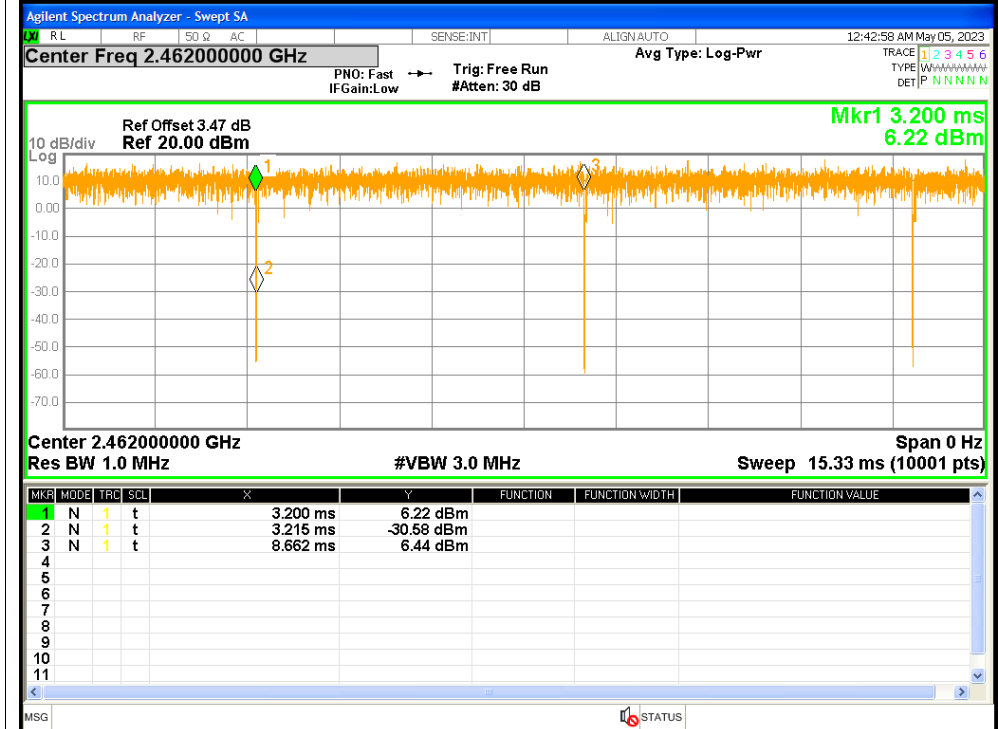

Duty Cycle NVNT ax40 2422MHz Sum

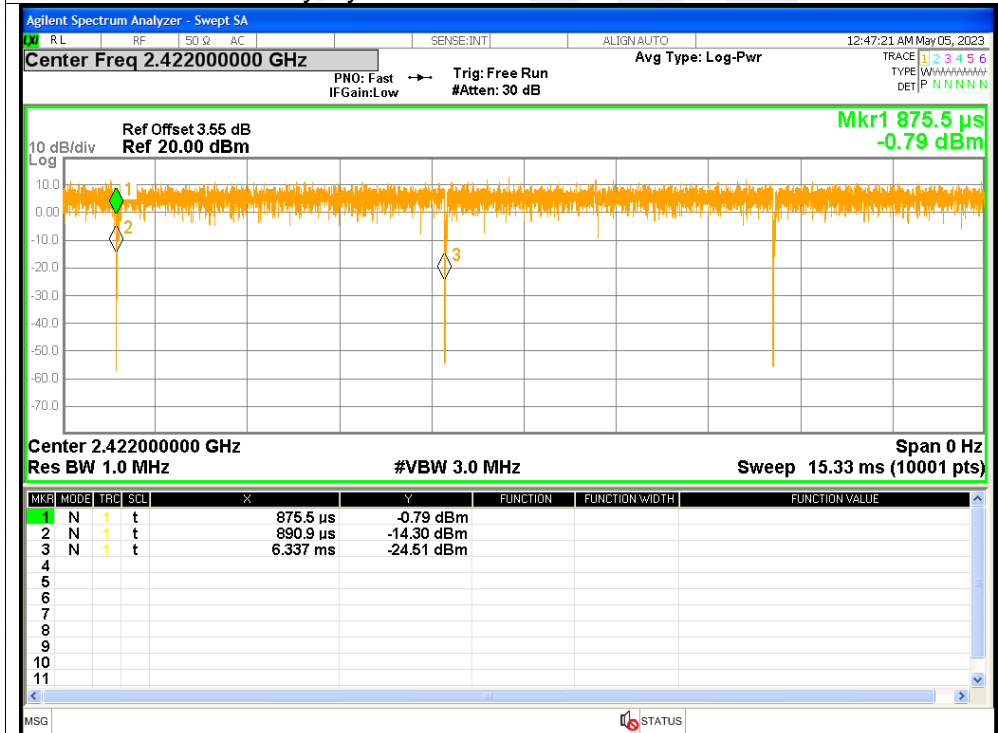



Duty Cycle NVNT ax40 2437MHz Sum

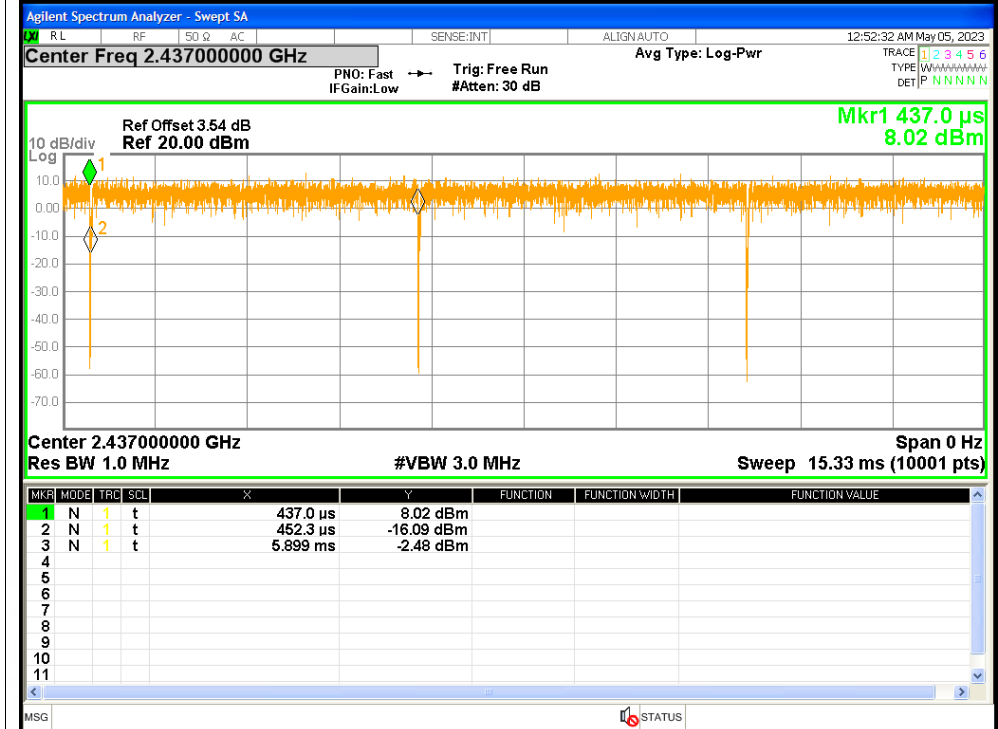

Duty Cycle NVNT ax40 2452MHz Sum

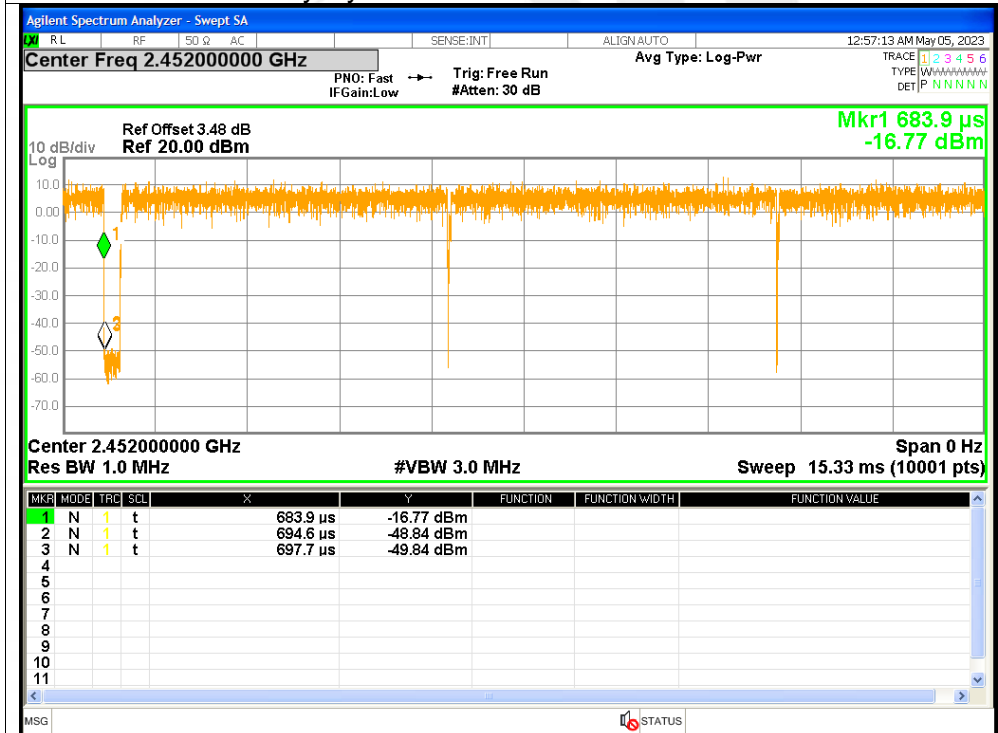



Duty Cycle NVNT n20 2412MHz Sum

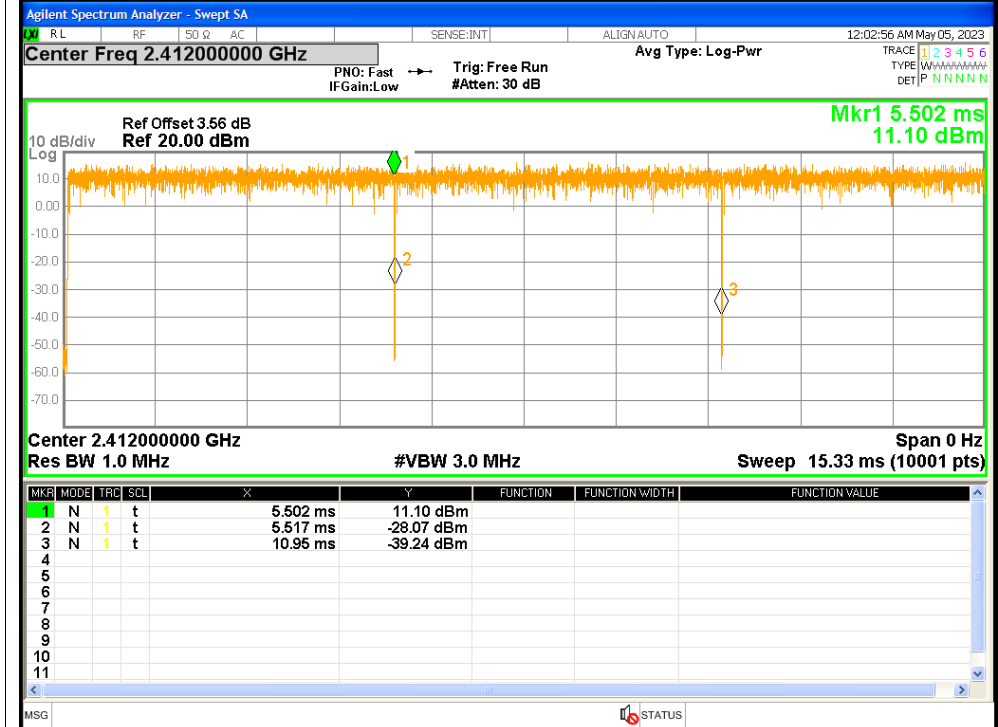

Duty Cycle NVNT n20 2437MHz Sum

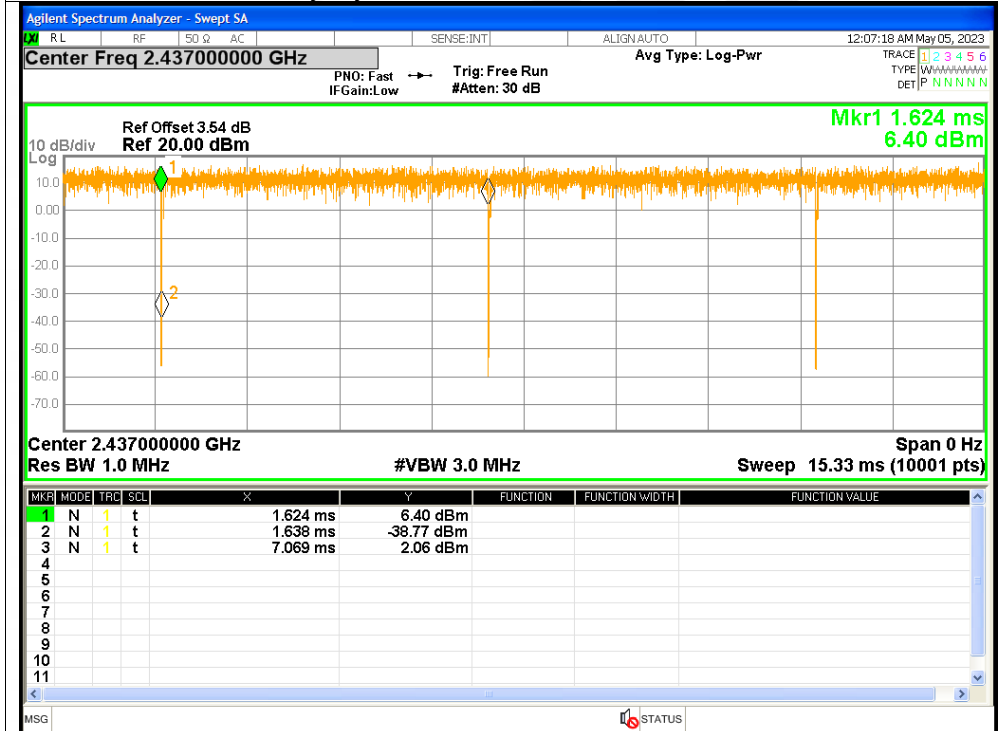



Duty Cycle NVNT n20 2462MHz Sum

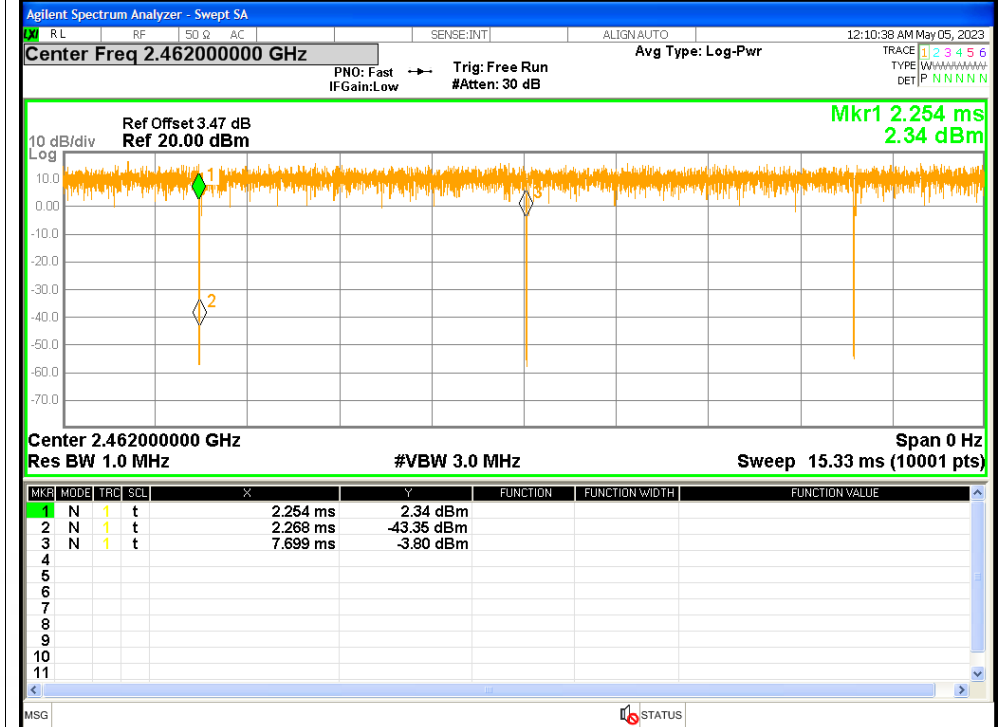

Duty Cycle NVNT n40 2422MHz Sum

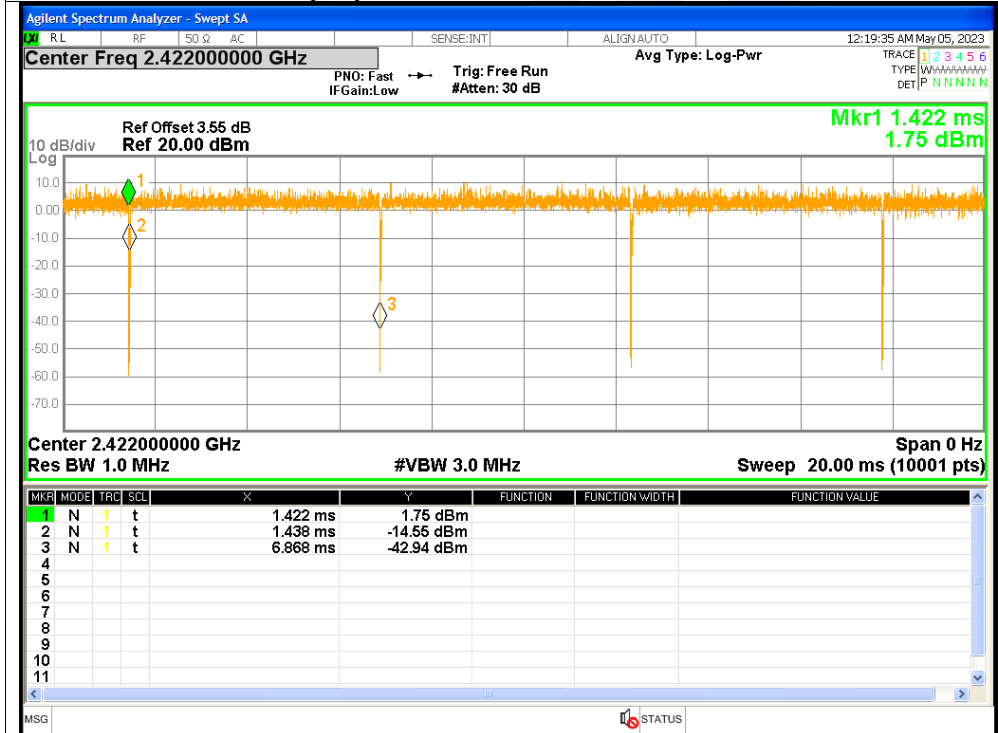



Duty Cycle NVNT n40 2437MHz Sum

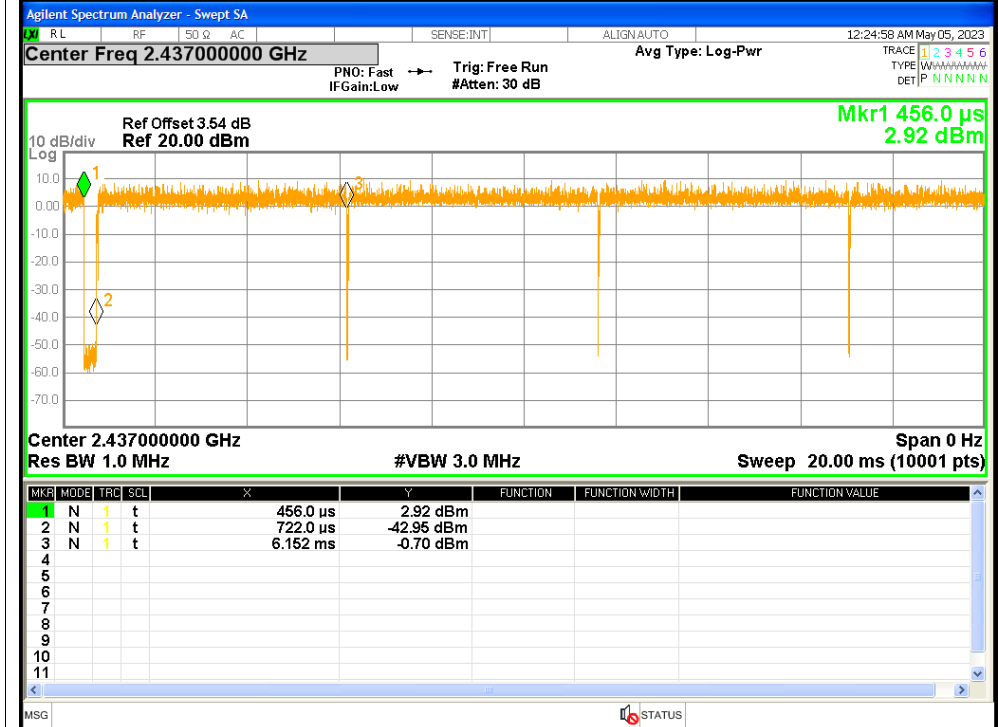

Duty Cycle NVNT n40 2452MHz Sum

