

Submittal Application Report

For Grant of Certification

Model: RBDynaDishG-5HacD-USr3
5180-5240, and 5745-5825 MHz
Unlicensed National Information Infrastructure (U-NII)
Indoor/Outdoor Operation Device
U-NII-1, U-NII-3 Operation (New Rules)
FCC ID: TV7DYNADISHGAC
IC: 7442A-DYNADISHGAC

FOR

Mikrotiks SIA

Pernavas 46 Str.
Riga LV-1009 Latvia

Test Report Number: 170217
FCC Site Registration: 90910, 315994
IC Test Site Registration: 3041A-1

Authorized Signatory: *Scot D Rogers*

Scot D. Rogers

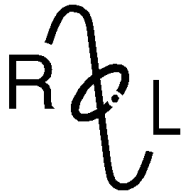

ROGERS LABS, INC.

4405 West 259th Terrace
Louisburg, KS 66053
Phone / Fax (913) 837-3214

Engineering Test Report for Grant of Certification Application

FOR

Unlicensed National Information Infrastructure (U-NII)

Indoor/Outdoor Operation Device

47CFR, Part 15E 15.407 (New Rules)

Industry Canada RSS-247 Issue 1

License Exempt Intentional Radiator

For

Mikrotikls SIA

Pernavas 46 Str.
Riga LV-1009 Latvia

Broadband Digital Transmission System
U-NII-1 and U-NII-3 operation

Model: RBDynaDishG-5HacD-USr3
Frequency Range 5180-5240 and 5745-5825 MHz
FCC ID#: TV7DYNADISHGAC
IC: 7442A-DYNADISHGAC

Test Date: February 17, 2017

Certifying Engineer: *Scot D. Rogers*

Scot D. Rogers
Rogers Labs, Inc.
4405 West 259th Terrace
Louisburg, KS 66053
Telephone/Facsimile: (913) 837-3214

This report shall not be reproduced except in full, without the written approval of the laboratory.
This report must not be used by the client to claim product certification, approval, or
endorsement by NVLAP, NIST, or any agency of the Federal Government.

Table of Contents

TABLE OF CONTENTS.....	3
REVISIONS.....	6
FORWARD	7
OPINION / INTERPRETATION OF RESULTS	7
EQUIPMENT TESTED.....	8
EQUIPMENT FUNCTION AND CONFIGURATION.....	8
Equipment Configuration.....	9
APPLICANT COMPANY INFORMATION	10
EQUIPMENT INFORMATION.....	10
Product Details	11
Accessories	12
Table for Filed Antennas	12
Antenna and Bandwidth.....	12
IEEE 11a/n Spec.....	12
Table for Carrier Frequencies	13
Table for Test Modes	13
Test Result of Occupied Bandwidth	14
APPLICATION FOR CERTIFICATION.....	16
APPLICABLE STANDARDS & TEST PROCEDURES	17
EQUIPMENT TESTING PROCEDURES	17
AC Line Conducted Emission Test Procedure	17
Radiated Emission Test Procedure.....	17
Diagram 1 Test arrangement for Conducted emissions	18

Diagram 2 Test arrangement for radiated emissions of tabletop equipment.....19
 Diagram 3 Test arrangement for radiated emissions tested on Open Area Test Site (OATS).....20

TEST SITE LOCATIONS 20

LIST OF TEST EQUIPMENT 21

UNITS OF MEASUREMENTS 22

ENVIRONMENTAL CONDITIONS..... 22

INTENTIONAL RADIATORS..... 22

Antenna Requirements22

Restricted Bands of Operation.....22

Table 1 Radiated Emissions in Restricted Bands Data23

Summary of Results for Radiated Emissions in Restricted Bands23

AC Line Conducted Emissions Procedure24

Figure 1 AC Line Conducted Emissions Line 125
 Figure 2 AC Line Conducted Emissions Line 225
 Table 2 AC Line Conducted Emissions Data (Highest Emissions Line L1)26
 Table 3 AC Line Conducted Emissions Data (Highest Emissions Line L2)26

Summary of Results for AC Line Conducted Emissions26

General Radiated Emissions Procedure.....27

Table 4 General Radiated Emissions from EUT Data (Highest Emissions)28

Summary of Results for General Radiated Emissions29

Operation in the 5150-5250 and 5725-5850 MHz Frequency U-NII-1 and U-NII-3 Bands30

Figure 3 Plot of Transmitter Emissions (Chain 0, Across 5150-5250 MHz Band, 802.11a).....32
 Figure 4 Plot of Transmitter Emissions (Chain 1, Across 5150-5250 MHz Band, 802.11a).....32
 Figure 5 Plot of Transmitter Emissions (Chain0, Across 5150-5250 MHz Band, 802.11n40)33
 Figure 6 Plot of Transmitter Emissions (Chain 1, Across 5150-5250 MHz Band, 802.11n40)33
 Figure 7 Plot of Transmitter Emissions (Chain 0, Across 5150-5250 MHz Band, 802.11ac80)34
 Figure 8 Plot of Transmitter Emissions (Chain 1, Across 5150-5250 MHz Band, 802.11ac80).....34
 Figure 9 Plot of Transmitter Low Band Edge (Chain 0, 5150-5250 MHz Band, 802.11a)35
 Figure 10 Plot of Transmitter Low Band Edge (Chain 1, 5150-5250 MHz Band, 802.11a)35

Figure 11 Plot of Transmitter Low Band Edge (Chain 0, 5150-5250 MHz Band, 802.11n40).....36
 Figure 12 Plot of Transmitter Low Band Edge (Chain 1, 5150-5250 MHz Band, 802.11n40).....36
 Figure 13 Plot of Transmitter Low Band Edge (Chain 0, 5150-5250 MHz Band, 802.11ac80).....37
 Figure 14 Plot of Transmitter Low Band Edge (Chain 1, 5150-5250 MHz Band, 802.11ac80).....37
 Figure 15 Plot of Transmitter High Band Edge (Chain 0, 5150-5250 MHz Band, 802.11a).....38
 Figure 16 Plot of Transmitter High Band Edge (Chain 1, 5150-5250 MHz Band, 802.11a).....38
 Figure 17 Plot of Transmitter High Band Edge (Chain 0, 5150-5250 MHz Band, 802.11n40).....39
 Figure 18 Plot of Transmitter High Band Edge (Chain 1, 5150-5250 MHz Band, 802.11n40).....39
 Figure 19 Plot of Transmitter High Band Edge (Chain 0, 5150-5250 MHz Band, 802.11ac80).....40
 Figure 20 Plot of Transmitter High Band Edge (Chain 1, 5150-5250 MHz Band, 802.11ac80).....40
 Figure 21 Plot of Transmitter Emissions (Chain 0, 5150-5250 MHz Band, 802.11a, 99% OBW).....41
 Figure 22 Plot of Transmitter Emissions (Chain 1, 5150-5250 MHz Band, 802.11a, 99% OBW).....41
 Figure 23 Plot of Transmitter Emissions (Chain 0, 5150-5250 MHz Band, 802.11ac, 99% OBW).....42
 Figure 24 Plot of Transmitter Emissions (Chain 1, 5150-5250 MHz Band, 802.11ac, 99% OBW).....42
 Figure 25 Plot of Transmitter Emissions (Chain 0, 5150-5250 MHz Band, 802.11a, 26 dB OBW).....43
 Figure 26 Plot of Transmitter Emissions (Chain 1, 5150-5250 MHz Band, 802.11a, 26 dB OBW).....43
 Figure 27 Plot of Transmitter Emissions (Chain 0, 5150-5250 MHz Band, 802.11n40, 99% OBW).....44
 Figure 28 Plot of Transmitter Emissions (Chain 1, 5150-5250 MHz Band, 802.11n40, 99% OBW).....44
 Figure 29 Plot of Transmitter Emissions (Chain 0, 5150-5250 MHz Band, 802.11n40, 26 dB OBW).....45
 Figure 30 Plot of Transmitter Emissions (Chain 1, 5150-5250 MHz Band, 802.11n40, 26 dB OBW).....45
 Figure 31 Plot of Transmitter Emissions (Chain 0, 5150-5250 MHz Band, 802.11ac, 26 dB OBW).....46
 Figure 32 Plot of Transmitter Emissions (Chain 1, 5150-5250 MHz Band, 802.11ac, 26 dB OBW).....46
 Figure 33 Plot of Transmitter Emissions (Chain 0, Across 5725-5850 MHz Band, 802.11a).....47
 Figure 34 Plot of Transmitter Emissions (Chain 1, Across 5725-5850 MHz Band, 802.11a).....47
 Figure 35 Plot of Transmitter Emissions (Chain 0, Across 5725-5850 MHz Band, 802.11n40).....48
 Figure 36 Plot of Transmitter Emissions (Chain 1, Across 5725-5850 MHz Band, 802.11n40).....48
 Figure 37 Plot of Transmitter Emissions (Chain 0, Across 5725-5850 MHz Band, 802.11ac80).....49
 Figure 38 Plot of Transmitter Emissions (Chain 1, Across 5725-5850 MHz Band, 802.11ac80).....49
 Figure 39 Plot of Transmitter Low Band Edge (Chain 0, 5725-5850 MHz Band, 802.11a).....50
 Figure 40 Plot of Transmitter Low Band Edge (Chain 1, 5725-5850 MHz Band, 802.11a).....50
 Figure 41 Plot of Transmitter Low Band Edge (Chain 0, 5725-5850 MHz Band, 802.11n40).....51
 Figure 42 Plot of Transmitter Low Band Edge (Chain 1, 5725-5850 MHz Band, 802.11n40).....51
 Figure 43 Plot of Transmitter Low Band Edge (Chain 0, 5725-5850 MHz Band, 802.11ac80).....52
 Figure 44 Plot of Transmitter Low Band Edge (Chain 1, 5725-5850 MHz Band, 802.11ac80).....52
 Figure 45 Plot of Transmitter High Band Edge (Chain 0, 5725-5850 MHz Band, 802.11a).....53
 Figure 46 Plot of Transmitter High Band Edge (Chain 1, 5725-5850 MHz Band, 802.11a).....53
 Figure 47 Plot of Transmitter High Band Edge (Chain 0, 5725-5850 MHz Band, 802.11n40).....54
 Figure 48 Plot of Transmitter High Band Edge (Chain 1, 5725-5850 MHz Band, 802.11n40).....54
 Figure 49 Plot of Transmitter High Band Edge (Chain 0, 5725-5850 MHz Band, 802.11ac80).....55
 Figure 50 Plot of Transmitter High Band Edge (Chain 1, 5725-5850 MHz Band, 802.11ac80).....55
 Figure 51 Plot of Transmitter Emissions (Chain 0, 5725-5850 MHz Band, 802.11a, 99% OBW).....56

Figure 52 Plot of Transmitter Emissions (Chain 1, 5725-5850 MHz Band, 802.11a, 99% OBW)	56
Figure 53 Plot of Transmitter Emissions (Chain 0, 5725-5850 MHz Band, 802.11a, 6-dB OBW)	57
Figure 54 Plot of Transmitter Emissions (Chain 1, 5725-5850 MHz Band, 802.11a, 6-dB OBW)	57
Figure 55 Plot of Transmitter Emissions (Chain 0, 5725-5850 MHz Band, 802.11n40, 99% OBW)	58
Figure 56 Plot of Transmitter Emissions (Chain 1, 5725-5850 MHz Band, 802.11n40, 99% OBW)	58
Figure 57 Plot of Transmitter Emissions (Chain 0, 5725-5850 MHz Band, 802.11n40, 6-dB OBW)	59
Figure 58 Plot of Transmitter Emissions (Chain 1, 5725-5850 MHz Band, 802.11n40, 6-dB OBW)	59
Figure 59 Plot of Transmitter Emissions (Chain 0, 5725-5850 MHz Band, 802.11ac80, 99% OBW)	60
Figure 60 Plot of Transmitter Emissions (Chain 1, 5725-5850 MHz Band, 802.11ac80, 99% OBW)	60
Figure 61 Plot of Transmitter Emissions (Chain 0, 5725-5850 MHz Band, 802.11ac80, 6-dB OBW).....	61
Figure 62 Plot of Transmitter Emissions (Chain 1, 5725-5850 MHz Band, 802.11ac80, 6-dB OBW).....	61
Transmitter Emissions Data.....	62
Table 5 Transmitter Radiated Emission (5150-5250 MHz Band)	62
Table 6 Transmitter Radiated Emission (5725-5850 MHz Band)	63
Table 7 Transmitter Antenna Port Conducted Power and Emissions Chain 0.....	64
Table 8 Transmitter Antenna Port Conducted Power and Emissions Chain 1.....	65
Table 9 Transmitter all antenna Ports Total Power and PSD U-NII-1 Band	66
Table 10 Transmitter all antenna Ports Total Power and PSD U-NII-3 Band	66
Summary of Results for Transmitter Radiated Emissions of Intentional Radiator.....	67
STATEMENT OF MODIFICATIONS AND DEVIATIONS	67
ANNEX.....	68
Annex A Measurement Uncertainty Calculations.....	69
Annex B Rogers Labs Test Equipment List.....	70
Annex C Rogers Qualifications	71
Annex D FCC Site Registration Letter.....	72
Annex E Industry Canada Site Registration Letter	73

Revisions

Revision 2 Issued March 28, 2017 – corrected antenna gain referenced on page 30

Revision 1 Issued March 25, 2017

Forward

The following information is submitted for consideration in obtaining Class 2 Permissible Change Grant of Certification for License Exempt, Unlicensed National Information Infrastructure (U-NII) Intentional Radiator operating under 47CFR Paragraph 15E (15.407), U-NII-1 and U-NII-3 new rules, 5180-5240, and 5745-5825 MHz bands, and Industry Canada RSS-GEN Issue 4, and RSS-247 Issue 1, LE-LAN transmitter operation in 5745-5825 MHz.

Name of Applicant: Mikrotikls SIA FRN: 0014431100
 Pernavas 46 Str.
 Riga LV-1009 Latvia

Model: RBDynaDishG-5HacD-USr3

FCC ID: TV7DYNADISHGAC, **IC:** 7442A-DYNADISHGAC

Frequency Range: 5180-5240 MHz and 5745-5825 MHz (U-NII-1 and U-NII-3 under new rules 15.407, 802.11a/n 20 MHz, 40 MHz and 80 MHz channels) and restrictions for operation in Canada

Maximum Power: U-NII-1 Band, 20 MHz mode, 0.045-watt, 99% OBW 17,400 kHz
 U-NII-1 Band, 40 MHz mode, 0.038-watt, 99% OBW 37,350 kHz
 U-NII-1 Band, 80 MHz mode, 0.029-watt, 99% OBW 77,875 kHz
 U-NII-3 Band, 20 MHz mode, 0.242-watt, 99% OBW 17,360 kHz
 U-NII-3 Band, 40 MHz mode, 0.145-watt, 99% OBW 37,350 kHz
 U-NII-3 Band, 80 MHz mode, 0.119-watt, 99% OBW 77,525 kHz

Opinion / Interpretation of Results

Tests Performed	Margin (dB)	Results
Restricted Frequency Bands 15.205, RSS-GEN 8.10	-16.2	Complies
AC Line Conducted 15.207, RSS-GEN 7.2.4	-9.2	Complies
Radiated Emissions 15.209, RSS-GEN 7.2.5	-5.3	Complies
Harmonic Emissions per 15.407, RSS-247	-27.1	Complies
Power Spectral Density per 15.407, RS-247	-0.4	Complies

Equipment Tested

<u>Equipment</u>	<u>Model</u>	<u>FCC I.D.</u>
EUT	RBDynaDishG-5HacD-USr3	TV7DYNADISHGAC
AC Adapter	FLD181-2400750-U	N/A
Power Adapter	POE	N/A
Dell Studio XPS	921LBN1	N/A

Test results in this report relate only to the items tested.

Equipment Function and Configuration

The EUT is a 5 GHz (two chain) Digital Transmission System providing Multiple Inputs and Multiple Outputs (MIMO). The design provides 2x2 MIMO operational capabilities in the U-NII-1 and U-NII-3 services (5180-5240 and 5745-5825 MHz) and Industry Canada operation as LE-LAN, Indoor only for 5180-5240 MHz band, Indoor/Outdoor access point operation in the 5725-5850 MHz band. The EUT offers broadband wireless connectivity to transmit and receive data. The design is fully self-contained with integral antenna system operating as cross polarized Printed Circuit Board panel antenna. The EUT provides single Ethernet port for connection with network cable and Power Over Ethernet (POE) and associated AC/DC adapter. The design requires power provided through the use of the included POE (Power Over Ethernet) adapter. For testing purposes, the EUT transceiver was connected to the manufacturer supplied POE and AC/DC power supply and communicating to the laptop computer through the Ethernet network interface. This configuration provided operational control of the EUT and communications over the network interface between the EUT and supporting computer system. The design provides no other interfacing options than those presented in this report. For testing purposes, the RBDynaDishG-5HacD-USr3test sample was configured to transmit in available data modes receiving power from the manufacturer provided POE and AC/DC power adapter. Two test samples were provided for evaluation and testing purposes, one as production design and the other with the antenna replaced with coaxial cable and RF connectors. As requested by the manufacturer and required by regulations, the equipment was tested for emissions compliance using the available configurations with the worst-case data presented. Test results in this report relate only to the products described in this report.

Equipment Configuration

Configuration 1 (Integral Antenna System as Production Design)

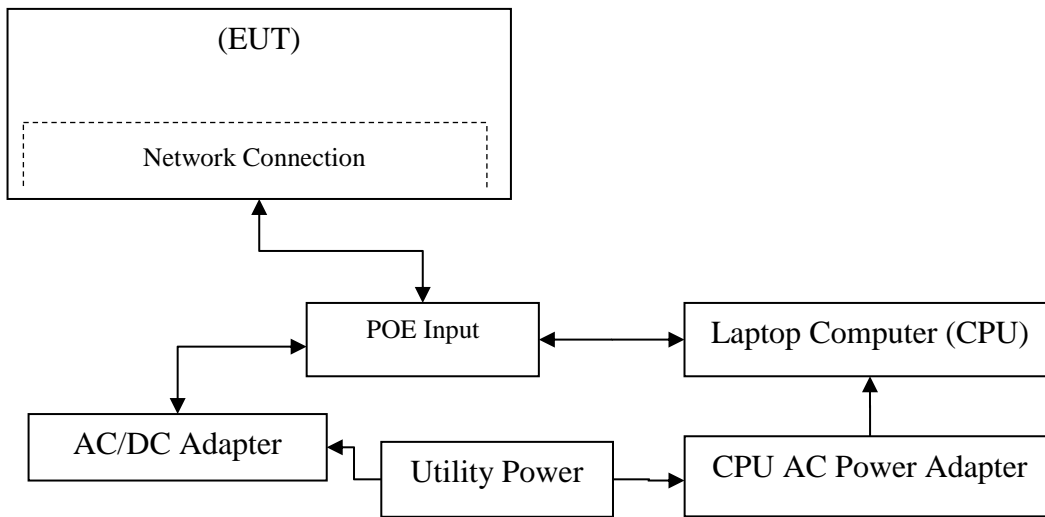

Configuration 2 (Antenna System replaced with Antenna Port connectors)

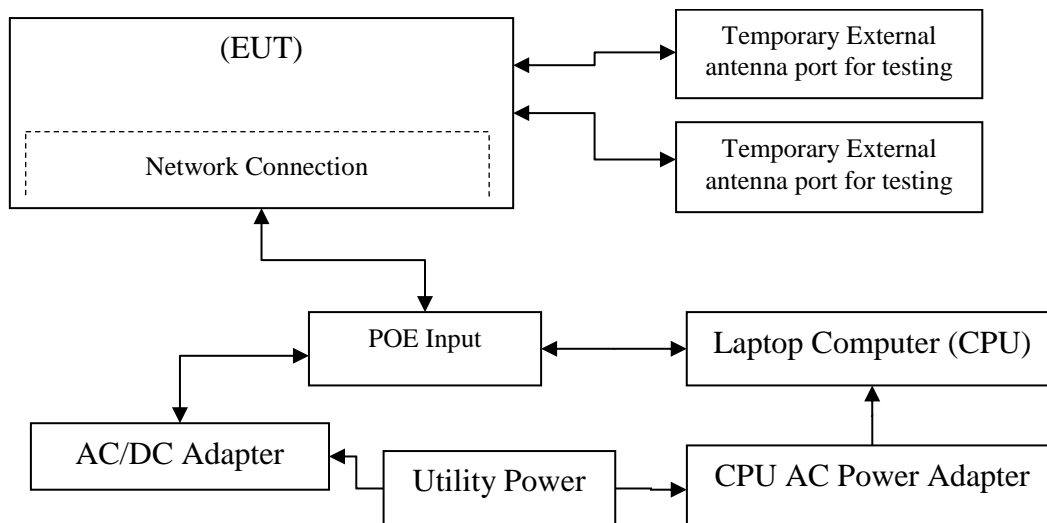

Applicant Company information

Applicants Company	MikroTik (“Mikrotīkls, SIA”)
Applicants Address	Pernavas 46 Str., Riga LV-1009 Latvia
FCC Identifier	TV7DYNADISHGAC
Industry Canada Identifier	7442A-DYNADISHGAC
Manufacturer Company	MikroTik (“Mikrotīkls, SIA”)
Manufacturer Address	Pernavas 46 Str., Riga LV-1009 Latvia

Equipment information

Product Marketing Name (PMN): The PMN is the name or model number under which the product will be marketed/offered for sale in Canada. If the product has PMN, it must be provided.	RBDynaDishG-5HacD-USr3
Unique Product Number (UPN): The applicant, made up of a maximum of 11 alphanumeric characters (A-Z, 0-9), assigns the UPN.	DYNADISHGAC
Hardware Version Identification Number (HVIN): The HVIN identifies hardware specifications of a product version. The HVIN replaces the ISED Model Number in the legacy E-filing System. An HVIN is required for all products for certification applications.	RBDynaDishG-5HacD-USr3
Host Marketing Name (HMN) (if applicable): The HMN is the name or model number of a final product, which contains a certified radio module.	
Brand Name	
Model Number	RBDynaDishG-5HacD-USr3
Test Rule Part(s)	47CFR 15E, 15.407, RSS-247
Test Frequency Range	5.15-5.25 and 5.725-5.85 GHz
Project Number	170217
Submission Type	Certification

Product Details

Items	Description
Product Type	5 GHz U-NII-1 and U-NII-3 [2x2 MIMO]
Radio Type	Transceiver
Power Type	POE adapter with External Power Supply
Modulation	IEEE 802.11a: OFDM IEEE 802.11a/n: see the below table
Data Modulation	IEEE 802.11 a/n: OFDM (BPSK/QPSK/16QAM/64QAM) IEEE 802.11ac: OFDM (BPSK/QPSK/16QAM/64QAM/256QAM) IEEE 802.11 g/n: N/A IEEE 802.11 b: N/A
Data Rate (Mbps)	IEEE 802.11a: OFDM (36/48/54) IEEE 802.11n/ac: see the below table IEEE 802.11b/g/n: N/A
Frequency Range	5150-5250 MHz / 5725-5850 MHz
Channel Number	802.11b: N/A 802.11g/n: N/A 802.11a/n: 9 for 20MHz bandwidth; 4 for 40MHz bandwidth 802.11 a/c: 1 for 80 MHz bandwidth
Maximum Conducted Output Power	802.11 b: 802.11 g: 802.11 n (HT-20): 802.11 n (HT-40): Band 1: IEEE 802.11a: 0.020 Watts IEEE 802.11a/n MCS0/Nss1 (VHT20): 0.045 Watts IEEE 802.11a/n MCS0/Nss1 (VHT40): 0.038 Watts IEEE 802.11ac MCS0/Nss1 (VHT80): 0.029 Watts Band 3: IEEE 802.11a: 0.037 Watts IEEE 802.11a/n MCS0/Nss1 (VHT20): 0.242 Watts IEEE 802.11a/n MCS0/Nss1 (VHT40): 0.145 Watts IEEE 802.11ac MCS0/Nss1 (VHT80): 0.119 Watts
Carrier Frequencies	Please refer to Table for Carrier Frequencies
Antenna	Integral antenna with NO other available antenna options
Communication Mode	Device operates as a 2x2 input output 5 GHz U-NII 1 and U-NII-3. The design utilizes Multiple-Input-Multiple-Output (MIMO) operational capability. The design may be configured to transmit on all chains or chosen single chain (without automatic switching between chains). The unit may receive on single or all chains and may transmit on single or all chains.
Beamforming Function	With beamforming
Operating Mode	5150-5250 MHz (U-NII-1 band) and 5725-5825 MHz (U-NII-3) and frequency band of 5725-5850 MHz for use in Canada

Accessories

AC Power Adapter	FLD181-240075-U
Power Over Ethernet (POE) adapter	POE

Table for Filed Antennas

Ant.	Brand	Model Name	P/N	Antenna Type	Connector	Gain (dBi)	
						2.4GHZ	5GHZ
1	Mikrotikls	Not Available	N/A	Integral PCB	Solder		16
2							
3							

Antenna and Bandwidth

Antenna	TX chains		
Bandwidth Mode	20 MHz	40 MHz	80 MHz
IEEE 802.11a	1 from above list		
IEEE 802.11n		1 from above list	
IEEE 802.11ac			1 from above list

IEEE 11a/n Spec.

Protocol	Number of Transmit Chains (NTX)	Data Rate/MCS
802.11a/n (VHT20)	2	MCS 0-9/Nss1-3
802.11a/n (VHT40)	2	MCS 0-9/Nss1-3
802.11ac (VHT80)	2	MCS 0-9/Nss1-3
<p>Note 1: IEEE Std. 802.11n modulation consists of HT20 and HT40 (HT: High Throughput). The EUT supports HT20 and HT40.</p> <p>Note 2: IEEE Std. 802.11ac modulation consists of VHT20, VHT40, VHT80, and VHT160 (VHT: Very High Throughput). The EUT does not support 802.11ac VHT160.</p> <p>Note 3: Modulation modes consist of below configuration: IEEE 802.11a/n; HT20/HT40; IEEE 802.11ac: VHT80</p>		

Table for Carrier Frequencies

For 20MHz bandwidth systems, use Channel 36, 40, 44, 48, 149, 153, 157, 161, 165.

For 40MHz bandwidth systems, use Channel 38, 46, 151, 159.

Frequency Band	Channel No.	Frequency	Channel No.	Frequency
5150-5250MHz U-NII-1	36	5180MHz	44	5220MHz
	38	5190MHz	46	5230MHz
	40	5200MHz	48	5240MHz
	42	5210MHz	-	-
5725-5850MHz U-NII-3	149	5745MHz	157	5785MHz
	151	5755MHz	159	5795MHz
	153	5765MHz	161	5805MHz
	155	5775MHz	165	5825MHz

Table for Test Modes

Preliminary tests were performed in different data rates to define the worst radiated emission.

The data rate shown in the table below is the worst-case rate with respect to the specific test item.

Investigation has been done on all possible configurations while searching the worst cases.

The following table is a list of the test modes investigated for this report.

Test Items	Mode		Data Rate	Channel	Chain
Max. Conducted Output Power	11 a BPSK	Band 1&3	6Mbps	36/40/48/149/157/165	1,2
	11a/n HT20	Band 1&3	MCS0/Nss1	36/40/48/149/157/165	1,2
	11a/n HT40	Band 1&3	MCS0/Nss1	38/46/151/159	1,2
	11ac VHT80	Band 1&3	MCS0/Nss1	42,155	1,2
Power Spectral Density	11 a BPSK	Band 1&3	6Mbps	36//40/48/149/157/165	1,2
	11a/n HT20	Band 1&3	MCS0/Nss1	36/40/48/149/157/165	1,2
	11a/n HT40	Band 1&3	MCS0/Nss1	38/46/151/159	1,2
	11ac VHT80	Band 1&3	MCS0/Nss1	42,155	1,2
26dB, 99% Occupied Bandwidth Measurement	11 a BPSK	Band 1&3	6Mbps	36/40/48/149/157/165	1,2
	11a/n HT20	Band 1&3	MCS0/Nss1	36/40/48/149/157/165	1,2
	11a/n HT40	Band 1&3	MCS0/Nss1	38/46/151/159	1,2
	11ac VHT80	Band 1&3	MCS0/Nss1	42,155	1,2

6dB Spectrum Bandwidth Measurement	802.11a BPSK	Band 3	6Mbps	149/157/165	1,2
	802.11a/n HT20	Band 3	MCS0/Nss1	149/157/165	1,2
	802.11a/n HT40	Band 3	MCS0/Nss1	151/159	1,2
	802.11ac VHT80	Band 3	MCS0/Nss1	42,155	1,2
Radiated Emission Below 1GHz			-	-	
Radiated Emission Above 1GHz	11a BPSK	Band 1&3	6Mbps	36/40/48/149/157/165	1,2
	802.11a/n HT20	Band 1&3	MCS0/Nss1	36/40/48/149/157/165	1,2
	802.11a/n HT40	Band 1&3	MCS0/Nss1	38/46/151/159	1,2
	802.11ac VHT80	Band 1&3	MCS0/Nss1	42/155	1,2
Band Edge Emission	11a BPSK	Band 1&3	6Mbps	36/40/48/149/157/165	1,2
	802.11a/n HT20	Band 1&3	MCS0/Nss1	36/40/48/149/157/165	1,2
	802.11a/n HT40	Band 1&3	MCS0/Nss1	38/46/151/159	1,2
	802.11ac VHT80	Band 1&3	MCS0/Nss1	42/155	1,2
Frequency Stability	20MHz	Band 1&3	-	40/157	1,2
	40MHz	Band 1&3	-	38/151	1,2
	80MHz	Band 1&3	-	42/155	1,2

Test Result of Occupied Bandwidth

Mode	Frequency	26 dB Bandwidth (kHz)	6 dB Bandwidth (kHz)	99% Occupied Bandwidth (kHz)
802.11b	2412 MHz	N/A		
	2437 MHz	N/A		
	2462 MHz	N/A		
802.11g	2412 MHz	N/A		
	2437 MHz	N/A		
	2462 MHz	N/A		
802.11n (HT20)	2412 MHz	N/A		
	2437 MHz	N/A		
	2462 MHz	N/A		

802.11n (HT40)	2422 MHz	N/A		
	2447 MHz	N/A		
	2452 MHz	N/A		
802.11a	5180 MHz	20440 kHz	N/A	17320 kHz
	5200 MHz	21120 kHz	N/A	17400 kHz
	5240 MHz	21320 kHz	N/A	17400 kHz
	5745 MHz	N/A	16400 kHz	17520 kHz
	5785 MHz	N/A	16360 kHz	17360 kHz
	5825 MHz	N/A	16400 kHz	17360 kHz
802.11n (ht20)	5180 MHz	20440 kHz	N/A	17320 kHz
	5200 MHz	21120 kHz	N/A	17400 kHz
	5240 MHz	21320 kHz	N/A	17400 kHz
	5745 MHz	N/A	16400 kHz	17520 kHz
	5785 MHz	N/A	16360 kHz	17360 kHz
	5825 MHz	N/A	16400 kHz	17360 kHz
802.11a/n MCS0/Nss1 HT40	5190 MHz	44325 kHz	N/A	37275 kHz
	5230 MHz	43725 kHz	N/A	37350 kHz
	5755 MHz	N/A	36225 kHz	37200 kHz
	5795 MHz	N/A	36300 kHz	37350 kHz
802.11ac VHT80	5210 MHz	86975 kHz	N/A	77875 kHz
802.11ac VHT80	5775 MHz	N/A	75600 kHz	77525 kHz

Application for Certification

- (1) Manufacturer: Mikrotiks SIA
Pernavas 46 Str.
Riga LV-1009 Latvia
- (2) Identification: Model: RBDynaDishG-5HacD-USr3
FCC I.D.: TV7DYNADISHGAC IC: 7442A-DYNADISHGAC
- (3) Instruction Book:
Refer to Exhibit for Instruction Manual.
- (4) Description of Circuit Functions:
Refer to Exhibit of Operational Description.
- (5) Block Diagram with Frequencies:
Refer to Exhibit of Operational Description.
- (6) Report of Measurements:
Report of measurements follows in this Report.
- (7) Photographs: Construction, Component Placement, etc.:
Refer to Exhibit for photographs of equipment.
- (8) List of Peripheral Equipment Necessary for operation. The equipment operates from power received from authorized AC/DC power adapter and POE. The EUT provides single Ethernet port for communications and power. During testing, the EUT was powered from the POE and AC/DC power supply and connected to CPU through network cable.
- (9) Transition Provisions of 47CFR 15.37 are not requested
- (10) Not Applicable. The unit is not a scanning receiver.
- (11) Not Applicable. The EUT does not operate in the 59 – 64 GHz frequency band.
- (12) The equipment is not software defined and this section is not applicable.
- (13) Applications for certification of U-NII devices in the 5.15-5.35 GHz and the 5.47-5.85 GHz bands must include a high-level operational description of the security procedures that control the radio frequency operating parameters and ensure that unauthorized modifications cannot be made. The required information has been provided in Operational Description Exhibit filed with the application.
- (14) Contain at least one drawing or photograph showing the test set-up for each of the required types of tests applicable to the device for which certification is requested. These drawings or photographs must show enough detail to confirm other information contained in the test report. Any photographs used must be focused originals without glare or dark spots and must clearly show the test configuration used. This information is provided in this report and Test Setup Exhibits provided with the application filing.

Applicable Standards & Test Procedures

The following information is submitted in accordance with e-CFR dated October 31, 2016, Part 2, Subpart J, Part 15, Subpart 15E, Industry Canada RSS-GEN issue 4, and RSS-247 issue 1.

Test procedures used are the established Methods of Measurement of Radio-Noise Emissions as described in ANSI C63.10-2013, KDB 662911 D01 v02r01, KDB 789033 D02 v01r03, KDB 926956 v02, RSS-247 Issue 1, and RSS-GEN Issue 4. The following information is submitted for processing Class 2 Permissible Change applications for Certification.

Equipment Testing Procedures

AC Line Conducted Emission Test Procedure

Testing for the AC line-conducted emissions was performed as defined in ANSI C63.10-2013. The test setup, including the EUT, was arranged in the test configurations as presented during testing. The test configuration was placed on a 1 x 1.5-meter wooden bench, 0.8 meters high located in a screen room. The power lines of the system were isolated from the power source using a standard LISN with a 50- μ Hy choke. EMI was coupled to the spectrum analyzer through a 0.1 μ F capacitor internal to the LISN. The LISN was positioned on the floor beneath the wooden bench supporting the EUT. The power lines and cables were draped over the back edge of the table. Refer to diagram one showing typical test arrangement and photographs in exhibits for EUT placement used during testing.

Radiated Emission Test Procedure

Radiated emission testing was performed as required on a CISPR 16-1-4 compliant OATS and as specified in ANSI C63.10-2013 and applicable KDB documents. The EUT was placed on a rotating 0.9 x 1.2-meter platform, elevated as required above the ground plane at a distance of 3 meters from the FSM antenna. The table permitted orientation of the EUT in each of three orthogonal axis positions if necessary. EMI energy was maximized by equipment placement, raising and lowering the FSM antenna, changing the antenna polarization, and by rotating the turntable. Each emission was maximized before data was taken using a spectrum analyzer. The frequency spectrum from 9 kHz to 50,000 MHz was searched for during preliminary investigation. Refer to diagrams two and three showing typical test arrangement and photographs in the test setup exhibits for specific EUT placement during testing.

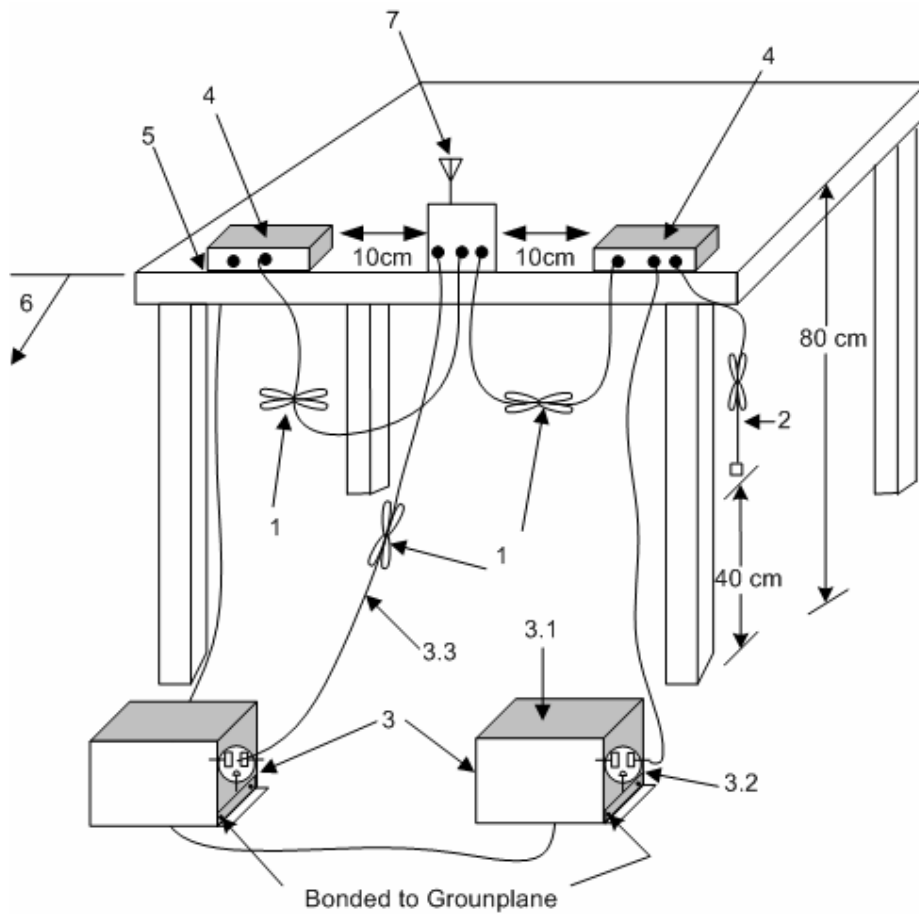

1. Interconnecting cables that hang closer than 40 cm to the ground plane shall be folded back and forth in the center forming a bundle 30 cm to 40 cm long see (see 6.2.3.2).
2. The I/O cables that are not connected to an accessory shall be bundled in the center. The end of the cable may be terminated, if required, using the correct terminating impedance. The overall length shall not exceed 1 m (see 6.2.2).
3. EUT connected to one LISN. Unused LISN measuring port connectors shall be terminated in 50 Ω loads. LISN may be placed on top of, or immediately beneath, reference ground plane (see 6.2.2 and 6.2.3).
 - 3.1 All other equipment powered from additional LISN(s).
 - 3.2 Multiple-outlet strip can be used for multiple power cords of non-EUT equipment.
 - 3.3 LISN at least 80 cm from nearest part of EUT chassis
4. Non-EUT components of EUT system being tested
5. Rear of EUT, including peripherals, shall all be aligned and flush with edge of tabletop (see 6.2.3.2).
6. Edge of tabletop shall be 40 cm removed from a vertical conducting plane that is bonded to the ground plane (see 6.2.2 for options).
7. Antenna may be integral or detachable. If detachable, the antenna shall be attached for this test.

Diagram 1 Test arrangement for Conducted emissions

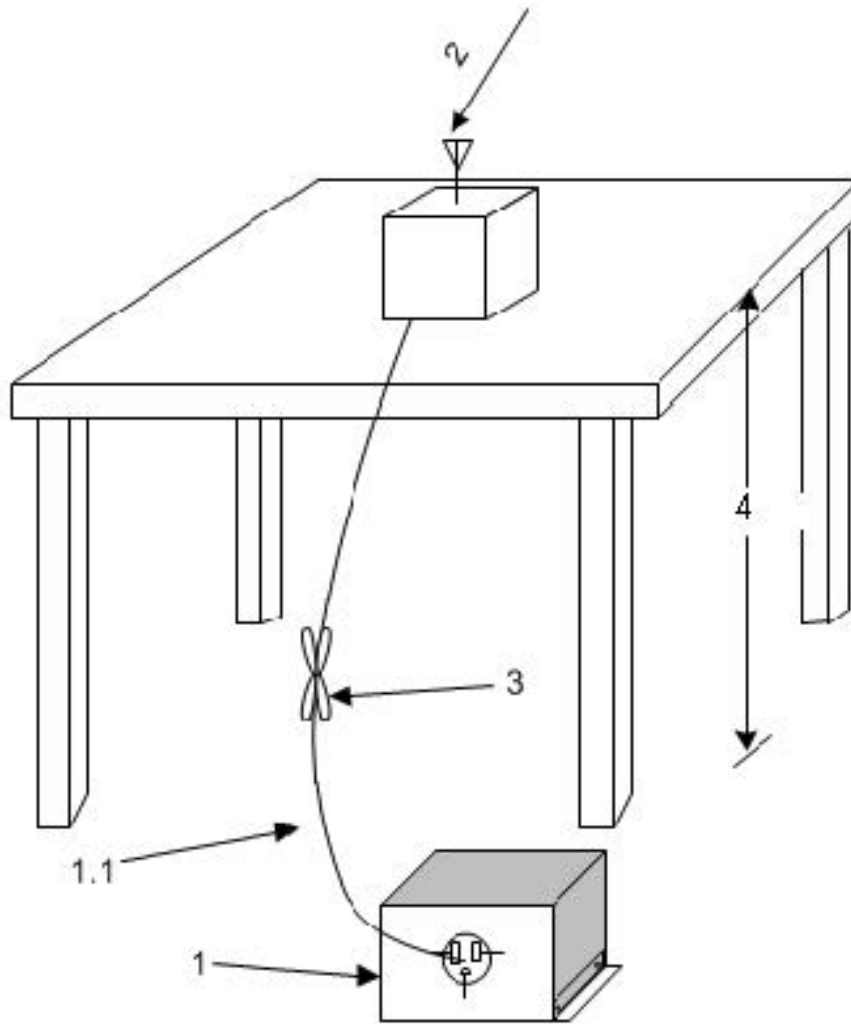

1. A LISN is optional for radiated measurements between 30 MHz and 1000 MHz but not allowed for measurements below 30 MHz and above 1000 MHz (see 6.3.1). If used, then connect EUT to one LISN. Unused LISN measuring port connectors shall be terminated in 50 Ω loads. The LISN may be placed on top of, or immediately beneath, the reference ground plane (see 6.2.2 and 6.2.3.2).
 - 1.1 LISN spaced at least 80 cm from nearest part of EUT chassis.
2. Antenna can be integral or detachable, depending on the EUT (see 6.3.1).
3. Interconnecting cables that hang closer than 40 cm to the ground plane shall be folded back and forth in the center forming a bundle 30 cm to 40 cm long (see 6.3.1).
4. For emission measurements at or below 1 GHz, the table height shall be 80 cm. For emission measurements above 1 GHz, the table height shall be 1.5 m for measurements, except as otherwise specified (see 6.3.1 and 6.6.3.1).

Diagram 2 Test arrangement for radiated emissions of tabletop equipment

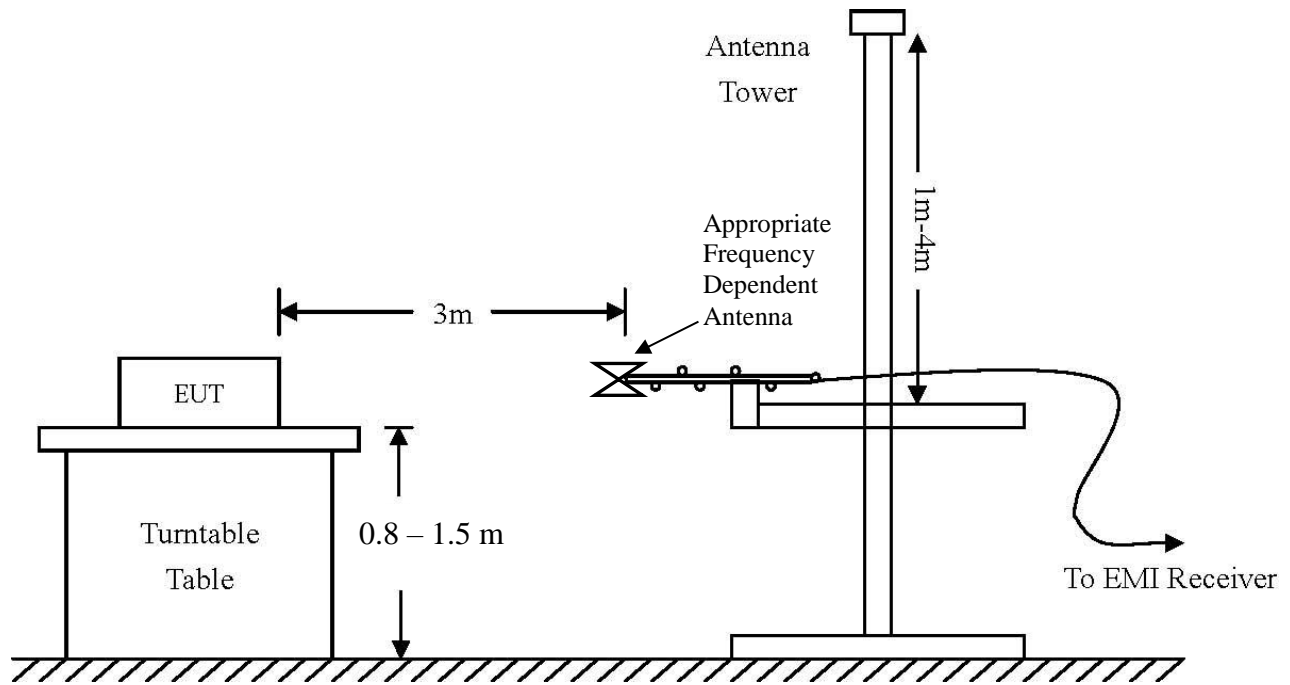

Frequency: 9 kHz-30 MHz	Frequency: 30 MHz- 1 GHz	Frequency: Above 1 GHz
Loop Antenna	Broadband Biconilog	Horn
RBW = 9 kHz	RBW = 120 kHz	RBW = 1 MHz
VBW = 30 kHz	VBW = 120 kHz	VBW = 1 MHz
Sweep time = Auto	Sweep time = Auto	Sweep time = Auto
Detector = PK, QP	Detector = PK, QP	Detector = PK, AV
Antenna Height 1m	Antenna Height 1-4m	Antenna Height 1-4m

Diagram 3 Test arrangement for radiated emissions tested on Open Area Test Site (OATS)

Test Site Locations

Conducted EMI The AC power line conducted emissions testing performed in a shielded screen room located at Rogers Labs, Inc., 4405 West 259th Terrace, Louisburg, KS

Radiated EMI The radiated emissions tests were performed at the 3 meters, Open Area Test Site (OATS) located at Rogers Labs, Inc., 4405 West 259th Terrace, Louisburg, KS

Site Registration Refer to Annex for Site Registration Letters

NVLAP Accreditation Lab code 200087-0

List of Test Equipment

A Rohde and Schwarz ESU40 and/or Hewlett Packard 8591EM was used as the measuring device for the emissions testing of frequencies below 1 GHz. A Rohde and Schwarz ESU40 and/or Hewlett Packard 8562A Spectrum Analyzer was used as the measuring device for testing the emissions at frequencies above 1 GHz. The analyzer settings used are described in the following table. Refer to the appendix for a complete list of test equipment.

AC Line Conducted Emissions (0.150 -30 MHz)		
RBW	AVG. BW	Detector Function
9 kHz	30 kHz	Peak / Quasi Peak
Emissions (30-1000 MHz)		
RBW	AVG. BW	Detector Function
120 kHz	300 kHz	Peak / Quasi Peak
Emissions (Above 1000 MHz)		
RBW	Video BW	Detector Function
100 kHz	100 kHz	Peak
1 MHz	1 MHz	Peak / Average

<u>Equipment</u>	<u>Manufacturer</u>	<u>Model (SN)</u>	<u>Band</u>	<u>Cal Date</u>	<u>Due</u>
<input checked="" type="checkbox"/> LISN	FCC	FCC-LISN-50-2-10(1PA) (160611)	.15-30MHz	5/16	5/17
<input checked="" type="checkbox"/> Cable	Time Microwave	750HF290-750 (L10M)	9kHz-40 GHz	10/16	10/17
<input checked="" type="checkbox"/> Cable	Belden	RG-58 (L1-CAT3-11509)	9kHz-30 MHz	10/16	10/17
<input checked="" type="checkbox"/> Cable	Belden	RG-58 (L2-CAT3-11509)	9kHz-30 MHz	10/16	10/17
<input type="checkbox"/> Antenna	ARA	BCD-235-B (169)	20-350MHz	10/16	10/17
<input type="checkbox"/> Antenna	EMCO	3147 (40582)	200-1000MHz	10/16	10/17
<input checked="" type="checkbox"/> Antenna	ETS-Lindgren	3117 (200389)	1-18 GHz	5/16	5/18
<input type="checkbox"/> Antenna	Com Power	AH-118 (10110)	1-18 GHz	10/15	10/17
<input checked="" type="checkbox"/> Antenna	Com Power	AH-840 (101046)	18-40 GHz	5/16	5/18
<input checked="" type="checkbox"/> Antenna	Com Power	AL-130 (121055)	.001-30 MHz	10/16	10/17
<input checked="" type="checkbox"/> Antenna	Sunol	JB-6 (A100709)	30-1000 MHz	10/16	10/17
<input type="checkbox"/> Antenna	EMCO	3143 (9607-1277)	20-1200 MHz	5/16	5/17
<input type="checkbox"/> Analyzer	HP	8591EM (3628A00871)	9kHz-1.8GHz	5/16	5/17
<input type="checkbox"/> Analyzer	HP	8562A (3051A05950)	9kHz-110GHz	5/16	5/17
<input type="checkbox"/> Analyzer	HP External Mixers	11571, 11970	25GHz-110GHz	5/16	5/17
<input checked="" type="checkbox"/> Analyzer	Rohde & Schwarz	ESU40 (100108)	20Hz-40GHz	5/16	5/17
<input checked="" type="checkbox"/> Amplifier	Com-Power	PA-010 (171003)	100Hz-30MHz	10/16	10/17
<input checked="" type="checkbox"/> Amplifier	Com-Power	CPPA-102 (01254)	1-1000 MHz	10/16	10/17
<input checked="" type="checkbox"/> Amplifier	Com-Power	PAM-118A (551014)	0.5-18 GHz	10/16	10/17

Units of Measurements

Conducted EMI Data is in dB μ V; dB referenced to one microvolt

Radiated EMI Data is in dB μ V/m; dB/m referenced to one microvolt per meter

Sample Calculation:

RFS = Radiated Field Strength, FSM = Field Strength Measured

A.F. = Receive antenna factor, Gain = amplification gains and/or cable losses

$RFS (dB\mu V/m @ 3m) = FSM (dB\mu V) + A.F. (dB) - Gain (dB)$

Environmental Conditions

Ambient Temperature	21.3° C
Relative Humidity	37%
Atmospheric Pressure	1007.5 mb

Intentional Radiators

As per 47CFR part 15 subpart E and Industry Canada RSS-247, Issue 1, the following information is submitted for consideration and demonstration of compliance with regulation and standards.

Antenna Requirements

The EUT incorporates integral printed circuit board antenna and offers no provision for alternate antenna or antenna replacement. Therefore, the design complies with the unique antenna connection requirements. The requirements of 15.203 are fulfilled there are no deviations or exceptions to the specification.

Restricted Bands of Operation

Spurious emissions falling in the restricted frequency bands of operation were measured on the OATS. The EUT utilizes frequency, determining circuitry, which generates harmonics falling in restricted bands. Emissions were investigated while the EUT was located on the OATS using appropriate antennas or pyramidal horns, amplification stages, and spectrum analyzer receiver. Peak and average amplitudes of frequencies above 1000 MHz were compared to the required limits with worst-case data presented below. Test procedures of ANSI C63.10-2013 were used during testing. No other significant emission was observed which fell into the restricted bands of operation. Computed radiated emission values consider the measured radiated field strength, receive antenna correction factor, amplifier gain stage, and test system cable losses.

Table 1 Radiated Emissions in Restricted Bands Data

Frequency in MHz	Horizontal Peak (dB μ V/m)	Horizontal Quasi-Peak (dB μ V/m)	Horizontal Average (dB μ V/m)	Vertical Peak (dB μ V/m)	Vertical Quasi-Peak (dB μ V/m)	Vertical Average (dB μ V/m)	Limit @ 3m (dB μ V/m)
U-NII-1 Operation Worst-case							
5150.0	44.5	N/A	31.5	44.6	N/A	31.4	54.0
5350.0	44.1	N/A	31.5	44.7	N/A	31.4	54.0
10360.0	48.4	N/A	35.7	48.8	N/A	35.6	54.0
10440.0	47.8	N/A	35.2	47.8	N/A	35.4	54.0
10480.0	47.4	N/A	34.6	47.8	N/A	34.5	54.0
20720.0	50.2	N/A	36.7	49.4	N/A	36.8	54.0
U-NII-3 Operation 802.11a							
11490.0	48.3	N/A	35.3	48.2	N/A	35.5	54.0
11570.0	47.7	N/A	35.0	47.4	N/A	34.7	54.0
11650.0	48.2	N/A	35.2	48.2	N/A	35.2	54.0
22980.0	51.2	N/A	37.8	50.7	N/A	37.5	54.0

Other emissions present had amplitudes at least 20 dB below the limit. Peak and Quasi-Peak amplitude emissions are recorded above for frequency range below 1000 MHz. Peak and Average amplitude emissions are recorded above for frequency range above 1000 MHz.

Summary of Results for Radiated Emissions in Restricted Bands

The EUT demonstrated compliance with the emissions requirements of 47CFR 15.205, RSS-GEN and RSS-247, Issue 1 Intentional Radiators. The EUT provided a worst-case minimum margin of -16.2 dB below the emissions requirements in restricted frequency bands. Peak, Quasi-peak, and average amplitudes were checked for compliance with the regulations. Worst-case emissions are reported with other emissions found in the restricted frequency bands at least 20 dB below the requirements.

AC Line Conducted Emissions Procedure

The EUT was arranged in a typical equipment configuration and placed on a 1 x 1.5-meter wooden bench 80 cm above the conducting ground plane, floor of a screen room. The bench was positioned 40 cm away from the wall of the screen room. The LISN was positioned on the floor of the screen room 80-cm from the rear of the EUT. The manufacturer supplied supporting equipment AC/DC adapter provided direct current power to the POE, which routed power to the EUT, was connected to the LISN. A second LISN was positioned on the floor of the screen room 80-cm from the rear of the supporting equipment of the EUT. All power cords except the EUT were then powered from the second LISN. EMI was coupled to the spectrum analyzer through a 0.1 µf capacitor, internal to the LISN. Power line conducted emissions testing were carried out individually for each current carrying conductor of the EUT. The excess length of lead between the system and the LISN receptacle was folded back and forth to form a bundle not exceeding 40 cm in length. The screen room, conducting ground plane, analyzer, and LISN were bonded together to the protective earth ground. Preliminary testing was performed to identify the frequency of each emission displaying the highest amplitude. The cables were repositioned to obtain maximum amplitude of measured EMI level. Once the worst-case configuration was identified, plots were made of the EMI from 0.15 MHz to 30 MHz then the data was recorded with maximum conducted emissions levels. Refer to figures one and two for plots of the EUT AC Line Conducted emissions.

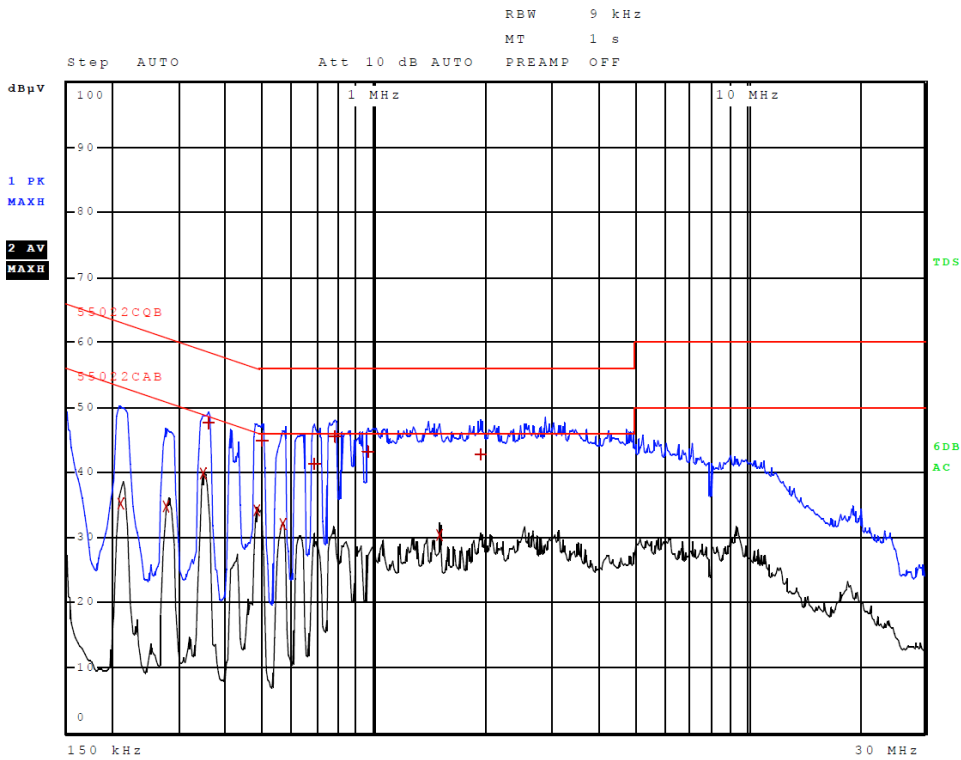

Figure 1 AC Line Conducted Emissions Line 1

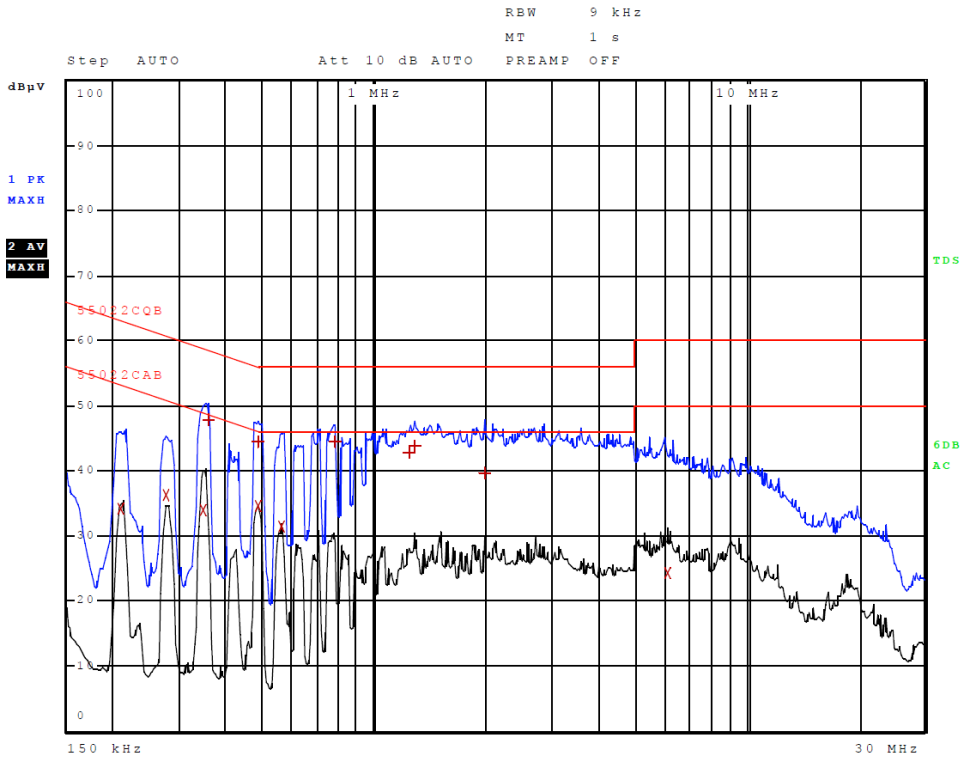

Figure 2 AC Line Conducted Emissions Line 2

Table 2 AC Line Conducted Emissions Data (Highest Emissions Line L1)

Trace	Frequency	Level (dBµV)	Detector	Delta Limit/dB
2	210.000000000 kHz	35.21	Average	-18.00
2	278.000000000 kHz	34.83	Average	-16.05
2	346.000000000 kHz	39.78	Average	-9.28
1	358.000000000 kHz	47.56	Quasi Peak	-11.22
2	482.000000000 kHz	34.19	Average	-12.11
1	498.000000000 kHz	44.77	Quasi Peak	-11.27
2	566.000000000 kHz	31.99	Average	-14.01
1	686.000000000 kHz	41.18	Quasi Peak	-14.82
1	782.000000000 kHz	45.42	Quasi Peak	-10.58
1	962.000000000 kHz	43.17	Quasi Peak	-12.83
2	1.498000000 MHz	30.42	Average	-15.58
1	1.922000000 MHz	42.82	Quasi Peak	-13.18

Other emissions present had amplitudes at least 20 dB below the limit.

Table 3 AC Line Conducted Emissions Data (Highest Emissions Line L2)

Trace	Frequency	Level (dBµV)	Detector	Delta Limit/dB
2	210.000000000 kHz	34.18	Average	-19.02
2	278.000000000 kHz	36.14	Average	-14.74
2	350.000000000 kHz	33.99	Average	-14.97
1	358.000000000 kHz	47.70	Quasi Peak	-11.08
2	486.000000000 kHz	34.58	Average	-11.66
1	486.000000000 kHz	44.36	Quasi Peak	-11.87
2	562.000000000 kHz	31.31	Average	-14.69
1	782.000000000 kHz	44.41	Quasi Peak	-11.59
1	1.246000000 MHz	42.83	Quasi Peak	-13.17
1	1.282000000 MHz	43.77	Quasi Peak	-12.23
1	1.990000000 MHz	39.57	Quasi Peak	-16.43
2	6.148000000 MHz	24.34	Average	-25.66

Other emissions present had amplitudes at least 20 dB below the limit.

Summary of Results for AC Line Conducted Emissions

The EUT test system demonstrated compliance to the conducted emissions requirements of 47CFR 15.207, RSS-247 Issue 1 and RSS-GEN. The EUT demonstrated minimum margin of -9.2 dB below the limit. Measurements were taken using the peak, quasi peak, and average, measurement function for each emissions amplitude and were below the limits stated in the specification. Other emissions were present with recorded data representing worst-case amplitudes.

General Radiated Emissions Procedure

The EUT was arranged in a typical equipment configuration and operated through all available modes with worst-case data recorded. Preliminary testing was performed in a screen room with the EUT positioned 1 meter from the FSM. Radiated emissions measurements were performed to identify the frequencies, which produced the highest emissions. Each radiated emission was then maximized at the OATS location before final radiated emissions measurements were performed. Final data was taken with the EUT located at the OATS at a distance of 3 meters between the EUT and the receiving antenna. The frequency spectrum from 9 kHz to 60,000 MHz was searched for general radiated emissions. Measured emission levels were maximized by EUT placement on the table, rotating the turntable through 360 degrees, varying the antenna height between 1 and 4 meters above the ground plane and changing antenna position between horizontal and vertical polarization. Antennas used were Loop from 9 kHz to 30 MHz, Broadband Biconical from 30 to 200 MHz, Biconilog from 30 to 1000 MHz, Log Periodic from 200 MHz to 1 GHz and or Double Ridge or pyramidal horns and mixers above 1 GHz, notch filters, and appropriate amplifiers and external mixers were utilized.

Table 4 General Radiated Emissions from EUT Data (Highest Emissions)

Frequency in MHz	Horizontal Peak (dB μ V/m)	Horizontal Quasi-Peak (dB μ V/m)	Horizontal Average (dB μ V/m)	Vertical Peak (dB μ V/m)	Vertical Quasi-Peak (dB μ V/m)	Vertical Average (dB μ V/m)	Limit @ 3m (dB μ V/m)
47.6	36.2	30.8	N/A	40.4	34.7	N/A	40.0
49.2	37.1	32.1	N/A	38.7	33.2	N/A	40.0
51.7	34.8	28.2	N/A	40.4	33.9	N/A	40.0
69.5	41.6	29.2	N/A	40.8	30.6	N/A	40.0
70.7	43.7	31.5	N/A	42.1	30.7	N/A	40.0
88.7	39.1	32.5	N/A	36.5	32.5	N/A	40.0
105.8	38.1	33.3	N/A	34.2	28.2	N/A	43.5
109.7	38.6	29.0	N/A	34.4	24.0	N/A	43.5
125.0	41.5	32.1	N/A	34.1	29.7	N/A	43.5
153.0	40.8	25.9	N/A	36.1	30.4	N/A	43.5
153.9	41.1	27.4	N/A	38.3	37.0	N/A	43.5
154.2	40.2	26.2	N/A	35.3	23.8	N/A	43.5
154.8	40.9	26.5	N/A	37.7	32.9	N/A	43.5
164.5	37.5	32.0	N/A	35.7	29.6	N/A	43.5
194.7	33.5	26.9	N/A	33.7	27.1	N/A	43.5
197.6	38.1	26.9	N/A	33.7	27.8	N/A	43.5
212.3	38.3	26.7	N/A	35.2	28.1	N/A	43.5
218.9	33.0	28.5	N/A	34.2	28.6	N/A	46.0
229.3	30.6	25.1	N/A	37.7	32.2	N/A	46.0
230.4	30.7	24.9	N/A	37.5	31.8	N/A	46.0

Other emissions present had amplitudes at least 20 dB below the limit. Peak and Quasi-Peak amplitude emissions are recorded above for frequency range below 1000 MHz. Peak and Average amplitude emissions are recorded above for frequency range above 1000 MHz.

Summary of Results for General Radiated Emissions

The EUT demonstrated compliance with the radiated emissions requirements of 47CFR part 15 and Industry Canada RSS-247 Issue 1 Intentional Radiators. The EUT demonstrated a minimum margin of -5.3 dB below the requirements. Other emissions were present with amplitudes at least 20 dB below the Limits.

Operation in the 5150-5250 and 5725-5850 MHz Frequency U-NII-1 and U-NII-3 Bands

Testing followed FCC KDB 789033 D02 General U-NII Test Procedures New Rules v01r03.

The test sample #2 provided direct connection to the antenna ports. A power meter was used to measure fundamental transmitter output power. A spectrum analyzer / receiver was used to produce plots and make other antenna port conducted measurements for compliance testing. Test software (Winbox version 3.10) was used to operate the transmitter. This software provided the ability to set test channel, operational mode, and modulation scheme. The test antenna ports were connected to coaxial cable with 50-ohm attenuator and receiver, spectrum analyzer, or power meter during testing. Radiated emissions testing was performed on sample 1 (production unit) with the sample placed on a turntable elevated as required above the ground plane at 3-meters distance from the FSM antenna located on the OATS. The peak and quasi-peak amplitude of the frequencies below 1000 MHz were measured using a spectrum analyzer. The peak and average amplitude of emissions above 1000 MHz were measured using a spectrum analyzer. Emissions data was recorded from the measurement results. Data presented reflects measurement result corrected to account for measurement system gains and losses. Plots were made of transmitter performance for reference and demonstration of compliance.

In addition, all Manufacturers of U-NII devices are responsible for ensuring frequency stability such that an emission is maintained within the band of operation under all conditions of normal operation as specified in the user's manual. The manufacturer has attested the equipment operates within the required frequency spectrum under normal operational conditions. The design provides three transmitter chains and antenna port connections with operational capabilities in 2 frequency bands (5180-5240 MHz and 5745-5825 MHz). This report documents emissions governed under the new rules for U-NII-1 and U-NII-3 bands operating in the 5180-5240 and 5745-5825 MHz frequency bands.

The design provides 2 transmitter chains which may be correlated. Summing the gain of the highest gain antenna system (16 dBi) would provide for 19 dBi gain (Directional gain = GANT + 10 log (NANT) dBi = 21 + 10 log (2) = 21 + 3 = 24 dBi

Per 15.407 Technical Requirements

(a) power limitations

(1) For the Band 5.15-5.25 GHz

- (i) For an outdoor access point operating in the band 5.15-5.25 GHz, the maximum conducted output power over the frequency band of operation shall not exceed 1 W provided the maximum antenna gain does not exceed 6 dBi. In addition, the maximum power spectral density shall not exceed 17 dBm in any 1 megahertz band. If transmitting antennas of directional gain greater than 6 dBi are used, both the maximum conducted output power and the maximum power spectral density shall be reduced by the amount in dB that the directional gain of the antenna exceeds 6 dBi. The maximum e.i.r.p. at any elevation angle above 30 degrees as measured from the horizon must not exceed 125 mW (21 dBm).

**Per KDB 789033 D02 General UNII Test Procedures New Rules v01r03, Section II
 H. Measurement of emission at elevation angle higher than 30° from horizon.**

This restriction leads to a general requirement for the antenna pattern: if the EIRP within 3-dB elevation beamwidth of any radiation lobe is higher than 125 mW, this lobe must be controlled, either mechanically or electrically, so that the 3-dB elevation beamwidth of this lobe is below 30° elevation angle relative to horizon.

For the purposes of compliance, information for all the antenna types must be included in the filing. For antennas to be considered of similar type, the antenna patterns must also be similar as well as other characteristics of the antenna. Antenna information has been included in the application in support of this requirement.

Note: For the sake of clarity, we define the elevation angle where 0° is horizontal and 90° is straight-up.

1. For fixed infrastructure, not electrically or mechanically steerable beam antenna

- a) If elevation plane radiation pattern is available:
- I) Determine the device intended mounting elevation angle and define 0° reference angle on the elevation plane radiation pattern.
 - ii) Indicate any radiation pattern between 30° and 90° which has highest gain.
 - iii) Calculate the EIRP based on this highest gain and conducted output power.
 - iv) Compare to the limit of 125 mW to find compliance.
 - v) Include the elevation pattern data in the application filing with the test report to show how the calculations are made.
- b) If elevation plane radiation pattern is not available, but the antenna type (such as dipole omnidirectional, Yagi, parabolic, or sector antenna) has symmetrical elevation plane pattern referenced at main beam and all lobes on the main beam elevation plane have highest gains, then the following measurement method is acceptable to determine compliance:
- (i) Determine the device's intended mounting elevation angle referenced to the horizon.
 - (ii) Rotate EUT antenna by 90° around the main beam axis in horizontal position to transform measurement in elevation angle into azimuth angle and define 0° reference angle based on device's intended mounting elevation angle.
 - (iii) Move test antenna along the horizontal arc, or rotate the turn table with EUT antenna placed at the center, between 30° and 90° relative to the 0° reference angle, and then continuing down from 90° to 30° on the other side of the pattern, while maintaining the test antenna pointing with constant distance to the EUT antenna and search for the spot which has the highest measured emission. Both horizontal and vertical polarization shall be investigated to find out the maximum radiated emission level.
 Note: Moving of test antenna along the horizontal arc, or rotating the turn table, shall be performed in angular step size as small as possible, but not larger than 3°.
 - (iv) Calculate the EIRP based on the highest measured emission and compare to the limit of 125 mW to determine compliance.
 - (v) The antenna pattern measurements should be included in the filing.

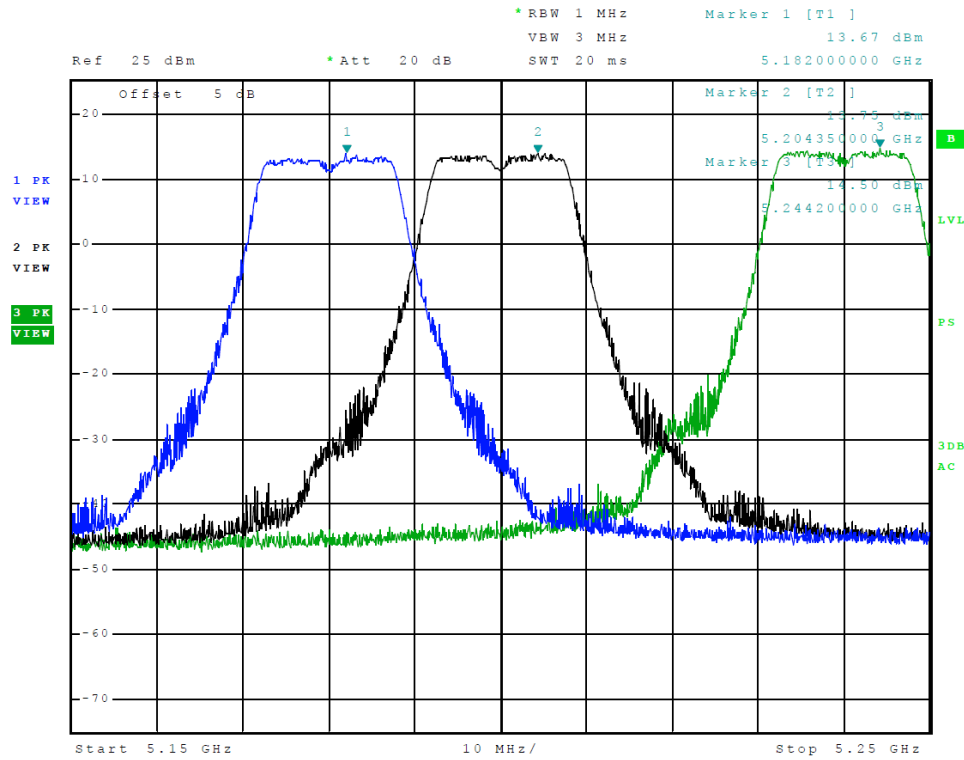

Figure 3 Plot of Transmitter Emissions (Chain 0, Across 5150-5250 MHz Band, 802.11a)

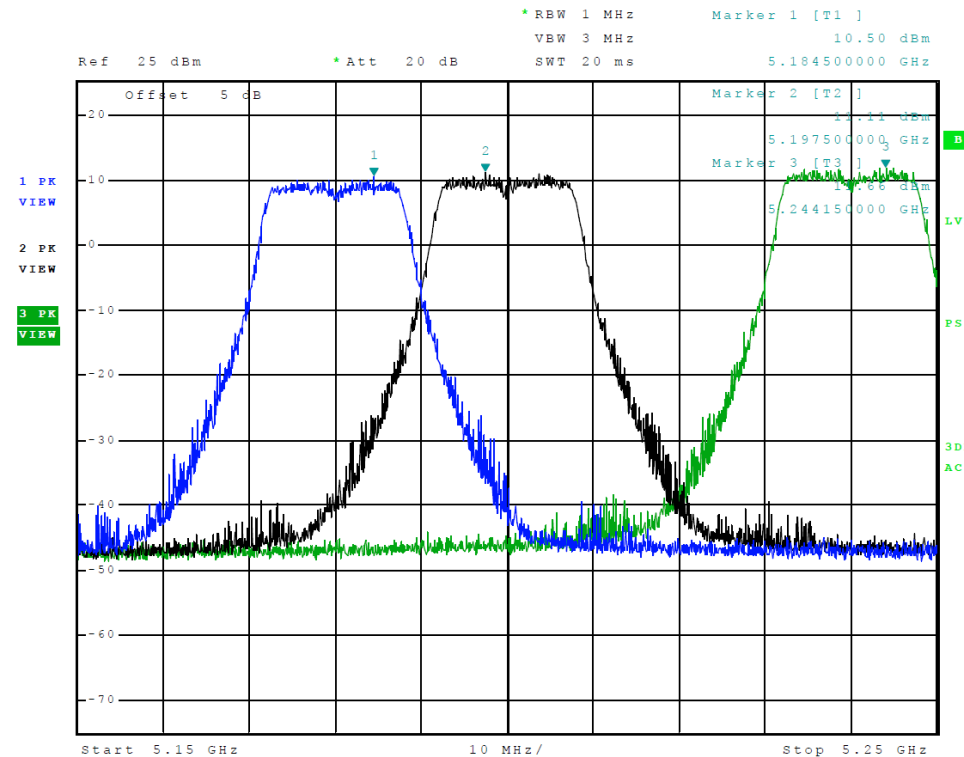

Figure 4 Plot of Transmitter Emissions (Chain 1, Across 5150-5250 MHz Band, 802.11a)

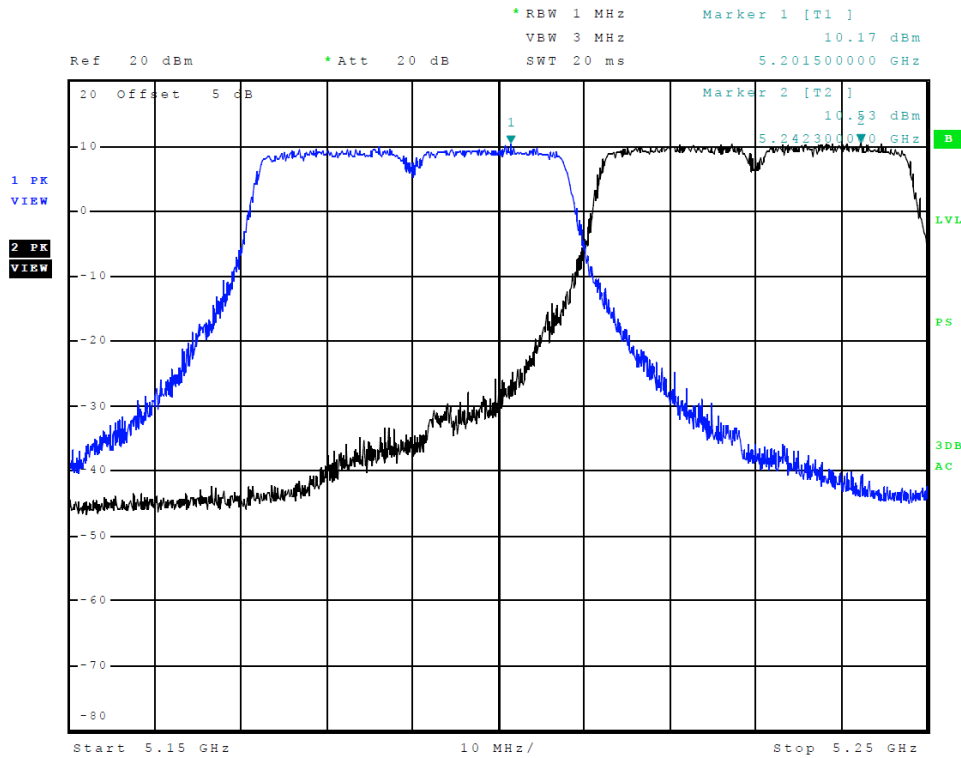

Figure 5 Plot of Transmitter Emissions (Chain0, Across 5150-5250 MHz Band, 802.11n40)

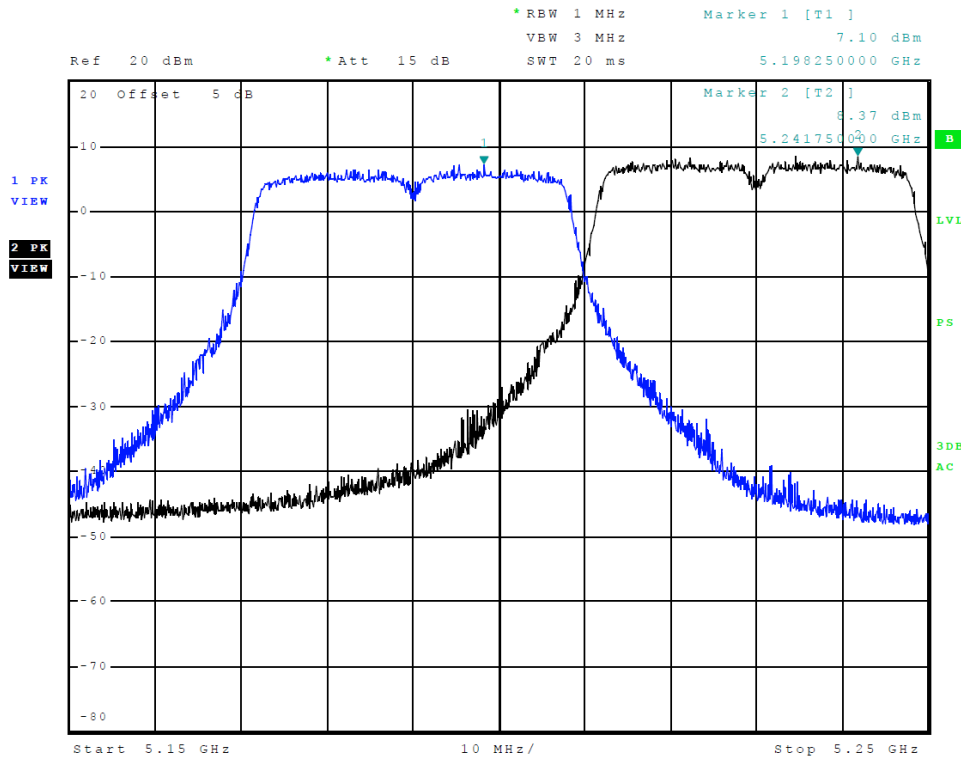

Figure 6 Plot of Transmitter Emissions (Chain 1, Across 5150-5250 MHz Band, 802.11n40)

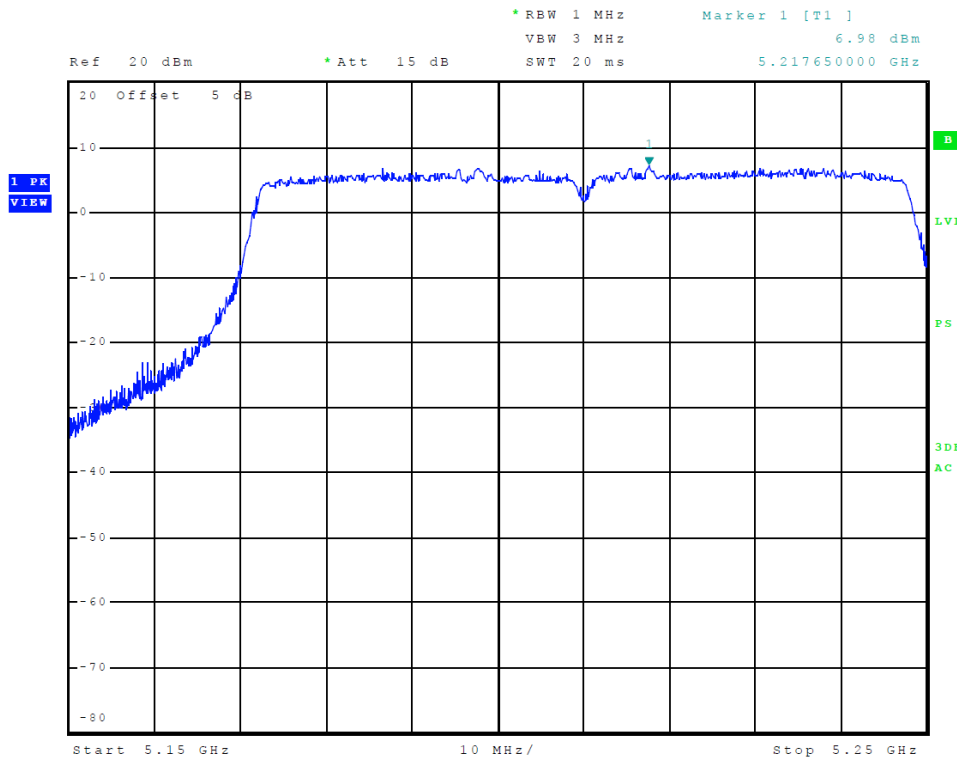

Figure 7 Plot of Transmitter Emissions (Chain 0, Across 5150-5250 MHz Band, 802.11ac80)

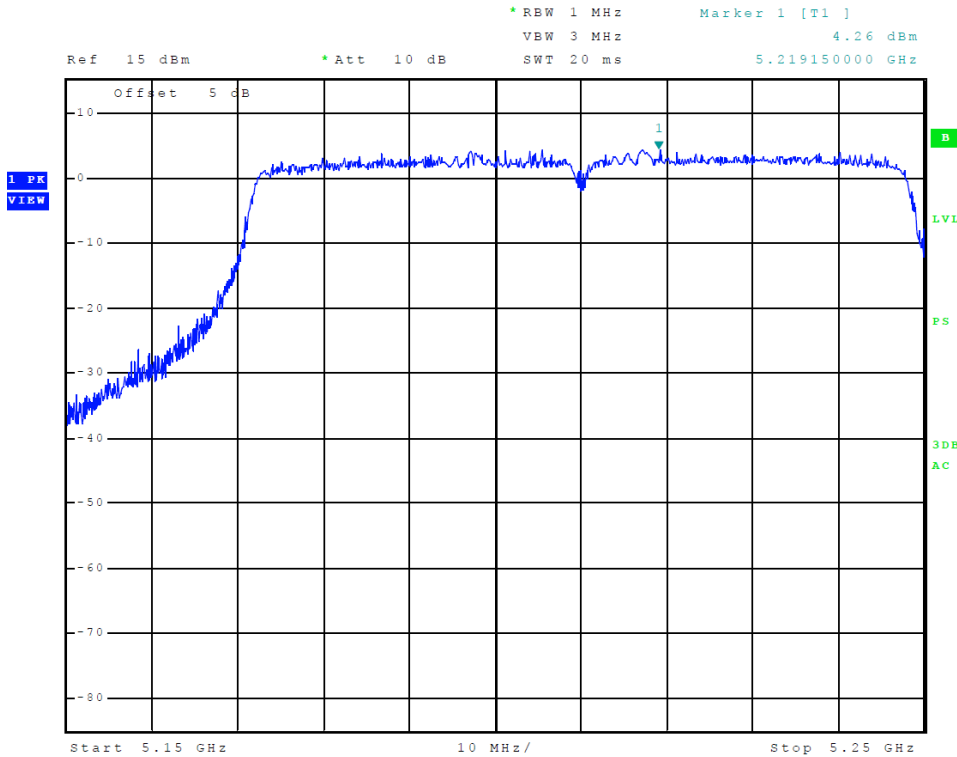

Figure 8 Plot of Transmitter Emissions (Chain 1, Across 5150-5250 MHz Band, 802.11ac80)

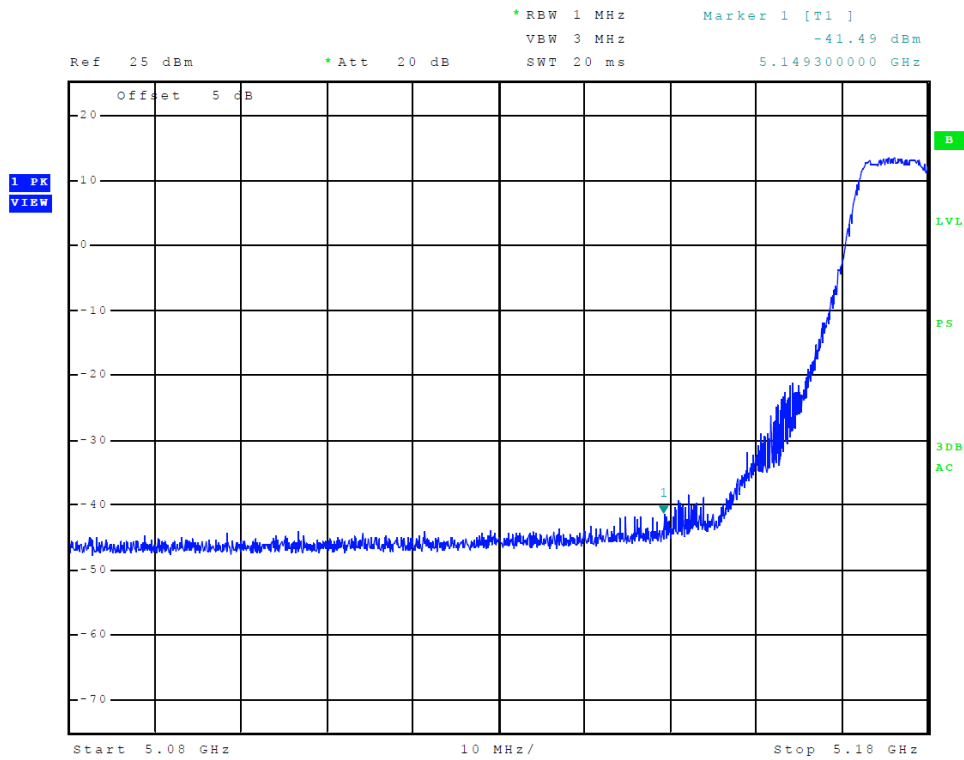

Figure 9 Plot of Transmitter Low Band Edge (Chain 0, 5150-5250 MHz Band, 802.11a)

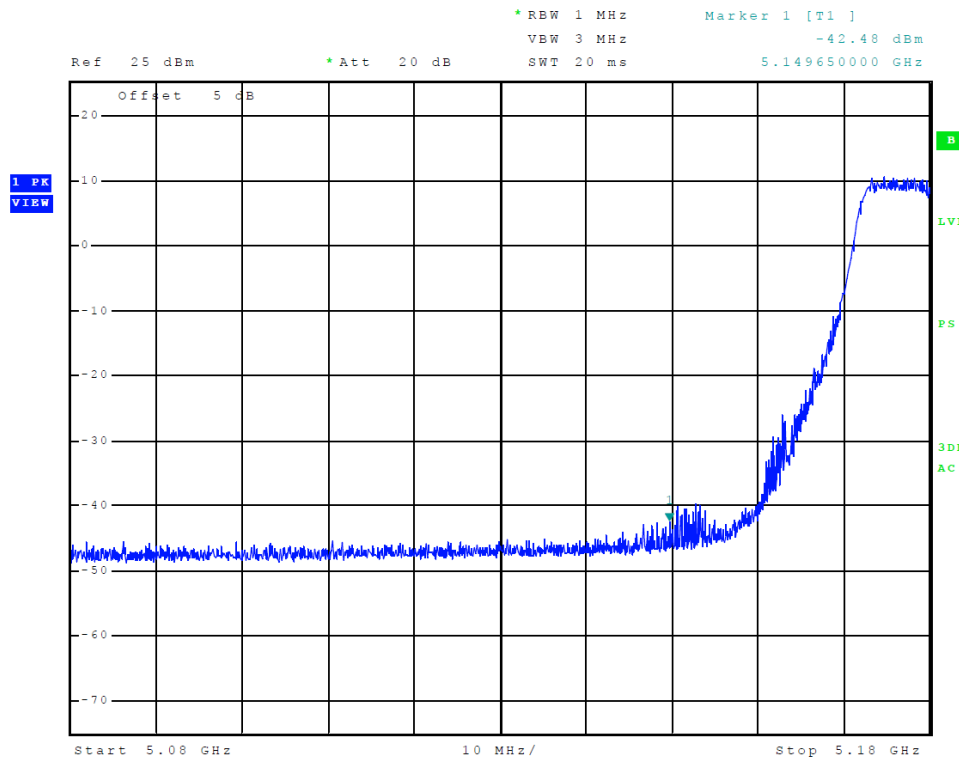

Figure 10 Plot of Transmitter Low Band Edge (Chain 1, 5150-5250 MHz Band, 802.11a)

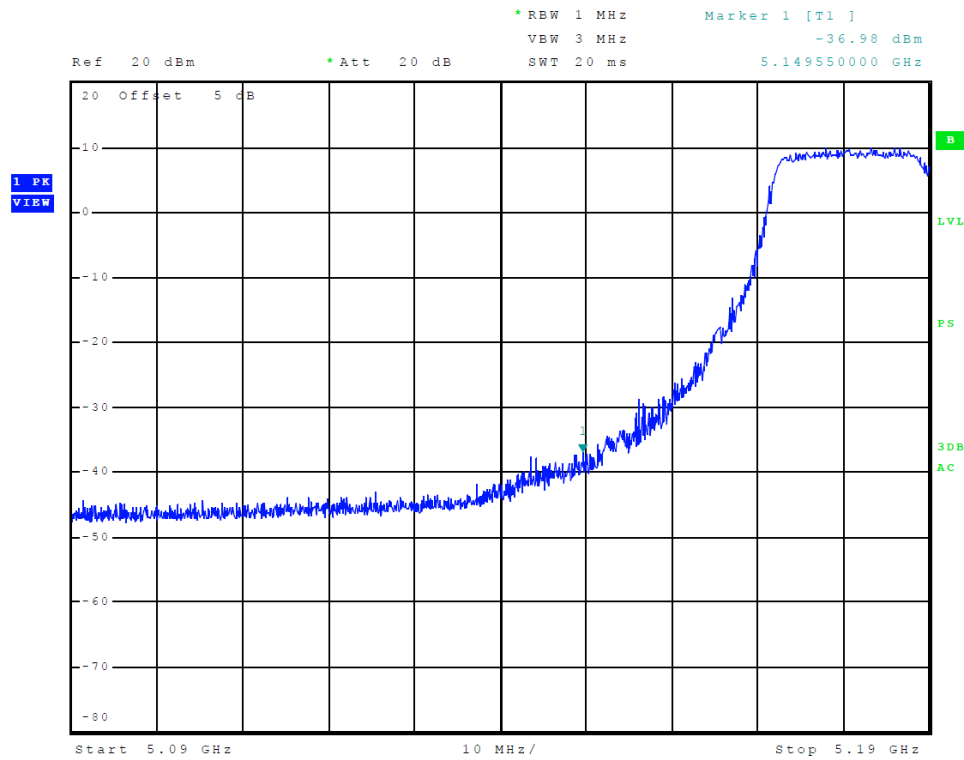

Figure 11 Plot of Transmitter Low Band Edge (Chain 0, 5150-5250 MHz Band, 802.11n40)

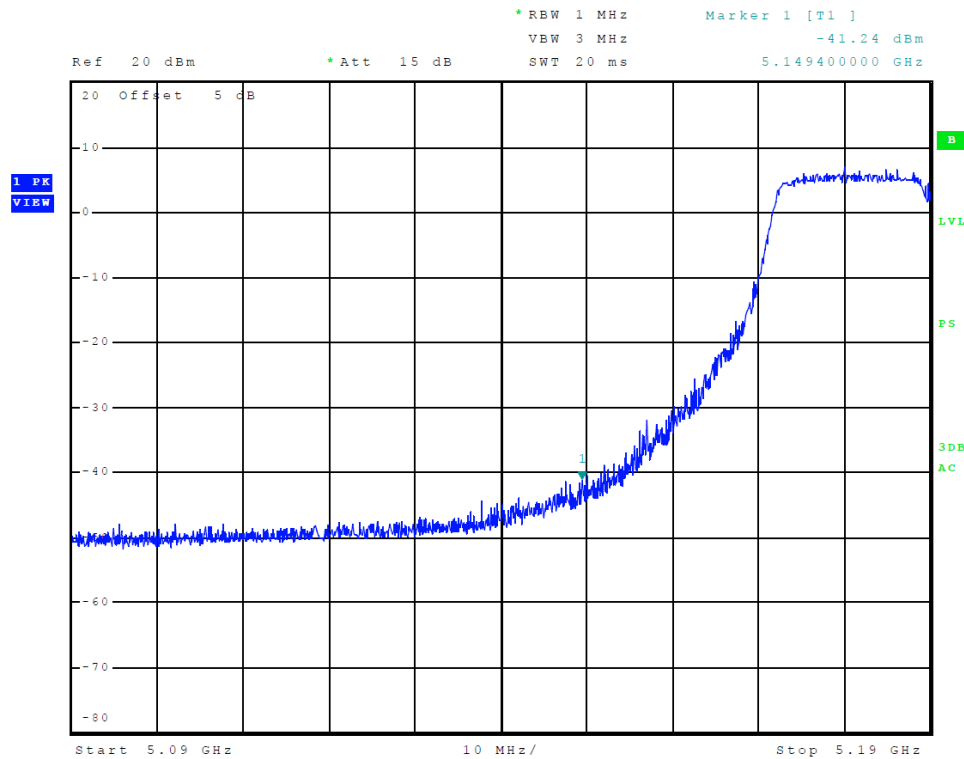

Figure 12 Plot of Transmitter Low Band Edge (Chain 1, 5150-5250 MHz Band, 802.11n40)

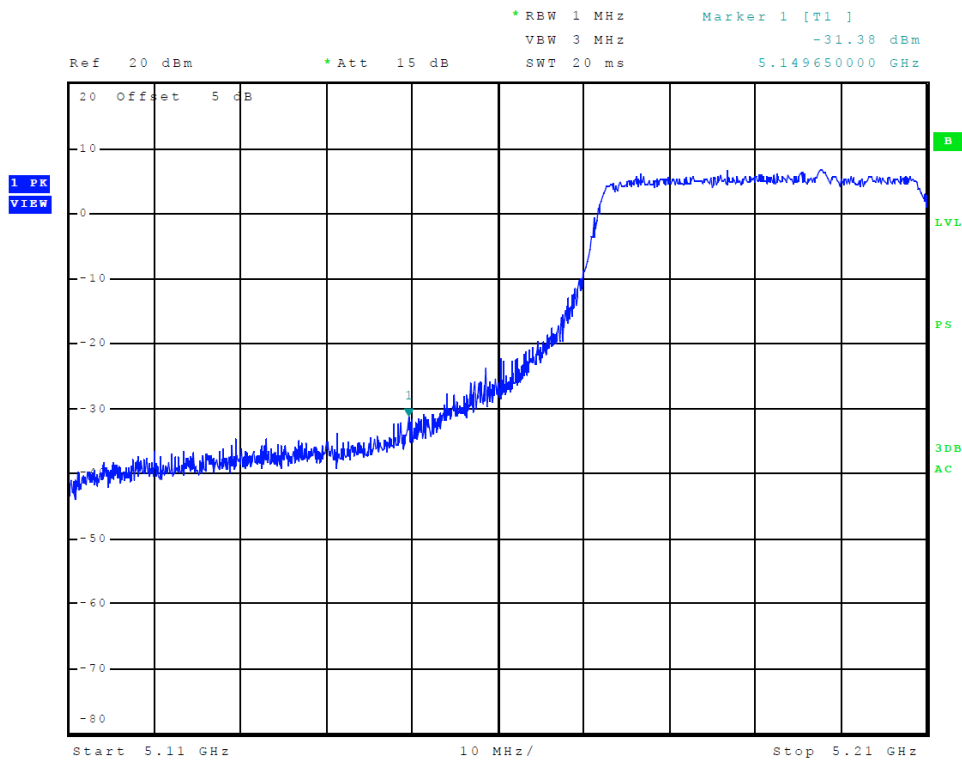

Figure 13 Plot of Transmitter Low Band Edge (Chain 0, 5150-5250 MHz Band, 802.11ac80)

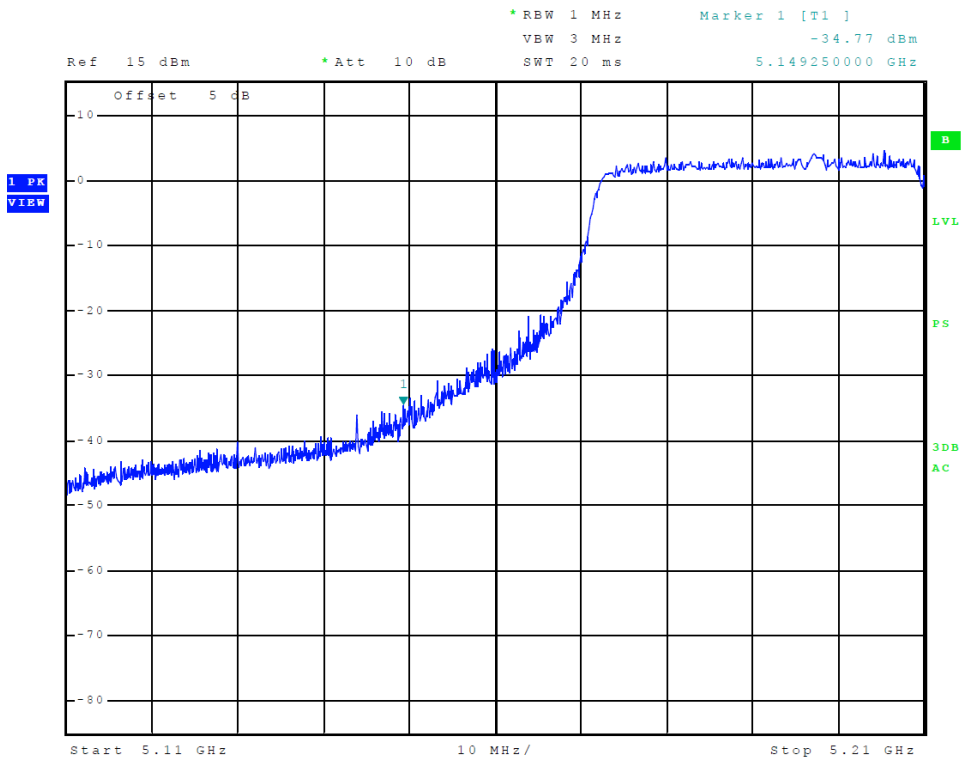

Figure 14 Plot of Transmitter Low Band Edge (Chain 1, 5150-5250 MHz Band, 802.11ac80)

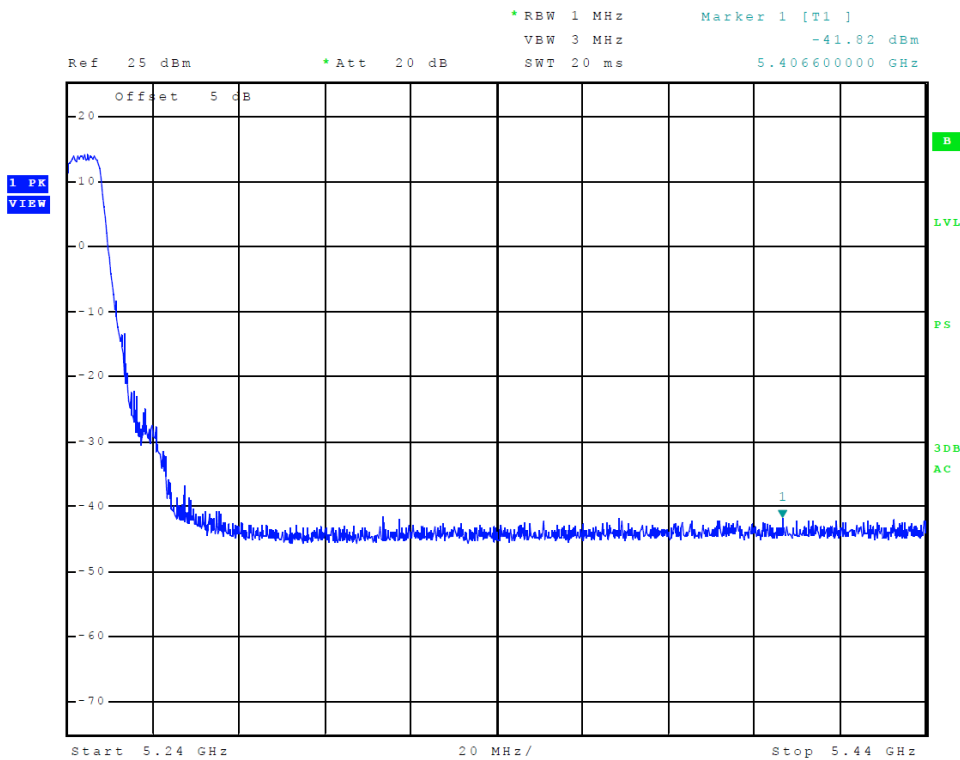

Figure 15 Plot of Transmitter High Band Edge (Chain 0, 5150-5250 MHz Band, 802.11a)

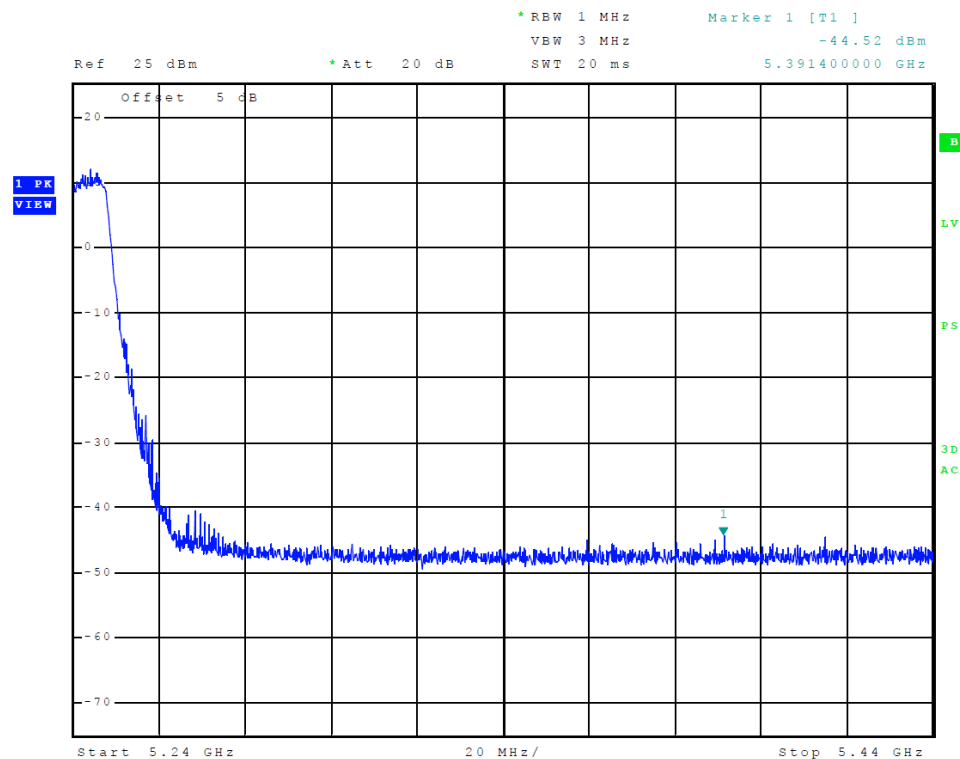

Figure 16 Plot of Transmitter High Band Edge (Chain 1, 5150-5250 MHz Band, 802.11a)

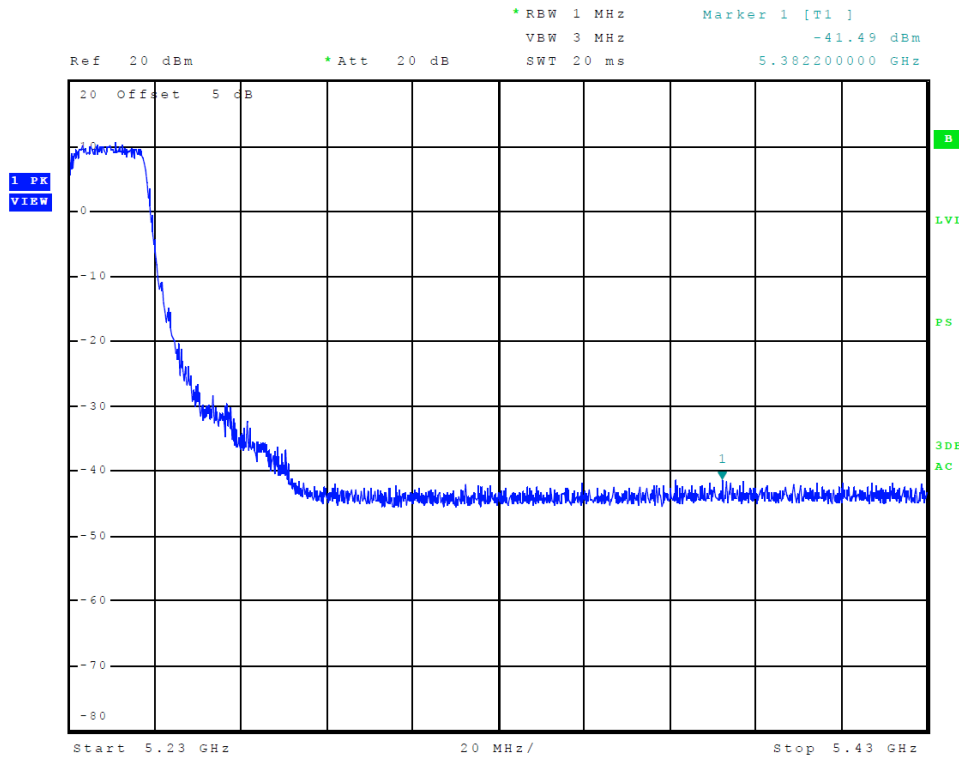

Figure 17 Plot of Transmitter High Band Edge (Chain 0, 5150-5250 MHz Band, 802.11n40)

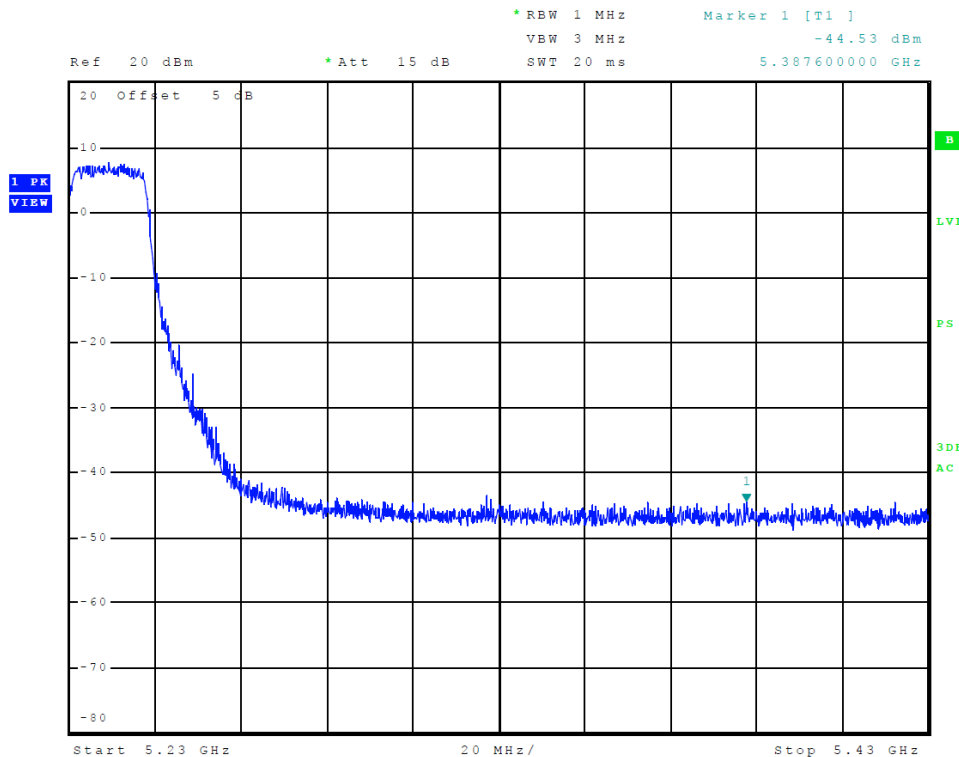

Figure 18 Plot of Transmitter High Band Edge (Chain 1, 5150-5250 MHz Band, 802.11n40)

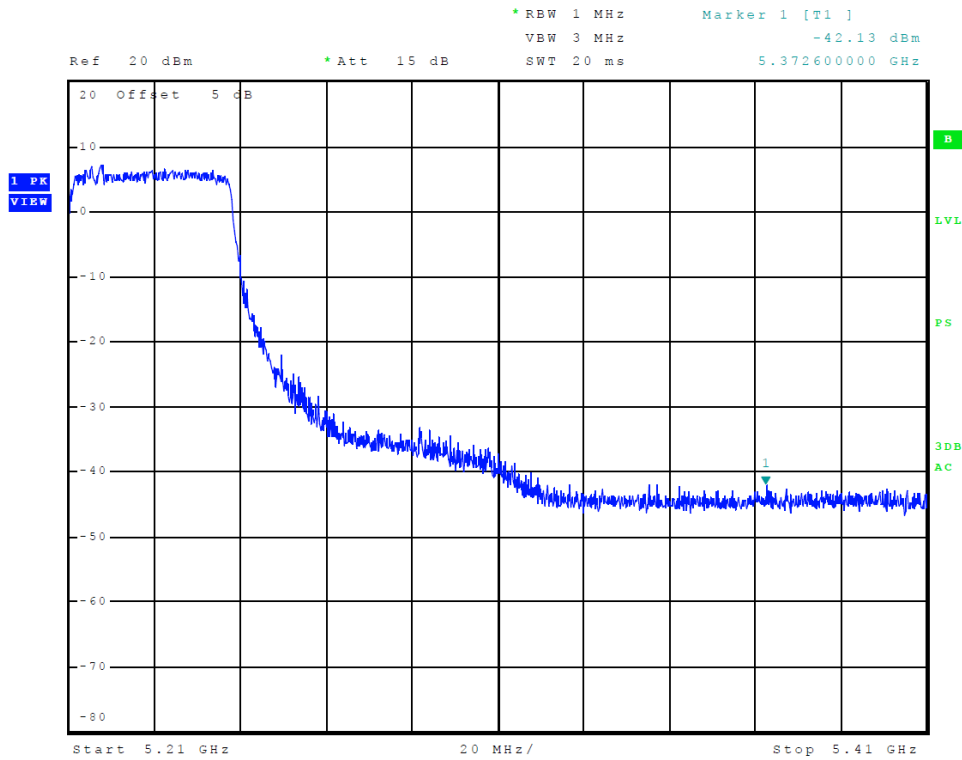

Figure 19 Plot of Transmitter High Band Edge (Chain 0, 5150-5250 MHz Band, 802.11ac80)

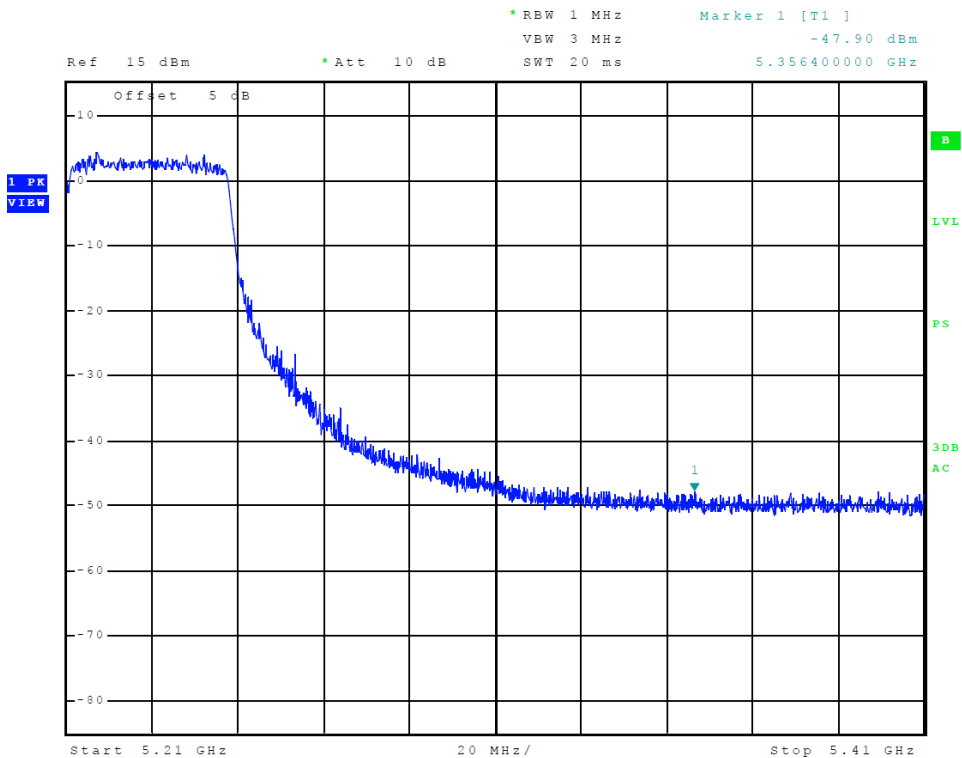

Figure 20 Plot of Transmitter High Band Edge (Chain 1, 5150-5250 MHz Band, 802.11ac80)

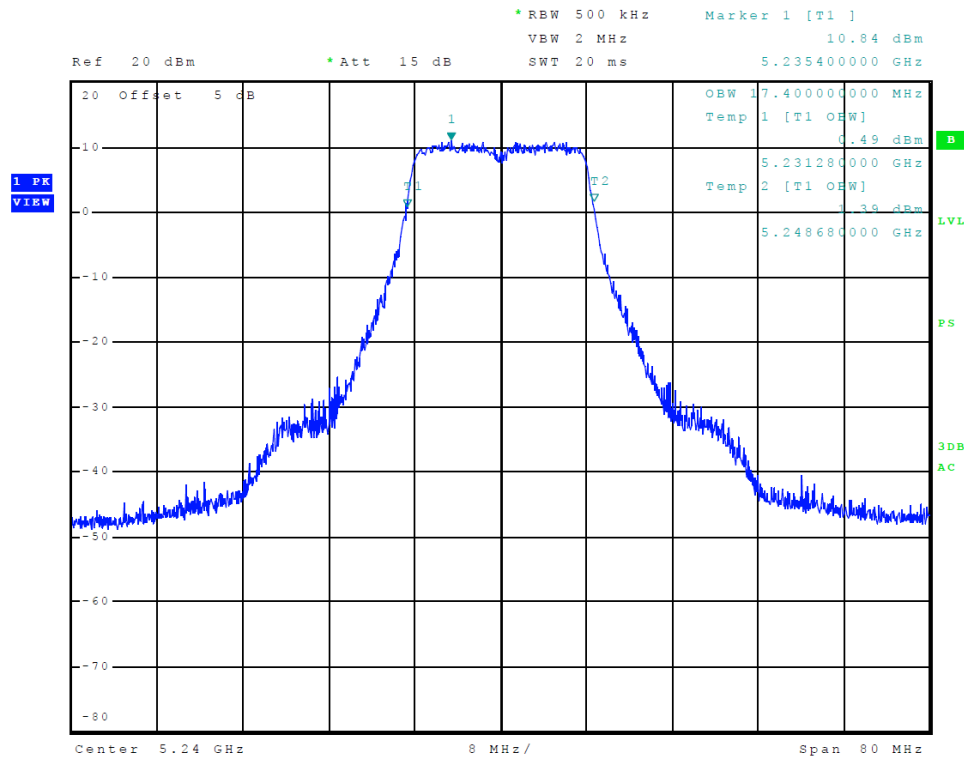

Figure 21 Plot of Transmitter Emissions (Chain 0, 5150-5250 MHz Band, 802.11a, 99% OBW)

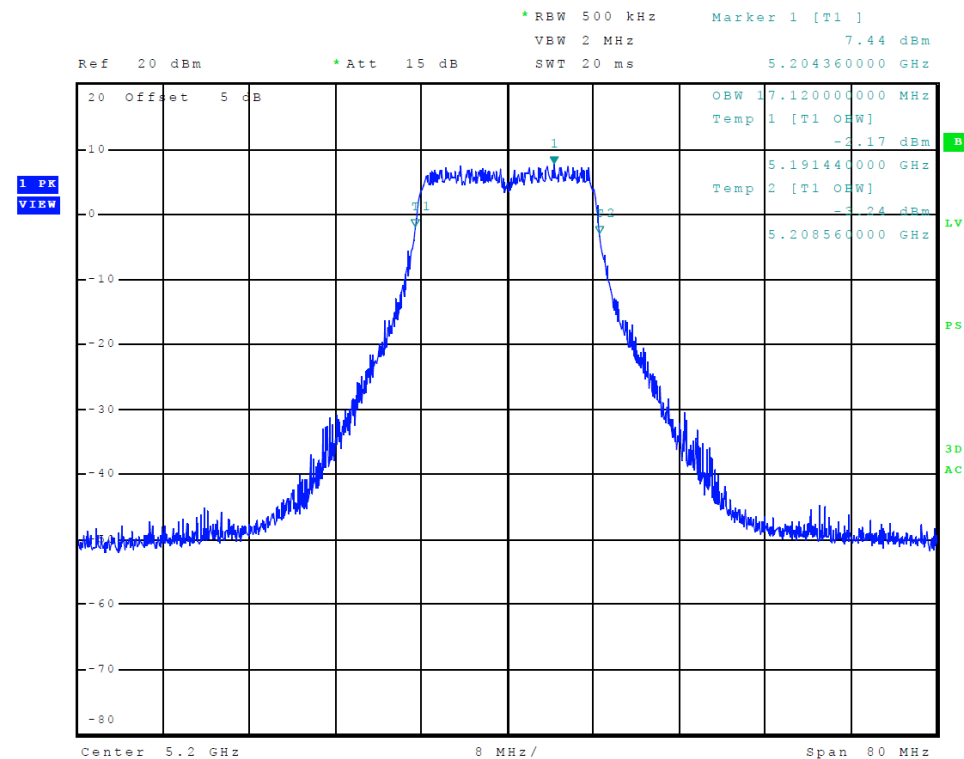

Figure 22 Plot of Transmitter Emissions (Chain 1, 5150-5250 MHz Band, 802.11a, 99% OBW)

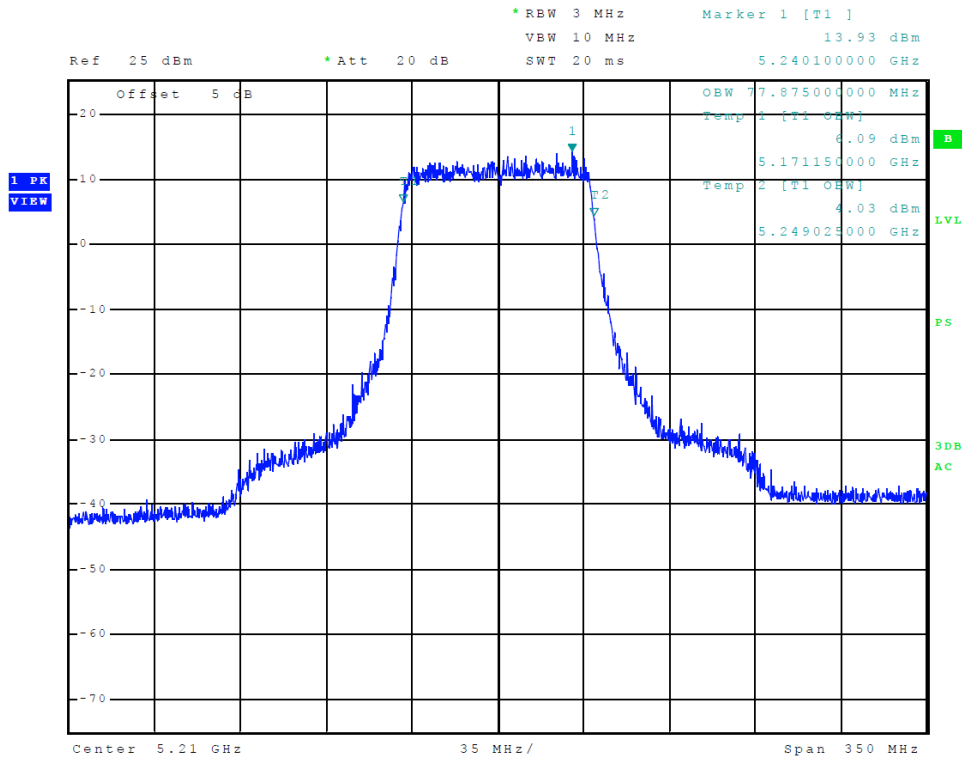

Figure 23 Plot of Transmitter Emissions (Chain 0, 5150-5250 MHz Band, 802.11ac, 99% OBW)

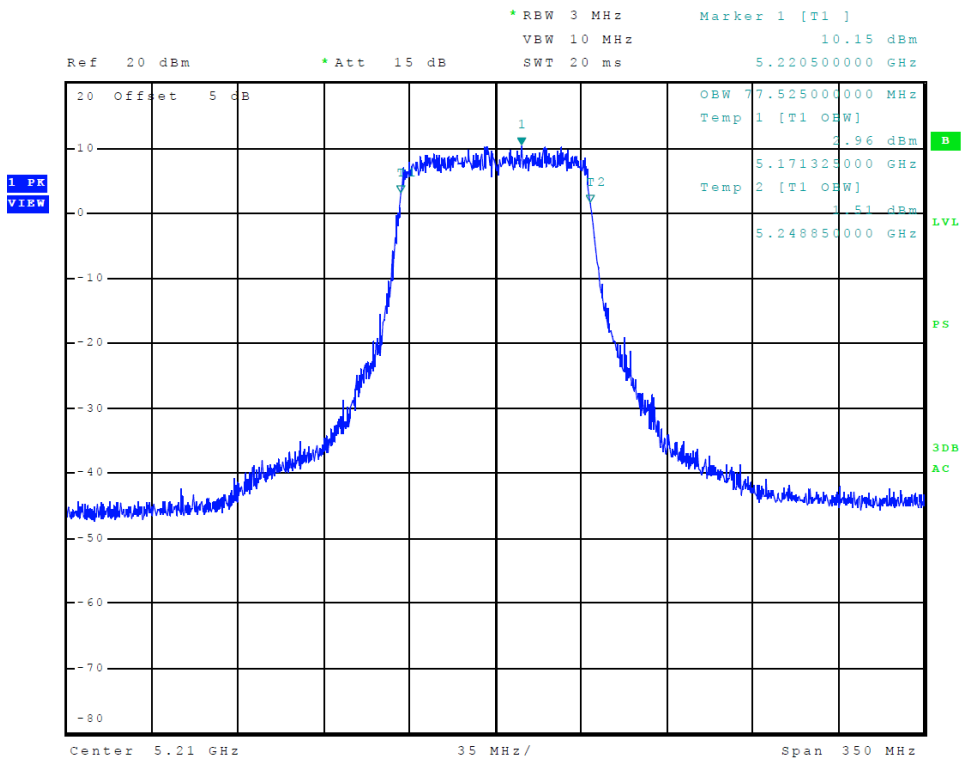

Figure 24 Plot of Transmitter Emissions (Chain 1, 5150-5250 MHz Band, 802.11ac, 99% OBW)

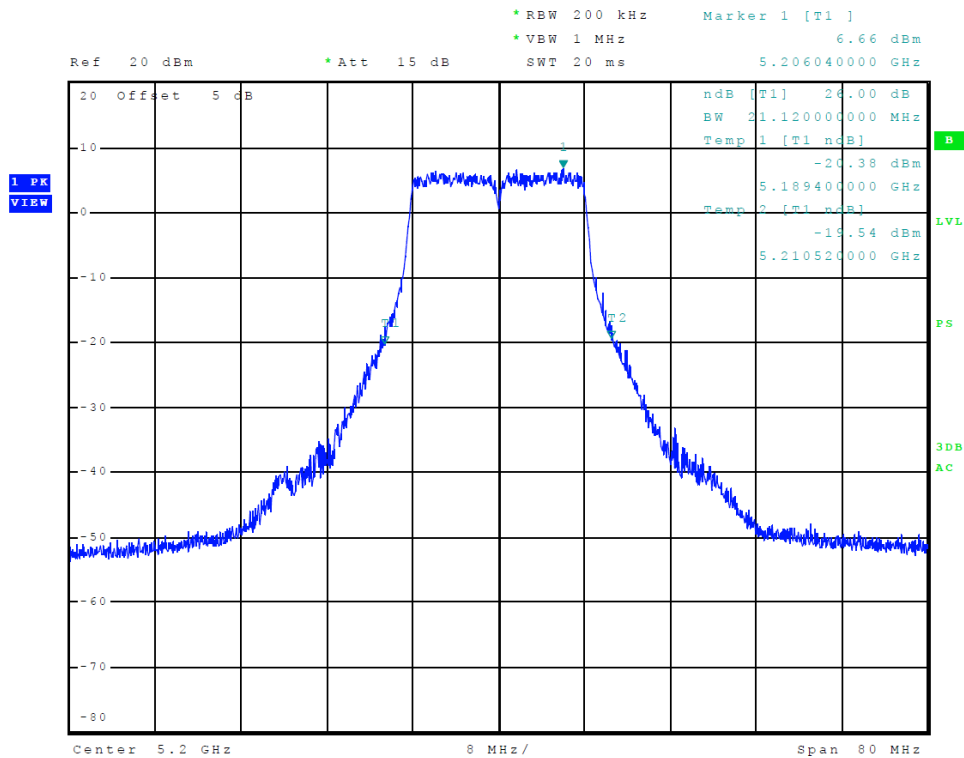

Figure 25 Plot of Transmitter Emissions (Chain 0, 5150-5250 MHz Band, 802.11a, 26 dB OBW)

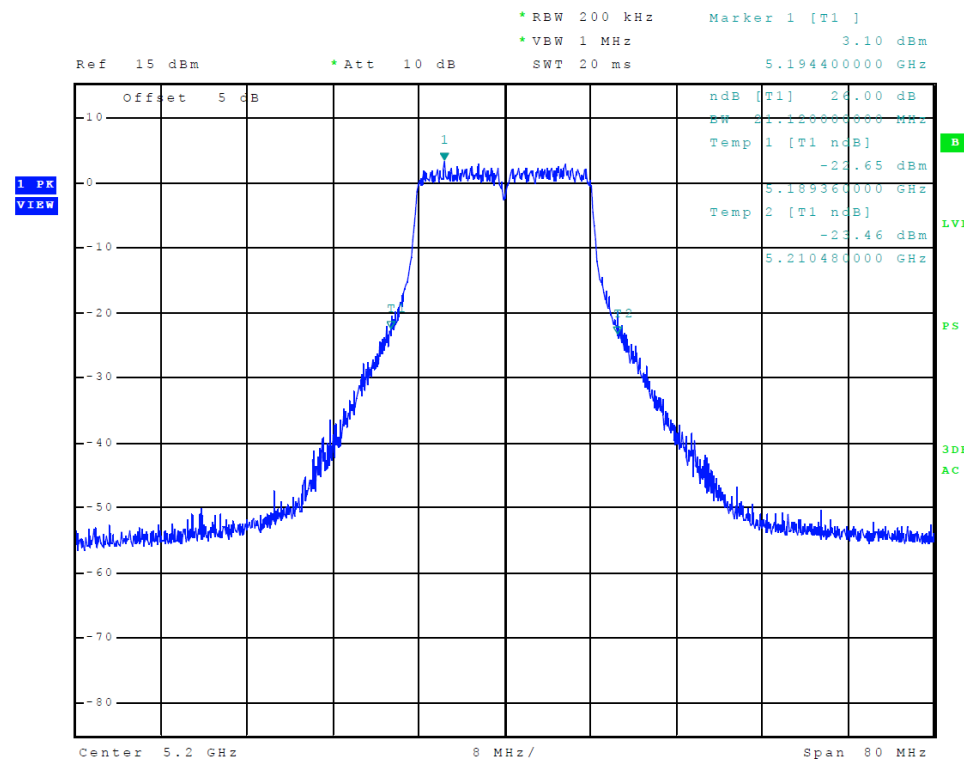

Figure 26 Plot of Transmitter Emissions (Chain 1, 5150-5250 MHz Band, 802.11a, 26 dB OBW)

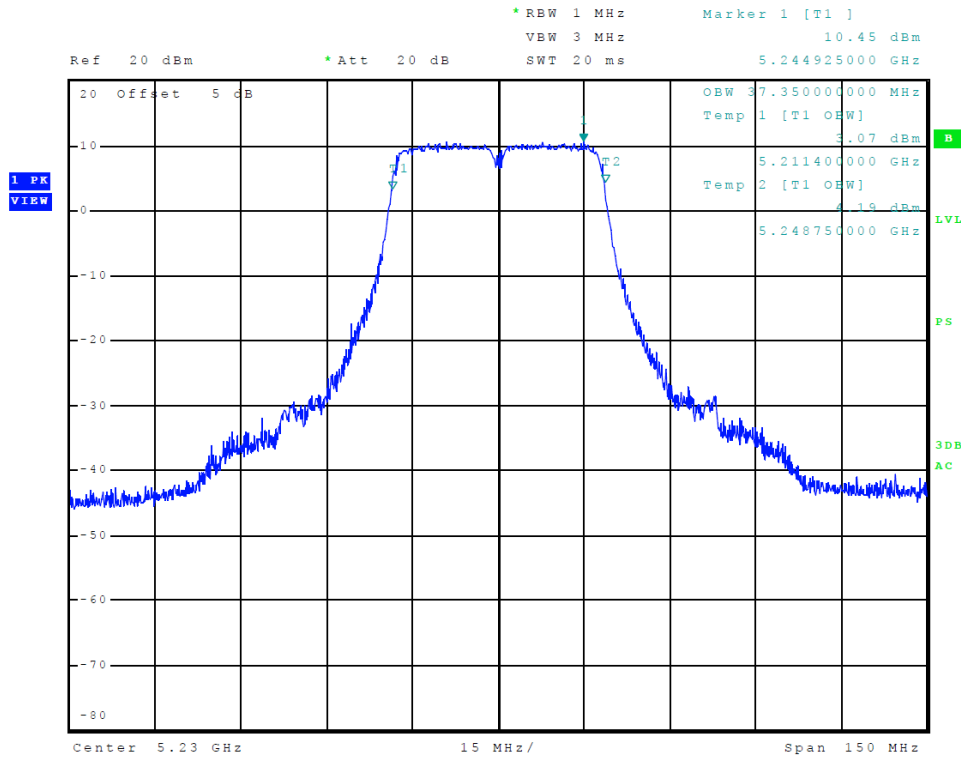

Figure 27 Plot of Transmitter Emissions (Chain 0, 5150-5250 MHz Band, 802.11n40, 99% OBW)

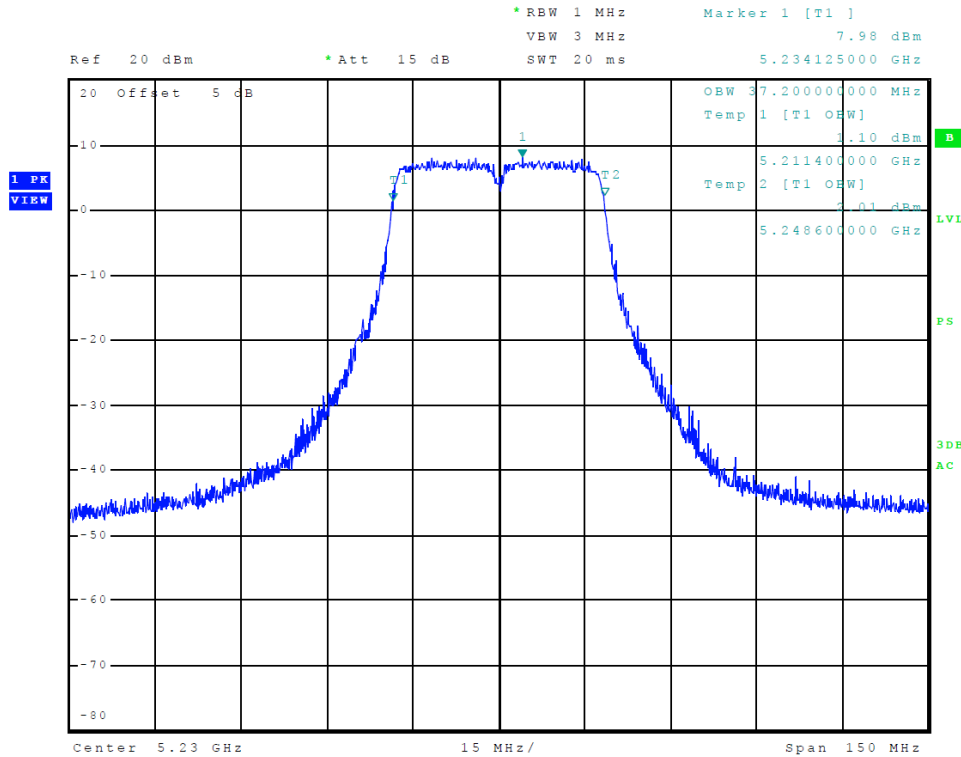

Figure 28 Plot of Transmitter Emissions (Chain 1, 5150-5250 MHz Band, 802.11n40, 99% OBW)

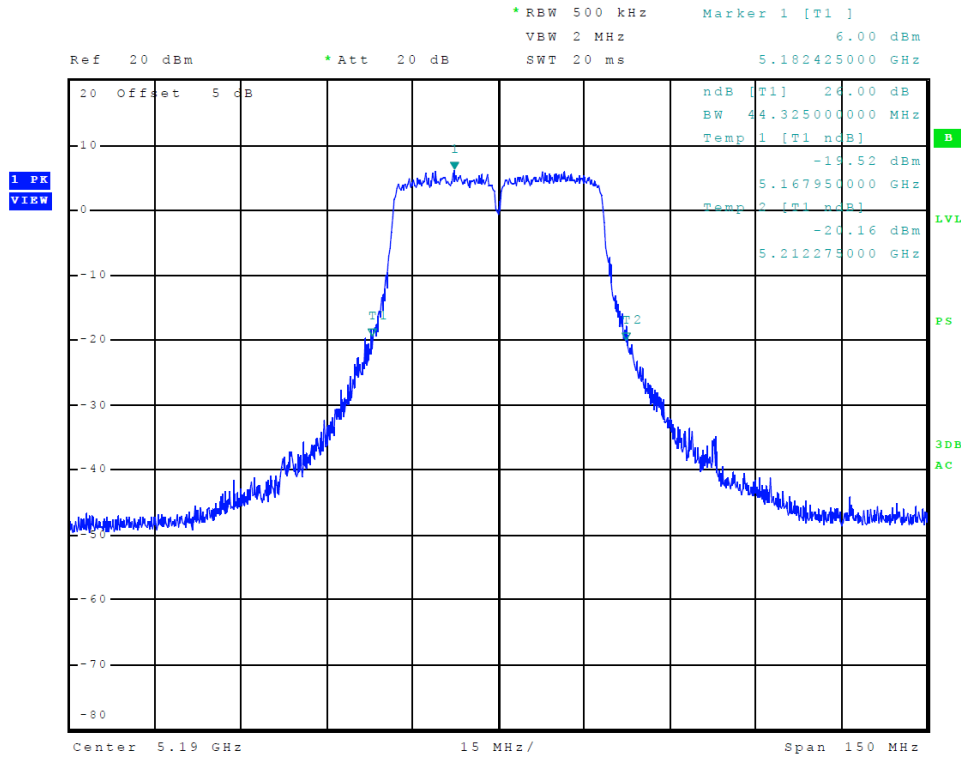

Figure 29 Plot of Transmitter Emissions (Chain 0, 5150-5250 MHz Band, 802.11n40, 26 dB OBW)

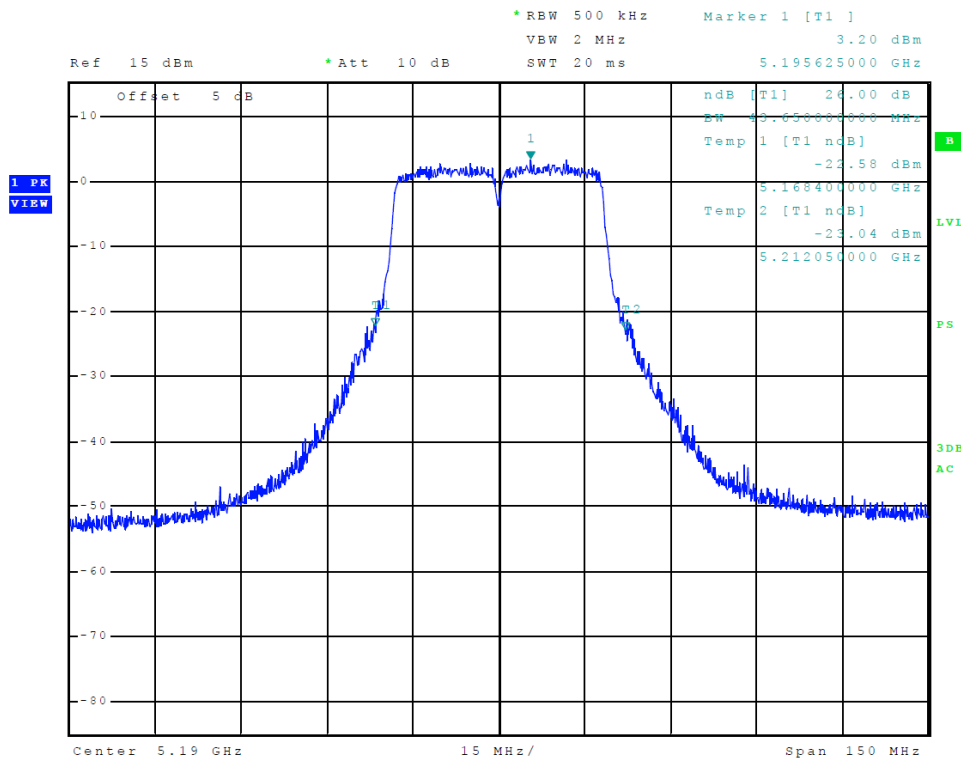

Figure 30 Plot of Transmitter Emissions (Chain 1, 5150-5250 MHz Band, 802.11n40, 26 dB OBW)

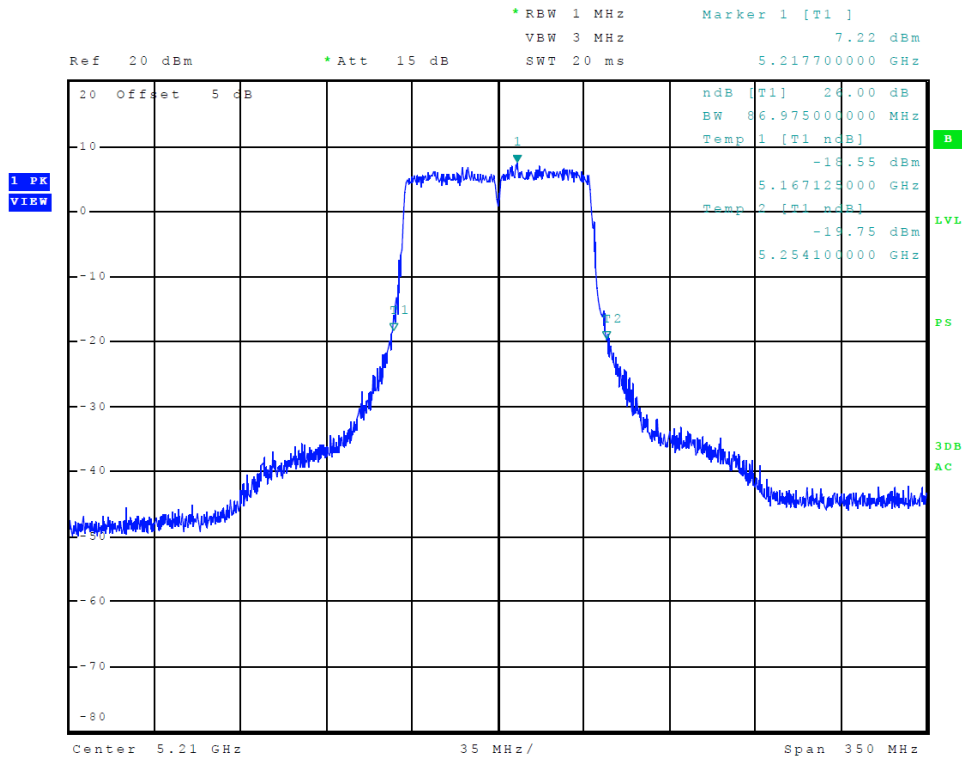

Figure 31 Plot of Transmitter Emissions (Chain 0, 5150-5250 MHz Band, 802.11ac, 26 dB OBW)

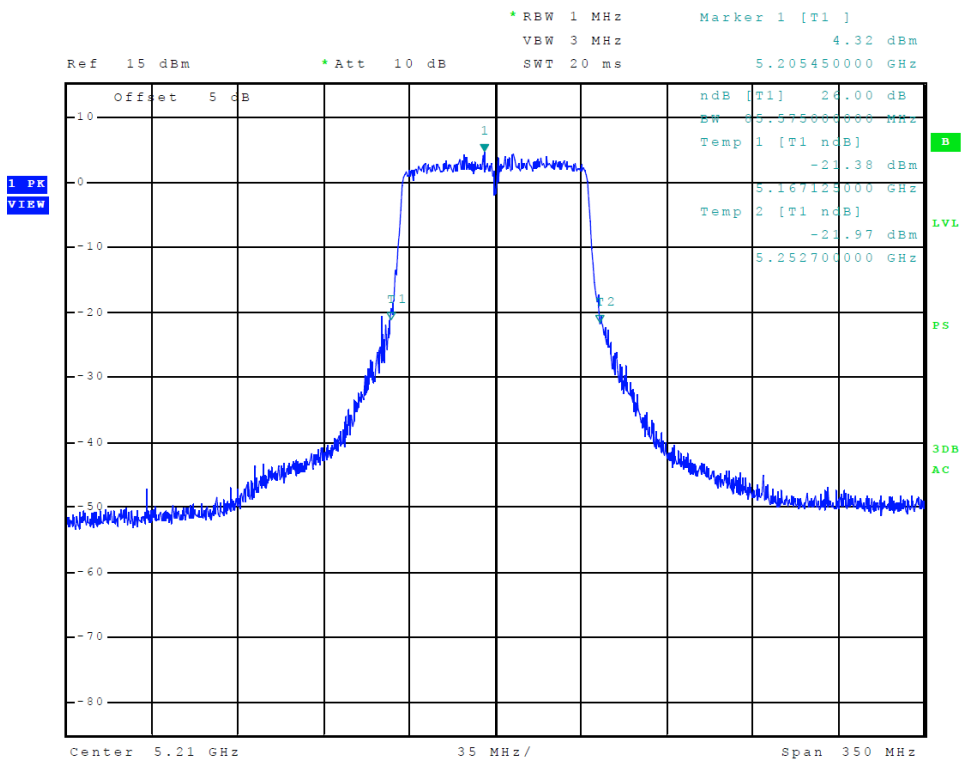

Figure 32 Plot of Transmitter Emissions (Chain 1, 5150-5250 MHz Band, 802.11ac, 26 dB OBW)

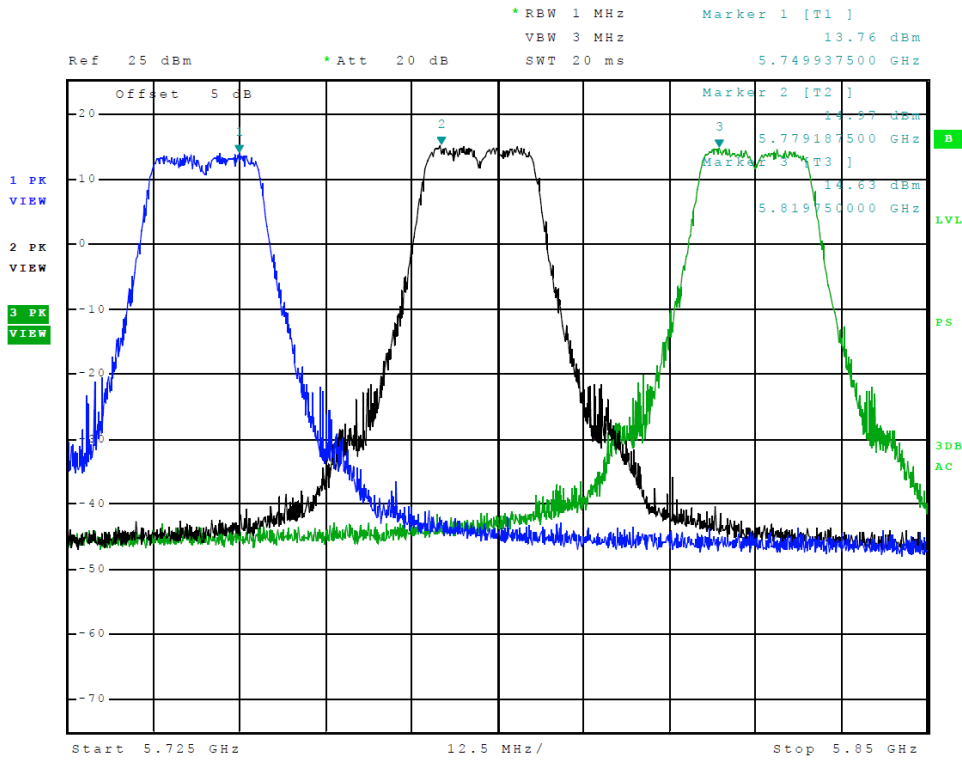

Figure 33 Plot of Transmitter Emissions (Chain 0, Across 5725-5850 MHz Band, 802.11a)

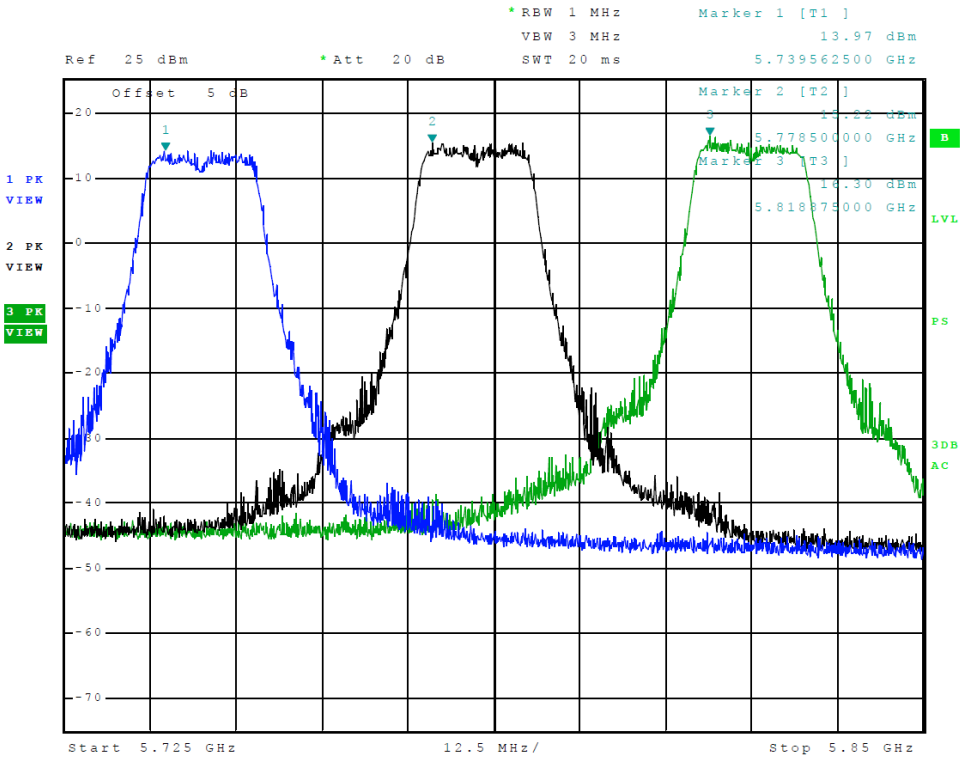

Figure 34 Plot of Transmitter Emissions (Chain 1, Across 5725-5850 MHz Band, 802.11a)

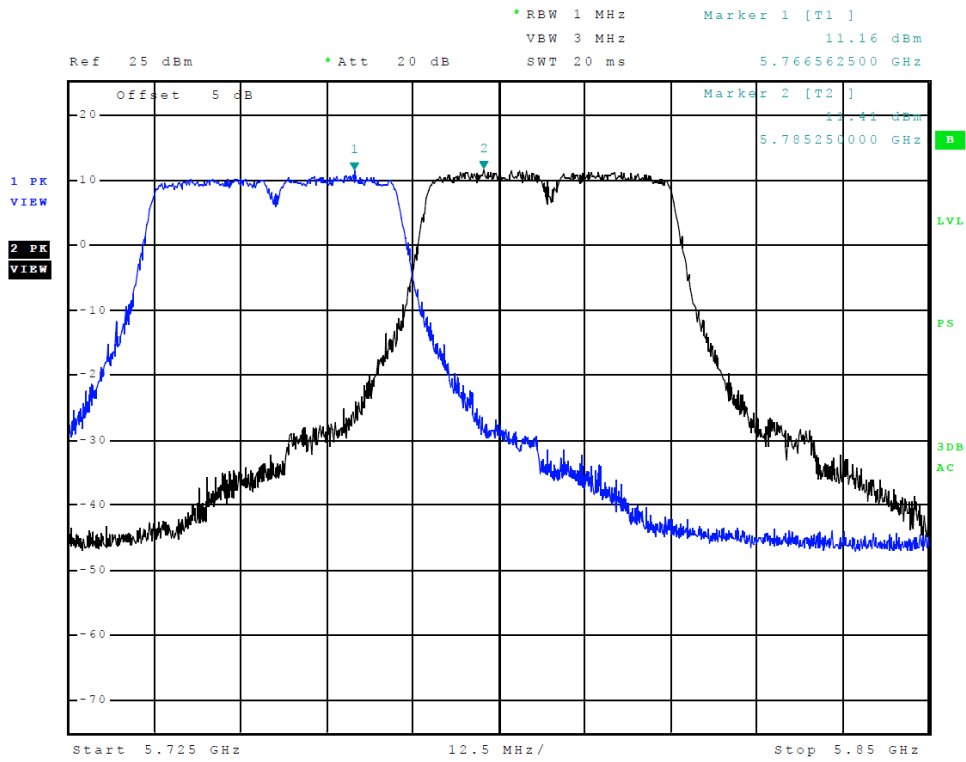

Figure 35 Plot of Transmitter Emissions (Chain 0, Across 5725-5850 MHz Band, 802.11n40)

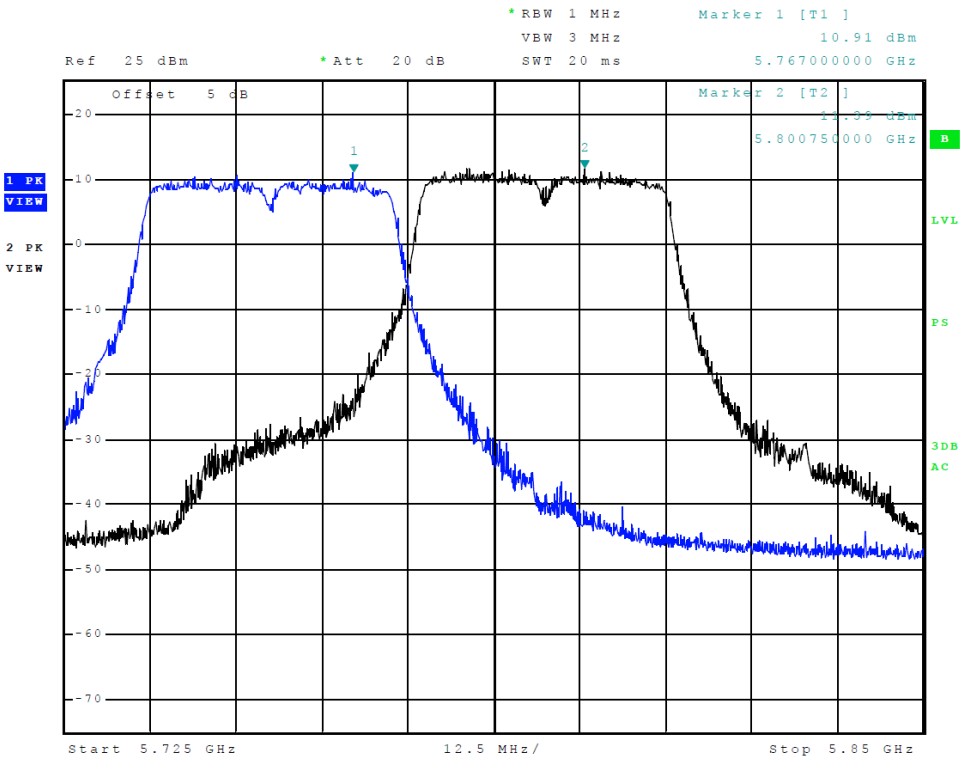

Figure 36 Plot of Transmitter Emissions (Chain 1, Across 5725-5850 MHz Band, 802.11n40)

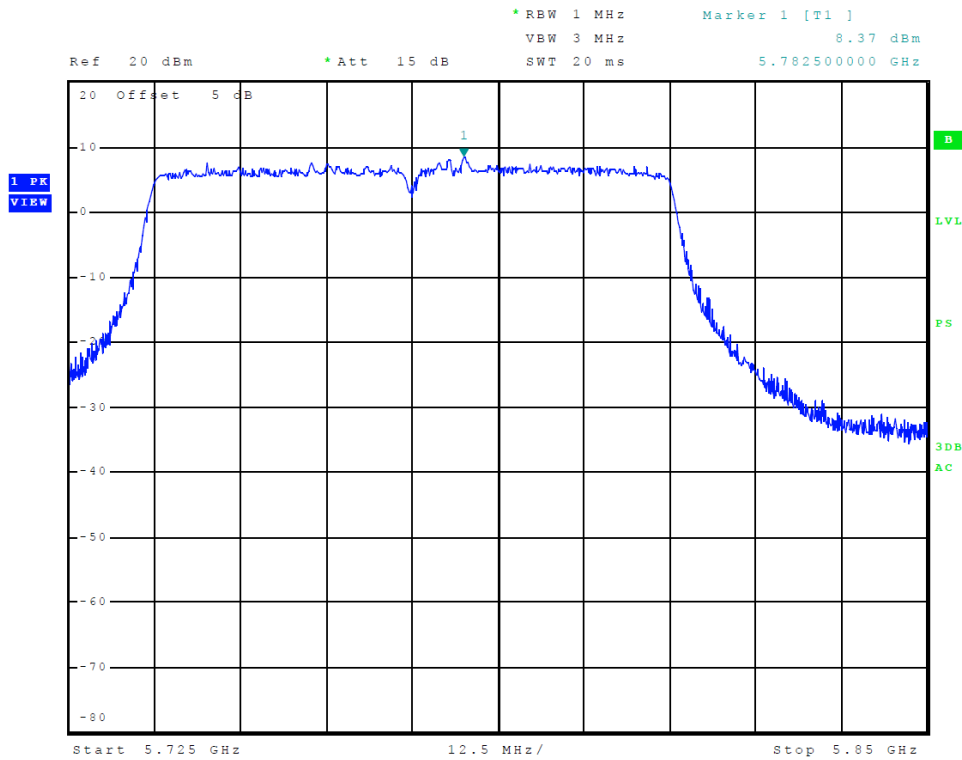

Figure 37 Plot of Transmitter Emissions (Chain 0, Across 5725-5850 MHz Band, 802.11ac80)

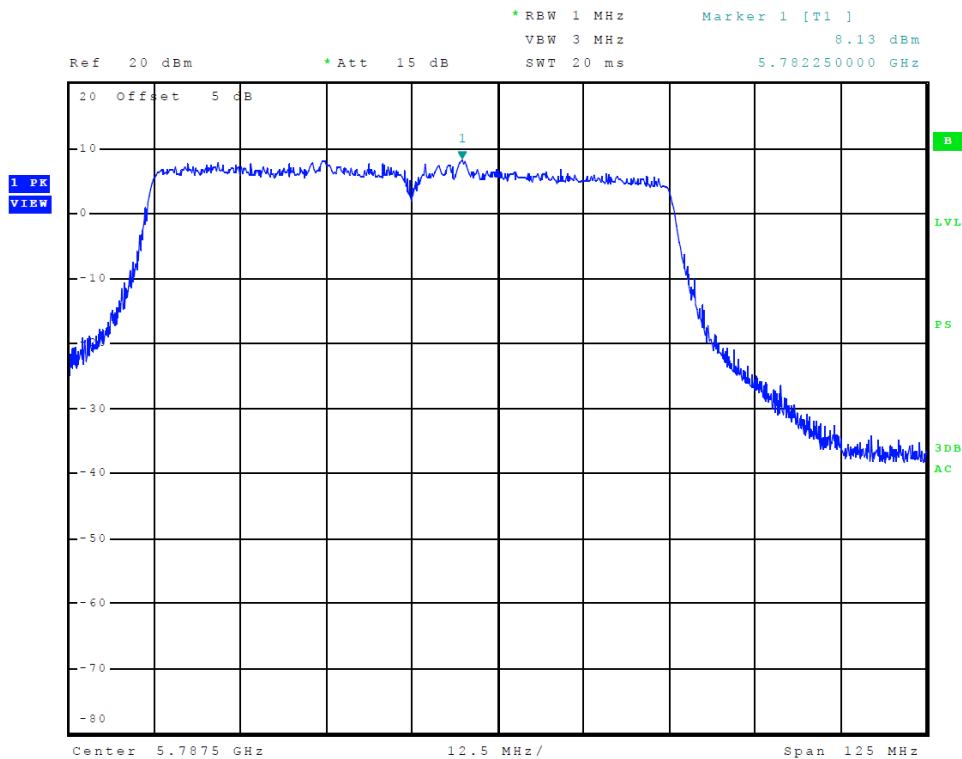

Figure 38 Plot of Transmitter Emissions (Chain 1, Across 5725-5850 MHz Band, 802.11ac80)

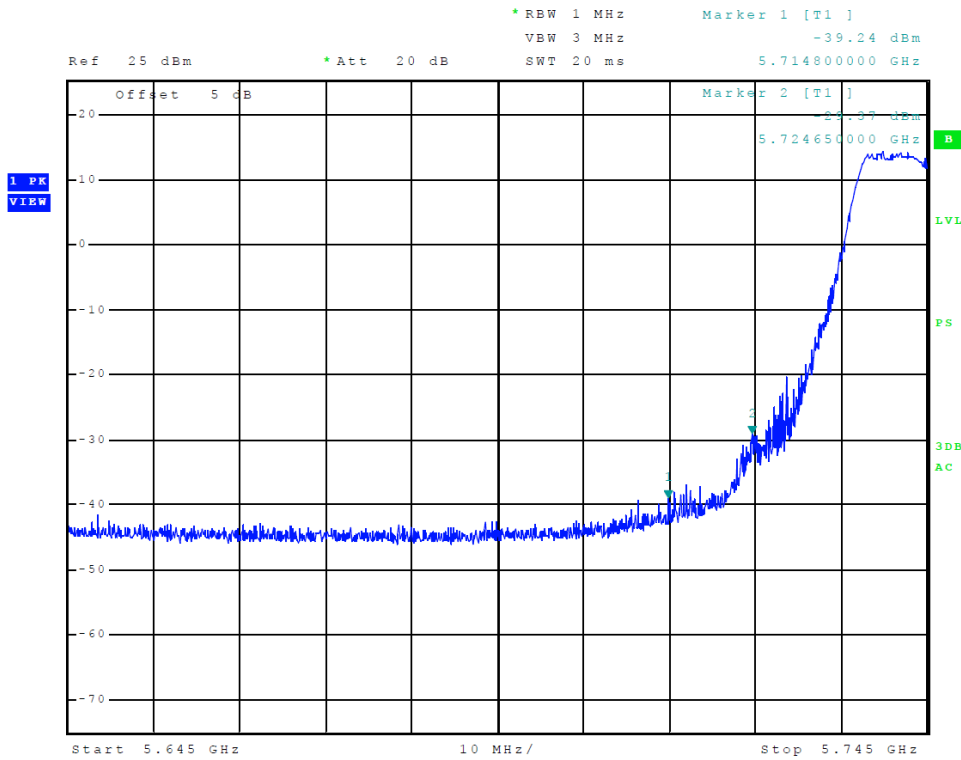

Figure 39 Plot of Transmitter Low Band Edge (Chain 0, 5725-5850 MHz Band, 802.11a)

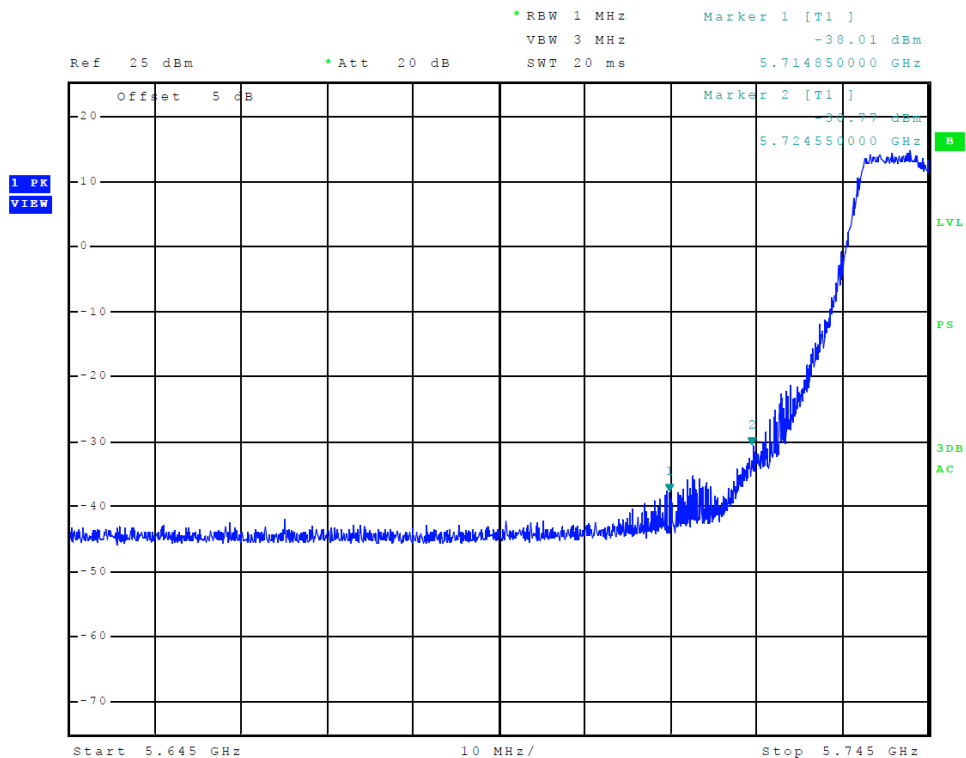

Figure 40 Plot of Transmitter Low Band Edge (Chain 1, 5725-5850 MHz Band, 802.11a)

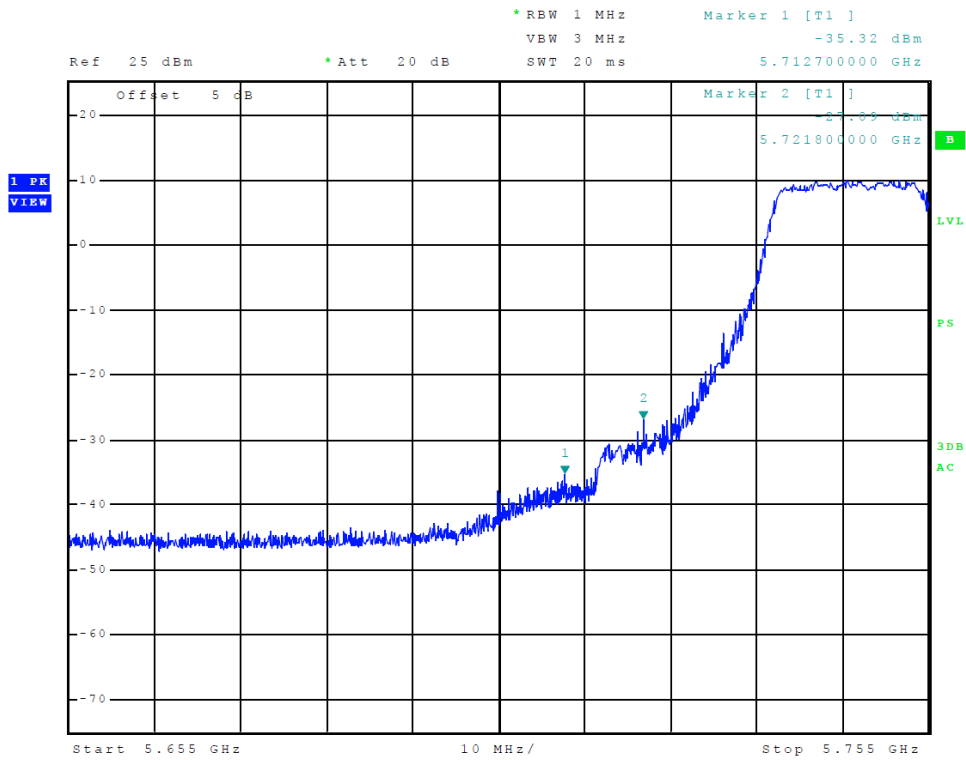

Figure 41 Plot of Transmitter Low Band Edge (Chain 0, 5725-5850 MHz Band, 802.11n40)

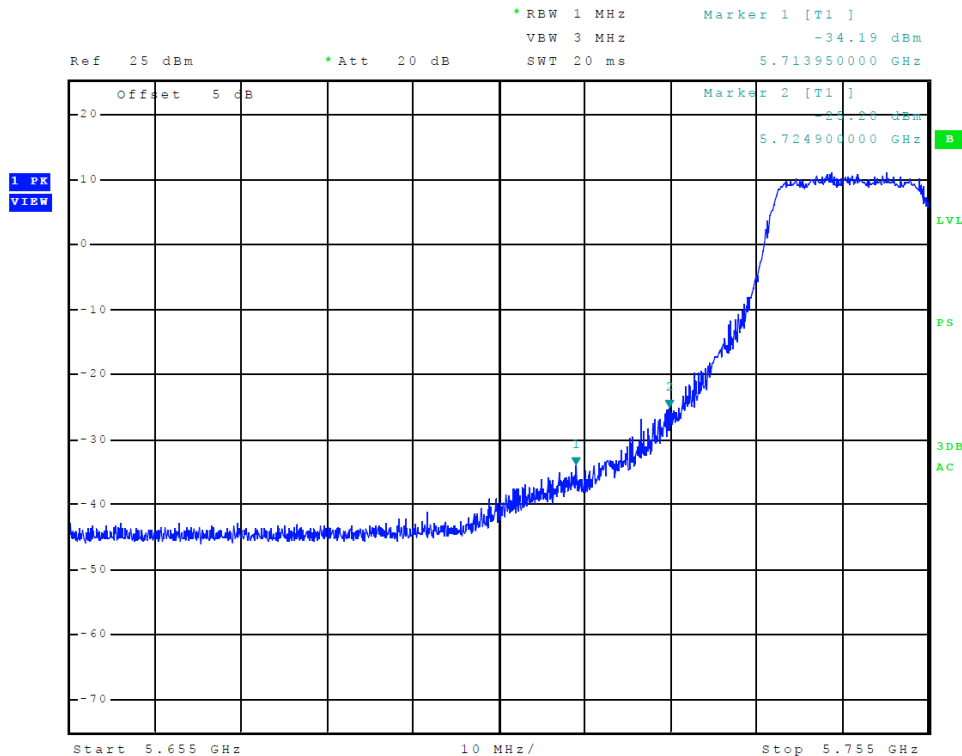

Figure 42 Plot of Transmitter Low Band Edge (Chain 1, 5725-5850 MHz Band, 802.11n40)

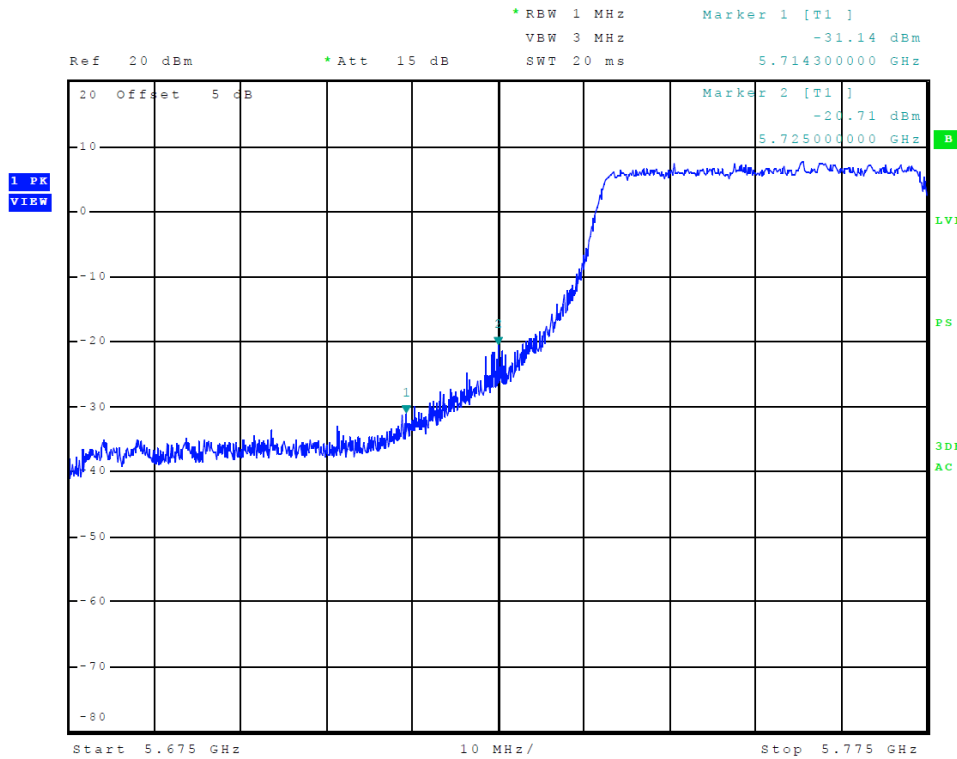

Figure 43 Plot of Transmitter Low Band Edge (Chain 0, 5725-5850 MHz Band, 802.11ac80)

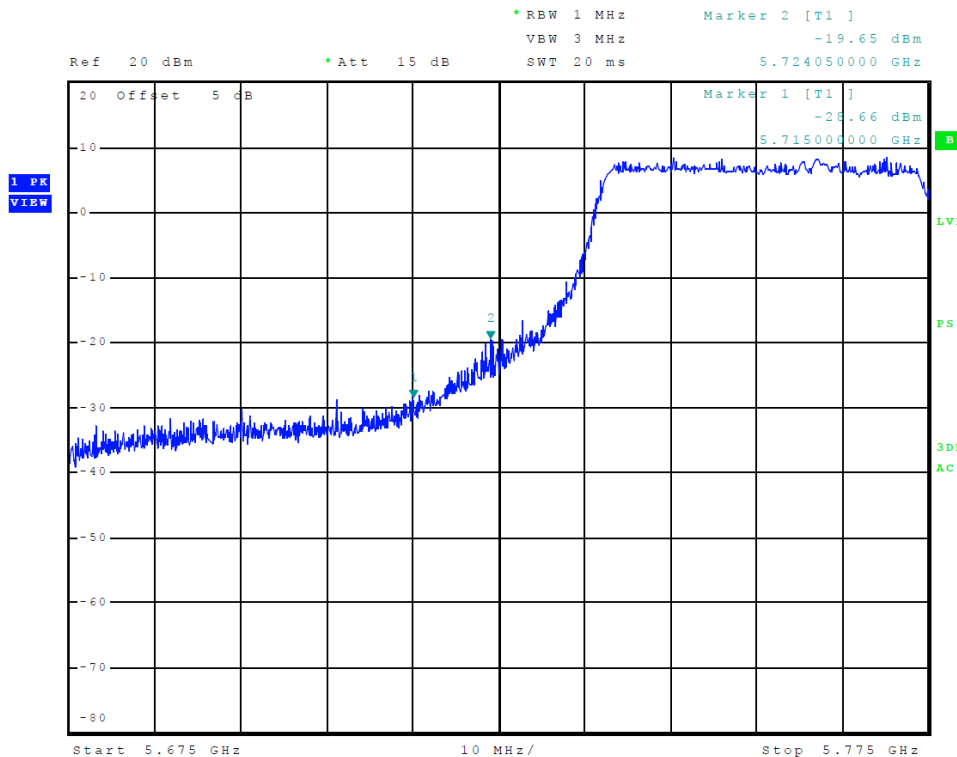

Figure 44 Plot of Transmitter Low Band Edge (Chain 1, 5725-5850 MHz Band, 802.11ac80)

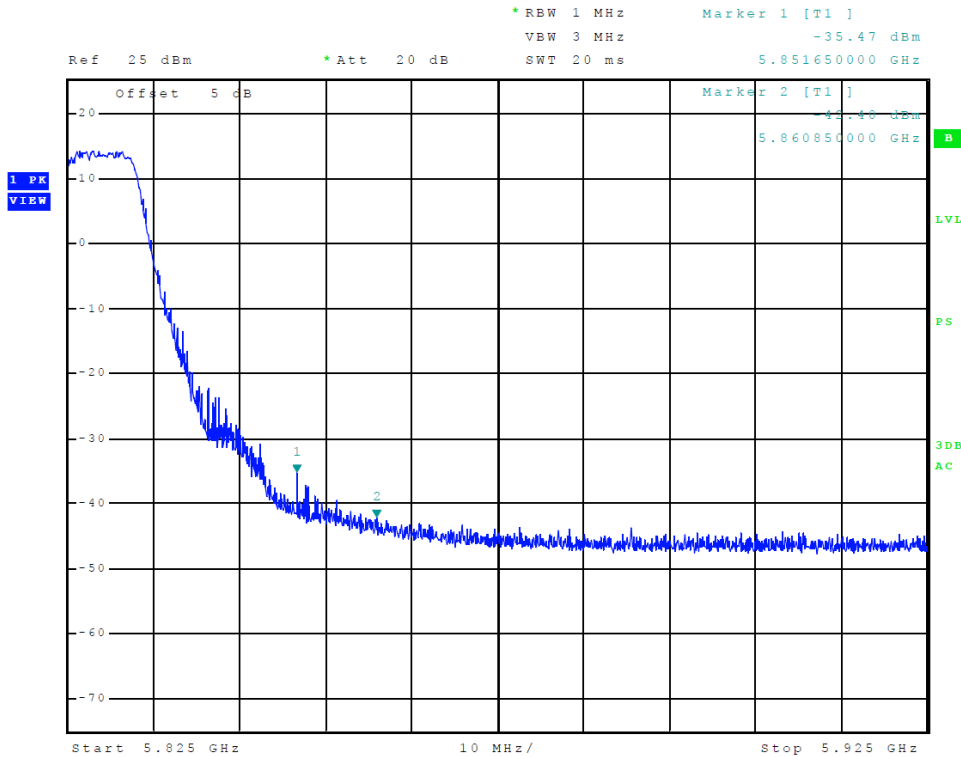

Figure 45 Plot of Transmitter High Band Edge (Chain 0, 5725-5850 MHz Band, 802.11a)

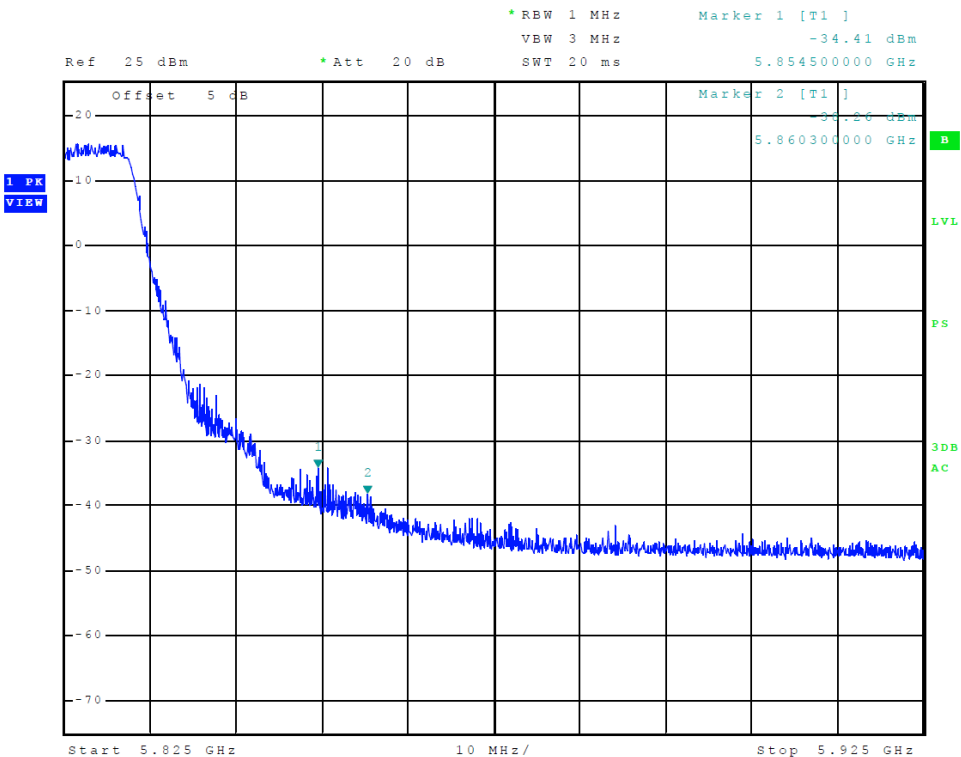

Figure 46 Plot of Transmitter High Band Edge (Chain 1, 5725-5850 MHz Band, 802.11a)

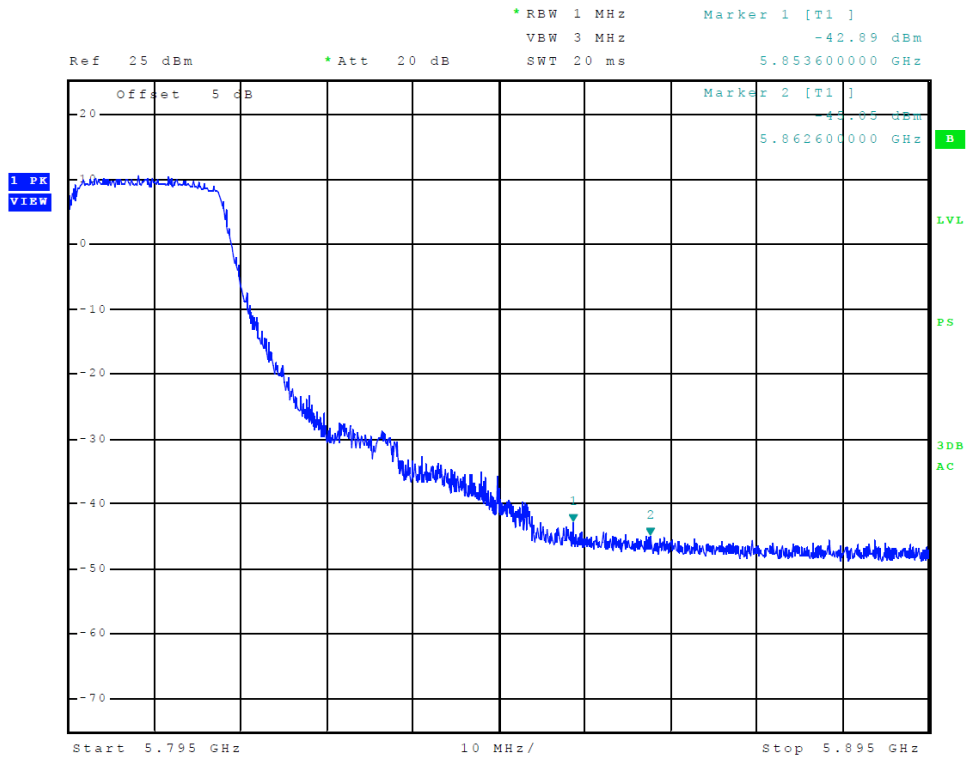

Figure 47 Plot of Transmitter High Band Edge (Chain 0, 5725-5850 MHz Band, 802.11n40)

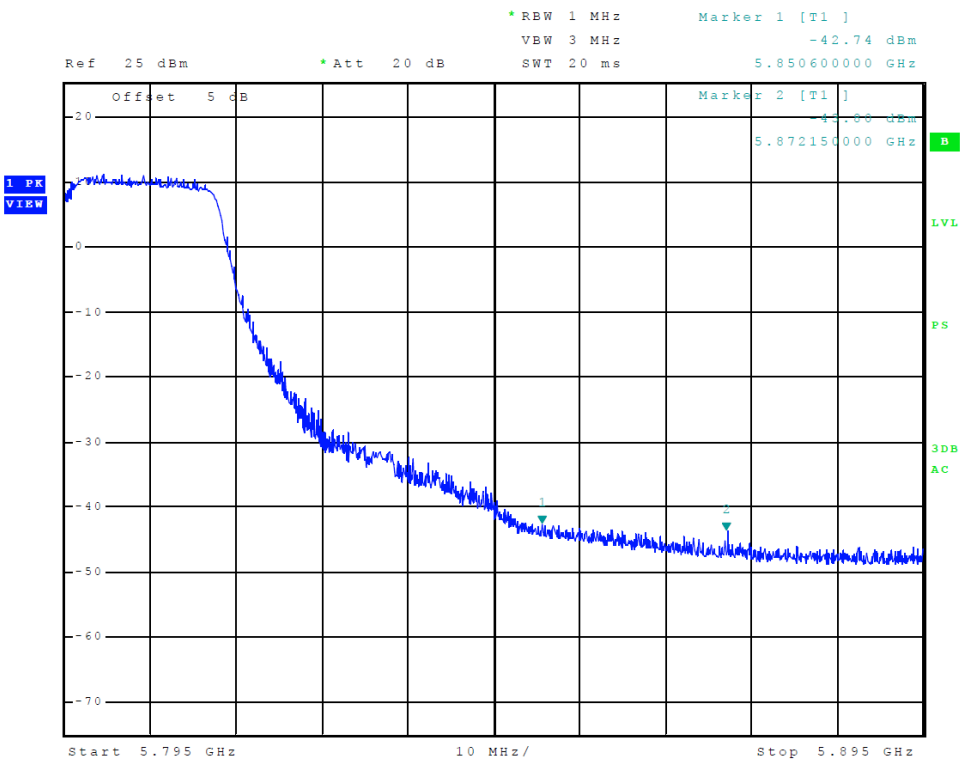

Figure 48 Plot of Transmitter High Band Edge (Chain 1, 5725-5850 MHz Band, 802.11n40)

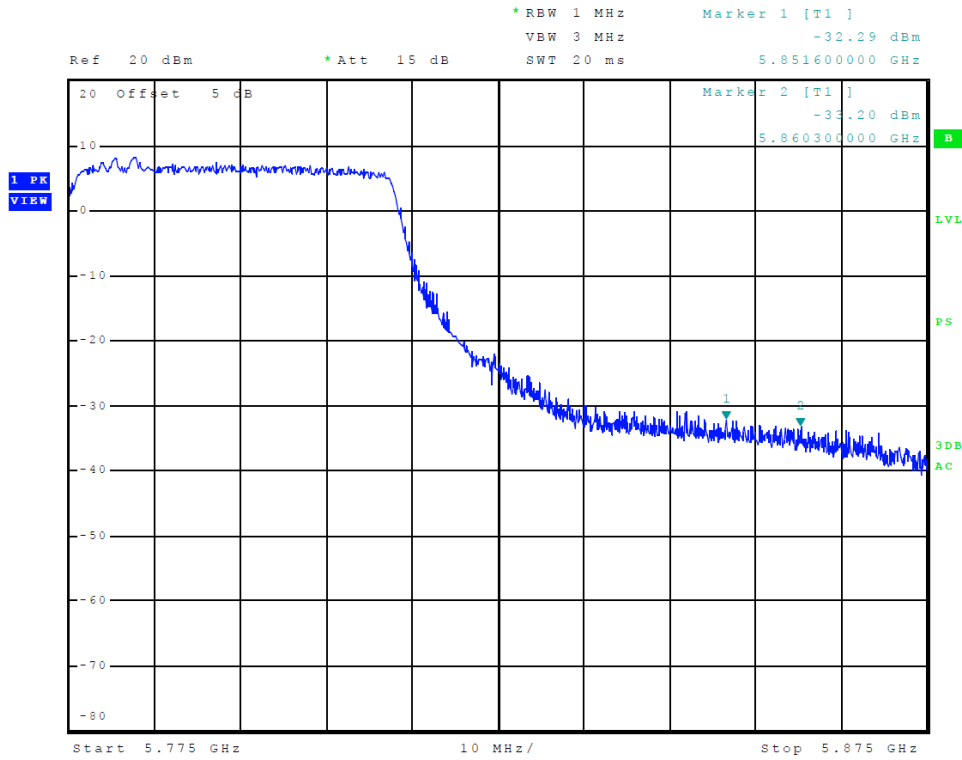

Figure 49 Plot of Transmitter High Band Edge (Chain 0, 5725-5850 MHz Band, 802.11ac80)

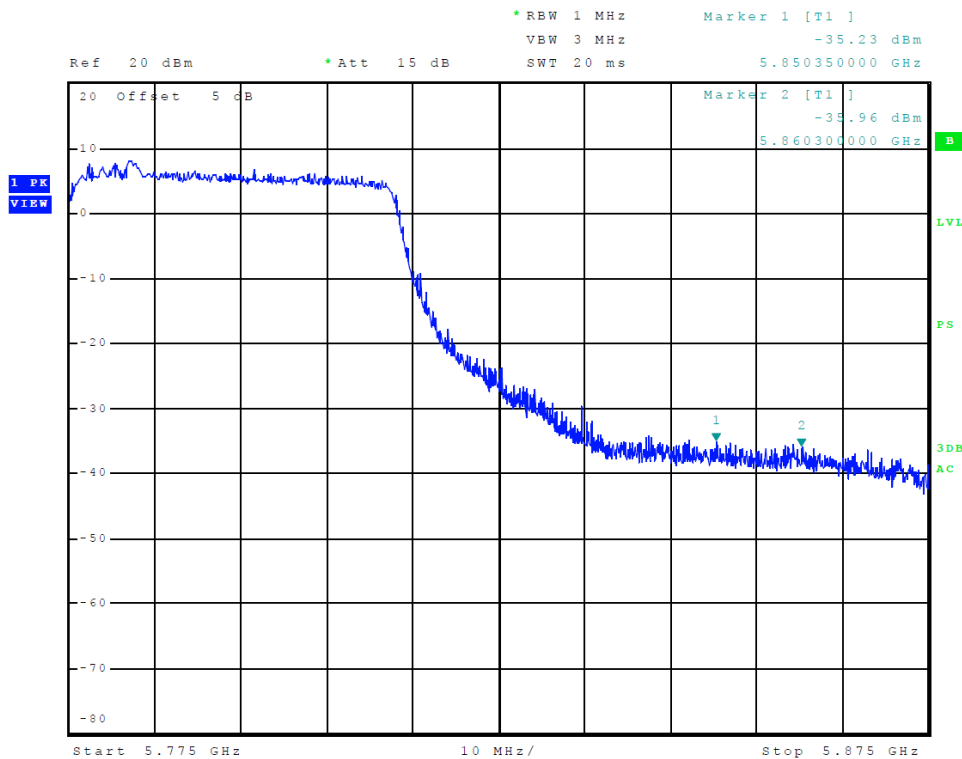

Figure 50 Plot of Transmitter High Band Edge (Chain 1, 5725-5850 MHz Band, 802.11ac80)

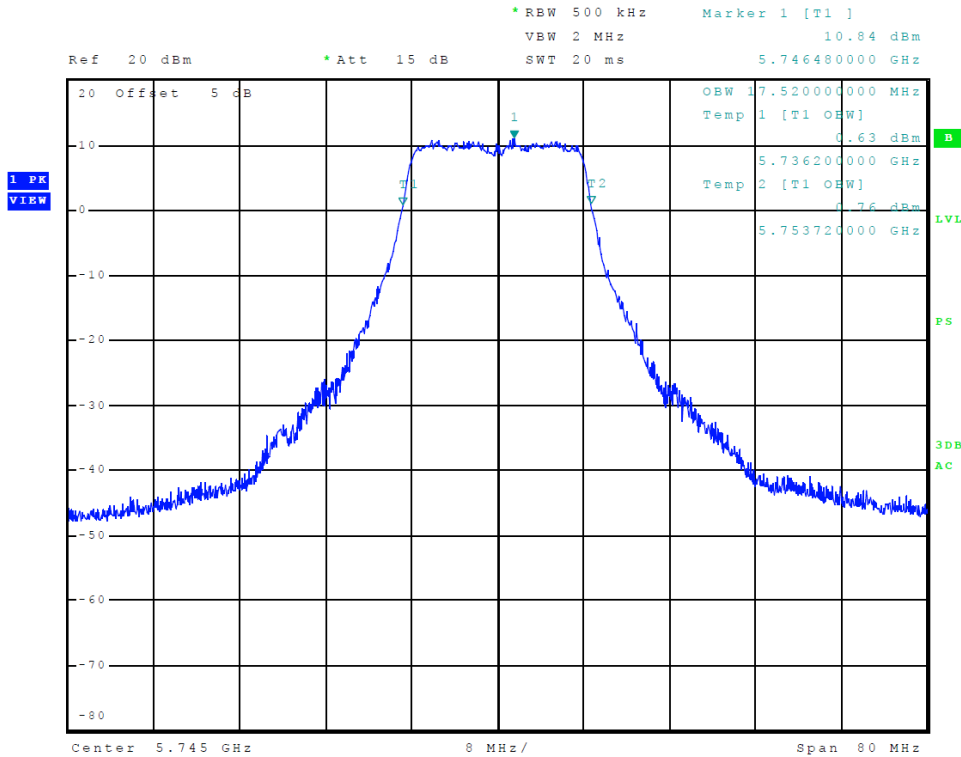

Figure 51 Plot of Transmitter Emissions (Chain 0, 5725-5850 MHz Band, 802.11a, 99% OBW)

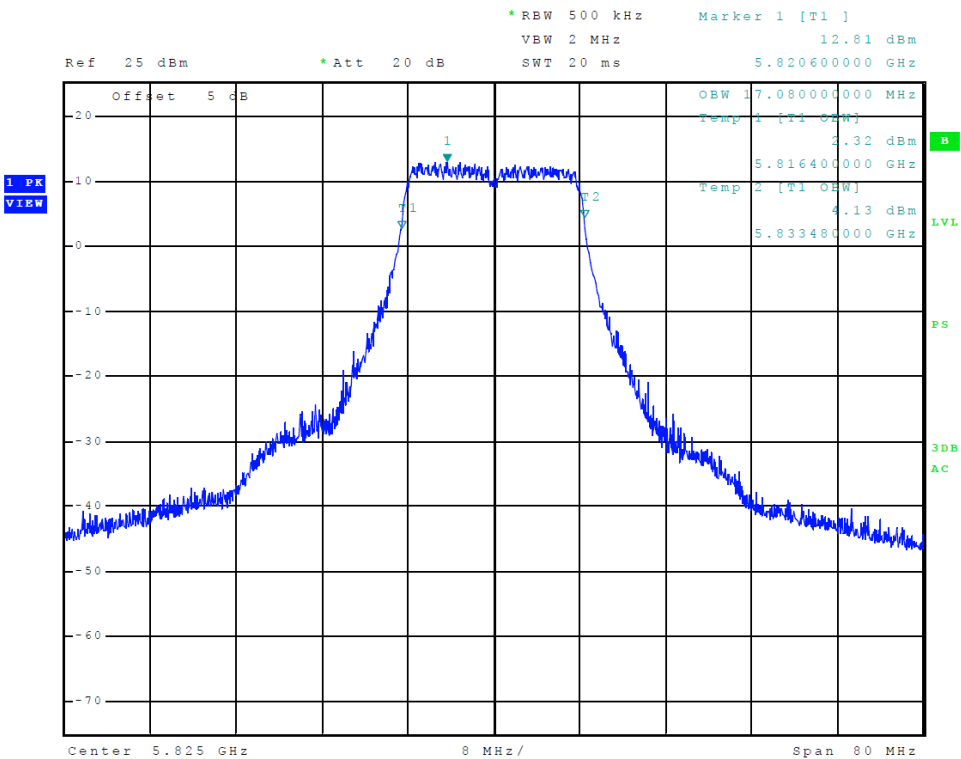

Figure 52 Plot of Transmitter Emissions (Chain 1, 5725-5850 MHz Band, 802.11a, 99% OBW)

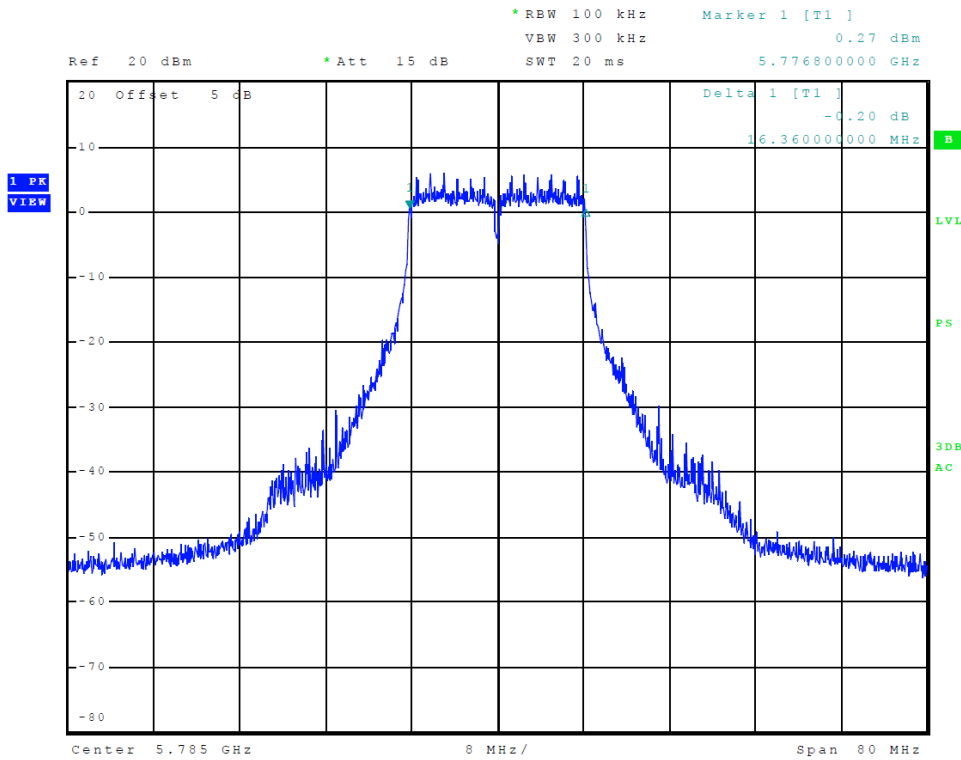

Figure 53 Plot of Transmitter Emissions (Chain 0, 5725-5850 MHz Band, 802.11a, 6-dB OBW)

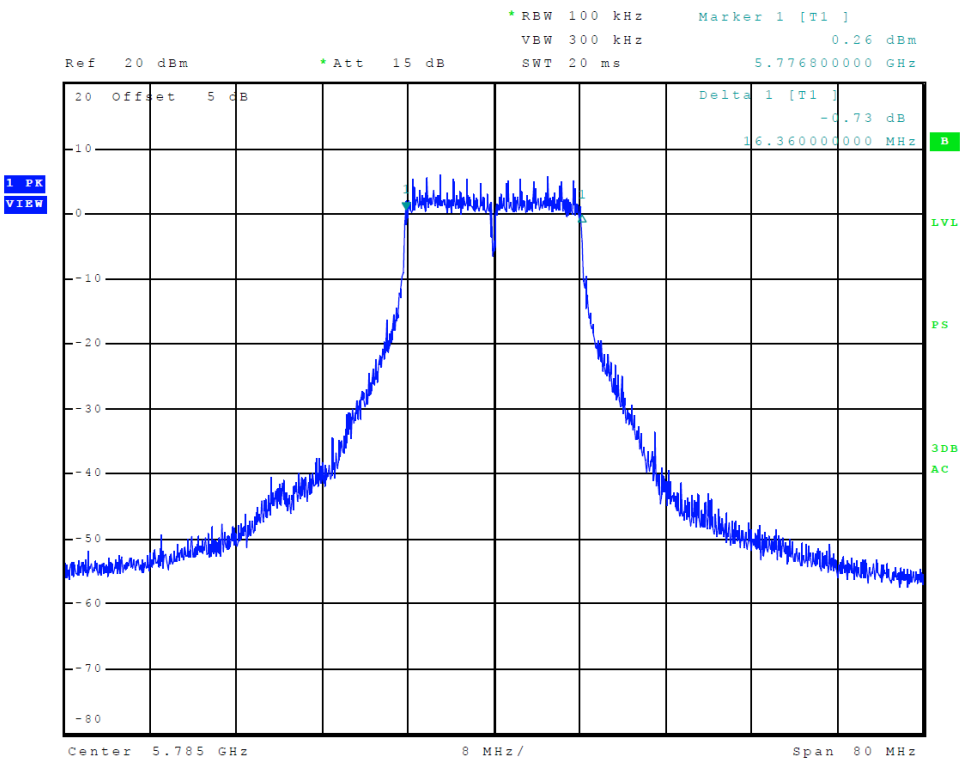

Figure 54 Plot of Transmitter Emissions (Chain 1, 5725-5850 MHz Band, 802.11a, 6-dB OBW)

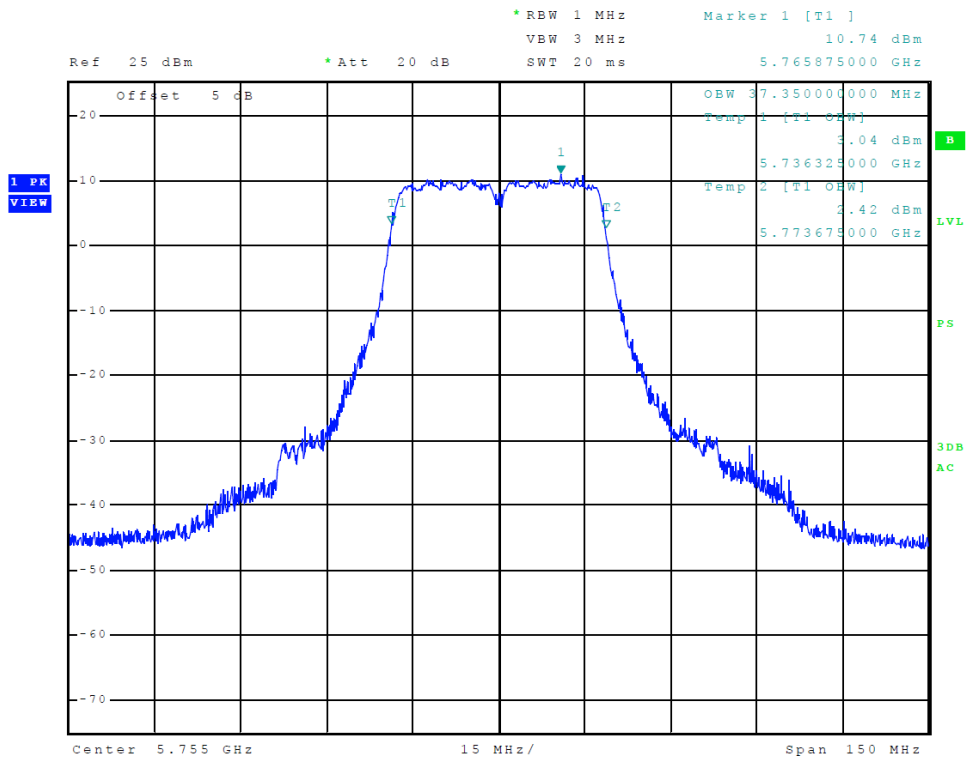

Figure 55 Plot of Transmitter Emissions (Chain 0, 5725-5850 MHz Band, 802.11n40, 99% OBW)

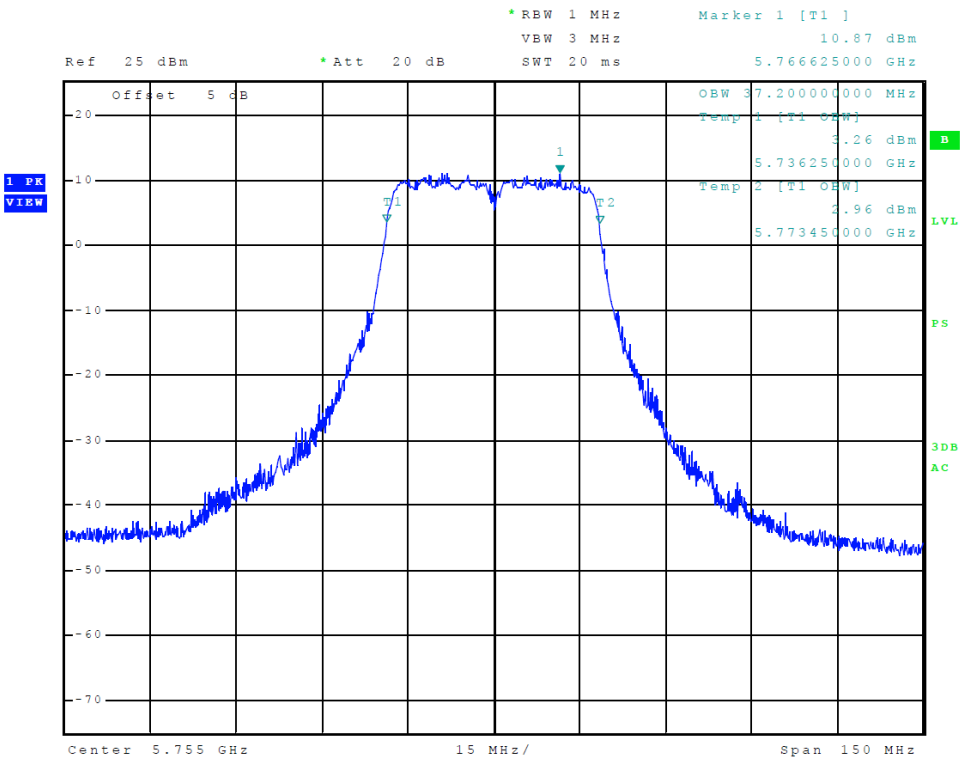

Figure 56 Plot of Transmitter Emissions (Chain 1, 5725-5850 MHz Band, 802.11n40, 99% OBW)

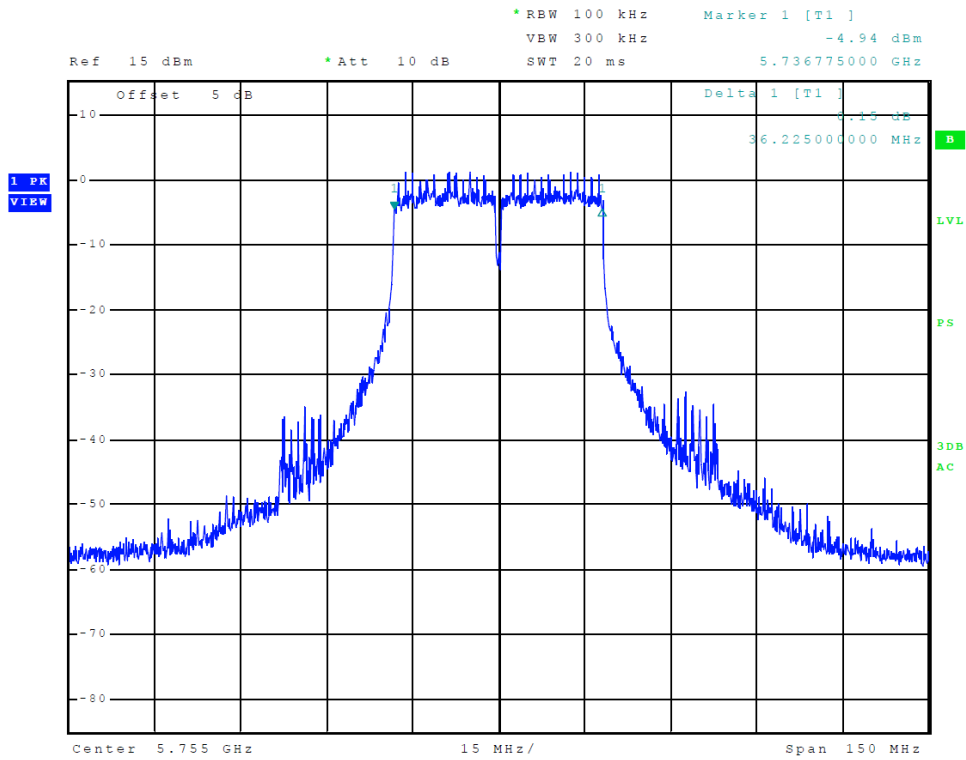

Figure 57 Plot of Transmitter Emissions (Chain 0, 5725-5850 MHz Band, 802.11n40, 6-dB OBW)

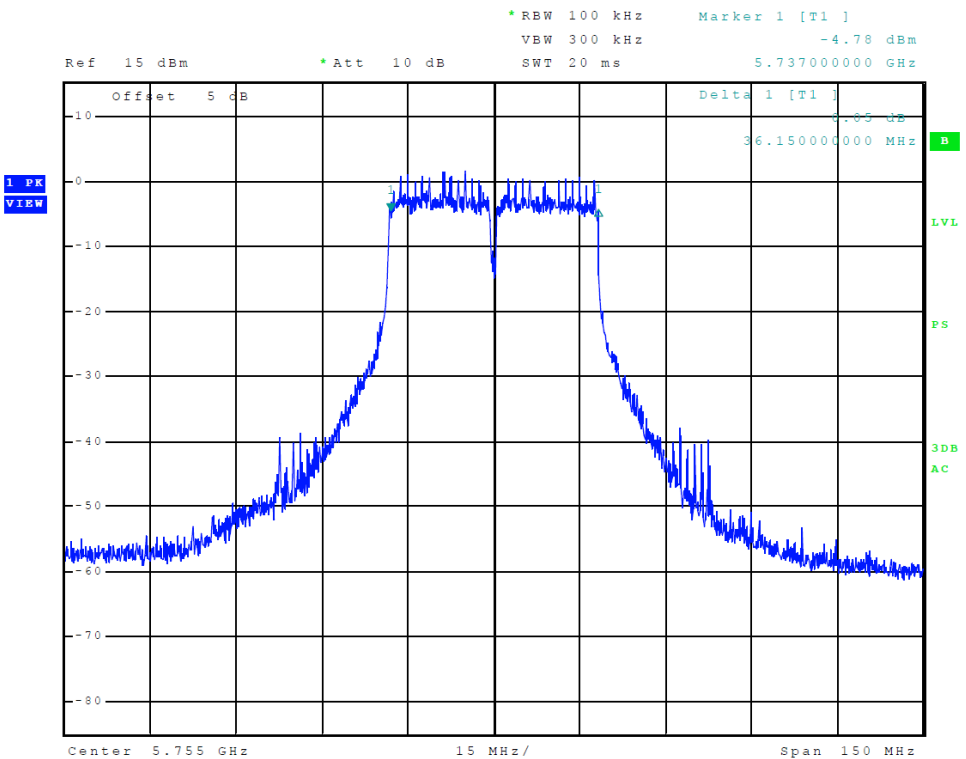

Figure 58 Plot of Transmitter Emissions (Chain 1, 5725-5850 MHz Band, 802.11n40, 6-dB OBW)

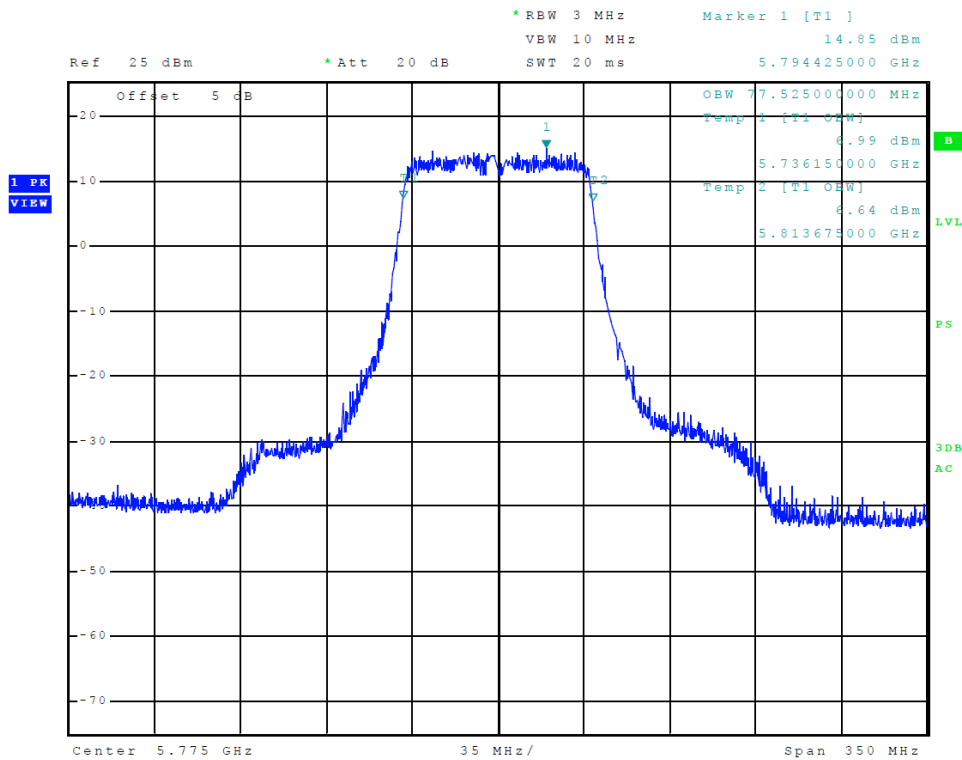

Figure 59 Plot of Transmitter Emissions (Chain 0, 5725-5850 MHz Band, 802.11ac80, 99% OBW)

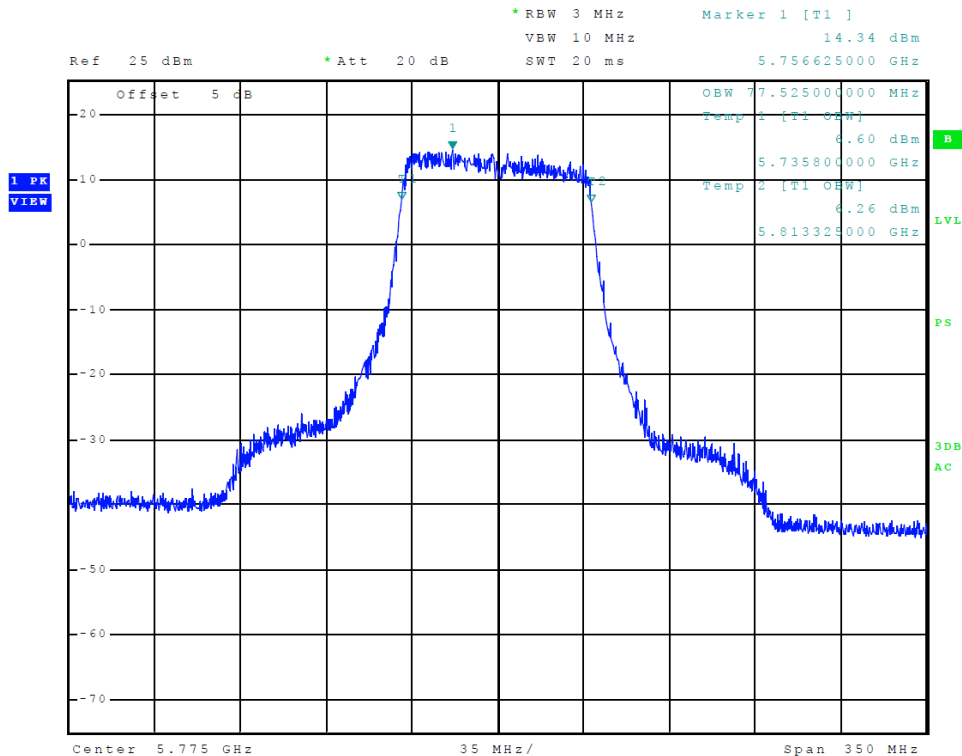

Figure 60 Plot of Transmitter Emissions (Chain 1, 5725-5850 MHz Band, 802.11ac80, 99% OBW)

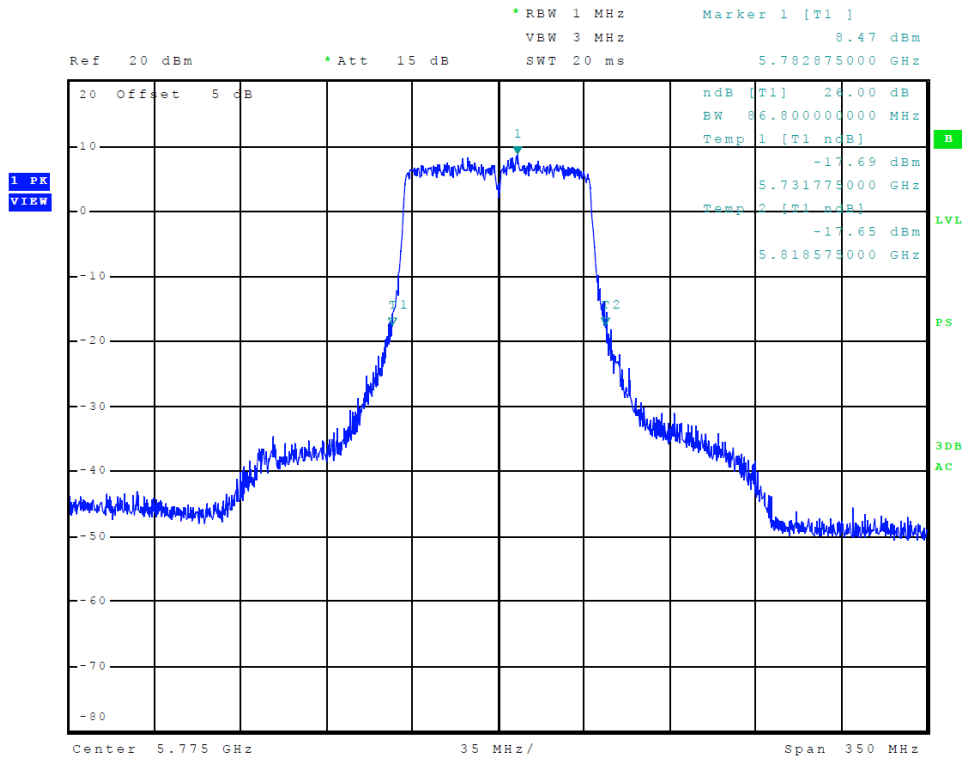

Figure 61 Plot of Transmitter Emissions (Chain 0, 5725-5850 MHz Band, 802.11ac80, 6-dB OBW)

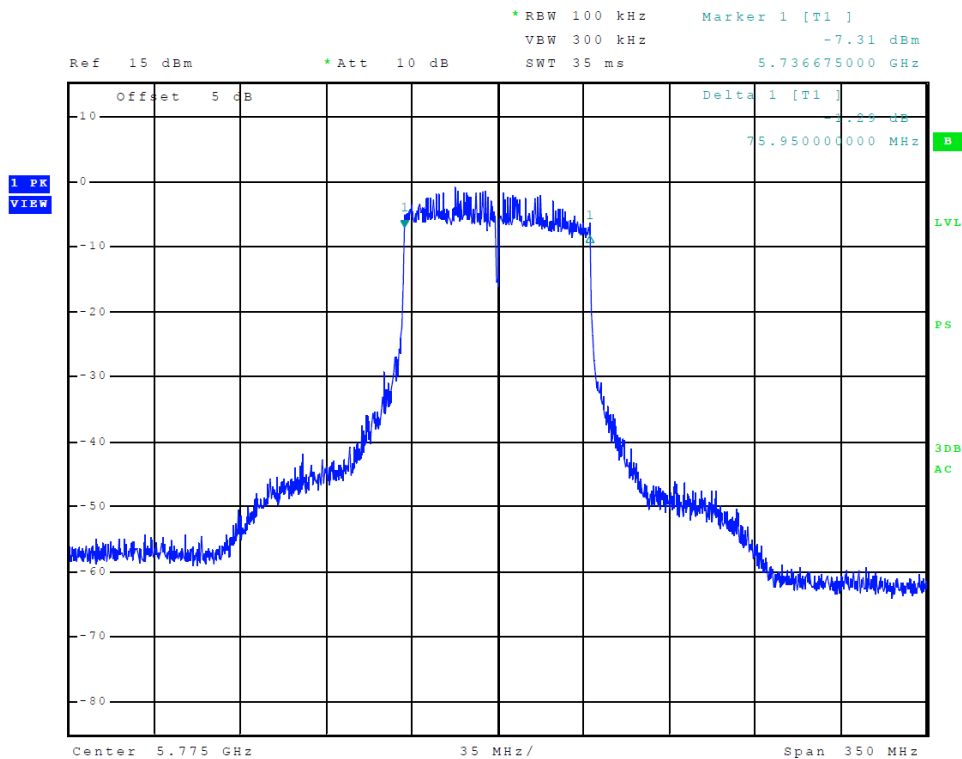

Figure 62 Plot of Transmitter Emissions (Chain 1, 5725-5850 MHz Band, 802.11ac80, 6-dB OBW)

Transmitter Emissions Data

Table 5 Transmitter Radiated Emission (5150-5250 MHz Band)

Frequency in MHz	Horizontal Peak (dBµV/m)	Horizontal Average (dBµV/m)	Vertical Peak (dBµV/m)	Vertical Average (dBµV/m)	Limit @ 3m (dBµV/m)
20 MHz Channel					
5180.0	--	--	--	--	--
10360.0	48.4	35.7	48.8	35.6	68.3
15540.0	52.0	38.9	51.6	38.7	68.3
20720.0	50.2	36.7	49.4	36.8	68.3
25900.0	52.2	39.1	51.3	38.8	68.3
5220.0	--	--	--	--	--
10440.0	47.8	35.2	47.8	35.4	68.3
15660.0	50.3	37.7	51.0	38.0	68.3
20880.0	49.7	36.3	49.4	36.2	68.3
26100.0	52.6	39.7	52.5	39.7	68.3
5240.0	--	--	--	--	--
10480.0	47.4	34.6	47.8	34.5	68.3
15720.0	52.6	39.5	53.4	39.8	68.3
20960.0	50.1	36.3	49.7	36.5	68.3
26200.0	52.7	39.3	52.4	39.3	68.3
Band Edges					
5150.0	44.5	31.5	44.6	31.4	54.0
5350.0	44.1	31.5	44.7	31.4	54.0

Other emissions present had amplitudes at least 20 dB below the limit. Peak and Quasi-Peak amplitude emissions are recorded above for frequency range of 30-1000 MHz. Peak and Average amplitude emissions are recorded above for frequency range above 1000 MHz.

Table 6 Transmitter Radiated Emission (5725-5850 MHz Band)

Frequency in MHz	Horizontal Peak (dB μ V/m)	Horizontal Average (dB μ V/m)	Vertical Peak (dB μ V/m)	Vertical Average (dB μ V/m)	Limit @ 3m (dB μ V/m)
20 MHz Channel					
5745.0	--	--	--	--	--
11490.0	48.3	35.3	48.2	35.5	68.3
17235.0	54.6	41.2	53.3	41.2	68.3
22980.0	51.2	37.8	50.7	37.5	68.3
28725.0	53.4	40.4	53.2	40.4	68.3
5785.0	--	--	--	--	--
11570.0	47.7	35.0	47.4	34.7	68.3
17355.0	52.7	40.2	52.6	39.6	68.3
23140.0	51.5	38.0	51.1	38.0	68.3
28925.0	53.8	40.6	53.2	40.6	68.3
5825.0	--	--	--	--	--
11650.0	48.2	35.2	48.2	35.2	68.3
17475.0	52.3	39.2	51.9	39.1	68.3
23300.0	50.6	37.5	49.6	37.2	68.3
29125.0	53.6	40.6	53.3	40.7	68.3
Band Edges					
5725.0	54.2	37.0	52.1	34.6	78.2
5850.0	44.3	30.1	45.1	32.2	78.2

Other emissions present had amplitudes at least 20 dB below the limit. Peak and Quasi-Peak amplitude emissions are recorded above for frequency range of 30-1000 MHz. Peak and Average amplitude emissions are recorded above for frequency range above 1000 MHz.

Table 7 Transmitter Antenna Port Conducted Power and Emissions Chain 0

Frequency MHz	Conducted Antenna Port Output Power (Watts)	99% Occupied Bandwidth kHz	Power Spectral Density dBm
20 MHz Mode 802.11a			
5180	0.018	17320	13.62 dBm/1MHz
5200	0.019	17400	14.04 dBm/1MHz
5240	0.021	17400	14.47 dBm/1MHz
40 MHz Mode 802.11n			
5190	0.016	37275	9.93 dBm/1M
5230	0.018	37350	10.56 dBm/1M
80 MHz Mode 802.11ac			
5210	0.014	77875	7.16 dBm/1M
20 MHz Mode 802.11a			
5745	0.103	17250	11.20 dBm/500kHz
5785	0.106	17360	11.94 dBm/500kHz
5825	0.127	17360	11.69 dBm/500kHz
40 MHz Mode 802.11n			
5755	0.087	37350	7.47 dBm/500kHz
5795	0.080	37200	8.16 dBm/500kHz
80 MHz Mode 802.11ac			
5775	0.059	77525	5.79 dBm/500kHz

Table 8 Transmitter Antenna Port Conducted Power and Emissions Chain 1

Frequency MHz	Conducted Antenna Port Output Power (Watts)	99% Occupied Bandwidth kHz	Power Spectral Density dBm
20 MHz Mode 802.11a			
5180	0.019	17080	11.01 dBm/1MHz
5200	0.021	17120	11.66 dBm/1MHz
5240	0.024	17080	12.59 dBm/1MHz
40 MHz Mode 802.11n			
5190	0.016	37125	7.07 dBm/1M
5230	0.21	37200	8.67 dBm/1M
80 MHz Mode 802.11ac			
5210	0.015	77525	4.46 dBm/1M
20 MHz Mode 802.11a			
5745	0.100	17080	11.65 dBm/500kHz
5785	0.106	17080	12.75 dBm/500kHz
5825	0.115	17080	12.98 dBm/500kHz
40 MHz Mode 802.11n			
5755	0.058	37200	6.83 dBm/500kHz
5795	0.064	37200	7.97 dBm/500kHz
80 MHz Mode 802.11ac			
5775	0.060	77525	6.19 dBm/500kHz

Table 9 Transmitter all antenna Ports Total Power and PSD U-NII-1 Band

Frequency MHz	Antenna Port Output Total (Watts)	Total Power Spectral Density dBm
20 MHz Mode 802.11a		
5180	0.037	15.5 dBm/1MHz
5200	0.040	16.0 dBm/1MHz
5240	0.045	16.6 dBm/1MHz
40 MHz Mode 802.11n		
5190	0.033	11.7 dBm/1MHz
5230	0.038	12.7 dBm/1MHz
80 MHz Mode 802.11ac		
5210	0.029	7.16 dBm/1MHz

Table 10 Transmitter all antenna Ports Total Power and PSD U-NII-3 Band

Frequency MHz	Antenna Port Output Total (Watts)	Total Power Spectral Density dBm
20 MHz Mode 802.11a		
5745	0.203	14.4 dBm/500 kHz
5785	0.212	15.4 dBm/500 kHz
5825	0.242	15.4 dBm/500 kHz
40 MHz Mode 802.11n		
5755	0.145	10.2 dBm/500 kHz
5795	0.145	11.1 dBm/500 kHz
80 MHz Mode 802.11ac		
5775	0.119	9.0 dBm/500 kHz

Summary of Results for Transmitter Radiated Emissions of Intentional Radiator

The EUT demonstrated compliance with the radiated emissions requirements of 47CFR Part 15.407 and Industry Canada RSS-247. The maximum conducted combined output power delivered into antenna ports was 0.242 -Watts. The minimum harmonic radiated emission margin provided -27.6 dB margin below requirements. General radiated emissions of EUT and supporting equipment provided -5.3 dB margin. There were no other significantly measurable emissions in the restricted bands other than those recorded in this report. Other emissions were present with amplitudes at least 20 dB below the requirements. There were no other deviations or exceptions to the requirements.

Statement of Modifications and Deviations

No modifications to the EUT were required for the unit to demonstrate compliance with the 47CFR Part 15C and Industry Canada RSS-247 emissions requirements. There were no deviations or modifications to the specifications.

Annex

- Annex A Measurement Uncertainty Calculations
- Annex B Rogers Labs Test Equipment List
- Annex C Rogers Qualifications
- Annex D FCC Site Registration Letter
- Annex E Industry Canada Site Registration Letter

Annex A Measurement Uncertainty Calculations

Measurement uncertainty calculations were made for the laboratory. Result of measurement uncertainty calculations are recorded below for AC line conducted and radiated emission measurements.

Measurement Uncertainty	$U_{(E)}$	$U_{(lab)}$
3 Meter Horizontal 30-200 MHz Measurements	2.08	4.16
3 Meter Vertical 30-200 MHz Measurements	2.16	4.33
3 Meter Vertical Measurements 200-1000 MHz	2.99	5.97
10 Meter Horizontal Measurements 30-200 MHz	2.07	4.15
10 Meter Vertical Measurements 30-200 MHz	2.06	4.13
10 Meter Horizontal Measurements 200-1000 MHz	2.32	4.64
10 Meter Vertical Measurements 200-1000 MHz	2.33	4.66
3 Meter Measurements 1-6 GHz	2.57	5.14
3 Meter Measurements 6-18 GHz	2.58	5.16
AC Line Conducted	1.72	3.43

Annex B Rogers Labs Test Equipment List

List of Test Equipment	Calibration	Date	Due
Spectrum Analyzer: Rohde & Schwarz ESU40		5/16	5/17
Spectrum Analyzer: HP 8562A, HP Adapters: 11518, 11519, and 11520		5/16	5/17
Mixers: 11517A, 11970A, 11970K, 11970U, 11970V, 11970W			
Spectrum Analyzer: HP 8591EM		5/16	5/17
Antenna: EMCO Biconilog Model: 3143		5/16	5/17
Antenna: Sunol Biconilog Model: JB6		10/16	10/17
Antenna: EMCO Log Periodic Model: 3147		10/16	10/17
Antenna: Com Power Model: AH-118		10/16	10/17
Antenna: Com Power Model: AH-840		5/16	5/18
Antenna: Antenna Research Biconical Model: BCD 235		10/16	10/17
Antenna: Com Power Model: AL-130		10/16	10/17
Antenna: EMCO 6509		10/16	10/17
LISN: Compliance Design Model: FCC-LISN-2.Mod.cd, 50 µHy/50 ohms/0.1 µf		10/16	10/17
R.F. Preamp CPPA-102		10/16	10/17
Attenuator: HP Model: HP11509A		10/16	10/17
Attenuator: Mini Circuits Model: CAT-3		10/16	10/17
Attenuator: Mini Circuits Model: CAT-3		10/16	10/17
Cable: Belden RG-58 (L1)		10/16	10/17
Cable: Belden RG-58 (L2)		10/16	10/17
Cable: Belden 8268 (L3)		10/16	10/17
Cable: Time Microwave: 4M-750HF290-750		10/16	10/17
Cable: Time Microwave: 10M-750HF290-750		10/16	10/17
Frequency Counter: Leader LDC825		2/17	2/18
Oscilloscope Scope: Tektronix 2230		2/17	2/18
Wattmeter: Bird 43 with Load Bird 8085		2/17	2/18
Power Supplies: Sorensen SRL 20-25, SRL 40-25, DCR 150, DCR 140		2/17	2/18
R.F. Generators: HP 606A, HP 8614A, HP 8640B		2/17	2/18
R.F. Power Amp 65W Model: 470-A-1010		2/17	2/18
R.F. Power Amp 50W M185- 10-501		2/17	2/18
R.F. Power Amp A.R. Model: 10W 1010M7		2/17	2/18
R.F. Power Amp EIN Model: A301		2/17	2/18
LISN: Compliance Eng. Model 240/20		2/17	2/18
LISN: Fischer Custom Communications Model: FCC-LISN-50-16-2-08		2/17	2/18
Antenna: EMCO Dipole Set 3121C		2/17	2/18
Antenna: C.D. B-101		2/17	2/18
Antenna: Solar 9229-1 & 9230-1		2/17	2/18
Audio Oscillator: H.P. 201CD		2/17	2/18
ELGAR Model: 1751		2/17	2/18
ELGAR Model: TG 704A-3D		2/17	2/18
ESD Test Set 2010i		2/17	2/18
Fast Transient Burst Generator Model: EFT/B-101		2/17	2/18
Field Intensity Meter: EFM-018		2/17	2/18
Shielded Room 5 M x 3 M x 3.0 M			

Annex C Rogers Qualifications

Scot D. Rogers, Engineer

Rogers Labs, Inc.

Mr. Rogers has approximately 17 years' experience in the field of electronics. Engineering experience includes six years in the automated controls industry and remaining years working with the design, development and testing of radio communications and electronic equipment.

Positions Held

Systems Engineer: A/C Controls Mfg. Co., Inc. 6 Years

Electrical Engineer: Rogers Consulting Labs, Inc. 5 Years

Electrical Engineer: Rogers Labs, Inc. Current

Educational Background

- 1) Bachelor of Science Degree in Electrical Engineering from Kansas State University.
- 2) Bachelor of Science Degree in Business Administration Kansas State University.
- 3) Several Specialized Training courses and seminars pertaining to Microprocessors and Software programming.

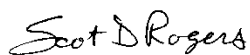

Scot D. Rogers



Annex D FCC Site Registration Letter

FEDERAL COMMUNICATIONS COMMISSION

**Laboratory Division
7435 Oakland Mills Road
Columbia, MD 21046**

April 16, 2015

Registration Number: 90910

Rogers Labs, Inc.
4405 West 259th Terrace
Louisburg, KS 66053

Attention: Scot Rogers,

Re: Measurement facility located at Louisburg
3 & 10 meter site
Date of Renewal: April 16, 2015

Dear Sir or Madam:

Your request for renewal of the registration of the subject measurement facility has been received. The information submitted has been placed in your file and the registration has been renewed. The name of your organization will remain on the list of facilities whose measurement data will be accepted in conjunction with applications for Certification under Parts 15 or 18 of the Commission's Rules. Please note that the file must be updated for any changes made to the facility and the registration must be renewed at least every three years.

Measurement facilities that have indicated that they are available to the public to perform measurement services on a fee basis may be found on the FCC website www.fcc.gov under E-Filing, OET Equipment Authorization Electronic Filing, Test Firms.

Sincerely,

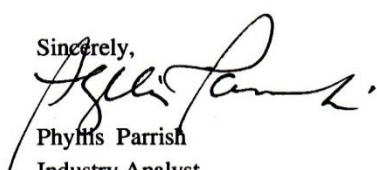
Phyllis Parrish
Industry Analyst

Rogers Labs, Inc.
4405 W. 259th Terrace
Louisburg, KS 66053

Phone/Fax: (913) 837-3214

Revision 2 File: Mikrotikls RBDynaDishG-5HacD-US TstRpt 170217 r2

Mikrotikls SIA

Model: RBDynaDishG-5HacD-USr3

Test #: 170217

Test to: 47CFR, 15.407, RSS-247

S/N: 6B2D056EB2B8/705E06697C53

FCC ID: TV7DYNADISHGAC

IC: 7442A-DYNADISHGAC

Date: March 28, 2017

Page 72 of 73

Annex E Industry Canada Site Registration Letter

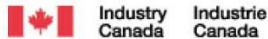

June 08, 2015

OUR FILE: 46405-3041
Authorization No: 010277847-001

Rogers Labs Inc.
4405 West 259th Terrace
Louisburg, KS
USA
66053

Attention: Mr. Scot D. Rogers

Dear Sir:

The Bureau has received your application for the renewal of 3m OATS. Be advised that the information received was satisfactory to Industry Canada. The following number(s) is now associated to the site(s) for which registration / renewal was sought (**Site# 3041A-1**). Please reference the appropriate site number in the body of test reports containing measurements performed on the site. In addition, please keep for your records the following information;

- The company address code associated to the site(s) located at the above address is: **3041A**

Furthermore, to obtain or renew a unique site number, the applicant shall demonstrate that the site has been accredited to ANSI C63.4-2009 or later. A scope of accreditation indicating the accreditation by a recognized accreditation body to ANSI C63.4-2009 or later shall be accepted. Please indicate in a letter the previous assigned site number if applicable and the type of site (example: 3 metre OATS or 3 metre chamber). If the test facility is not accredited to ANSI C63.4-2009 or later, the test facility shall submit test data demonstrating full compliance with the ANSI standard. The Bureau will evaluate the filing to determine if recognition shall be granted.

The frequency for re-validation of the test site and the information that is required to be filed or retained by the testing party shall comply with the requirements established by the accrediting organization. However, in all cases, test site re-validation shall occur on an interval not to exceed **three years**. There is no fee or form associated with an OATS filing. OATS submissions are encouraged to be submitted electronically to the Bureau using the following URL; http://strategis.ic.gc.ca/epic/internet/inceb-bhst.nsf/en/h_tt00052e.html.

If you have any questions, you may contact the Bureau by e-mail at certification.bureau@ic.gc.ca Please reference our file and submission number above for all correspondence.

Yours sincerely,

A handwritten signature in black ink that reads "Bill Payn".

Bill Payn
For: Wireless Laboratory Manager
Certification and Engineering Bureau
3701 Carling Ave., Building 94
P.O. Box 11490, Station AH@
Ottawa, Ontario K2H 8S2
Email: certification.bureau@ic.gc.ca

Rogers Labs, Inc.
4405 W. 259th Terrace
Louisburg, KS 66053
Phone/Fax: (913) 837-3214
Revision 2 File: Mikrotikls RBDynaDishG-5HacD-US TstRpt 170217 r2

Mikrotikls SIA
Model: RBDynaDishG-5HacD-USr3
Test #: 170217
Test to: 47CFR, 15.407, RSS-247
S/N: 6B2D056EB2B8/705E06697C53
FCC ID: TV7DYNADISHGAC
IC: 7442A-DYNADISHGAC
Date: March 28, 2017
Page 73 of 73