



# RF TEST REPORT

**Applicant**      Quetel Wireless Solutions Co., Ltd  
**FCC ID**          XMR201912BG77  
**Product**        LTE Cat M1 & Cat NB2 Module  
**Brand**            Quetel  
**Model**            BG77  
**Marketing**       Quetel BG77  
**Report No.**      R1909A0576-R7  
**Issue Date**     March 17, 2020

TA Technology (Shanghai) Co., Ltd. tested the above equipment in accordance with the requirements in **FCC CFR47 Part 2 (2019)/ FCC CFR47 Part 27C (2019)**. The test results show that the equipment tested is capable of demonstrating compliance with the requirements as documented in this report.

*Performed by: Peng Tao*

*Approved by: Kai Xu*

---

**TA Technology (Shanghai) Co., Ltd.**

*No.145, Jintang Rd, Tangzhen Industry Park, Pudong Shanghai, China*

*TEL: +86-021-50791141/2/3*

*FAX: +86-021-50791141/2/3-8000*



## TABLE OF CONTENT

<b>1</b>	<b>Test Laboratory</b> .....	4
1.1	Notes of the Test Report .....	4
<b>1.2.</b>	<b>Test facility</b> .....	4
1.3	Testing Location .....	4
<b>2</b>	<b>General Description of Equipment under Test</b> .....	5
2.1	Applicant and Manufacturer Information.....	5
2.2	General information.....	5
<b>3</b>	<b>Applied Standards</b> .....	7
<b>4</b>	<b>Test Configuration</b> .....	8
<b>5</b>	<b>Test Case Results</b> .....	10
5.1	RF Power Output and Effective Radiated Power .....	10
5.2	Occupied Bandwidth .....	17
5.3	Band Edge Compliance .....	27
5.4	Peak-to-Average Power Ratio (PAPR) .....	58
5.5	Frequency Stability.....	61
5.6	Spurious Emissions at Antenna Terminals .....	65
5.7	Radiates Spurious Emission .....	87
<b>6</b>	<b>Main Test Instruments</b> .....	98



## Summary of Measurement Results

Number	Test Case	Clause in FCC rules	Verdict
1	RF power output and Effective Radiated Power	2.1046 27.50(d)(4)/27.50(b)(10)/27.50(c)(10)	PASS
2	Occupied Bandwidth	2.1049	PASS
3	Band Edge Compliance	27.53(h)/27.53(g)/27.53(f) /27.53(c)	PASS
4	Peak-to-Average Power Ratio	27.50(d)/KDB971168 D01(5.7)	PASS
5	Frequency Stability	2.1055 / 27.54	PASS
6	Spurious Emissions at Antenna Terminals	2.1051 /27.53(h)/27.53(g) /27.53(f) /27.53(c)	PASS
7	Radiates Spurious Emission	2.1053 /27.53(h) /27.53(g) /27.53(f) /27.53(c)	PASS

Date of Testing: December 13, 2019 ~January 14, 2020

Note: PASS: The EUT complies with the essential requirements in the standard.

FAIL: The EUT does not comply with the essential requirements in the standard.

All indications of Pass/Fail in this report are opinions expressed by TA Technology (Shanghai) Co., Ltd. based on interpretations and/or observations of test results. Measurement Uncertainties were not taken into account and are published for informational purposes only.



# 1 Test Laboratory

## 1.1 Notes of the Test Report

This report shall not be reproduced in full or partial, without the written approval of **TA technology (shanghai) co., Ltd.** The results documented in this report apply only to the tested sample, under the conditions and modes of operation as described herein .Measurement Uncertainties were not taken into account and are published for informational purposes only. This report is written to support regulatory compliance of the applicable standards stated above.

## 1.2. Test facility

### **FCC (Designation number: CN1179, Test Firm Registration Number: 446626)**

TA Technology (Shanghai) Co., Ltd. has been listed on the US Federal Communications Commission list of test facilities recognized to perform electromagnetic emissions measurements.

### **A2LA (Certificate Number: 3857.01)**

TA Technology (Shanghai) Co., Ltd. has been listed by American Association for Laboratory Accreditation to perform electromagnetic emission measurement.

## 1.3 Testing Location

Company: TA Technology (Shanghai) Co., Ltd.  
Address: No.145, Jintang Rd, Tangzhen Industry Park, Pudong Shanghai, China  
City: Shanghai  
Post code: 201201  
Country: P. R. China  
Contact: Xu Kai  
Telephone: +86-021-50791141/2/3  
Fax: +86-021-50791141/2/3-8000  
Website: <http://www.ta-shanghai.com>  
E-mail: [xukai@ta-shanghai.com](mailto:xukai@ta-shanghai.com)

## 2 General Description of Equipment under Test

### 2.1 Applicant and Manufacturer Information

<b>Applicant</b>	Quectel Wireless Solutions Co., Ltd
<b>Applicant address</b>	Building 5, Shanghai Business Park Phase III (Area B), No.1016 Tianlin Road, Minhang District, Shanghai, China 200233
<b>Manufacturer</b>	Quectel Wireless Solutions Co., Ltd
<b>Manufacturer address</b>	Building 5, Shanghai Business Park Phase III (Area B), No.1016 Tianlin Road, Minhang District, Shanghai, China 200233

### 2.2 General information

EUT Description			
Model	BG77		
IMEI	866349040016200		
Hardware Version	R1.2		
Software Version	BG77LAR02A02		
Power Supply	External Power Supply		
Antenna Type	The EUT don't have standard Antenna, The Antenna used for testing in this report is the after-market accessory (Dipole Antenna)		
Antenna Gain	LTE Band 4: 1.67dBi LTE Band 12: 1.66dBi LTE Band 13: 3.98dBi LTE Band 66: 1.67dBi LTE Band 85: 1.66dBi		
Test Mode(s)	LTE Band 4/12/13/66/85		
Test Modulation	(LTE)QPSK 16QAM;		
LTE Category	M1		
Maximum E.I.R.P.	LTE Band 4:	23.54dBm	
	LTE Band 66:	23.30dBm	
Maximum E.R.P.	LTE Band 12:	22.47dBm	
	LTE Band 13:	23.32dBm	
	LTE Band 85	22.81 dBm	
Rated Power Supply Voltage:	3.3V		
Extreme Voltage	Minimum: 2.6V    Maximum: 4.8V		
Extreme Temperature	Lowest: -40°C    Highest: +85°C		
Operating Frequency Range(s)	Mode	Tx (MHz)	Rx (MHz)
	LTE Band 4	1710 ~ 1755	2110 ~ 2155
	LTE Band 12	699 ~ 716	729 ~ 746



	LTE Band 13	777 ~ 787	746 ~ 756
	LTE Band 66	1710 ~ 1780	2110 ~ 2180
	LTE Band 85	698 ~ 716	728 ~ 746

Note: 1. The EUT is sent from the applicant to TA and the information of the EUT is declared by the applicant.



### **3 Applied Standards**

According to the specifications of the manufacturer, it must comply with the requirements of the following standards:

**Test standards:**

**FCC CFR47 Part 27C (2019)**

**ANSI C63.26 (2015)**

**Reference standard:**

**FCC CFR47 Part 2 (2019)**

**KDB 971168 D01 Power Meas License Digital Systems v03r01**

## 4 Test Configuration

Radiated measurements are performed by rotating the EUT in three different orthogonal test planes. EUT stand-up position (Z axis), lie-down position (X, Y axis). Receiver antenna polarization (horizontal and vertical), the worst emission was found in position (X axis, horizontal polarization) and the worst case was recorded.

All mode and data rates and positions and RB size and modulations were investigated. Subsequently, only the worst case emissions are reported.

The following testing in LTE is set based on the maximum RF Output Power.

The following testing in different Bandwidth is set to detail in the following table:

Test modes are chosen to be reported as the worst case configuration below for LTE Band 4/12/13/61/85:

Test items	Modes	Bandwidth (MHz)						Modulation		RB			Test Channel		
		1.4	3	5	10	15	20	QPSK	16QAM	1	50%	100%	L	M	H
RF power output	LTE 4	O	O	O	O	O	O	O	O	O	O	O	O	O	O
	LTE 12	O	O	O	O	-	-	O	O	O	O	O	O	O	O
	LTE 13	-	-	O	O	-	-	O	O	O	O	O	O	O	O
	LTE 66	O	O	O	O	O	O	O	O	O	O	O	O	O	O
	LTE 85	-	-	O	O	-	-	O	O	O	O	O	O	O	O
Effective Isotropic Radiated power	LTE 4	O	O	O	O	O	O	O	O	O	O	O	O	O	O
	LTE 12	O	O	O	O	-	-	O	O	O	O	O	O	O	O
	LTE 13	-	-	O	O	-	-	O	O	O	O	O	O	O	O
	LTE 66	O	O	O	O	O	O	O	O	O	O	O	O	O	O
	LTE 85	-	-	O	O	-	-	O	O	O	O	O	O	O	O
Occupied Bandwidth	LTE 4	O	O	O	O	O	O	O	O	-	-	O	O	O	O
	LTE 12	O	O	O	O	-	-	O	O	-	-	O	O	O	O
	LTE 13	-	-	O	O	-	-	O	O	-	-	O	O	O	O
	LTE 66	O	O	O	O	O	O	O	O	-	-	O	O	O	O
	LTE 85	-	-	O	O	-	-	O	O	-	-	O	O	O	O
Band Edge Compliance	LTE 4	O	O	O	O	O	O	O	O	O	-	O	O	-	O
	LTE 12	O	O	O	O	-	-	O	O	O	-	O	O	-	O
	LTE 13	-	-	O	O	-	-	O	O	O	-	O	O	-	O
	LTE 66	O	O	O	O	O	O	O	O	O	-	O	O	-	O
	LTE 85	-	-	O	O	-	-	O	O	O	-	O	O	-	O
Peak-to-Average Power Ratio	LTE 4	O	O	O	O	O	O	O	O	-	-	O	O	O	O
	LTE 12	O	O	O	O	-	-	O	O	-	-	O	O	O	O
	LTE 13	-	-	O	O	-	-	O	O	-	-	O	O	O	O





	LTE 66	O	O	O	O	O	O	O	O	-	-	O	O	O	O
	LTE 85	-	-	O	O	-	-	O	O	-	-	O	O	O	O
Frequency Stability	LTE 4	O	O	O	O	O	O	O	O	O	O	O	O	O	O
	LTE 12	O	O	O	O	-	-	O	O	O	O	O	O	O	O
	LTE 13	-	-	O	O	-	-	O	O	O	O	O	O	O	O
	LTE 66	O	O	O	O	O	O	O	O	O	O	O	O	O	O
	LTE 85	-	-	O	O	-	-	O	O	O	O	O	O	O	O
Spurious Emissions at Antenna Terminals	LTE 4	O	O	O	O	O	O	O	-	O	-	-	O	O	O
	LTE 12	O	O	O	O	-	-	O	-	O	-	-	O	O	O
	LTE 13	-	-	O	O	-	-	O	-	O	-	-	O	O	O
	LTE 66	O	O	O	O	O	O	O	-	O	-	-	O	O	O
	LTE 85	-	-	O	O	-	-	O	-	O	-	-	O	O	O
Radiates Spurious Emission	LTE 4	O	-	O	-	-	O	O	-	O	-	-	-	O	-
	LTE 12	O	-	O	O	-	-	O	-	O	-	-	-	O	-
	LTE 13	-	-	O	O	-	-	O	-	O	-	-	-	O	-
	LTE 66	O	O	O	O	O	O	O	-	O	-	-	-	O	-
	LTE 85	-	-	O	O	-	-	O	-	O	-	-	-	O	-
Note	1. The mark "O" means that this configuration is chosen for testing. 2. The mark "-" means that this configuration is not testing.														

## 5 Test Case Results

### 5.1 RF Power Output and Effective Radiated Power

#### Ambient condition

Temperature	Relative humidity	Pressure
23°C ~25°C	45%~50%	101.5kPa

#### Methods of Measurement

During the process of the testing, The EUT is controlled by the Base Station Simulator to ensure max power transmission and proper modulation.

1. The testing follows FCC KDB 971168 D01 v03r01 Section 5.8 and ANSI C63.26 (2015).

- a) Connect the equipment as illustrated. Mount the equipment with the manufacturer specified antenna in a vertical orientation on a manufacturer specified mounting surface located on a non-conducting rotating platform of a RF anechoic chamber (preferred) or a standard radiation site.
- b) Key the transmitter, then rotate the EUT 360° azimuthally and record spectrum analyzer power level (LVL) measurements at angular increments that are sufficiently small to permit resolution of all peaks. If a standard radiation test site is used, raise and lower the test antenna to obtain a maximum reading at each angular increment. (Note: several batteries may be needed to offset the effect of battery voltage droop, which should not exceed 5% of the manufactured specified battery voltage during transmission).
- c) Replace the transmitter under test with a vertically polarized half-wave dipole (or an antenna whose gain is known relative to an ideal half-wave dipole). The center of the antenna should be at the same location as the center of the antenna under test.
- d) Connect the antenna to a signal generator with a known output power and record the path loss (in dB) as LOSS. If a standard radiation test site is used, raise and lower the test antenna to obtain a maximum reading.  $LOSS = \text{Generator Output Power (dBm)} - \text{Analyzer reading (dBm)}$
- e) Determine the effective radiated output power at each angular position from the readings in steps b) and d) using the following equation:  $ERP \text{ (dBm)} = \text{LVL (dBm)} + \text{LOSS (dB)}$
- f) The maximum ERP is the maximum value determined in the preceding step.
- g) When calculating ERP, in addition to knowing the antenna radiation and matching characteristics, it is necessary to know the loss values of all elements (e.g. transmission line attenuation, mismatches, filters, combiners) interposed between the point where transmitter output power is measured, and the point where power is applied to the antenna. ERP can then be calculated as follows:

$$EIRP \text{ (dBm)} = \text{Output Power (dBm)} - \text{Losses (dB)} + \text{Antenna Gain (dBi)}$$

where: dBd refers to gain relative to an ideal dipole.

$$EIRP \text{ (dBm)} = ERP \text{ (dBm)} + 2.15 \text{ (dB.)}$$

The RB allocation refers to section 5.1, using the maximum output power configuration.

**Test Setup**

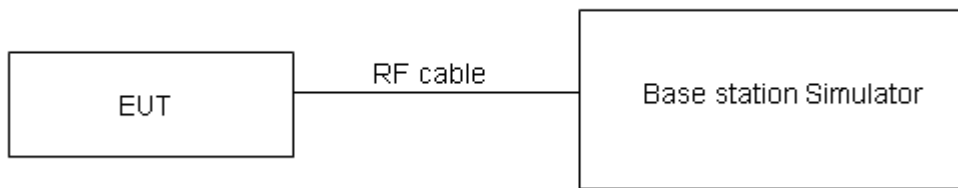

The loss between RF output port of the EUT and the input port of the tester has been taken into consideration.

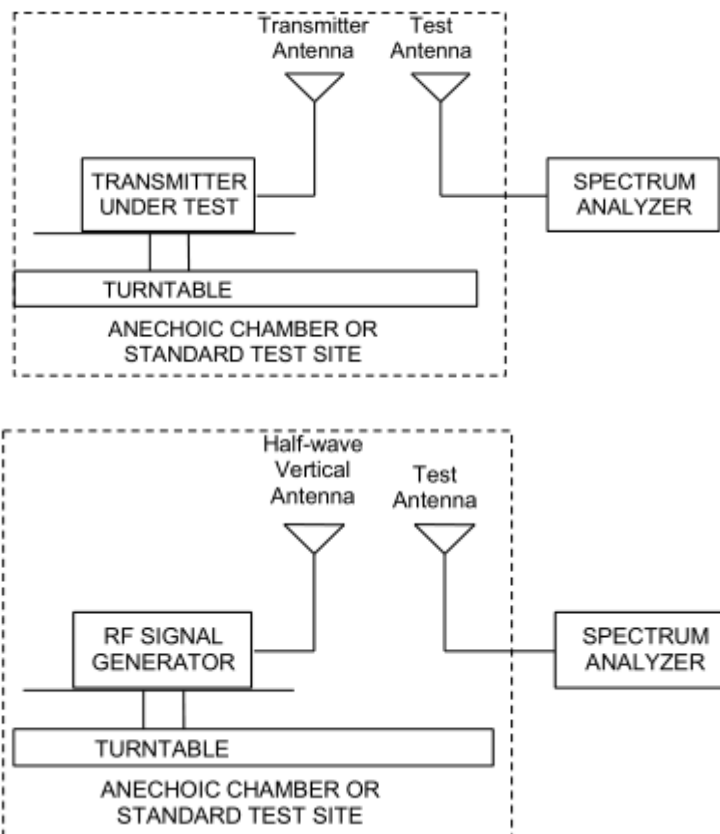

Note: Area side:2.4mX3.6m

The radiated emission was measured in the following position: EUT stand-up position (Z axis), lie-down position (X, Y axis). The worst emission was found in stand-up position (Z axis) and the worst case was recorded.

**Limits**

No specific RF power output requirements in part 2.1046.

Rule Part 27.50(b) (10) specifies that “Portable stations (hand-held devices) transmitting in the 746-757 MHz, 776-788 MHz, and 805-806 MHz bands are limited to 3 watts ERP”

Rule Part 27.50(c) (10) specifies that “Portable stations (hand-held devices) in the 600 MHz uplink band and the 698-746 MHz band, and fixed and mobile stations in the 600 MHz uplink band are limited to 3 watts ERP”



Rule Part 27.50(d) (4) specifies that “Fixed, mobile and portable (hand-held) stations operating in the 1710–1755 MHz band are limited to 1 watt EIRP”

Part 27.50(b)(10)	$\leq 3 \text{ W}$ (34.77 dBm)
Part 27.50(c)(10)	$\leq 3 \text{ W}$ (34.77 dBm)
Part 27.50(d)(4)Limit	$\leq 1 \text{ W}$ (30 dBm)

### Measurement Uncertainty

The assessed measurement uncertainty to ensure 95% confidence level for the normal distribution is with the coverage factor  $k = 2$ ,  $U=0.4$  dB for RF power output,  $k = 2$ ,  $U= 1.19$  dB for EIRP.



## Test Results

LTE Band4	Channel/ Frequency(MHz)	Index	RB# RBstart	Conducted Power (dBm)		EIRP (dBm)	
				QPSK	16QAM	QPSK	16QAM
1.4MHz	19957/1710.7	0	1#0	21.15	20.55	23.09	22.49
		0	6#0	19.34	19.05	21.28	20.99
	20175/1732.5	0	1#0	21.19	20.59	23.13	22.53
		0	6#0	19.22	19.05	21.16	20.99
	20393/1754.3	0	1#5	21.60	20.23	23.54	22.17
		0	6#0	19.36	19.60	21.30	21.54
3MHz	19965/1711.5	0	1#0	21.37	20.08	23.31	22.02
		0	6#0	19.29	19.50	21.23	21.44
	20175/1732.5	0	1#0	21.29	20.62	23.23	22.56
		0	6#0	19.21	19.12	21.15	21.06
	20385/1753.5	1	1#5	21.24	19.90	23.18	21.84
		1	6#0	19.36	19.57	21.30	21.51
5MHz	19975/1712.5	0	1#0	21.25	20.90	23.19	22.84
		0	6#0	20.25	20.34	22.19	22.28
	20175/1732.5	0	1#0	21.30	20.86	23.24	22.80
		0	6#0	20.25	20.36	22.19	22.30
	20375/1752.5	3	1#5	21.20	20.80	23.14	22.74
		3	6#0	20.36	20.45	22.30	22.39
10MHz	20000/1715	0	1#0	21.26	20.95	23.20	22.89
		0	4#0	21.26	21.31	23.20	23.25
	20175/1732.5	0	1#0	21.27	21.48	23.21	23.42
		0	4#0	21.15	21.51	23.09	23.45
	20350/1750	7	1#5	21.27	20.77	23.21	22.71
		7	4#2	21.38	21.43	23.32	23.37
15MHz	20025/1717.5	0	1#0	21.30	20.90	23.24	22.84
		0	6#0	20.11	21.31	22.05	23.25
	20175/1732.5	0	1#0	21.24	21.37	23.18	23.31
		0	6#0	21.20	21.25	23.14	23.19
	20325/1747.5	11	1#5	21.17	21.35	23.11	23.29
		11	6#0	21.33	21.35	23.27	23.29
20MHz	20050/1720	0	1#0	21.32	20.86	23.26	22.80
		0	6#0	21.12	21.22	23.06	23.16
	20175/1732.5	0	1#0	21.28	20.79	23.22	22.73
		0	6#0	21.11	21.22	23.05	23.16
	20300/1745	15	1#5	21.23	20.89	23.17	22.83
		15	6#0	21.29	21.31	23.23	23.25



LTE Band12	Channel/ Frequency(MHz)	Index	RB# RBstart	Conducted Power (dBm)		ERP (dBm)	
				QPSK	16QAM	QPSK	16QAM
1.4MHz	23017/699.7	0	1#0	21.18	19.32	22.29	20.43
		0	6#0	18.51	19.03	19.62	20.14
	23095/707.5	0	1#0	21.31	19.65	22.42	20.76
		0	6#0	18.75	19.17	19.86	20.28
	23173/715.3	0	1#5	21.36	19.71	22.47	20.82
		0	6#0	18.83	19.25	19.94	20.36
3MHz	23025/700.5	0	1#0	20.98	19.47	22.09	20.58
		0	6#0	18.55	18.86	19.66	19.97
	23095/707.5	0	1#0	21.11	19.68	22.22	20.79
		0	6#0	18.78	19.01	19.89	20.12
	23165/714.5	1	1#5	21.10	19.76	22.21	20.87
		1	6#0	18.83	19.06	19.94	20.17
5MHz	23035/701.5	3	1#0	20.74	20.45	21.85	21.56
		0	6#0	19.60	19.79	20.71	20.90
	23095/707.5	0	1#0	20.92	20.45	22.03	21.56
		0	6#0	19.87	19.79	20.98	20.90
	23155/713.5	0	1#5	20.91	20.52	22.02	21.63
		3	6#0	19.87	19.96	20.98	21.07
10MHz	23060/704	3	1#0	20.82	20.35	21.93	21.46
		0	4#0	20.81	21.18	21.92	22.29
	23095/707.5	0	1#0	20.84	20.45	21.95	21.56
		0	4#0	21.02	21.36	22.13	22.47
	23130/711	4	1#5	20.88	21.16	21.99	22.27
		7	4#2	20.82	21.07	21.93	22.18

LTE Band13	Channel/ Frequency(MHz)	Index	RB# RBstart	Conducted Power (dBm)		ERP (dBm)	
				QPSK	16QAM	QPSK	16QAM
5MHz	23205/779.5	0	1#0	20.77	20.42	23.07	22.72
		0	6#0	19.81	20.07	22.11	22.37
	23230/782	0	1#0	20.82	20.42	23.12	22.72
		0	6#0	19.82	20.00	22.12	22.30
	23255/784.5	3	1#5	20.72	20.21	23.02	22.51
		3	6#0	19.81	19.98	22.11	22.28
10MHz	23230/782	0	1#0	20.85	20.37	23.15	22.67
		0	4#0	19.77	21.02	22.07	23.32



LTE Band66	Channel/ Frequency(MHz)	Index	RB# RBstart	Conducted Power (dBm)		EIRP (dBm)	
				QPSK	16QAM	QPSK	16QAM
1.4MHz	131979/1710.7	0	1#0	21.20	19.79	23.20	21.79
		0	6#0	18.79	19.14	20.79	21.14
	132322/1745	0	1#0	21.19	19.67	23.19	21.67
		0	6#0	18.03	19.08	20.03	21.08
	132665/1779.3	0	1#5	21.30	19.68	23.30	21.68
		0	6#0	19.08	19.85	21.08	21.85
3MHz	131987/1711.5	0	1#0	20.84	19.48	22.84	21.48
		0	6#0	18.87	19.07	20.87	21.07
	132322/1745	0	1#0	20.73	19.38	22.73	21.38
		0	6#0	18.66	18.62	20.66	20.62
	132657/1778.5	1	1#5	21.15	19.78	23.15	21.78
		1	6#0	19.14	20.17	21.14	22.17
5MHz	131997/1712.5	0	1#0	20.85	20.32	22.85	22.32
		0	6#0	19.86	19.97	21.86	21.97
	132322/1745	0	1#0	20.86	20.41	22.86	22.41
		0	6#0	19.84	19.86	21.84	21.86
	132647/1777.5	0	1#5	21.15	20.87	23.15	22.87
		3	6#0	20.13	20.26	22.13	22.26
10MHz	132022/1715	3	1#0	20.82	20.41	22.82	22.41
		0	4#0	20.83	20.84	22.83	22.84
	132022/1745	0	1#0	20.75	20.47	22.75	22.47
		0	4#0	20.83	20.90	22.83	22.90
	132622/1775	4	1#5	20.41	20.11	22.41	22.11
		7	4#2	20.67	20.62	22.67	22.62
15MHz	132047/1717.5	3	1#0	20.91	20.45	22.91	22.45
		0	6#0	20.74	20.86	22.74	22.86
	132322/1745	0	1#0	20.83	20.44	22.83	22.44
		0	6#0	20.69	20.84	22.69	22.84
	132597/1772.5	8	1#5	21.13	20.64	23.13	22.64
		11	6#0	21.17	21.23	23.17	23.23
20MHz	132072/1720	3	1#0	20.91	21.04	22.91	23.04
		0	6#0	20.79	20.86	22.79	22.86
	132322/1745	0	1#0	20.73	20.87	22.73	22.87
		0	6#0	20.75	20.76	22.75	22.76
	132572/1770	12	1#5	20.63	20.26	22.63	22.26
		15	6#0	20.52	20.64	22.52	22.64



LTE Band85	Channel/ Frequency(MHz)	Index	RB# RBstart	Conducted Power (dBm)		ERP (dBm)	
				QPSK	16QAM	QPSK	16QAM
5MHz	134027/700.5	0	1#0	21.22	21.70	22.33	22.81
		0	6#0	20.56	21.20	21.67	22.31
	134092/707	0	1#0	21.33	21.37	22.44	22.48
		0	6#0	20.71	21.30	21.82	22.41
	134157/713.5	3	1#5	21.22	20.97	22.33	22.08
		3	6#0	20.49	21.11	21.60	22.22
10MHz	134052/703	0	1#0	21.33	21.30	22.44	22.41
		0	4#0	20.91	20.98	22.02	22.09
	134092/707	0	1#0	21.12	21.01	22.23	22.12
		0	4#0	20.30	20.87	21.41	21.98
	134132/711	0	1#5	21.03	20.97	22.14	22.08
		0	4#2	21.22	20.81	22.33	21.92



## 5.2 Occupied Bandwidth

### Ambient condition

Temperature	Relative humidity	Pressure
23°C ~25°C	45%~50%	101.5kPa

### Method of Measurement

The EUT was connected to Spectrum Analyzer and Base Station Simulator via power Splitter. The occupied bandwidth is measured using spectrum analyzer.

RBW is set to 51kHz, VBW is set to 160kHz for LTE Band 4/12/13/66/85.

99% power and -26dBc occupied bandwidths are recorded. Spectrum analyzer plots are included on the following pages.

### Test Setup

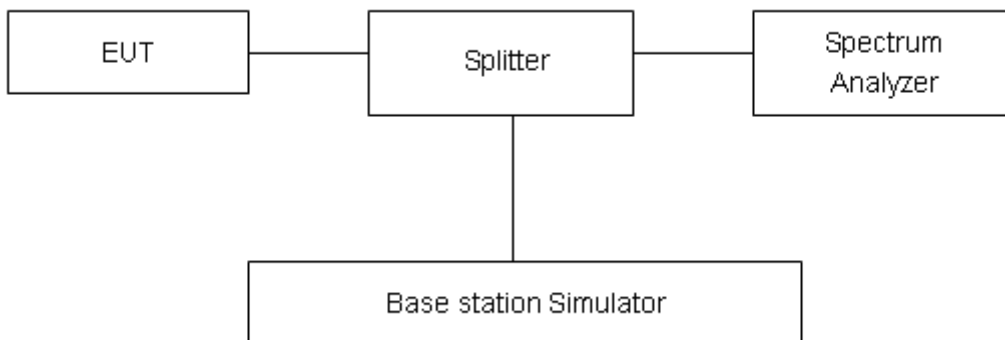

### Limits

No specific occupied bandwidth requirements in part 2.1049.

### Measurement Uncertainty

The assessed measurement uncertainty to ensure 95% confidence level for the normal distribution is with the coverage factor  $k = 2$ ,  $U=624\text{Hz}$ .



## Test Result

Mode	Bandwidth	Modulation	Channel/ Frequency(MHz)	RB	Index	Bandwidth(MHz)	
						99% Power	-26dBc
Band4	1.4MHz	QPSK	20175/1732.5	6#0	0	1.1061	1.333
		16QAM	20175/1732.5	6#0	0	0.9427	1.167
	3MHz	QPSK	20175/1732.5	6#0	0	1.1006	1.390
		16QAM	20175/1732.5	6#0	0	0.9514	1.366
	5MHz	QPSK	20175/1732.5	6#0	0	1.1252	1.357
		16QAM	20175/1732.5	6#0	0	0.9491	1.190
	10MHz	QPSK	20175/1732.5	6#0	0	1.1239	1.335
		16QAM	20175/1732.5	6#0	0	0.9615	1.177
	15MHz	QPSK	20175/1732.5	6#0	0	1.1267	1.375
		16QAM	20175/1732.5	6#0	0	0.9618	1.159
	20MHz	QPSK	20175/1732.5	6#0	0	1.1282	1.341
		16QAM	20175/1732.5	6#0	0	0.9554	1.273

Mode	Bandwidth	Modulation	Channel/ Frequency(MHz)	RB	Index	Bandwidth(MHz)	
						99% Power	-26dBc
Band12	1.4MHz	QPSK	23095/707.5	6#0	0	1.1045	1.362
		16QAM	23095/707.5	6#0	0	0.9391	1.163
	3MHz	QPSK	23095/707.5	6#0	0	1.1095	1.329
		16QAM	23095/707.5	6#0	0	0.9418	1.252
	5MHz	QPSK	23095/707.5	6#0	0	1.1021	1.369
		16QAM	23095/707.5	6#0	0	0.9453	1.190
	10MHz	QPSK	23095/707.5	6#0	0	1.1182	1.386
		16QAM	23095/707.5	6#0	0	0.9528	1.174

Mode	Bandwidth	Modulation	Channel/ Frequency(MHz)	RB	Index	Bandwidth(MHz)	
						99% Power	-26dBc
Band13	5MHz	QPSK	23230/782	6#0	0	1.1109	1.319
		16QAM	23230/782	6#0	0	0.9478	1.225
	10MHz	QPSK	23230/782	6#0	0	1.1146	1.345
		16QAM	23230/782	6#0	0	0.9570	1.175

Mode	Bandwidth	Modulation	Channel/ Frequency(MHz)	RB	Index	Bandwidth(MHz)	
						99% Power	-26dBc
Band66	1.4MHz	QPSK	132322/1745	6#0	0	1.0998	1.339
		16QAM	132322/1745	6#0	0	0.9410	1.158
	3MHz	QPSK	132322/1745	6#0	0	1.1088	1.336
		16QAM	132322/1745	6#0	0	0.9507	1.261
	5MHz	QPSK	132322/1745	6#0	0	1.1024	1.338
		16QAM	132322/1745	6#0	0	0.9462	1.134



10MHz	QPSK	132322/1745	6#0	0	1.1202	1.377
	16QAM	132322/1745	6#0	0	0.9482	1.160
15MHz	QPSK	132322/1745	6#0	0	1.1164	1.347
	16QAM	132322/1745	6#0	0	0.9574	1.145
20MHz	QPSK	132322/1745	6#0	0	1.1272	1.338
	16QAM	132322/1745	6#0	0	0.9585	1.170

Mode	Bandwidth	Modulation	Channel/ Frequency(MHz)	RB	Index	Bandwidth(MHz)	
						99% Power	-26dBc
Band85	5MHz	QPSK	134092/707	6#0	0	1.1148	1.200
		16QAM	134092/707	6#0	0	0.9614	1.020
	10MHz	QPSK	134092/707	6#0	0	1.1271	1.880
		16QAM	134092/707	6#0	0	0.9595	1.220

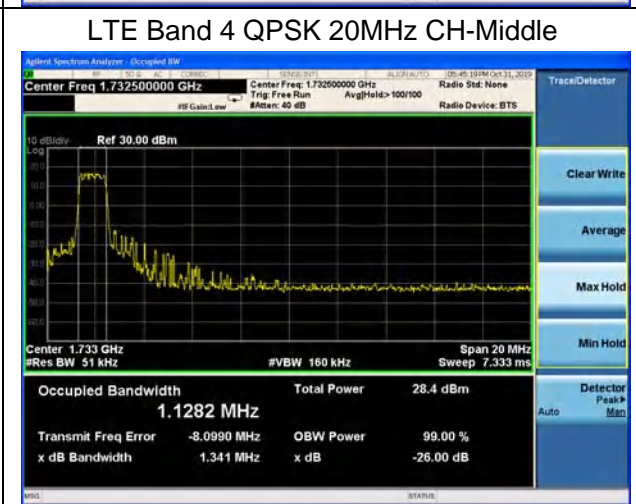
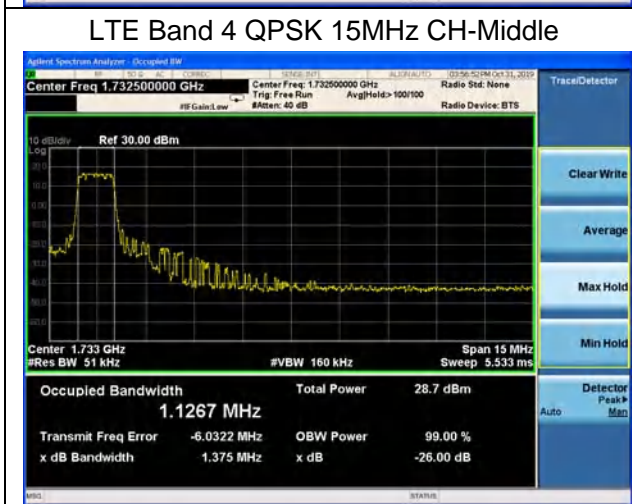
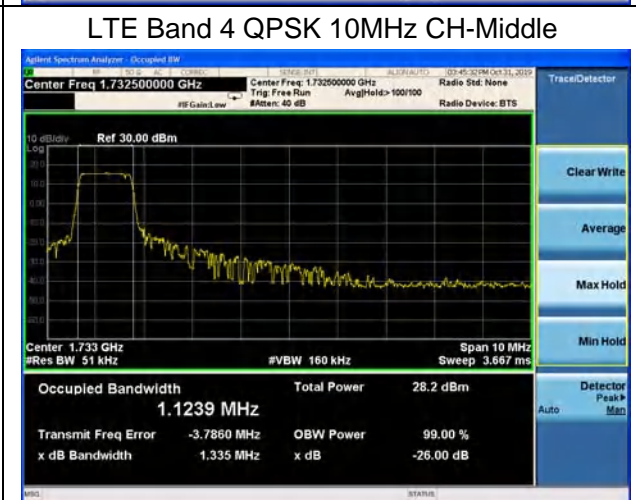
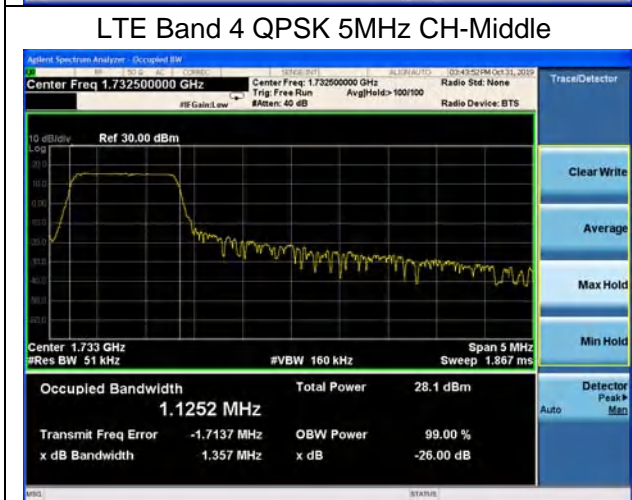
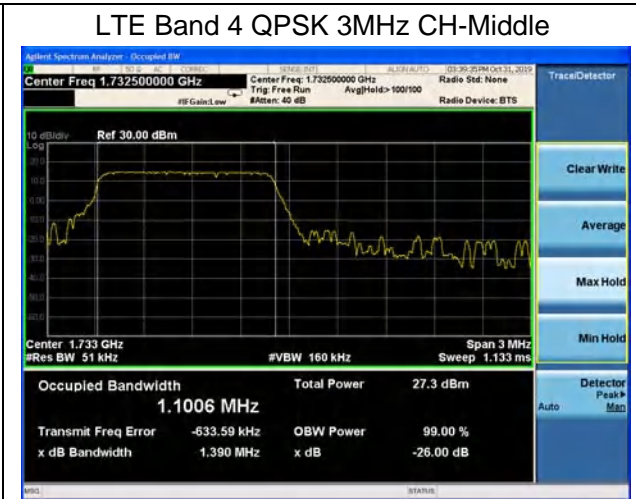
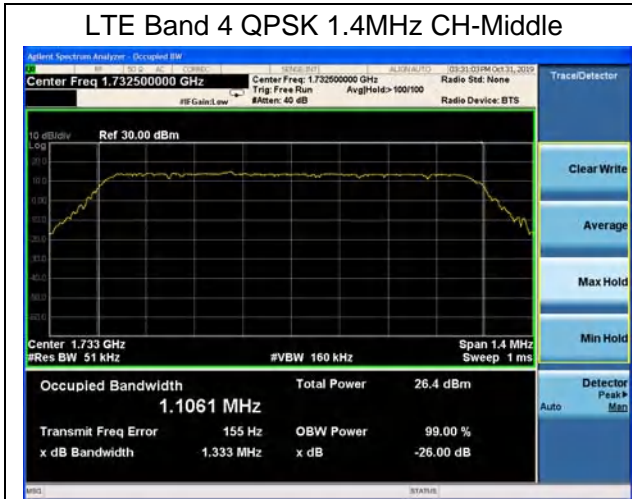

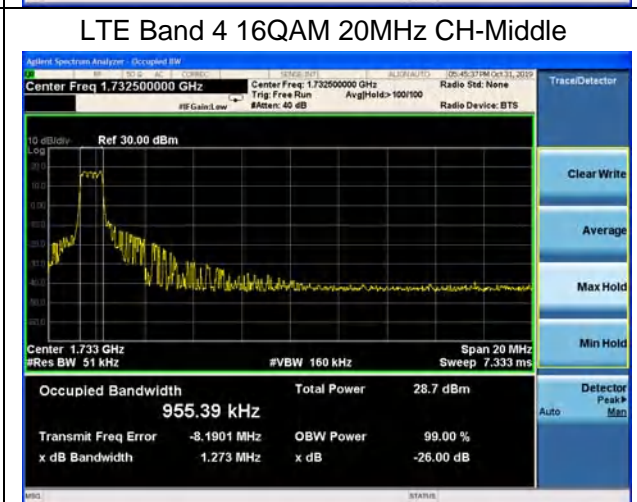
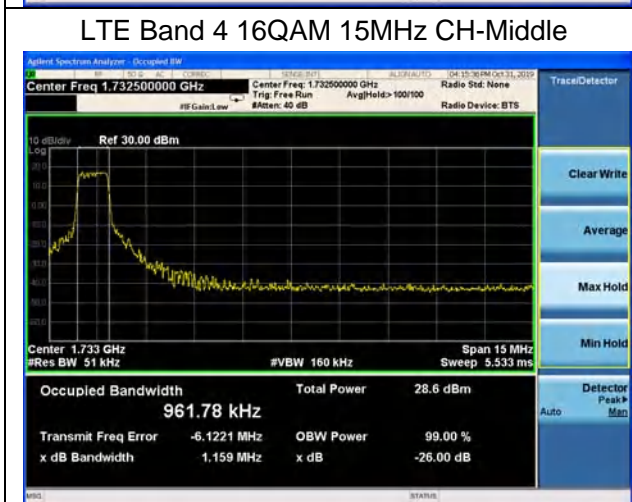
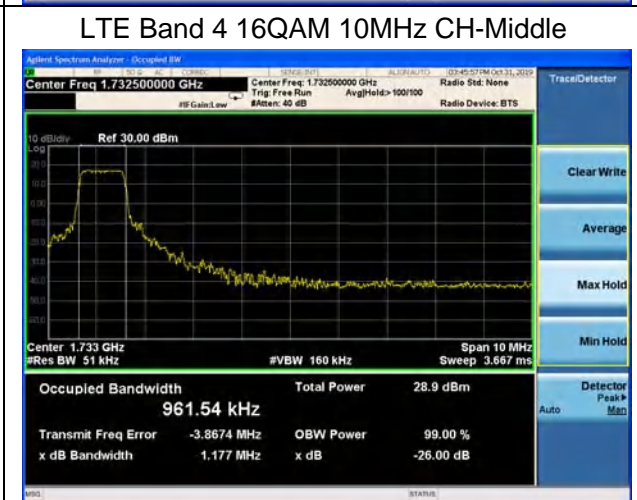
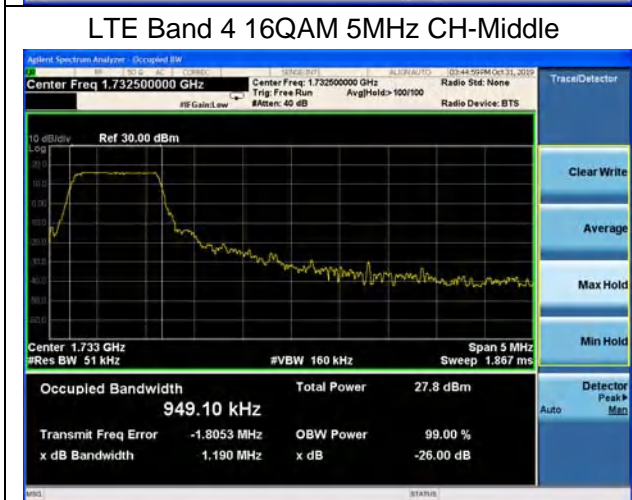
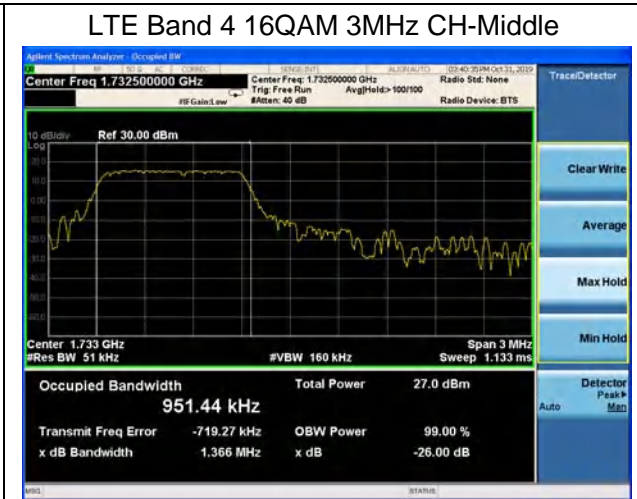
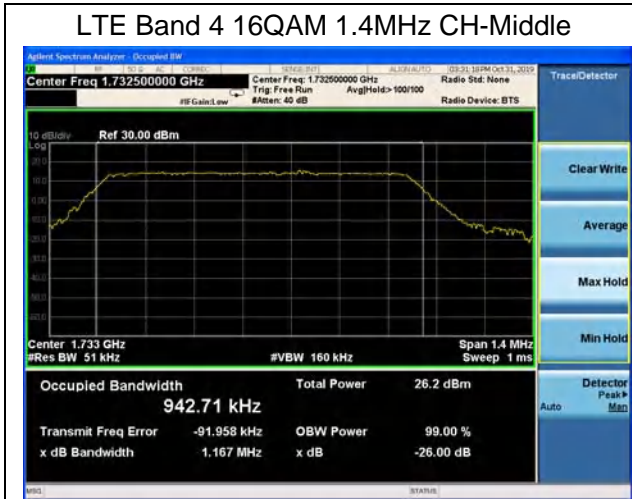



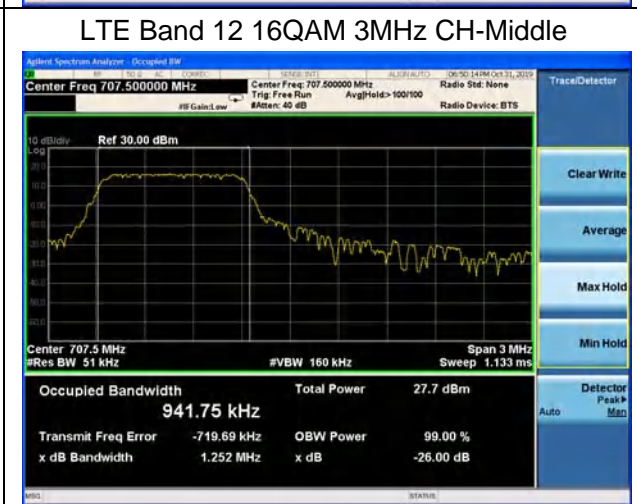
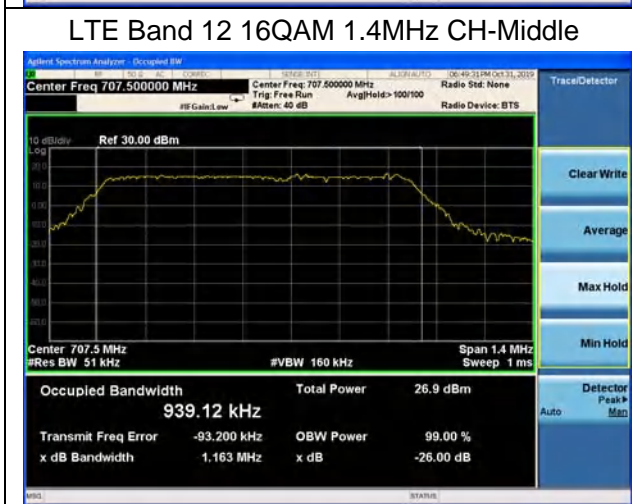
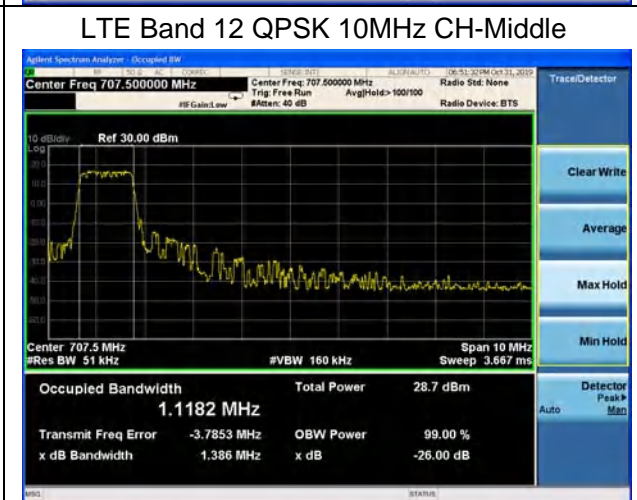
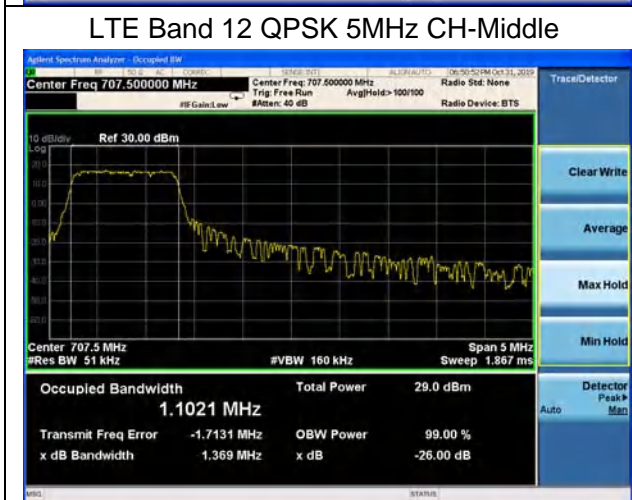
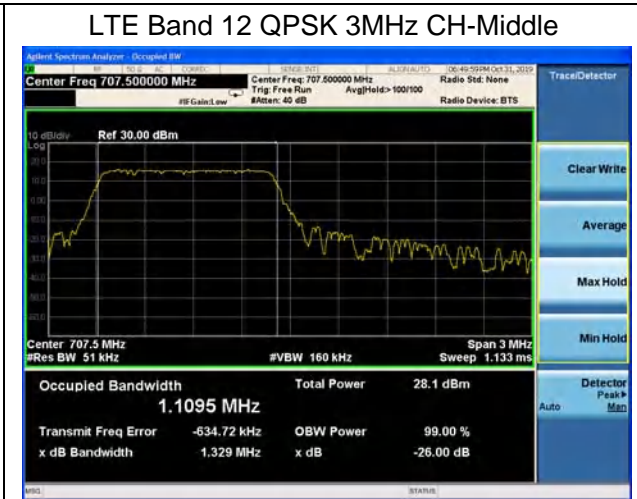
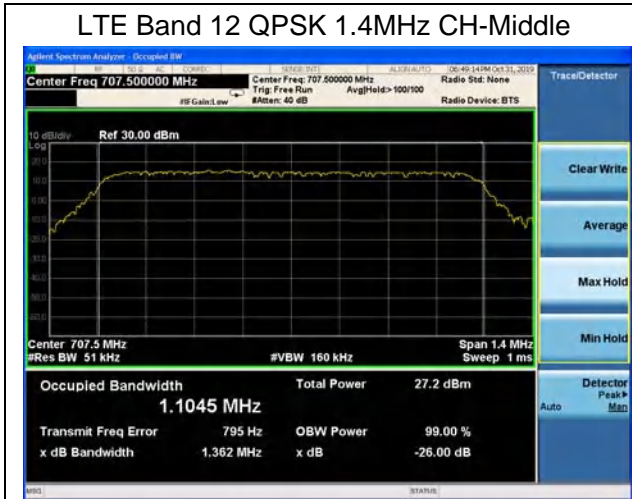

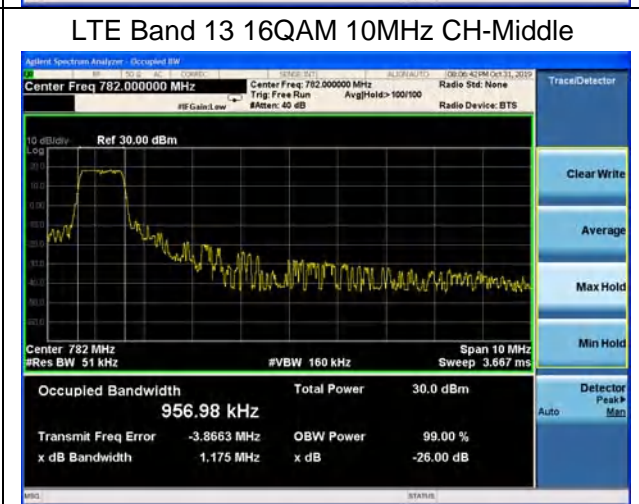
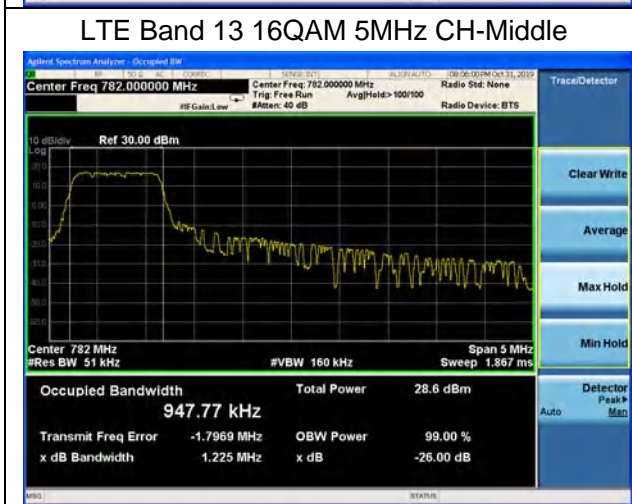
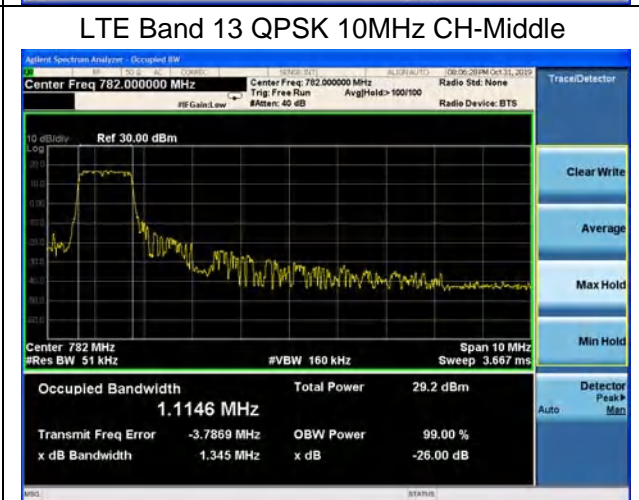
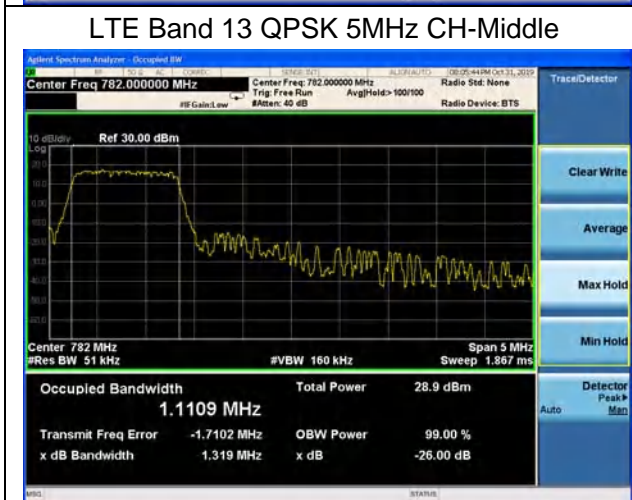
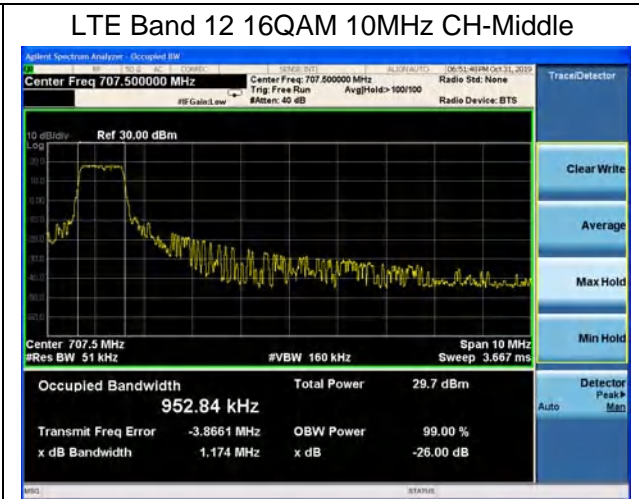
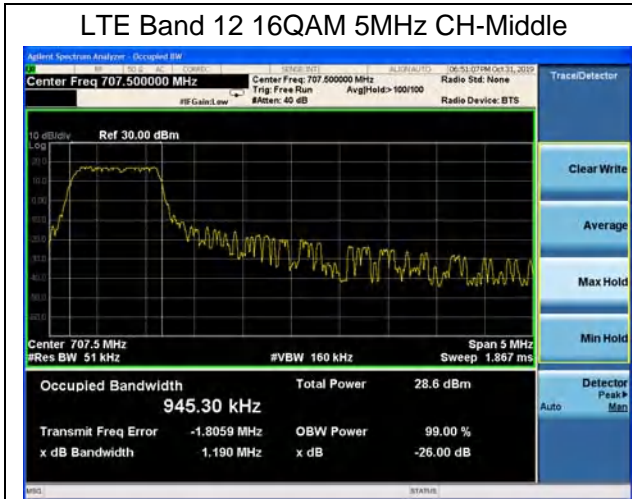



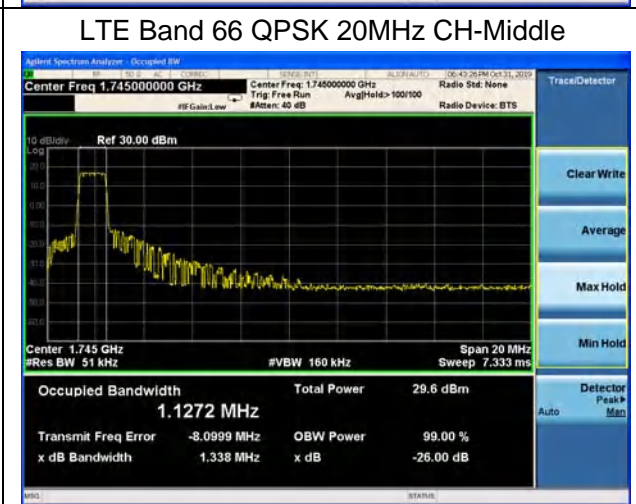
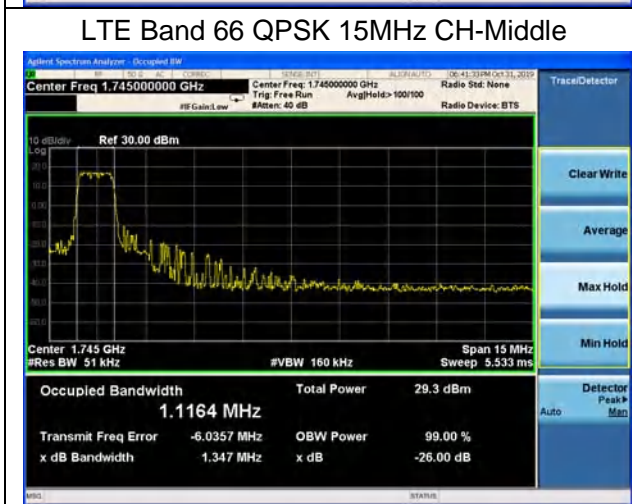
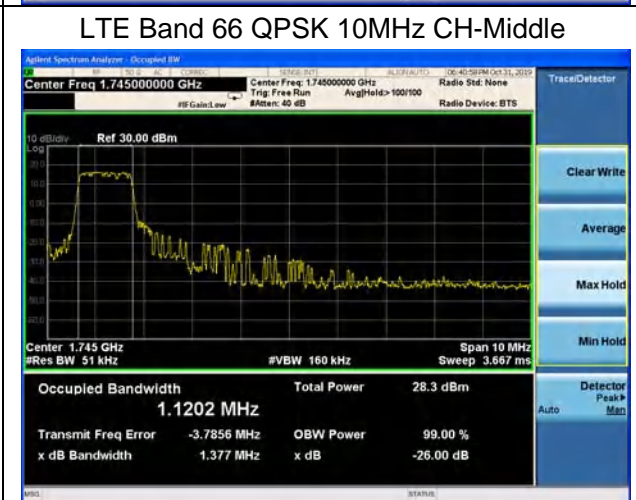
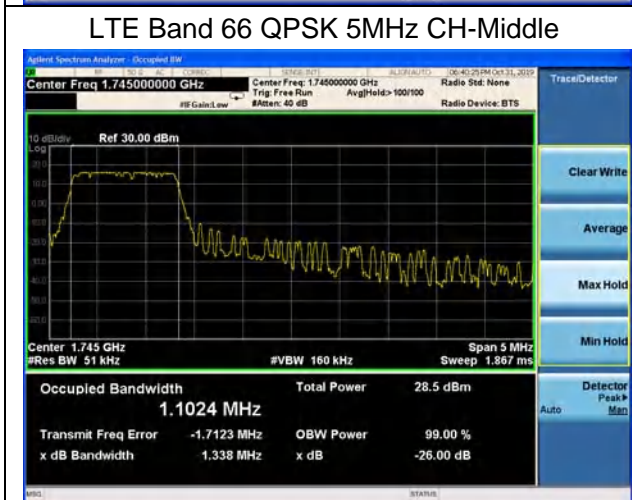
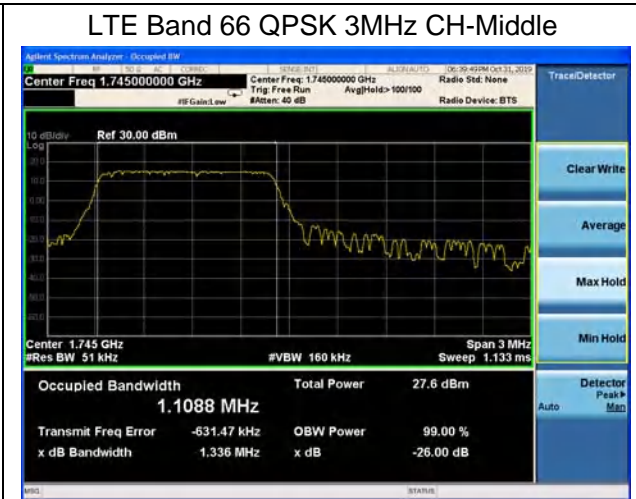
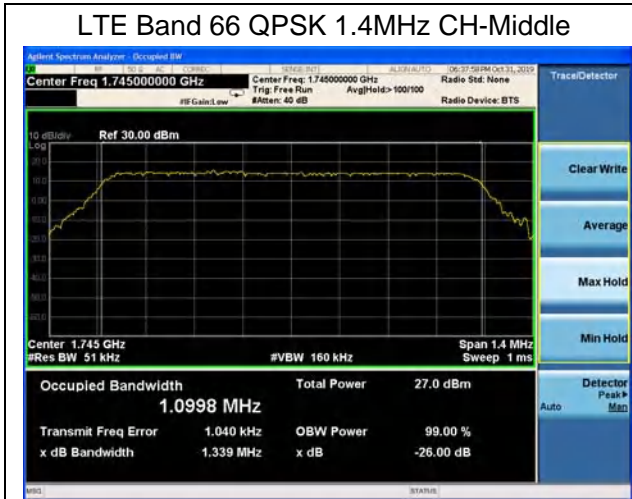



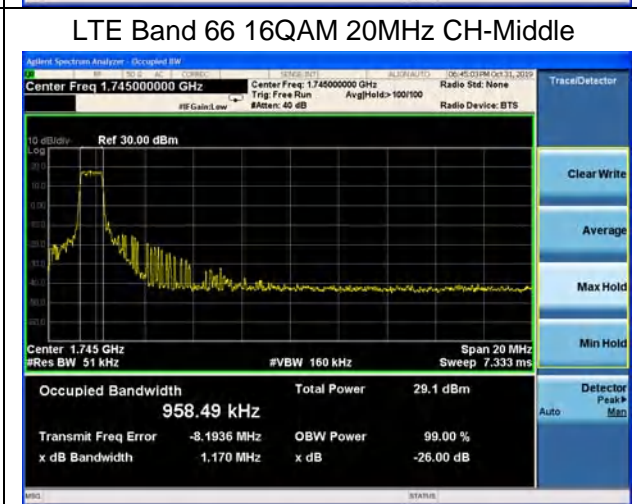
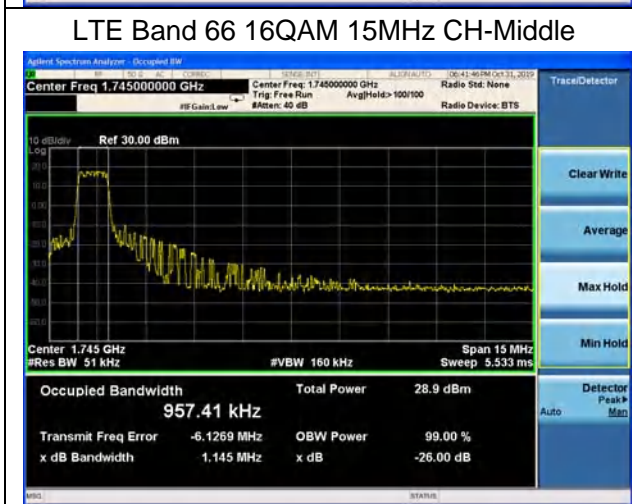
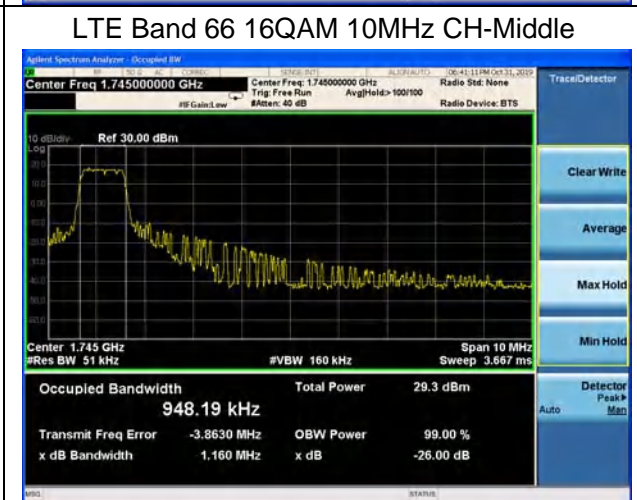
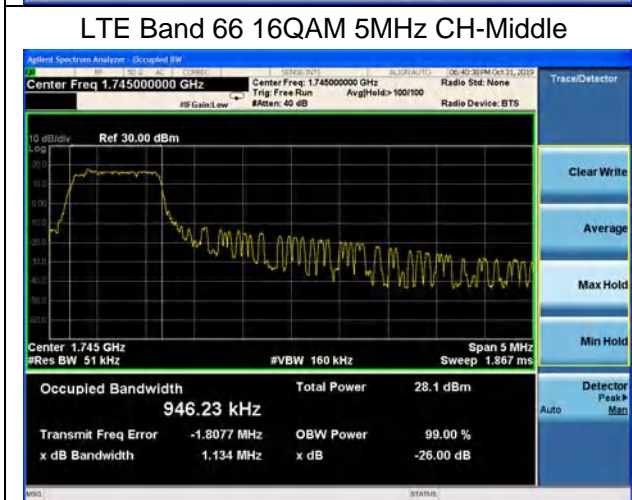
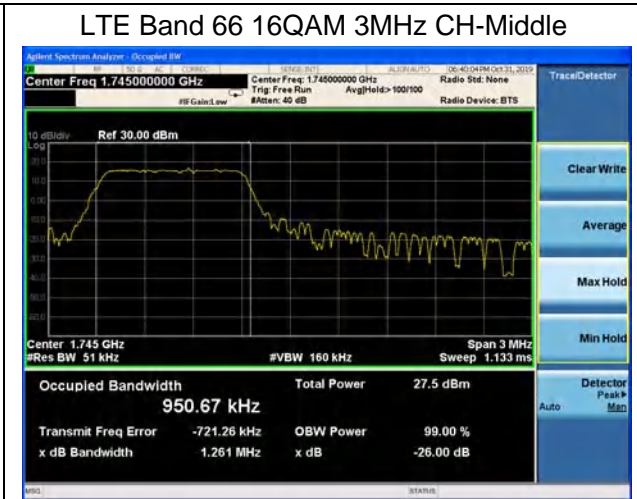

LTE Band 85 QPSK 5MHz CH-Middle



04:47:43 31.10.2020

LTE Band 85 QPSK 10MHz CH-Middle



04:49:06 31.10.2020

LTE Band 85 16QAM 5MHz CH-Middle



04:48:23 31.10.2020

LTE Band 85 16QAM 10MHz CH-Middle



04:49:25 31.10.2020

### 5.3 Band Edge Compliance

#### Ambient condition

Temperature	Relative humidity	Pressure
23°C ~25°C	45%~50%	101.5kPa

#### Method of Measurement

The EUT was connected to Spectrum Analyzer and Base Station Simulator via power Splitter. The band edge of the lowest and highest channels were measured.

The testing follows KDB 971168 D01 v03r01 Section 6.0

The EUT was connected to spectrum analyzer and system simulator via a power divider.

The band edges of low and high channels for the highest RF powers were measured.

RBW is set to 51kHz, VBW is set to 160kHz for LTE Band 4/12/66/85.

RBW is set to 6.25kHz, VBW is set to 18.75kHz for LTE Band 13.

on spectrum analyzer.

Set spectrum analyzer with RMS detector.

The RF fundamental frequency should be excluded against the limit line in the operating frequency band.

Checked that all the results comply with the emission limit line.

#### Test Setup

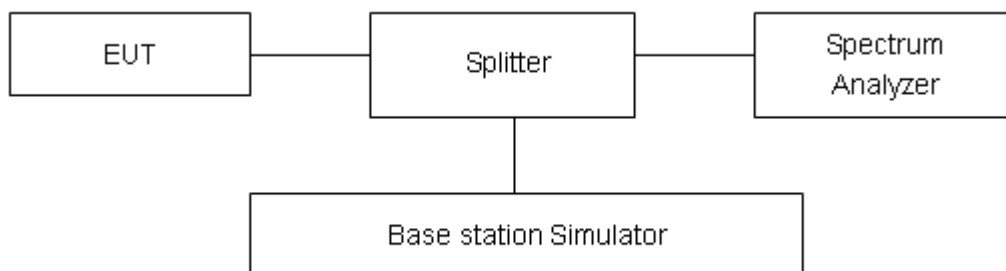

#### Limits

Rule Part 27.53(i) By a factor of not less than  $43 + 10 \log (P)$  dB on all frequencies between 2305 and 2320 MHz.

Rule Part 27.53(h) specifies that “ for operations in the 1695-1710 MHz, 1710-1755 MHz, 1755-1780 MHz, 1915-1920 MHz, 1995-2000 MHz, 2000-2020 MHz, 2110-2155 MHz, 2155-2180 MHz, and 2180-2200 bands, the power of any emission outside a licensee's frequency block shall be attenuated below the transmitter power (P) in watts by at least  $43 + 10 \log_{10} (P)$  dB”



Rule Part 27.53(g) For operations in the 600 MHz band and the 698-746 MHz band, the power of any emission outside a licensee's frequency band(s) of operation shall be attenuated below the transmitter power (P) within the licensed band(s) of operation, measured in watts, by at least  $43 + 10 \log (P)$  dB. Compliance with this provision is based on the use of measurement instrumentation employing a resolution bandwidth of 100 kilohertz or greater. However, in the 100 kilohertz bands immediately outside and adjacent to a licensee's frequency block, a resolution bandwidth of at least 30 kHz may be employed.

Rule Part 27.53(m) (4) specifies that "for BRS and EBS stations. For mobile digital stations, the attenuation factor shall be not less than  $40 + 10 \log (P)$  dB on all frequencies between the channel edge and 5 megahertz from the channel edge,  $43 + 10 \log (P)$  dB on all frequencies between 5 megahertz and X megahertz from the channel edge, and  $55 + 10 \log (P)$  dB on all frequencies more than X megahertz from the channel edge, where X is the greater of 6 megahertz or the actual emission bandwidth as defined in paragraph (m)(4) of this section. In addition, the attenuation factor shall not be less that  $43 + 10 \log (P)$  dB on all frequencies between 2490.5 MHz and 2496 MHz and  $55 + 10 \log (P)$  dB at or below 2490.5 MHz. Mobile Satellite Service licensees operating on frequencies below 2495 MHz may also submit a documented interference complaint against BRS licensees operating on channel BRS Channel 1 on the same terms and conditions as adjacent channel BRS or EBS licensees.

Example:

The limit line is derived from  $43 + 10 \log (P)$  dB below the transmitter power P(Watts)  
= P(W)- [43 + 10log(P)] (dB)  
= [30 + 10log (P)] (dBm) - [43 + 10log(P)] (dB) = -13dBm.

Rule Part 27.53(f) For operations in the 746-758 MHz, 775-788 MHz, and 805-806 MHz bands, emissions in the band 1559-1610 MHz shall be limited to  $-70$  dBW/MHz equivalent isotropically radiated power (EIRP) for wideband signals, and  $-80$  dBW EIRP for discrete emissions of less than 700 Hz bandwidth. For the purpose of equipment authorization, a transmitter shall be tested with an antenna that is representative of the type that will be used with the equipment in normal operation.

Rule Part 27.53 (c) For operations in the 746-758 MHz band and the 776-788 MHz band, the power of any emission outside the licensee's frequency band(s) of operation shall be attenuated below the transmitter power (P) within the licensed band(s) of operation, measured in watts, in accordance with the following:

- (1) On any frequency outside the 746-758 MHz band, the power of any emission shall be attenuated outside the band below the transmitter power (P) by at least  $43 + 10 \log (P)$  dB;
- (2) On any frequency outside the 776-788 MHz band, the power of any emission shall be attenuated outside the band below the transmitter power (P) by at least  $43 + 10 \log (P)$  dB;
- (3) On all frequencies between 763-775 MHz and 793-805 MHz, by a factor not less than  $76 + 10 \log (P)$  dB in a 6.25 kHz band segment, for base and fixed stations;
- (4) On all frequencies between 763-775 MHz and 793-805 MHz, by a factor not less than  $65 + 10 \log (P)$  dB in a 6.25 kHz band segment, for mobile and portable stations;
- (5) Compliance with the provisions of paragraphs (c)(1) and (c)(2) of this section is based on the use of measurement instrumentation employing a resolution bandwidth of 100 kHz or greater. However, in



the 100 kHz bands immediately outside and adjacent to the frequency block, a resolution bandwidth of at least 30 kHz may be employed;

### Measurement Uncertainty

The assessed measurement uncertainty to ensure 95% confidence level for the normal distribution is with the coverage factor  $k = 1.96$ ,  $U=0.684\text{dB}$ .





### Test Result

All the test traces in the plots shows the test results clearly.

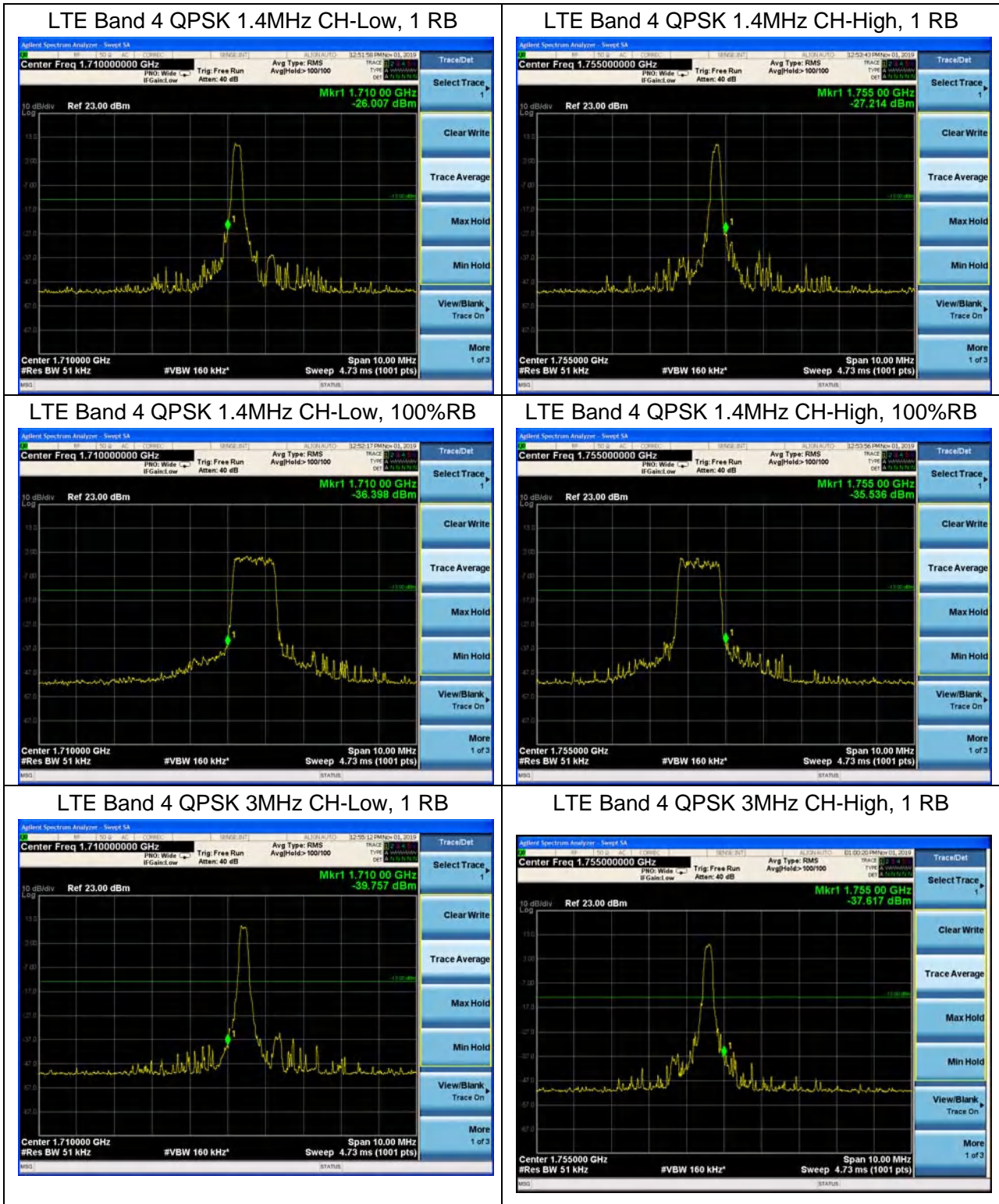



LTE Band 4 QPSK 3MHz CH-Low, 100%RB



LTE Band 4 QPSK 3MHz CH-High, 100%RB



LTE Band 4 QPSK 5MHz CH-Low, 1 RB

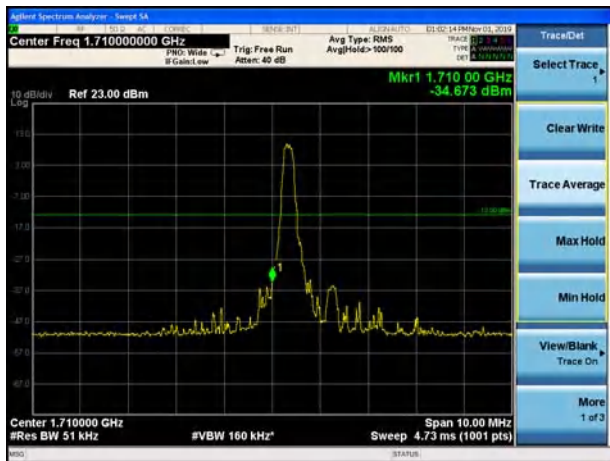

LTE Band 4 QPSK 5MHz CH-High, 1 RB

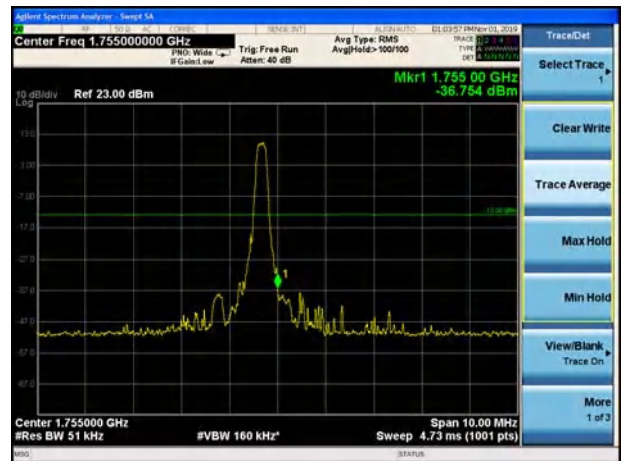

LTE Band 4 QPSK 5MHz CH-Low, 100%RB

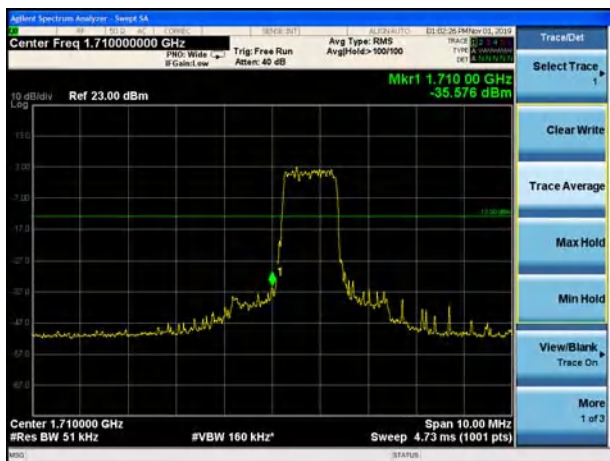

LTE Band 4 QPSK 5MHz CH-High, 100%RB

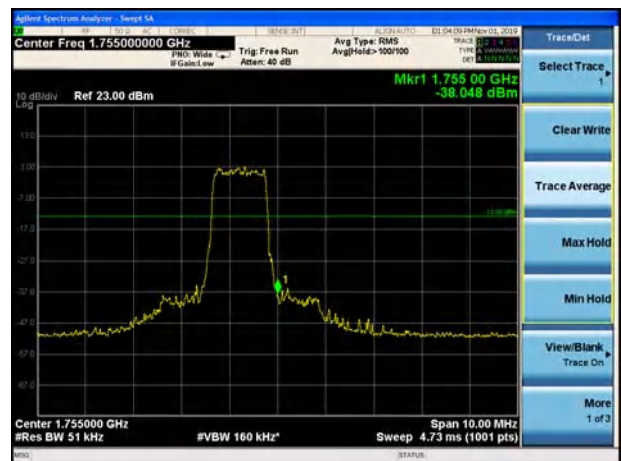





LTE Band 4 QPSK 10MHz CH-Low, 1 RB

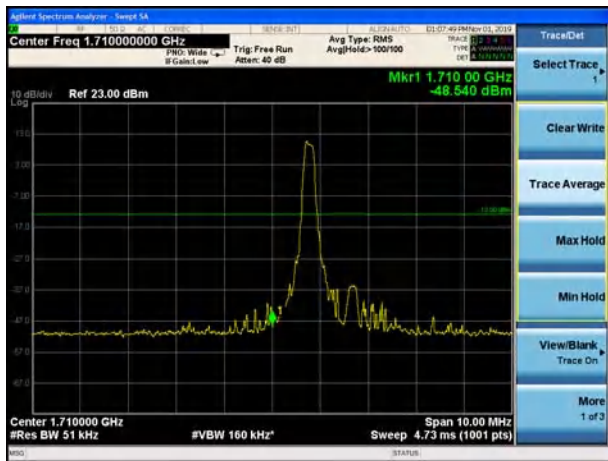

LTE Band 4 QPSK 10MHz CH-High, 1 RB

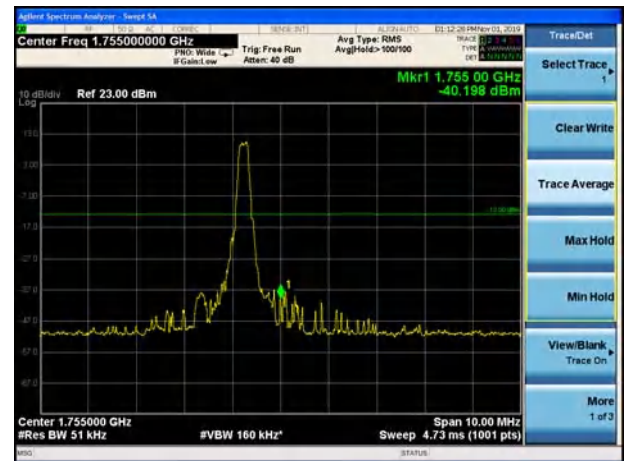

LTE Band 4 QPSK 10MHz CH-Low, 100%RB

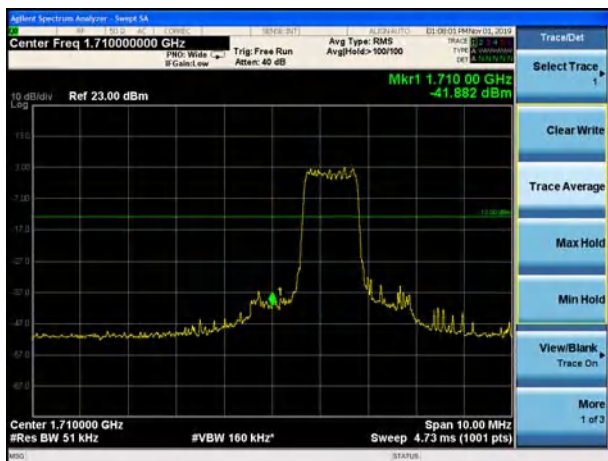

LTE Band 4 QPSK 10MHz CH-High, 100%RB

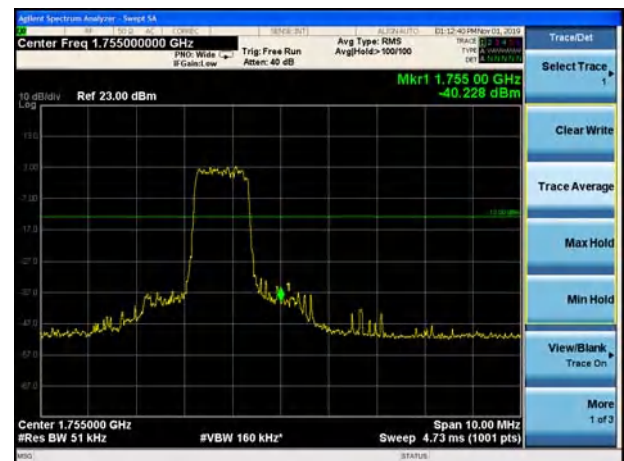

LTE Band 4 QPSK 15MHz CH-Low, 1 RB

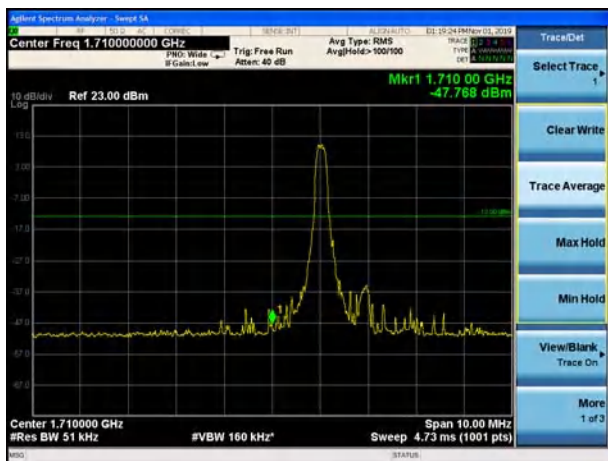

LTE Band 4 QPSK 15MHz CH-High, 1 RB

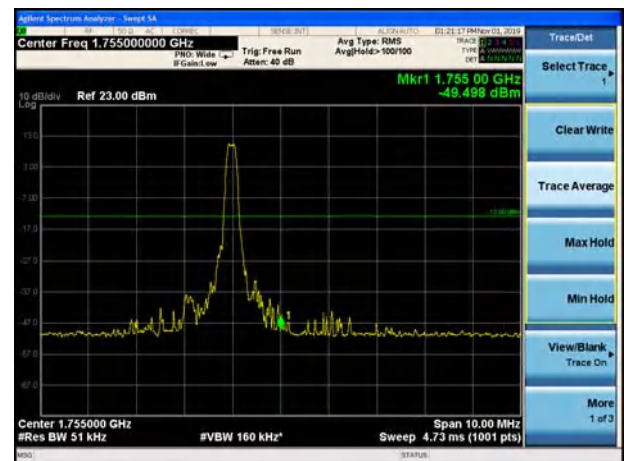





LTE Band 4 QPSK 15MHz CH-Low, 100%RB



LTE Band 4 QPSK 15MHz CH-High, 100%RB



LTE Band 4 QPSK 20MHz CH-Low, 1 RB

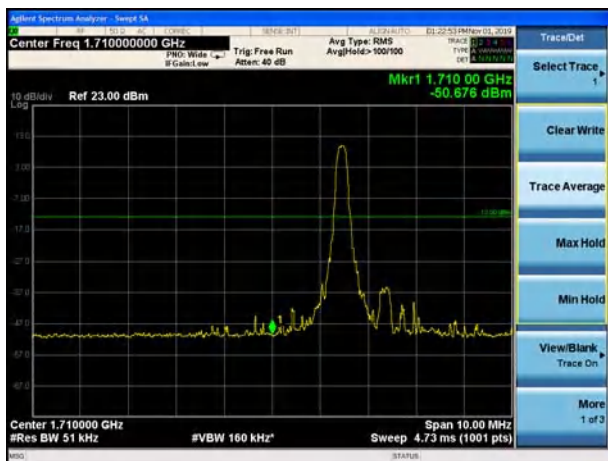

LTE Band 4 QPSK 20MHz CH-High, 1 RB

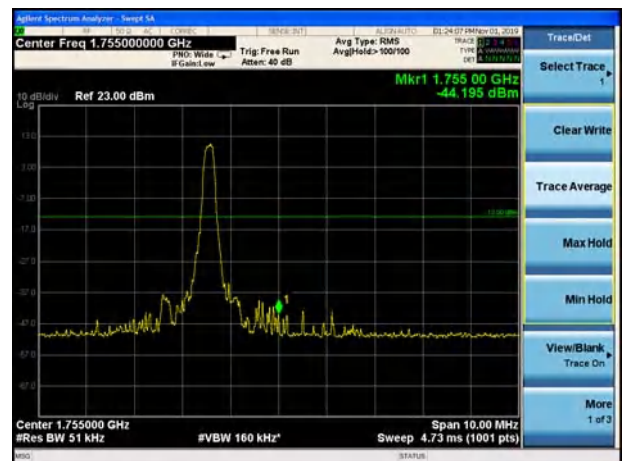

LTE Band 4 QPSK 20MHz CH-Low, 100%RB

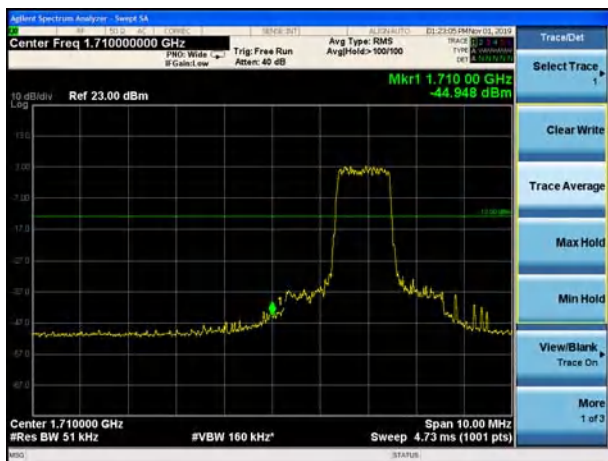

LTE Band 4 QPSK 20MHz CH-High, 100%RB

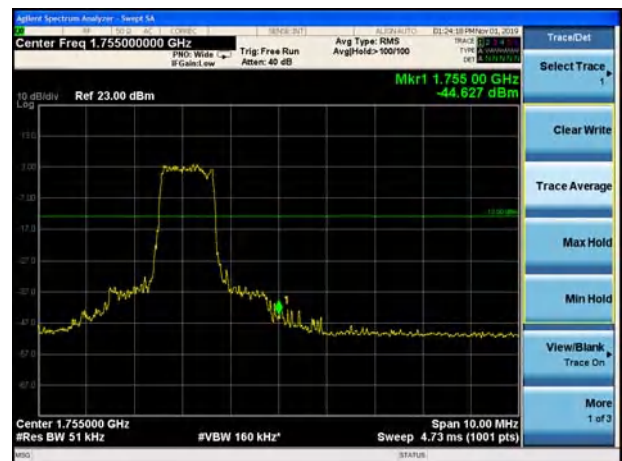

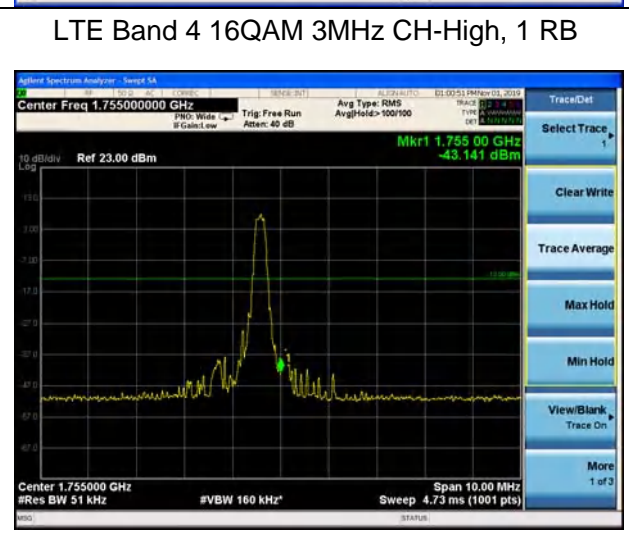
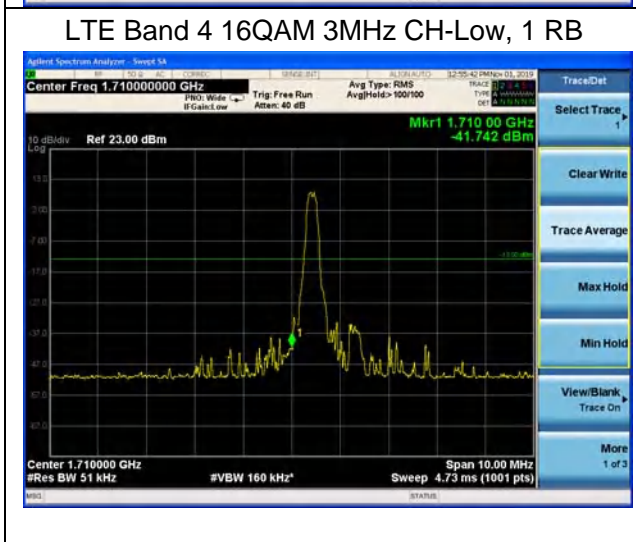
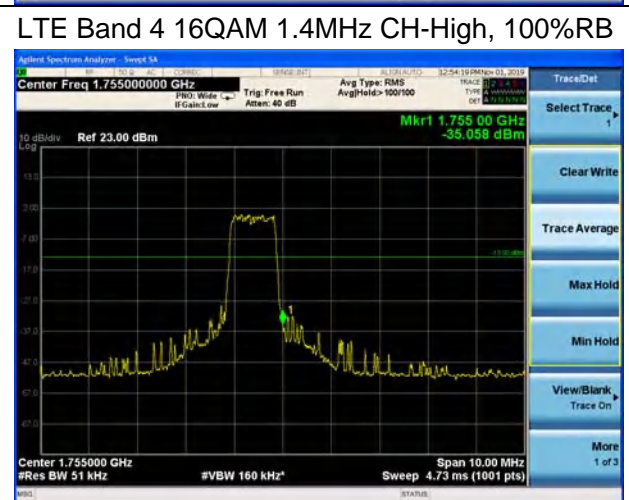
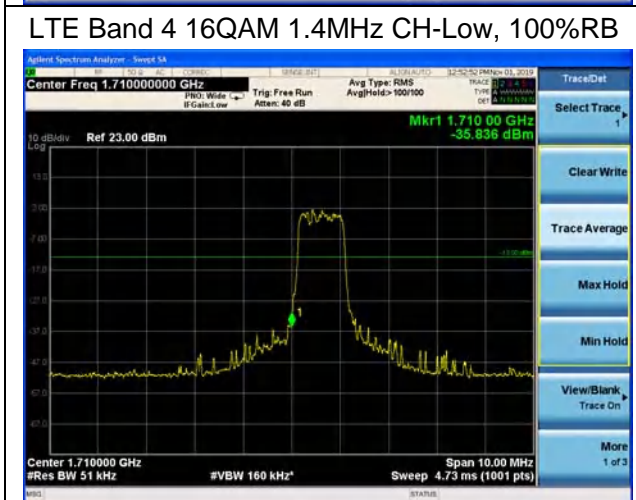
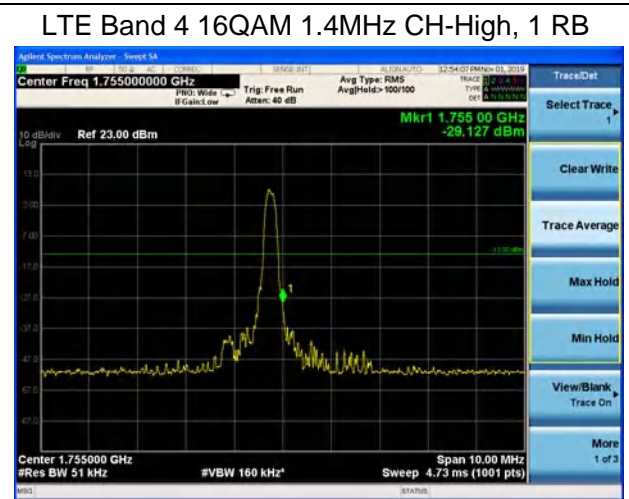
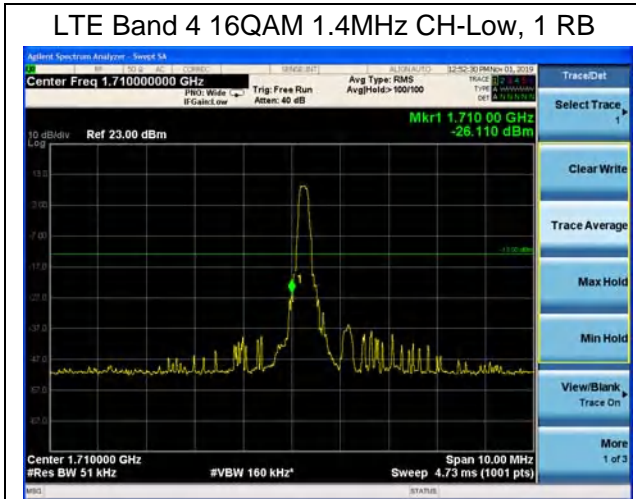





LTE Band 4 16QAM 3MHz CH-Low, 100%RB



LTE Band 4 16QAM 3MHz CH-High, 100%RB

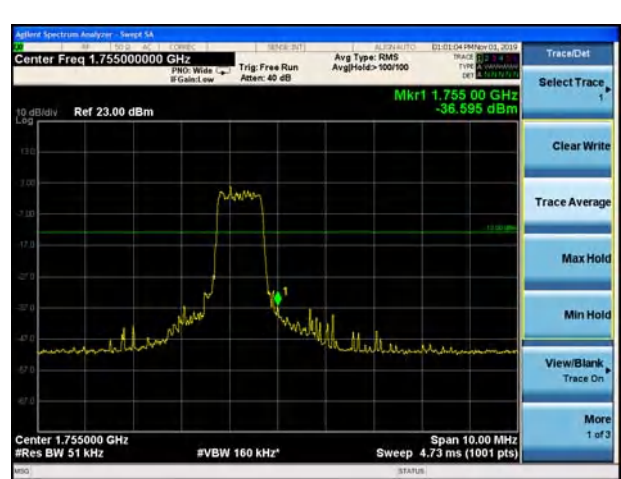

LTE Band 4 16QAM 5MHz CH-Low, 1 RB



LTE Band 4 16QAM 5MHz CH-High, 1 RB



LTE Band 4 16QAM 5MHz CH-Low, 100%RB

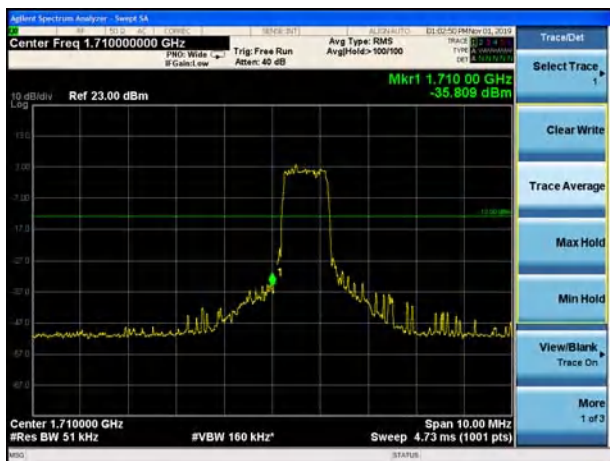

LTE Band 4 16QAM 5MHz CH-High, 100%RB

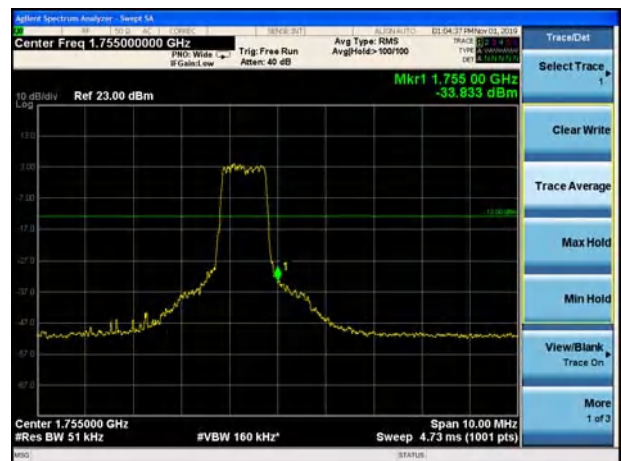



LTE Band 4 16QAM 10MHz CH-Low, 1 RB

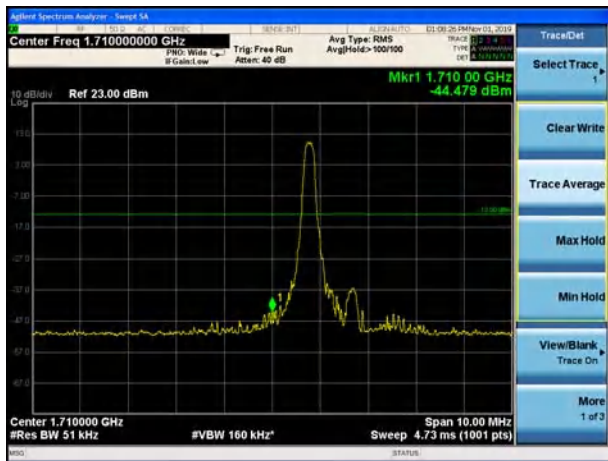

LTE Band 4 16QAM 10MHz CH-High, 1 RB



LTE Band 4 16QAM 10MHz CH-Low, 100%RB

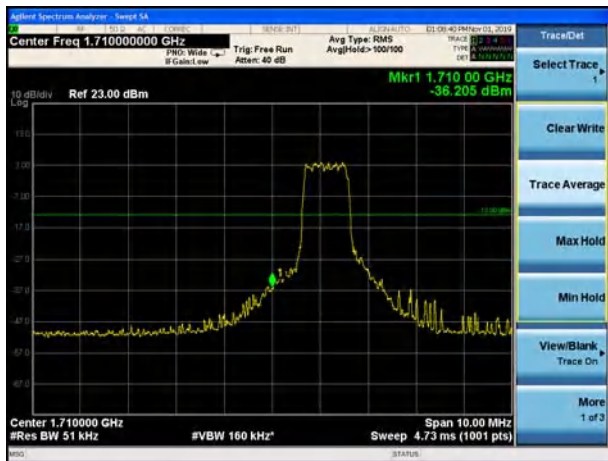

LTE Band 4 16QAM 10MHz CH-High, 100%RB

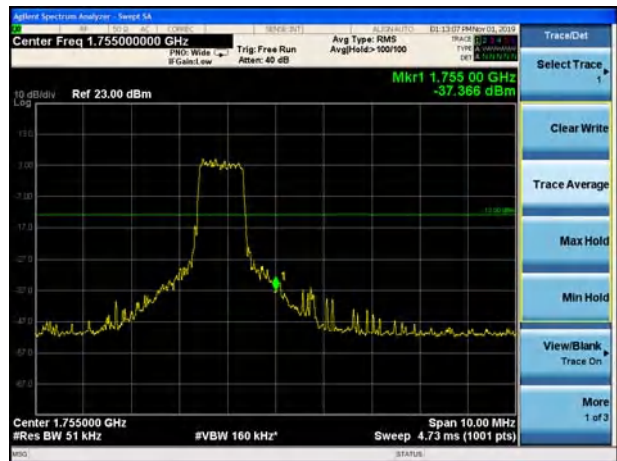

LTE Band 4 16QAM 15MHz CH-Low, 1 RB

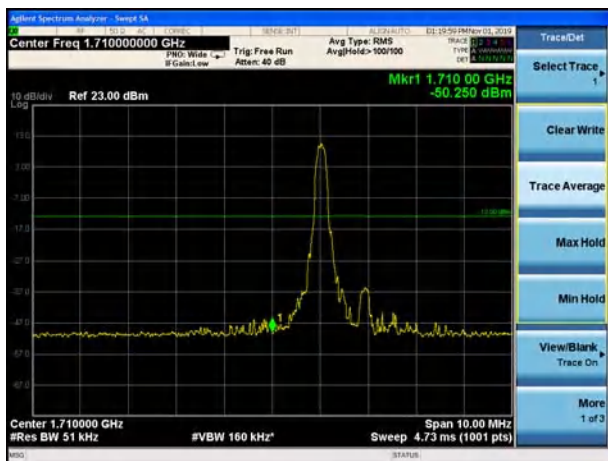

LTE Band 4 16QAM 15MHz CH-High, 1 RB

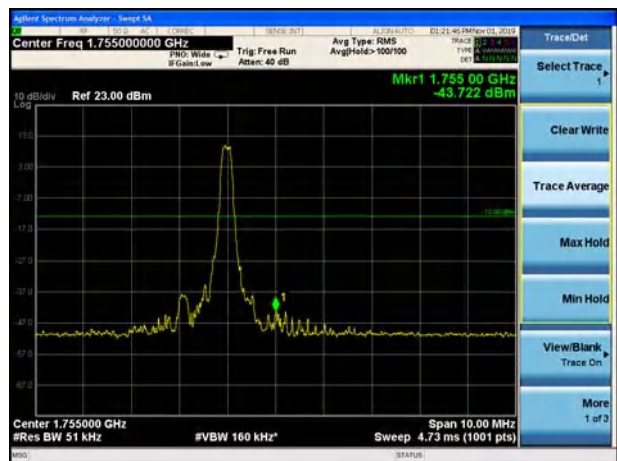





LTE Band 4 16QAM 15MHz CH-Low, 100%RB

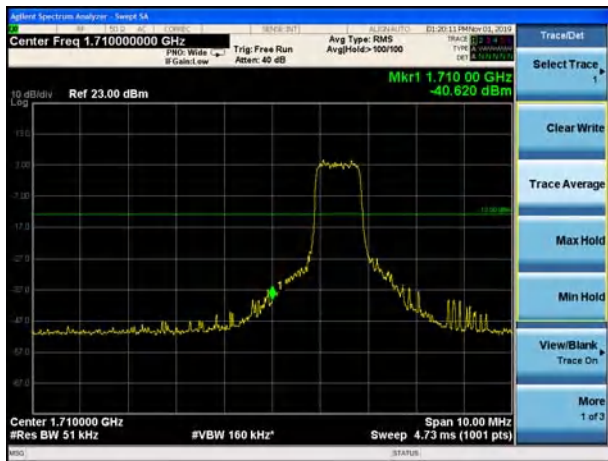

LTE Band 4 16QAM 15MHz CH-High, 100%RB

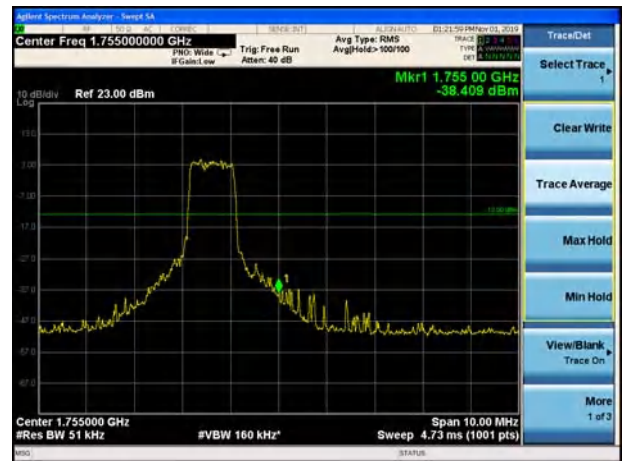

LTE Band 4 16QAM 20MHz CH-Low, 1 RB



LTE Band 4 16QAM 20MHz CH-High, 1 RB

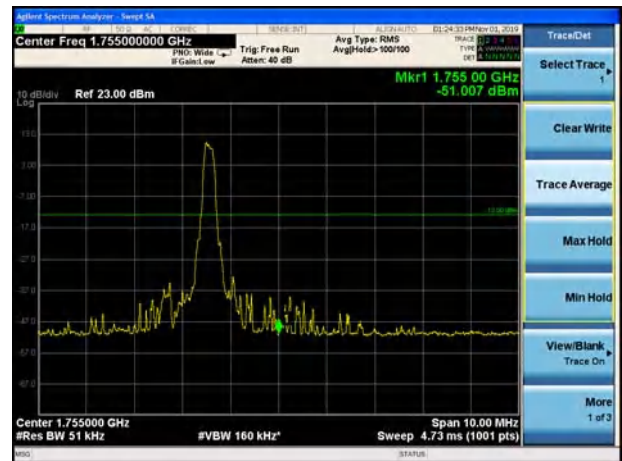

LTE Band 4 16QAM 20MHz CH-Low, 100%RB

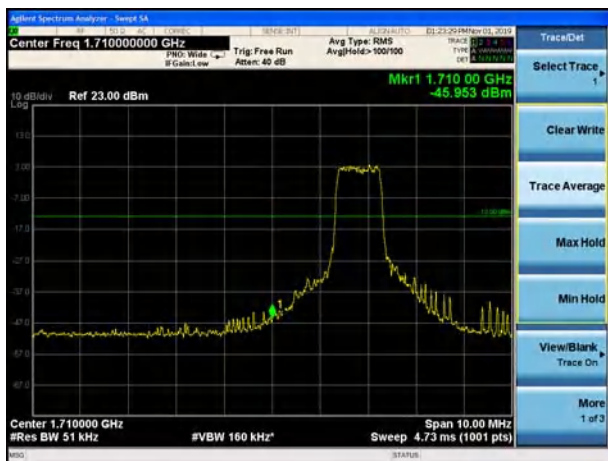

LTE Band 4 16QAM 20MHz CH-High, 100%RB

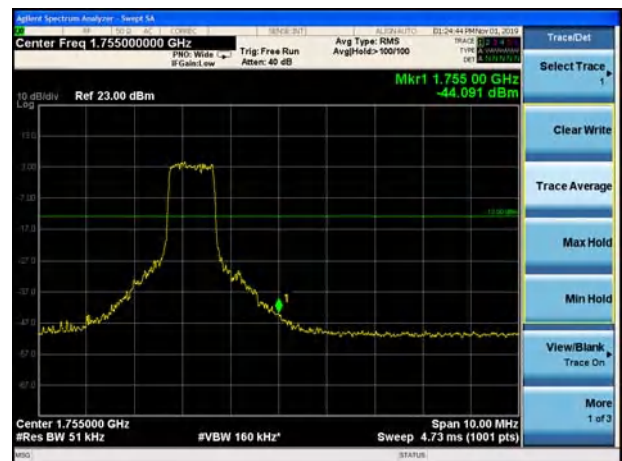



LTE Band 12 QPSK 1.4MHz CH-Low, 1 RB

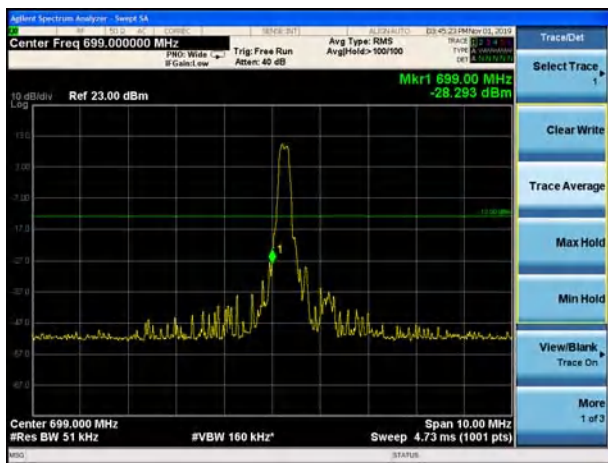

LTE Band 12 QPSK 1.4MHz CH-High, 1 RB

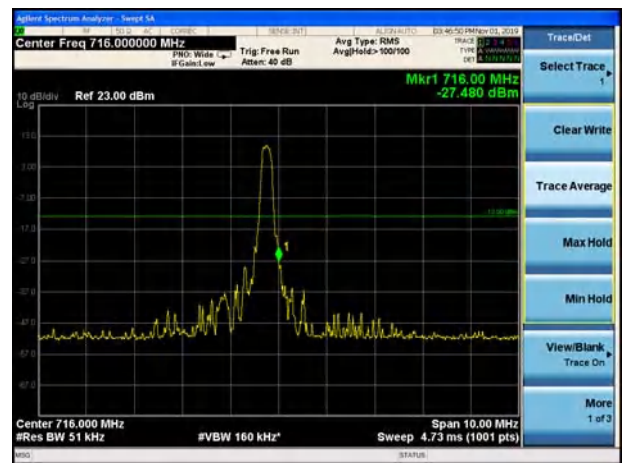

LTE Band 12 QPSK 1.4MHz CH-Low, 100%RB



LTE Band 12 QPSK 1.4MHz CH-High, 100%RB

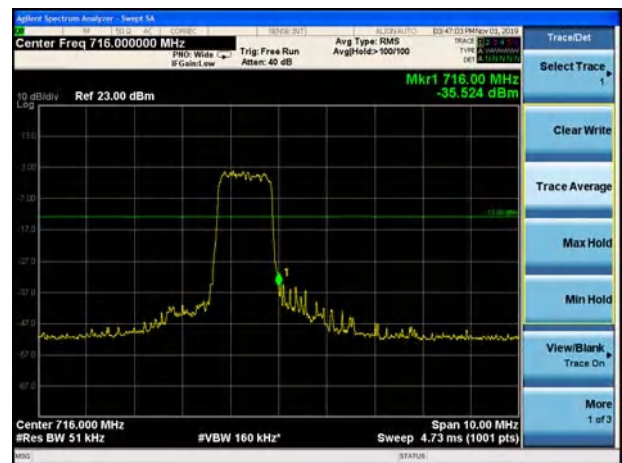

LTE Band 12 QPSK 3MHz CH-Low, 1 RB

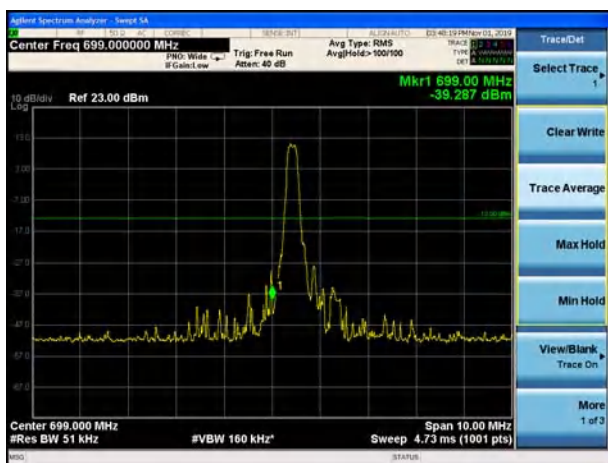

LTE Band 12 QPSK 3MHz CH-High, 1 RB

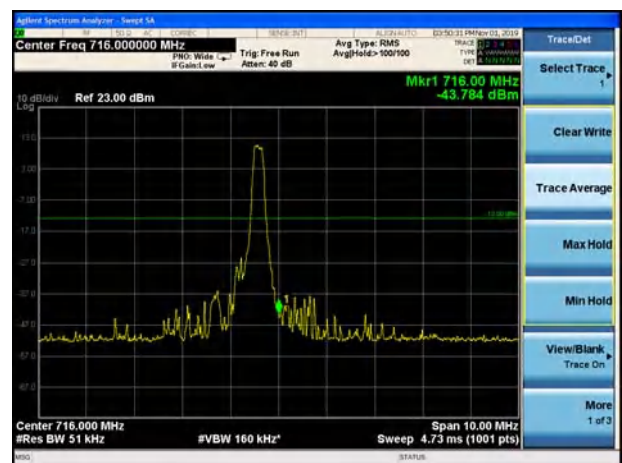





### LTE Band 12 QPSK 3MHz CH-Low, 100%RB

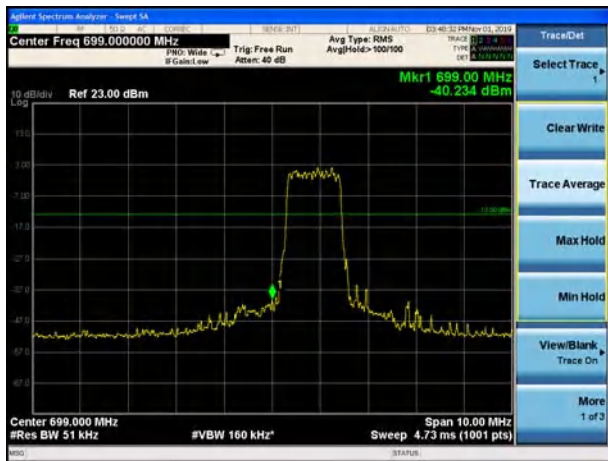

### LTE Band 12 QPSK 3MHz CH-High, 100%RB

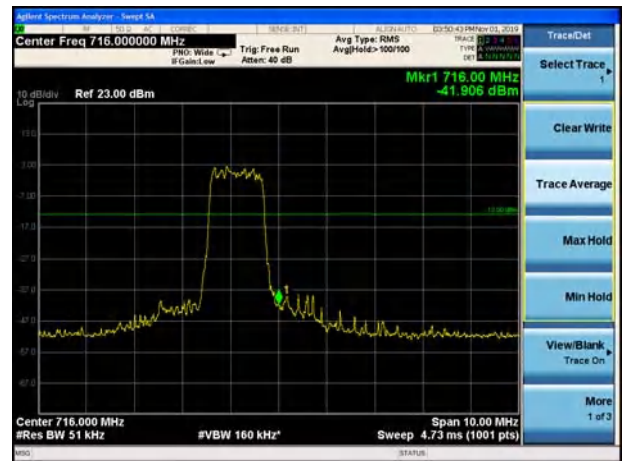

### LTE Band 12 QPSK 5MHz CH-Low, 1 RB

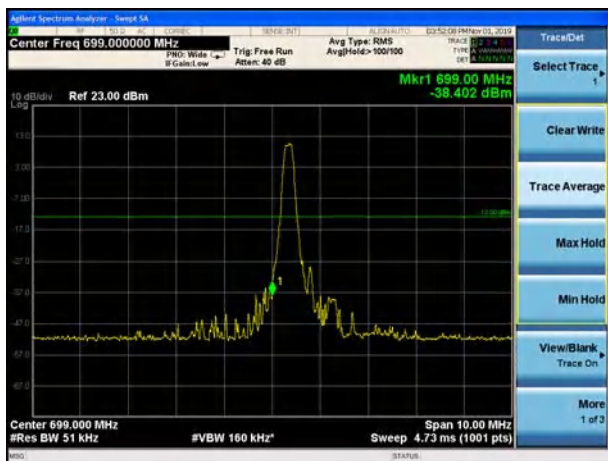

### LTE Band 12 QPSK 5MHz CH-High, 1 RB

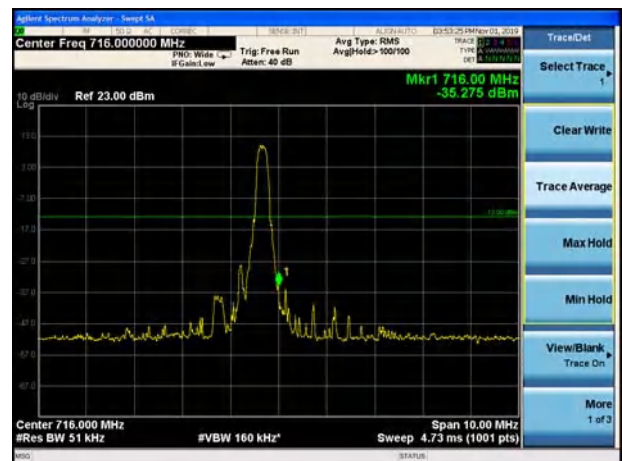

### LTE Band 12 QPSK 5MHz CH-Low, 100%RB

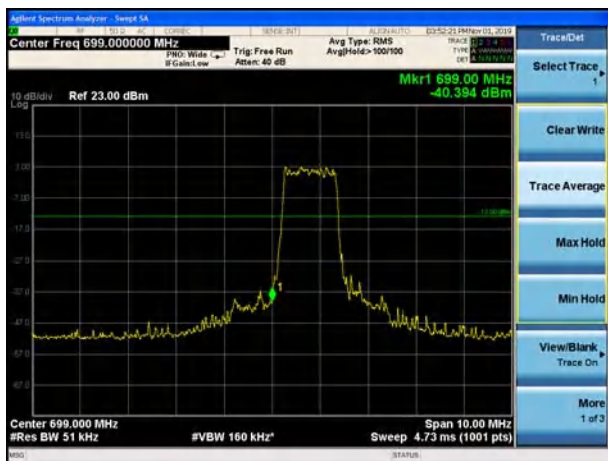

### LTE Band 12 QPSK 5MHz CH-High, 100%RB

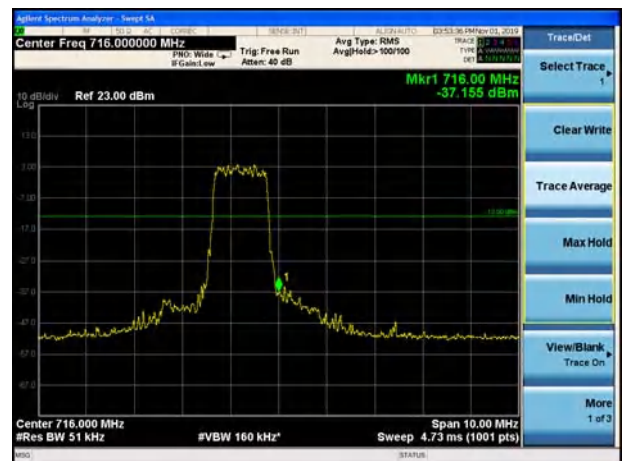

LTE Band 12 QPSK 10MHz CH-Low, 1 RB

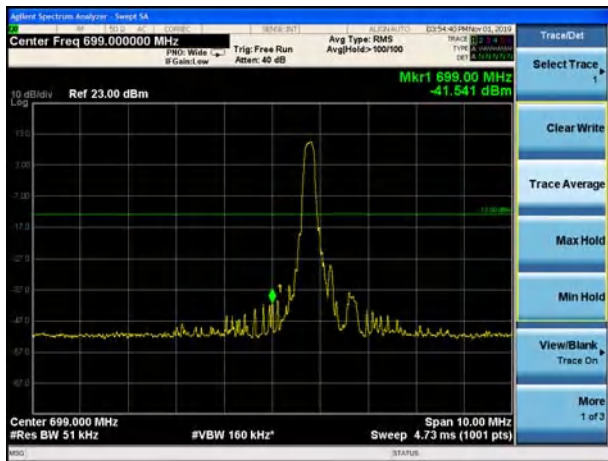

LTE Band 12 QPSK 10MHz CH-High, 1 RB

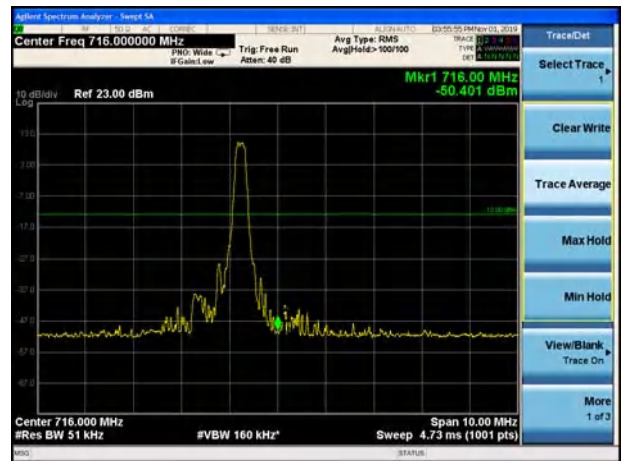

LTE Band 12 QPSK 10MHz CH-Low, 100%RB

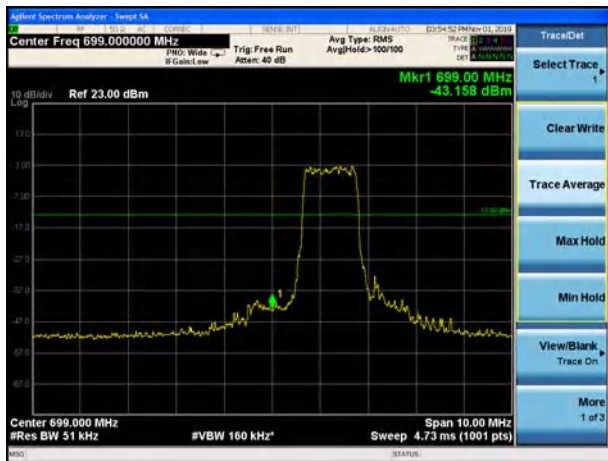

LTE Band 12 QPSK 10MHz CH-High, 100%RB

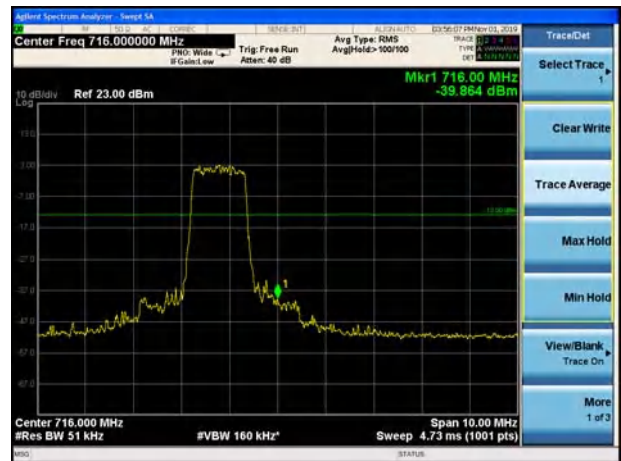

LTE Band 12 16QAM 1.4MHz CH-Low, 1 RB



LTE Band 12 16QAM 1.4MHz CH-High, 1 RB

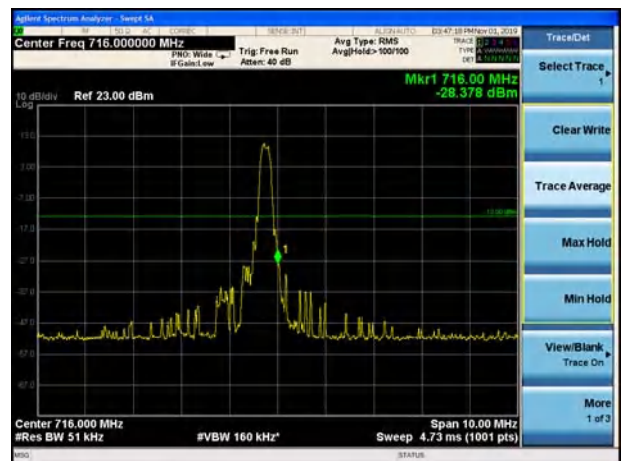





LTE Band 12 16QAM 1.4MHz CH-Low, 100%RB

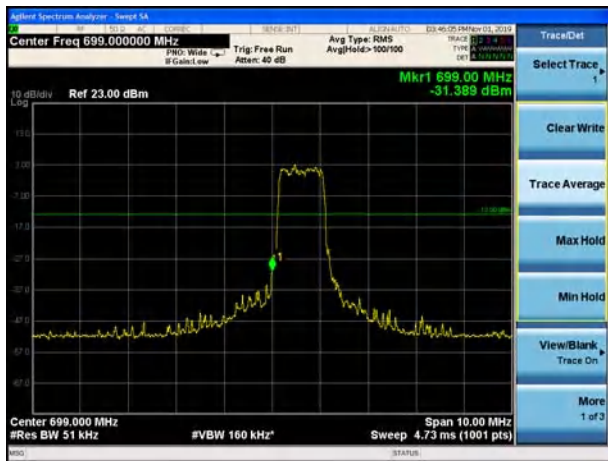

LTE Band 12 16QAM 1.4MHz CH-High, 100%RB



LTE Band 12 16QAM 3MHz CH-Low, 1 RB

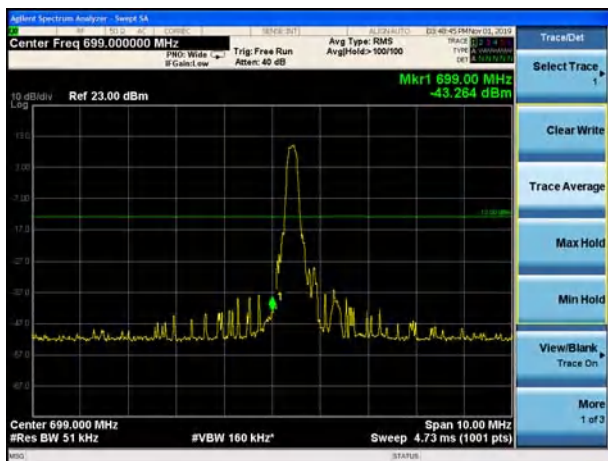

LTE Band 12 16QAM 3MHz CH-High, 1 RB

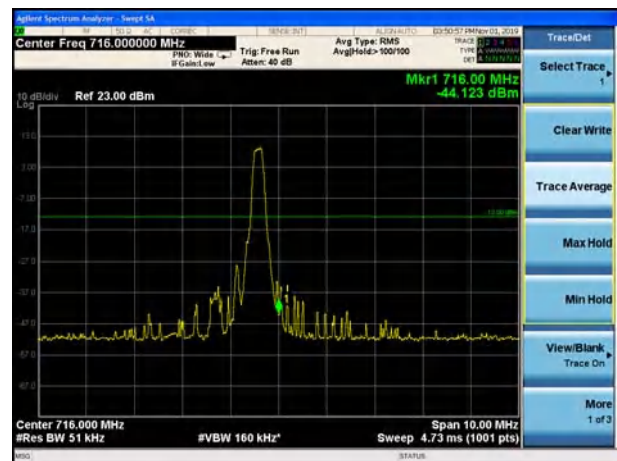

LTE Band 12 16QAM 3MHz CH-Low, 100%RB

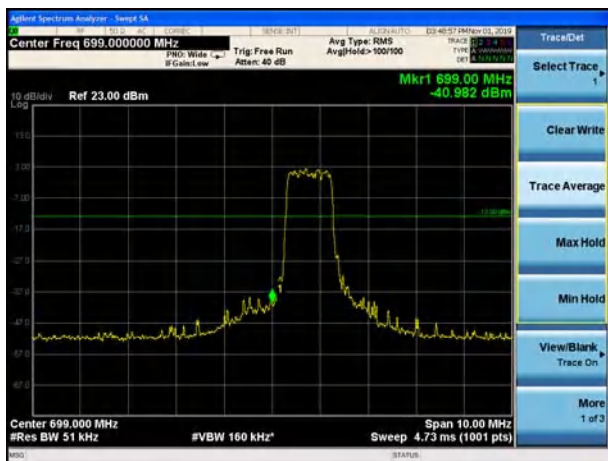

LTE Band 12 16QAM 3MHz CH-High, 100%RB

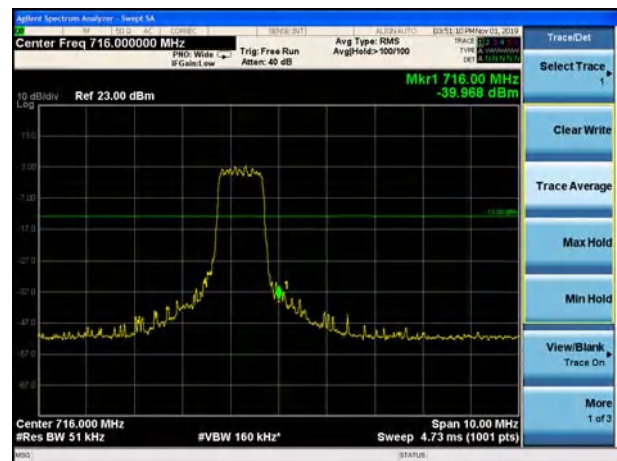



LTE Band 12 16QAM 5MHz CH-Low, 1 RB

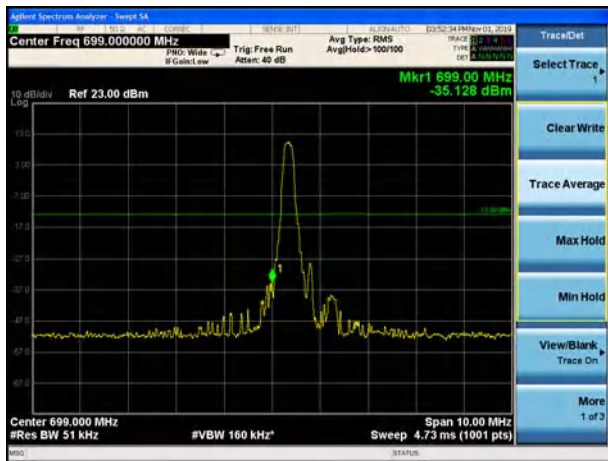

LTE Band 12 16QAM 5MHz CH-High, 1 RB

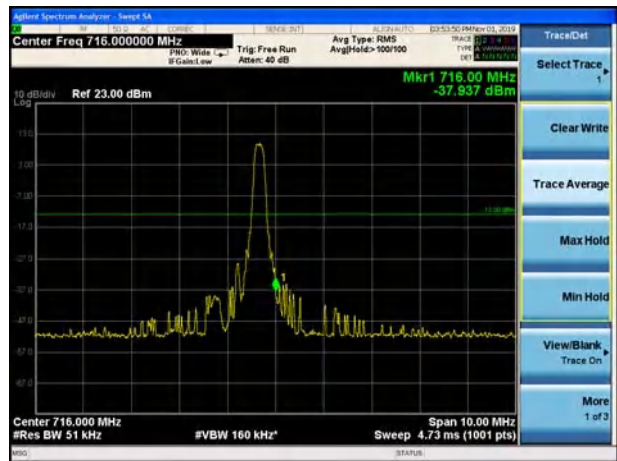

LTE Band 12 16QAM 5MHz CH-Low, 100%RB

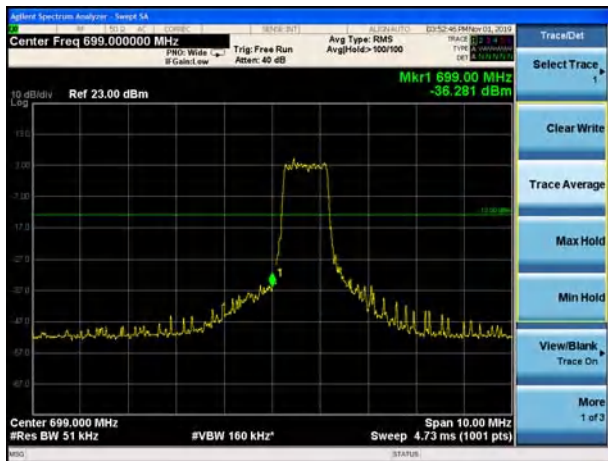

LTE Band 12 16QAM 5MHz CH-High, 100%RB

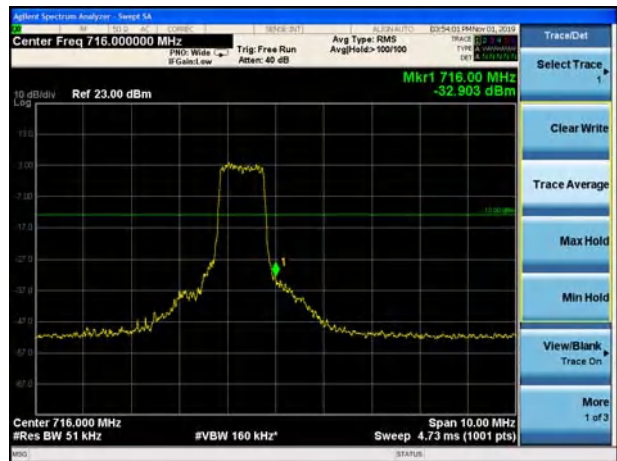

LTE Band 12 16QAM 10MHz CH-Low, 1 RB

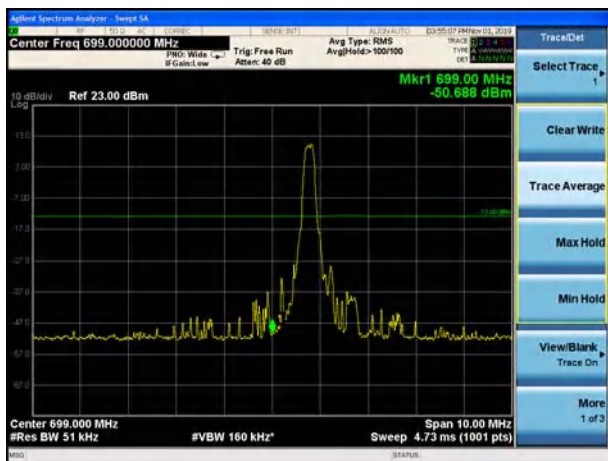

LTE Band 12 16QAM 10MHz CH-High, 1 RB

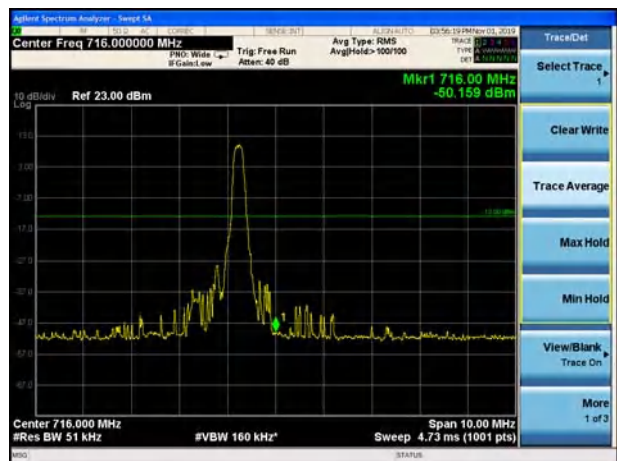



LTE Band 12 16QAM 10MHz CH-Low, 100%RB

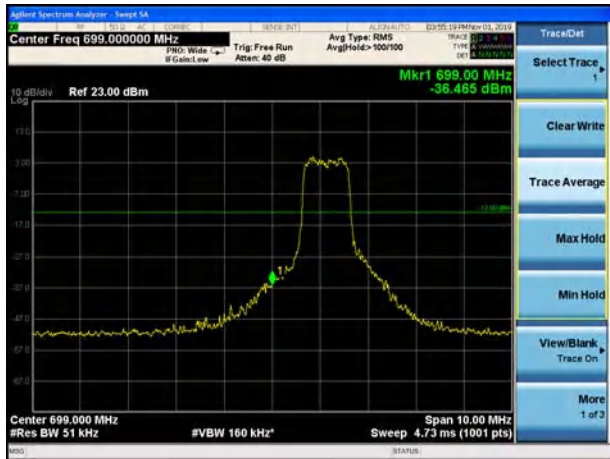

LTE Band 12 16QAM 10MHz CH-High, 100%RB

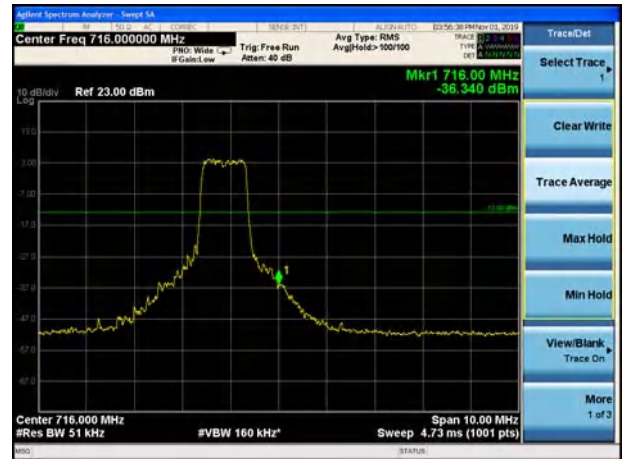





LTE Band 13 QPSK 5MHz CH-Low, 1 RB

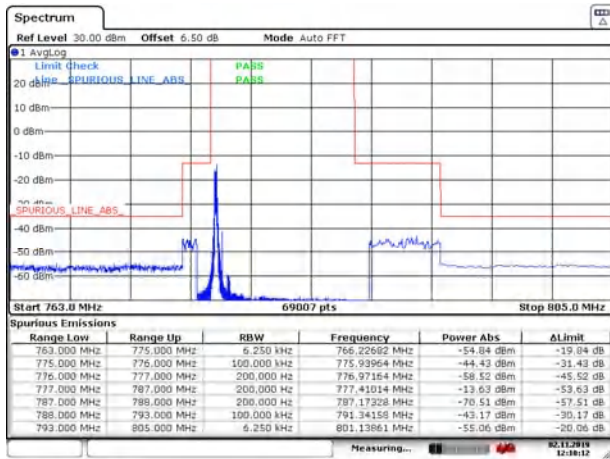

Date: 2 NOV 2019 12:10:13

LTE Band 13 QPSK 5MHz CH-High, 1 RB

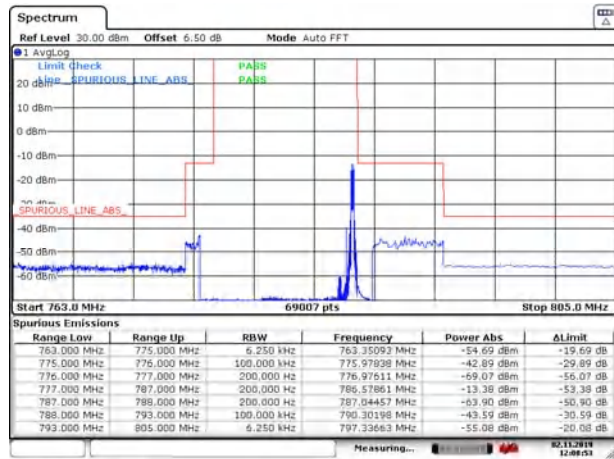

Date: 2 NOV 2019 12:08:53

LTE Band 13 QPSK 5MHz CH-Low, 100%RB

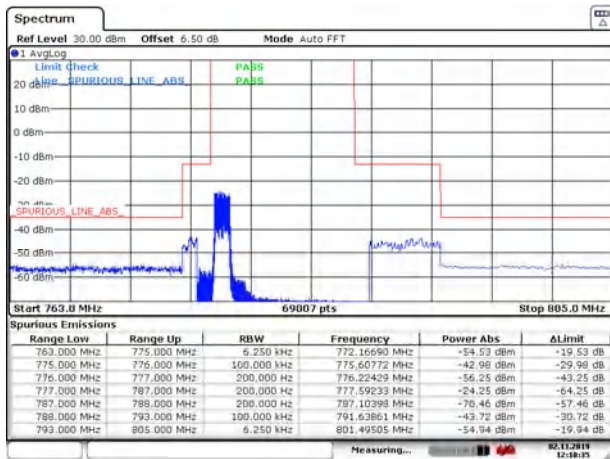

Date: 2 NOV 2019 12:10:34

LTE Band 13 QPSK 5MHz CH-High, 100%RB

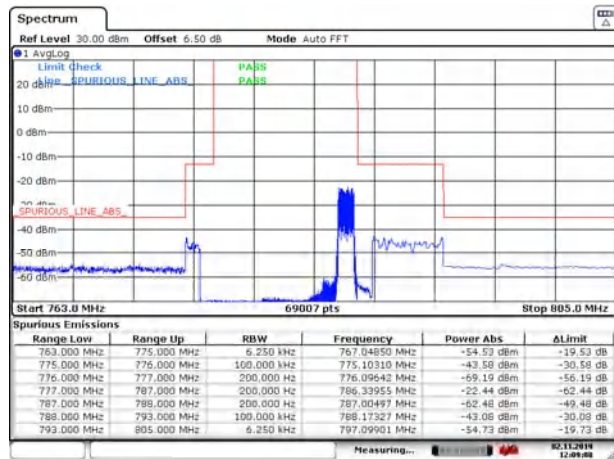

Date: 2 NOV 2019 12:09:08



LTE Band 13 QPSK 10MHz CH-Low, 1 RB

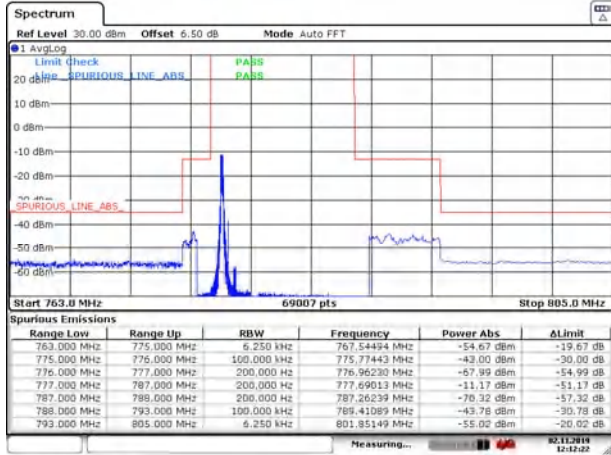

Date: 2 NOV 2019 12:12:22

LTE Band 13 QPSK 10MHz CH-High, 1 RB

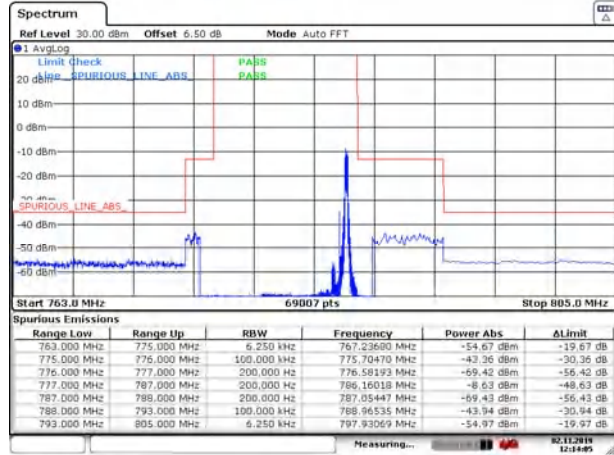

Date: 2 NOV 2019 12:14:05

LTE Band 13 QPSK 10MHz CH-Low, 100%RB

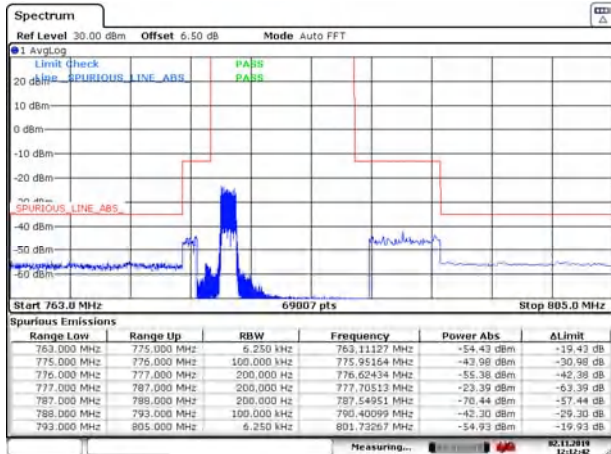

Date: 2 NOV 2019 12:12:42

LTE Band 13 QPSK 10MHz CH-High, 100%RB

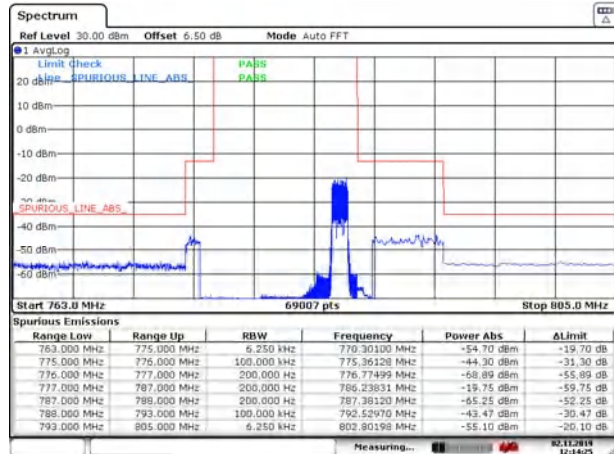

Date: 2 NOV 2019 12:14:24

LTE Band 13 16QAM 5MHz CH-Low, 1 RB

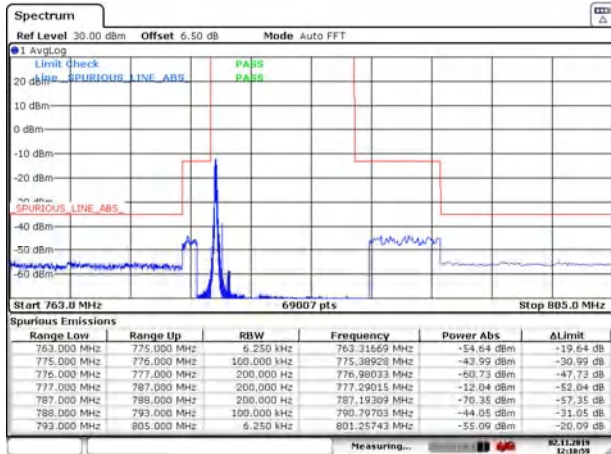

Date: 2 NOV 2019 12:10:58

LTE Band 13 16QAM 5MHz CH-High, 1 RB

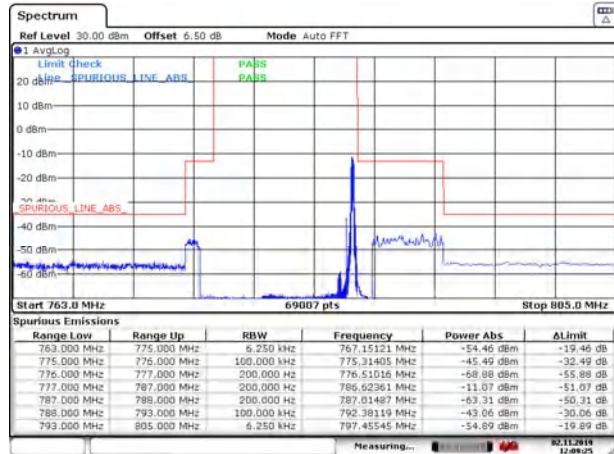

Date: 2 NOV 2019 12:08:24



LTE Band 13 16QAM 5MHz CH-Low, 100%RB

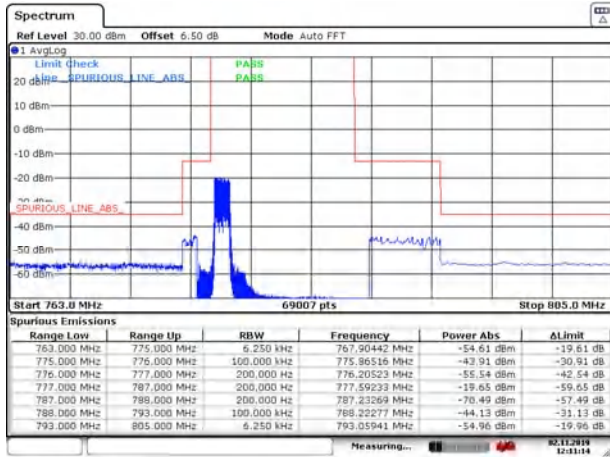

Date: 2 NOV 2019 12:11:14

LTE Band 13 16QAM 5MHz CH-High, 100%RB

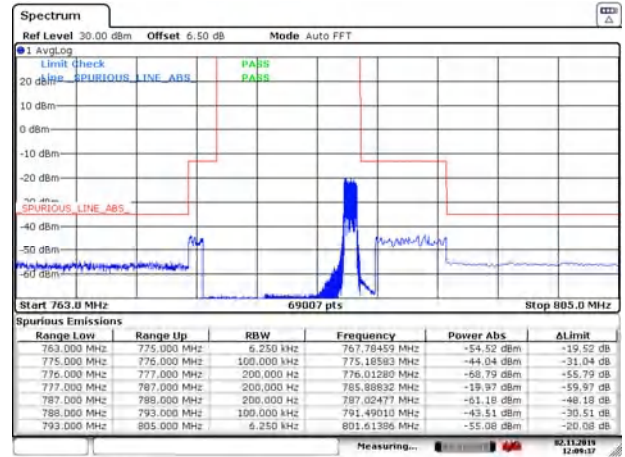

Date: 2 NOV 2019 12:08:37

LTE Band 13 16QAM 10MHz CH-Low, 1 RB

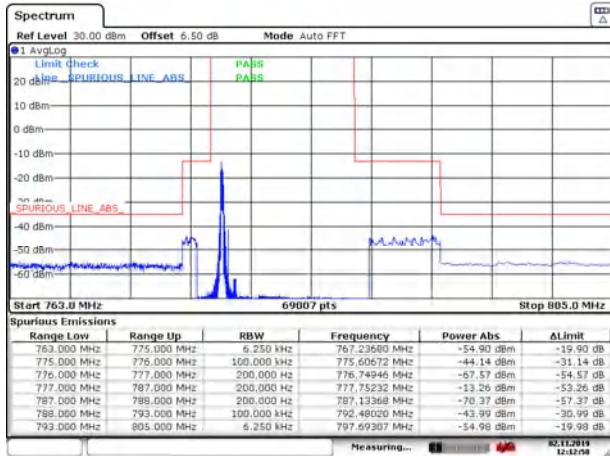

Date: 2 NOV 2019 12:12:58

LTE Band 13 16QAM 10MHz CH-High, 1 RB

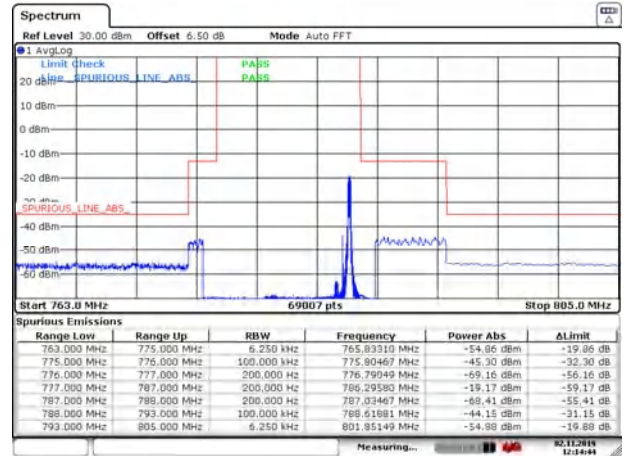

Date: 2 NOV 2019 12:14:44

LTE Band 13 16QAM 10MHz CH-Low, 100%RB

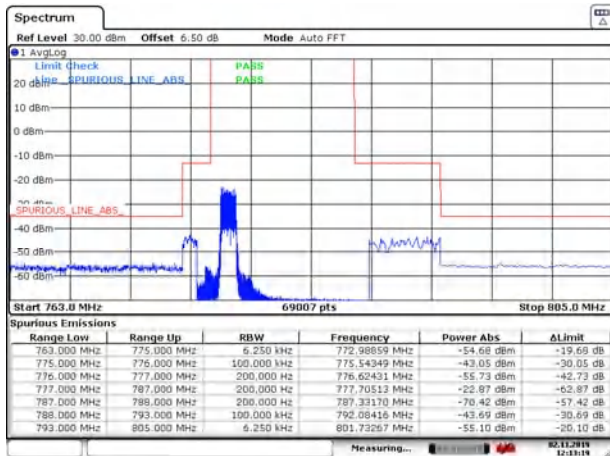

Date: 2 NOV 2019 12:13:18

LTE Band 13 16QAM 10MHz CH-High, 100%RB

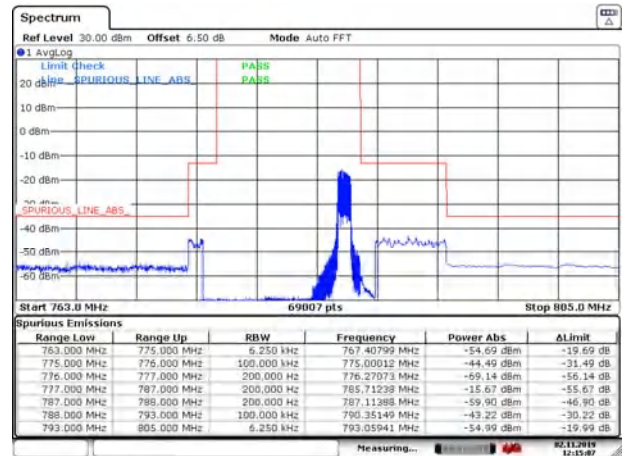

Date: 2 NOV 2019 12:15:07





LTE Band 66 QPSK 1.4MHz CH-Low, 1 RB

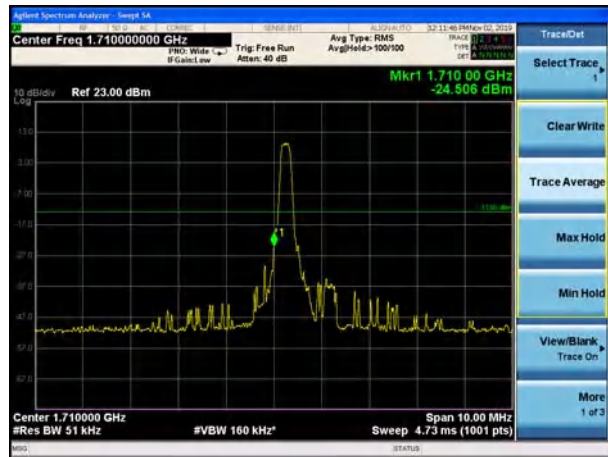

LTE Band 66 QPSK 1.4MHz CH-High, 1 RB

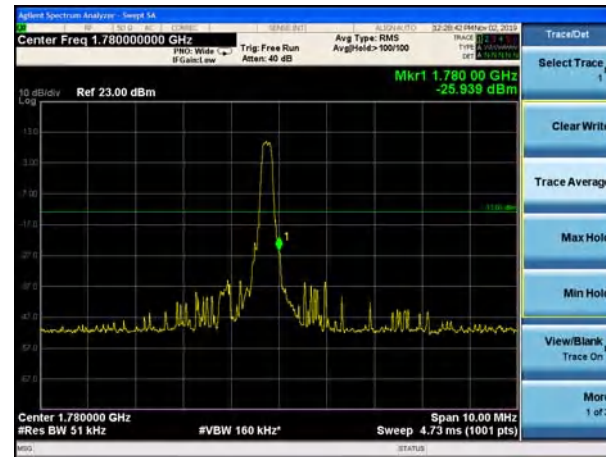

LTE Band 66 QPSK 1.4MHz CH-Low, 100%RB



LTE Band 66 QPSK 1.4MHz CH-High, 100%RB

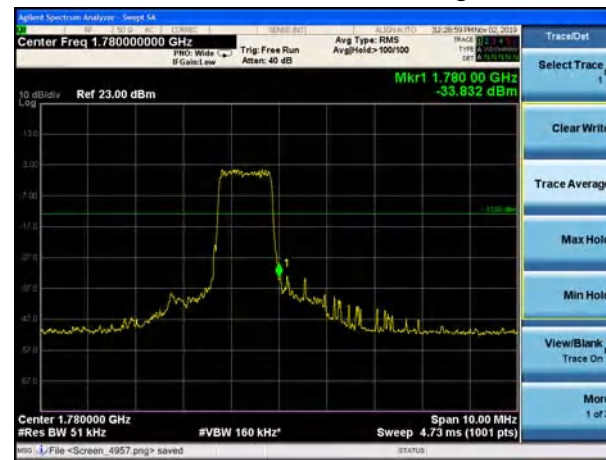



### LTE Band 66 QPSK 3MHz CH-Low, 1 RB

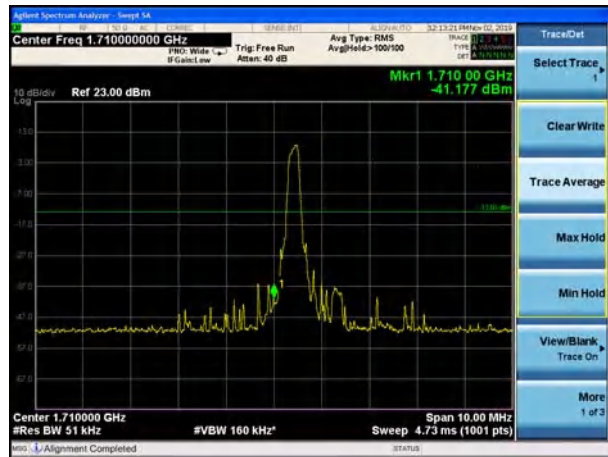

### LTE Band 66 QPSK 3MHz CH-High, 1 RB

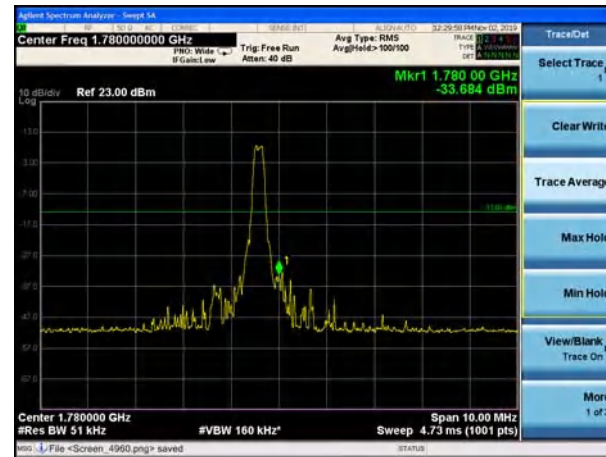

### LTE Band 66 QPSK 3MHz CH-Low, 100%RB

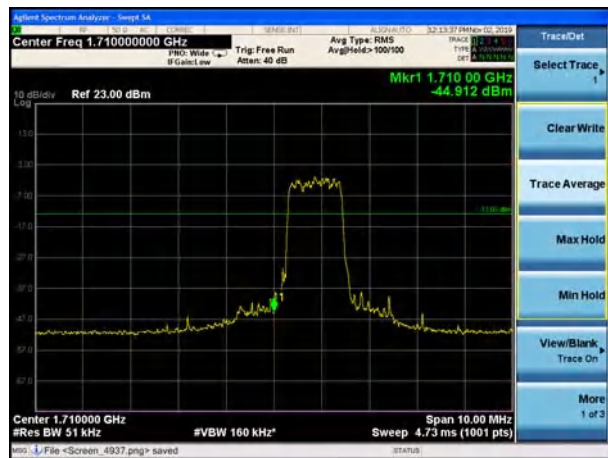

### LTE Band 66 QPSK 3MHz CH-High, 100%RB



### LTE Band 66 QPSK 5MHz CH-Low, 1 RB



### LTE Band 66 QPSK 5MHz CH-High, 1 RB

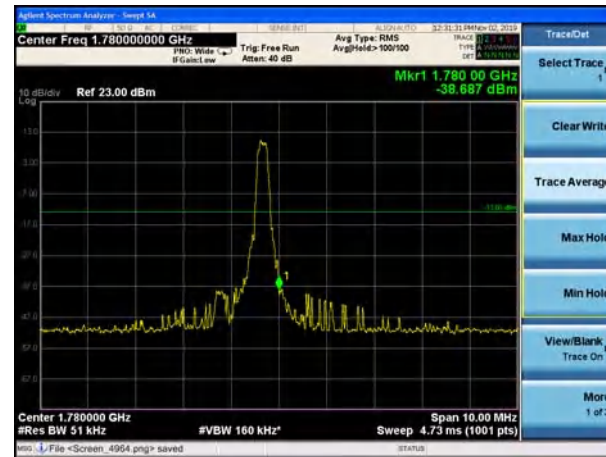





LTE Band 66 QPSK 5MHz CH-Low, 100%RB

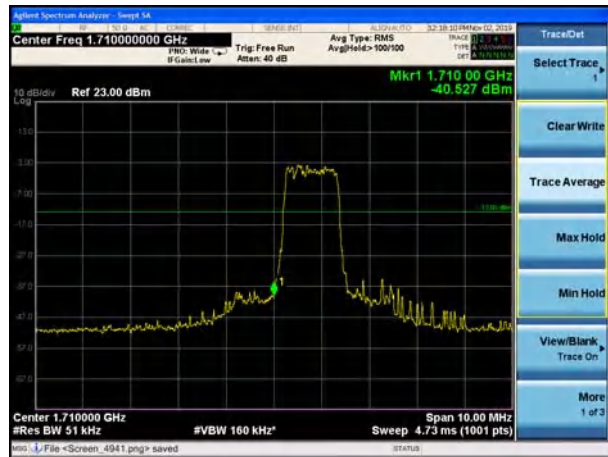

LTE Band 66 QPSK 5MHz CH-High, 100%RB

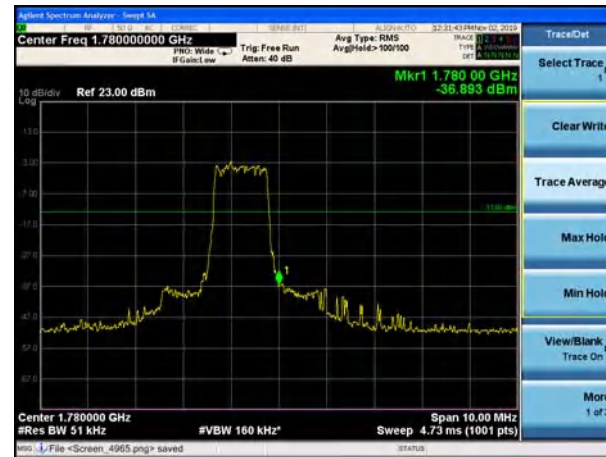

LTE Band 66 QPSK 10MHz CH-Low, 1 RB

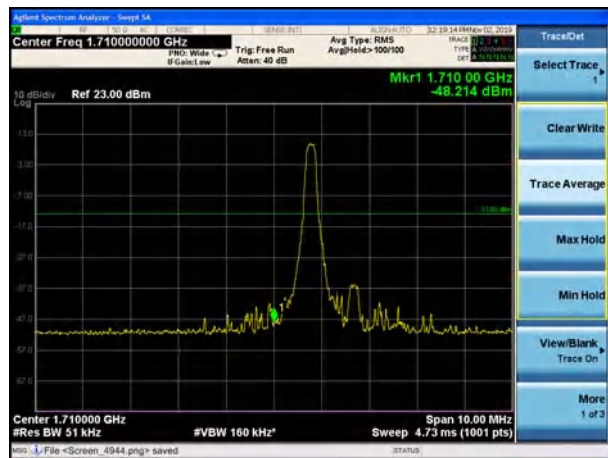

LTE Band 66 QPSK 10MHz CH-High, 1 RB

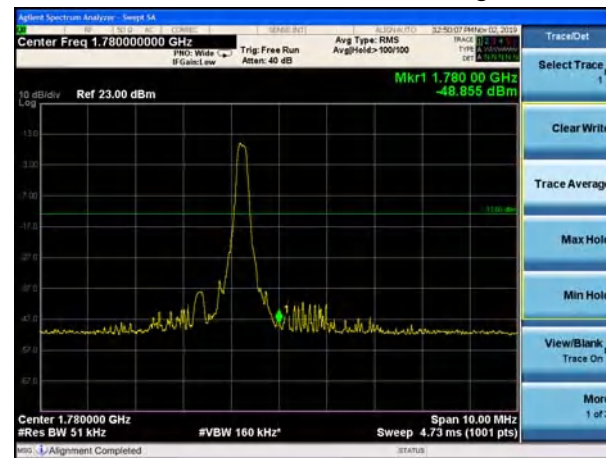

LTE Band 66 QPSK 10MHz CH-Low, 100%RB

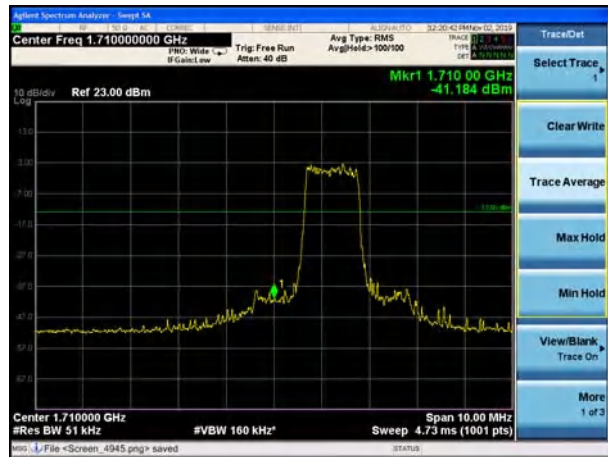

LTE Band 66 QPSK 10MHz CH-High, 100%RB

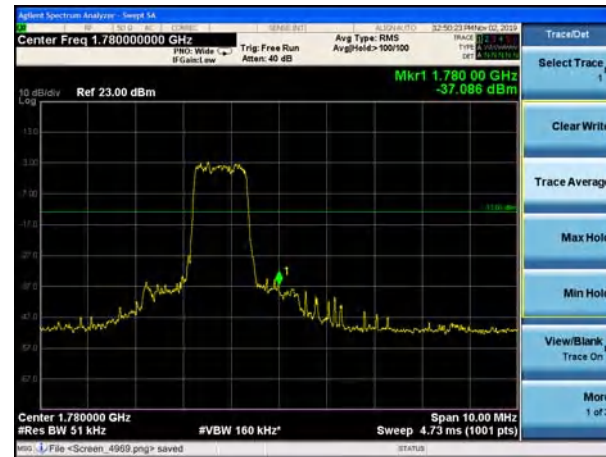



LTE Band 66 QPSK 15MHz CH-Low, 1 RB

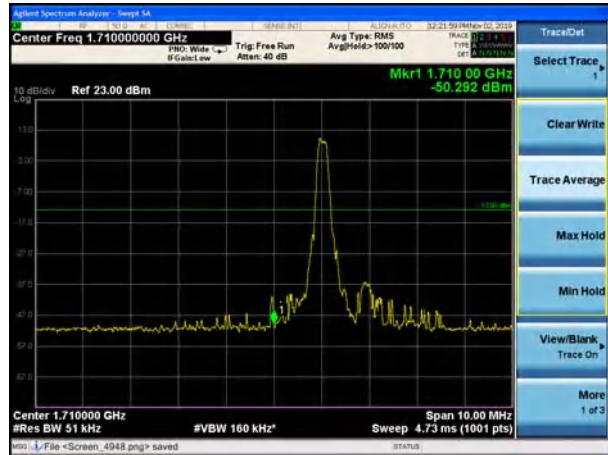

LTE Band 66 QPSK 15MHz CH-High, 1 RB

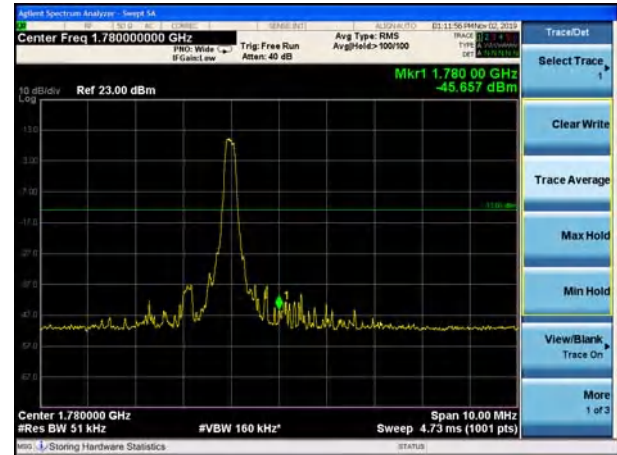

LTE Band 66 QPSK 15MHz CH-Low, 100%RB

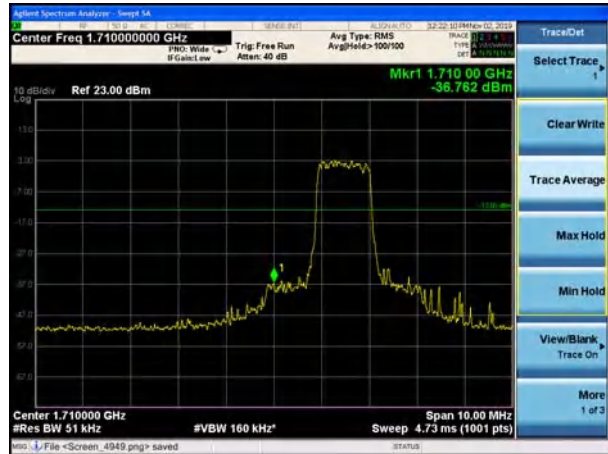

LTE Band 66 QPSK 15MHz CH-High, 100%RB

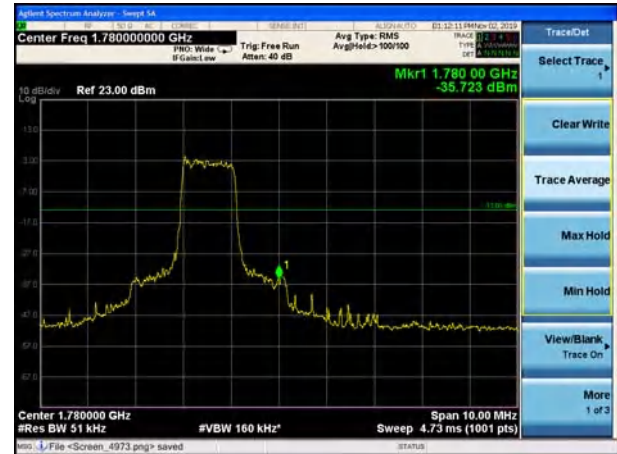

LTE Band 66 QPSK 20MHz CH-Low, 1 RB



LTE Band 66 QPSK 20MHz CH-High, 1 RB

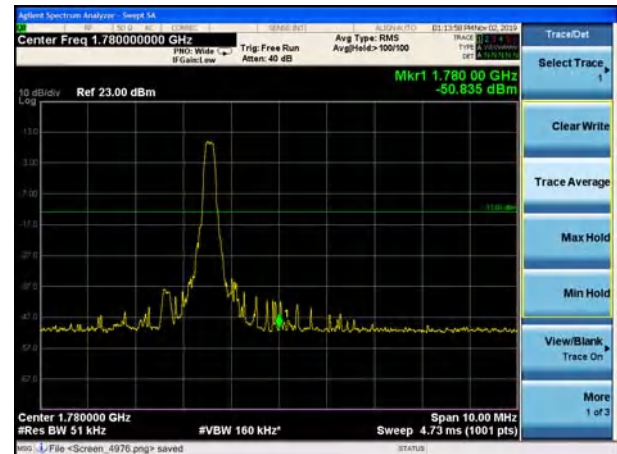



LTE Band 66 QPSK 20MHz CH-Low, 100%RB

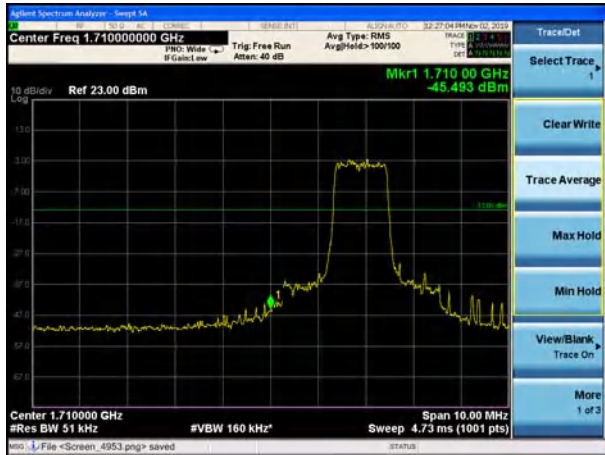

LTE Band 66 QPSK 20MHz CH-High, 100%RB



LTE Band 66 16QAM 1.4MHz CH-Low, 1 RB



LTE Band 66 16QAM 1.4MHz CH-High, 1 RB

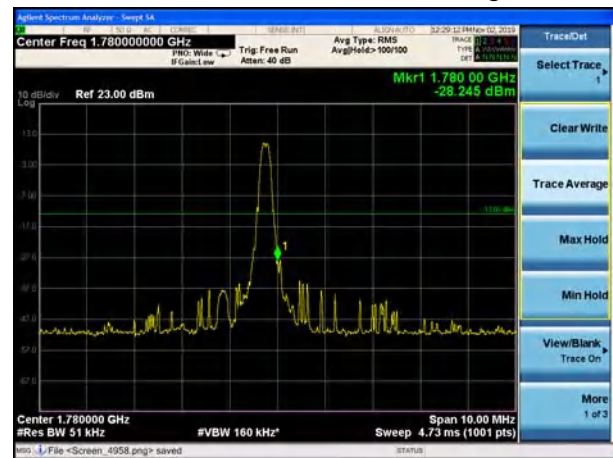

LTE Band 66 16QAM 1.4MHz CH-Low, 100%RB

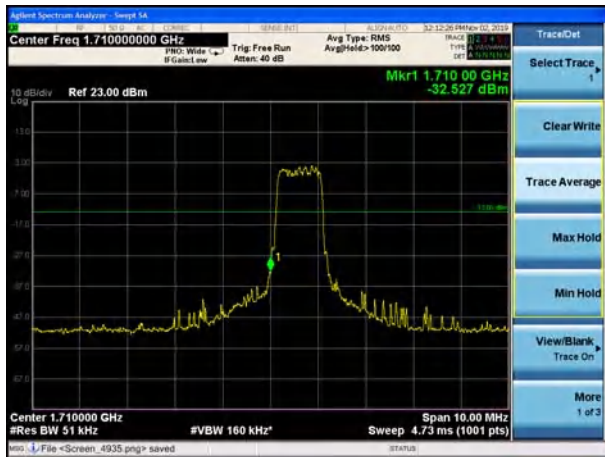

LTE Band 66 16QAM 1.4MHz CH-High, 100%RB

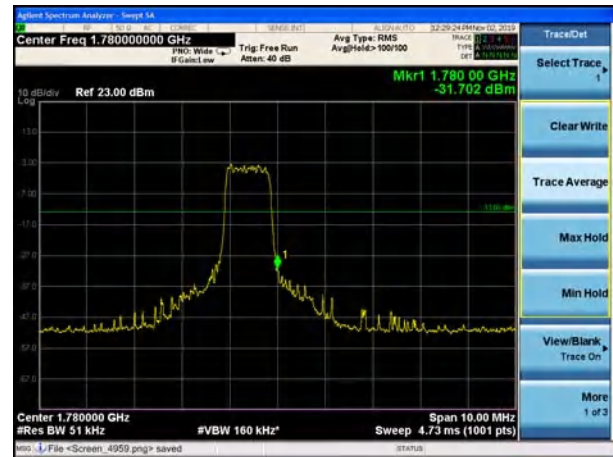





LTE Band 66 16QAM 3MHz CH-Low, 1 RB



LTE Band 66 16QAM 3MHz CH-High, 1 RB



LTE Band 66 16QAM 3MHz CH-Low, 100%RB

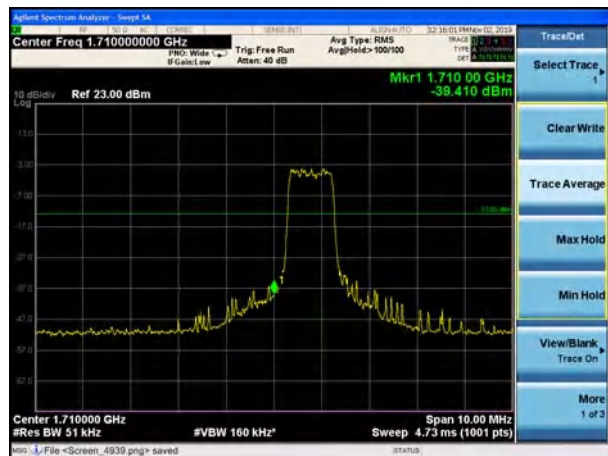

LTE Band 66 16QAM 3MHz CH-High, 100%RB



LTE Band 66 16QAM 5MHz CH-Low, 1 RB

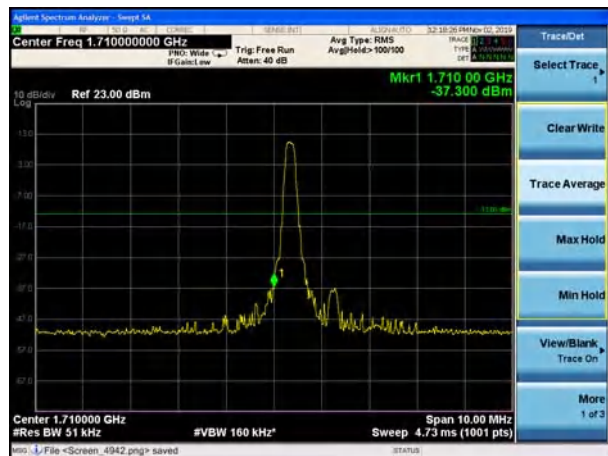

LTE Band 66 16QAM 5MHz CH-High, 1 RB



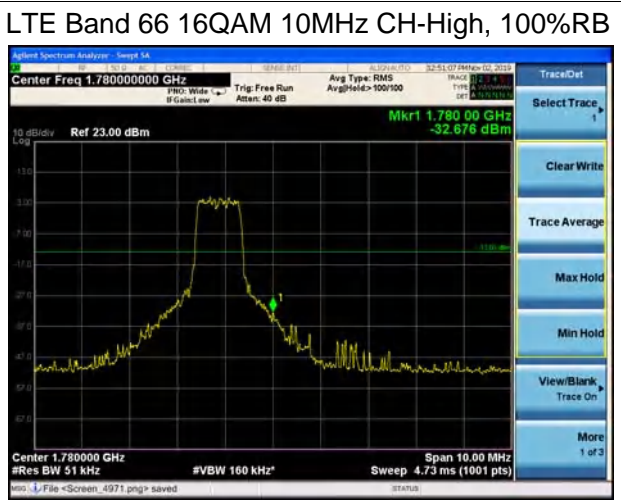
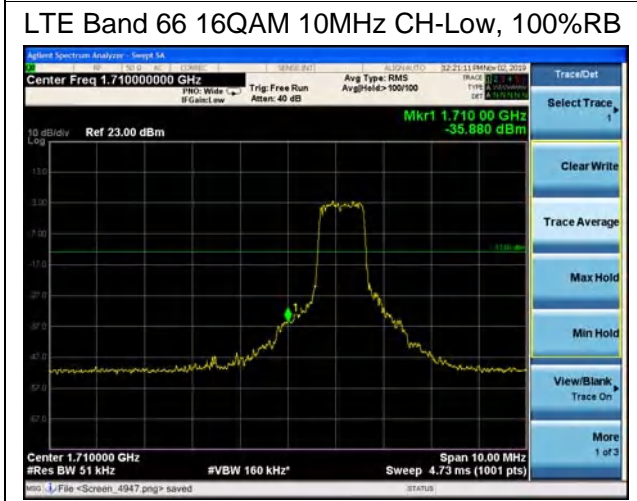
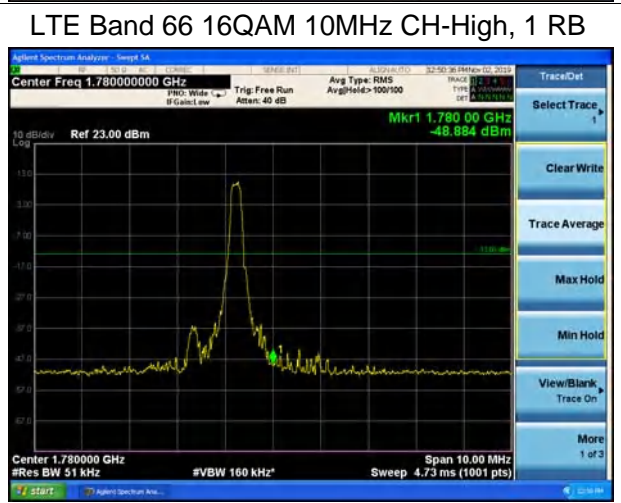
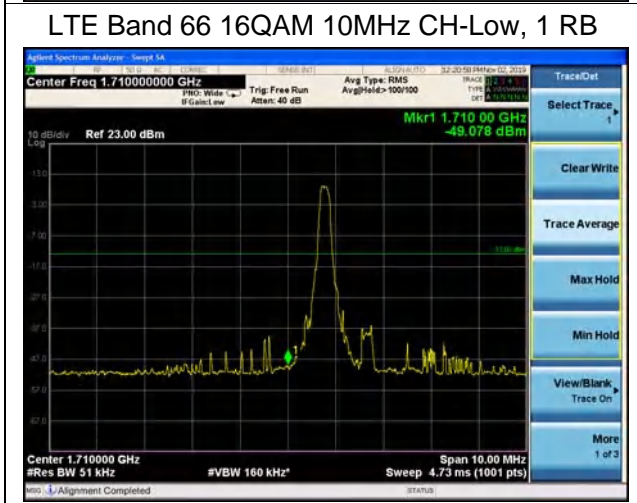
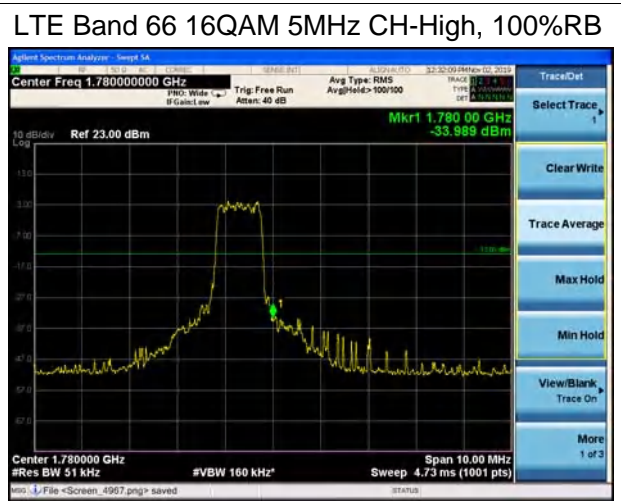
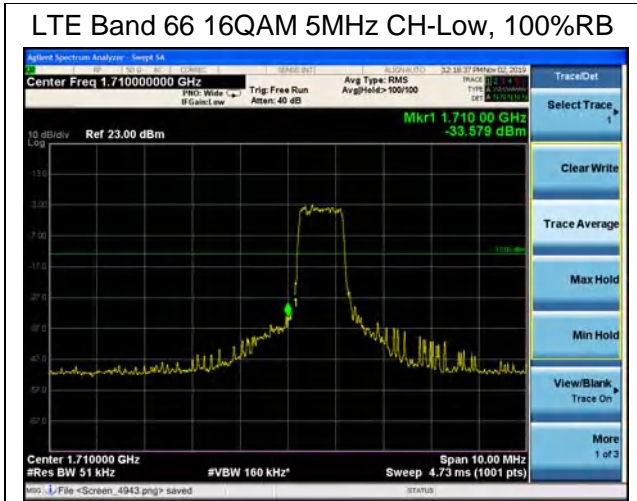



LTE Band 66 16QAM 15MHz CH-Low, 1 RB



LTE Band 66 16QAM 15MHz CH-High, 1 RB

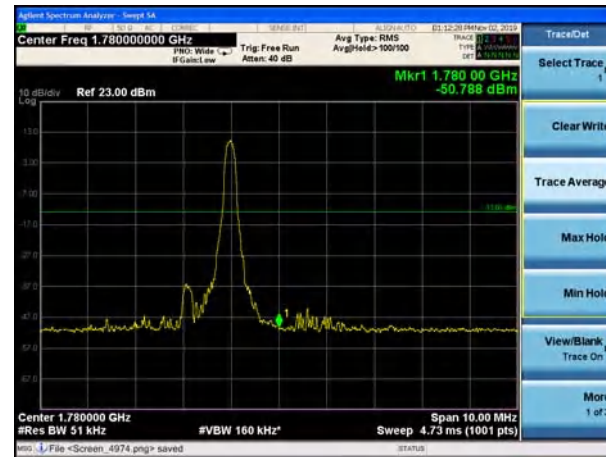

LTE Band 66 16QAM 15MHz CH-Low, 100%RB

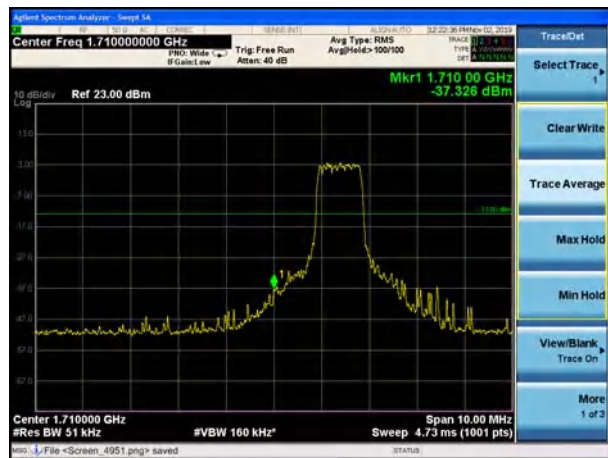

LTE Band 66 16QAM 15MHz CH-High, 100%RB



LTE Band 66 16QAM 20MHz CH-Low, 1 RB



LTE Band 66 16QAM 20MHz CH-High, 1 RB

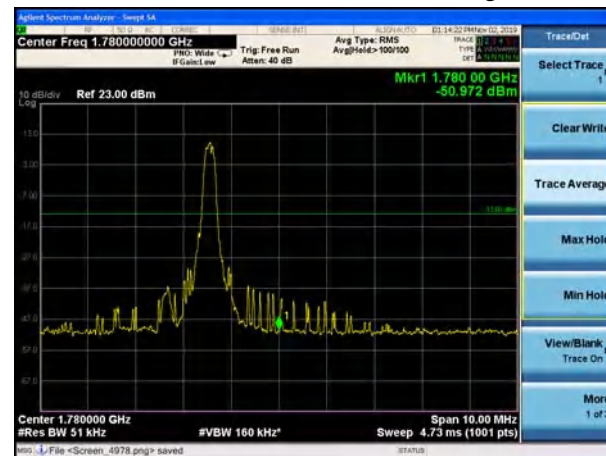





LTE Band 66 16QAM 20MHz CH-Low, 100%RB



LTE Band 66 16QAM 20MHz CH-High, 100%RB



LTE Band 85 QPSK 5MHz CH-Low, 1 RB

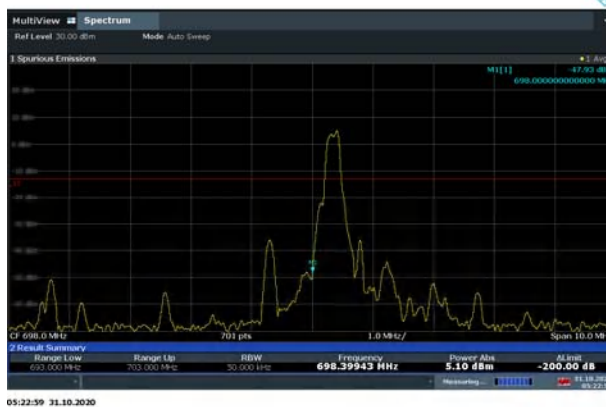

LTE Band 85 QPSK 5MHz CH-High, 1 RB



LTE Band 85 QPSK 5MHz CH-Low, 100%RB



LTE Band 85 QPSK 5MHz CH-High, 100%RB



LTE Band 85 QPSK 10MHz CH-Low, 1 RB

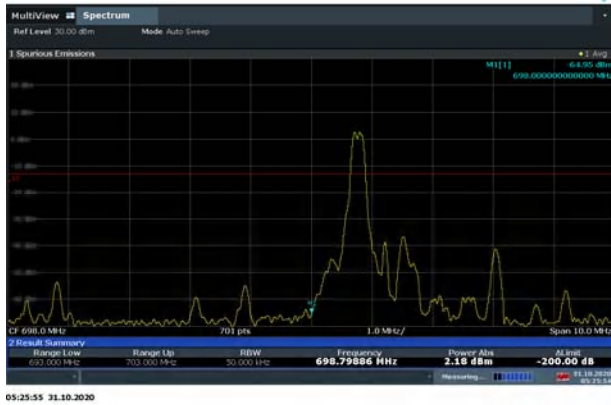

05:25:55 31.10.2020

LTE Band 85 QPSK 10MHz CH-High, 1 RB



05:27:30 31.10.2020

LTE Band 85 QPSK 10MHz CH-Low, 100%RB



05:26:03 31.10.2020

LTE Band 85 QPSK 10MHz CH-High, 100%RB



05:27:37 31.10.2020

LTE Band 85 16QAM 5MHz CH-Low, 1 RB



05:23:21 31.10.2020

LTE Band 85 16QAM 5MHz CH-High, 1 RB



05:29:11 31.10.2020



LTE Band 85 16QAM 5MHz CH-Low, 100%RB



05:23:29 31.10.2020

LTE Band 85 16QAM 5MHz CH-High, 100%RB

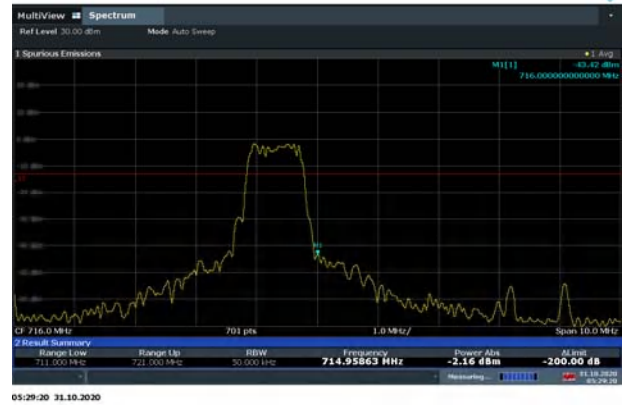

05:29:20 31.10.2020

LTE Band 85 16QAM 10MHz CH-Low, 1 RB



05:28:12 31.10.2020

LTE Band85 16QAM 10MHz CH-High, 1 RB



05:27:46 31.10.2020

LTE Band 85 16QAM 10MHz CH-Low, 100%RB



05:28:20 31.10.2020

LTE Band 85 16QAM 10MHz CH-High, 100%RB



05:27:55 31.10.2020

### 5.4 Peak-to-Average Power Ratio (PAPR)

#### Ambient condition

Temperature	Relative humidity	Pressure
23°C ~25°C	45%~50%	101.5kPa

#### Methods of Measurement

Measure the total peak power and record as PPk. And measure the total average power and record as PAvg. Both the peak and average power levels must be expressed in the same logarithmic units (e.g., dBm). Determine the PAPR from:

$$PAPR (dB) = PPk (dBm) - PAvg (dBm).$$

#### Test Setup

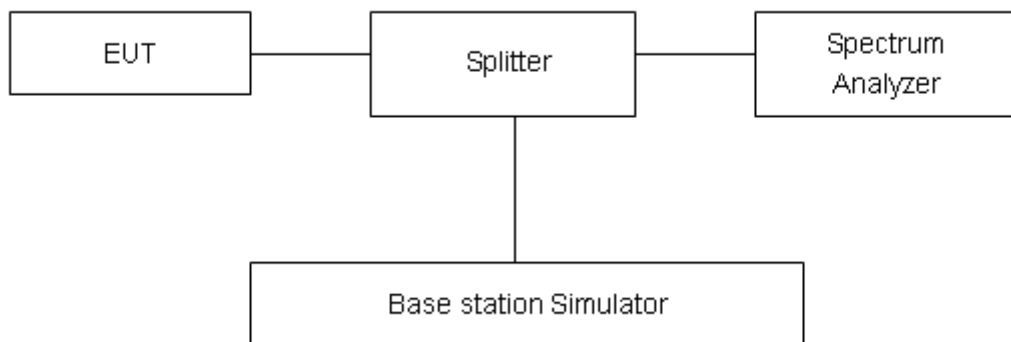

#### Limits

Rule Part 27.50(d)(5) Equipment employed must be authorized in accordance with the provisions of 24.51. Power measurements for transmissions by stations authorized under this section may be made either in accordance with a Commission-approved average power technique or in compliance with paragraph (d)(6) of this section. In measuring transmissions in this band using an average power technique, the peak-to-average ratio (PAR) of the transmission may not exceed 13 dB.

#### Measurement Uncertainty

The assessed measurement uncertainty to ensure 95% confidence level for the normal distribution is with the coverage factor  $k = 2$ ,  $U = 0.4$  dB.



## Test Results

Mode	Bandwidth	Modulation	Channel/ Frequency(MHz)	Peak-to-Average Power Ratio (PAPR)		
				Peak(dBm)	Avg(dBm)	PAPR(dB)
Band4	1.4MHz	QPSK	20175/1732.5	23.43	12.53	10.90
		16QAM	20175/1732.5	24.39	12.40	11.99
	3MHz	QPSK	20175/1732.5	23.60	13.26	10.34
		16QAM	20175/1732.5	24.04	13.30	10.74
	5MHz	QPSK	20175/1732.5	24.50	14.70	9.80
		16QAM	20175/1732.5	25.02	15.21	9.81
	10MHz	QPSK	20175/1732.5	24.53	15.52	9.01
		16QAM	20175/1732.5	25.59	16.65	8.94
	15MHz	QPSK	20175/1732.5	25.01	14.42	10.59
		16QAM	20175/1732.5	25.50	14.54	10.96
20MHz	QPSK	20175/1732.5	25.13	15.81	9.32	
	16QAM	20175/1732.5	25.57	15.03	10.54	

Mode	Bandwidth	Modulation	Channel/ Frequency(MHz)	Peak-to-Average Power Ratio (PAPR)		
				Peak(dBm)	Avg(dBm)	PAPR(dB)
Band12	1.4MHz	QPSK	23095/707.5	24.28	13.25	11.03
		16QAM	23095/707.5	25.39	13.80	11.59
	3MHz	QPSK	23095/707.5	24.24	13.53	10.71
		16QAM	23095/707.5	25.25	13.69	11.56
	5MHz	QPSK	23095/707.5	25.33	15.72	9.61
		16QAM	23095/707.5	25.98	16.05	9.93
	10MHz	QPSK	23095/707.5	25.34	16.16	9.18
		16QAM	23095/707.5	26.46	17.39	9.07

Mode	Bandwidth	Modulation	Channel/ Frequency(MHz)	Peak-to-Average Power Ratio (PAPR)		
				Peak(dBm)	Avg(dBm)	PAPR(dB)
Band13	5MHz	QPSK	23230/782	25.09	15.20	9.89
		16QAM	23230/782	25.52	15.79	9.73
	10MHz	QPSK	23230/782	25.35	16.16	9.19
		16QAM	23230/782	26.25	16.72	9.53

Mode	Bandwidth	Modulation	Channel/ Frequency(MHz)	Peak-to-Average Power Ratio (PAPR)		
				Peak(dBm)	Avg(dBm)	PAPR(dB)
Ban66	1.4MHz	QPSK	132322/1745	23.82	12.16	11.66
		16QAM	132322/1745	24.75	12.57	12.18
	3MHz	QPSK	132322/1745	23.85	13.63	10.22



	5MHz	16QAM	132322/1745	24.53	13.63	10.90
		QPSK	132322/1745	24.60	15.17	9.43
		16QAM	132322/1745	25.31	15.56	9.75
	10MHz	QPSK	132322/1745	24.55	15.07	9.48
		16QAM	132322/1745	25.64	16.13	9.51
	15MHz	QPSK	132322/1745	25.13	15.94	9.19
		16QAM	132322/1745	25.62	15.97	9.65
	20MHz	QPSK	132322/1745	25.10	15.69	9.41
		16QAM	132322/1745	25.55	14.98	10.57

Mode	Bandwidth	Modulation	Channel/ Frequency(MHz)	Peak-to-Average Power Ratio (PAPR)		
				Peak(dBm)	Avg(dBm)	PAPR(dB)
Band85	5MHz	QPSK	134092/707	20.02	10.22	9.80
		16QAM	134092/707	20.98	10.64	10.34
	10MHz	QPSK	134092/707	20.14	10.30	9.84
		16QAM	134092/707	19.99	10.09	9.90



## 5.5 Frequency Stability

### Ambient condition

Temperature	Relative humidity	Pressure
23°C ~25°C	45%~50%	101.5kPa

### Method of Measurement

#### Frequency Stability (Temperature Variation)

The temperature inside the climate chamber is varied from -40°C to +85°C in 10°C step size.

(1) With all power removed, the temperature was decreased to -10°C and permitted to stabilize for three hours.

(2) Measure the carrier frequency with the test equipment in a “call mode”. These measurements should be made within 1 minute of powering up the mobile station, to prevent significant self warming.

(3) Repeat the above measurements at 10°C increments from -40°C to +85°C. Allow at least 1.5 hours at each temperature, un-powered, before making measurements.

#### Frequency Stability (Voltage Variation)

The frequency stability shall be measured with variation of primary supply voltage as follows:

(1) Vary primary supply voltage from 85 to 115 percent of the nominal value for other than hand carried battery equipment.

(2) For hand carried, battery powered equipment, reduce primary supply voltage to the battery-operating end point which shall be specified by the manufacturer.

This transceiver is specified to operate with an input voltage of between 2.6 V and 4.8 V, with a nominal voltage of 3.3V.

### Test setup

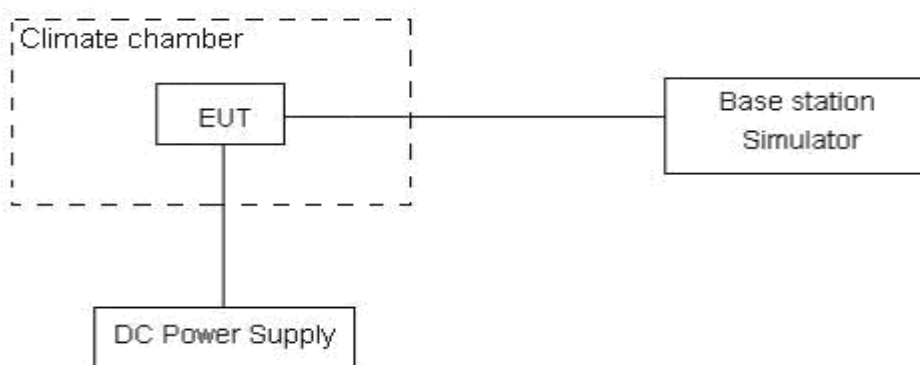

### Limits

The frequency stability shall be sufficient to ensure that the fundamental emissions stay within the authorized bands of operation.

### Measurement Uncertainty

The assessed measurement uncertainty to ensure 99.75% confidence level for the normal distribution is with the coverage factor  $k = 3, U=0.01\text{ppm}$ .



## Test Result

LTE Band 4						
Condition		Freq.Error (Hz)	Freq.Error (Hz)	Frequency Stability (ppm)	Frequency Stability (ppm)	Verdict
Bandwidth	20MHz					
Temperature	Voltage	16QAM	QPSK	16QAM	QPSK	
Normal (25°C)	Normal	10.23	8.16	0.00544	0.00434	PASS
Extreme (85°C)		1.63	5.36	0.00087	0.00285	PASS
Extreme (80°C)		1.14	17.98	0.00061	0.00957	PASS
Extreme (70°C)		3.92	15.07	0.00208	0.00802	PASS
Extreme (60°C)		2.76	5.69	0.00147	0.00302	PASS
Extreme (50°C)		10.55	12.31	0.00561	0.00655	PASS
Extreme (40°C)		16.83	7.27	0.00895	0.00386	PASS
Extreme (30°C)		6.71	16.89	0.00357	0.00898	PASS
Extreme (20°C)		6.85	6.47	0.00364	0.00344	PASS
Extreme (10°C)		13.80	6.55	0.00734	0.00348	PASS
Extreme (0°C)		6.27	6.01	0.00333	0.00320	PASS
Extreme (-10°C)		1.22	12.63	0.00065	0.00672	PASS
Extreme (-20°C)		6.13	1.70	0.00326	0.00091	PASS
Extreme (-30°C)		7.65	16.23	0.00407	0.00863	PASS
Extreme (-40°C)		1.46	6.41	0.00077	0.00341	PASS
25°C	LV	13.39	9.58	0.00712	0.00510	PASS
	HV	9.70	4.32	0.00516	0.00230	PASS

LTE Band 12						
Condition		Freq.Error (Hz)	Freq.Error (Hz)	Frequency Stability (ppm)	Frequency Stability (ppm)	Verdict
Bandwidth	10MHz					
Temperature	Voltage	16QAM	QPSK	16QAM	QPSK	
Normal (25°C)	Normal	8.55	9.13	0.00455	0.00485	PASS
Extreme (85°C)		5.23	1.96	0.00278	0.00104	PASS
Extreme (80°C)		17.39	10.08	0.00925	0.00536	PASS
Extreme (70°C)		10.21	4.05	0.00543	0.00215	PASS
Extreme (60°C)		13.94	6.49	0.00742	0.00345	PASS
Extreme (50°C)		1.48	2.56	0.00079	0.00136	PASS
Extreme (40°C)		17.40	17.98	0.00925	0.00956	PASS
Extreme (30°C)		2.29	13.64	0.00122	0.00726	PASS
Extreme (20°C)		11.73	10.40	0.00624	0.00553	PASS
Extreme (10°C)		16.49	9.90	0.00877	0.00527	PASS



Extreme (0°C)		5.67	8.91	0.00302	0.00474	PASS
Extreme (-10°C)		9.89	3.95	0.00526	0.00210	PASS
Extreme (-20°C)		3.92	2.50	0.00209	0.00133	PASS
Extreme (-30°C)		2.14	7.71	0.00114	0.00410	PASS
Extreme (-40°C)		1.42	15.19	0.00076	0.00808	PASS
25°C	LV	9.33	2.59	0.00496	0.00138	PASS
	HV	4.56	15.53	0.00243	0.00826	PASS

LTE Band 13						
Condition		Freq.Error (Hz)	Freq.Error (Hz)	Frequency Stability (ppm)	Frequency Stability (ppm)	Verdict
Bandwidth	10MHz					
Temperature	Voltage	16QAM	QPSK	16QAM	QPSK	
Normal (25°C)	Normal	5.40	14.07	0.00287	0.00749	
Extreme (85°C)		9.90	15.59	0.00526	0.00829	PASS
Extreme (80°C)		9.16	9.46	0.00487	0.00503	PASS
Extreme (70°C)		4.29	16.99	0.00228	0.00904	PASS
Extreme (60°C)		1.07	16.85	0.00057	0.00896	PASS
Extreme (50°C)		1.08	17.95	0.00058	0.00955	PASS
Extreme (40°C)		5.57	4.97	0.00296	0.00264	PASS
Extreme (30°C)		6.16	9.48	0.00328	0.00504	PASS
Extreme (20°C)		4.63	7.07	0.00246	0.00376	PASS
Extreme (10°C)		5.37	12.94	0.00286	0.00688	PASS
Extreme (0°C)		14.62	8.18	0.00778	0.00435	PASS
Extreme (-10°C)		4.92	15.30	0.00262	0.00814	PASS
Extreme (-20°C)		9.50	16.72	0.00505	0.00890	PASS
Extreme (-30°C)		17.39	9.02	0.00925	0.00480	PASS
Extreme (-40°C)		1.34	11.02	0.00071	0.00586	PASS
25°C	LV	16.07	2.17	0.00855	0.00115	PASS
	HV	7.56	7.69	0.00402	0.00409	PASS

LTE Band 66						
Condition		Freq.Error (Hz)	Freq.Error (Hz)	Frequency Stability (ppm)	Frequency Stability (ppm)	Verdict
Bandwidth	20MHz					
Temperature	Voltage	16QAM	QPSK	16QAM	QPSK	
Normal (25°C)	Normal	16.52	3.98	0.00879	0.00212	
Extreme (85°C)		11.00	1.98	0.00585	0.00105	PASS
Extreme (80°C)		10.25	2.35	0.00545	0.00125	PASS
Extreme (70°C)		15.14	14.12	0.00805	0.00751	PASS



Extreme (60°C)		15.42	3.58	0.00820	0.00191	PASS
Extreme (50°C)		4.43	15.40	0.00236	0.00819	PASS
Extreme (40°C)		17.09	7.68	0.00909	0.00409	PASS
Extreme (30°C)		1.84	5.37	0.00098	0.00285	PASS
Extreme (20°C)		4.26	1.52	0.00227	0.00081	PASS
Extreme (10°C)		16.89	16.10	0.00898	0.00856	PASS
Extreme (0°C)		8.33	3.08	0.00443	0.00164	PASS
Extreme (-10°C)		14.88	9.87	0.00791	0.00525	PASS
Extreme (-20°C)		9.26	12.90	0.00493	0.00686	PASS
Extreme (-30°C)		4.71	17.85	0.00251	0.00949	PASS
Extreme (-40°C)		4.98	5.41	0.00265	0.00288	PASS
25°C		LV	12.26	5.35	0.00652	0.00285
	HV	12.35	13.06	0.00657	0.00695	PASS

LTE Band 85						
Condition		Freq.Error (Hz)	Freq.Error (Hz)	Frequency Stability (ppm)	Frequency Stability (ppm)	Verdict
Bandwidth	20MHz					
Temperature	Voltage	16QAM	QPSK	16QAM	QPSK	
Normal (25°C)	Normal	8.02	11.69	0.00427	0.00622	
Extreme (85°C)		7.95	7.37	0.00423	0.00392	PASS
Extreme (80°C)		6.07	8.54	0.00323	0.00454	PASS
Extreme (70°C)		3.51	13.56	0.00187	0.00721	PASS
Extreme (60°C)		3.22	10.80	0.00171	0.00574	PASS
Extreme (50°C)		14.56	13.74	0.00775	0.00731	PASS
Extreme (40°C)		3.52	12.45	0.00187	0.00662	PASS
Extreme (30°C)		3.66	5.71	0.00195	0.00304	PASS
Extreme (20°C)		6.05	8.88	0.00322	0.00472	PASS
Extreme (10°C)		7.99	16.69	0.00425	0.00888	PASS
Extreme (0°C)		17.36	5.11	0.00923	0.00272	PASS
Extreme (-10°C)		12.73	6.11	0.00677	0.00325	PASS
Extreme (-20°C)		15.16	8.99	0.00806	0.00478	PASS
Extreme (-30°C)		17.22	13.60	0.00916	0.00723	PASS
Extreme (-40°C)		12.29	6.31	0.00654	0.00336	PASS
25°C	LV	13.61	16.85	0.00724	0.00896	PASS
	HV	15.39	3.91	0.00819	0.00208	PASS

## 5.6 Spurious Emissions at Antenna Terminals

### Ambient condition

Temperature	Relative humidity	Pressure
23°C ~25°C	45%~50%	101.5kPa

### Method of Measurement

The EUT was connected to Spectrum Analyzer and Base Station Simulator via power Splitter. The measurement is carried out using a spectrum analyzer. The spectrum analyzer scans from 9kHz to the 10th harmonic of the carrier. The peak detector is used.

RBW is set to 100kHz, VBW is set to 300kHz for 30MHz~1GHz

RBW is set to 1MHz, VBW is set to 3MHz for above 1GHz, Sweep is set to ATUO.

Of those disturbances below (limit – 20 dB), the mark is not required for the EUT.

The modulation mode and RB allocation refer to section 5.1, using the maximum output power configuration.

### Test setup

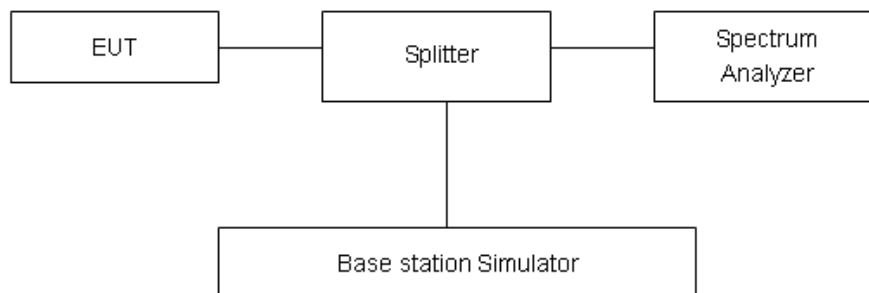

### Limits

Rule Part 27.53(h) specifies that “for operations in the 1695-1710 MHz, 1710-1755 MHz, 1755-1780 MHz, 1915-1920 MHz, 1995-2000 MHz, 2000-2020 MHz, 2110-2155 MHz, 2155-2180 MHz, and 2180-2200 bands, the power of any emission outside a licensee's frequency block shall be attenuated below the transmitter power (P) in watts by at least  $43 + 10 \log_{10}(P)$  dB..”

Rule Part 27.53 (g) For operations in the 600 MHz band and the 698-746 MHz band, the power of any emission outside a licensee's frequency band(s) of operation shall be attenuated below the transmitter power (P) within the licensed band(s) of operation, measured in watts, by at least  $43 + 10 \log(P)$  dB. Compliance with this provision is based on the use of measurement instrumentation employing a resolution bandwidth of 100 kilohertz or greater. However, in the 100 kilohertz bands immediately outside and adjacent to a licensee's frequency block, a resolution bandwidth of at least 30 kHz may be employed.

Rule Part 27.53(f) For operations in the 746-758 MHz, 775-788 MHz, and 805-806 MHz bands, emissions in the band 1559-1610 MHz shall be limited to  $-70$  dBW/MHz equivalent isotropically





radiated power (EIRP) for wideband signals, and -80 dBW EIRP for discrete emissions of less than 700 Hz bandwidth. For the purpose of equipment authorization, a transmitter shall be tested with an antenna that is representative of the type that will be used with the equipment in normal operation.

Part 27.53((h)/(g) Limit		-13 dBm
Part 27.53(f) Limit	Limit out of the band 1559-1610 MHz	-13 dBm
	Limit in the band 1559-1610 MHz	-40 dBm

### Measurement Uncertainty

The assessed measurement uncertainty to ensure 99.75% confidence level for the normal distribution is with the coverage factor  $k = 1.96$ .

Frequency	Uncertainty
9kHz-1GHz	0.684 dB
1GHz-27GHz	1.407 dB



### Test Result

Sweep the whole frequency band through the range from 9kHz to the 10th harmonic of the carrier, the emissions more than 20 dB below the limit are not reported.

The signal beyond the limit is carrier.

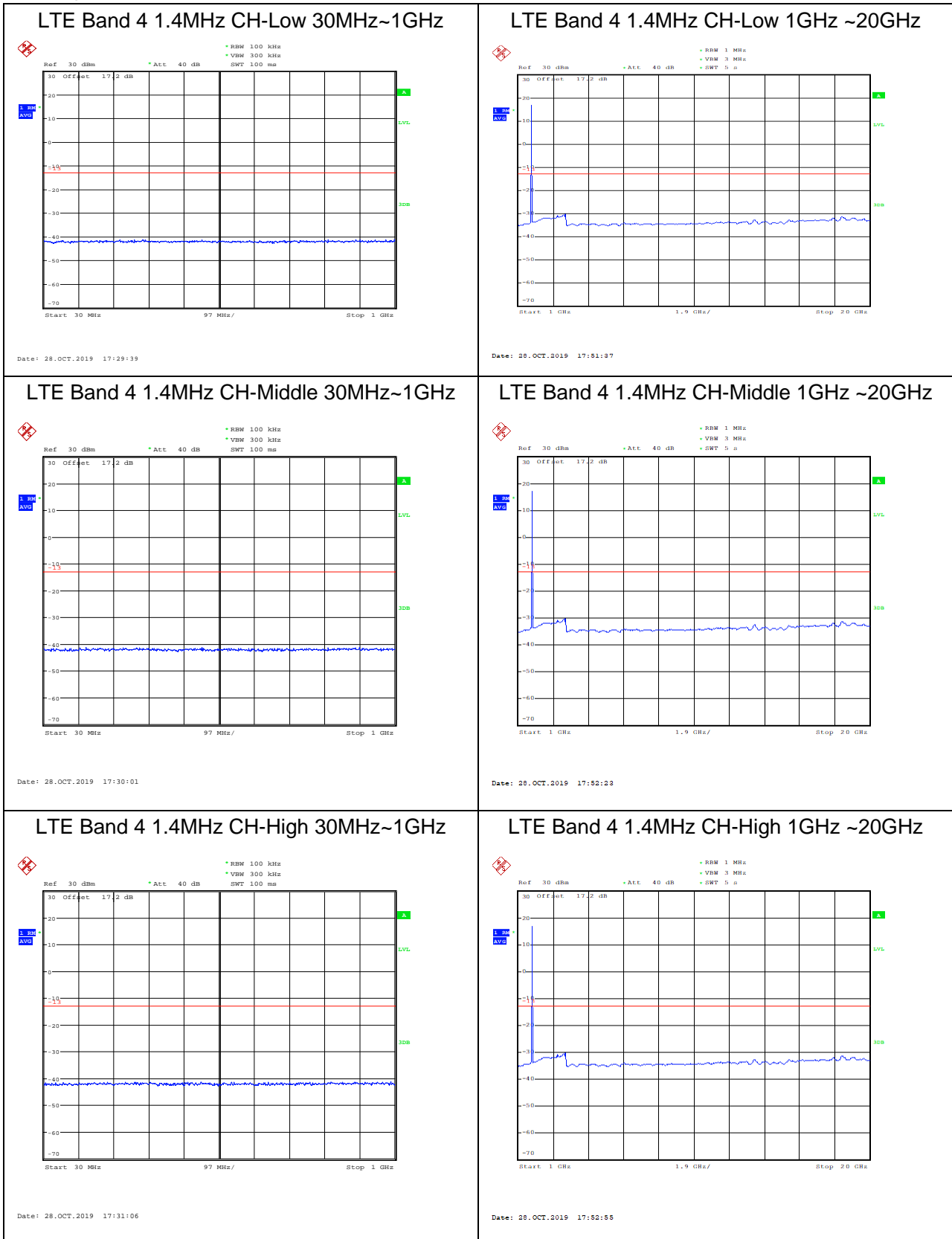



### LTE Band 4 3MHz CH-Low 30MHz~1GHz

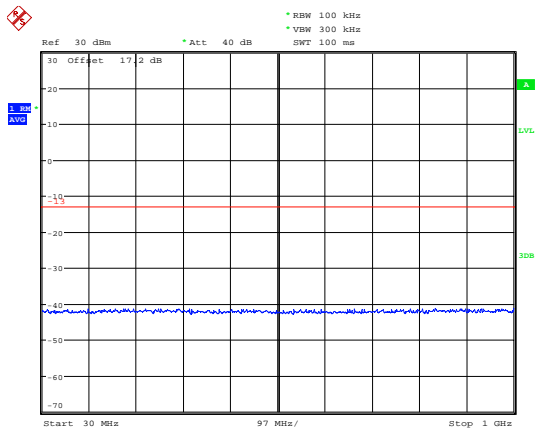

Date: 28.OCT.2019 17:36:04

### LTE Band 4 3MHz CH-Low 1GHz ~20GHz

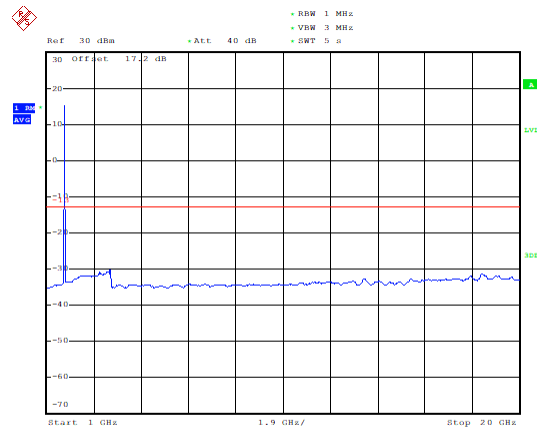

Date: 28.OCT.2019 17:54:56

### LTE Band 4 3MHz CH-Middle 30MHz~1GHz

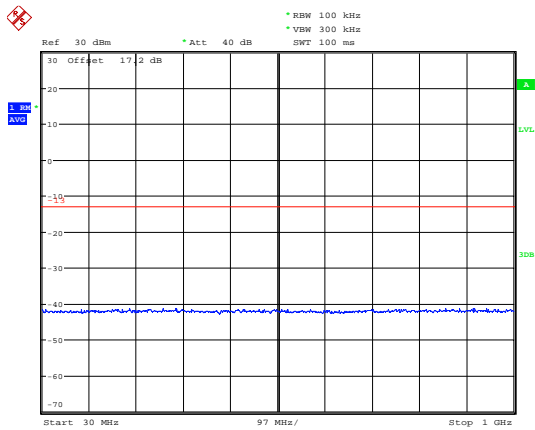

Date: 28.OCT.2019 17:36:34

### LTE Band 4 3MHz CH-Middle 1GHz ~20GHz

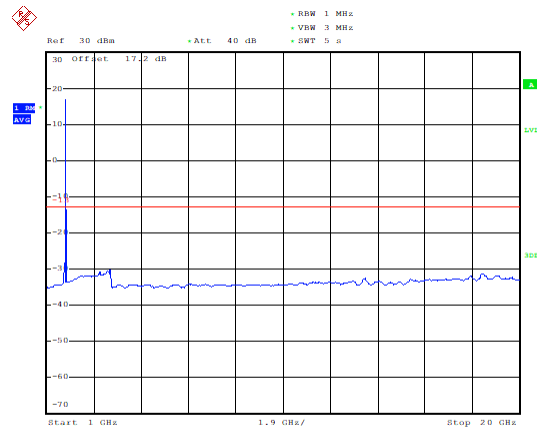

Date: 28.OCT.2019 17:55:40

### LTE Band 4 3MHz CH-High 30MHz~1GHz

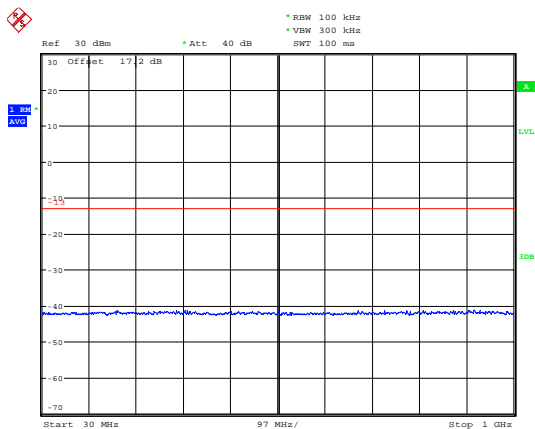

Date: 28.OCT.2019 17:39:34

### LTE Band 4 3MHz CH-High 1GHz ~20GHz

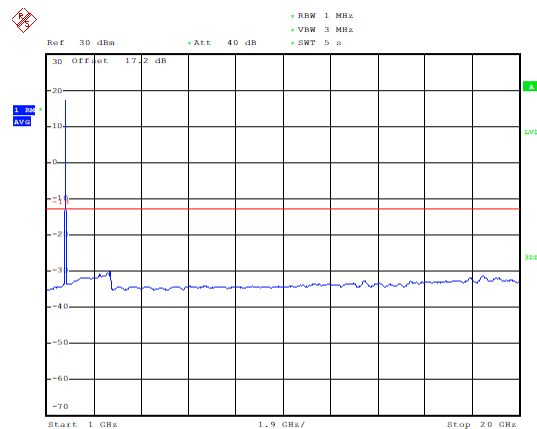

Date: 28.OCT.2019 17:57:09



### LTE Band 4 5MHz CH-Low 30MHz~1GHz

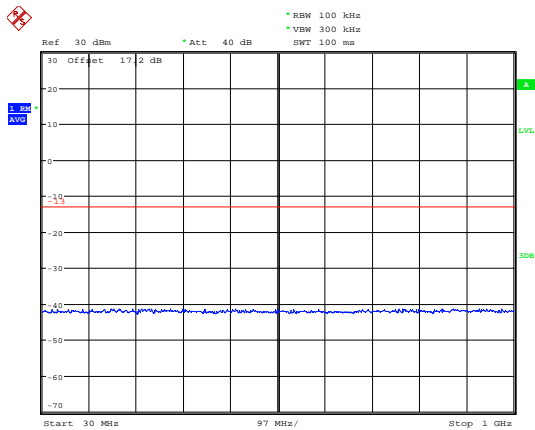

Date: 28.OCT.2019 17:40:28

### LTE Band 4 5MHz CH-Low 1GHz ~20GHz

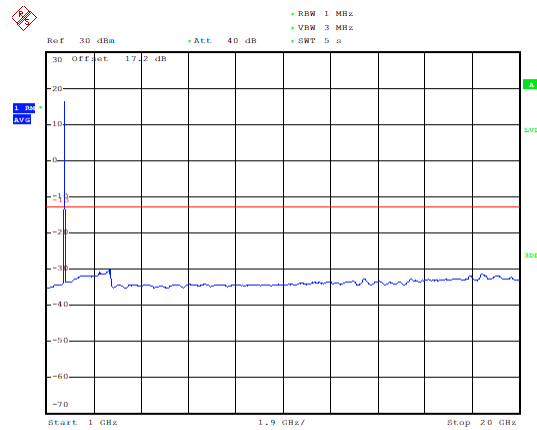

Date: 28.OCT.2019 17:58:16

### LTE Band 4 5MHz CH-Middle 30MHz~1GHz

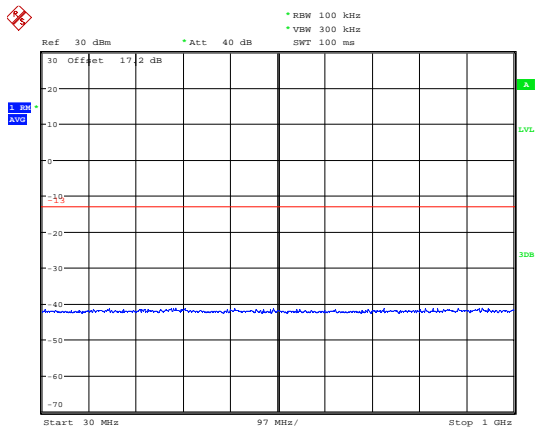

Date: 28.OCT.2019 17:41:50

### LTE Band 4 5MHz CH-Middle 1GHz ~20GHz

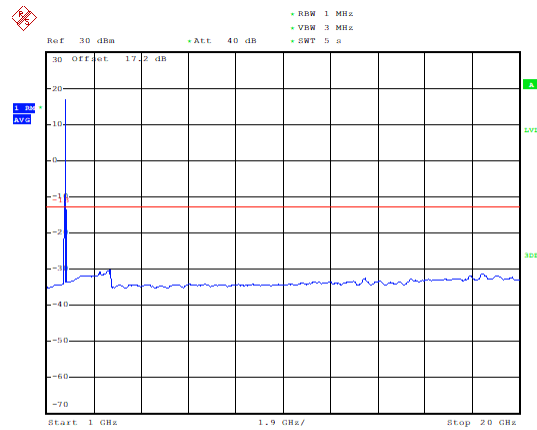

Date: 28.OCT.2019 17:58:58

### LTE Band 4 5MHz CH-High 30MHz~1GHz

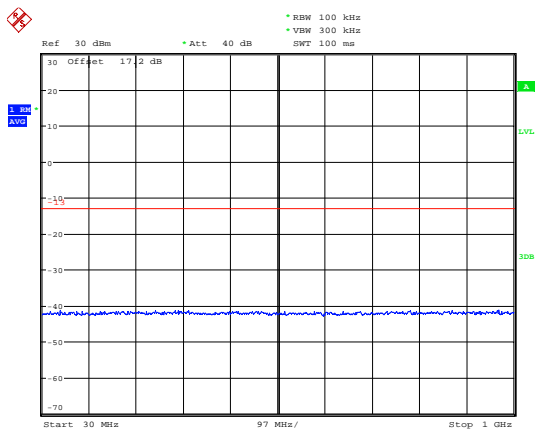

Date: 28.OCT.2019 17:42:50

### LTE Band 4 5MHz CH-High 1GHz ~20GHz

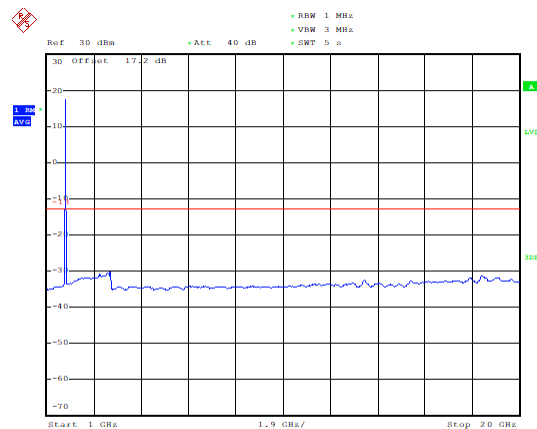

Date: 28.OCT.2019 17:59:35





### LTE Band 4 10MHz CH-Low 30MHz~1GHz

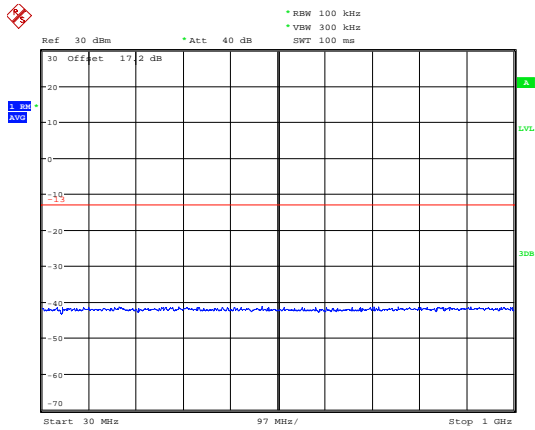

Date: 28.OCT.2019 17:43:55

### LTE Band 4 10MHz CH-Low 1GHz ~20GHz

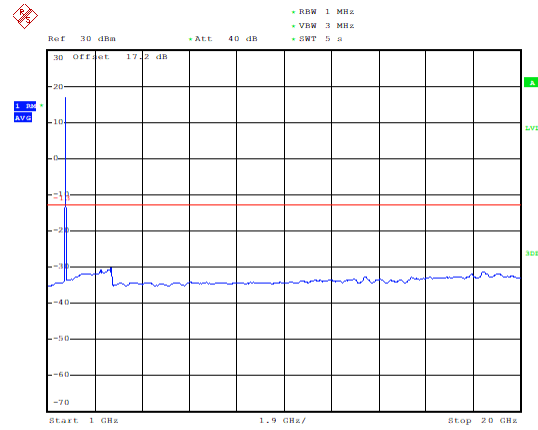

Date: 28.OCT.2019 18:00:24

### LTE Band 4 10MHz CH-Middle 30MHz~1GHz

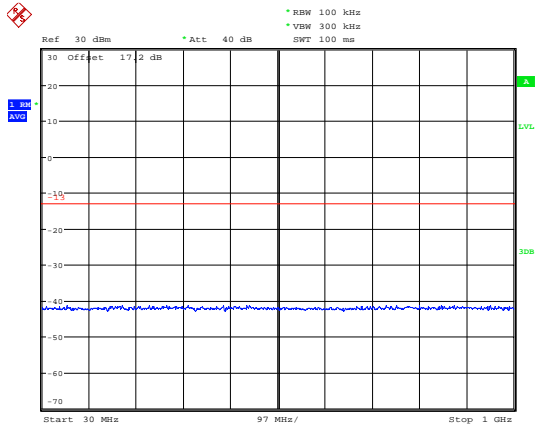

Date: 28.OCT.2019 17:44:34

### LTE Band 4 10MHz CH-Middle 1GHz ~20GHz

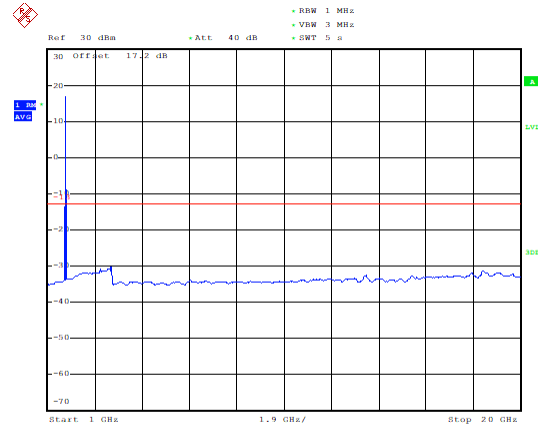

Date: 28.OCT.2019 18:01:10

### LTE Band 4 10MHz CH-High 30MHz~1GHz

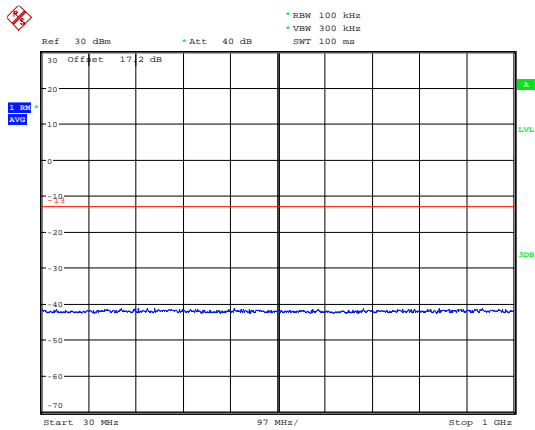

Date: 28.OCT.2019 17:44:59

### LTE Band 4 10MHz CH-High 1GHz ~20GHz

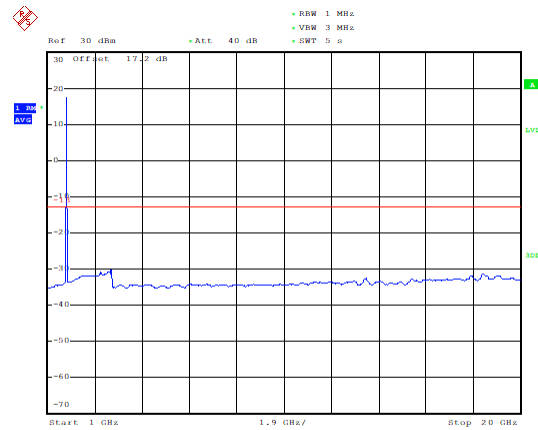

Date: 28.OCT.2019 18:01:49



### LTE Band 4 15MHz CH-Low 30MHz~1GHz

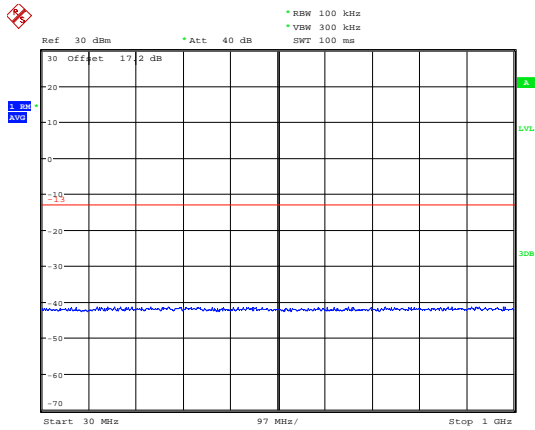

Date: 28.OCT.2019 17:46:41

### LTE Band 4 15MHz CH-Low 1GHz ~20GHz

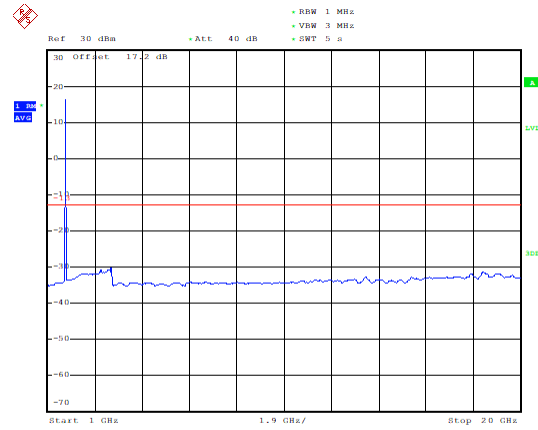

Date: 28.OCT.2019 18:03:30

### LTE Band 4 15MHz CH-Middle 30MHz~1GHz

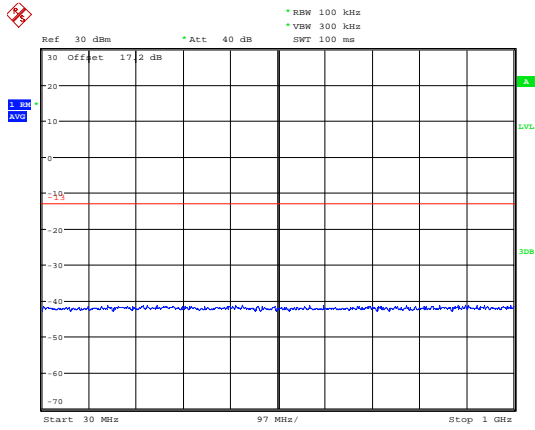

Date: 28.OCT.2019 17:47:01

### LTE Band 4 15MHz CH-Middle 1GHz ~20GHz

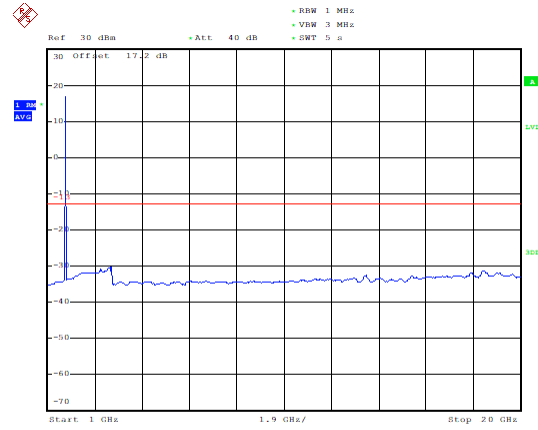

Date: 28.OCT.2019 18:04:40

### LTE Band 4 15MHz CH-High 30MHz~1GHz

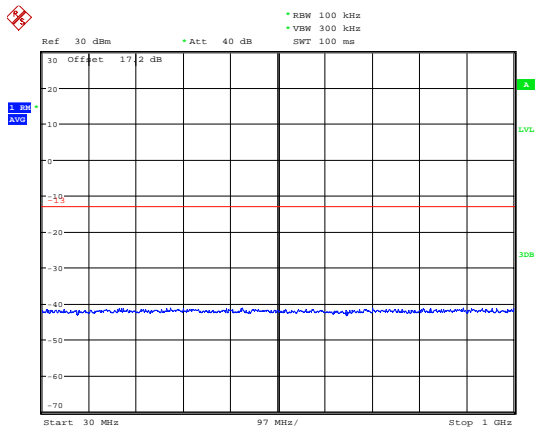

Date: 28.OCT.2019 17:47:25

### LTE Band 4 15MHz CH-High 1GHz ~20GHz

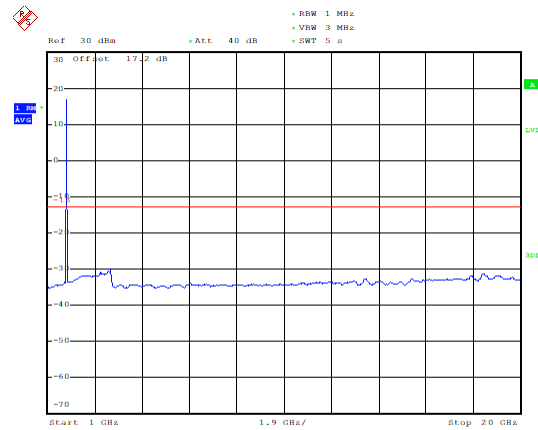

Date: 28.OCT.2019 18:06:22



### LTE Band 4 20MHz CH-Low 30MHz~1GHz

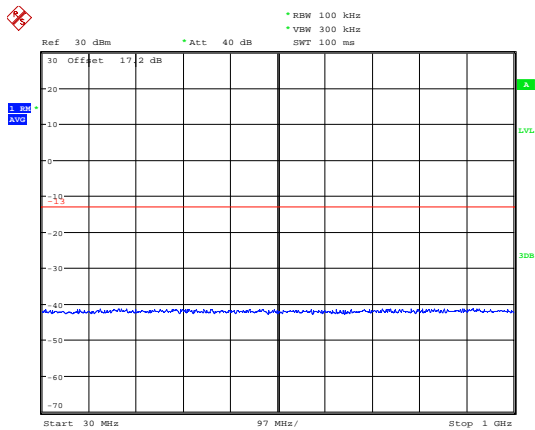

Date: 28.OCT.2019 17:48:28

### LTE Band 4 20MHz CH-Low 1GHz ~20GHz

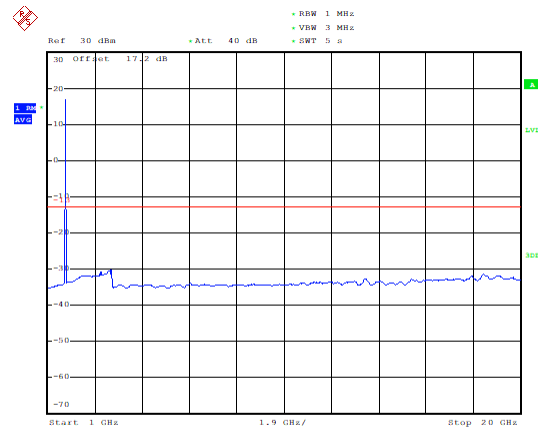

Date: 28.OCT.2019 18:07:59

### LTE Band 4 20MHz CH-Middle 30MHz~1GHz

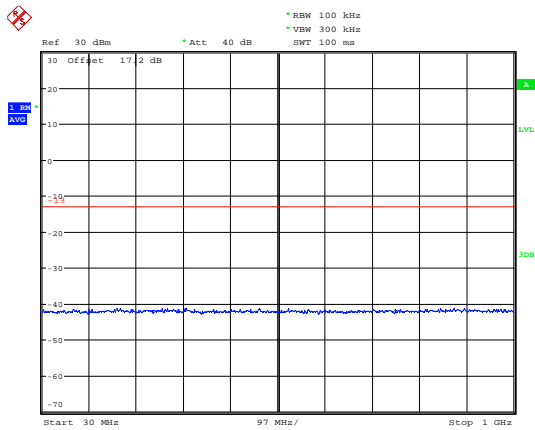

Date: 28.OCT.2019 17:49:14

### LTE Band 4 20MHz CH-Middle 1GHz ~20GHz

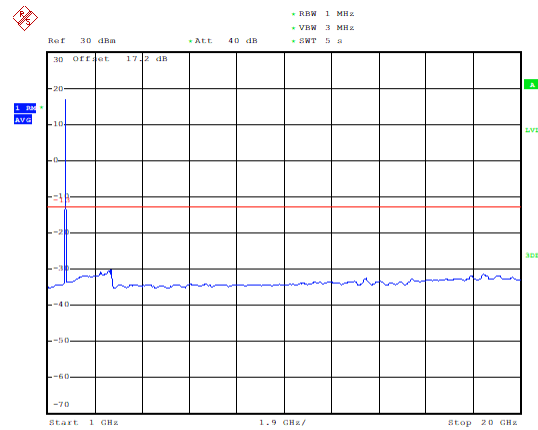

Date: 28.OCT.2019 18:08:21

### LTE Band 4 20MHz CH-High 30MHz~1GHz

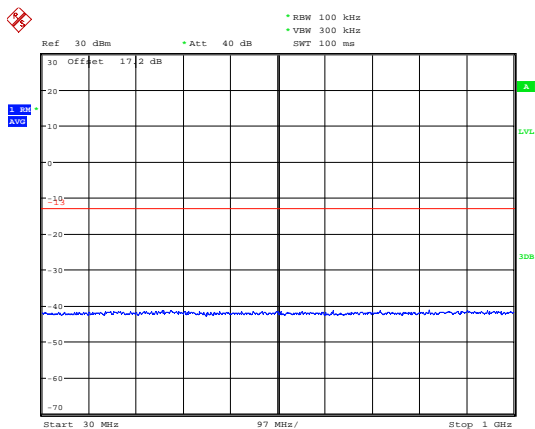

Date: 28.OCT.2019 17:49:58

### LTE Band 4 20MHz CH-High 1GHz ~20GHz

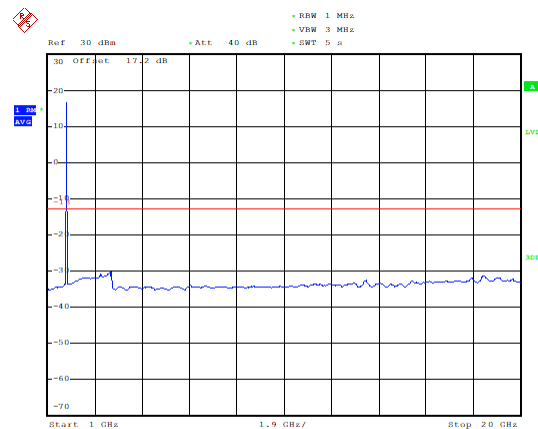

Date: 28.OCT.2019 18:08:48



### LTE Band 12 1.4MHz CH-Low 30MHz~1GHz

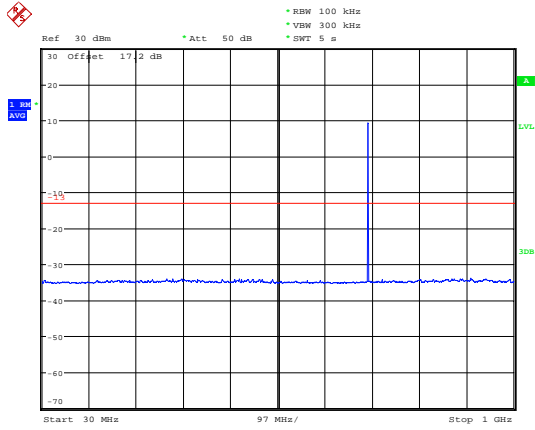

Date: 29.OCT.2019 11:18:12

### LTE Band 12 1.4MHz CH-Low 1GHz ~9GHz

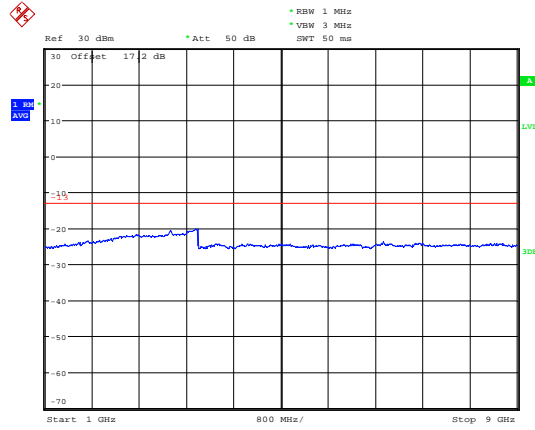

Date: 29.OCT.2019 10:40:56

### LTE Band 12 1.4MHz CH-Middle 30MHz~1GHz

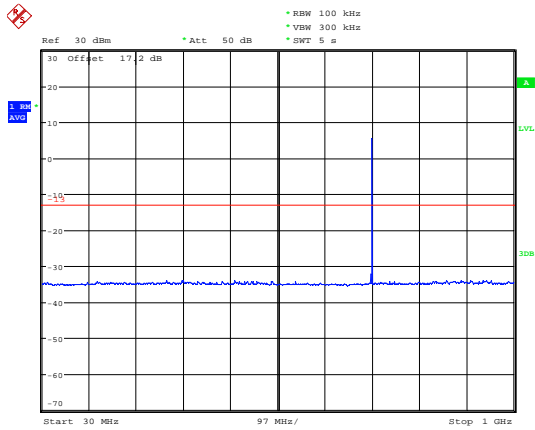

Date: 29.OCT.2019 11:18:40

### LTE Band 12 1.4MHz CH-Middle 1GHz ~9GHz

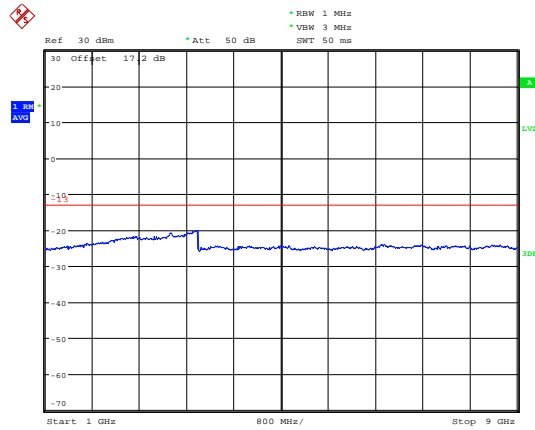

Date: 29.OCT.2019 11:00:13

### LTE Band 12 1.4MHz CH-High 30MHz~1GHz

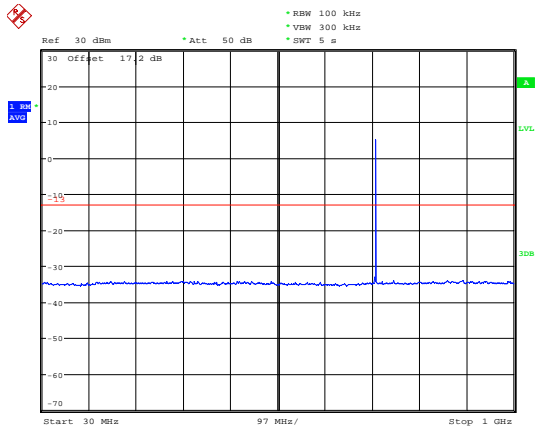

Date: 29.OCT.2019 11:20:13

### LTE Band 12 1.4MHz CH-High 1GHz ~9GHz

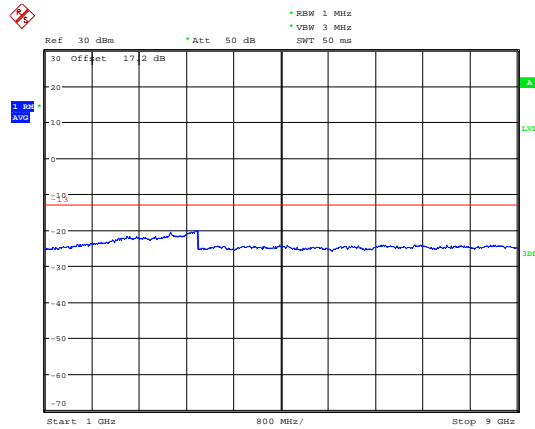

Date: 29.OCT.2019 11:01:44





### LTE Band 12 3MHz CH-Low 30MHz~1GHz

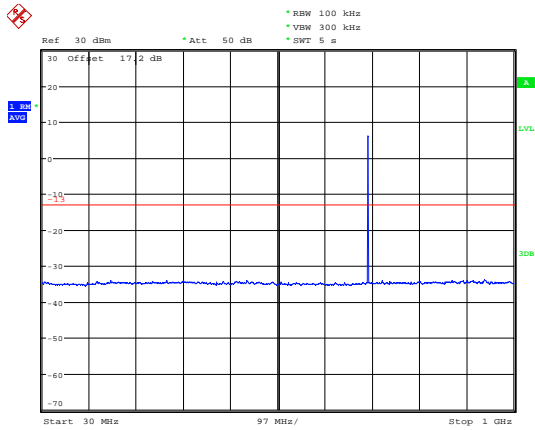

Date: 29.OCT.2019 11:21:35

### LTE Band 12 3MHz CH-Low 1GHz ~9GHz

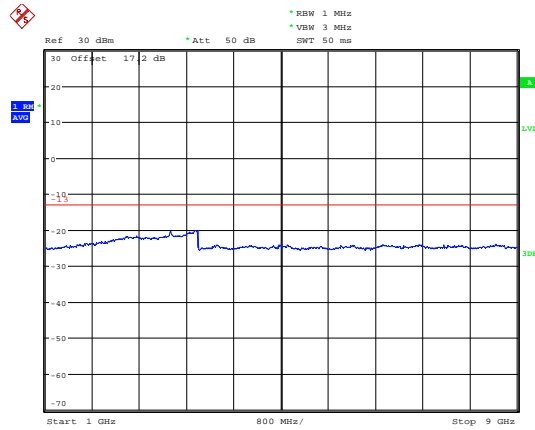

Date: 29.OCT.2019 11:08:22

### LTE Band 12 3MHz CH-Middle 30MHz~1GHz

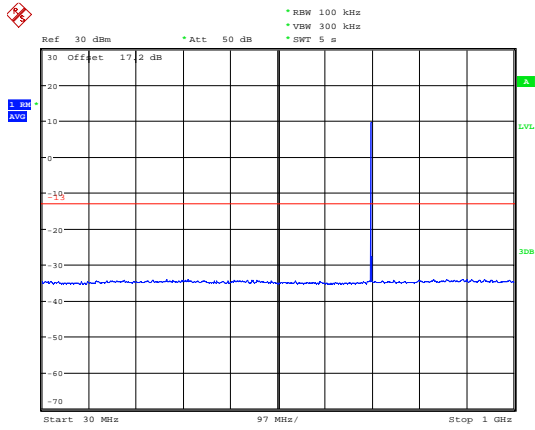

Date: 29.OCT.2019 11:22:51

### LTE Band 12 3MHz CH-Middle 1GHz ~9GHz

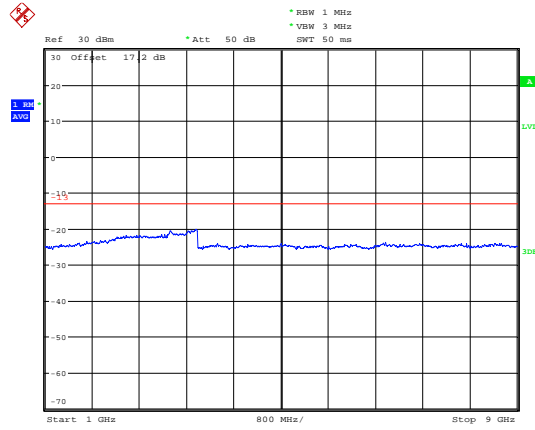

Date: 29.OCT.2019 11:08:42

### LTE Band 12 3MHz CH-High 30MHz~1GHz

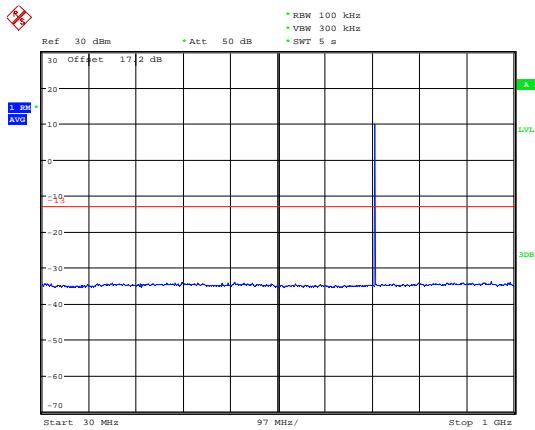

Date: 29.OCT.2019 11:24:19

### LTE Band 12 3MHz CH-High 1GHz ~9GHz

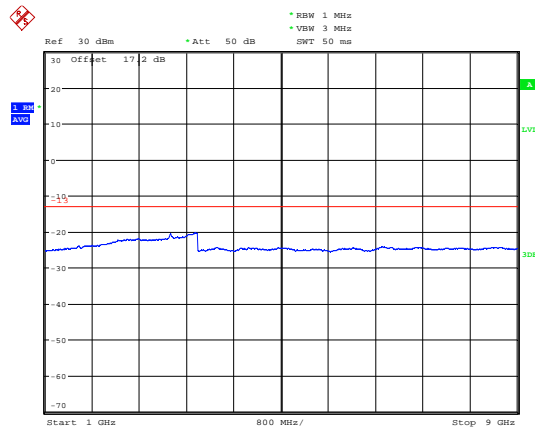

Date: 29.OCT.2019 11:09:40



### LTE Band 12 5MHz CH-Low 30MHz~1GHz

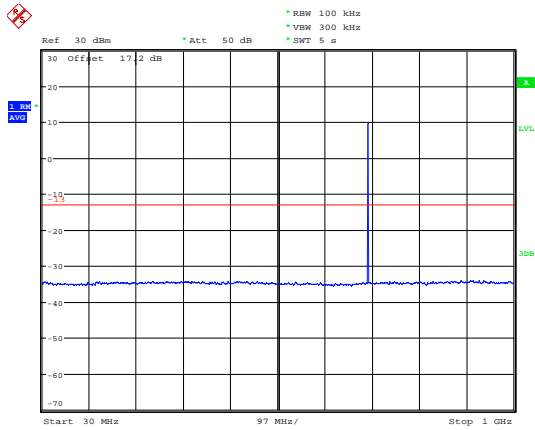

Date: 29.OCT.2019 11:25:51

### LTE Band 12 5MHz CH-Low 1GHz ~9GHz

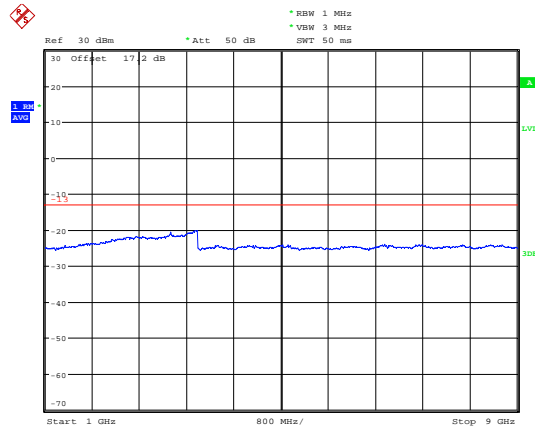

Date: 29.OCT.2019 11:10:22

### LTE Band 12 5MHz CH-Middle 30MHz~1GHz

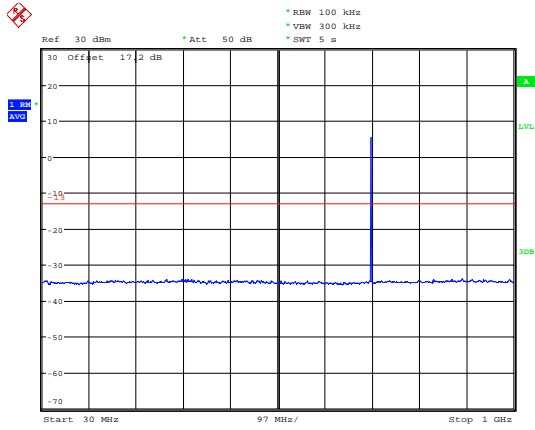

Date: 29.OCT.2019 11:26:52

### LTE Band 12 5MHz CH-Middle 1GHz ~9GHz

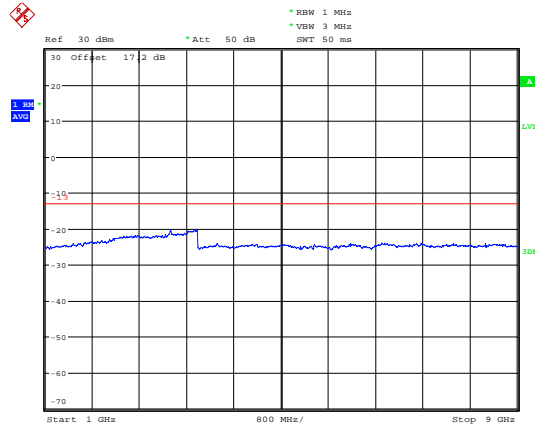

Date: 29.OCT.2019 11:10:41

### LTE Band 12 5MHz CH-High 30MHz~1GHz

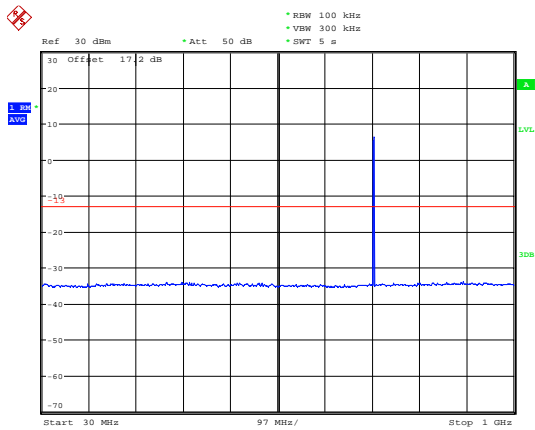

Date: 29.OCT.2019 11:28:33

### LTE Band 12 5MHz CH-High 1GHz ~9GHz

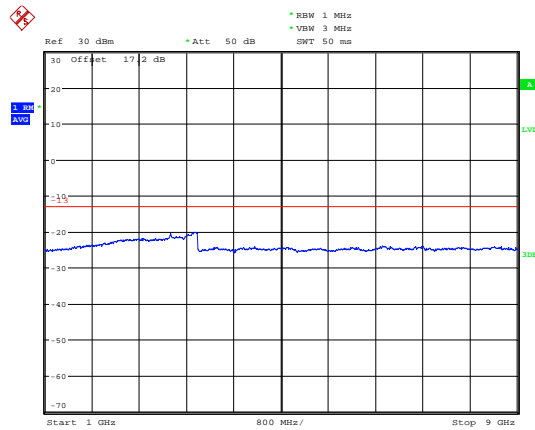

Date: 29.OCT.2019 11:11:41



### LTE Band 12 10MHz CH-Low 30MHz~1GHz

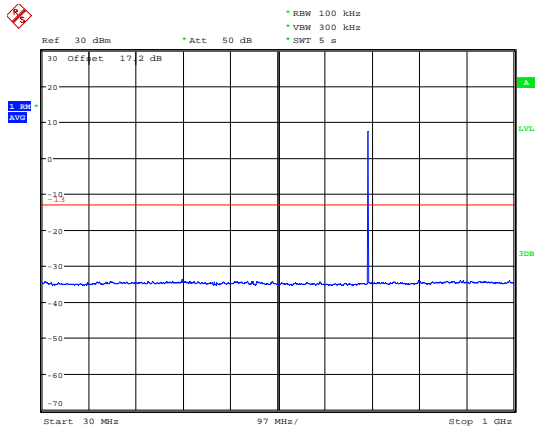

Date: 29.OCT.2019 11:30:14

### LTE Band 12 10MHz CH-Low 1GHz ~9GHz

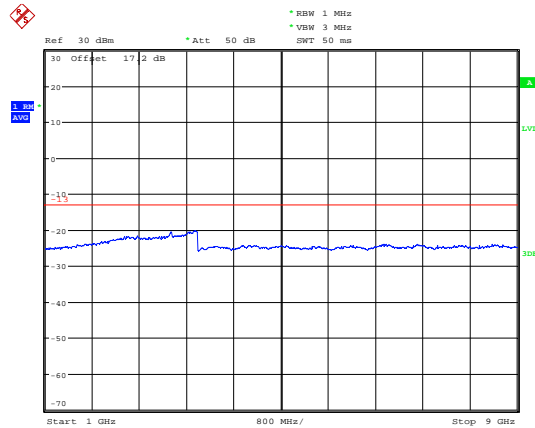

Date: 29.OCT.2019 11:12:41

### LTE Band 12 10MHz CH-Middle 30MHz~1GHz

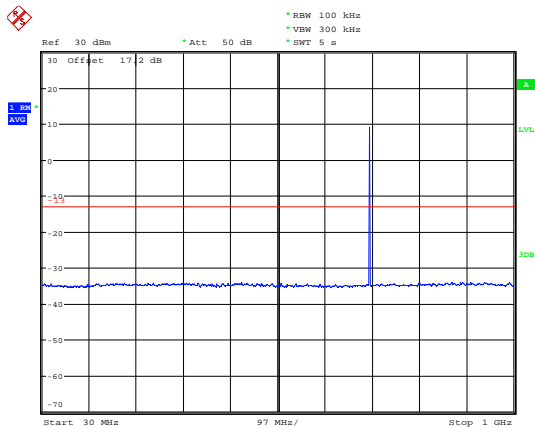

Date: 29.OCT.2019 11:33:22

### LTE Band 12 10MHz CH-Middle 1GHz ~9GHz

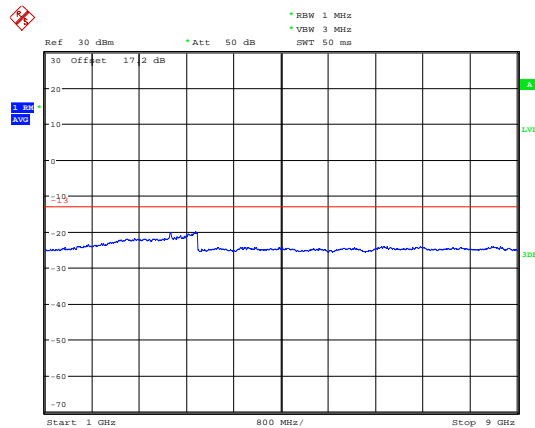

Date: 29.OCT.2019 11:13:07

### LTE Band 12 10MHz CH-High 30MHz~1GHz

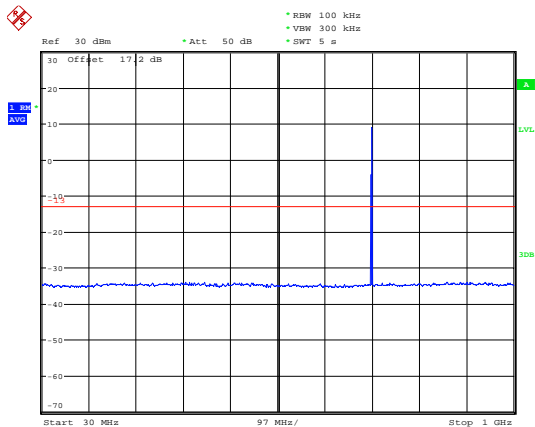

Date: 29.OCT.2019 11:34:13

### LTE Band 12 10MHz CH-High 1GHz ~9GHz

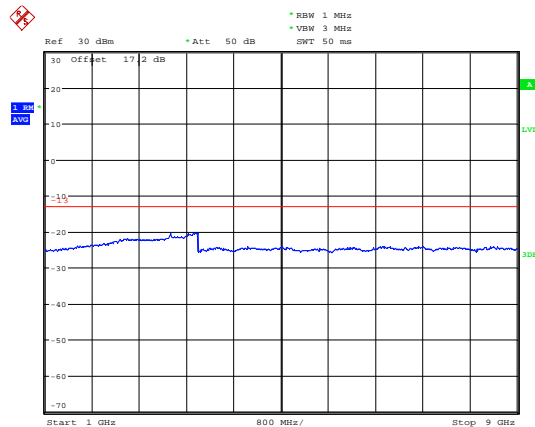

Date: 29.OCT.2019 11:15:23



### LTE Band 13 5MHz CH-Low 30MHz~1GHz

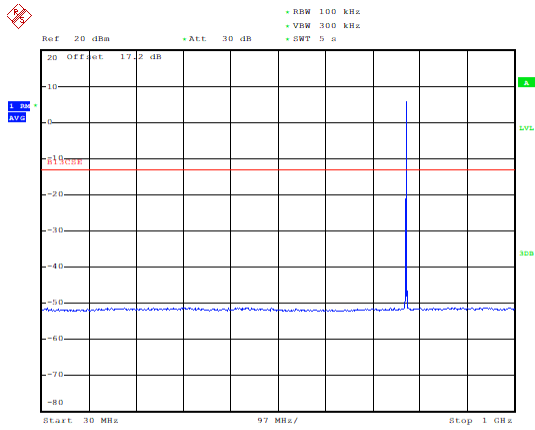

Date: 29.OCT.2019 17:24:36

### LTE Band 13 5MHz CH-Low 1GHz ~9GHz

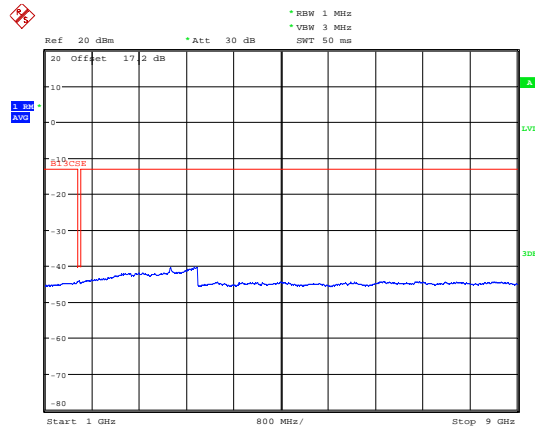

Date: 29.OCT.2019 17:29:40

### LTE Band 13 5MHz CH-Middle 30MHz~1GHz

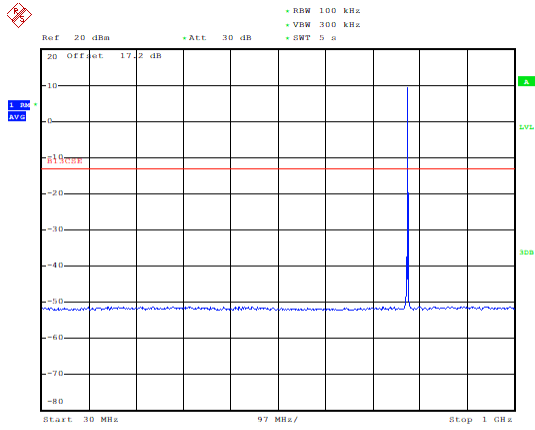

Date: 29.OCT.2019 17:28:11

### LTE Band 13 5MHz CH-Middle 1GHz ~9GHz

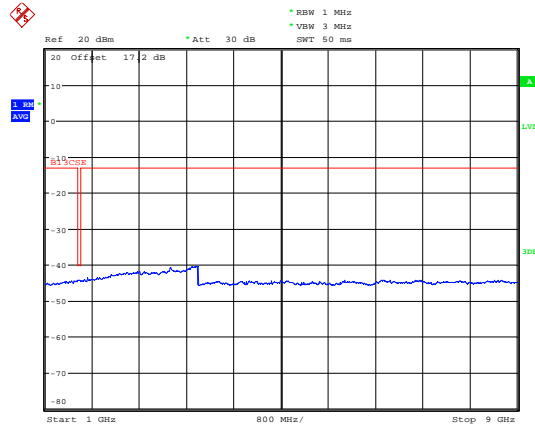

Date: 29.OCT.2019 17:30:45

### LTE Band 13 5MHz CH-High 30MHz~1GHz

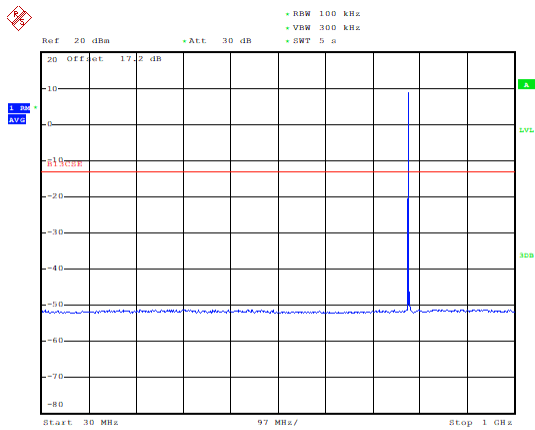

Date: 29.OCT.2019 17:27:10

### LTE Band 13 5MHz CH-High 1GHz ~9GHz

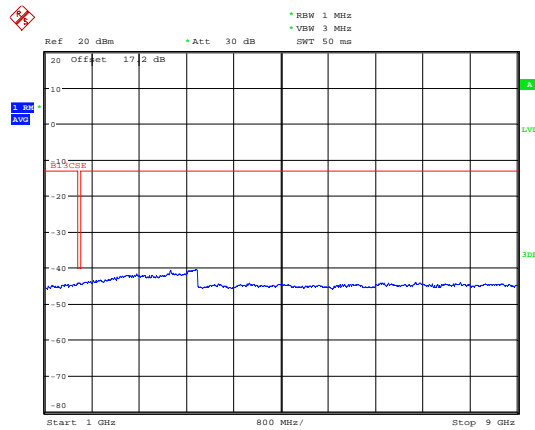

Date: 29.OCT.2019 17:31:05





### LTE Band 13 10MHz CH-Middle 30MHz~1GHz

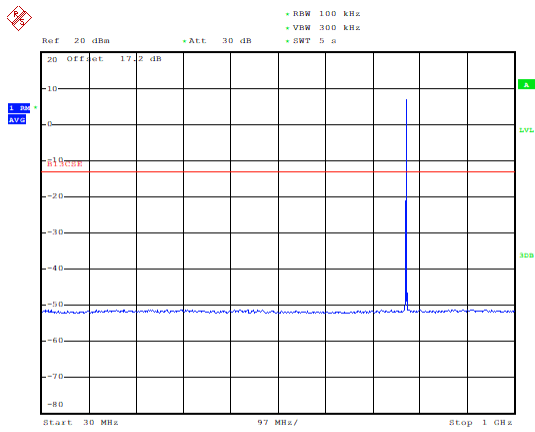

Date: 29.OCT.2019 17:28:25

### LTE Band 13 10MHz CH-Middle 1GHz ~9GHz

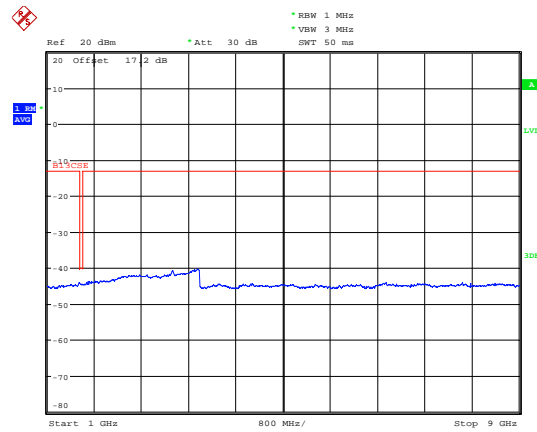

Date: 29.OCT.2019 17:31:23



### LTE Band 66 1.4MHz CH-Low 30MHz~1GHz

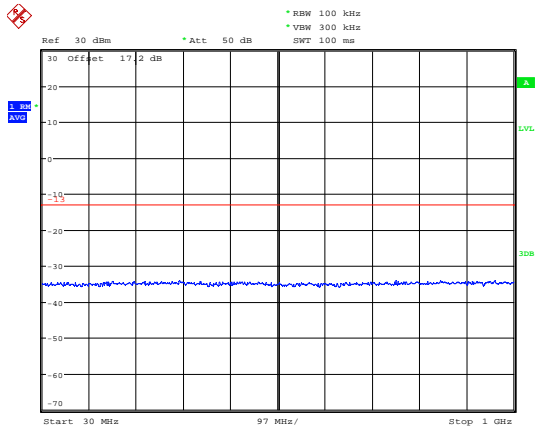

Date: 29.OCT.2019 16:33:01

### LTE Band 66 1.4MHz CH-Low 1GHz ~20GHz

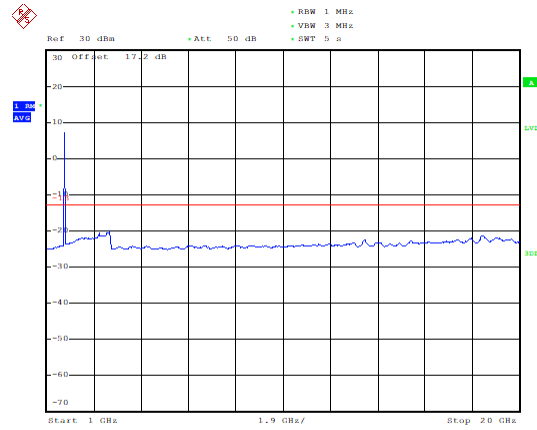

Date: 29.OCT.2019 16:48:51

### LTE Band 66 1.4MHz CH-Middle 30MHz~1GHz

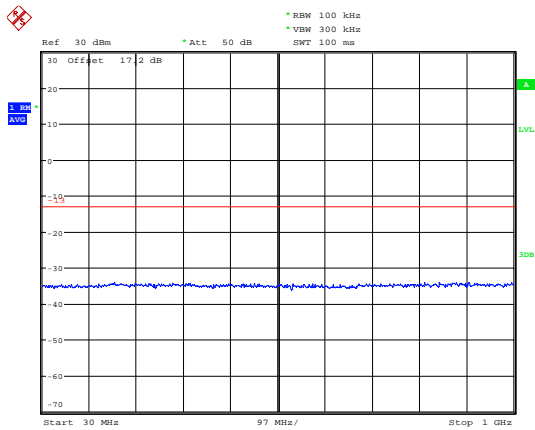

Date: 29.OCT.2019 16:34:47

### LTE Band 66 1.4MHz CH-Middle 1GHz ~20GHz

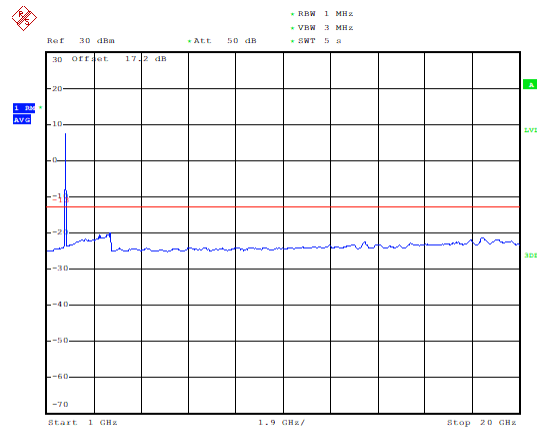

Date: 29.OCT.2019 16:51:00

### LTE Band 66 1.4MHz CH-High 30MHz~1GHz

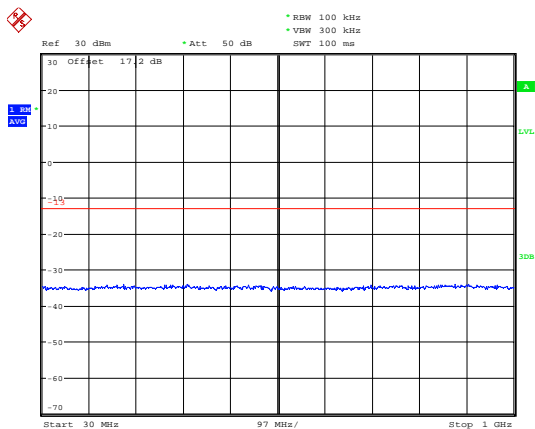

Date: 29.OCT.2019 16:35:22

### LTE Band 66 1.4MHz CH-High 1GHz ~20GHz

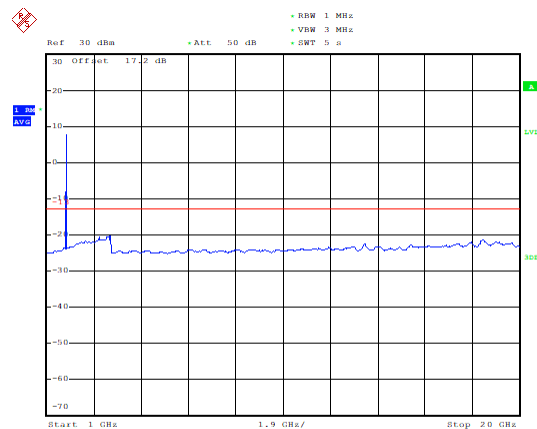

Date: 29.OCT.2019 16:51:40



### LTE Band 66 3MHz CH-Low 30MHz~1GHz

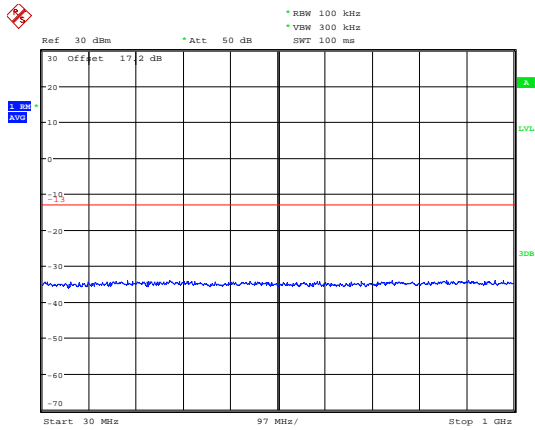

Date: 29.OCT.2019 16:35:48

### LTE Band 66 3MHz CH-Low 1GHz ~20GHz

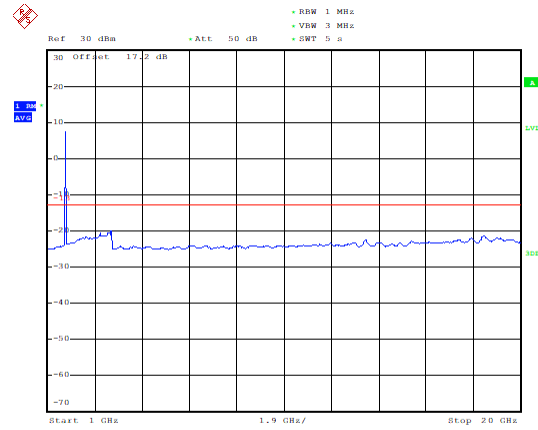

Date: 29.OCT.2019 16:54:00

### LTE Band 66 3MHz CH-Middle 30MHz~1GHz

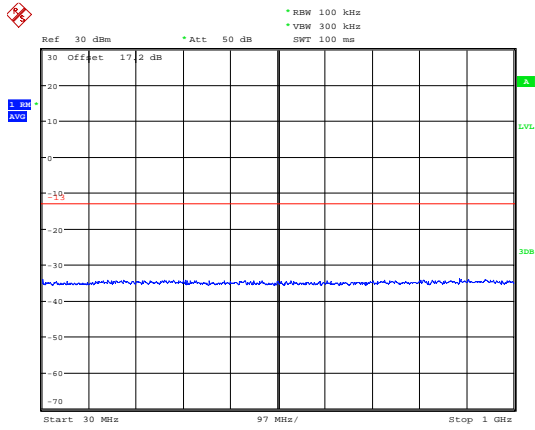

Date: 29.OCT.2019 16:36:05

### LTE Band 66 3MHz CH-Middle 1GHz ~20GHz

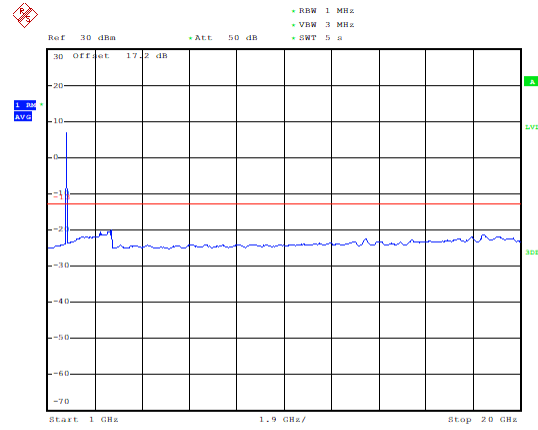

Date: 29.OCT.2019 16:56:06

### LTE Band 66 3MHz CH-High 30MHz~1GHz

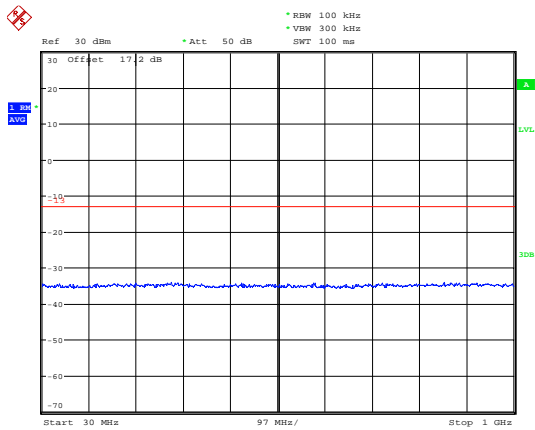

Date: 29.OCT.2019 16:37:21

### LTE Band 66 3MHz CH-High 1GHz ~20GHz

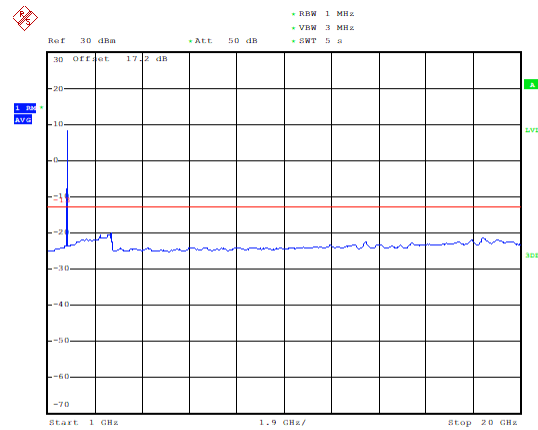

Date: 29.OCT.2019 16:56:35



### LTE Band 66 5MHz CH-Low 30MHz~1GHz

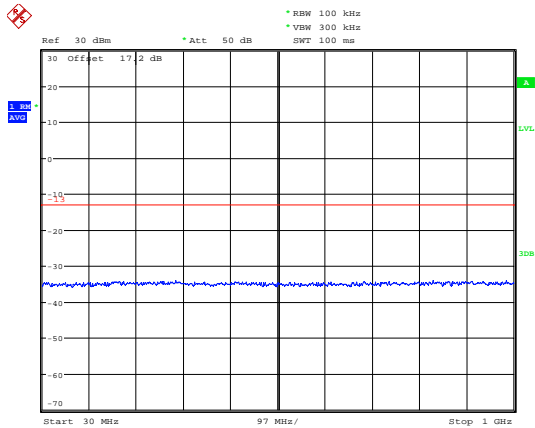

Date: 29.OCT.2019 16:37:41

### LTE Band 66 5MHz CH-Low 1GHz ~20GHz

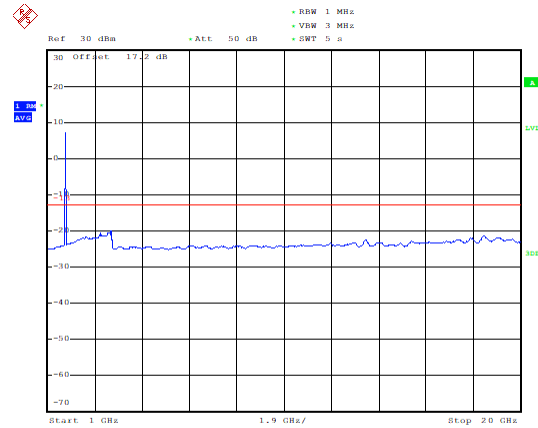

Date: 29.OCT.2019 16:56:56

### LTE Band 66 5MHz CH-Middle 30MHz~1GHz

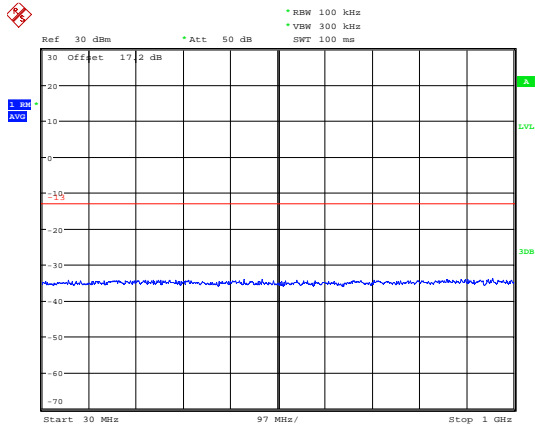

Date: 29.OCT.2019 16:37:55

### LTE Band 66 5MHz CH-Middle 1GHz ~20GHz

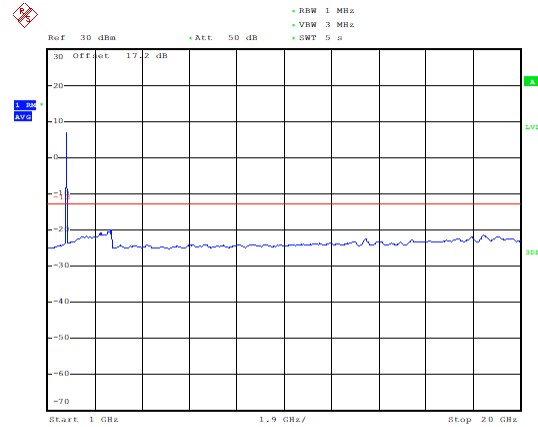

Date: 29.OCT.2019 16:57:17

### LTE Band 66 5MHz CH-High 30MHz~1GHz

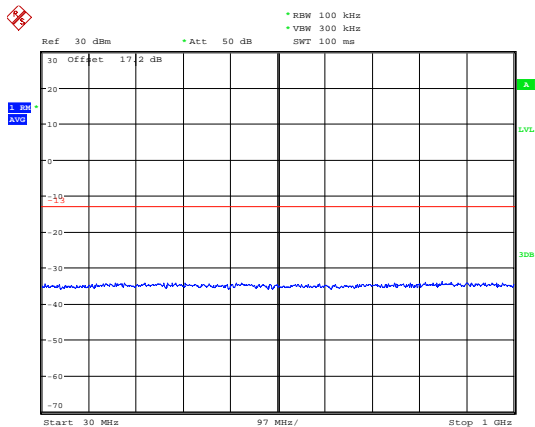

Date: 29.OCT.2019 16:38:14

### LTE Band 66 5MHz CH-High 1GHz ~20GHz

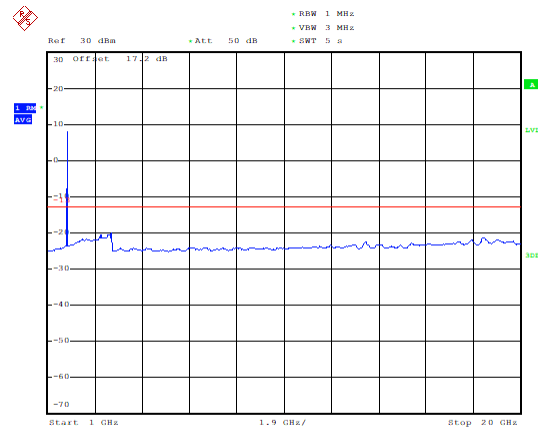

Date: 29.OCT.2019 16:58:42





### LTE Band 66 10MHz CH-Low 30MHz~1GHz

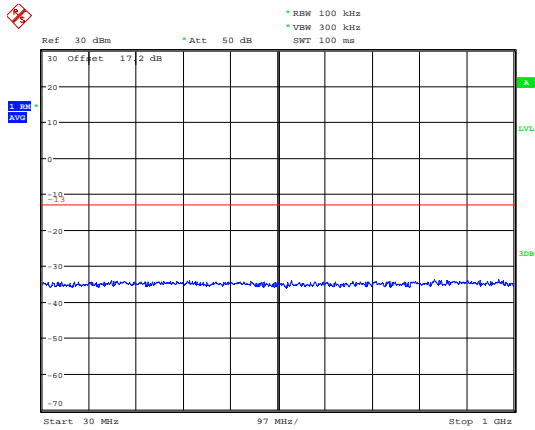

Date: 29.OCT.2019 16:38:35

### LTE Band 66 10MHz CH-Low 1GHz ~20GHz

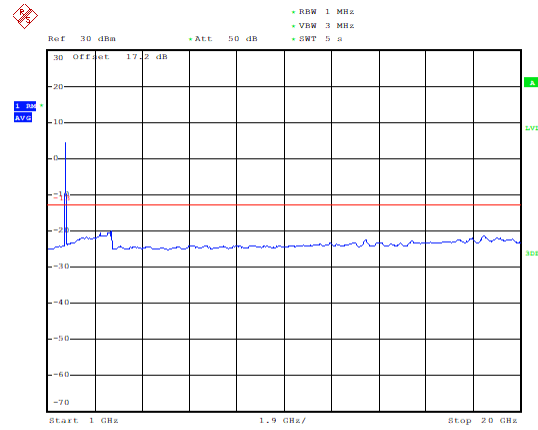

Date: 29.OCT.2019 17:00:20

### LTE Band 66 10MHz CH-Middle 30MHz~1GHz

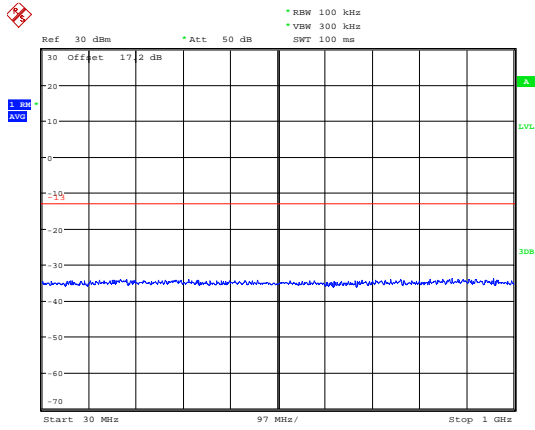

Date: 29.OCT.2019 16:38:50

### LTE Band 66 10MHz CH-Middle 1GHz ~20GHz

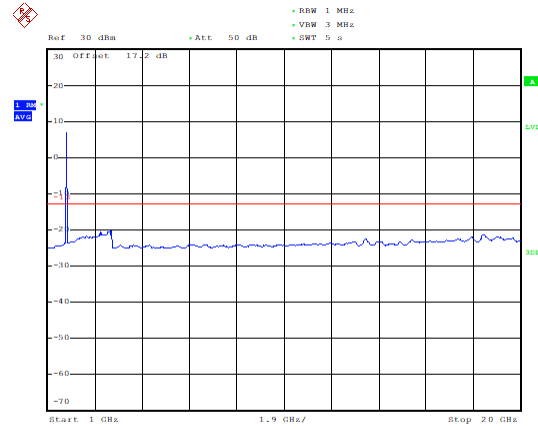

Date: 29.OCT.2019 17:02:02

### LTE Band 66 10MHz CH-High 30MHz~1GHz

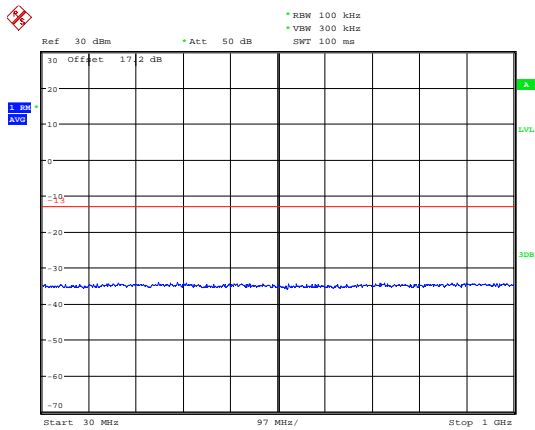

Date: 29.OCT.2019 16:39:11

### LTE Band 66 10MHz CH-High 1GHz ~20GHz

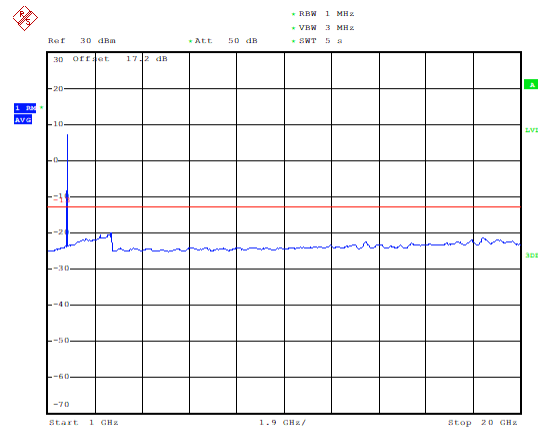

Date: 29.OCT.2019 17:02:57



### LTE Band 66 15MHz CH-Low 30MHz~1GHz

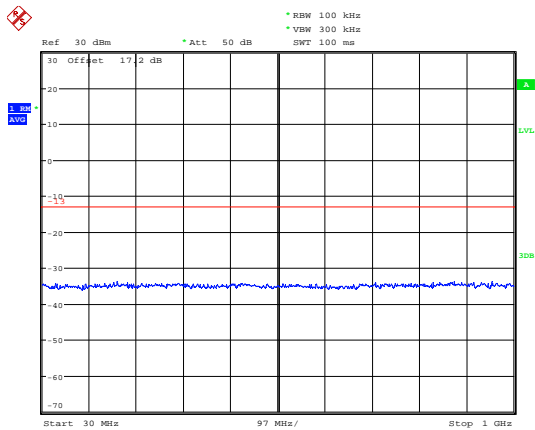

Date: 29.OCT.2019 16:39:33

### LTE Band 66 15MHz CH-Low 1GHz ~20GHz

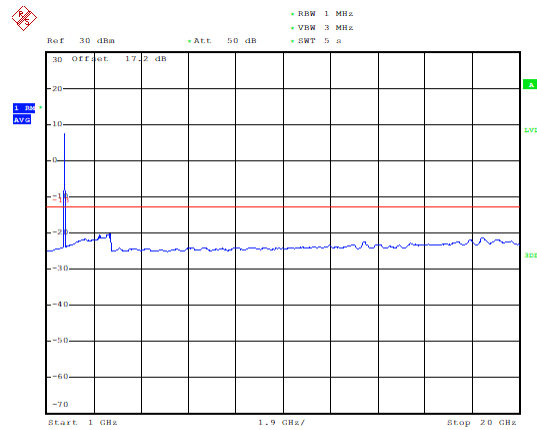

Date: 29.OCT.2019 17:03:53

### LTE Band 66 15MHz CH-Middle 30MHz~1GHz

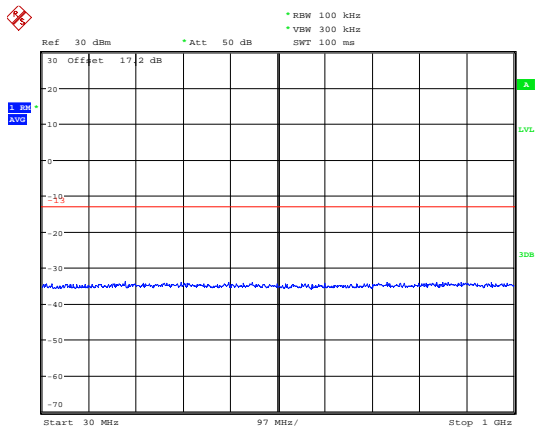

Date: 29.OCT.2019 16:40:39

### LTE Band 66 15MHz CH-Middle 1GHz ~20GHz

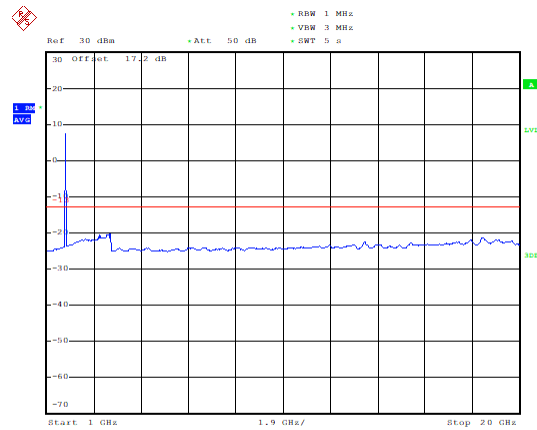

Date: 29.OCT.2019 17:04:11

### LTE Band 66 15MHz CH-High 30MHz~1GHz

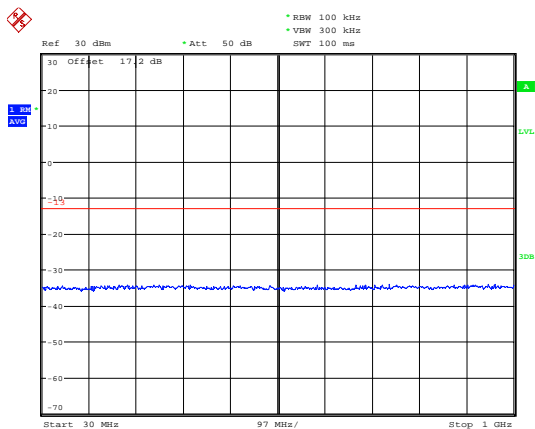

Date: 29.OCT.2019 16:42:52

### LTE Band 66 15MHz CH-High 1GHz ~20GHz

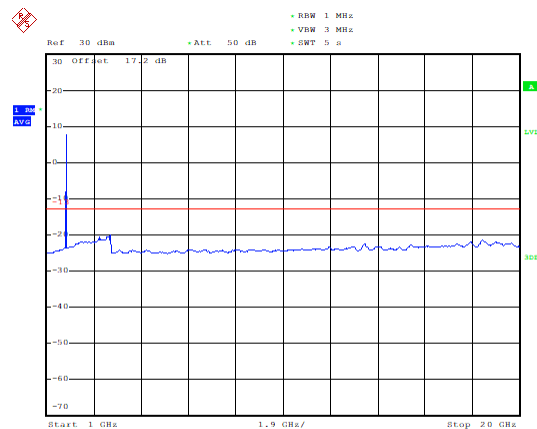

Date: 29.OCT.2019 17:04:35



### LTE Band 66 20MHz CH-Low 30MHz~1GHz

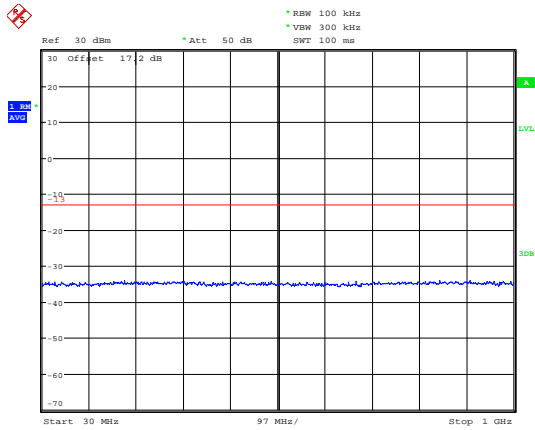

Date: 29.OCT.2019 16:44:26

### LTE Band 66 20MHz CH-Low 1GHz ~20GHz

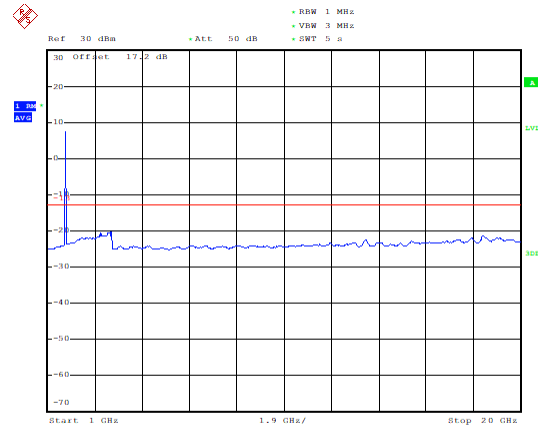

Date: 29.OCT.2019 17:04:55

### LTE Band 66 20MHz CH-Middle 30MHz~1GHz

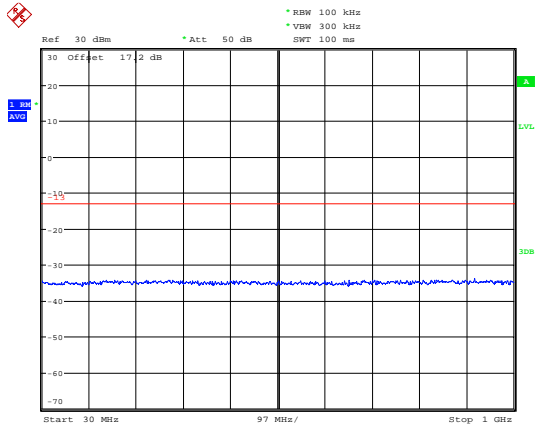

Date: 29.OCT.2019 16:45:53

### LTE Band 66 20MHz CH-Middle 1GHz ~20GHz

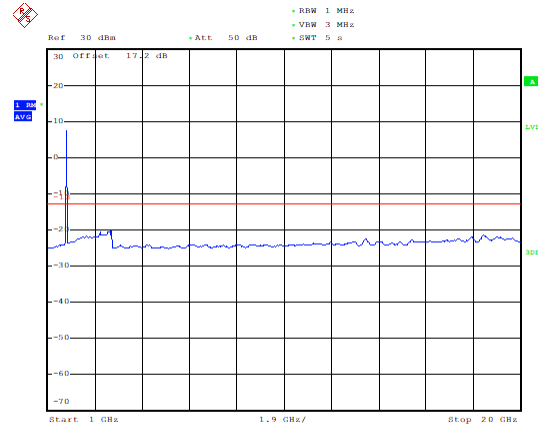

Date: 29.OCT.2019 17:05:20

### LTE Band 66 20MHz CH-High 30MHz~1GHz

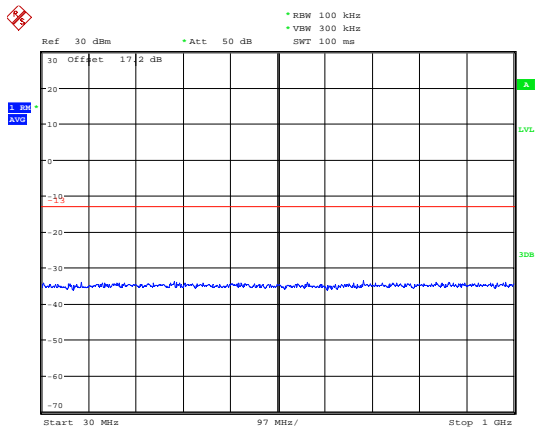

Date: 29.OCT.2019 16:46:13

### LTE Band 66 20MHz CH-High 1GHz ~20GHz

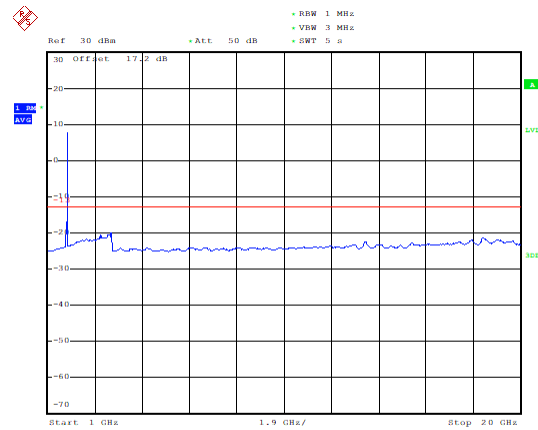

Date: 29.OCT.2019 17:05:42



### LTE Band 85 5MHz CH-Low 30MHz~1GHz

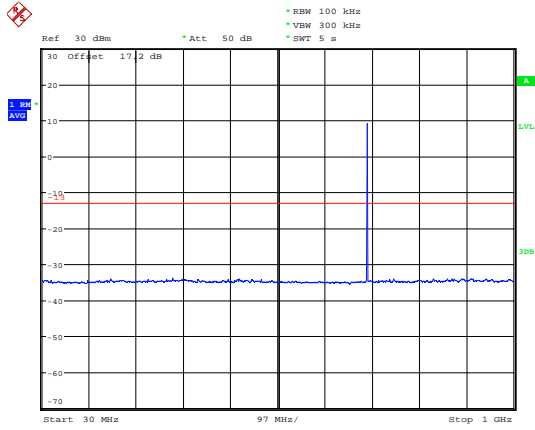

Date: 16.MAR.2020 19:03:11

### LTE Band 85 5MHz CH-Low 1GHz ~9GHz

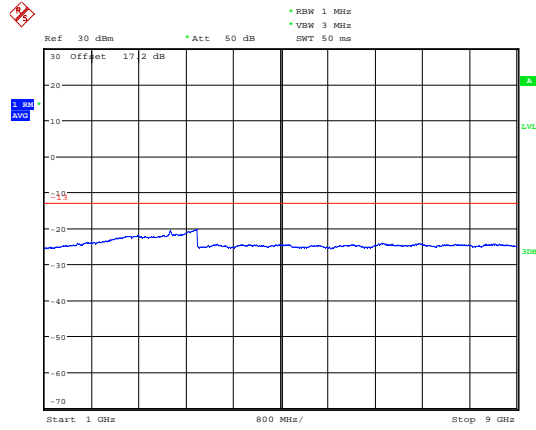

Date: 16.MAR.2020 19:08:00

### LTE Band 85 5MHz CH- Middle 30MHz~1GHz

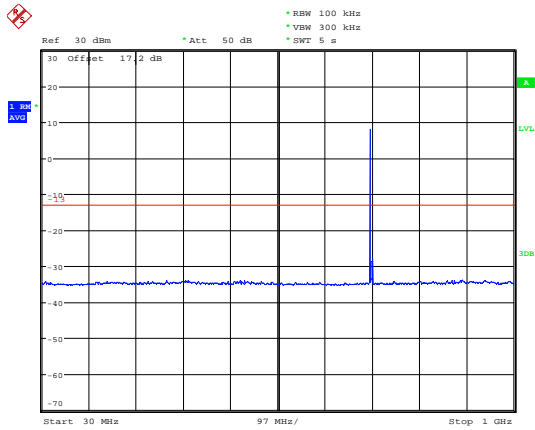

Date: 16.MAR.2020 19:03:48

### LTE Band 85 5MHz CH- Middle 1GHz ~9GHz

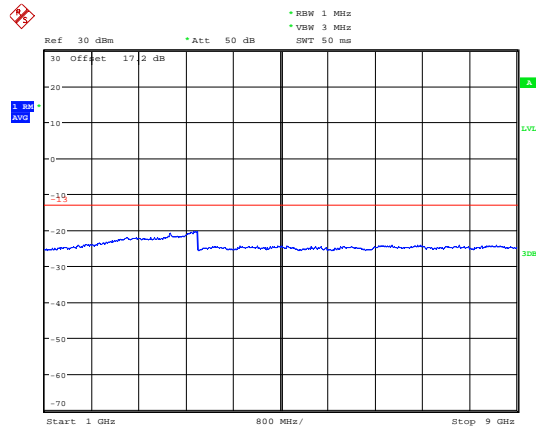

Date: 16.MAR.2020 19:08:19

### LTE Band 85 5MHz CH- High 30MHz~1GHz

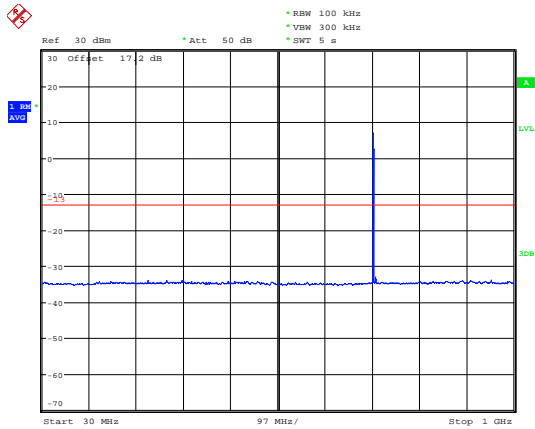

Date: 16.MAR.2020 19:04:23

### LTE Band 85 5MHz CH- High 1GHz ~9GHz

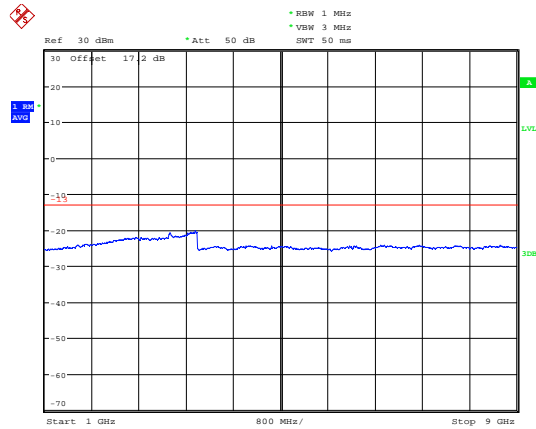

Date: 16.MAR.2020 19:08:38



### LTE Band 85 10MHz CH-Low 30MHz~1GHz

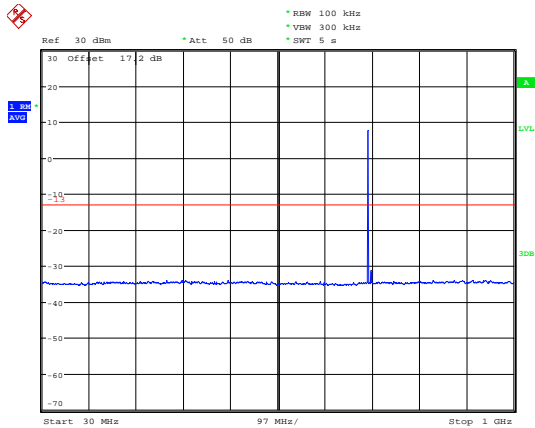

Date: 16.MAR.2020 19:02:27

### LTE Band 85 10MHz CH-Low 1GHz ~9GHz

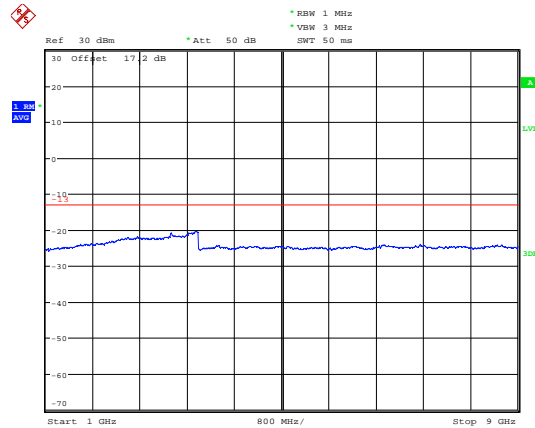

Date: 16.MAR.2020 19:09:48

### LTE Band 85 10MHz CH- Middle 30MHz~1GHz

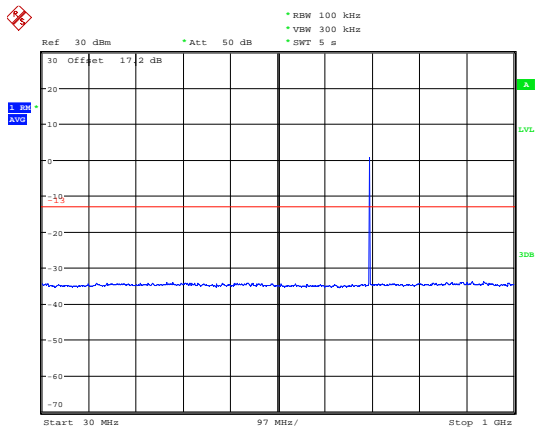

Date: 16.MAR.2020 19:02:00

### LTE Band 85 10MHz CH- Middle 1GHz ~9GHz

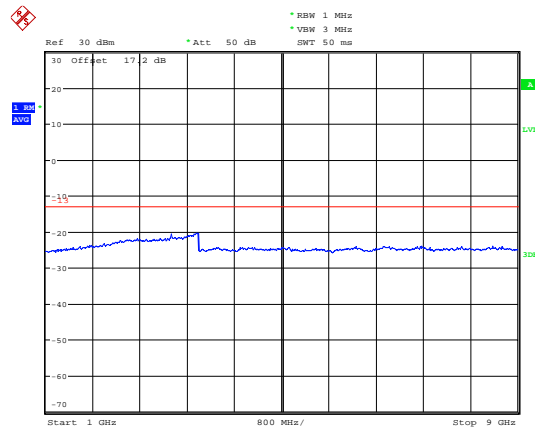

Date: 16.MAR.2020 19:10:12

### LTE Band 85 10MHz CH- High 30MHz~1GHz

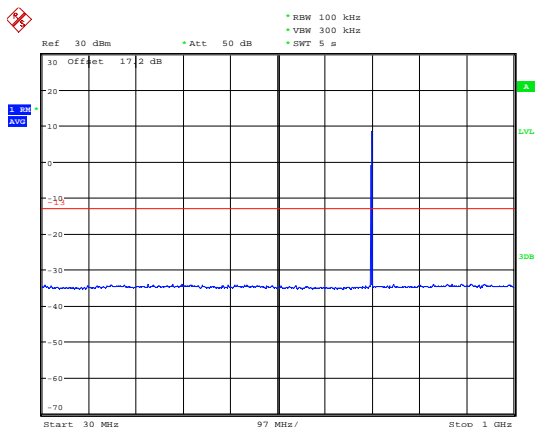

Date: 16.MAR.2020 19:00:53

### LTE Band 85 10MHz CH- High 1GHz ~9GHz

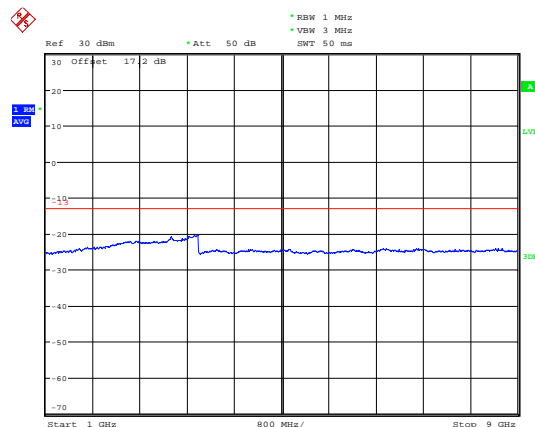

Date: 16.MAR.2020 19:10:29





## 5.7 Radiates Spurious Emission

### Ambient condition

Temperature	Relative humidity	Pressure
23°C ~25°C	45%~50%	101.5kPa

### Method of Measurement

- The testing follows FCC KDB 971168 D01 v03r01 Section 5.8 and ANSI C63.26 (2015).
- Below 1GHz: The EUT is placed on a turntable 0.8 meters above the ground in the chamber, 3 meter away from the antenna. The maximal emission value is acquired by adjusting the antenna height, polarisation and turntable azimuth. Normally, the height range of antenna is 1 m to 4 m, the azimuth range of turntable is 0° to 360°, and the receive antenna has two polarizations Vertical (V) and Horizontal (H). Above 1GHz: (Note: the FCC's permission to use 1.5m as an alternative per TCBC Conf call of Dec. 2, 2014.) The EUT is placed on a turntable 1.5 meters above the ground in the chamber, 3 meter away from the antenna. The maximal emission value is acquired by adjusting the antenna height, polarisation and turntable azimuth. Normally, the height range of antenna is 1 m to 4 m, the azimuth range of turntable is 0° to 360°, and the receive antenna has two polarizations Vertical (V) and Horizontal (H).
- A loop antenna, A log-periodic antenna or horn antenna shall be substituted in place of the EUT. The log-periodic antenna will be driven by a signal generator and the level will be adjusted till the same power value on the spectrum analyzer or receiver. The level of the spurious emissions can be calculated through the level of the signal generator, cable loss, the gain of the substitution antenna and the reading of the spectrum analyzer or receiver.
- The EUT is then put into continuously transmitting mode at its maximum power level during the test. Set Test Receiver or Spectrum RBW=200Hz,VBW=600Hz for 9kHz150kHz , RBW=10kHz, VBW=30kHz 150kHz-30MHz ,RBW=100kHz,VBW=300kHz for 30MHz to 1GHz and RBW=1MHz, VBW=3MHz for above 1GHz And the maximum value of the receiver should be recorded as (Pr).
- The EUT shall be replaced by a substitution antenna. In the chamber, an substitution antenna for the frequency band of interest is placed at the reference point of the chamber. An RF Signal source for the frequency band of interest is connected to the substitution antenna with a cable that has been constructed to not interfere with the radiation pattern of the antenna. A power (PMea) is applied to the input of the substitution antenna, and adjust the level of the signal generator output until the value of the receiver reach the previously recorded (Pr). The power of signal source (PMea) is recorded. The test should be performed by rotating the test item and adjusting the receiving antenna polarization.
- A amplifier should be connected to the Signal Source output port. And the cable should be connect between the Amplifier and the Substitution Antenna. The cable loss (Pcl) ,the Substitution Antenna Gain (Ga) and the Amplifier Gain (PAg) should be recorded after test.
- The measurement results are obtained as described below:  

$$\text{Power(EIRP)} = \text{PMea} - \text{PAg} - \text{Pcl} + \text{Ga}$$
 The measurement results are amend as described below:  

$$\text{Power(EIRP)} = \text{PMea} - \text{Pcl} + \text{Ga}$$
- This value is EIRP since the measurement is calibrated using an antenna of known gain (2.15 dBi) and known input power. ERP can be calculated from EIRP by subtracting the gain of the dipole, ERP

= EIRP-2.15dBi.

The modulation mode and RB allocation refer to section 5.1, using the maximum output power configuration.

**Test setup**

**9KHz ~ 30MHz**

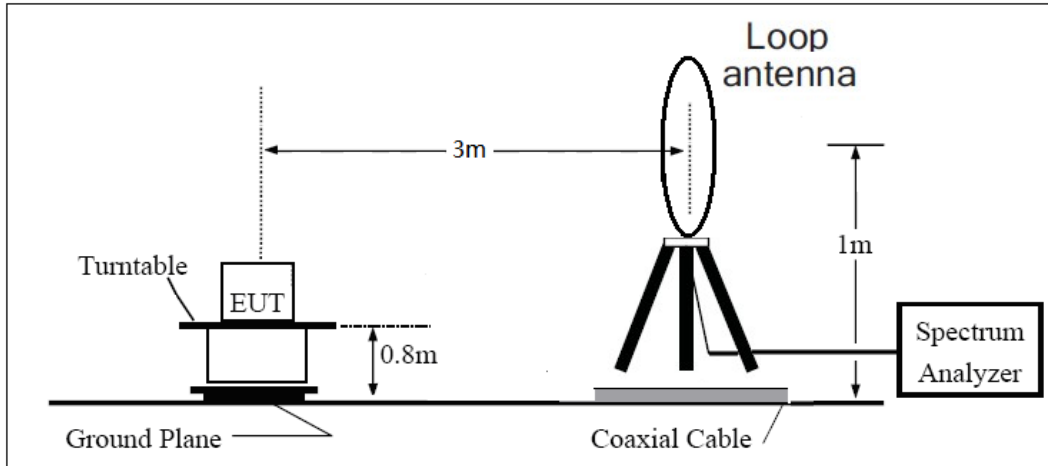

**30MHz ~ 1GHz**

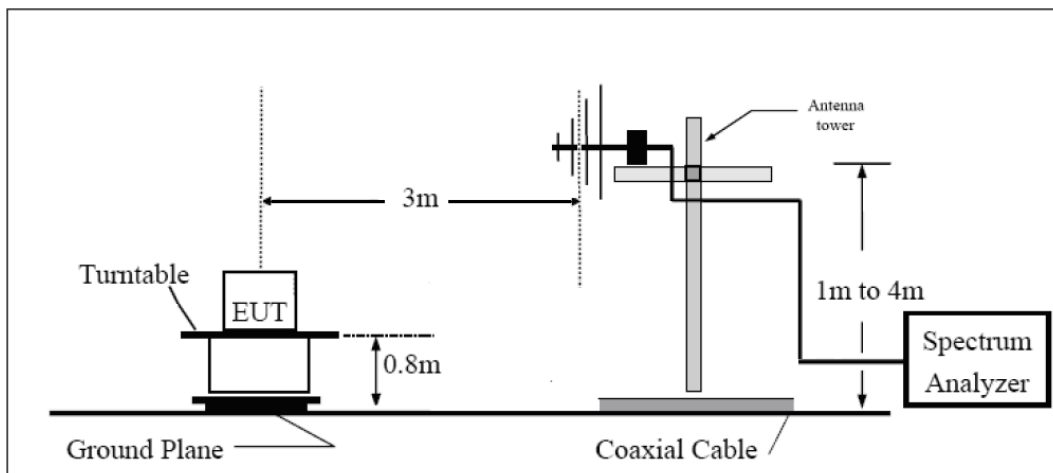

**Above 1GHz**

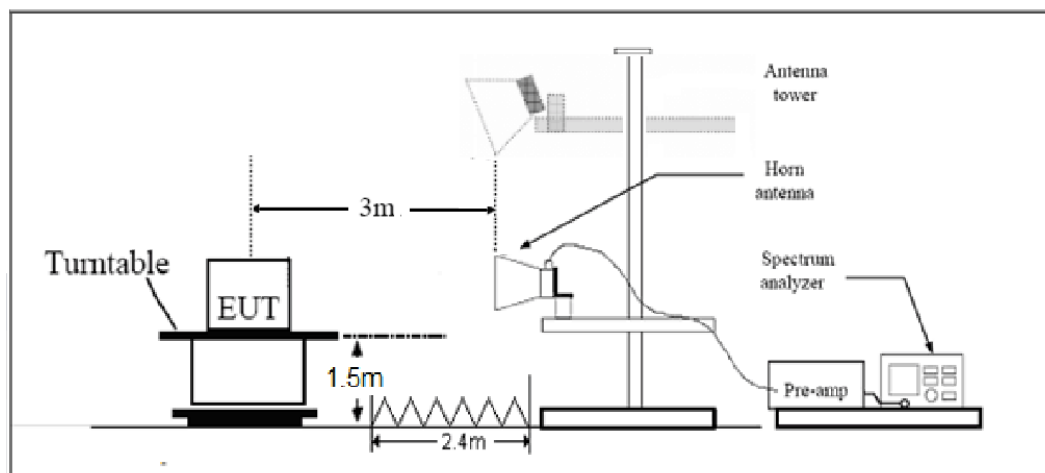

Note: Area side:2.4mX3.6m



**Limits**

Rule Part 27.53(h) specifies that “for operations in the 1695-1710 MHz, 1710-1755 MHz, 1755-1780 MHz, 1915-1920 MHz, 1995-2000 MHz, 2000-2020 MHz, 2110-2155 MHz, 2155-2180 MHz, and 2180-2200 bands, the power of any emission outside a licensee's frequency block shall be attenuated below the transmitter power (P) in watts by at least  $43 + 10 \log_{10} (P)$  dB.”

Rule Part 27.53 (g) For operations in the 600 MHz band and the 698-746 MHz band, the power of any emission outside a licensee's frequency band(s) of operation shall be attenuated below the transmitter power (P) within the licensed band(s) of operation, measured in watts, by at least  $43 + 10 \log (P)$  dB. Compliance with this provision is based on the use of measurement instrumentation employing a resolution bandwidth of 100 kilohertz or greater. However, in the 100 kilohertz bands immediately outside and adjacent to a licensee's frequency block, a resolution bandwidth of at least 30 kHz may be employed.

Rule Part 27.53(f) For operations in the 746-758 MHz, 775-788 MHz, and 805-806 MHz bands, emissions in the band 1559-1610 MHz shall be limited to  $-70$  dBW/MHz equivalent isotropically radiated power (EIRP) for wideband signals, and  $-80$  dBW EIRP for discrete emissions of less than 700 Hz bandwidth. For the purpose of equipment authorization, a transmitter shall be tested with an antenna that is representative of the type that will be used with the equipment in normal operation.

Part 27.53(h)/(g) Limit		-13 dBm
Part 27.53(f) Limit	Limit out of the band 1559-1610 MHz	-13 dBm
	Limit in the band 1559-1610 MHz	-40 dBm

**Measurement Uncertainty**

The assessed measurement uncertainty to ensure 95% confidence level for the normal distribution is with the coverage factor  $k = \pm 1.96$ ,  $U = \pm 3.55$  dB.

**Test Result**

Sweep the whole frequency band through the range from 9kHz to the 10th harmonic of the carrier, the emissions below the noise floor will not be recorded in the report.

LTE Band 4 QPSK 1.4MHz CH-Middle, RB 1

Harmonic	Frequency (MHz)	SG (dBm)	Cable Loss (dB)	Gain (dBi)	Antenna Polarization	EIRP Level (dBm)	Limit (dBm)	Margin (dB)	Azimuth (deg)
2	3464.3	-58.51	2.6	10.75	Horizontal	-50.36	-13.00	37.36	45
3	5197.5	-58.88	2.4	11.05	Horizontal	-50.23	-13.00	37.23	135
4	6930.0	-59.48	4.5	11.15	Horizontal	-52.83	-13.00	39.83	225
5	8662.5	-57.50	5.1	11.35	Horizontal	-51.25	-13.00	38.25	270
6	10395.0	-55.18	5.3	11.95	Horizontal	-48.53	-13.00	35.53	135
7	12127.5	-55.05	5.5	13.55	Horizontal	-47.00	-13.00	34.00	45
8	13860.0	-51.88	6.3	13.75	Horizontal	-44.43	-13.00	31.43	90
9	15592.5	-54.27	6.7	13.85	Horizontal	-47.12	-13.00	34.12	0
10	17325.0	-51.82	6.8	14.25	Horizontal	-44.37	-13.00	31.37	135

Note: 1.The other Spurious RF Radiated emissions level is no more than noise floor.

2. The worst emission was found in the antenna is Horizontal position.

LTE Band 4 QPSK 5MHz CH-Middle, RB 1

Harmonic	Frequency (MHz)	SG (dBm)	Cable Loss (dB)	Gain (dBi)	Antenna Polarization	EIRP Level (dBm)	Limit (dBm)	Margin (dB)	Azimuth (deg)
2	3460.5	-59.48	2.6	10.75	Horizontal	-51.33	-13.00	38.33	225
3	5191.5	-60.43	2.4	11.05	Horizontal	-51.78	-13.00	38.78	45
4	6930.0	-59.31	4.5	11.15	Horizontal	-52.66	-13.00	39.66	135
5	8662.5	-57.66	5.1	11.35	Horizontal	-51.41	-13.00	38.41	0
6	10395.0	-54.15	5.3	11.95	Horizontal	-47.50	-13.00	34.50	180
7	12127.5	-54.96	5.5	13.55	Horizontal	-46.91	-13.00	33.91	270
8	13860.0	-53.79	6.3	13.75	Horizontal	-46.34	-13.00	33.34	45
9	15592.5	-54.64	6.7	13.85	Horizontal	-47.49	-13.00	34.49	135
10	17325.0	-52.47	6.8	14.25	Horizontal	-45.02	-13.00	32.02	225

Note: 1.The other Spurious RF Radiated emissions level is no more than noise floor.

2. The worst emission was found in the antenna is Horizontal position.



## LTE Band 4 QPSK 20MHz CH-Middle, RB 1

Harmonic	Frequency (MHz)	SG (dBm)	Cable Loss (dB)	Gain (dBi)	Antenna Polarization	EIRP Level (dBm)	Limit (dBm)	Margin (dB)	Azimuth (deg)
2	3447.0	-57.91	2.6	10.75	Horizontal	-49.76	-13.00	36.76	45
3	5170.5	-60.14	2.4	11.05	Horizontal	-51.49	-13.00	38.49	90
4	6930.0	-59.46	4.5	11.15	Horizontal	-52.81	-13.00	39.81	135
5	8662.5	-57.39	5.1	11.35	Horizontal	-51.14	-13.00	38.14	225
6	10395.0	-55.80	5.3	11.95	Horizontal	-49.15	-13.00	36.15	45
7	12127.5	-55.01	5.5	13.55	Horizontal	-46.96	-13.00	33.96	90
8	13860.0	-53.16	6.3	13.75	Horizontal	-45.71	-13.00	32.71	135
9	15592.5	-55.18	6.7	13.85	Horizontal	-48.03	-13.00	35.03	225
10	17325.0	-51.69	6.8	14.25	Horizontal	-44.24	-13.00	31.24	45

Note: 1.The other Spurious RF Radiated emissions level is no more than noise floor.  
2. The worst emission was found in the antenna is Horizontal position.

## LTE Band 12 QPSK 1.4MHz CH-Middle, RB 1

Harmonic	Frequency (MHz)	SG (dBm)	Cable Loss (dB)	Gain (dBi)	Antenna Polarization	ERP Level (dBm)	Limit (dBm)	Margin (dB)	Azimuth (deg)
2	1415.00	-43.20	2.00	10.75	Horizontal	-36.60	-13.00	23.60	0
3	2122.50	-52.89	2.51	11.05	Horizontal	-46.50	-13.00	33.50	45
4	2830.00	-53.60	4.20	11.15	Horizontal	-48.80	-13.00	35.80	135
5	3537.50	-59.07	5.20	11.15	Horizontal	-55.27	-13.00	42.27	90
6	4245.00	-60.10	5.50	11.95	Horizontal	-55.80	-13.00	42.80	135
7	4952.50	-61.00	5.70	13.55	Horizontal	-55.30	-13.00	42.30	315
8	5660.00	-60.40	6.30	13.75	Horizontal	-55.10	-13.00	42.10	225
9	6367.50	-58.50	6.80	13.85	Horizontal	-53.60	-13.00	40.60	225
10	7075.00	-54.60	6.90	14.25	Horizontal	-49.40	-13.00	36.40	270

Note: 1.The other Spurious RF Radiated emissions level is no more than noise floor.  
2. The worst emission was found in the antenna is Horizontal position.





## LTE Band 12 QPSK 5MHz CH-Middle, RB 1

Harmonic	Frequency (MHz)	SG (dBm)	Cable Loss (dB)	Gain (dBi)	Antenna Polarization	ERP Level (dBm)	Limit (dBm)	Margin (dB)	Azimuth (deg)
2	1415.00	-43.73	2.00	10.75	Horizontal	-37.13	-13.00	24.13	180
3	2122.50	-52.59	2.51	11.05	Horizontal	-46.20	-13.00	33.20	225
4	2830.00	-53.10	4.20	11.15	Horizontal	-48.30	-13.00	35.30	315
5	3537.50	-59.30	5.20	11.15	Horizontal	-55.50	-13.00	42.50	225
6	4245.00	-60.70	5.50	11.95	Horizontal	-56.40	-13.00	43.40	180
7	4952.50	-60.60	5.70	13.55	Horizontal	-54.90	-13.00	41.90	45
8	5660.00	-58.80	6.30	13.75	Horizontal	-53.50	-13.00	40.50	0
9	6367.50	-58.30	6.80	13.85	Horizontal	-53.40	-13.00	40.40	90
10	7075.00	-53.60	6.90	14.25	Horizontal	-48.40	-13.00	35.40	135

Note: 1. The other Spurious RF Radiated emissions level is no more than noise floor.  
2. The worst emission was found in the antenna is Horizontal position.

## LTE Band 12 QPSK 10MHz CH-Middle, RB 1

Harmonic	Frequency (MHz)	SG (dBm)	Cable Loss (dB)	Gain (dBi)	Antenna Polarization	ERP Level (dBm)	Limit (dBm)	Margin (dB)	Azimuth (deg)
2	1415.00	-45.40	2.00	10.75	Horizontal	-38.80	-13.00	25.80	225
3	2122.50	-51.49	2.51	11.05	Horizontal	-45.10	-13.00	32.10	270
4	2830.00	-53.50	4.20	11.15	Horizontal	-48.70	-13.00	35.70	45
5	3537.50	-59.20	5.20	11.15	Horizontal	-55.40	-13.00	42.40	0
6	4245.00	-60.50	5.50	11.95	Horizontal	-56.20	-13.00	43.20	135
7	4952.50	-61.30	5.70	13.55	Horizontal	-55.60	-13.00	42.60	90
8	5660.00	-58.70	6.30	13.75	Horizontal	-53.40	-13.00	40.40	225
9	6367.50	-56.10	6.80	13.85	Horizontal	-51.20	-13.00	38.20	135
10	7075.00	-54.60	6.90	14.25	Horizontal	-49.40	-13.00	36.40	90

Note: 1. The other Spurious RF Radiated emissions level is no more than noise floor.  
2. The worst emission was found in the antenna is Horizontal position.



## LTE Band 13 QPSK 5MHz CH-Middle, RB 1

Harmonic	Frequency (MHz)	SG (dBm)	Cable Loss (dB)	Gain (dBi)	Antenna Polarization	EIRP Level (dBm)	Limit (dBm)	Margin (dB)	Azimuth (deg)
2	1564.0	-49.69	2.00	10.75	Horizontal	-43.09	-40.00	3.09	135
Harmonic	Frequency (MHz)	SG (dBm)	Cable Loss (dB)	Gain (dBi)	Antenna Polarization	ERP Level (dBm)	Limit (dBm)	Margin (dB)	Azimuth (deg)
3	2346.0	-41.56	2.51	11.05	Horizontal	-35.17	-13.00	22.17	0
4	3128.0	-51.40	4.20	11.15	Horizontal	-46.60	-13.00	33.60	180
5	3910.0	-58.90	5.20	11.15	Horizontal	-55.10	-13.00	42.10	315
6	4692.0	-59.00	5.50	11.95	Horizontal	-54.70	-13.00	41.70	225
7	5474.0	-59.10	5.70	13.55	Horizontal	-53.40	-13.00	40.40	90
8	6256.0	-58.40	6.30	13.75	Horizontal	-53.10	-13.00	40.10	0
9	7038.0	-54.87	6.80	13.85	Horizontal	-49.97	-13.00	36.97	45
10	7820.0	-55.10	6.90	14.25	Horizontal	-49.90	-13.00	36.90	135

Note: 1.The other Spurious RF Radiated emissions level is no more than noise floor.  
2. The worst emission was found in the antenna is Horizontal position.

## LTE Band 13 QPSK 10MHz CH-Middle, RB 1

Harmonic	Frequency (MHz)	SG (dBm)	Cable Loss (dB)	Gain (dBi)	Antenna Polarization	ERP Level (dBm)	Limit (dBm)	Margin (dB)	Azimuth (deg)
2	1555.3	-48.58	2.00	10.75	Horizontal	-41.98	-13.00	28.98	45
3	2346.0	-41.89	2.51	11.05	Horizontal	-35.50	-13.00	22.50	135
4	3128.0	-52.71	4.20	11.15	Horizontal	-47.91	-13.00	34.91	315
5	3910.0	-59.20	5.20	11.15	Horizontal	-55.40	-13.00	42.40	135
6	4692.0	-60.00	5.50	11.95	Horizontal	-55.70	-13.00	42.70	45
7	5474.0	-59.40	5.70	13.55	Horizontal	-53.70	-13.00	40.70	0
8	6256.0	-58.90	6.30	13.75	Horizontal	-53.60	-13.00	40.60	90
9	7038.0	-54.80	6.80	13.85	Horizontal	-49.90	-13.00	36.90	225
10	7820.0	-54.40	6.90	14.25	Horizontal	-49.20	-13.00	36.20	135

Note: 1.The other Spurious RF Radiated emissions level is no more than noise floor.  
2. The worst emission was found in the antenna is Horizontal position.





## LTE Band 66 QPSK 1.4MHz CH-Middle, RB 1

Harmonic	Frequency (MHz)	SG (dBm)	Cable Loss (dB)	Gain (dBi)	Antenna Polarization	EIRP Level (dBm)	Limit (dBm)	Margin (dB)	Azimuth (deg)
2	3472.1	-66.78	2.6	10.75	Horizontal	-58.63	-13.00	45.63	225
3	5208.4	-67.66	2.4	11.05	Horizontal	-59.01	-13.00	46.01	45
4	6980	-68.44	4.5	11.15	Horizontal	-61.79	-13.00	48.79	90
5	8725	-66.56	5.1	11.35	Horizontal	-60.31	-13.00	47.31	135
6	10470	-64.65	5.3	11.95	Horizontal	-58.00	-13.00	45.00	45
7	12215	-64.07	5.5	13.55	Horizontal	-56.02	-13.00	43.02	90
8	13960	-62.67	6.3	13.75	Horizontal	-55.22	-13.00	42.22	0
9	15705	-64.63	6.7	13.85	Horizontal	-57.48	-13.00	44.48	225
10	17450	-62.36	6.8	14.25	Horizontal	-54.91	-13.00	41.91	45

Note: 1.The other Spurious RF Radiated emissions level is no more than noise floor.

2. The worst emission was found in the antenna is Horizontal position.

## LTE Band 66 QPSK 5MHz CH-Middle, RB 1

Harmonic	Frequency (MHz)	SG (dBm)	Cable Loss (dB)	Gain (dBi)	Antenna Polarization	EIRP Level (dBm)	Limit (dBm)	Margin (dB)	Azimuth (deg)
2	3472.1	-66.98	2.6	10.75	Horizontal	-58.83	-13.00	45.83	90
3	5208.4	-67.13	2.4	11.05	Horizontal	-58.48	-13.00	45.48	135
4	6980	-68.69	4.5	11.15	Horizontal	-62.04	-13.00	49.04	45
5	8725	-66.67	5.1	11.35	Horizontal	-60.42	-13.00	47.42	90
6	10470	-64.28	5.3	11.95	Horizontal	-57.63	-13.00	44.63	225
7	12215	-63.64	5.5	13.55	Horizontal	-55.59	-13.00	42.59	45
8	13960	-62.85	6.3	13.75	Horizontal	-55.40	-13.00	42.40	90
9	15705	-64.73	6.7	13.85	Horizontal	-57.58	-13.00	44.58	135
10	17450	-61.53	6.8	14.25	Horizontal	-54.08	-13.00	41.08	0

Note: 1.The other Spurious RF Radiated emissions level is no more than noise floor.

2. The worst emission was found in the antenna is Horizontal position.



## LTE Band 66 QPSK 20MHz CH-Middle, RB 1

Harmonic	Frequency (MHz)	SG (dBm)	Cable Loss (dB)	Gain (dBi)	Antenna Polarization	EIRP Level (dBm)	Limit (dBm)	Margin (dB)	Azimuth (deg)
2	3472.1	-67.33	2.6	10.75	Horizontal	-59.18	-13.00	46.18	45
3	5208.4	-68.41	2.4	11.05	Horizontal	-59.76	-13.00	46.76	225
4	6980	-68.54	4.5	11.15	Horizontal	-61.89	-13.00	48.89	270
5	8725	-66.24	5.1	11.35	Horizontal	-59.99	-13.00	46.99	45
6	10470	-63.62	5.3	11.95	Horizontal	-56.97	-13.00	43.97	90
7	12215	-64.15	5.5	13.55	Horizontal	-56.10	-13.00	43.10	135
8	13960	-62.96	6.3	13.75	Horizontal	-55.51	-13.00	42.51	225
9	15705	-64.22	6.7	13.85	Horizontal	-57.07	-13.00	44.07	90
10	17450	-62.40	6.8	14.25	Horizontal	-54.95	-13.00	41.95	0

Note: 1.The other Spurious RF Radiated emissions level is no more than noise floor.

2. The worst emission was found in the antenna is Horizontal position.

## LTE Band 85 QPSK 5MHz CH-Middle, RB 1

Harmonic	Frequency (MHz)	SG (dBm)	Cable Loss (dB)	Gain (dBi)	Antenna Polarization	ERP Level (dBm)	Limit (dBm)	Margin (dB)	Azimuth (deg)
2	1414.0	-71.25	2.00	10.75	Horizontal	-64.65	-13.00	51.65	45
3	2121.0	-67.31	2.51	11.05	Horizontal	-60.92	-13.00	47.92	135
4	2828.0	-63.69	4.20	11.15	Horizontal	-58.89	-13.00	45.89	270
5	3537.50	-61.65	5.20	11.15	Horizontal	-57.85	-13.00	44.85	0
6	4245.00	-61.49	5.50	11.95	Horizontal	-57.19	-13.00	44.19	225
7	4952.50	-62.38	5.70	13.55	Horizontal	-56.68	-13.00	43.68	315
8	5660.00	-60.78	6.30	13.75	Horizontal	-55.48	-13.00	42.48	180
9	6367.50	-59.29	6.80	13.85	Horizontal	-54.39	-13.00	41.39	45
10	7075.00	-56.36	6.90	14.25	Horizontal	-51.16	-13.00	38.16	135

Note: 1.The other Spurious RF Radiated emissions level is no more than noise floor.

2. The worst emission was found in the antenna is Horizontal position.





## LTE Band 85 QPSK 10MHz CH-Middle, RB 1

Harmonic	Frequency (MHz)	SG (dBm)	Cable Loss (dB)	Gain (dBi)	Antenna Polarization	ERP Level (dBm)	Limit (dBm)	Margin (dB)	Azimuth (deg)
2	1415.00	-70.49	2.00	10.75	Horizontal	-63.89	-13.00	50.89	180
3	2122.50	-68.28	2.51	11.05	Horizontal	-61.89	-13.00	48.89	315
4	2830.00	-64.59	4.20	11.15	Horizontal	-59.79	-13.00	46.79	90
5	3537.50	-60.85	5.20	11.15	Horizontal	-57.05	-13.00	44.05	45
6	4245.00	-60.34	5.50	11.95	Horizontal	-56.04	-13.00	43.04	180
7	4952.50	-61.30	5.70	13.55	Horizontal	-55.60	-13.00	42.60	270
8	5660.00	-61.33	6.30	13.75	Horizontal	-56.03	-13.00	43.03	90
9	6367.50	-58.71	6.80	13.85	Horizontal	-53.81	-13.00	40.81	225
10	7075.00	-55.74	6.90	14.25	Horizontal	-50.54	-13.00	37.54	270

Note: 1. The other Spurious RF Radiated emissions level is no more than noise floor.

2. The worst emission was found in the antenna is Horizontal position.



## 6 Main Test Instruments

Name	Manufacturer	Type	Serial Number	Calibration Date	Expiration Date
Base Station Simulator	R&S	CMW500	113824	2019-05-19	2020-05-18
Power Splitter	Hua Xiang	SHX-GF2-2-13	10120101	/	/
Spectrum Analyzer	Key sight	N9010A	MY50210259	2019-05-19	2020-05-18
Signal Analyzer	R&S	FSV40	15195-01-00	2019-05-19	2020-05-18
Loop Antenna	SCHWARZBECK	FMZB1519	1519-047	2017-09-26	2020-09-25
Trilog Antenna	SCHWARZBECK	VUBL 9163	9163-201	2017-11-18	2020-11-17
Horn Antenna	R&S	HF907	100126	2018-07-07	2020-07-06
Horn Antenna	ETS-Lindgren	3160-09	00102643	2018-06-20	2020-06-19
Signal generator	R&S	SMB 100A	102594	2019-05-19	2020-05-18
Climatic Chamber	ESPEC	SU-242	93000506	2017-12-17	2020-12-16
Preamplifier	R&S	SCU18	102327	2019-05-19	2020-05-18
MOB COMMS DC SUPPLY	Keysight	66319D	MY43004105	2019-05-19	2020-05-18
RF Cable	Agilent	SMA 15cm	0001	2019-12-13	2020-6-12
Software	R&S	EMC32	9.26.0	/	/

\*\*\*\*\*END OF REPORT \*\*\*\*\*