



RF TEST REPORT

Applicant Quectel Wireless Solutions Co., Ltd
FCC ID XMR201912BG77
Product LTE Cat M1 & Cat NB2 Module
Brand Quectel
Marketing Quectel BG77
Model BG77
Report No. R1909A0576-R3
Issue Date March 17, 2020

TA Technology (Shanghai) Co., Ltd. tested the above equipment in accordance with the requirements in **FCC CFR47 Part 2 (2019)/ FCC CFR47 Part 27C (2019)**. The test results show that the equipment tested is capable of demonstrating compliance with the requirements as documented in this report.

Performed by: Peng Tao

Approved by: Kai Xu

TA Technology (Shanghai) Co., Ltd.

No. 145, Jintang Rd, Tangzhen Industry Park, Pudong Shanghai, China

TEL: +86-021-50791141/2/3

FAX: +86-021-50791141/2/3-8000



TABLE OF CONTENT

1	Test Laboratory	4
1.1	Notes of the Test Report	4
1.2.	Test facility	4
1.3	Testing Location	4
2	General Description of Equipment under Test	5
2.1	Applicant and Manufacturer Information	5
2.2	General information	5
3	Applied Standards	7
4	Test Configuration	8
5	Test Case Results	10
5.1	RF Power Output and Effective Isotropic Radiated Power	10
5.2	Occupied Bandwidth	15
5.3	Band Edge Compliance	36
5.4	Peak-to-Average Power Ratio (PAPR)	54
5.5	Frequency Stability	56
5.6	Spurious Emissions at Antenna Terminals	64
5.7	Radiates Spurious Emission	72
6	Main Test Instruments	84



Summary of Measurement Results

Number	Test Case	Clause in FCC rules	Verdict
1	RF Power Output and Effective Isotropic Radiated Power	2.1046 27.50(d)(4) /27.50(b)(10) /27.50(c)(10)	PASS
2	Occupied Bandwidth	2.1049	PASS
3	Band Edge Compliance	27.53(h) /27.53(g) /27.53(f) /27.53(c)	PASS
4	Peak-to-Average Power Ratio	27.50(d)/KDB971168 D01(5.7)	PASS
5	Frequency Stability	2.1055 / 27.54	PASS
6	Spurious Emissions at Antenna Terminals	2.1051 /27.53(h) /27.53(g) /27.53(f) /27.53(c)	PASS
7	Radiates Spurious Emission	2.1053 /27.53(h) /27.53(g) /27.53(m) /27.53(f) /27.53(c)	PASS

Date of Testing: November 28, 2019~ February 20, 2020

Note: PASS: The EUT complies with the essential requirements in the standard.

FAIL: The EUT does not comply with the essential requirements in the standard.

All indications of Pass/Fail in this report are opinions expressed by TA Technology (Shanghai) Co., Ltd. based on interpretations and/or observations of test results. Measurement Uncertainties were not taken into account and are published for informational purposes only.

1 Test Laboratory

1.1 Notes of the Test Report

This report shall not be reproduced in full or partial, without the written approval of **TA technology (shanghai) co., Ltd.** The results documented in this report apply only to the tested sample, under the conditions and modes of operation as described herein. Measurement Uncertainties were not taken into account and are published for informational purposes only. This report is written to support regulatory compliance of the applicable standards stated above.

1.2. Test facility

FCC (Designation number: CN1179, Test Firm Registration Number: 446626)

TA Technology (Shanghai) Co., Ltd. has been listed on the US Federal Communications Commission list of test facilities recognized to perform electromagnetic emissions measurements.

A2LA(Certificate Number: 3857.01)

TA Technology (Shanghai) Co., Ltd. has been listed by American Association for Laboratory Accreditation to perform electromagnetic emission measurement.

1.3 Testing Location

Company: TA Technology (Shanghai) Co., Ltd.
Address: No.145, Jintang Rd, Tangzhen Industry Park, Pudong Shanghai, China
City: Shanghai
Post code: 201201
Country: P. R. China
Contact: Xu Kai
Telephone: +86-021-50791141/2/3
Fax: +86-021-50791141/2/3-8000
Website: <http://www.ta-shanghai.com>
E-mail: xukai@ta-shanghai.com

2 General Description of Equipment under Test

2.1 Applicant and Manufacturer Information

Applicant	Quectel Wireless Solutions Co., Ltd
Applicant address	Building 5, Shanghai Business Park Phase III (Area B), No.1016 Tianlin Road, Minhang District, Shanghai, China 200233
Manufacturer	Quectel Wireless Solutions Co., Ltd
Manufacturer address	Building 5, Shanghai Business Park Phase III (Area B), No.1016 Tianlin Road, Minhang District, Shanghai, China 200233

2.2 General Information

EUT Description			
Model	BG77		
IMEI	866349040044541		
Hardware Version	R1.2		
Software Version	BG77LAR02A02		
Power Supply	External power supply		
Antenna Type	The EUT don't have standard Antenna, The Antenna used for testing in this report is the after-market accessory (Dipole Antenna)		
Test Mode(s)	NB-IOT Band 4/12/13/66/71/85;		
Test Modulation	BPSK, QPSK		
Category	NB2		
Deployment	stand-alone		
Sub-carrier spacing	3.75KHz, 15KHz		
Ntones	single, multi-tone		
Maximum E.R.P.	NB-IOT Band 12:	23.35dBm	
	NB-IOT Band 13:	23.58dBm	
	NB-IOT Band 71	20.97dBm	
	NB-IOT Band 85	23.36dBm	
Maximum E.I.R.P	NB-IOT Band 4	23.23dBm	
	NB-IOT Band 66	23.08dBm	
Rated Power Supply Voltage:	3.3V		
Extreme Voltage	Minimum: 2.6V Maximum: 4.8V		
Extreme Temperature	Lowest: -40°C Highest: +85°C		
Operating Frequency Range(s)	Mode	Tx (MHz)	Rx (MHz)
	NB-IOT Band 4	1710 ~1755	2110~2155
	NB-IOT Band 12	699 ~ 716	729 ~ 746



	NB-IOT Band 13	777 ~ 787	746 ~ 756
	NB-IOT Band 66	1710 ~ 1780	2110 ~ 2180
	NB-IOT Band 71	663 ~ 698	617 ~ 652
	NB-IOT Band 85	698~716	728~746

Note: 1. The EUT is sent from the applicant to TA and the information of the EUT is declared by the applicant.

Antenna Gain:

Band	CH-Low(dBi)	CH-Middle(dBi)	CH-High(dBi)
NB-IOT Band 4	1.94	2.00	1.57
NB-IOT Band 12	1.66	3.26	3.95
NB-IOT Band 13	4.45	4.45	3.63
NB-IOT Band 66	1.94	1.57	0.97
NB-IOT Band 71	1.66	1.66	1.66
NB-IOT Band 85	1.66	3.26	3.95



3 Applied Standards

According to the specifications of the manufacturer, it must comply with the requirements of the following standards:

Test standards:

FCC CFR47 Part 27C(2019)

ANSI C63.26 (2015)

Reference standard:

FCC CFR47 Part 2 (2019)

KDB 971168 D01 Power Meas License Digital Systems v03r01

4 Test Configuration

Radiated measurements are performed by rotating the EUT in three different orthogonal test planes. EUT stand-up position (Z axis), lie-down position (X, Y axis). Receiver antenna polarization (horizontal and vertical), the worst emission was found in position (X axis, horizontal polarization) and the worst case was recorded.

All modes as Subcarrier Spacing, modulations, Channel were investigated. Subsequently, only the worst case emissions are reported.

The following testing in NB-IOT is set based on the maximum RF Output Power.

The following testing in different mode is set to detail in the following table:

Test modes are chosen to be reported as the worst case configuration below for NB-IOT Band 4/12/13/66/71/85:

Test items	Mode	Deployment mode	Subcarrier Spacing (kHz)		Modulation		Test Channel		
		Stand-alone	3.75	15	BPSK	QPSK	L	M	H
RF Power Output and Effective Isotropic Radiated Power	NB-IOT B4	O	O	O	O	O	O	O	O
	NB-IOT B12	O	O	O	O	O	O	O	O
	NB-IOT B13	O	O	O	O	O	O	O	O
	NB-IOT B66	O	O	O	O	O	O	O	O
	NB-IOT B71	O	O	O	O	O	O	O	O
	NB-IOT B85	O	O	O	O	O	O	O	O
Occupied Bandwidth	NB-IOT B4	O	O	O	O	O	O	O	O
	NB-IOT B12	O	O	O	O	O	O	O	O
	NB-IOT B13	O	O	O	O	O	O	O	O
	NB-IOT B66	O	O	O	O	O	O	O	O
	NB-IOT B71	O	O	O	O	O	O	O	O
	NB-IOT B85	O	O	O	O	O	O	O	O
Band Edge Compliance	NB-IOT B4	O	O	O	O	O	O	-	O
	NB-IOT B12	O	O	O	O	O	O	-	O
	NB-IOT B13	O	O	O	O	O	O	-	O
	NB-IOT B66	O	O	O	O	O	O	-	O
	NB-IOT B71	O	O	O	O	O	O	-	O
	NB-IOT B85	O	O	O	O	O	O	-	O
Peak-to-Average Power Ratio	NB-IOT B4	O	O	O	O	O	-	O	-
	NB-IOT B12	O	O	O	O	O	-	O	-
	NB-IOT B13	O	O	O	O	O	-	O	-
	NB-IOT B66	O	O	O	O	O	-	O	-
	NB-IOT B71	O	O	O	O	O	-	O	-



	NB-IOT B85	O	O	O	O	O	-	O	-
Frequency Stability	NB-IOT B4	O	O	O	O	O	O	O	O
	NB-IOT B12	O	O	O	O	O	O	O	O
	NB-IOT B13	O	O	O	O	O	O	O	O
	NB-IOT B66	O	O	O	O	O	O	O	O
	NB-IOT B71	O	O	O	O	O	O	O	O
	NB-IOT B85	O	O	O	O	O	O	O	O
	Conducted Spurious Emissions	NB-IOT B4	O	-	O	-	O	O	O
NB-IOT B12		O	-	O	-	O	O	O	O
NB-IOT B13		O	-	O	-	O	O	O	O
NB-IOT B66		O	-	O	-	O	O	O	O
NB-IOT B71		O	-	O	-	O	O	O	O
NB-IOT B85		O	-	O	-	O	O	O	O
Radiates Spurious Emission	NB-IOT B4	O	-	O	O	-	O	O	O
	NB-IOT B12	O	-	O	O	-	O	O	O
	NB-IOT B13	O	-	O	O	-	O	O	O
	NB-IOT B66	O	-	O	O	-	O	O	O
	NB-IOT B71	O	-	O	O	-	O	O	O
	NB-IOT B85	O	-	O	O	-	O	O	O
Note									
1. The mark "O" means that this configuration is chosen for testing.									
2. The mark "-" means that this configuration is not testing.									

5 Test Case Results

5.1 RF Power Output and Effective Isotropic Radiated Power

Ambient condition

Temperature	Relative humidity	Pressure
23°C ~25°C	45%~50%	101.5kPa

Methods of Measurement

During the process of the testing, The EUT is controlled by the Base Station Simulator to ensure max power transmission and proper modulation.

1. The testing follows FCC KDB 971168D01v03r01 Section 5.8 and ANSI C63.26 (2015).

a) Connect the equipment as illustrated. Mount the equipment with the manufacturer specified antenna in a vertical orientation on a manufacturer specified mounting surface located on a non-conducting rotating platform of a RF anechoic chamber (preferred) or a standard radiation site.

b) Key the transmitter, then rotate the EUT 360° azimuthally and record spectrum analyzer power level (LVL) measurements at angular increments that are sufficiently small to permit resolution of all peaks. If a standard radiation test site is used, raise and lower the test antenna to obtain a maximum reading at each angular increment. (Note: several batteries may be needed to offset the effect of battery voltage droop, which should not exceed 5% of the manufactured specified battery voltage during transmission).

c) Replace the transmitter under test with a vertically polarized half-wavedipole (or an antenna whose gain is known relative to an ideal half-wavedipole). The center of the antenna should be at the same location as the center of the antenna under test.

d) Connect the antenna to a signal generator with a known output power and record the path loss (in dB) as LOSS. If a standard radiation test site is used, raise and lower the test antenna to obtain a maximum reading. $LOSS = \text{Generator Output Power (dBm)} - \text{Analyzer reading (dBm)}$

e) Determine the effective radiated output power at each angular position from the readings in steps b) and d) using the following equation: $ERP \text{ (dBm)} = \text{LVL (dBm)} + \text{LOSS (dB)}$

f) The maximum ERP is the maximum value determined in the preceding step.

g) When calculating ERP, in addition to knowing the antenna radiation and matching characteristics, it is necessary to know the loss values of all elements (e.g. transmission line attenuation, mismatches, filters, combiners) interposed between the point where transmitter output power is measured, and the point where power is applied to the antenna. ERP can then be calculated as follows:

$$EIRP \text{ (dBm)} = \text{Output Power (dBm)} - \text{Losses (dB)} + \text{Antenna Gain (dBi)}$$

where: dBd refers to gain relative to an ideal dipole.

$$EIRP \text{ (dBm)} = ERP \text{ (dBm)} + 2.15 \text{ (dB.)}$$

The RB allocation refers to section 5.1, using the maximum output power configuration.

Test Setup

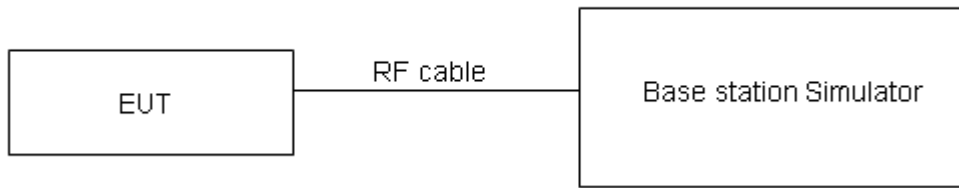

The loss between RF output port of the EUT and the input port of the tester has been taken into consideration.

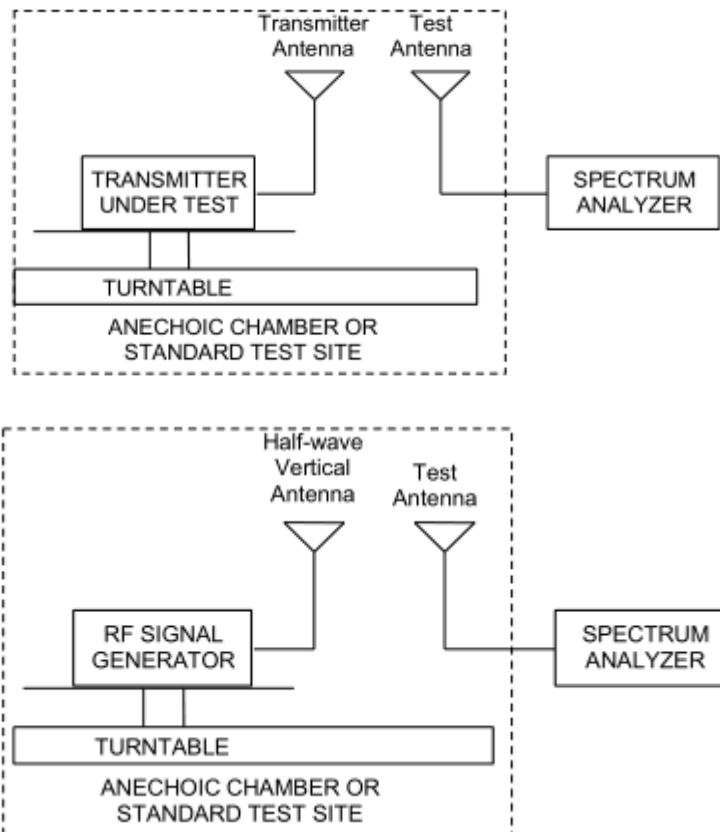

Note: Area side:2.4mX3.6m

The radiated emission was measured in the following position: EUT stand-up position (Z axis), lie-down position (X, Y axis). The worst emission was found in stand-up position (Z axis) and the worst case was recorded.

Limits

No specific RF power output requirements in part 2.1046.

Rule Part 27.50(b) (10) specifies that “Portable stations (hand-held devices) transmitting in the 746-757 MHz, 776-788 MHz, and 805-806 MHz bands are limited to 3 watts ERP”

Rule Part 27.50(c) (10) specifies that “Portable stations (hand-held devices) in the 600 MHz uplink band and the 698-746 MHz band, and fixed and mobile stations in the 600 MHz uplink band are limited to 3 watts ERP”



Rule Part 27.50(d) (4) specifies that “Fixed, mobile and portable (hand-held) stations operating in the 1710–1755 MHz band are limited to 1 watt EIRP”

Rule Part 27.50(h) (2) specifies that “Mobile and other user stations. Mobile stations are limited to 2.0 watts EIRP. All user stations are limited to 2.0 watts transmitter output power.”

Rule Part 27.50(a) (3) specifies that “(i) For mobile and portable stations transmitting in the 2305-2315 MHz band or the 2350-2360 MHz band, the average EIRP must not exceed 50 milliwatts within any 1 megahertz of authorized bandwidth, except that for mobile and portable stations compliant with 3GPP LTE standards or another advanced mobile broadband protocol that avoids concentrating energy at the edge of the operating band the average EIRP must not exceed 250 milliwatts within any 5 megahertz of authorized bandwidth but may exceed 50 milliwatts within any 1 megahertz of authorized bandwidth. ”

Part 27.50(b)(10)Limit	$\leq 3 \text{ W}$ (34.77 dBm)
Part 27.50(c)(10)Limit	$\leq 3 \text{ W}$ (34.77 dBm)
Part 27.50(d)(4)Limit	$\leq 1 \text{ W}$ (30 dBm)

Measurement Uncertainty

The assessed measurement uncertainty to ensure 95% confidence level for the normal distribution is with the coverage factor $k = 2$, $U=0.4 \text{ dB}$ for RF power output, $k = 2$, $U= 1.19 \text{ dB}$ for ERP/EIRP.



Test Results

Mode	Modulation	Sub-carrier spacing (KHz)	Ntones	Conducted Power (dBm) for low/mid/high channel			EIRP(dBm)		
				19951/1710.2	20175/1732.5	20399/1754.8	19951/1710.2	20175/1732.5	20399/1754.8
Band 4 Standalone	BPSK	3.75	1@0	21.16	21.16	21.60	23.10	23.16	23.17
			1@47	21.06	21.05	20.62	23.00	23.05	22.19
		15	1@0	21.22	21.23	21.49	23.16	23.23	23.06
			1@11	21.16	21.17	20.65	23.10	23.17	22.22
	QPSK	3.75	1@0	21.08	21.09	21.57	23.02	23.09	23.14
			1@47	21.04	21.04	20.57	22.98	23.04	22.14
		15	1@0	21.14	21.13	21.44	23.08	23.13	23.01
			1@11	21.18	21.20	20.64	23.12	23.20	22.21
		15	12@0	19.47	20.24	19.92	21.41	22.24	21.49
Mode	Modulation	Sub-carrier spacing (KHz)	Ntones	Conducted Power (dBm) for low/mid/high channel			ERP(dBm)		
				23011/699.2	23095/707.5	23179/715.8	23011/699.2	23095/707.5	23179/715.8
Band 12 Standalone	BPSK	3.75	1@0	21.13	20.75	21.41	20.64	21.86	23.21
			1@47	21.02	20.69	21.36	20.53	21.80	23.16
		15	1@0	21.07	20.81	21.55	20.58	21.92	23.35
			1@11	21.03	20.75	21.51	20.54	21.86	23.31
	QPSK	3.75	1@0	21.07	20.74	21.34	20.58	21.85	23.14
			1@47	21.13	20.66	21.32	20.64	21.77	23.12
		15	1@0	21.14	20.84	21.44	20.65	21.95	23.24
			1@11	21.16	20.76	21.47	20.67	21.87	23.27
		15	12@0	20.09	19.77	20.51	19.60	20.88	22.31
Mode	Modulation	Sub-carrier spacing (KHz)	Ntones	Conducted Power (dBm) for low/mid/high channel			ERP(dBm)		
				23181/777.2	23230/782	23279/786.8	23181/777.2	23230/782	23279/786.8
Band 13 Standalone	BPSK	3.75	1@0	21.20	21.23	21.11	23.50	23.53	22.59
			1@47	21.12	21.20	21.01	23.42	23.50	22.49
		15	1@0	21.27	21.17	21.15	23.57	23.47	22.63
			1@11	21.24	21.15	21.03	23.54	23.45	22.51
	QPSK	3.75	1@0	21.17	21.24	21.07	23.47	23.54	22.55
			1@47	21.16	21.13	21.01	23.46	23.43	22.49
		15	1@0	21.28	21.27	21.16	23.58	23.57	22.64
			1@11	21.19	21.14	21.07	23.49	23.44	22.55
		15	12@0	19.97	19.95	19.97	22.27	22.25	21.45
Mode	Modulation	Sub-carrier spacing (KHz)	Ntones	Conducted Power (dBm) for low/mid/high channel			EIRP(dBm)		
				131973/	132322/	132671/	131973/	132322/	132671/



				1710.2	1745	1779.8	1710.2	1745	1779.8
Band 66 Standalone	BPSK	3.75	1@0	21.11	21.18	21.36	23.05	22.75	22.33
			1@47	21.04	21.06	20.42	22.98	22.63	21.39
		15	1@0	21.10	21.20	21.63	23.04	22.77	22.60
			1@11	21.03	21.17	20.08	22.97	22.74	21.05
	QPSK	3.75	1@0	21.07	21.12	21.47	23.01	22.69	22.44
			1@47	21.06	21.05	20.39	23.00	22.62	21.36
		15	1@0	21.08	21.21	21.53	23.02	22.78	22.50
			1@11	21.14	21.12	20.12	23.08	22.69	21.09
		15	12@0	19.33	21.35	19.55	21.27	22.92	20.52
		Mode	Modulation	Sub-carrier spacing (KHz)	Ntones	Conducted Power (dBm) for low/mid/high channel			ERP(dBm)
133123/663.2	133297/680.5					133471/697.8	133123/663.2	13329/680.5	133471/697.8
Band 71 Standalone	BPSK	3.75	1@0	21.41	21.30	21.35	20.92	20.81	20.86
			1@47	21.32	21.32	21.24	20.83	20.83	20.75
		15	1@0	21.35	21.35	21.38	20.86	20.86	20.89
			1@11	21.38	21.28	21.28	20.89	20.79	20.79
	QPSK	3.75	1@0	21.39	21.39	21.45	20.90	20.90	20.96
			1@47	21.31	21.33	21.40	20.82	20.84	20.91
		15	1@0	21.46	21.40	21.33	20.97	20.91	20.84
			1@11	21.42	21.37	21.30	20.93	20.88	20.81
		15	12@0	19.70	19.91	19.82	19.21	19.42	19.33
		Mode	Modulation	Sub-carrier spacing (KHz)	Ntones	Conducted Power (dBm) for low/mid/high channel			ERP(dBm)
134003/698.2	134081/705.9					134181/715.8	134003/698.2	134081/705.9	134181/715.8
Band 85 Standalone	BPSK	3.75	1@0	21.33	20.99	21.31	20.84	22.10	23.11
			1@47	21.29	20.87	21.34	20.80	21.98	23.14
		15	1@0	21.41	20.95	21.55	20.92	22.06	23.35
			1@11	21.38	20.90	21.47	20.89	22.01	23.27
	QPSK	3.75	1@0	21.47	20.94	21.41	20.98	22.05	23.21
			1@47	21.44	20.91	21.32	20.95	22.02	23.12
		15	1@0	21.51	21.01	21.49	21.02	22.12	23.29
			1@11	21.48	20.93	21.56	20.99	22.04	23.36
		15	12@0	20.20	19.74	20.24	19.71	20.85	22.04

5.2 Occupied Bandwidth

Ambient condition

Temperature	Relative humidity	Pressure
23°C ~25°C	45%~50%	101.5kPa

Method of Measurement

The EUT was connected to Spectrum Analyzer and Base Station Simulator via power Splitter. The occupied bandwidth is measured using spectrum analyzer.

RBW is set to 2kHz, VBW is set to 6.2kHz for NB-IOT Band 4/12/13/66/71/85.

99% power and -26dBc occupied bandwidths are recorded. Spectrum analyzer plots are included on the following pages.

Test Setup

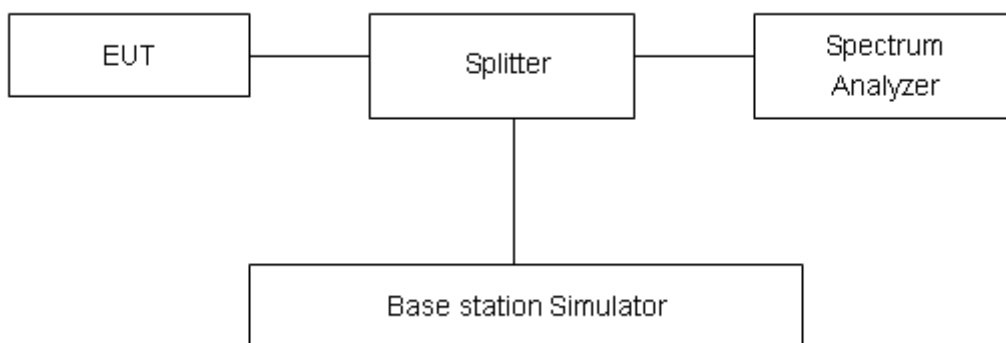

Limits

No specific occupied bandwidth requirements in part 2.1049.

Measurement Uncertainty

The assessed measurement uncertainty to ensure 95% confidence level for the normal distribution is with the coverage factor $k = 2, U = 624\text{Hz}$.



Test Result

Mode	Modulation	Sub-carrier spacing (KHz)	Ntones	Bandwidth(KHz) for low/middle/high channel					
				19951/1710.2		20175/1732.5		20399/1754.8	
				99% Power	-26dBc	99% Power	-26dBc	99% Power	-26dBc
Band 4 Standalone	BPSK	3.75	1@0	64.86	40.82	61.14	41.61	61.50	41.73
	QPSK	3.75	1@0	68.06	40.22	68.63	40.17	69.53	40.34
	BPSK	15	1@0	128.10	105.80	131.33	129.40	127.48	103.10
	QPSK	15	1@0	117.52	116.10	121.16	118.00	120.77	116.10
	QPSK	15	12@0	182.59	236.00	183.12	236.30	184.91	256.50
Mode	Modulation	Sub-carrier spacing (KHz)	Ntones	Bandwidth(KHz) for low/middle/high channel					
				23012/699.2		23095/707.5		23178/715.8	
				99% Power	-26dBc	99% Power	-26dBc	99% Power	-26dBc
Band 12 Standalone	BPSK	3.75	1@0	60.89	41.69	64.90	44.46	60.77	41.51
	QPSK	3.75	1@0	67.03	40.60	67.64	40.82	70.65	41.13
	BPSK	15	1@0	128.58	117.70	127.65	116.30	119.96	101.00
	QPSK	15	1@0	121.15	117.00	118.46	114.80	125.31	130.10
	QPSK	15	12@0	183.46	239.90	183.86	241.00	183.81	251.30
Mode	Modulation	Sub-carrier spacing (KHz)	Ntones	Bandwidth(KHz) for low/middle/high channel					
				23182/777.2		23230/782		23278/786.8	
				99% Power	-26dBc	99% Power	-26dBc	99% Power	-26dBc
Band 13 Standalone	BPSK	3.75	1@0	66.51	40.36	62.95	41.14	60.50	40.80
	QPSK	3.75	1@0	68.20	40.26	68.02	40.20	66.27	39.55
	BPSK	15	1@0	121.04	104.70	126.53	103.70	126.06	113.50
	QPSK	15	1@0	118.84	101.60	116.61	114.80	116.96	117.40
	QPSK	15	12@0	184.84	252.60	183.69	239.30	182.72	248.10
Mode	Modulation	Sub-carrier spacing (KHz)	Ntones	Bandwidth(KHz) for low/middle/high channel					
				131973/1710.2		132322/1745		132671/1779.8	
				99% Power	-26dBc	99% Power	-26dBc	99% Power	-26dBc
Band 66 Standalone	BPSK	3.75	1@0	63.43	40.06	62.31	41.78	62.70	41.74
	QPSK	3.75	1@0	69.68	42.18	68.52	40.34	70.13	40.39
	BPSK	15	1@0	128.59	117.20	119.85	103.10	129.00	116.90
	QPSK	15	1@0	120.14	117.20	117.95	116.70	122.82	118.90
	QPSK	15	12@0	183.63	250.20	183.76	238.80	184.51	240.50
Mode	Modulation	Sub-carrier spacing (KHz)	Ntones	Bandwidth(KHz) for low/middle/high channel					
				133124/663.2		133297/680.5		133470/697.8	
				99% Power	-26dBc	99% Power	-26dBc	99% Power	-26dBc
Band 71 Standalone	BPSK	3.75	1@0	60.84	41.47	60.09	41.45	58.91	41.13
	QPSK	3.75	1@0	69.48	40.55	68.22	41.85	67.83	40.22



	BPSK	15	1@0	119.07	104.90	126.13	105.40	122.37	103.90
	QPSK	15	1@0	119.45	116.10	118.37	116.60	117.27	117.70
	QPSK	15	12@0	186.05	239.50	185.19	239.00	181.89	238.70
Mode	Modulation	Sub-carrier spacing (KHz)	Ntones	Bandwidth(KHz) for low/middle/high channel					
				134004/698.2		134081/705.9		134180/715.8	
				99% Power	-26dBc	99% Power	-26dBc	99% Power	-26dBc
Band 85 Standalone	BPSK	3.75	1@0	61.16	41.13	61.51	41.65	61.10	40.45
	QPSK	3.75	1@0	68.16	42.51	69.65	41.94	67.67	39.67
	BPSK	15	1@0	128.50	116.00	122.87	117.40	130.38	118.20
	QPSK	15	1@0	119.70	116.00	126.94	131.40	127.18	118.90
	QPSK	15	12@0	183.01	238.60	183.86	262.30	182.96	239.10



NB-IOT Band 4 BPSK 3.75KHz 1@0 CH-Low

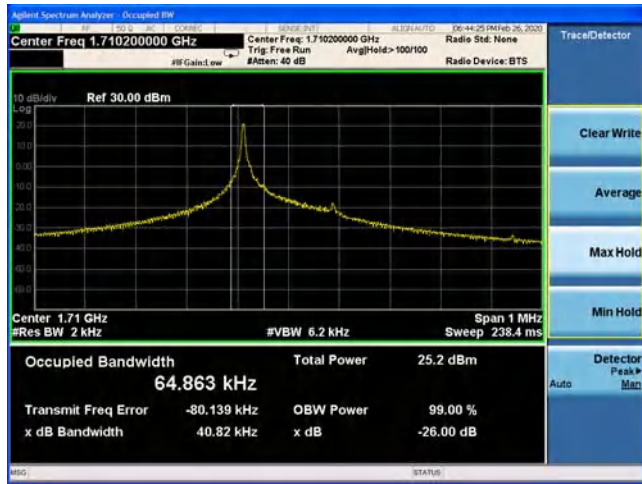

NB-IOT Band 4 BPSK 15KHz 1@0 CH-Low

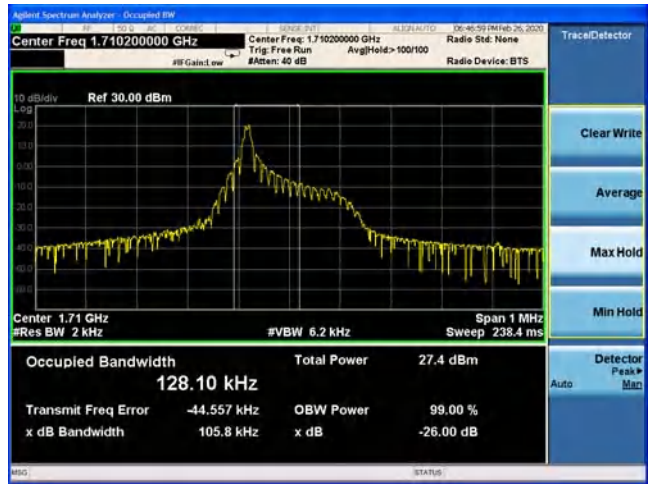

NB-IOT Band 4 BPSK 3.75KHz 1@0 CH-Middle

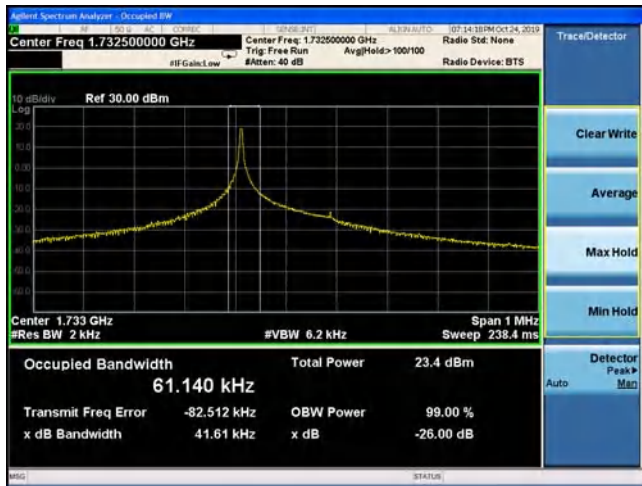

NB-IOT Band 4 BPSK 15KHz 1@0 CH-Middle

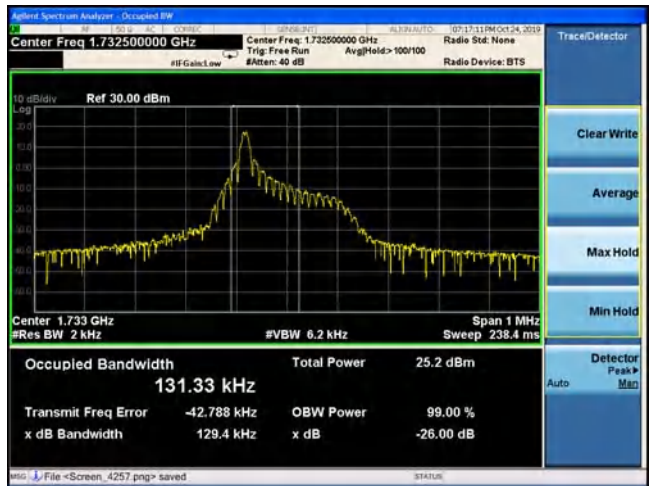

NB-IOT Band 4 BPSK 3.75KHz 1@0 CH-High

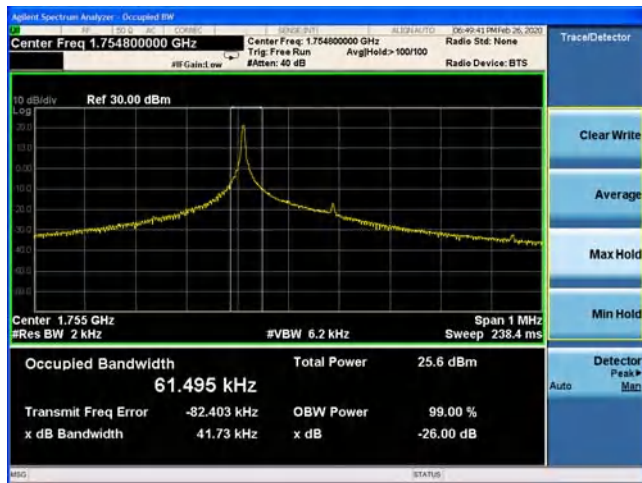

NB-IOT Band 4 BPSK 15KHz 1@0 CH-High

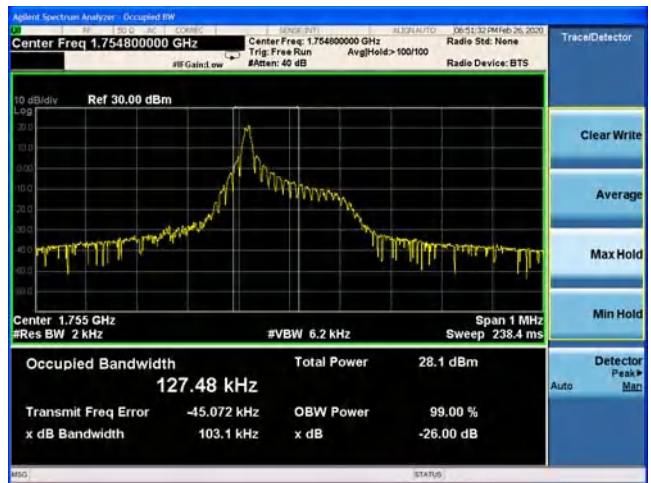



NB-IOT Band 4 QPSK 3.75KHz 1@0 CH-Low

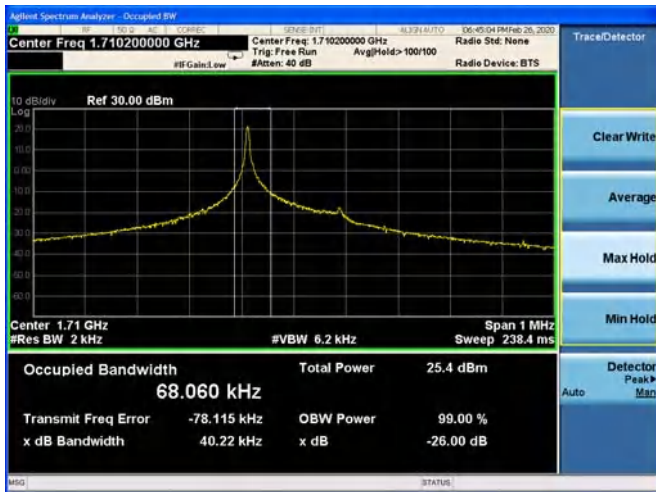

NB-IOT Band 4 QPSK 15KHz 1@0 CH-Low



NB-IOT Band 4 QPSK 3.75KHz 1@0 CH-Middle

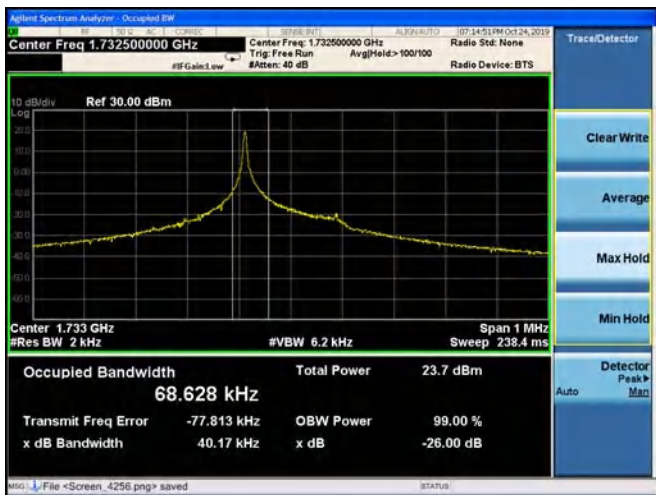

NB-IOT Band 4 QPSK 15KHz 1@0 CH-Middle

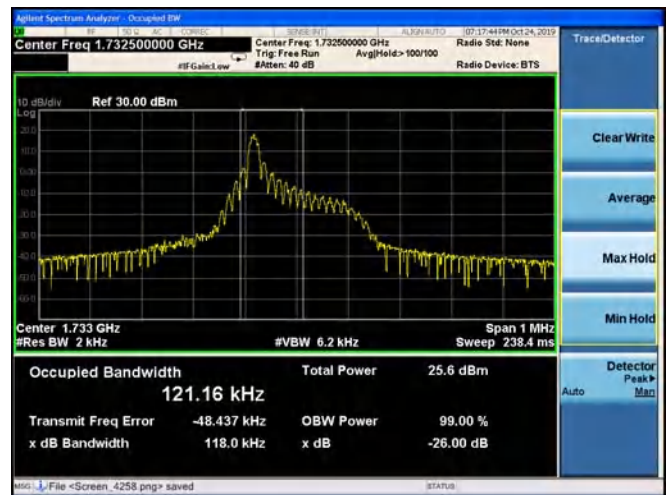

NB-IOT Band 4 QPSK 3.75KHz 1@0 CH-High

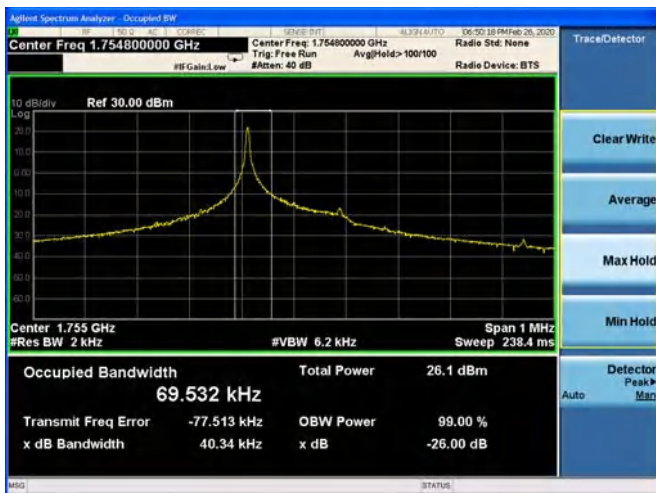

NB-IOT Band 4 QPSK 15KHz 1@0 CH-High

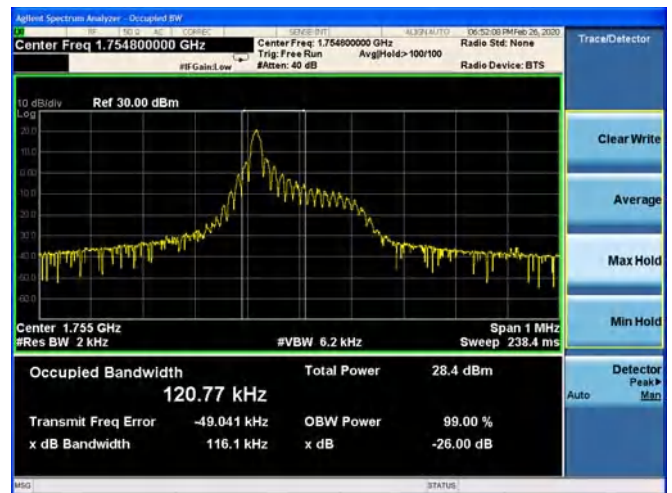



NB-IOT Band 4 QPSK 15KHz 12@0 CH-Low

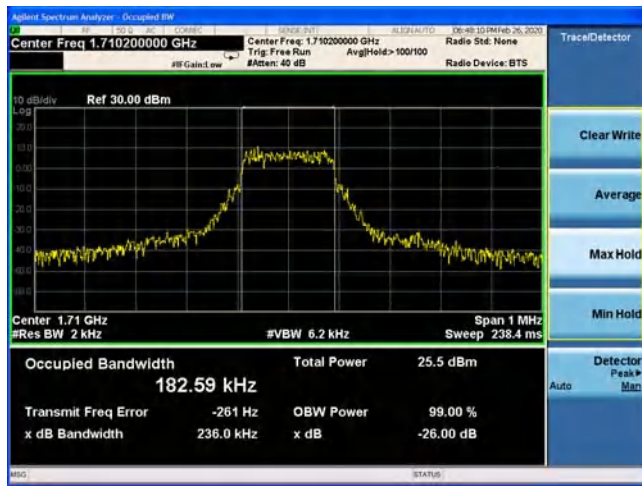

NB-IOT Band 4 QPSK 15KHz 12@0 CH-Middle

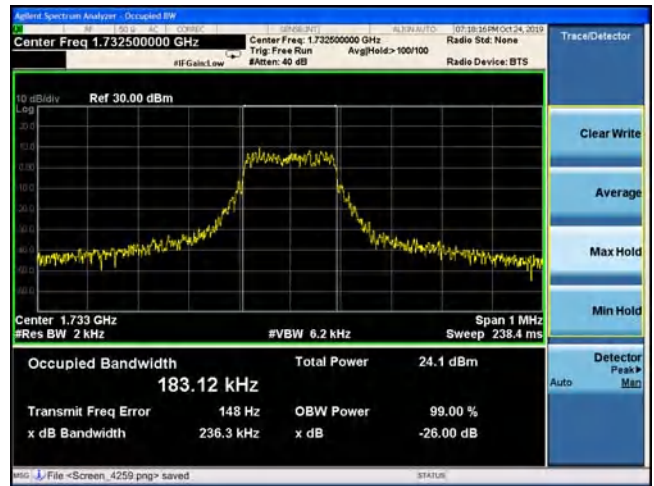

NB-IOT Band 4 QPSK 15KHz 12@0 CH-High

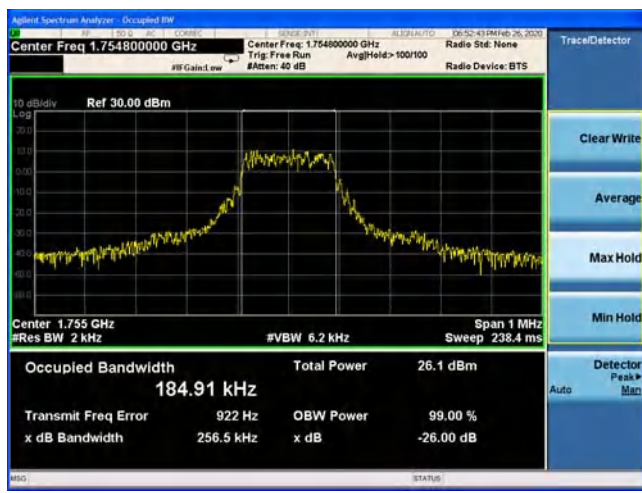



NB-IOT Band 12 BPSK 3.75KHz 1@0 CH-Low

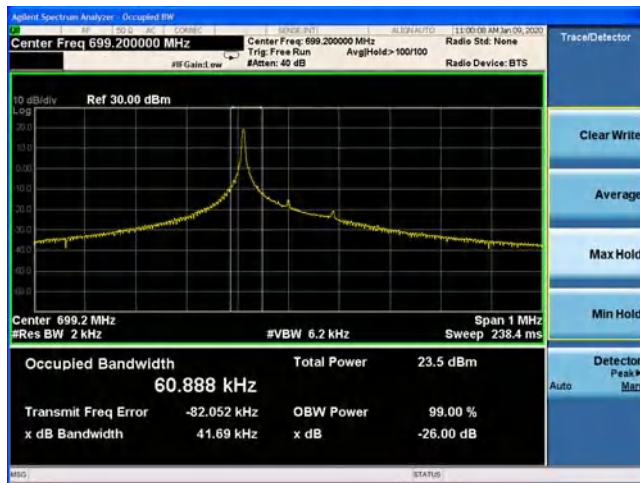

NB-IOT Band 12 BPSK 15KHz 1@0 CH-Low

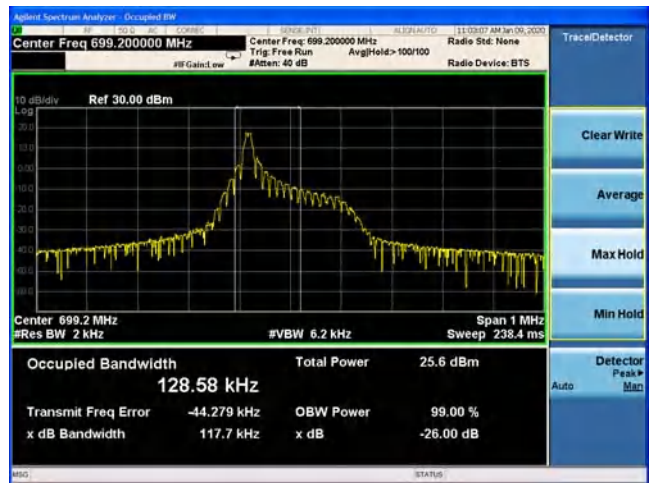

NB-IOT Band 12 BPSK 3.75KHz 1@0 CH-Middle

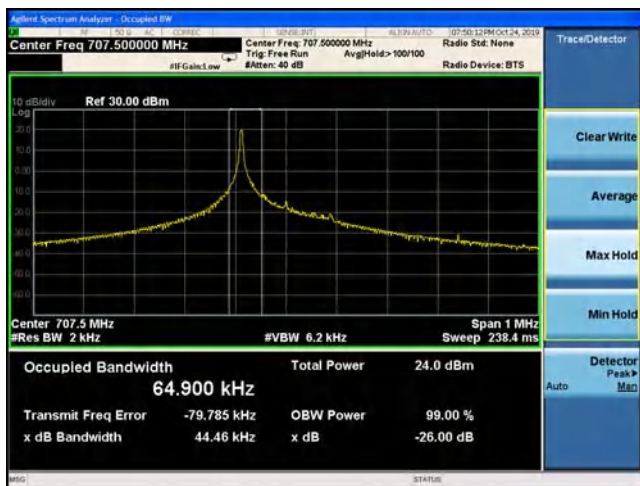

NB-IOT Band 12 BPSK 15KHz 1@0 CH-Middle

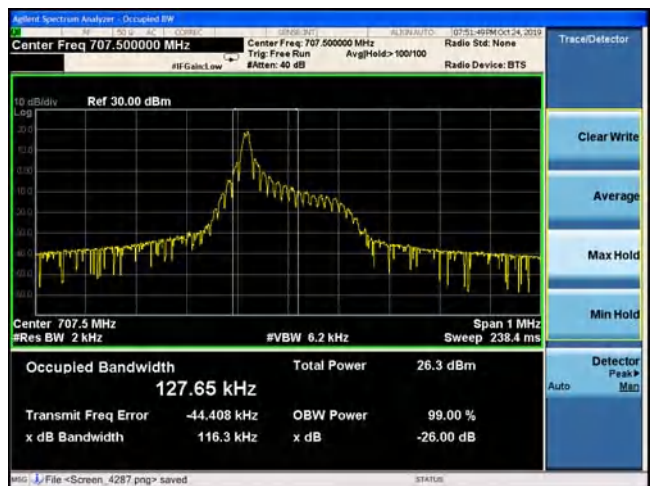

NB-IOT Band 12 BPSK 3.75KHz 1@0 CH-High

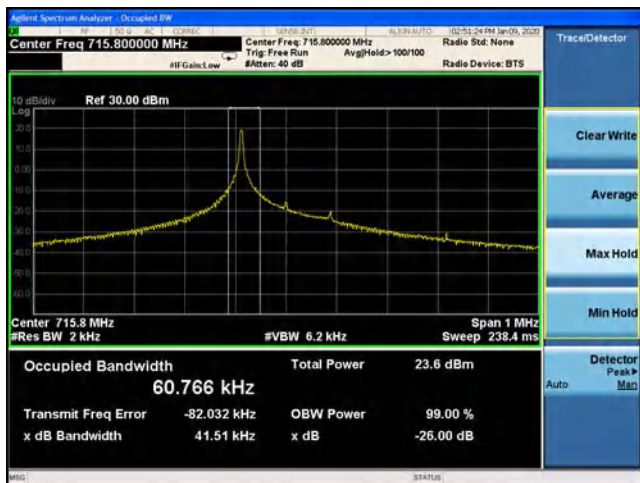

NB-IOT Band 12 BPSK 15KHz 1@0 CH-High

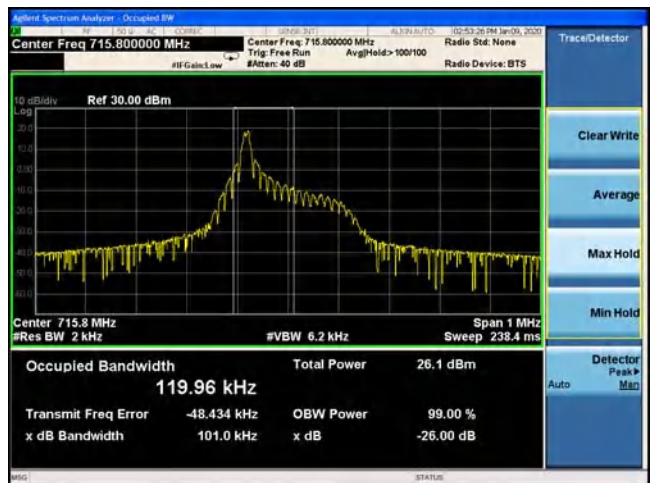



NB-IOT Band 12 QPSK 3.75KHz 1@0 CH-Low

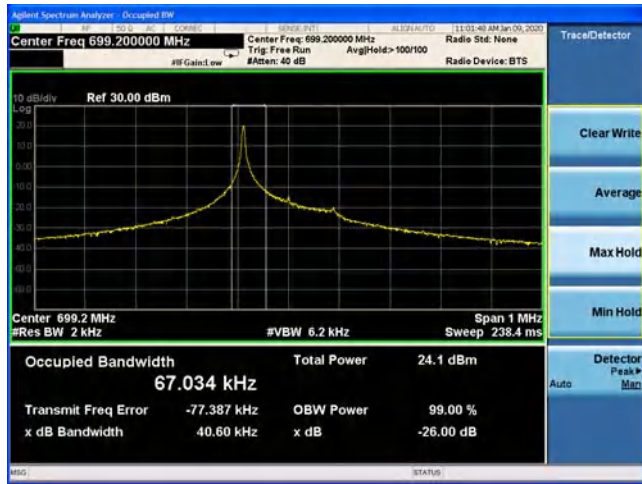

NB-IOT Band 12 QPSK 15KHz 1@0 CH-Low

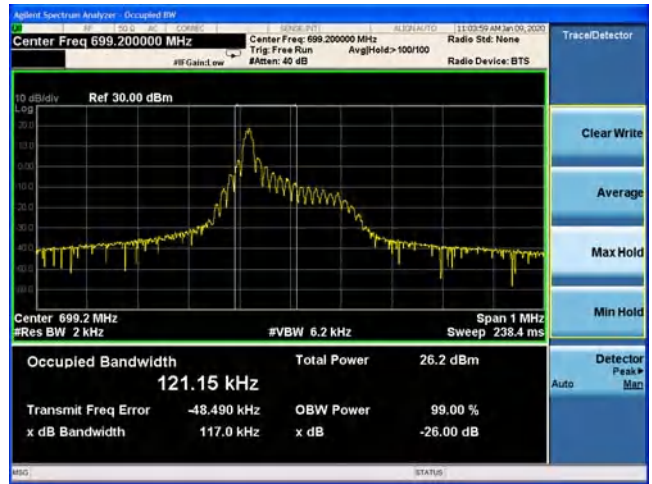

NB-IOT Band 12 QPSK 3.75KHz 1@0 CH-Middle

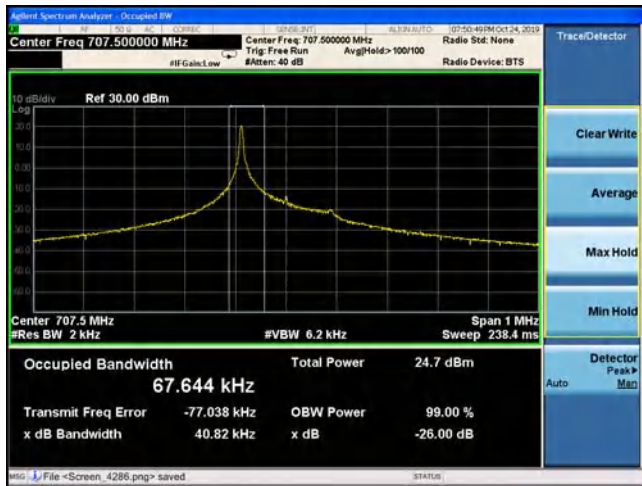

NB-IOT Band 12 QPSK 15KHz 1@0 CH-Middle

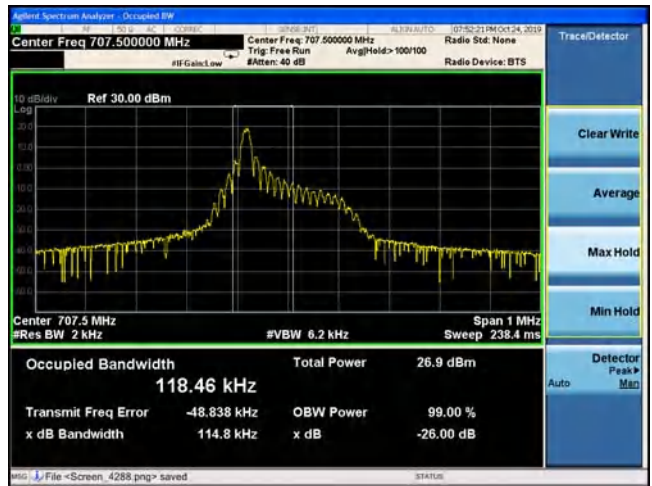

NB-IOT Band 12 QPSK 3.75KHz 1@0 CH-High

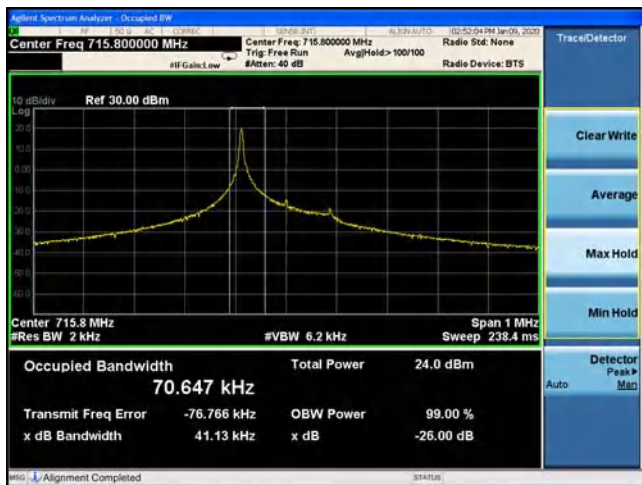

NB-IOT Band 12 QPSK 15KHz 1@0 CH-High

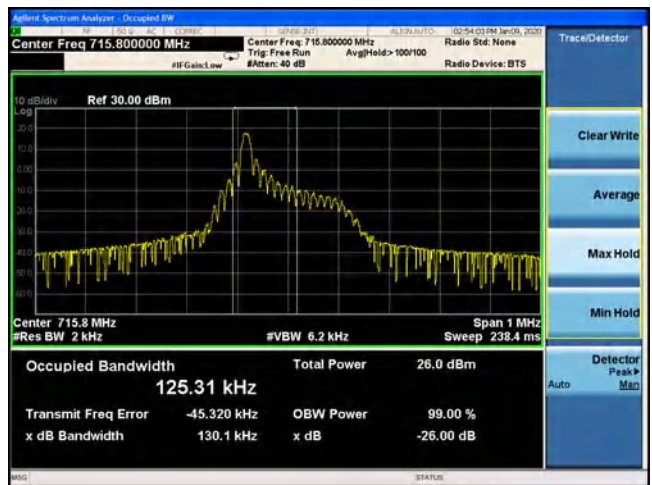



NB-IOT Band 12 QPSK 15KHz 12@0 CH-Low

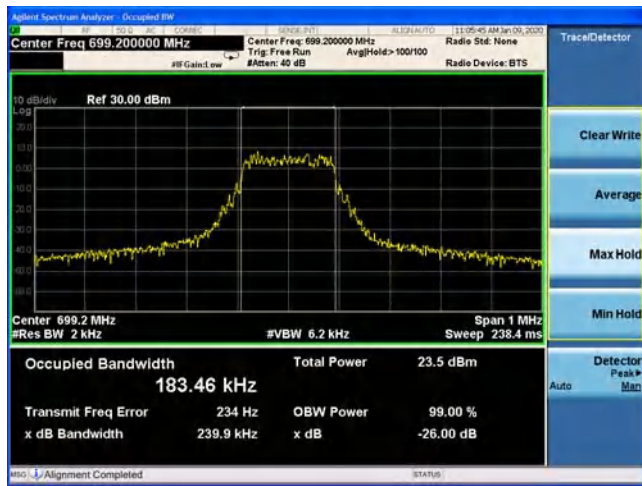

NB-IOT Band 12 QPSK 15KHz 12@0 CH-Middle

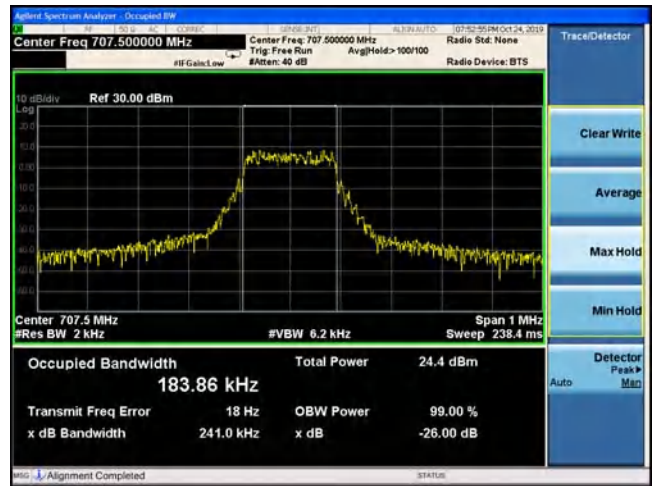

NB-IOT Band 12 QPSK 15KHz 12@0 CH-High

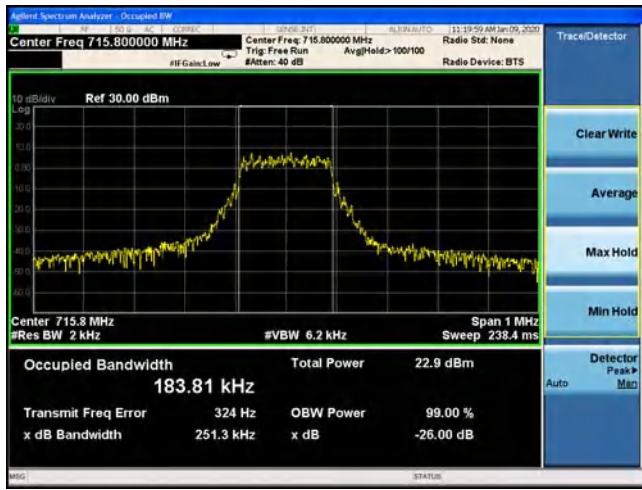



NB-IOT Band 13 BPSK 3.75KHz 1@0 CH-Low



NB-IOT Band 13 BPSK 15KHz 1@0 CH-Low

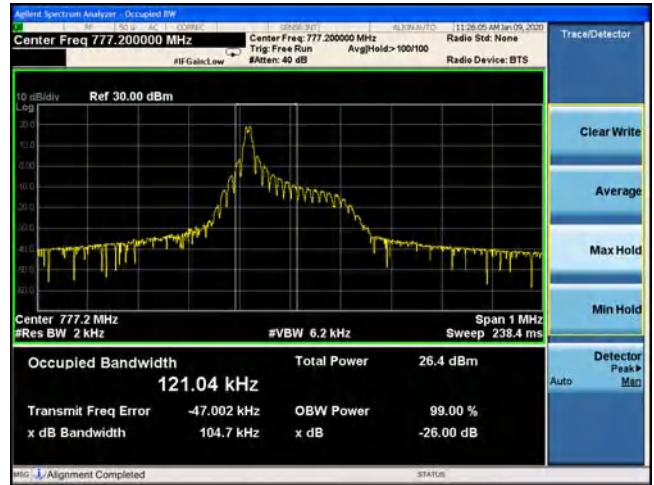

NB-IOT Band 13 BPSK 3.75KHz 1@0 CH-Middle

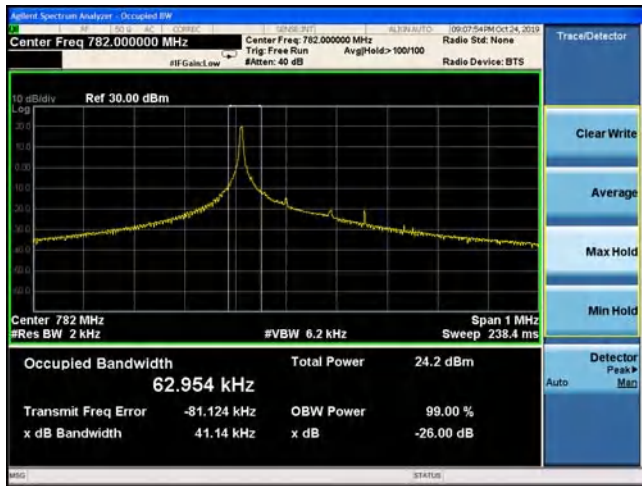

NB-IOT Band 13 BPSK 15KHz 1@0 CH-Middle

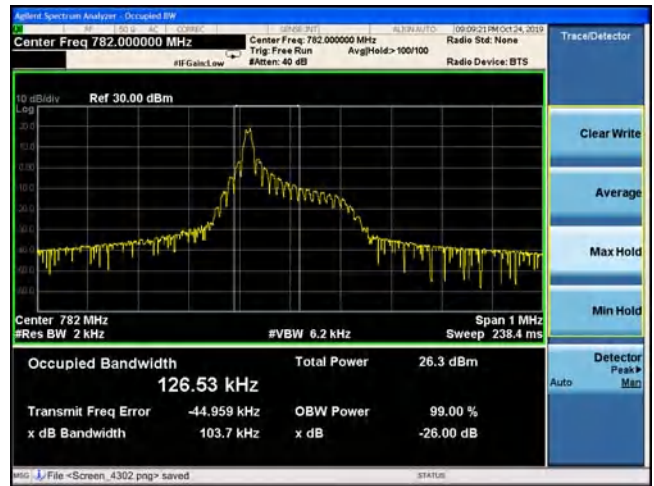

NB-IOT Band 13 BPSK 3.75KHz 1@0 CH-High

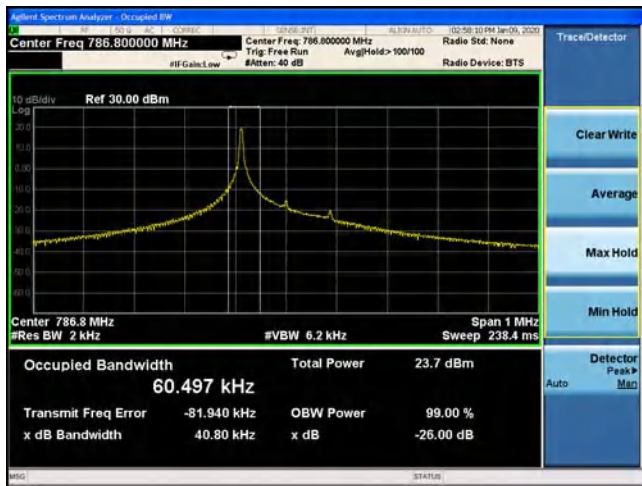

NB-IOT Band 13 BPSK 15KHz 1@0 CH-High





NB-IOT Band 13 QPSK 3.75KHz 1@0 CH-Low

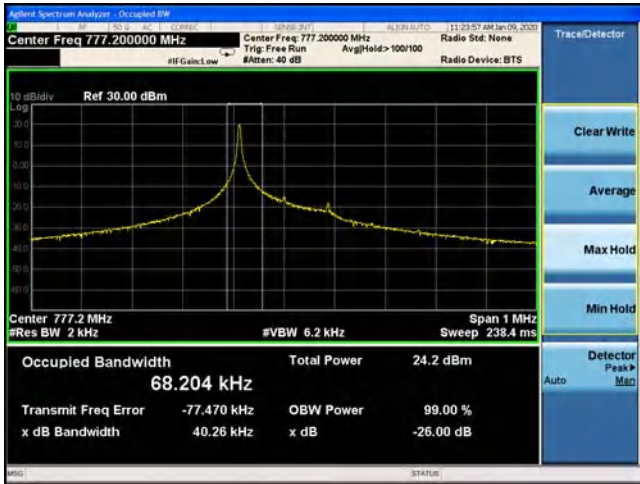

NB-IOT Band 13 QPSK 15KHz 1@0 CH-Low

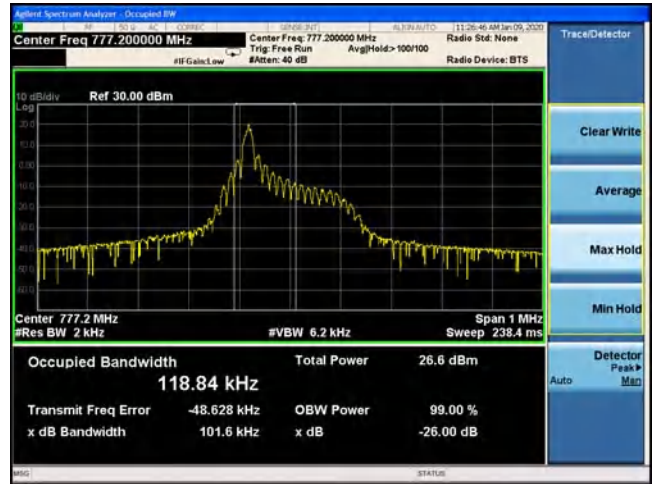

NB-IOT Band 13 QPSK 3.75KHz 1@0 CH-Middle

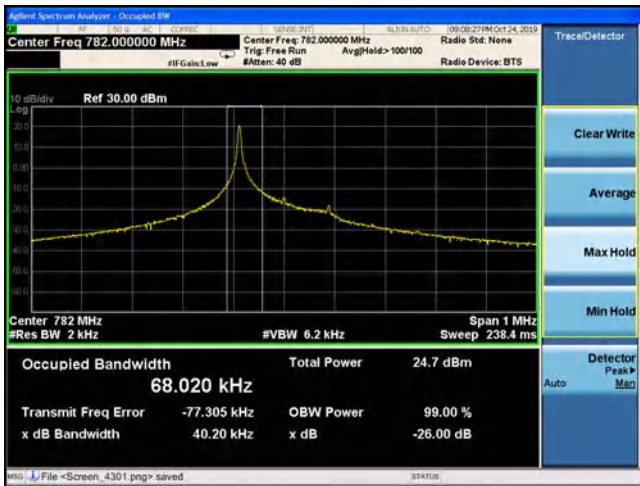

NB-IOT Band 13 QPSK 15KHz 1@0 CH-Middle

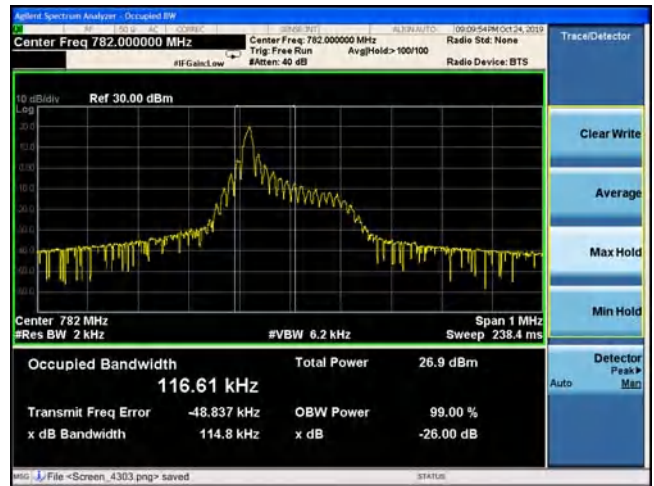

NB-IOT Band 13 QPSK 3.75KHz 1@0 CH-High

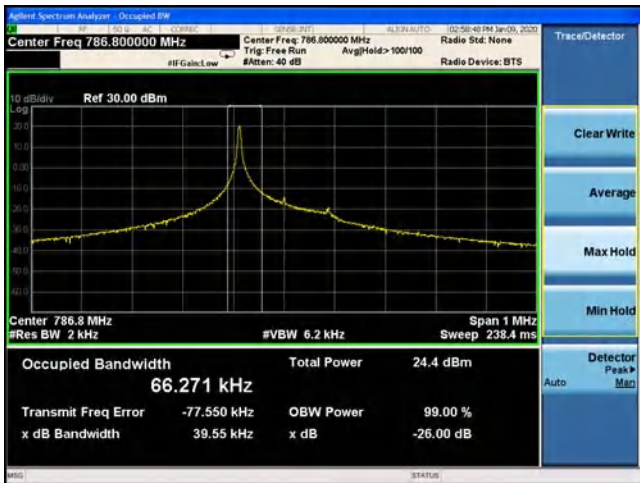

NB-IOT Band 13 QPSK 15KHz 1@0 CH-High

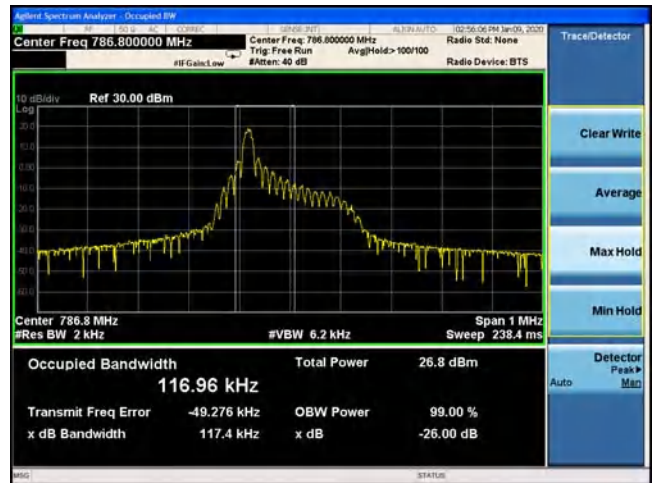



NB-IOT Band 13 QPSK 15KHz 12@0 CH-Low

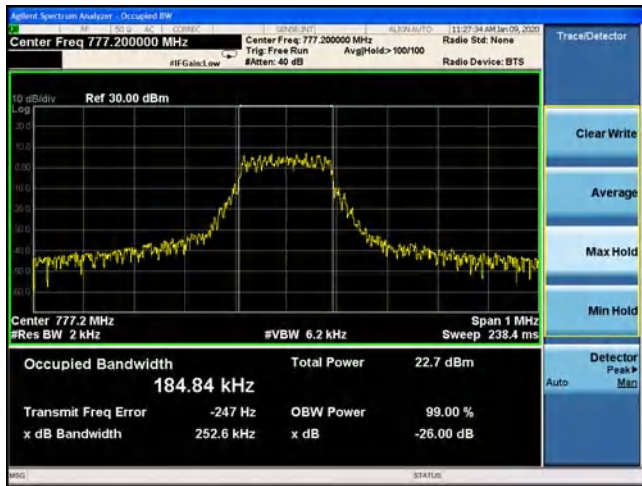

NB-IOT Band 13 QPSK 15KHz 12@0 CH-Middle

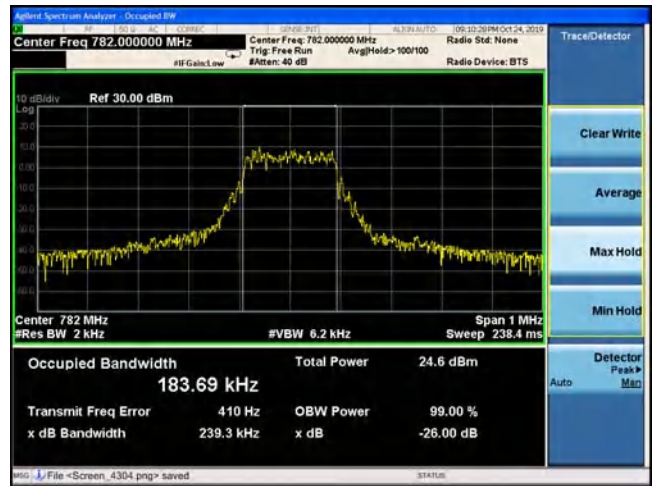

NB-IOT Band 13 QPSK 15KHz 12@0 CH-High

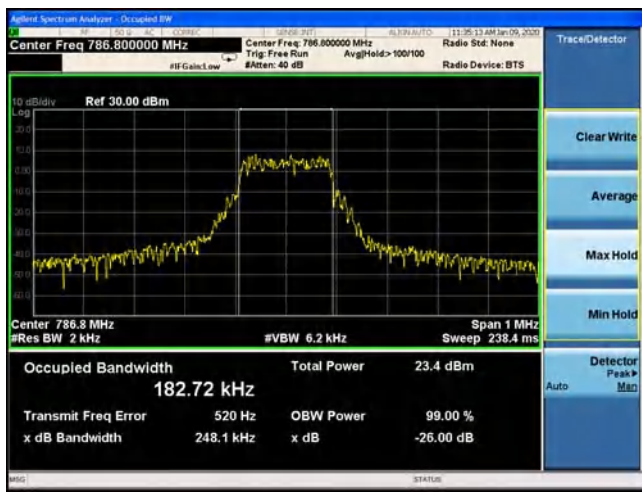



NB-IOT Band 66 BPSK 3.75KHz 1@0 CH-Low

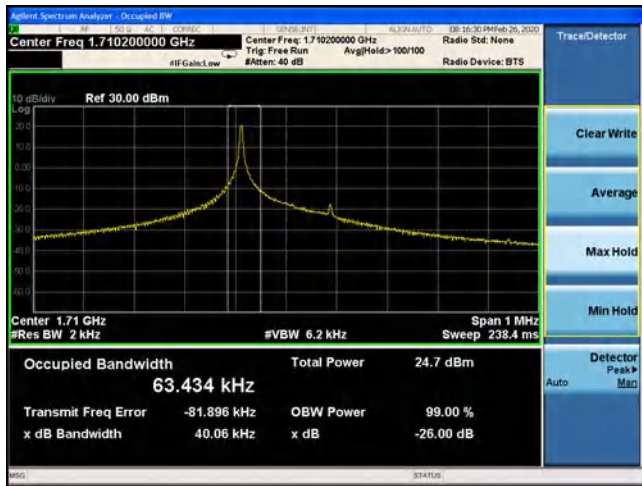

NB-IOT Band 66 BPSK 15KHz 1@0 CH-Low

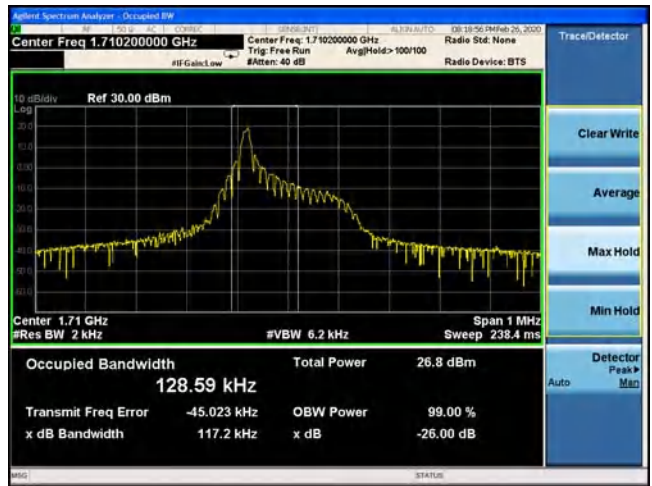

NB-IOT Band 66 BPSK 3.75KHz 1@0 CH-Middle

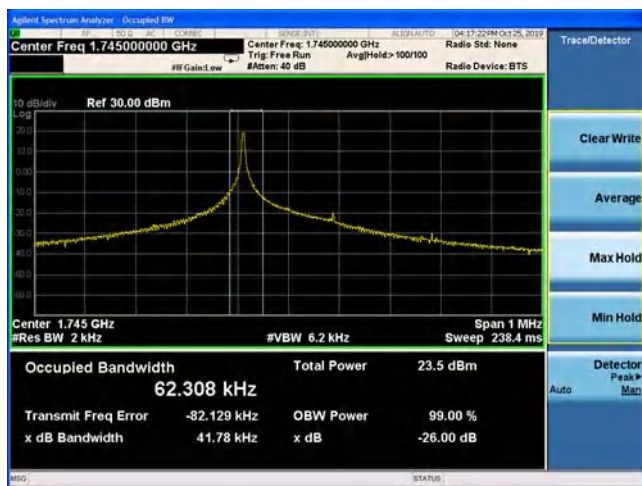

NB-IOT Band 66 BPSK 15KHz 1@0 CH-Middle



NB-IOT Band 66 BPSK 3.75KHz 1@0 CH-High

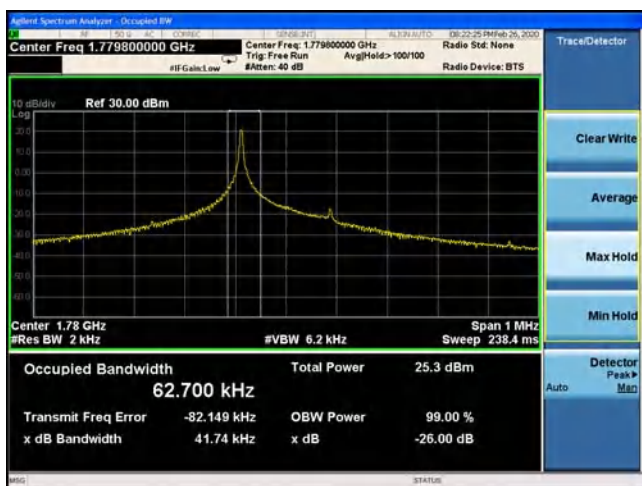

NB-IOT Band 66 BPSK 15KHz 1@0 CH-High

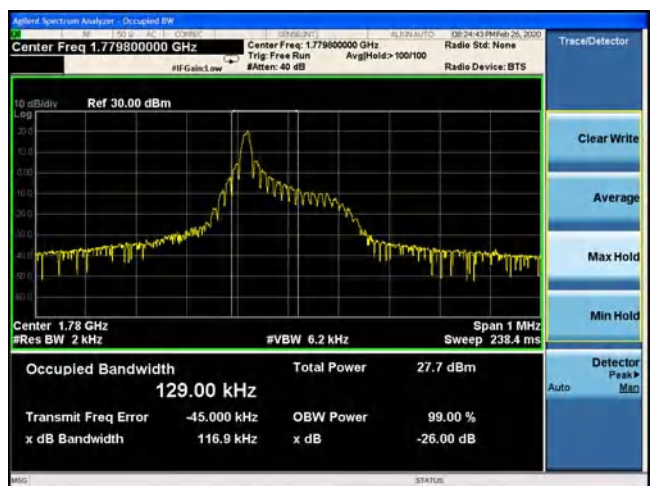



NB-IOT Band 66 QPSK 3.75KHz 1@0 CH-Low

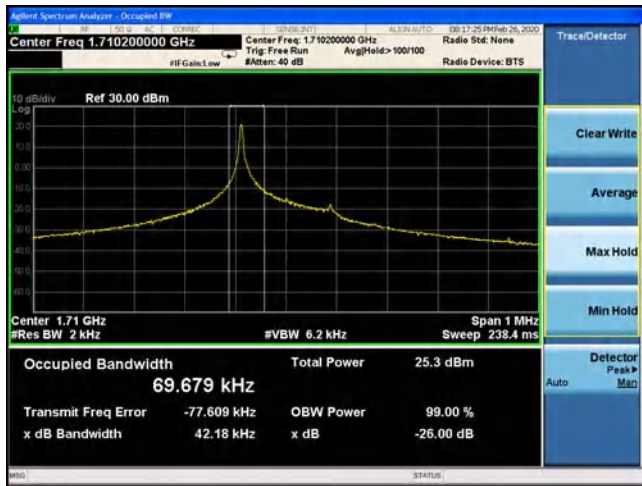

NB-IOT Band 66 QPSK 15KHz 1@0 CH-Low



NB-IOT Band 66 QPSK 3.75KHz 1@0 CH-Middle

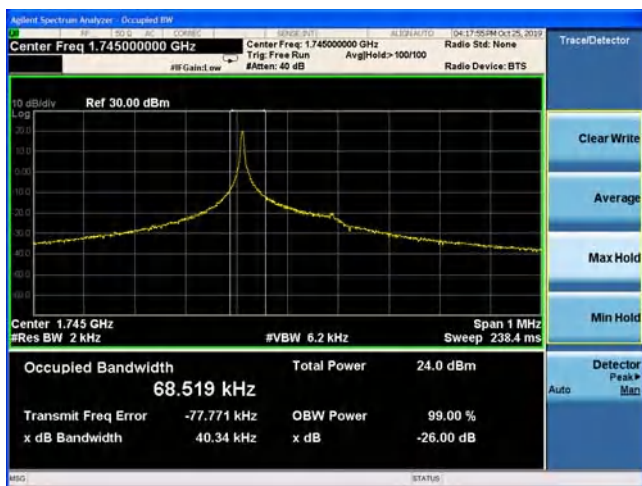

NB-IOT Band 66 QPSK 15KHz 1@0 CH-Middle

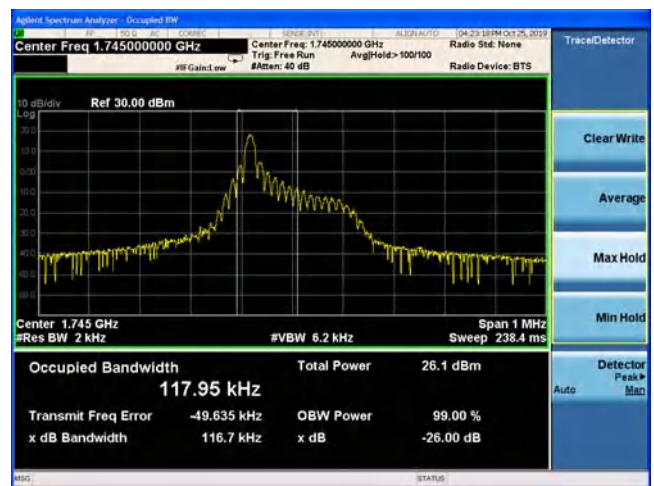

NB-IOT Band 66 QPSK 3.75KHz 1@0 CH-High

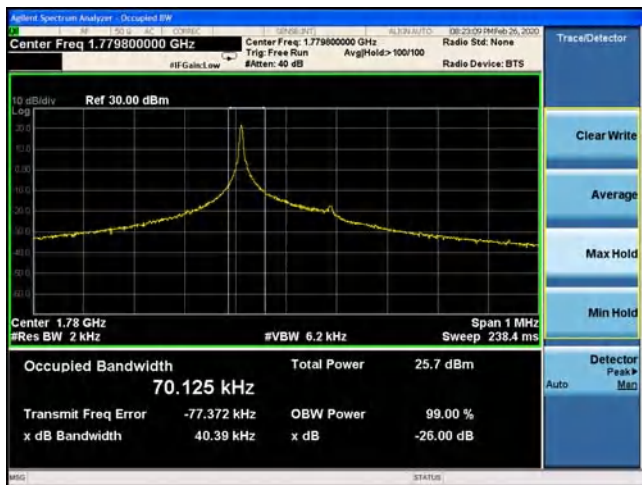

NB-IOT Band 66 QPSK 15KHz 1@0 CH-High

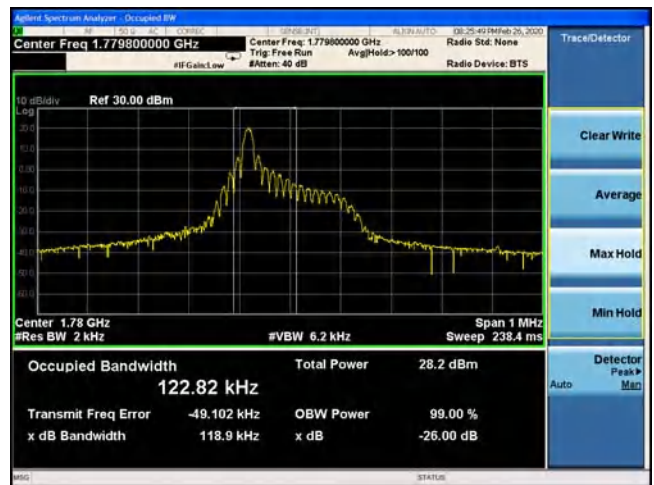



NB-IOT Band 66 QPSK 15KHz 12@0 CH-Low



NB-IOT Band 66 QPSK 15KHz 12@0 CH-Middle

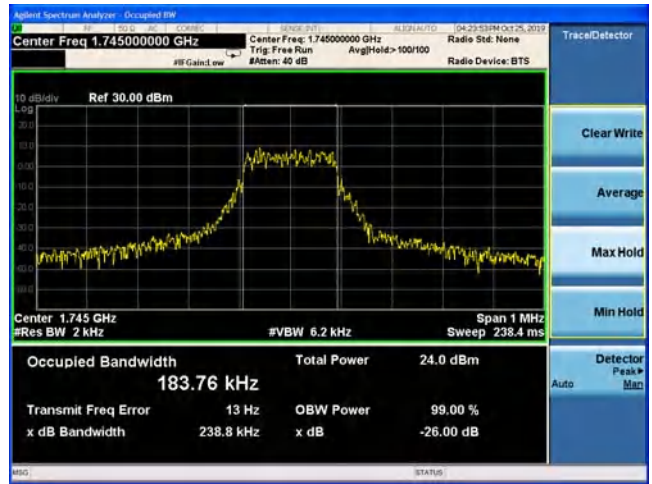

NB-IOT Band 66 QPSK 15KHz 12@0 CH-High





NB-IOT Band 71 BPSK 3.75KHz 1@0 CH-Low

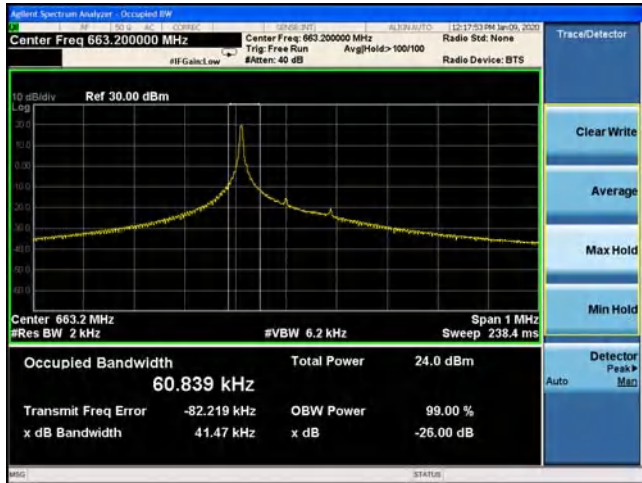

LTE Band 71 BPSK 15KHz 1@0 CH-Low

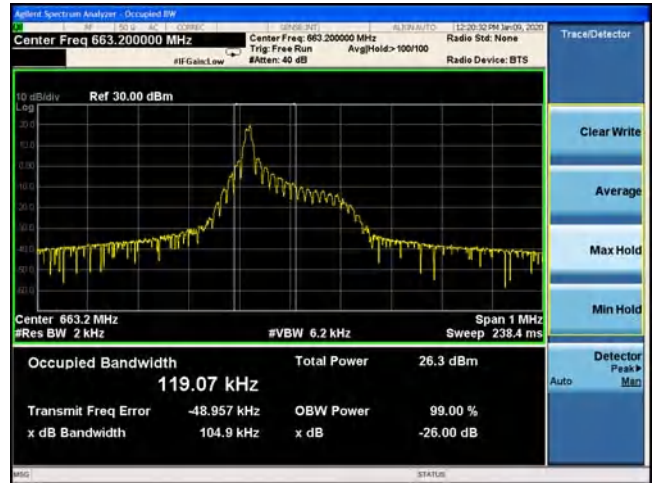

NB-IOT Band 71 BPSK 3.75KHz 1@0 CH-Middle

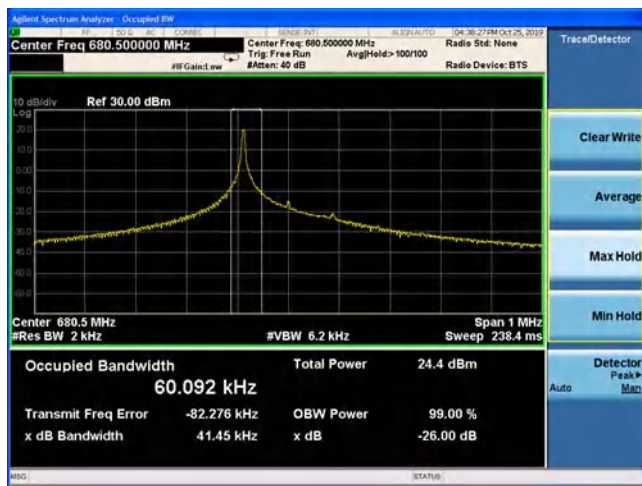

LTE Band 71 BPSK 15KHz 1@0 CH-Middle

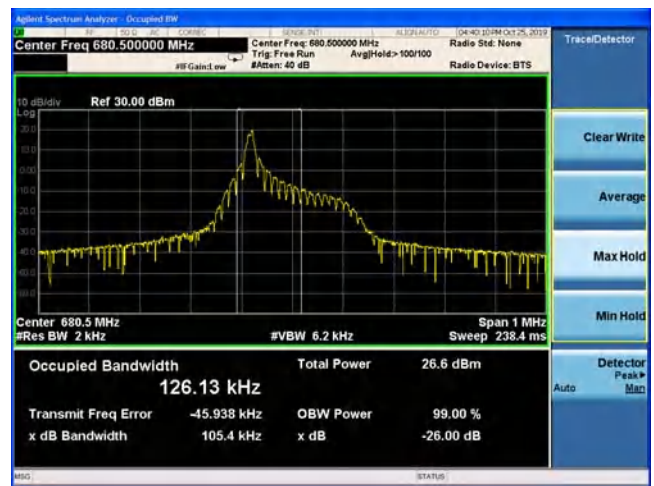

NB-IOT Band 71 BPSK 3.75KHz 1@0 CH-High

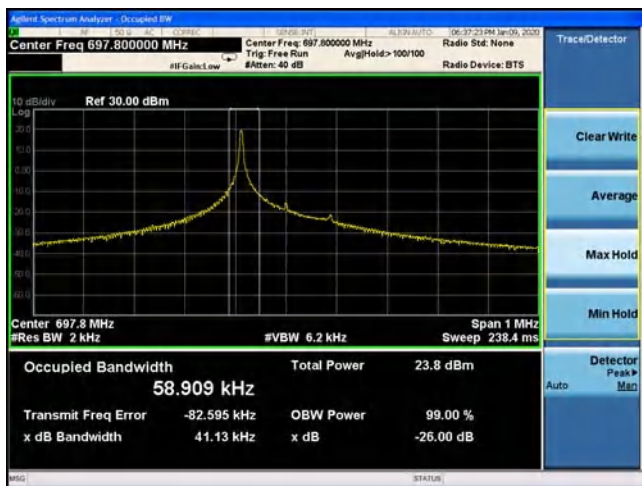

LTE Band71 BPSK 15KHz 1@0 CH-High

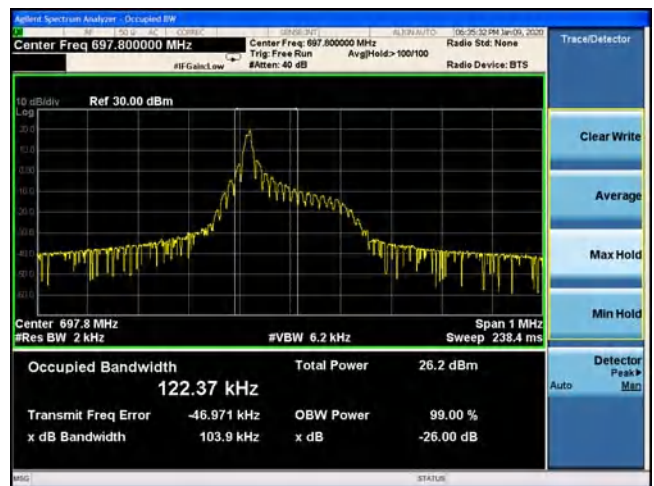



NB-IOT Band 71 QPSK 3.75KHz 1@0 CH-Low

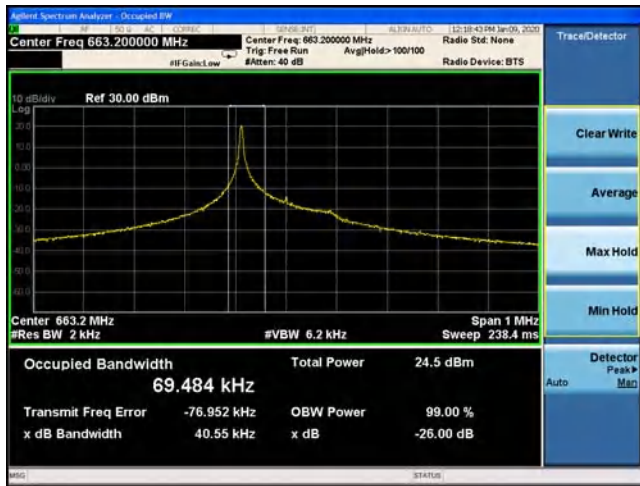

NB-IOT Band 71 QPSK 15KHz 1@0 CH-Low



NB-IOT Band 71 QPSK 3.75KHz 1@0 CH-Middle

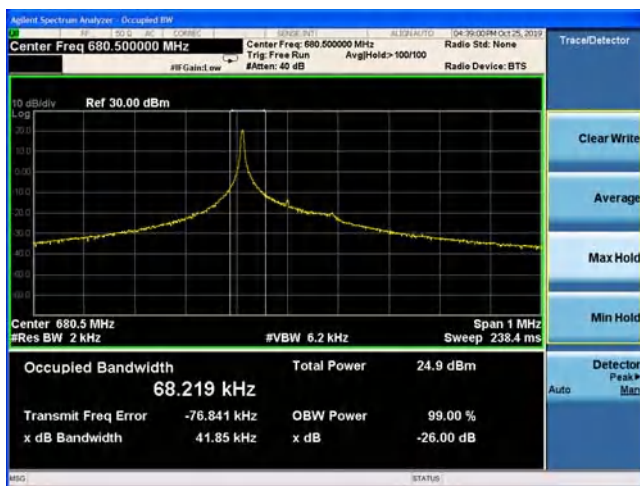

NB-IOT Band 71 QPSK 15KHz 1@0 CH-Middle

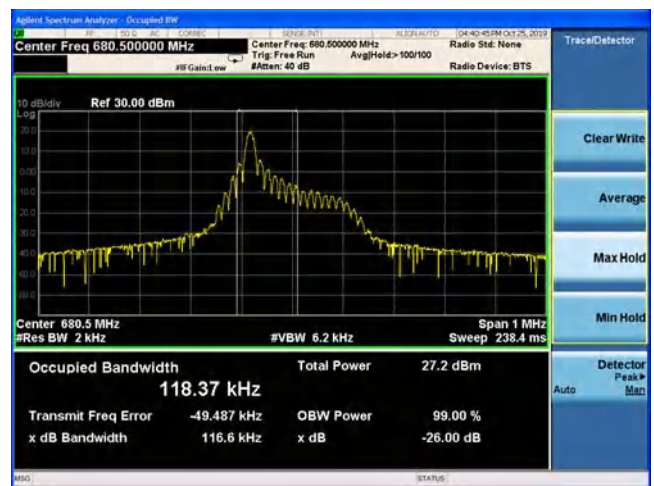

NB-IOT Band 71 QPSK 3.75KHz 1@0 CH-High

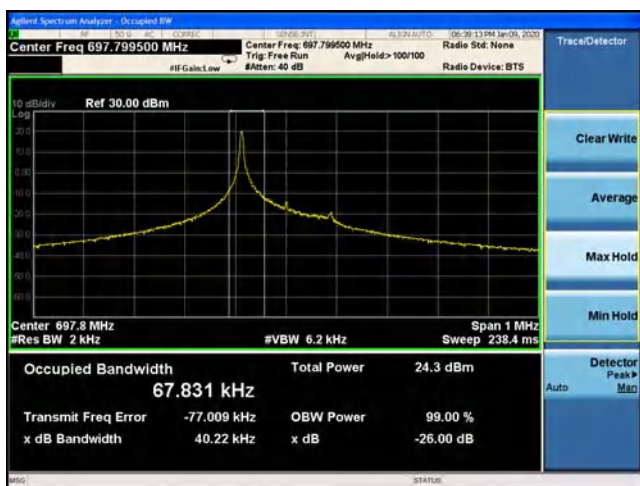

NB-IOT Band 71 QPSK 15KHz 1@0 CH-High

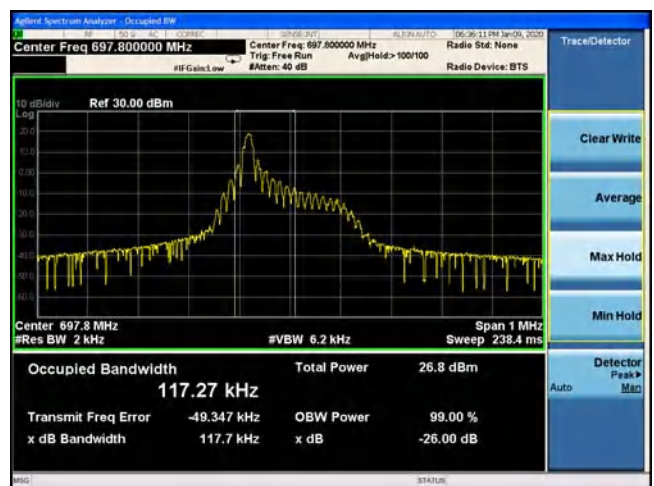



NB-IOT Band 71 QPSK 15KHz 12@0 CH-Low



NB-IOT Band 71 QPSK 15KHz 12@0 CH-Middle

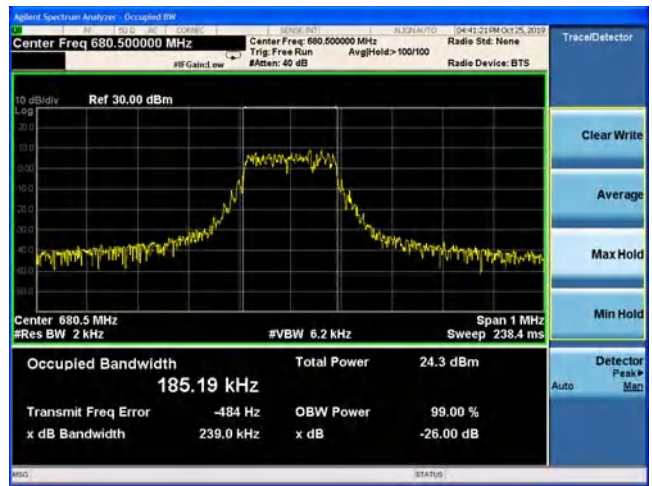

NB-IOT Band 71 QPSK 15KHz 12@0 CH-High

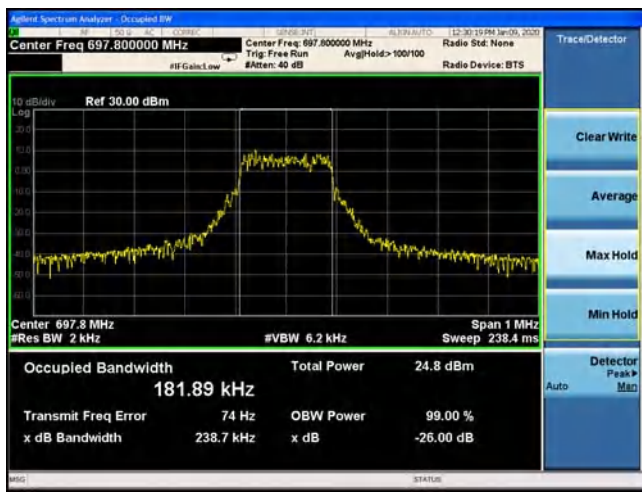



NB-IOT Band 85 BPSK 3.75KHz 1@0 CH-Low

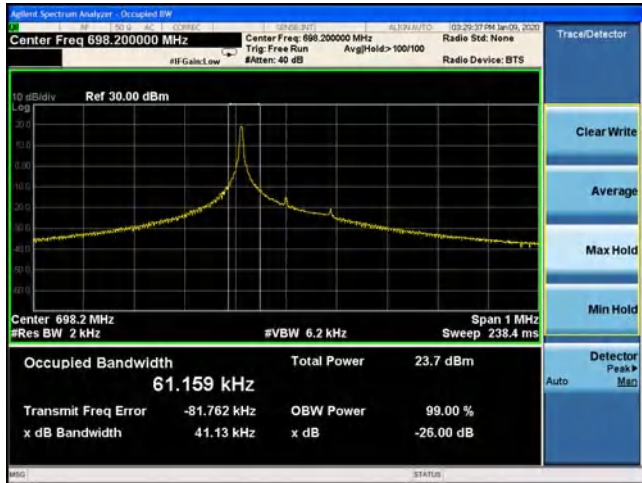

LTE Band 85 BPSK 15KHz 1@0 CH-Low

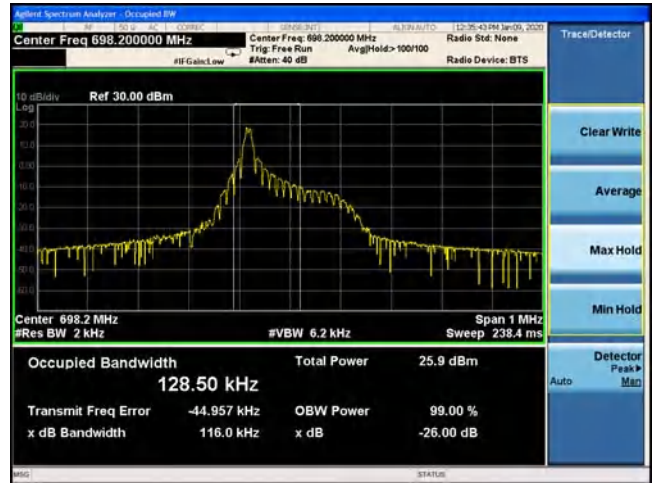

NB-IOT Band 85 BPSK 3.75KHz 1@0 CH-Middle

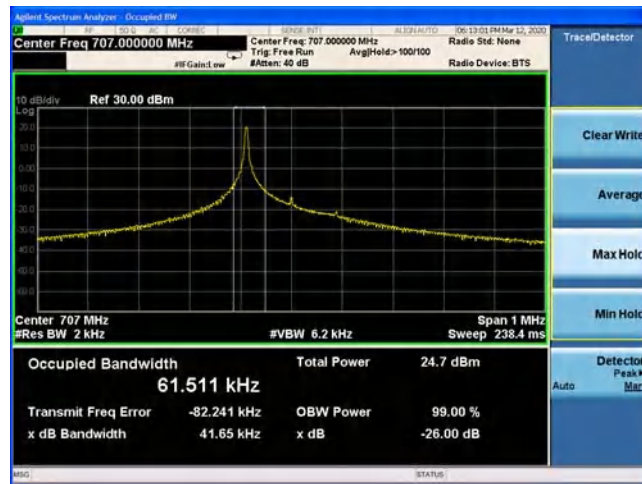

LTE Band 85 BPSK 15KHz 1@0 CH-Middle

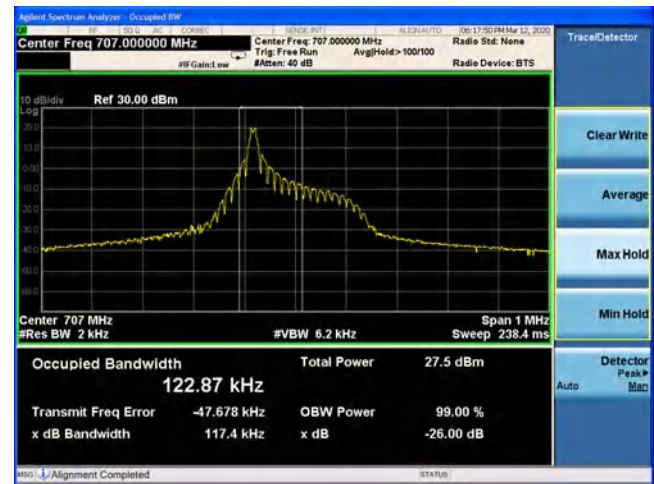

NB-IOT Band 85 BPSK 3.75KHz 1@0 CH-High

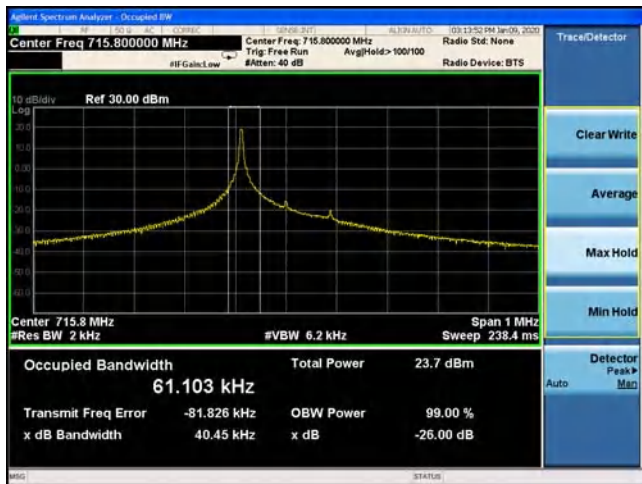

LTE Band85 BPSK 15KHz 1@0 CH-High

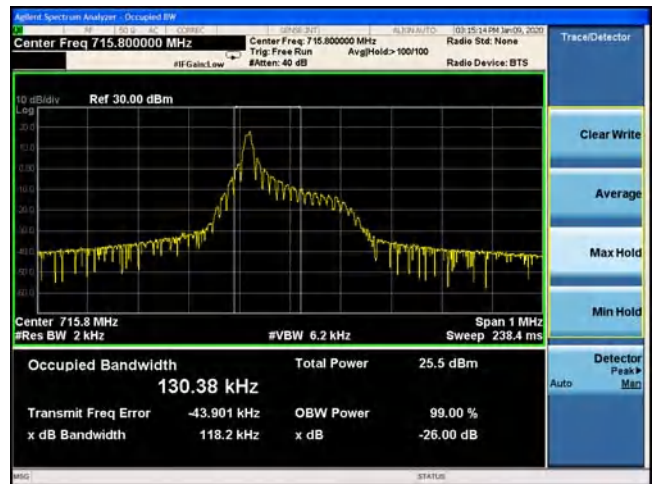



NB-IOT Band 85 QPSK 3.75KHz 1@0 CH-Low

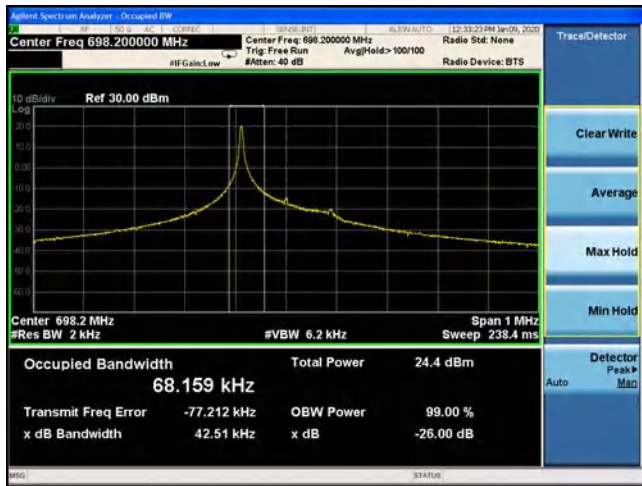

NB-IOT Band 85 QPSK 15KHz 1@0 CH-Low



NB-IOT Band 85 QPSK 3.75KHz 1@0 CH-Middle

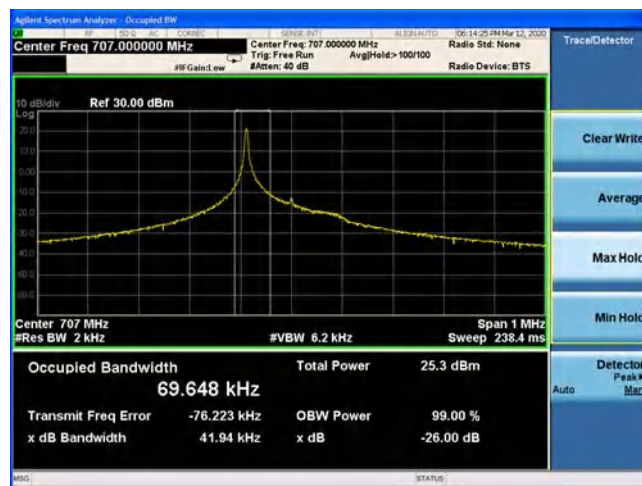

NB-IOT Band 85 QPSK 15KHz 1@0 CH-Middle

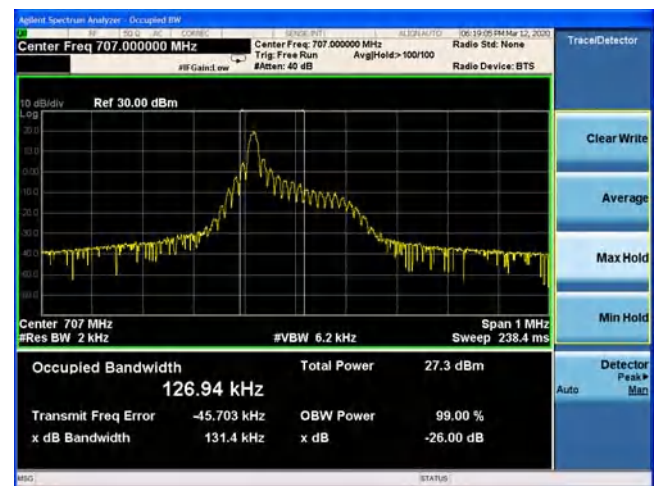

NB-IOT Band 85 QPSK 3.75KHz 1@0 CH-High

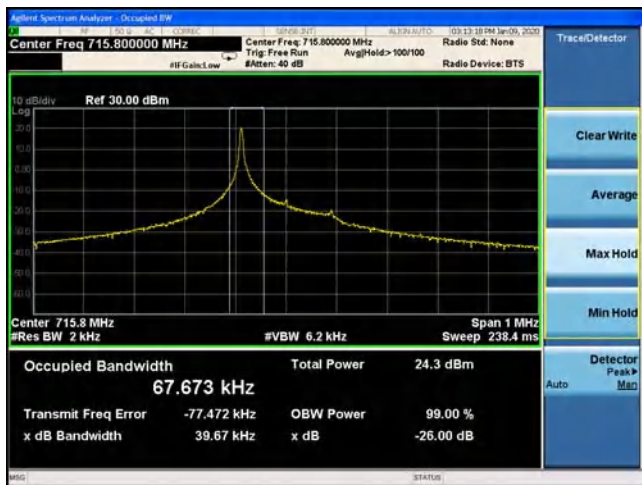

NB-IOT Band 85 QPSK 15KHz 1@0 CH-High

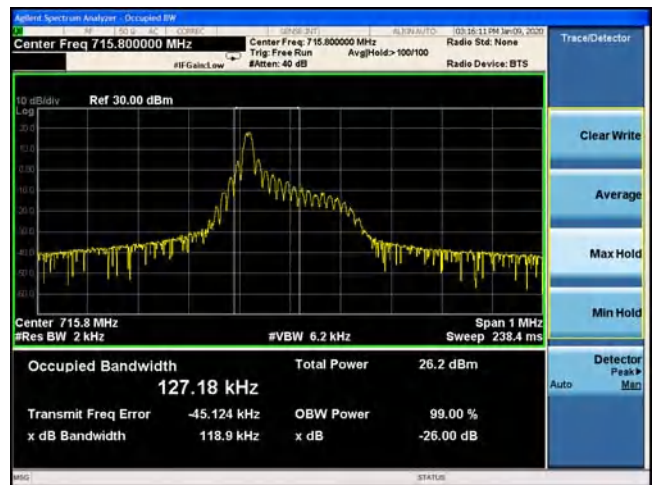



NB-IOT Band 85 QPSK 15KHz 12@0 CH-Low

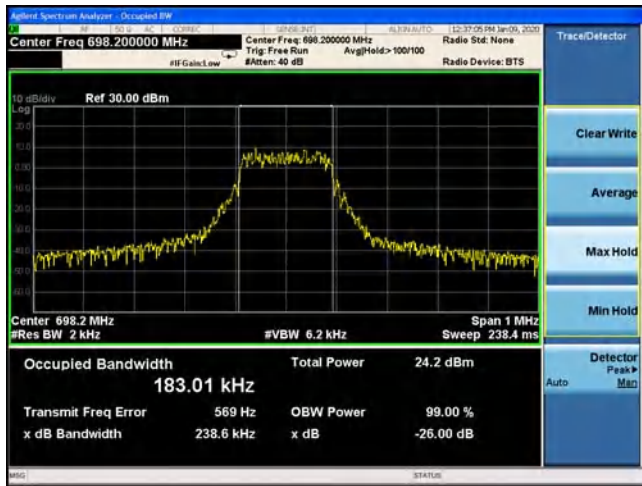

NB-IOT Band 85 QPSK 15KHz 12@0 CH-Middle

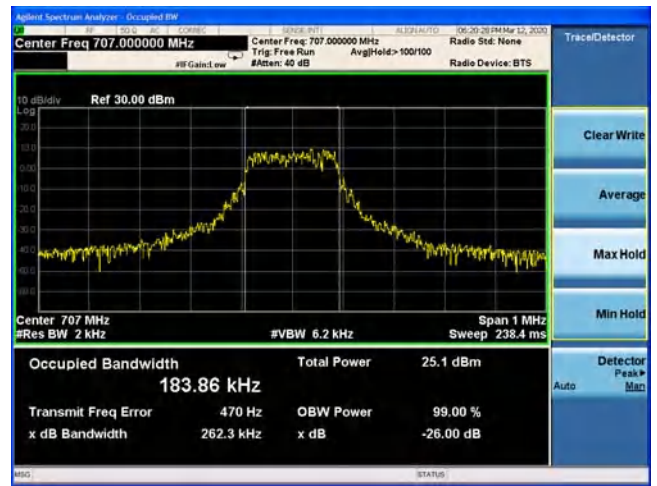

NB-IOT Band 85 QPSK 15KHz 12@0 CH-High

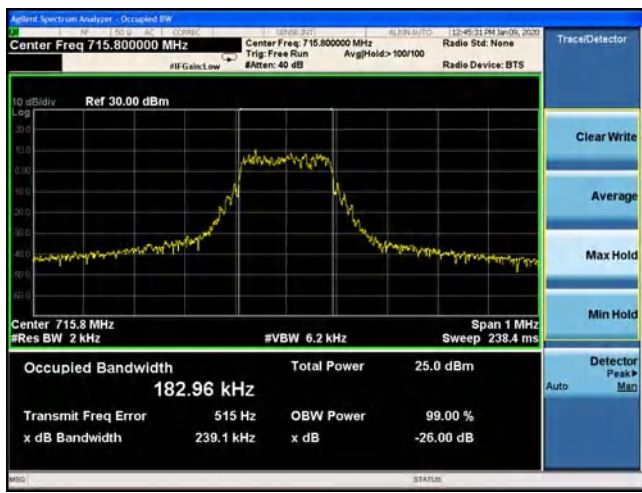

5.3 Band Edge Compliance

Ambient condition

Temperature	Relative humidity	Pressure
23°C ~25°C	45%~50%	101.5kPa

Method of Measurement

The EUT was connected to Spectrum Analyzer and Base Station Simulator via power Splitter. The band edge of the lowest and highest channels were measured.

The testing follows KDB 971168D01v03r01 Section 6.0

The EUT was connected to spectrum analyzer and system simulator via a power divider.

The band edges of low and high channels for the highest RF powers were measured.

RBW is set to $\geq 1\%EBW$, VBW is set to 3x RBW.

onspectrumanalyzer.

Set spectrum analyzer with RMS detector.

The RF fundamental frequency should be excluded against the limit line in the operating frequency band.

Checked that all the results comply with the emission limit line.

Test Setup

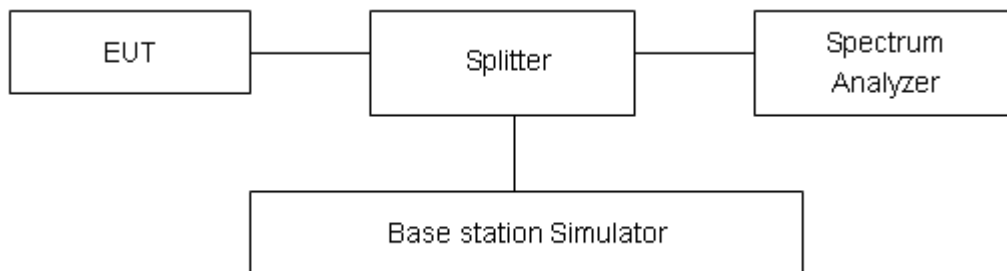

Limits

Rule Part 27.53(i) By a factor of not less than $43 + 10 \log (P)$ dB on all frequencies between 2305 and 2320 MHz.

Rule Part 27.53(h) specifies that “ for operations in the 1695-1710 MHz, 1710-1755 MHz, 1755-1780 MHz, 1915-1920 MHz, 1995-2000 MHz, 2000-2020 MHz, 2110-2155 MHz, 2155-2180 MHz, and 2180-2200 bands, the power of any emission outside a licensee's frequency block shall be attenuated below the transmitter power (P) in watts by at least $43 + 10 \log_{10} (P)$ dB”



Rule Part 27.53(g) For operations in the 600 MHz band and the 698-746 MHz band, the power of any emission outside a licensee's frequency band(s) of operation shall be attenuated below the transmitter power (P) within the licensed band(s) of operation, measured in watts, by at least $43 + 10 \log (P)$ dB. Compliance with this provision is based on the use of measurement instrumentation employing a resolution bandwidth of 100 kilohertz or greater. However, in the 100 kilohertz bands immediately outside and adjacent to a licensee's frequency block, a resolution bandwidth of at least 30 kHz may be employed.

Rule Part 27.53(m)(4) specifies that "for BRS and EBS stations. For mobile digital stations, the attenuation factor shall be not less than $40 + 10 \log (P)$ dB on all frequencies between the channel edge and 5 megahertz from the channel edge, $43 + 10 \log (P)$ dB on all frequencies between 5 megahertz and X megahertz from the channel edge, and $55 + 10 \log (P)$ dB on all frequencies more than X megahertz from the channel edge, where X is the greater of 6 megahertz or the actual emission bandwidth as defined in paragraph (m)(4) of this section. In addition, the attenuation factor shall not be less than $43 + 10 \log (P)$ dB on all frequencies between 2490.5 MHz and 2496 MHz and $55 + 10 \log (P)$ dB at or below 2490.5 MHz. Mobile Satellite Service licensees operating on frequencies below 2495 MHz may also submit a documented interference complaint against BRS licensees operating on channel BRS Channel 1 on the same terms and conditions as adjacent channel BRS or EBS licensees.

Example:

The limit line is derived from $43 + 10 \log (P)$ dB below the transmitter power P (Watts)
= $P(W) - [43 + 10 \log (P)]$ (dB)
= $[30 + 10 \log (P)]$ (dBm) - $[43 + 10 \log (P)]$ (dB) = -13 dBm.

Rule Part 27.53(f) For operations in the 746-758 MHz, 775-788 MHz, and 805-806 MHz bands, emissions in the band 1559-1610 MHz shall be limited to -70 dBW/MHz equivalent isotropically radiated power (EIRP) for wideband signals, and -80 dBW EIRP for discrete emissions of less than 700 Hz bandwidth. For the purpose of equipment authorization, a transmitter shall be tested with an antenna that is representative of the type that will be used with the equipment in normal operation.

Rule Part 27.53 (c) For operations in the 746-758 MHz band and the 776-788 MHz band, the power of any emission outside the licensee's frequency band(s) of operation shall be attenuated below the transmitter power (P) within the licensed band(s) of operation, measured in watts, in accordance with the following:

- (1) On any frequency outside the 746-758 MHz band, the power of any emission shall be attenuated outside the band below the transmitter power (P) by at least $43 + 10 \log (P)$ dB;
- (2) On any frequency outside the 776-788 MHz band, the power of any emission shall be attenuated outside the band below the transmitter power (P) by at least $43 + 10 \log (P)$ dB;
- (3) On all frequencies between 763-775 MHz and 793-805 MHz, by a factor not less than $76 + 10 \log (P)$ dB in a 6.25 kHz band segment, for base and fixed stations;
- (4) On all frequencies between 763-775 MHz and 793-805 MHz, by a factor not less than $65 + 10 \log (P)$ dB in a 6.25 kHz band segment, for mobile and portable stations;
- (5) Compliance with the provisions of paragraphs (c)(1) and (c)(2) of this section is based on the use of measurement instrumentation employing a resolution bandwidth of 100 kHz or greater. However, in



the 100 kHz bands immediately outside and adjacent to the frequency block, a resolution bandwidth of at least 30 kHz may be employed;

Measurement Uncertainty

The assessed measurement uncertainty to ensure 95% confidence level for the normal distribution is with the coverage factor $k = 1.96$, $U=0.684\text{dB}$.



Test Result

All the test traces in the plots shows the test results clearly.

NB-IOT Band 4 BPSK 3.75KHz 1@0 CH-Low

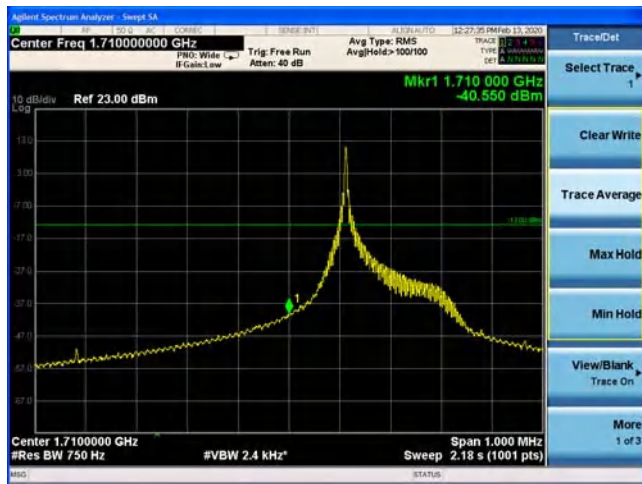

NB-IOT Band 4 BPSK 3.75KHz 1@0 CH-High

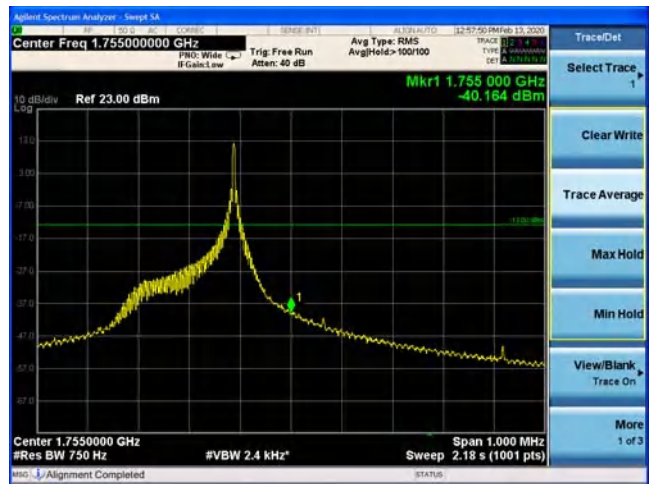

NB-IOT Band 4 BPSK 15KHz 1@0 CH-Low



NB-IOT Band 4 BPSK 15KHz 1@0 CH-High



NB-IOT Band 4 QPSK 3.75KHz 1@0 CH-Low

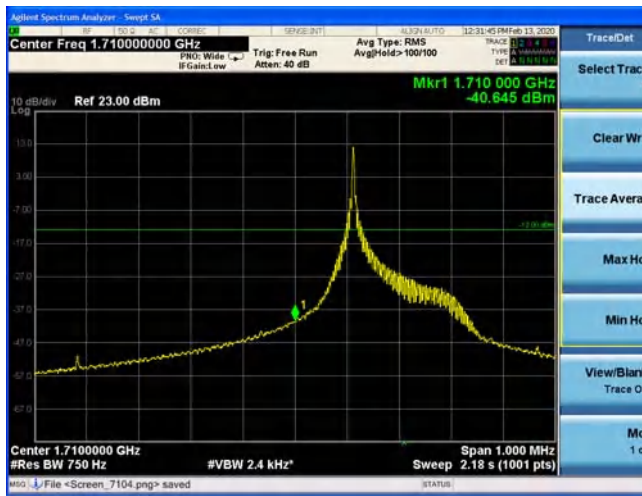

NB-IOT Band 4 QPSK 3.75KHz 1@0 CH-High

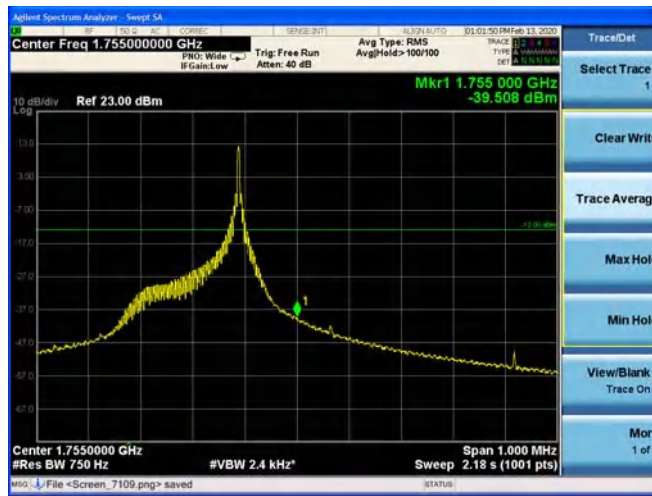



NB-IOT Band 4 QPSK 15KHz 1@0 CH-Low

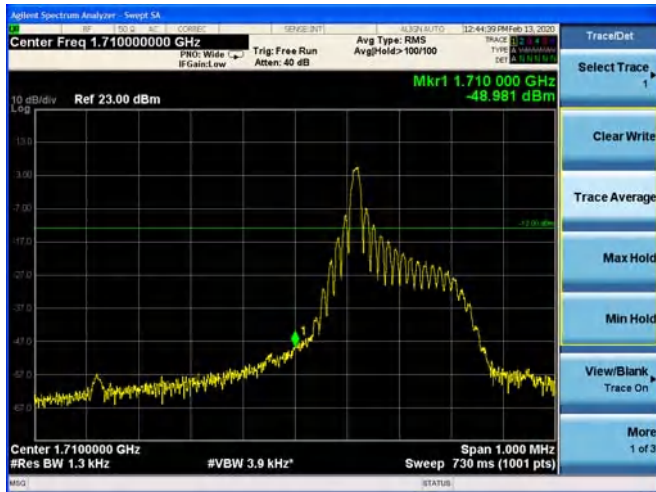

NB-IOT Band 4 QPSK 15KHz 1@0 CH-High



NB-IOT Band 4 QPSK 15KHz 12@0 CH-Low



NB-IOT Band 4 QPSK 15KHz 12@0 CH-High

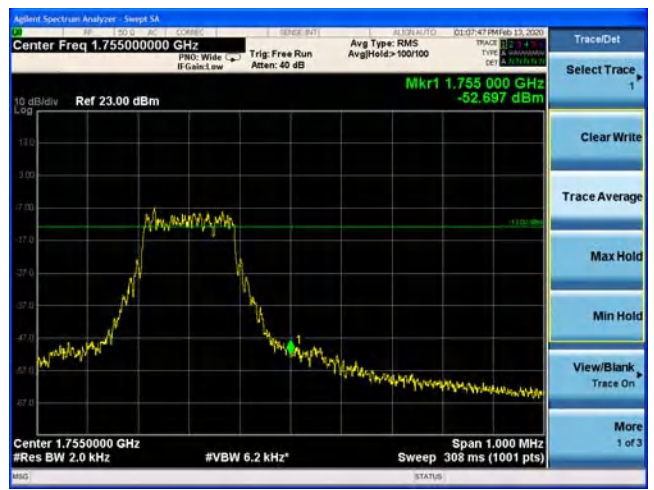



NB-IOT Band 12 BPSK 3.75KHz 1@0 CH-Low



NB-IOT Band 12 BPSK3.75KHz 1@0 CH-High



NB-IOT Band 12 BPSK 15KHz 1@0 CH-Low



NB-IOT Band 12 BPSK 15KHz 1@0 CH-High



NB-IOT Band 12 QPSK 3.75KHz 1@0 CH-Low



NB-IOT Band 12 QPSK 3.75KHz 1@0 CH-High





NB-IOT Band 12QPSK 15KHz 1@0 CH-Low



NB-IOT Band 12 QPSK 15KHz 1@0 CH-High



NB-IOT Band 12 QPSK 15KHz 12@0 CH-Low



NB-IOT Band 12 QPSK 15KHz 12@0 CH-High





NB-IOT Band 13 BPSK 3.75KHz 1@0 CH-Low

NB-IOT Band 13 BPSK 3.75KHz 1@0 CH-High

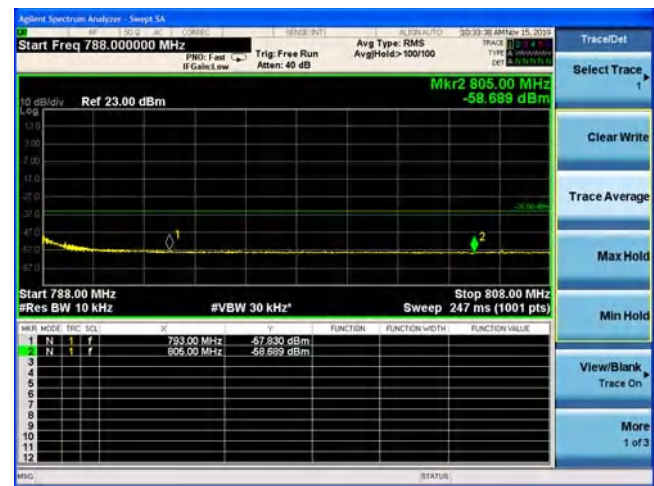
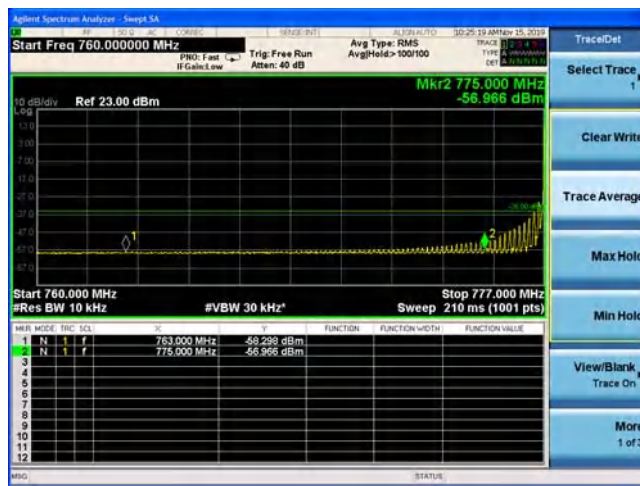
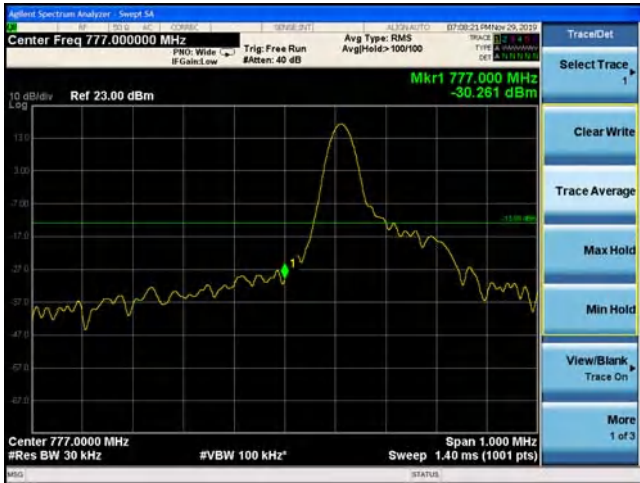



NB-IOT Band 13 BPSK 15KHz 1@0 CH-Low

NB-IOT Band 13 BPSK 15KHz 1@0 CH-High

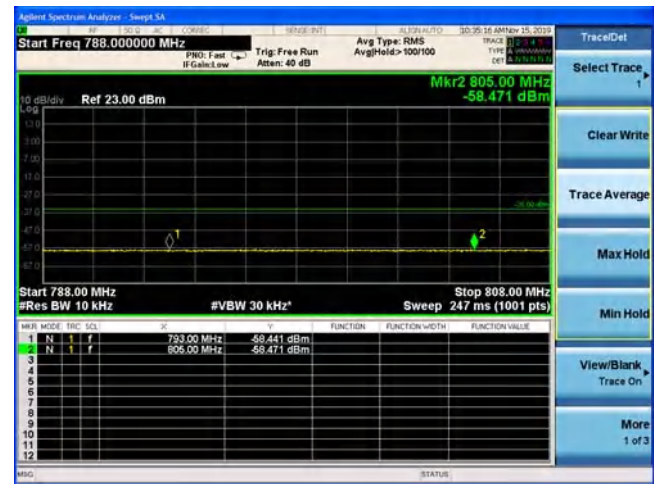
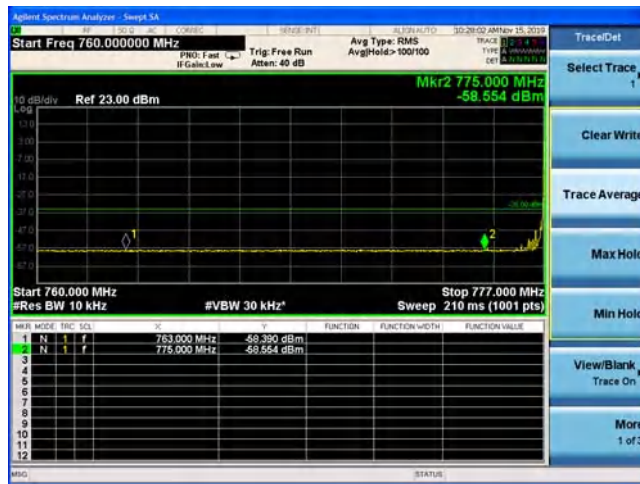



NB-IOT Band 13 QPSK 3.75KHz 1@0 CH-Low

NB-IOT Band 13 QPSK 3.75KHz 1@0 CH-High

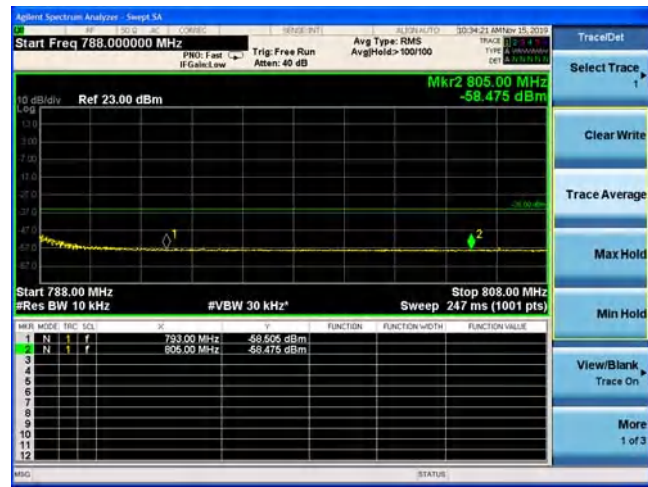
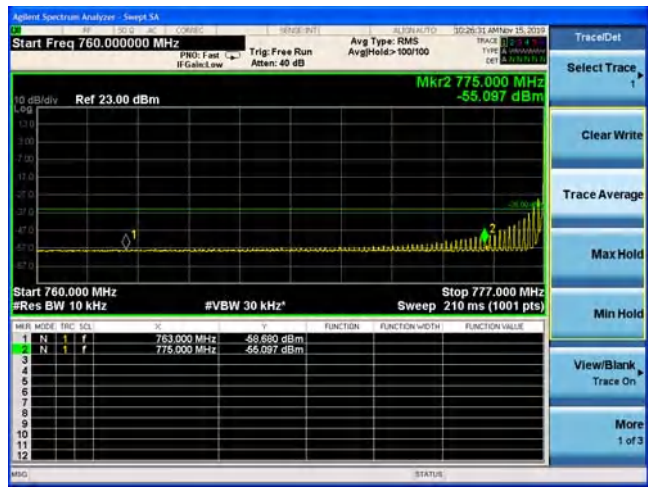
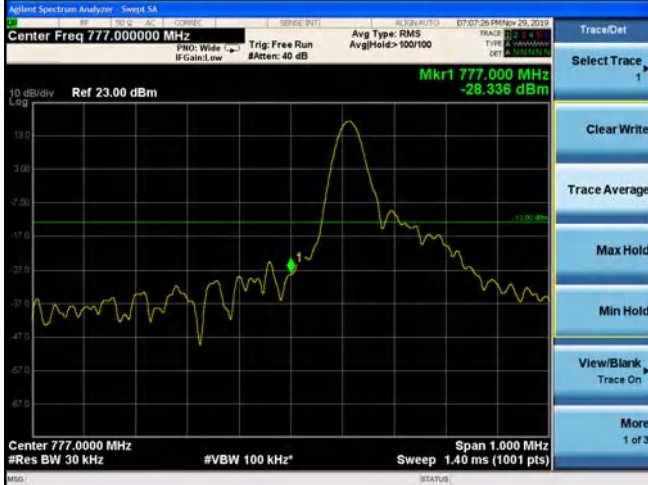



NB-IOT Band 13QPSK 15KHz 1@0 CH-Low



NB-IOT Band 13 QPSK 15KHz 1@0 CH-High

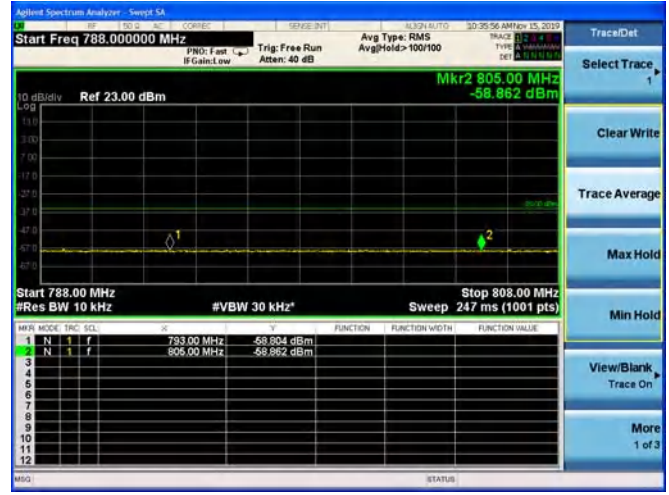
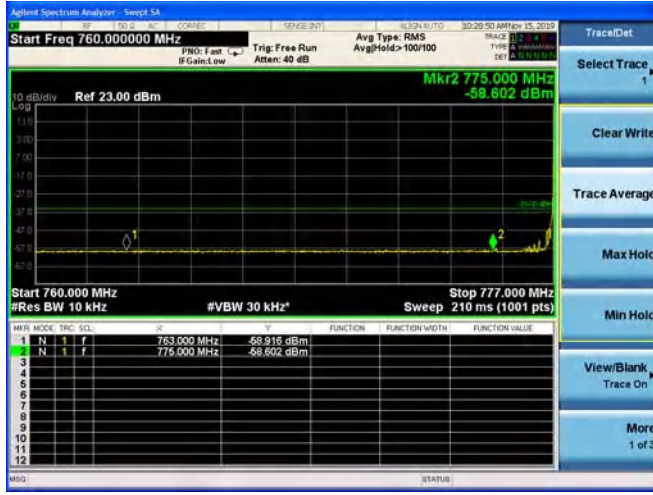



NB-IOT Band 13 QPSK 15KHz 12@0 CH-Low

NB-IOT Band 13 QPSK 15KHz 12@0 CH-High

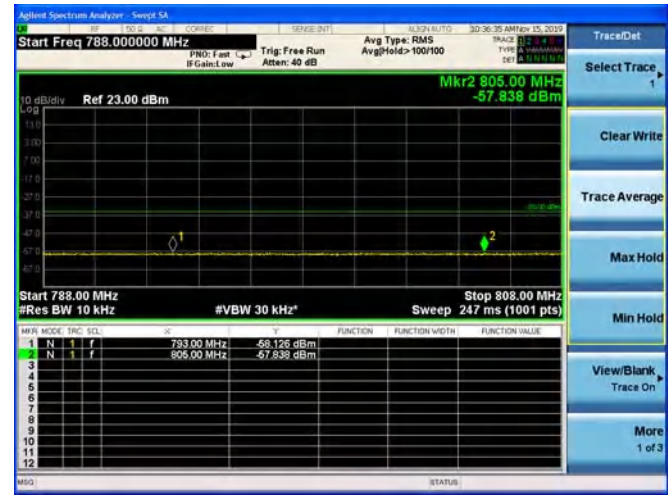



NB-IOT Band 66 BPSK 3.75KHz 1@0 CH-Low

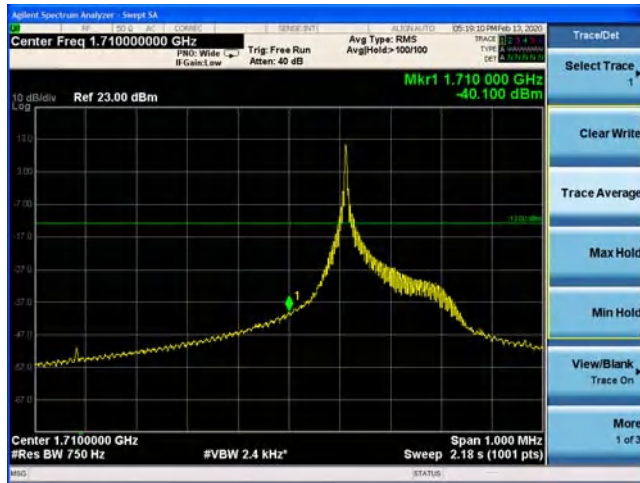

NB-IOT Band 66 BPSK 3.75KHz 1@0 CH-High

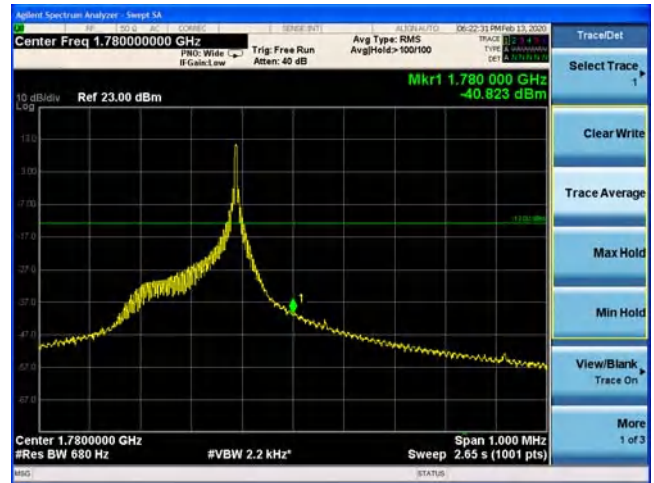

NB-IOT Band 66 BPSK 15KHz 1@0 CH-Low

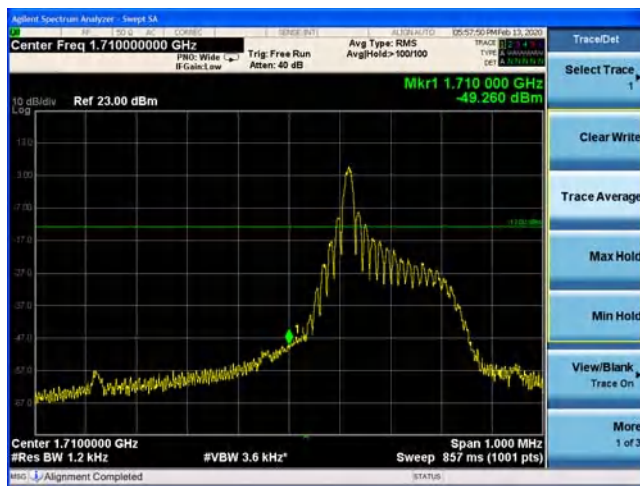

NB-IOT Band 66 BPSK 15KHz 1@0 CH-High

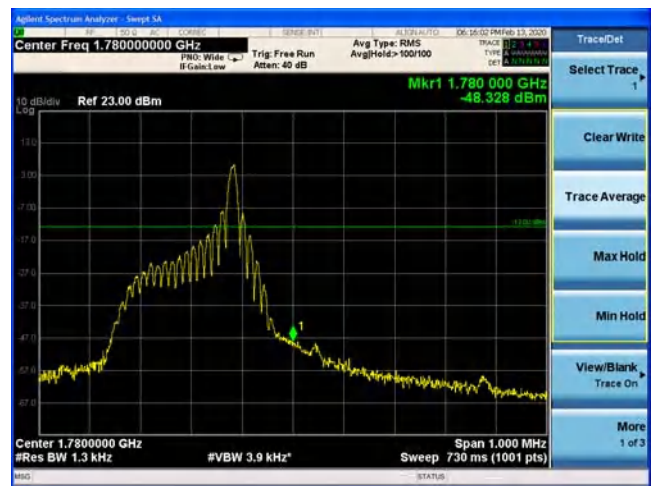

NB-IOT Band 66 QPSK 3.75KHz 1@0 CH-Low

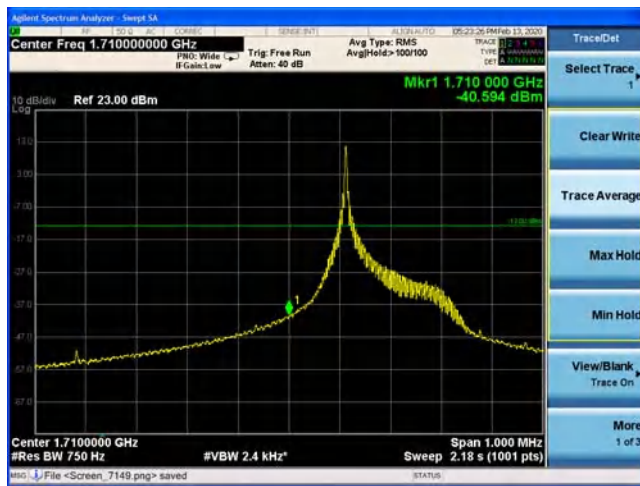

NB-IOT Band 66 QPSK 3.75KHz 1@0 CH-High

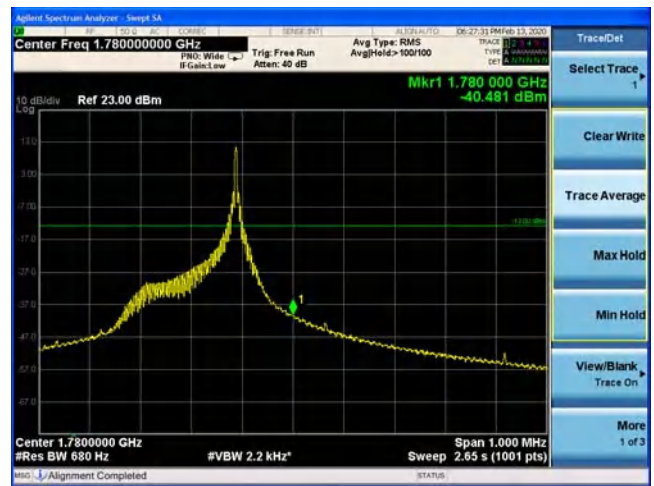



NB-IOT Band 66 QPSK 15KHz 1@0 CH-Low

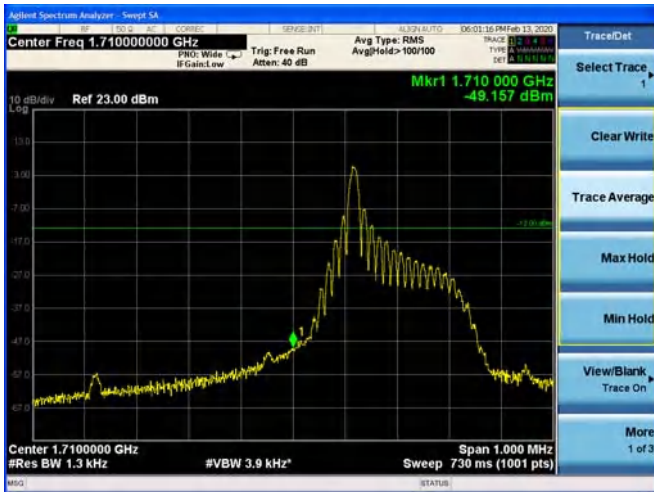

NB-IOT Band 66 QPSK 15KHz 1@0 CH-High

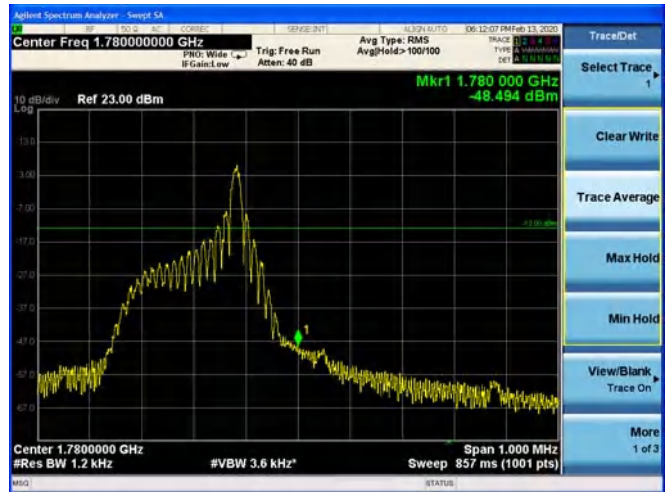

NB-IOT Band 66 QPSK 15KHz 12@0 CH-Low

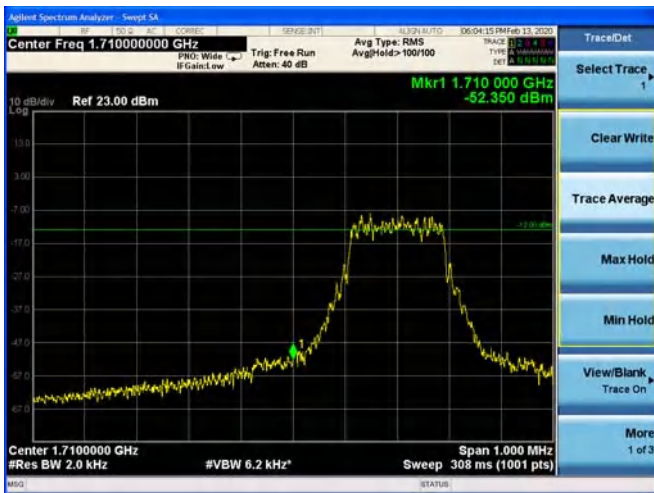

NB-IOT Band 66 QPSK 15KHz 12@0 CH-High





NB-IOT Band 71 BPSK 3.75KHz 1@0 CH-Low



NB-IOT Band 71 BPSK 3.75KHz 1@0 CH-High



NB-IOT Band 71 BPSK 15KHz 1@0 CH-Low

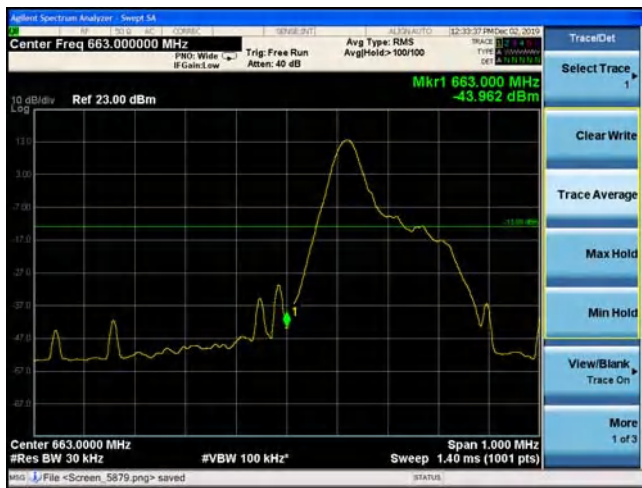

NB-IOT Band 71 BPSK 15KHz 1@0 CH-High



NB-IOT Band 71 QPSK 3.75KHz 1@0 CH-Low



NB-IOT Band 71 QPSK 3.75KHz 1@0 CH-High





NB-IOT Band 71 QPSK 15KHz 1@0 CH-Low



NB-IOT Band 71 QPSK 15KHz 1@0 CH-High



NB-IOT Band 71 QPSK 15KHz 12@0 CH-Low



NB-IOT Band 71 QPSK 15KHz 12@0 CH-High





NB-IOT Band 85 BPSK 3.75KHz 1@0 CH-Low



NB-IOT Band 85 BPSK 3.75KHz 1@0 CH-High



NB-IOT Band 85 BPSK 15KHz 1@0 CH-Low



NB-IOT Band 85 BPSK 15KHz 1@0 CH-High



NB-IOT Band 85 QPSK 3.75KHz 1@0 CH-Low



NB-IOT Band 85 QPSK 3.75KHz 1@0 CH-High





NB-IOT Band 85 QPSK 15KHz 1@0 CH-Low



NB-IOT Band 85 QPSK 15KHz 1@0 CH-High



NB-IOT Band 85 QPSK 15KHz 12@0 CH-Low



NB-IOT Band 85 QPSK 15KHz 12@0 CH-High



5.4 Peak-to-Average Power Ratio (PAPR)

Ambient condition

Temperature	Relative humidity	Pressure
23°C ~25°C	45%~50%	101.5kPa

Methods of Measurement

Measure the total peak power and record as PPK. And measure the total average power and record as PAvg. Both the peak and average power levels must be expressed in the same logarithmic units (e.g., dBm). Determine the PAPR from:

$$PAPR (dB) = PPK (dBm) - PAvg (dBm).$$

Test Setup

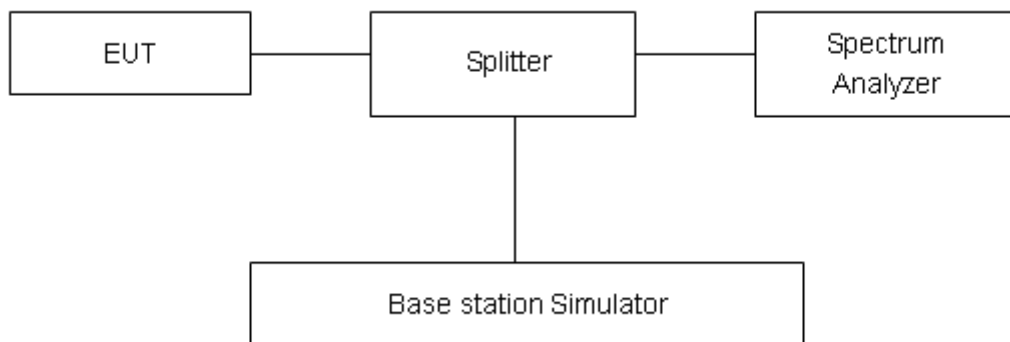

Limits

Rule Part 27.50(d)(5) Equipment employed must be authorized in accordance with the provisions of 24.51. Power measurements for transmissions by stations authorized under this section may be made either in accordance with a Commission-approved average power technique or in compliance with paragraph (d)(6) of this section. In measuring transmissions in this band using an average power technique, the peak-to-average ratio (PAR) of the transmission may not exceed 13 dB.

Measurement Uncertainty

The assessed measurement uncertainty to ensure 95% confidence level for the normal distribution is with the coverage factor $k = 2$, $U = 0.4$ dB.



Test Results

Mode	Modulation	Sub-carrier spacing (KHz)	Channel/ Frequency(MHz)	Peak-to-Average Power Ratio (PAPR)		
				Peak(dBm)	Avg(dBm)	PAPR(dB)
Band 4 Standalone	BPSK	3.75	20175/1732.5	20.94	17.05	3.89
	QPSK	3.75	20175/1732.5	20.45	17.03	3.42
	BPSK	15	20175/1732.5	20.96	14.45	6.51
	QPSK	15	20175/1732.5	20.94	14.48	6.46
Mode	Modulation	Sub-carrier spacing (KHz)	Channel/ Frequency(MHz)	Peak-to-Average Power Ratio (PAPR)		
				Peak(dBm)	Avg(dBm)	PAPR(dB)
Band 12 Standalone	BPSK	3.75	23095/707.5	22.13	18.29	3.84
	QPSK	3.75	23095/707.5	21.68	18.29	3.39
	BPSK	15	23095/707.5	21.80	15.38	6.42
	QPSK	15	23095/707.5	21.74	15.34	6.40
Mode	Modulation	Sub-carrier spacing (KHz)	Channel/ Frequency(MHz)	Peak-to-Average Power Ratio (PAPR)		
				Peak(dBm)	Avg(dBm)	PAPR(dB)
Band 13 Standalone	BPSK	3.75	23230/782	22.20	18.34	3.86
	QPSK	3.75	23230/782	21.78	18.38	3.40
	BPSK	15	23230/782	21.83	15.33	6.50
	QPSK	15	23230/782	21.79	15.33	6.46
Mode	Modulation	Sub-carrier spacing (KHz)	Channel/ Frequency(MHz)	Peak-to-Average Power Ratio (PAPR)		
				Peak(dBm)	Avg(dBm)	PAPR(dB)
Band 66 Standalone	BPSK	3.75	132322/1745	21.53	17.64	3.89
	QPSK	3.75	132322/1745	21.09	17.65	3.44
	BPSK	15	132322/1745	21.23	14.70	6.53
	QPSK	15	132322/1745	21.19	14.71	6.48
Mode	Modulation	Sub-carrier spacing (KHz)	Channel/ Frequency(MHz)	Peak-to-Average Power Ratio (PAPR)		
				Peak(dBm)	Avg(dBm)	PAPR(dB)
Band 71 Standalone	BPSK	3.75	133297/680.5	22.49	18.72	3.77
	QPSK	3.75	133297/680.5	22.09	18.74	3.35
	BPSK	15	133297/680.5	22.18	15.56	6.62
	QPSK	15	133297/680.5	22.16	15.76	6.40
Mode	Modulation	Sub-carrier spacing (KHz)	Channel/ Frequency(MHz)	Peak-to-Average Power Ratio (PAPR)		
				Peak(dBm)	Avg(dBm)	PAPR(dB)
Band 85 Standalone	BPSK	3.75	134092/707	22.29	18.47	3.82
	QPSK	3.75	134092/707	21.83	18.43	3.40
	BPSK	15	134092/707	21.98	15.52	6.46
	QPSK	15	134092/707	21.99	15.58	6.41

5.5 Frequency Stability

Ambient condition

Temperature	Relative humidity	Pressure
23°C ~25°C	45%~50%	101.5kPa

Method of Measurement

Frequency Stability (Temperature Variation)

The temperature inside the climate chamber is varied from -40°C to +85°C in 10°C step size.

(1) With all power removed, the temperature was decreased to -10°C and permitted to stabilize for three hours.

(2) Measure the carrier frequency with the test equipment in a “call mode”. These measurements should be made within 1 minute of powering up the mobile station, to prevent significant self warming.

(3) Repeat the above measurements at 10°C increments from -40°C to +85°C. Allow at least 1.5 hours at each temperature, un-powered, before making measurements.

Frequency Stability (Voltage Variation)

The frequency stability shall be measured with variation of primary supply voltage as follows:

(1) Vary primary supply voltage from 85 to 115 percent of the nominal value for other than hand carried battery equipment.

(2) For hand carried, battery powered equipment, reduce primary supply voltage to the battery-operating end point which shall be specified by the manufacturer.

This transceiver is specified to operate with an input voltage of between 2.6 V and 4.8 V, with a nominal voltage of 3.3V.

Test setup

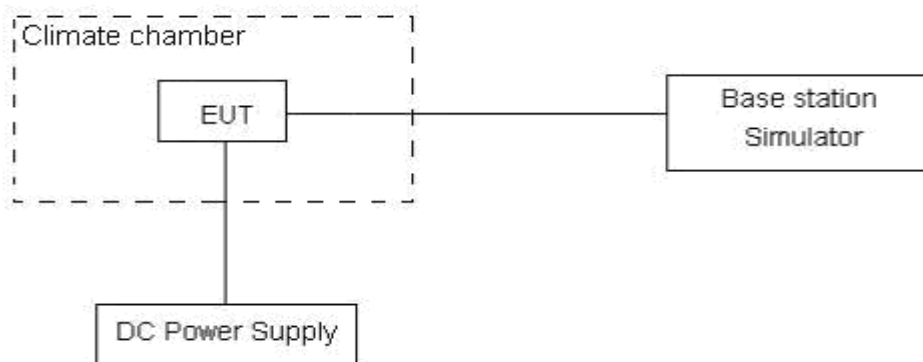

Limits

The frequency stability shall be sufficient to ensure that the fundamental emissions stay within the authorized bands of operation.

Measurement Uncertainty

The assessed measurement uncertainty to ensure 99.75% confidence level for the normal distribution is with the coverage factor $k = 3, U = 0.01\text{ppm}$.



Test Result:

NB-IOT Band4	Condition		Freq.Error (Hz)	Freq.Error (Hz)	Frequency Stability (ppm)	Frequency Stability (ppm)	Verdict	
	Sub-carrier spacing	3.75KHz						
	Temperature	Voltage	BPSK	QPSK	BPSK	QPSK		
	Normal(25°C)	Normal	10.37	11.52	0.00551	0.00613	PASS	
	Extreme(85°C)		7.71	5.71	0.00410	0.00304	PASS	
	Extreme(80°C)		13.92	3.65	0.00740	0.00194	PASS	
	Extreme(70°C)		2.83	6.14	0.00150	0.00327	PASS	
	Extreme(60°C)		11.58	1.39	0.00616	0.00074	PASS	
	Extreme(50°C)		9.52	15.74	0.00507	0.00837	PASS	
	Extreme(40°C)		16.09	7.14	0.00856	0.00380	PASS	
	Extreme(30°C)		2.93	17.98	0.00156	0.00956	PASS	
	Extreme(20°C)		14.65	11.60	0.00779	0.00617	PASS	
	Extreme(10°C)		5.18	17.31	0.00275	0.00921	PASS	
	Extreme(0°C)		15.67	4.43	0.00834	0.00236	PASS	
	Extreme(-10°C)		4.44	5.93	0.00236	0.00316	PASS	
	Extreme(-20°C)		16.72	17.15	0.00890	0.00912	PASS	
	Extreme(-30°C)		16.48	3.29	0.00877	0.00175	PASS	
	Extreme(-40°C)		10.82	8.83	0.00576	0.00470	PASS	
	25°C		LV	10.43	9.96	0.00555	0.00530	PASS
			HV	16.51	1.75	0.00878	0.00093	PASS
	Condition		Freq.Error (Hz)	Freq.Error (Hz)	Frequency Stability(ppm)	Frequency Stability(ppm)	Verdict	
	Sub-carrier spacing	15KHz						
	Temperature	Voltage	BPSK	QPSK	BPSK	QPSK		
	Normal(25°C)	Normal	12.24	2.09	0.00651	0.00111	PASS	
	Extreme(85°C)		6.34	5.87	0.00337	0.00312	PASS	
	Extreme(80°C)		1.37	3.88	0.00073	0.00206	PASS	
	Extreme(70°C)		12.80	15.24	0.00681	0.00810	PASS	
	Extreme(60°C)		2.62	8.17	0.00139	0.00434	PASS	
	Extreme(50°C)		16.19	5.67	0.00861	0.00301	PASS	
	Extreme(40°C)		10.36	6.50	0.00551	0.00346	PASS	
	Extreme(30°C)		4.78	4.91	0.00254	0.00261	PASS	
	Extreme(20°C)		15.63	8.69	0.00832	0.00462	PASS	
	Extreme(10°C)		12.25	10.09	0.00652	0.00537	PASS	
	Extreme(0°C)		16.49	11.05	0.00877	0.00588	PASS	
	Extreme(-10°C)		12.41	13.30	0.00660	0.00707	PASS	
	Extreme(-20°C)		11.80	10.95	0.00628	0.00583	PASS	
	Extreme(-30°C)		17.67	1.29	0.00940	0.00069	PASS	
	Extreme(-40°C)		3.15	3.07	0.00167	0.00163	PASS	



25°C	LV	6.23	9.50	0.00331	0.00505	PASS
	HV	8.05	14.30	0.00428	0.00761	PASS

Condition	Sub-carrier spacing	3.75KHz	Freq.Error (Hz)	Freq.Error (Hz)	Frequency Stability(ppm)		Verdict			
					Temperature					
					BPSK	QPSK				
Normal	25°C	Voltage	BPSK	QPSK	BPSK	QPSK				
			Normal(25°C)	3.04	13.59	0.00162	0.00723	PASS		
			Extreme(85°C)	6.46	14.13	0.00343	0.00752	PASS		
			Extreme(80°C)	11.44	17.12	0.00609	0.00911	PASS		
			Extreme(70°C)	3.70	9.45	0.00197	0.00503	PASS		
			Extreme(60°C)	6.78	12.11	0.00361	0.00644	PASS		
			Extreme(50°C)	1.10	6.07	0.00059	0.00323	PASS		
			Extreme(40°C)	7.58	7.01	0.00403	0.00373	PASS		
			Extreme(30°C)	1.06	7.94	0.00057	0.00422	PASS		
			Extreme(20°C)	14.94	8.70	0.00795	0.00463	PASS		
			Extreme(10°C)	5.27	13.70	0.00280	0.00729	PASS		
			Extreme(0°C)	14.94	3.30	0.00795	0.00176	PASS		
			Extreme(-10°C)	14.92	14.57	0.00794	0.00775	PASS		
			Extreme(-20°C)	16.12	15.30	0.00857	0.00814	PASS		
			Extreme(-30°C)	13.97	3.24	0.00743	0.00172	PASS		
			Extreme(-40°C)	17.91	11.77	0.00953	0.00626	PASS		
			25°C	Voltage	LV	5.25	14.44	0.00279	0.00768	PASS
					HV	15.79	1.58	0.00840	0.00084	PASS
Condition			Freq.Error (Hz)	Freq.Error (Hz)	Frequency Stability(ppm)		Verdict			
Sub-carrier spacing	15KHz	Temperature			Voltage					
					BPSK	QPSK		BPSK	QPSK	
			Normal	25°C	Voltage	BPSK	QPSK	BPSK	QPSK	
Normal(25°C)	4.77	11.94				0.00254	0.00635	PASS		
Extreme(85°C)	5.92	1.37				0.00315	0.00073	PASS		
Extreme(80°C)	1.14	5.00				0.00061	0.00266	PASS		
Extreme(70°C)	2.54	7.24				0.00135	0.00385	PASS		
Extreme(60°C)	13.04	1.00				0.00694	0.00053	PASS		
Extreme(50°C)	9.01	13.34				0.00479	0.00709	PASS		
Extreme(40°C)	15.21	6.45				0.00809	0.00343	PASS		
Extreme(30°C)	5.25	5.74				0.00279	0.00305	PASS		
Extreme(20°C)	9.24	10.82				0.00492	0.00576	PASS		
Extreme(10°C)	14.89	7.43				0.00792	0.00395	PASS		
Extreme(0°C)	16.01	11.46				0.00852	0.00610	PASS		
Extreme(-10°C)	11.34	10.78				0.00603	0.00573	PASS		



	Extreme(-20°C)		6.67	12.73	0.00355	0.00677	PASS
	Extreme(-30°C)		17.28	15.17	0.00919	0.00807	PASS
	Extreme(-40°C)		3.87	8.52	0.00206	0.00453	PASS
	25°C	LV	4.93	14.74	0.00262	0.00784	PASS
		HV	2.56	17.37	0.00136	0.00924	PASS

	Condition		Freq.Error (Hz)	Freq.Error (Hz)	Frequency Stability(ppm)	Frequency Stability(ppm)	Verdict	
	Sub-carrier spacing	3.75KHz						
	Temperature	Voltage	BPSK	QPSK	BPSK	QPSK		
NB-IOT Band13	Normal(25°C)	Normal	12.65	15.89	0.00673	0.00845	PASS	
	Extreme(85°C)		10.31	9.22	0.00549	0.00490	PASS	
	Extreme(80°C)		12.20	8.07	0.00649	0.00429	PASS	
	Extreme(70°C)		15.05	7.77	0.00800	0.00413	PASS	
	Extreme(60°C)		16.54	13.24	0.00880	0.00704	PASS	
	Extreme(50°C)		2.75	13.88	0.00146	0.00739	PASS	
	Extreme(40°C)		10.53	2.86	0.00560	0.00152	PASS	
	Extreme(30°C)		6.18	7.19	0.00329	0.00382	PASS	
	Extreme(20°C)		14.08	3.41	0.00749	0.00181	PASS	
	Extreme(10°C)		15.73	3.34	0.00837	0.00178	PASS	
	Extreme(0°C)		12.50	4.51	0.00665	0.00240	PASS	
	Extreme(-10°C)		11.21	12.40	0.00596	0.00659	PASS	
	Extreme(-20°C)		1.74	16.97	0.00093	0.00903	PASS	
	Extreme(-30°C)		14.03	7.86	0.00746	0.00418	PASS	
	Extreme(-40°C)		6.99	8.16	0.00372	0.00434	PASS	
	25°C		LV	1.05	15.16	0.00056	0.00806	PASS
			HV	5.06	8.59	0.00269	0.00457	PASS
		Condition		Freq.Error (Hz)	Freq.Error (Hz)	Frequency Stability(ppm)	Frequency Stability(ppm)	Verdict
		Sub-carrier spacing	15KHz					
		Temperature	Voltage	BPSK	QPSK	BPSK	QPSK	
	Normal(25°C)	Normal	14.03	8.27	0.00746	0.00440	PASS	
	Extreme(85°C)		4.67	4.07	0.00249	0.00217	PASS	
	Extreme(80°C)		8.29	1.60	0.00441	0.00085	PASS	
	Extreme(70°C)		14.73	7.99	0.00784	0.00425	PASS	
	Extreme(60°C)		1.49	11.98	0.00079	0.00637	PASS	
	Extreme(50°C)		2.28	6.63	0.00121	0.00352	PASS	
	Extreme(40°C)		13.89	14.40	0.00739	0.00766	PASS	
	Extreme(30°C)		13.26	3.00	0.00706	0.00160	PASS	
	Extreme(20°C)		9.04	2.15	0.00481	0.00114	PASS	



	Extreme(10°C)		2.34	15.31	0.00125	0.00815	PASS
	Extreme(0°C)		2.42	5.76	0.00129	0.00306	PASS
	Extreme(-10°C)		5.75	2.49	0.00306	0.00133	PASS
	Extreme(-20°C)		11.68	14.60	0.00621	0.00777	PASS
	Extreme(-30°C)		1.44	4.07	0.00077	0.00216	PASS
	Extreme(-40°C)		13.70	7.66	0.00729	0.00408	PASS
	25°C		LV	13.72	1.46	0.00730	0.00078
HV		2.34	8.49	0.00124	0.00451	PASS	

	Condition		Freq.Error (Hz)	Freq.Error (Hz)	Frequency Stability(ppm)	Frequency Stability(ppm)	Verdict	
	Sub-carrier spacing	3.75KHz						
	Temperature	Voltage	BPSK	QPSK	BPSK	QPSK		
NB-IOT Band66	Normal(25°C)	Normal	11.22	16.60	0.00597	0.00883	PASS	
	Extreme(85°C)		11.82	9.45	0.00629	0.00503	PASS	
	Extreme(80°C)		3.55	5.84	0.00189	0.00311	PASS	
	Extreme(70°C)		14.34	12.57	0.00763	0.00668	PASS	
	Extreme(60°C)		17.33	15.77	0.00922	0.00839	PASS	
	Extreme(50°C)		15.92	1.58	0.00847	0.00084	PASS	
	Extreme(40°C)		17.47	5.96	0.00930	0.00317	PASS	
	Extreme(30°C)		1.88	9.14	0.00100	0.00486	PASS	
	Extreme(20°C)		10.68	7.18	0.00568	0.00382	PASS	
	Extreme(10°C)		7.80	2.46	0.00415	0.00131	PASS	
	Extreme(0°C)		15.91	2.47	0.00846	0.00131	PASS	
	Extreme(-10°C)		11.80	4.78	0.00628	0.00254	PASS	
	Extreme(-20°C)		13.08	8.01	0.00695	0.00426	PASS	
	Extreme(-30°C)		5.99	8.40	0.00319	0.00447	PASS	
	Extreme(-40°C)		6.21	11.40	0.00330	0.00606	PASS	
	25°C		LV	6.02	3.27	0.00320	0.00174	PASS
			HV	16.05	2.11	0.00854	0.00112	PASS
			Condition		Freq.Error (Hz)	Freq.Error (Hz)	Frequency Stability(ppm)	Frequency Stability(ppm)
	Sub-carrier spacing	15KHz						
	Temperature	Voltage	BPSK	QPSK	BPSK	QPSK		
	Normal(25°C)	Normal	10.04	15.80	0.00534	0.00841	PASS	
	Extreme(85°C)		12.24	17.23	0.00651	0.00917	PASS	
	Extreme(80°C)		10.65	6.84	0.00567	0.00364	PASS	
	Extreme(70°C)		17.24	17.03	0.00917	0.00906	PASS	
	Extreme(60°C)		7.45	16.26	0.00396	0.00865	PASS	
	Extreme(50°C)		14.50	15.19	0.00771	0.00808	PASS	



	Extreme(40°C)		8.66	7.20	0.00461	0.00383	PASS
	Extreme(30°C)		6.16	17.68	0.00328	0.00940	PASS
	Extreme(20°C)		2.26	2.29	0.00120	0.00122	PASS
	Extreme(10°C)		1.66	9.99	0.00088	0.00531	PASS
	Extreme(0°C)		14.92	14.03	0.00793	0.00746	PASS
	Extreme(-10°C)		16.74	2.59	0.00890	0.00138	PASS
	Extreme(-20°C)		6.13	8.03	0.00326	0.00427	PASS
	Extreme(-30°C)		8.55	7.44	0.00455	0.00396	PASS
	Extreme(-40°C)		10.84	5.35	0.00577	0.00285	PASS
	25°C		LV	2.09	13.47	0.00111	0.00717
HV		2.56	2.23	0.00136	0.00119	PASS	

	Condition		Freq.Error (Hz)	Freq.Error (Hz)	Frequency Stability(ppm)	Frequency Stability(ppm)	Verdict		
	Sub-carrier spacing	3.75KHz							
	Temperature	Voltage	BPSK	QPSK	BPSK	QPSK			
NB-IOT Band71	Normal(25°C)	Normal	10.75	5.03	0.00572	0.00267	PASS		
	Extreme(85°C)		10.00	14.30	0.00532	0.00761	PASS		
	Extreme(80°C)		13.75	4.65	0.00731	0.00247	PASS		
	Extreme(70°C)		10.95	5.08	0.00582	0.00270	PASS		
	Extreme(60°C)		3.24	3.59	0.00173	0.00191	PASS		
	Extreme(50°C)		9.02	12.35	0.00480	0.00657	PASS		
	Extreme(40°C)		7.49	2.52	0.00398	0.00134	PASS		
	Extreme(30°C)		16.99	5.60	0.00904	0.00298	PASS		
	Extreme(20°C)		14.29	10.67	0.00760	0.00568	PASS		
	Extreme(10°C)		2.24	11.97	0.00119	0.00637	PASS		
	Extreme(0°C)		8.99	10.41	0.00478	0.00554	PASS		
	Extreme(-10°C)		12.32	6.40	0.00656	0.00340	PASS		
	Extreme(-20°C)		5.04	7.57	0.00268	0.00402	PASS		
	Extreme(-30°C)		14.31	15.37	0.00761	0.00818	PASS		
	Extreme(-40°C)		4.01	17.38	0.00214	0.00924	PASS		
	25°C		LV	9.77	14.33	0.00519	0.00762	PASS	
			HV	13.44	8.80	0.00715	0.00468	PASS	
			Condition		Freq.Error (Hz)	Freq.Error (Hz)	Frequency Stability(ppm)	Frequency Stability(ppm)	Verdict
			Sub-carrier spacing	15KHz					
			Temperature	Voltage	BPSK	QPSK	BPSK	QPSK	
	Normal(25°C)	Normal	15.52	12.48	0.00826	0.00664	PASS		
	Extreme(85°C)		14.67	7.21	0.00780	0.00383	PASS		
	Extreme(80°C)		17.08	11.52	0.00908	0.00613	PASS		



	Extreme(70°C)		1.68	8.90	0.00089	0.00474	PASS
	Extreme(60°C)		2.94	11.08	0.00156	0.00589	PASS
	Extreme(50°C)		10.18	7.53	0.00541	0.00401	PASS
	Extreme(40°C)		4.12	16.73	0.00219	0.00890	PASS
	Extreme(30°C)		7.84	16.27	0.00417	0.00865	PASS
	Extreme(20°C)		15.24	12.68	0.00811	0.00674	PASS
	Extreme(10°C)		7.67	6.25	0.00408	0.00333	PASS
	Extreme(0°C)		4.53	8.62	0.00241	0.00459	PASS
	Extreme(-10°C)		16.18	16.55	0.00861	0.00880	PASS
	Extreme(-20°C)		2.53	14.74	0.00135	0.00784	PASS
	Extreme(-30°C)		5.09	1.57	0.00271	0.00084	PASS
	Extreme(-40°C)		10.56	17.32	0.00562	0.00921	PASS
	25°C		LV	15.29	14.37	0.00814	0.00764
HV		13.41	3.18	0.00713	0.00169	PASS	

NB-IOT Band85	Condition		Freq.Error (Hz)	Freq.Error (Hz)	Frequency Stability(ppm)	Frequency Stability(ppm)	Verdict	
	Sub-carrier spacing	3.75KHz						
	Temperature	Voltage	BPSK	QPSK	BPSK	QPSK		
	Normal(25°C)	Normal	2.80	12.09	0.00149	0.00643	PASS	
	Extreme(85°C)		4.16	10.31	0.00221	0.00548	PASS	
	Extreme(80°C)		8.04	10.66	0.00428	0.00567	PASS	
	Extreme(70°C)		1.56	9.15	0.00083	0.00486	PASS	
	Extreme(60°C)		1.95	17.67	0.00104	0.00940	PASS	
	Extreme(50°C)		6.44	13.44	0.00342	0.00715	PASS	
	Extreme(40°C)		13.67	8.06	0.00727	0.00429	PASS	
	Extreme(30°C)		1.52	3.73	0.00081	0.00198	PASS	
	Extreme(20°C)		2.73	9.50	0.00145	0.00505	PASS	
	Extreme(10°C)		15.59	2.36	0.00829	0.00126	PASS	
	Extreme(0°C)		13.28	13.98	0.00706	0.00744	PASS	
	Extreme(-10°C)		8.76	9.97	0.00466	0.00530	PASS	
	Extreme(-20°C)		10.65	15.79	0.00566	0.00840	PASS	
	Extreme(-30°C)		8.43	12.35	0.00449	0.00657	PASS	
	Extreme(-40°C)		13.84	6.48	0.00736	0.00345	PASS	
	25°C		LV	14.01	8.56	0.00745	0.00455	PASS
			HV	14.96	4.66	0.00796	0.00248	PASS
	Condition		Freq.Error (Hz)	Freq.Error (Hz)	Frequency Stability(ppm)	Frequency Stability(ppm)	Verdict	
	Sub-carrier spacing	15KHz						
	Temperature	Voltage	BPSK	QPSK	BPSK	QPSK		



	Normal(25℃)	Normal	2.60	2.02	0.00138	0.00107	PASS	
	Extreme(85℃)		1.25	7.55	0.00066	0.00402	PASS	
	Extreme(80℃)		2.59	3.77	0.00138	0.00200	PASS	
	Extreme(70℃)		7.37	16.37	0.00392	0.00871	PASS	
	Extreme(60℃)		6.66	7.63	0.00354	0.00406	PASS	
	Extreme(50℃)		4.57	3.11	0.00243	0.00166	PASS	
	Extreme(40℃)		2.05	8.79	0.00109	0.00467	PASS	
	Extreme(30℃)		4.84	7.39	0.00258	0.00393	PASS	
	Extreme(20℃)		12.20	17.20	0.00649	0.00915	PASS	
	Extreme(10℃)		3.65	6.14	0.00194	0.00326	PASS	
	Extreme(0℃)		5.15	3.76	0.00274	0.00200	PASS	
	Extreme(-10℃)		14.50	17.66	0.00771	0.00939	PASS	
	Extreme(-20℃)		5.46	17.04	0.00290	0.00906	PASS	
	Extreme(-30℃)		1.01	5.54	0.00054	0.00295	PASS	
	Extreme(-40℃)		1.11	7.12	0.00059	0.00379	PASS	
	25℃	LV		9.83	12.07	0.00523	0.00642	PASS
		HV		7.26	15.96	0.00386	0.00849	PASS

5.6 Spurious Emissions at Antenna Terminals

Ambient condition

Temperature	Relative humidity	Pressure
23°C ~25°C	45%~50%	101.5kPa

Method of Measurement

The EUT was connected to Spectrum Analyzer and Base Station Simulator via power Splitter. The measurement is carried out using a spectrum analyzer. The spectrum analyzer scans from 9kHz to the 10th harmonic of the carrier. The peak detector is used.

RBW is set to 100kHz, VBW is set to 300kHz for 30MHz~1GHz

RBW is set to 1MHz, VBW is set to 3MHz for above 1GHz, Sweep is set to ATUO.

Of those disturbances below (limit – 20 dB), the mark is not required for the EUT.

The modulation mode and RB allocation refer to section 5.1, using the maximum output power configuration.

Test setup

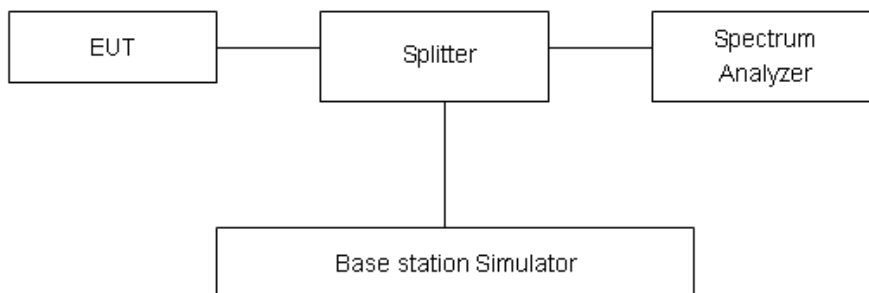

Limits

Rule Part 27.53(h) specifies that “for operations in the 1695-1710 MHz, 1710-1755 MHz, 1755-1780 MHz, 1915-1920 MHz, 1995-2000 MHz, 2000-2020 MHz, 2110-2155 MHz, 2155-2180 MHz, and 2180-2200 bands, the power of any emission outside a licensee's frequency block shall be attenuated below the transmitter power (P) in watts by at least $43 + 10 \log_{10} (P)$ dB..”

Rule Part 27.53 (g) For operations in the 600 MHz band and the 698-746 MHz band, the power of any emission outside a licensee's frequency band(s) of operation shall be attenuated below the transmitter power (P) within the licensed band(s) of operation, measured in watts, by at least $43 + 10 \log (P)$ dB. Compliance with this provision is based on the use of measurement instrumentation employing a resolution bandwidth of 100 kilohertz or greater. However, in the 100 kilohertz bands immediately outside and adjacent to a licensee's frequency block, a resolution bandwidth of at least 30 kHz may be employed.

Rule Part 27.53(f) For operations in the 746-758 MHz, 775-788 MHz, and 805-806 MHz bands, emissions in the band 1559-1610 MHz shall be limited to -70 dBW/MHz equivalent isotropically



radiated power (EIRP) for wideband signals, and -80 dBW EIRP for discrete emissions of less than 700 Hz bandwidth. For the purpose of equipment authorization, a transmitter shall be tested with an antenna that is representative of the type that will be used with the equipment in normal operation.

Part 27.53(a)/(h)/(g) Limit		-13 dBm
Part 27.53(f) Limit	Limit out of the band 1559-1610 MHz	-13 dBm
	Limit in the band 1559-1610 MHz	-40 dBm
Part 27.53(m) Limit		-25 dBm

Measurement Uncertainty

The assessed measurement uncertainty to ensure 99.75% confidence level for the normal distribution is with the coverage factor $k = 1.96$.

Frequency	Uncertainty
9kHz-1GHz	0.684 dB
1GHz-27GHz	1.407 dB



Test Result

Sweep the whole frequency band through the range from 9kHz to the 10th harmonic of the carrier, the emissions more than 20 dB below the limit are not reported.

The signal beyond the limit is carrier.

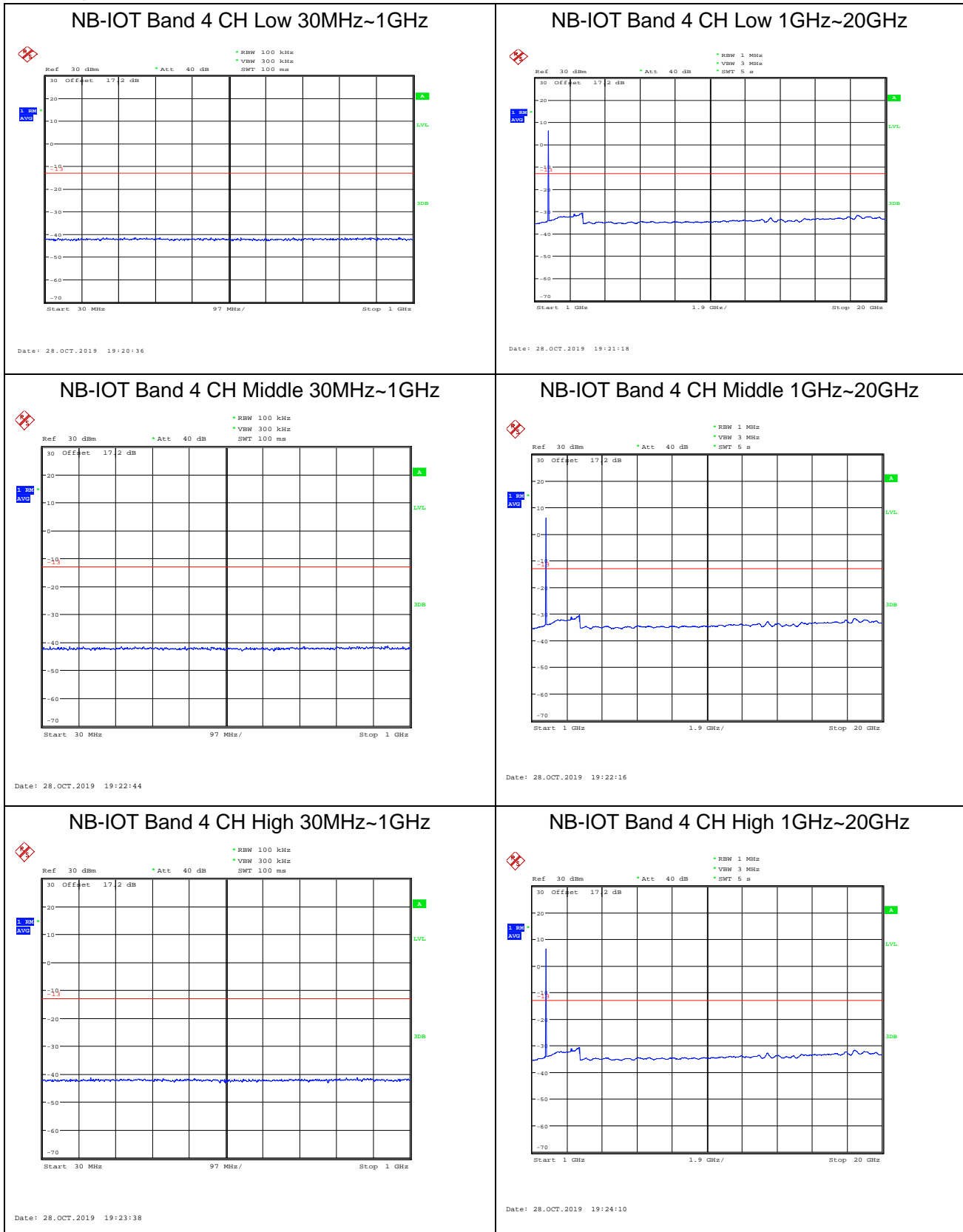



NB-IOT Band 12 CH Low 30MHz~1GHz

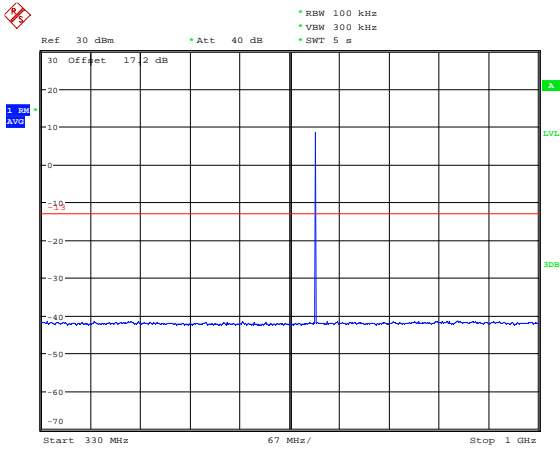

Date: 28.OCT.2019 19:37:30

NB-IOT Band 12 CH Low 1GHz~9GHz

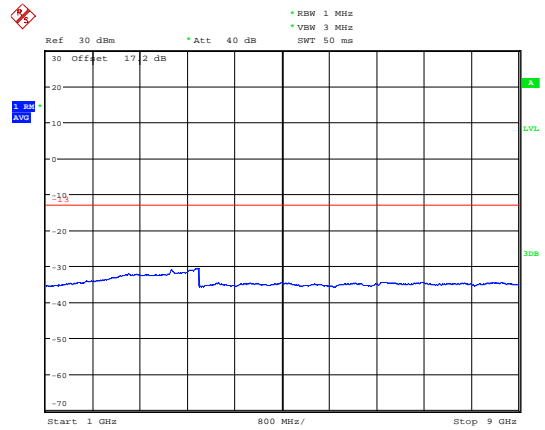

Date: 28.OCT.2019 19:37:56

NB-IOT Band 12 CH Middle 30MHz~1GHz

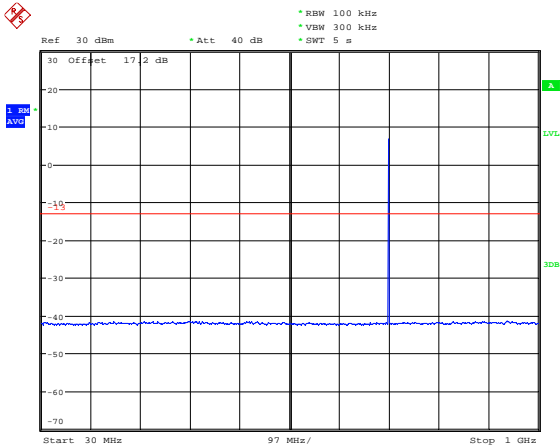

Date: 28.OCT.2019 19:39:58

NB-IOT Band 12 CH Middle 1GHz~9GHz

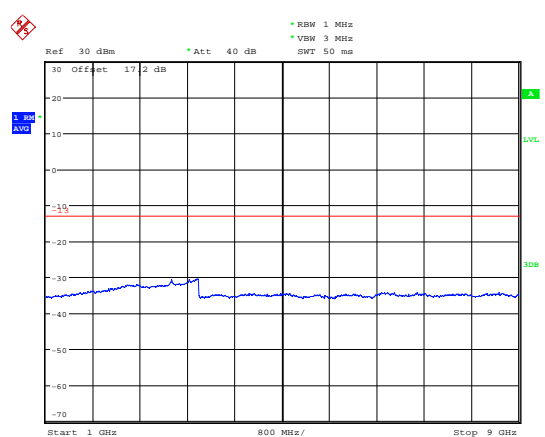

Date: 28.OCT.2019 19:38:49

NB-IOT Band 12 CH High 30MHz~1GHz

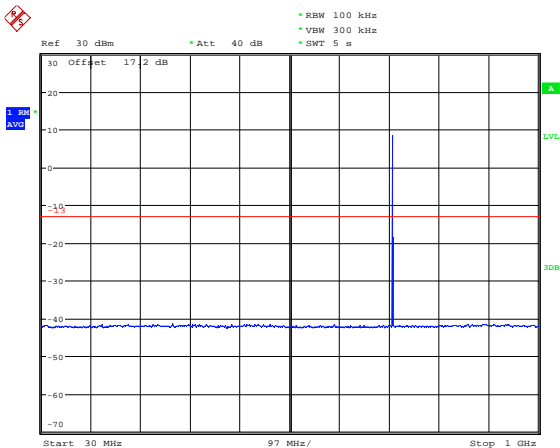

Date: 28.OCT.2019 19:41:35

NB-IOT Band 12 CH High 1GHz~9GHz

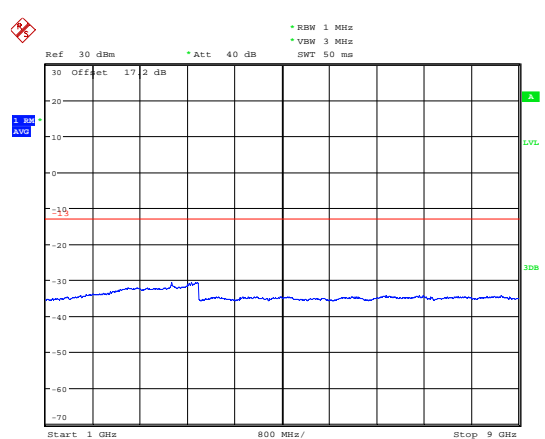

Date: 28.OCT.2019 19:42:05



NB-IOT Band 13 CH Low 30MHz~1GHz

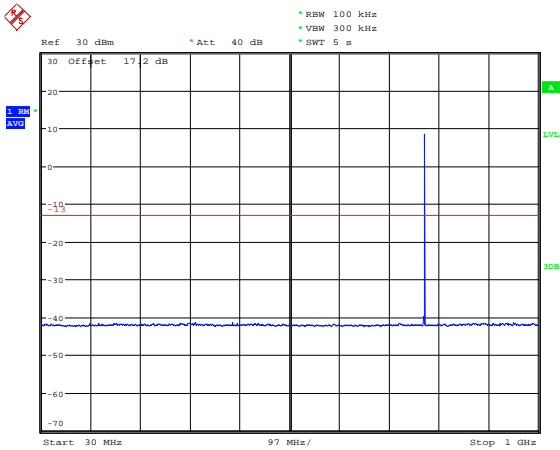

Date: 28.OCT.2019 19:45:00

NB-IOT Band 13 CH Low 1GHz~9GHz

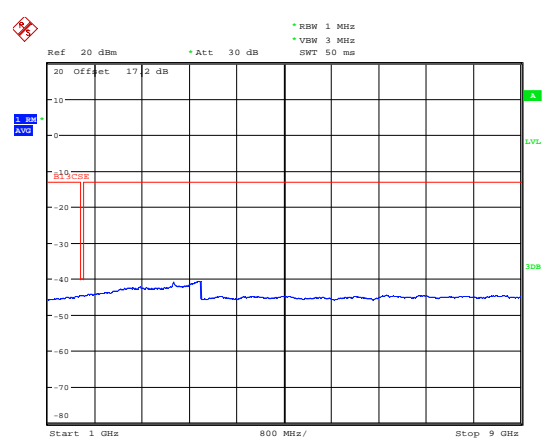

Date: 28.OCT.2019 21:01:46

NB-IOT Band 13 CH Middle 30MHz~1GHz

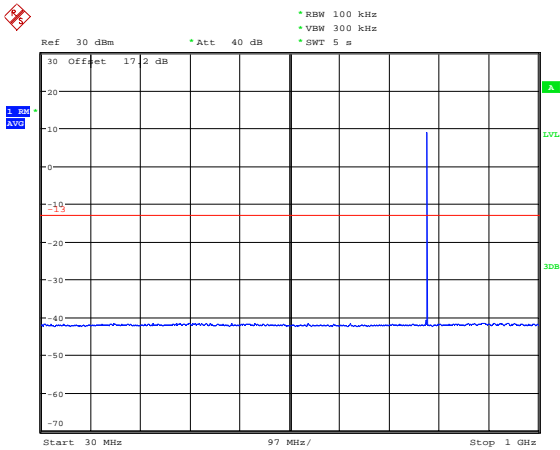

Date: 28.OCT.2019 19:46:53

NB-IOT Band 13 CH Middle 1GHz~9GHz

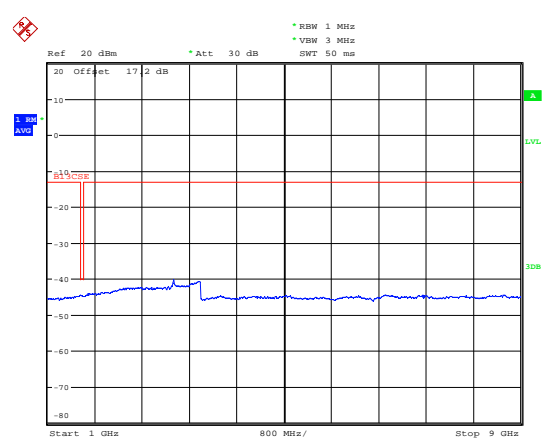

Date: 28.OCT.2019 21:03:01

NB-IOT Band 13 CH High 30MHz~1GHz

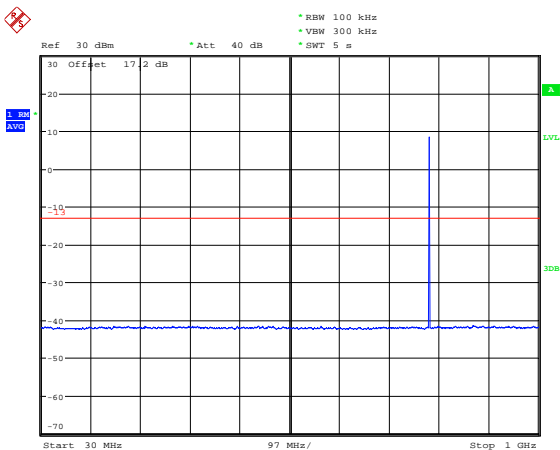

Date: 28.OCT.2019 19:48:41

NB-IOT Band 13 CH High 1GHz~9GHz

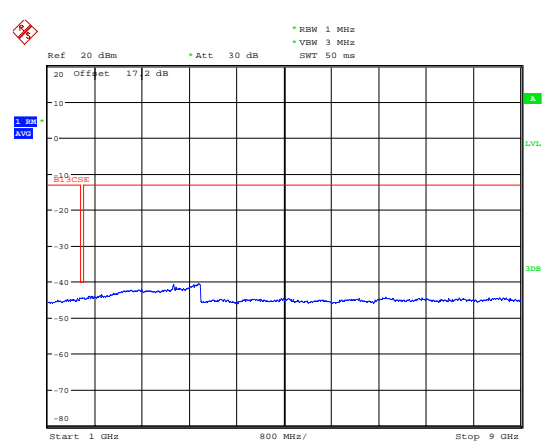

Date: 28.OCT.2019 21:03:42



NB-IOT Band 66 CH Low 30MHz~1GHz

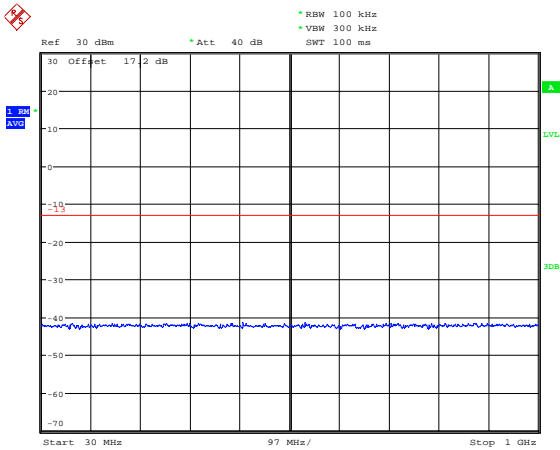

Date: 28.OCT.2019 20:26:29

NB-IOT Band 66 CH Low 1GHz~20GHz

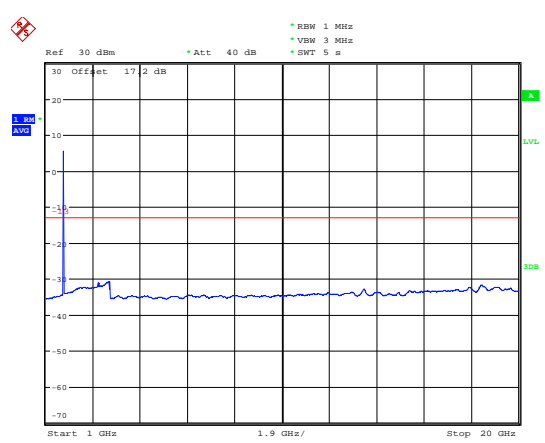

Date: 28.OCT.2019 20:27:07

NB-IOT Band 66 CH Middle 30MHz~1GHz

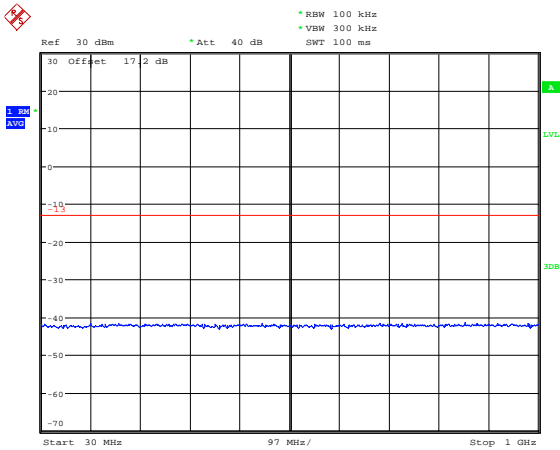

Date: 28.OCT.2019 20:29:15

NB-IOT Band 66 CH Middle 1GHz~20GHz

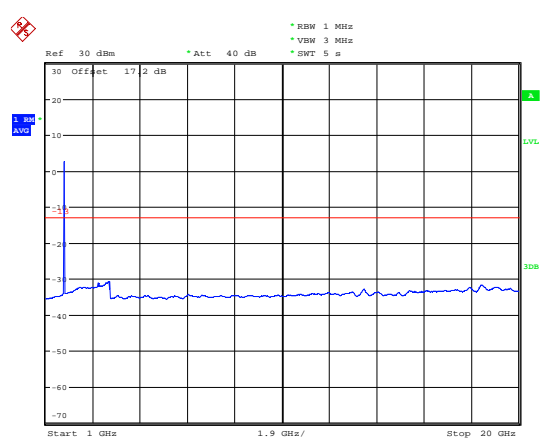

Date: 28.OCT.2019 20:28:27

NB-IOT Band 66 CH High 30MHz~1GHz

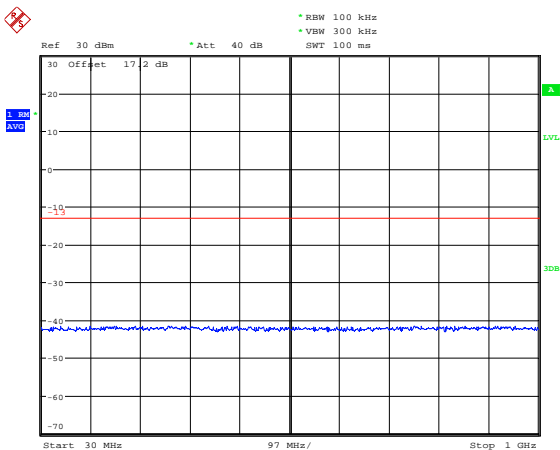

Date: 28.OCT.2019 20:30:34

NB-IOT Band 66 CH High 1GHz~20GHz

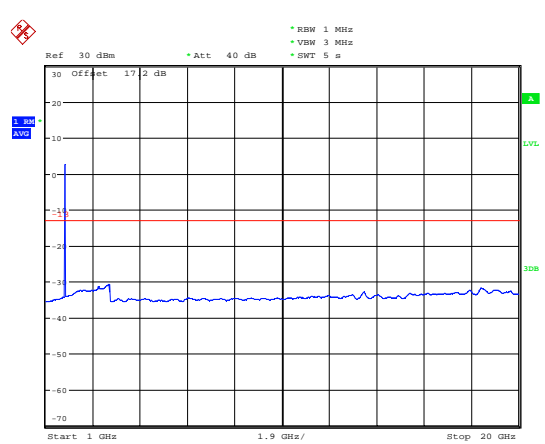

Date: 28.OCT.2019 20:31:08



NB-IOT Band 71 CH Low 30MHz~1GHz

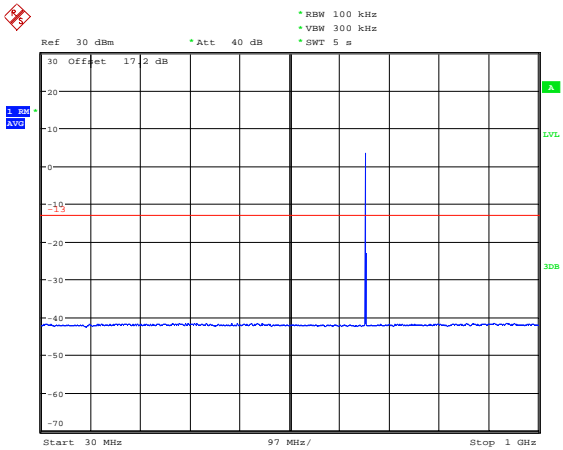

Date: 28.OCT.2019 20:37:42

NB-IOT Band 71 CH Low 1GHz~9GHz

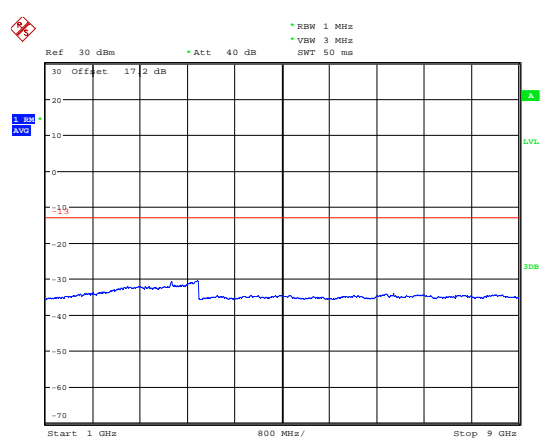

Date: 28.OCT.2019 20:38:08

NB-IOT Band 71 CH Middle 30MHz~1GHz

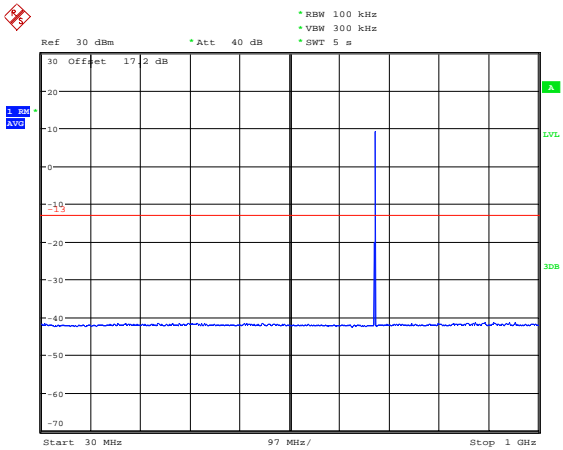

Date: 28.OCT.2019 20:40:30

NB-IOT Band 71 CH Middle 1GHz~9GHz

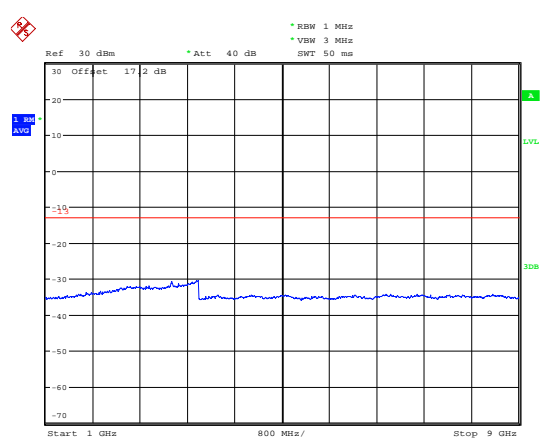

Date: 28.OCT.2019 20:39:39

NB-IOT Band 71 CH High 30MHz~1GHz

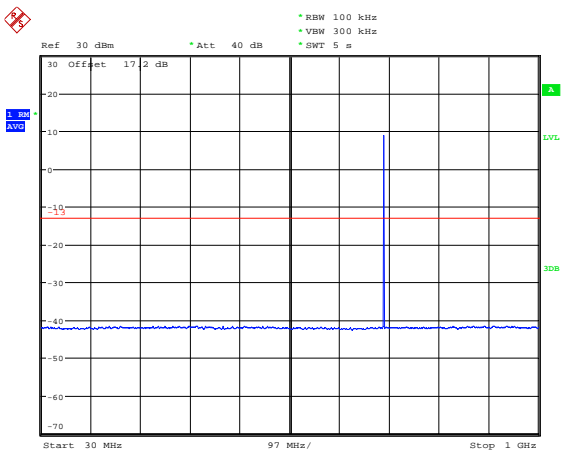

Date: 28.OCT.2019 20:43:20

NB-IOT Band 71 CH High 1GHz~9GHz

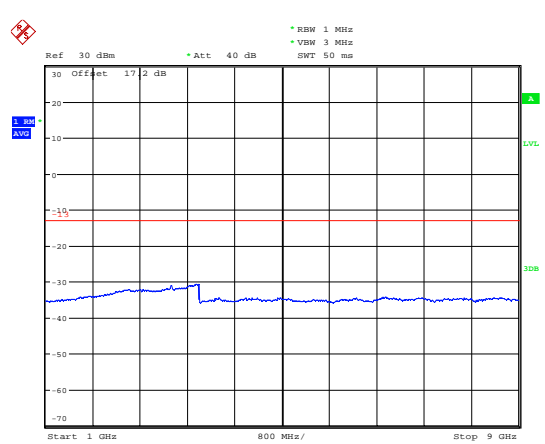

Date: 28.OCT.2019 20:43:43



NB-IOT Band 85 CH Low 30MHz~1GHz

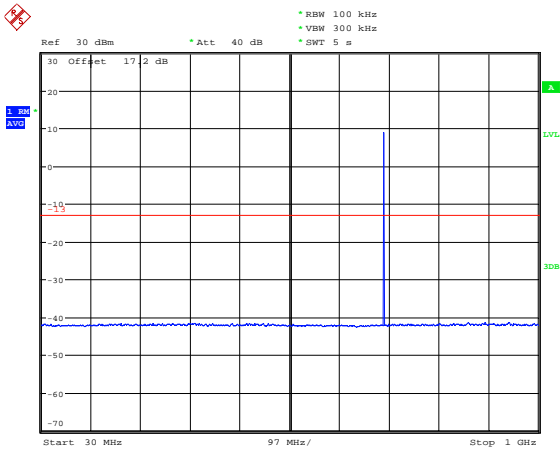

Date: 28.OCT.2019 20:47:57

NB-IOT Band 85 CH Low 1GHz~9GHz

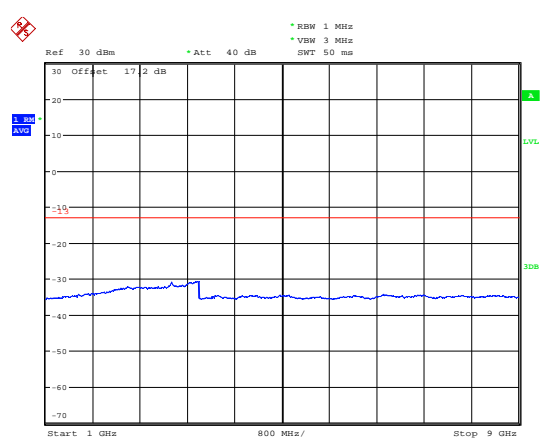

Date: 28.OCT.2019 20:48:19

NB-IOT Band 85 CH Middle 30MHz~1GHz

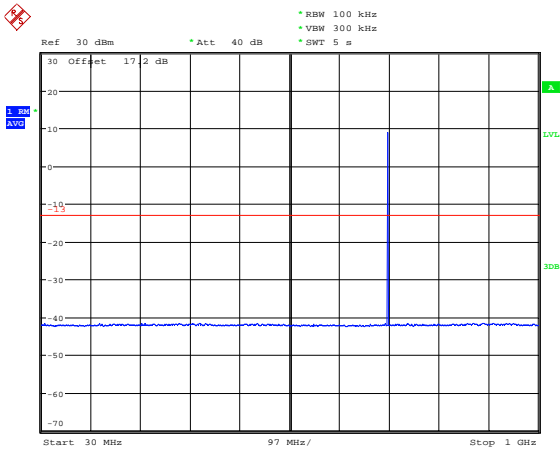

Date: 28.OCT.2019 20:49:27

NB-IOT Band 85 CH Middle 1GHz~9GHz

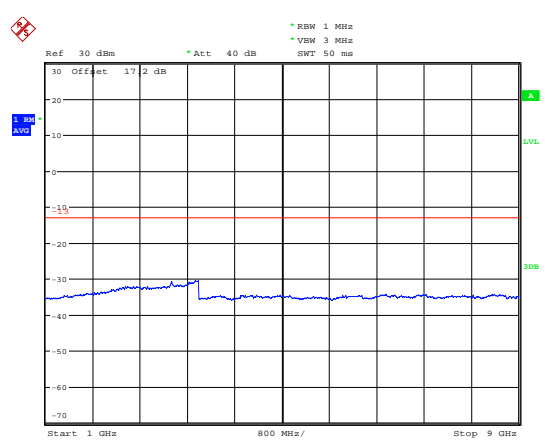

Date: 28.OCT.2019 20:48:54

NB-IOT Band 85 CH High 30MHz~1GHz

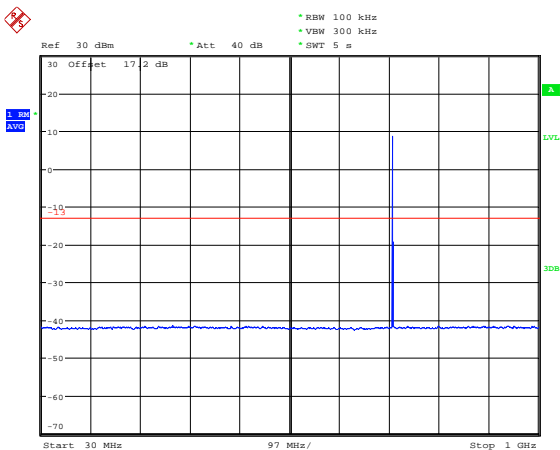

Date: 28.OCT.2019 20:50:57

NB-IOT Band 85 CH High 1GHz~9GHz

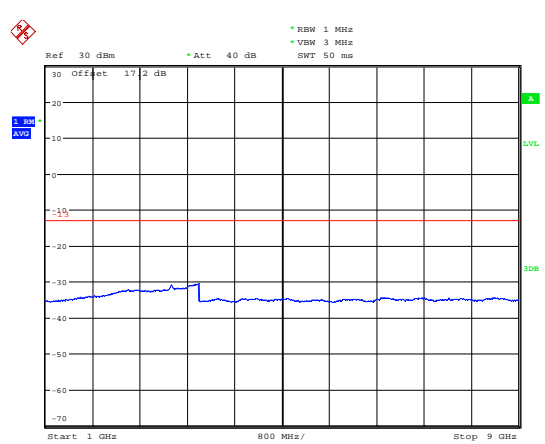

Date: 28.OCT.2019 20:51:16

5.7 Radiates Spurious Emission

Ambient condition

Temperature	Relative humidity	Pressure
23°C ~25°C	45%~50%	101.5kPa

Method of Measurement

- The testing follows FCC KDB 971168D01v03r01 Section 5.8 and ANSI C63.26 (2015).
- Below 1GHz:The EUT is placed on a turntable 0.8 meters above the ground in the chamber, 3 meter away from the antenna. The maximal emission value is acquired by adjusting the antenna height, polarisation and turntable azimuth. Normally, the height range of antenna is 1 m to 4 m, the azimuth range of turntable is 0° to 360°, and the receive antenna has two polarizations Vertical (V) and Horizontal (H). Above 1GHz:(Note: the FCC’s permission to use 1.5m as an alternative per TCBC Conf call of Dec. 2, 2014.)The EUT is placed on a turntable 1.5 meters above the ground in the chamber, 3 meter away from the antenna. The maximal emission value is acquired by adjusting the antenna height, polarisation and turntable azimuth. Normally, the height range of antenna is 1 m to 4 m, the azimuth range of turntable is 0° to 360°, and the receive antenna has two polarizations Vertical (V) and Horizontal (H).
- A loop antenna, A log-periodic antenna or horn antenna shall be substituted in place of the EUT. The log-periodic antenna will be driven by a signal generator and the level will be adjusted till the same power value on the spectrum analyzer or receiver. The level of the spurious emissions can be calculated through the level of the signal generator, cable loss, the gain of the substitution antenna and the reading of the spectrum analyzer or receiver.
- The EUT is then put into continuously transmitting mode at its maximum power level during the test. Set Test Receiver or Spectrum RBW=200Hz, VBW=600Hz for 9kHz-150kHz, RBW=10kHz, VBW=30kHz-30MHz, RBW=100kHz, VBW=300kHz for 30MHz to 1GHz and RBW=1MHz, VBW=3MHz for above 1GHz And the maximum value of the receiver should be recorded as (Pr).
- The EUT shall be replaced by a substitution antenna. In the chamber, a substitution antenna for the frequency band of interest is placed at the reference point of the chamber. An RF Signal source for the frequency band of interest is connected to the substitution antenna with a cable that has been constructed to not interfere with the radiation pattern of the antenna. A power (P_{Mea}) is applied to the input of the substitution antenna, and adjust the level of the signal generator output until the value of the receiver reach the previously recorded (Pr). The power of signal source (P_{Mea}) is recorded. The test should be performed by rotating the test item and adjusting the receiving antenna polarization.
- An amplifier should be connected to the Signal Source output port. And the cable should be connect between the Amplifier and the Substitution Antenna. The cable loss (P_{cl}), the Substitution Antenna Gain (G_a) and the Amplifier Gain (P_{Ag}) should be recorded after test.
- The measurement results are obtained as described below:
 $Power(EIRP) = P_{Mea} - P_{Ag} - P_{cl} + G_a$
 The measurement results are amend as described below:
 $Power(EIRP) = P_{Mea} - P_{cl} + G_a$
- This value is EIRP since the measurement is calibrated using an antenna of known gain (2.15 dBi)

and known input power. ERP can be calculated from EIRP by subtracting the gain of the dipole, $ERP = EIRP - 2.15\text{dBi}$.

The modulation mode and RB allocation refer to section 5.1, using the maximum output power configuration.

Test setup

9KHz~ 30MHz

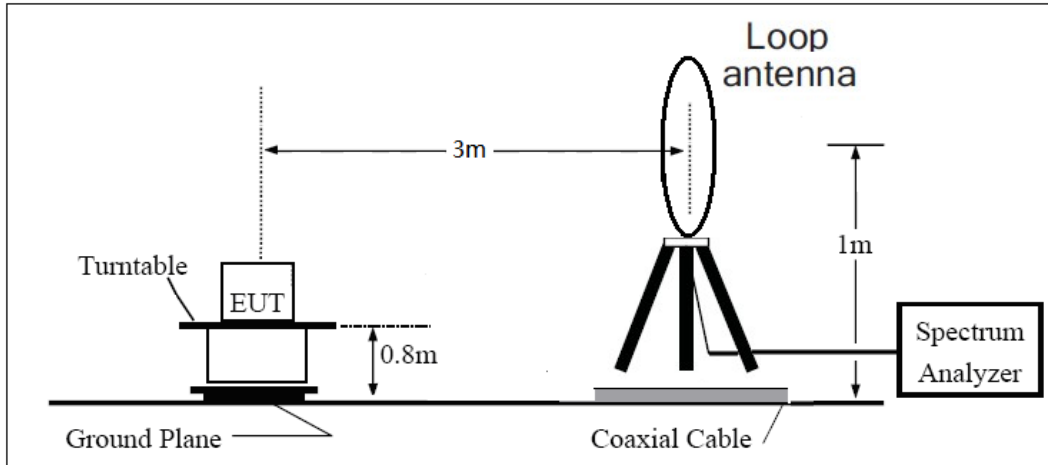

30MHz~ 1GHz

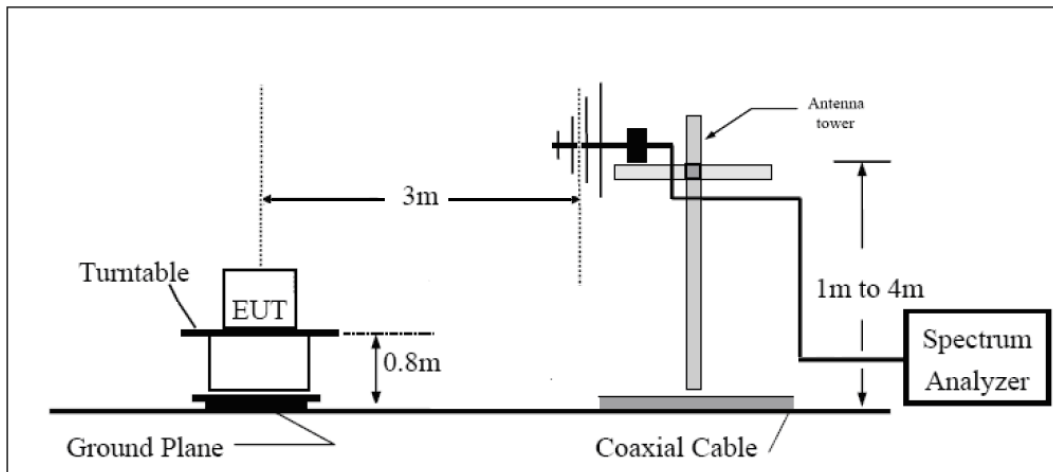

Above 1GHz

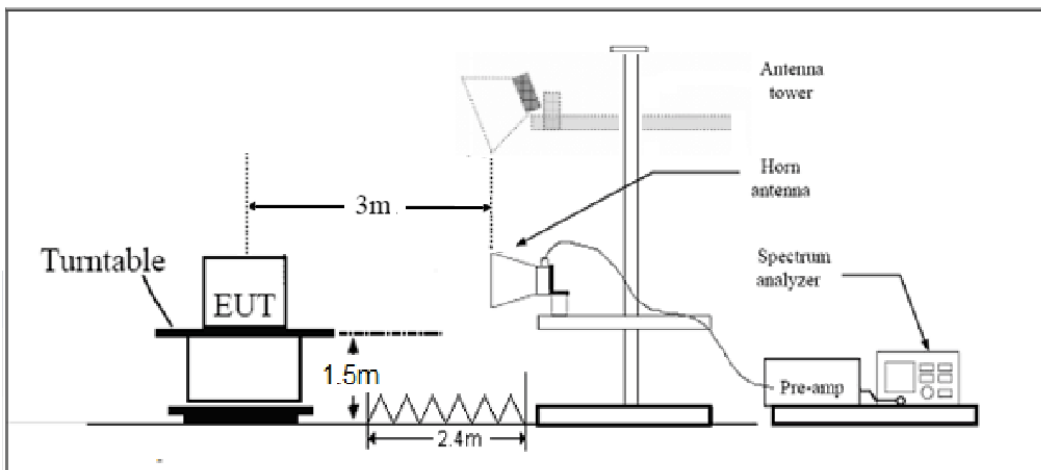

Note: Area side:2.4mX3.6m

Limits

Rule Part 27.53(h) specifies that “for operations in the 1695-1710 MHz, 1710-1755 MHz, 1755-1780 MHz, 1915-1920 MHz, 1995-2000 MHz, 2000-2020 MHz, 2110-2155 MHz, 2155-2180 MHz, and 2180-2200 bands, the power of any emission outside a licensee's frequency block shall be attenuated below the transmitter power (P) in watts by at least $43 + 10 \log_{10}(P)$ dB.”

Rule Part 27.53 (g) For operations in the 600 MHz band and the 698-746 MHz band, the power of any emission outside a licensee's frequency band(s) of operation shall be attenuated below the transmitter power (P) within the licensed band(s) of operation, measured in watts, by at least $43 + 10 \log(P)$ dB. Compliance with this provision is based on the use of measurement instrumentation employing a resolution bandwidth of 100 kilohertz or greater. However, in the 100 kilohertz bands immediately outside and adjacent to a licensee's frequency block, a resolution bandwidth of at least 30 kHz may be employed.

Rule Part 27.53(f) For operations in the 746-758 MHz, 775-788 MHz, and 805-806 MHz bands, emissions in the band 1559-1610 MHz shall be limited to -70 dBW/MHz equivalent isotropically radiated power (EIRP) for wideband signals, and -80 dBW EIRP for discrete emissions of less than 700 Hz bandwidth. For the purpose of equipment authorization, a transmitter shall be tested with an antenna that is representative of the type that will be used with the equipment in normal operation.

Part 27.53(a)/(h)/(g) Limit		-13 dBm
Part 27.53(f) Limit	Limit out of the band 1559-1610 MHz	-13 dBm
	Limit in the band 1559-1610 MHz	-40 dBm
Part 27.53(m) Limit		-25 dBm

Measurement Uncertainty

The assessed measurement uncertainty to ensure 95% confidence level for the normal distribution is with the coverage factor $k = \pm 1.96$, $U = \pm 3.55$ dB.

**Test Result**

Sweep the whole frequency band through the range from 9kHz to the 10th harmonic of the carrier, the emissions below the noise floor will not be recorded in the report.

NB-IOT Band 4 BPSK 15KHz CH-Low

Harmonic	Frequency (MHz)	SG (dBm)	Cable Loss (dB)	Gain (dBi)	Antenna Polarization	EIRP Level (dBm)	Limit (dBm)	Margin (dB)	Azimuth (deg)
2	3420.2	-50.45	2.6	10.15	Horizontal	-42.90	-13.00	29.90	45
3	5130.3	-57.95	2.4	11.35	Horizontal	-49.00	-13.00	36.00	0
4	6840.4	-55.45	4.5	10.85	Horizontal	-49.10	-13.00	36.10	0
5	8550.5	-53.25	5.1	11.35	Horizontal	-47.00	-13.00	34.00	90
6	10260.6	-51.75	5.3	11.95	Horizontal	-45.10	-13.00	32.10	135
7	11970.7	-52.35	5.5	13.55	Horizontal	-44.30	-13.00	31.30	180
8	13680.8	-49.85	6.3	13.75	Horizontal	-42.40	-13.00	29.40	270
9	15390.9	-49.55	6.7	13.85	Horizontal	-42.40	-13.00	29.40	225
10	17101.0	-44.55	6.8	14.25	Horizontal	-37.10	-13.00	24.10	135

Note: 1.The other Spurious RF Radiated emissions level is no more than noise floor.

2. The worst emission was found in the antenna is Horizontal position.

NB-IOT Band 4 BPSK 15KHz CH-Middle

Harmonic	Frequency (MHz)	SG (dBm)	Cable Loss (dB)	Gain (dBi)	Antenna Polarization	EIRP Level (dBm)	Limit (dBm)	Margin (dB)	Azimuth (deg)
2	3465.0	-54.85	2.6	10.75	Horizontal	-46.70	-13.00	33.70	180
3	5197.5	-57.25	2.4	11.05	Horizontal	-48.60	-13.00	35.60	315
4	6930.0	-58.95	4.5	11.15	Horizontal	-52.30	-13.00	39.30	270
5	8662.5	-52.89	5.1	11.35	Horizontal	-46.64	-13.00	33.64	225
6	10395.0	-49.15	5.3	11.95	Horizontal	-42.50	-13.00	29.50	90
7	12127.5	-51.74	5.5	13.55	Horizontal	-43.69	-13.00	30.69	45
8	13860.0	-49.75	6.3	13.75	Horizontal	-42.30	-13.00	29.30	0
9	15592.5	-50.15	6.7	13.85	Horizontal	-43.00	-13.00	30.00	90
10	17325.0	-46.13	6.8	14.25	Horizontal	-38.68	-13.00	25.68	135

Note: 1.The other Spurious RF Radiated emissions level is no more than noise floor.

2. The worst emission was found in the antenna is Horizontal position.



NB-IOT Band 4 BPSK 15KHz CH-High

Harmonic	Frequency (MHz)	SG (dBm)	Cable Loss (dB)	Gain (dBi)	Antenna Polarization	EIRP Level (dBm)	Limit (dBm)	Margin (dB)	Azimuth (deg)
2	3509.8	-60.05	2.6	10.15	Horizontal	-52.50	-13.00	39.50	0
3	5264.7	-57.95	2.4	11.05	Horizontal	-49.30	-13.00	36.30	90
4	7019.6	-56.65	4.5	11.15	Horizontal	-50.00	-13.00	37.00	45
5	8774.5	-52.74	5.1	11.35	Horizontal	-46.49	-13.00	33.49	135
6	10529.4	-50.55	5.3	11.95	Horizontal	-43.90	-13.00	30.90	90
7	12284.3	-50.04	5.5	13.55	Horizontal	-41.99	-13.00	28.99	315
8	14039.2	-50.25	6.3	13.75	Horizontal	-42.80	-13.00	29.80	270
9	15794.1	-49.55	6.7	13.85	Horizontal	-42.40	-13.00	29.40	135
10	17549.0	-44.85	6.8	14.25	Horizontal	-37.40	-13.00	24.40	225

Note: 1.The other Spurious RF Radiated emissions level is no more than noise floor.
2. The worst emission was found in the antenna is Horizontal position.

NB-IOT Band 12BPSK 15KHz CH-Low

Harmonic	Frequency (MHz)	SG (dBm)	Cable Loss (dB)	Gain (dBi)	Antenna Polarization	ERP Level (dBm)	Limit (dBm)	Margin (dB)	Azimuth (deg)
2	1398.2	-48.21	2.00	10.15	Horizontal	-42.21	-13.00	29.21	90
3	2097.3	-55.55	2.50	11.35	Horizontal	-48.85	-13.00	35.85	45
4	2796.4	-54.18	4.20	10.85	Horizontal	-49.68	-13.00	36.68	315
5	3495.5	-56.20	5.20	11.35	Horizontal	-52.20	-13.00	39.20	135
6	4194.6	-54.80	5.50	11.95	Horizontal	-50.50	-13.00	37.50	225
7	4893.7	-55.20	5.70	13.55	Horizontal	-49.50	-13.00	36.50	180
8	5592.8	-54.80	6.30	13.75	Horizontal	-49.50	-13.00	36.50	135
9	6291.9	-54.40	6.80	13.85	Horizontal	-49.50	-13.00	36.50	225
10	6991.0	-56.90	6.90	14.25	Horizontal	-51.70	-13.00	38.70	135

Note: 1.The other Spurious RF Radiated emissions level is no more than noise floor.
2. The worst emission was found in the antenna is Horizontal position.



NB-IOT Band 13BPSK 15KHz CH-Middle

Harmonic	Frequency (MHz)	SG (dBm)	Cable Loss (dB)	Gain (dBi)	Antenna Polarization	ERP Level (dBm)	Limit (dBm)	Margin (dB)	Azimuth (deg)
2	1415.0	-47.28	2.00	10.75	Horizontal	-40.68	-13.00	27.68	45
3	2122.5	-52.30	2.51	11.05	Horizontal	-45.91	-13.00	32.91	135
4	2830.0	-52.95	4.20	11.15	Horizontal	-48.15	-13.00	35.15	45
5	3537.5	-55.89	5.20	11.15	Horizontal	-52.09	-13.00	39.09	90
6	4245.0	-53.55	5.50	11.95	Horizontal	-49.25	-13.00	36.25	315
7	4952.5	-54.50	5.70	13.55	Horizontal	-48.80	-13.00	35.80	90
8	5660.0	-53.40	6.30	13.75	Horizontal	-48.10	-13.00	35.10	45
9	6367.5	-55.10	6.80	13.85	Horizontal	-50.20	-13.00	37.20	135
10	7075.0	-54.77	6.90	14.25	Horizontal	-49.57	-13.00	36.57	45

Note: 1.The other Spurious RF Radiated emissions level is no more than noise floor.
2. The worst emission was found in the antenna is Horizontal position.

NB-IOT Band 12BPSK 15KHz CH-High

Harmonic	Frequency (MHz)	SG (dBm)	Cable Loss (dB)	Gain (dBi)	Antenna Polarization	ERP Level (dBm)	Limit (dBm)	Margin (dB)	Azimuth (deg)
2	1431.8	-51.54	2.00	10.15	Horizontal	-45.54	-13.00	32.54	225
3	2147.7	-56.50	2.51	11.05	Horizontal	-50.11	-13.00	37.11	180
4	2863.6	-53.21	4.20	11.15	Horizontal	-48.41	-13.00	35.41	135
5	3579.5	-56.08	5.20	11.15	Horizontal	-52.28	-13.00	39.28	225
6	4295.4	-53.60	5.50	11.95	Horizontal	-49.30	-13.00	36.30	135
7	5011.3	-53.50	5.70	13.55	Horizontal	-47.80	-13.00	34.80	225
8	5727.2	-53.30	6.30	13.75	Horizontal	-48.00	-13.00	35.00	180
9	6443.1	-55.10	6.80	13.85	Horizontal	-50.20	-13.00	37.20	135
10	7159.0	-55.00	6.90	14.25	Horizontal	-49.80	-13.00	36.80	225

Note: 1.The other Spurious RF Radiated emissions level is no more than noise floor.
2. The worst emission was found in the antenna is Horizontal position.



NB-IOT Band 13BPSK 15KHz CH-Low

Harmonic	Frequency (MHz)	SG (dBm)	Cable Loss (dB)	Gain (dBi)	Antenna Polarization	ERP Level (dBm)	Limit (dBm)	Margin (dB)	Azimuth (deg)
2	1554.2	-53.65	2.00	10.15	Horizontal	-47.65	-40.00	7.65	315
3	2331.3	-46.14	2.50	11.35	Horizontal	-39.44	-13.00	26.44	315
4	3108.4	-53.90	4.20	10.85	Horizontal	-49.40	-13.00	36.40	135
5	3885.5	-54.90	5.20	11.35	Horizontal	-50.90	-13.00	37.90	225
6	4662.6	-54.70	5.50	11.95	Horizontal	-50.40	-13.00	37.40	180
7	5439.7	-54.30	5.70	13.55	Horizontal	-48.60	-13.00	35.60	180
8	6216.8	-55.30	6.30	13.75	Horizontal	-50.00	-13.00	37.00	270
9	6993.9	-56.30	6.80	13.85	Horizontal	-51.40	-13.00	38.40	315
10	7771.0	-53.30	6.90	14.25	Horizontal	-48.10	-13.00	35.10	45

Note: 1.The other Spurious RF Radiated emissions level is no more than noise floor.

2. The worst emission was found in the antenna is Horizontal position.

NB-IOT Band 13BPSK 15KHz CH-Middle

Harmonic	Frequency (MHz)	SG (dBm)	Cable Loss (dB)	Gain (dBi)	Antenna Polarization	EIRP Level (dBm)	Limit (dBm)	Margin (dB)	Azimuth (deg)
2	1564.0	-53.76	2.00	10.75	Horizontal	-47.16	-40.00	7.16	180
3	2346.0	-46.85	2.51	11.05	Horizontal	-40.46	-13.00	27.46	90
4	3128.0	-55.14	4.20	11.15	Horizontal	-50.34	-13.00	37.34	45
5	3910.0	-54.19	5.20	11.15	Horizontal	-50.39	-13.00	37.39	315
6	4692.0	-54.30	5.50	11.95	Horizontal	-50.00	-13.00	37.00	135
7	5474.0	-54.30	5.70	13.55	Horizontal	-48.60	-13.00	35.60	45
8	6256.0	-55.00	6.30	13.75	Horizontal	-49.70	-13.00	36.70	90
9	7038.0	-55.40	6.80	13.85	Horizontal	-50.50	-13.00	37.50	315
10	7820.0	-52.50	6.90	14.25	Horizontal	-47.30	-13.00	34.30	90

Note: 1.The other Spurious RF Radiated emissions level is no more than noise floor.

2. The worst emission was found in the antenna is Horizontal position.



NB-IOT Band 13BPSK 15KHz CH-High

Harmonic	Frequency (MHz)	SG (dBm)	Cable Loss (dB)	Gain (dBi)	Antenna Polarization	ERP Level (dBm)	Limit (dBm)	Margin (dB)	Azimuth (deg)
2	1573.8	-53.46	2.00	10.15	Horizontal	-47.46	-40.00	7.46	0
3	2360.7	-50.30	2.51	11.05	Horizontal	-43.91	-13.00	30.91	0
4	3147.6	-52.80	4.20	11.15	Horizontal	-48.00	-13.00	35.00	90
5	3934.5	-54.60	5.20	11.15	Horizontal	-50.80	-13.00	37.80	135
6	4721.4	-53.90	5.50	11.95	Horizontal	-49.60	-13.00	36.60	180
7	5508.3	-54.50	5.70	13.55	Horizontal	-48.80	-13.00	35.80	270
8	6295.2	-56.10	6.30	13.75	Horizontal	-50.80	-13.00	37.80	225
9	7082.1	-55.00	6.80	13.85	Horizontal	-50.10	-13.00	37.10	90
10	7869.0	-51.90	6.90	14.25	Horizontal	-46.70	-13.00	33.70	315

Note: 1. The other Spurious RF Radiated emissions level is no more than noise floor.
2. The worst emission was found in the antenna is Horizontal position.

NB-IOT Band 66BPSK 15KHz CH-Low

Harmonic	Frequency (MHz)	SG (dBm)	Cable Loss (dB)	Gain (dBi)	Antenna Polarization	EIRP Level (dBm)	Limit (dBm)	Margin (dB)	Azimuth (deg)
2	3420.0	-57.70	2.6	10.15	Horizontal	-50.15	-13.00	37.15	315
3	5130.0	-57.71	2.4	11.35	Horizontal	-48.76	-13.00	35.76	0
4	6840.0	-57.05	4.5	10.85	Horizontal	-50.70	-13.00	37.70	135
5	8550.0	-53.13	5.1	11.35	Horizontal	-46.88	-13.00	33.88	225
6	10260.0	-50.87	5.3	11.95	Horizontal	-44.22	-13.00	31.22	45
7	11970.0	-51.78	5.5	13.55	Horizontal	-43.73	-13.00	30.73	90
8	13680.0	-49.10	6.3	13.75	Horizontal	-41.65	-13.00	28.65	180
9	15390.0	-49.03	6.7	13.85	Horizontal	-41.88	-13.00	28.88	225
10	17100.0	-45.29	6.8	14.25	Horizontal	-37.84	-13.00	24.84	90

Note: 1. The other Spurious RF Radiated emissions level is no more than noise floor.
2. The worst emission was found in the antenna is Horizontal position.



NB-IOT Band 66BPSK 15KHz CH-Middle

Harmonic	Frequency (MHz)	SG (dBm)	Cable Loss (dB)	Gain (dBi)	Antenna Polarization	EIRP Level (dBm)	Limit (dBm)	Margin (dB)	Azimuth (deg)
2	3490.0	-59.55	2.6	10.75	Horizontal	-51.40	-13.00	38.40	0
3	5235.0	-57.64	2.4	11.05	Horizontal	-48.99	-13.00	35.99	90
4	6980.0	-57.51	4.5	11.15	Horizontal	-50.86	-13.00	37.86	45
5	8725.0	-51.52	5.1	11.35	Horizontal	-45.27	-13.00	32.27	315
6	10470.0	-50.41	5.3	11.95	Horizontal	-43.76	-13.00	30.76	225
7	12215.0	-50.37	5.5	13.55	Horizontal	-42.32	-13.00	29.32	180
8	13960.0	-49.20	6.3	13.75	Horizontal	-41.75	-13.00	28.75	45
9	15705.0	-48.32	6.7	13.85	Horizontal	-41.17	-13.00	28.17	45
10	17450.0	-45.39	6.8	14.25	Horizontal	-37.94	-13.00	24.94	90

Note: 1.The other Spurious RF Radiated emissions level is no more than noise floor.
2. The worst emission was found in the antenna is Horizontal position.

NB-IOT Band 66BPSK 15KHz CH-High

Harmonic	Frequency (MHz)	SG (dBm)	Cable Loss (dB)	Gain (dBi)	Antenna Polarization	EIRP Level (dBm)	Limit (dBm)	Margin (dB)	Azimuth (deg)
2	3559.8	-59.07	2.6	10.15	Horizontal	-51.52	-13.00	38.52	45
3	5339.7	-57.94	2.4	11.05	Horizontal	-49.29	-13.00	36.29	225
4	7119.6	-56.61	4.5	11.15	Horizontal	-49.96	-13.00	36.96	90
5	8899.5	-52.42	5.1	11.35	Horizontal	-46.17	-13.00	33.17	180
6	10679.4	-49.98	5.3	11.95	Horizontal	-43.33	-13.00	30.33	45
7	12459.3	-50.28	5.5	13.55	Horizontal	-42.23	-13.00	29.23	0
8	14239.2	-49.60	6.3	13.75	Horizontal	-42.15	-13.00	29.15	135
9	16019.1	-47.63	6.7	13.85	Horizontal	-40.48	-13.00	27.48	180
10	17799.0	-45.88	6.8	14.25	Horizontal	-38.43	-13.00	25.43	315

Note: 1.The other Spurious RF Radiated emissions level is no more than noise floor.
2. The worst emission was found in the antenna is Horizontal position.



NB-IOT Band 71BPSK 15KHz CH-Low

Harmonic	Frequency (MHz)	SG (dBm)	Cable Loss (dB)	Gain (dBi)	Antenna Polarization	ERP Level (dBm)	Limit (dBm)	Margin (dB)	Azimuth (deg)
2	1326.2	-44.73	2.00	10.15	Horizontal	-38.73	-13.00	25.73	315
3	1989.3	-44.88	2.50	11.35	Horizontal	-38.18	-13.00	25.18	225
4	2652.4	-54.30	4.20	10.85	Horizontal	-49.80	-13.00	36.80	180
5	3315.5	-53.53	5.20	11.35	Horizontal	-49.53	-13.00	36.53	90
6	3978.6	-61.49	5.50	11.95	Horizontal	-57.19	-13.00	44.19	0
7	4641.7	-61.46	5.70	13.55	Horizontal	-55.76	-13.00	42.76	315
8	5304.8	-61.88	6.30	13.75	Horizontal	-56.58	-13.00	43.58	225
9	5967.9	-59.33	6.80	13.85	Horizontal	-54.43	-13.00	41.43	90
10	6631.0	-59.08	6.90	14.25	Horizontal	-53.88	-13.00	40.88	0

Note: 1.The other Spurious RF Radiated emissions level is no more than noise floor.
2. The worst emission was found in the antenna is Horizontal position.

NB-IOT Band 71BPSK 15KHz CH-Middle

Harmonic	Frequency (MHz)	SG (dBm)	Cable Loss (dB)	Gain (dBi)	Antenna Polarization	ERP Level (dBm)	Limit (dBm)	Margin (dB)	Azimuth (deg)
2	1361.0	-53.38	2.00	10.75	Horizontal	-46.78	-13.00	33.78	0
3	2041.5	-47.07	2.51	11.05	Horizontal	-40.68	-13.00	27.68	135
4	2722.0	-55.87	4.20	11.15	Horizontal	-51.07	-13.00	38.07	225
5	3402.5	-59.90	5.20	11.15	Horizontal	-56.10	-13.00	43.10	45
6	4083.0	-61.16	5.50	11.95	Horizontal	-56.86	-13.00	43.86	0
7	4763.5	-61.16	5.70	13.55	Horizontal	-55.46	-13.00	42.46	270
8	5444.0	-61.73	6.30	13.75	Horizontal	-56.43	-13.00	43.43	135
9	6124.5	-59.66	6.80	13.85	Horizontal	-54.76	-13.00	41.76	90
10	6805.0	-58.30	6.90	14.25	Horizontal	-53.10	-13.00	40.10	180

Note: 1.The other Spurious RF Radiated emissions level is no more than noise floor.
2. The worst emission was found in the antenna is Horizontal position.



NB-IOT Band 71BPSK 15KHz CH-High

Harmonic	Frequency (MHz)	SG (dBm)	Cable Loss (dB)	Gain (dBi)	Antenna Polarization	ERP Level (dBm)	Limit (dBm)	Margin (dB)	Azimuth (deg)
2	1395.8	-46.89	2.00	10.15	Horizontal	-40.89	-13.00	27.89	135
3	2093.7	-56.79	2.51	11.05	Horizontal	-50.40	-13.00	37.40	270
4	2791.6	-53.97	4.20	11.15	Horizontal	-49.17	-13.00	36.17	225
5	3489.5	-58.83	5.20	11.15	Horizontal	-55.03	-13.00	42.03	180
6	4187.4	-60.31	5.50	11.95	Horizontal	-56.01	-13.00	43.01	45
7	4885.3	-60.74	5.70	13.55	Horizontal	-55.04	-13.00	42.04	135
8	5583.2	-60.35	6.30	13.75	Horizontal	-55.05	-13.00	42.05	90
9	6281.1	-58.68	6.80	13.85	Horizontal	-53.78	-13.00	40.78	45
10	6979.0	-57.25	6.90	14.25	Horizontal	-52.05	-13.00	39.05	270

Note: 1.The other Spurious RF Radiated emissions level is no more than noise floor.

2. The worst emission was found in the antenna is Horizontal position.

NB-IOT Band 85BPSK 15KHz CH-Low

Harmonic	Frequency (MHz)	SG (dBm)	Cable Loss (dB)	Gain (dBi)	Antenna Polarization	ERP Level (dBm)	Limit (dBm)	Margin (dB)	Azimuth (deg)
2	1395.8	-41.58	2.00	10.15	Horizontal	-35.58	-13.00	22.58	0
3	2184.0	-56.66	2.50	11.35	Horizontal	-49.96	-13.00	36.96	45
4	2792.3	-52.12	4.20	10.85	Horizontal	-47.62	-13.00	34.62	90
5	3490.5	-58.05	5.20	11.35	Horizontal	-54.05	-13.00	41.05	90
6	4188.6	-58.43	5.50	11.95	Horizontal	-54.13	-13.00	41.13	45
7	4886.7	-60.91	5.70	13.55	Horizontal	-55.21	-13.00	42.21	90
8	5584.8	-58.72	6.30	13.75	Horizontal	-53.42	-13.00	40.42	180
9	6282.9	-57.13	6.80	13.85	Horizontal	-52.23	-13.00	39.23	225
10	6981.0	-54.61	6.90	14.25	Horizontal	-49.41	-13.00	36.41	135

Note: 1.The other Spurious RF Radiated emissions level is no more than noise floor.

2. The worst emission was found in the antenna is Horizontal position.



NB-IOT Band 85BPSK 15KHz CH-Middle

Harmonic	Frequency (MHz)	SG (dBm)	Cable Loss (dB)	Gain (dBi)	Antenna Polarization	ERP Level (dBm)	Limit (dBm)	Margin (dB)	Azimuth (deg)
2	1411.8	-54.00	2.00	10.75	Horizontal	-47.40	-13.00	34.40	180
3	2117.7	-55.06	2.51	11.05	Horizontal	-48.67	-13.00	35.67	225
4	2823.6	-60.07	4.20	11.15	Horizontal	-55.27	-13.00	42.27	135
5	3529.5	-59.52	5.20	11.15	Horizontal	-55.72	-13.00	42.72	90
6	4235.4	-59.55	5.50	11.95	Horizontal	-55.25	-13.00	42.25	0
7	4941.3	-60.09	5.70	13.55	Horizontal	-54.39	-13.00	41.39	45
8	5647.2	-59.49	6.30	13.75	Horizontal	-54.19	-13.00	41.19	90
9	6353.1	-57.26	6.80	13.85	Horizontal	-52.36	-13.00	39.36	225
10	7059.0	-55.06	6.90	14.25	Horizontal	-49.86	-13.00	36.86	135

Note: 1.The other Spurious RF Radiated emissions level is no more than noise floor.
2. The worst emission was found in the antenna is Horizontal position.

NB-IOT Band 85BPSK 15KHz CH-High

Harmonic	Frequency (MHz)	SG (dBm)	Cable Loss (dB)	Gain (dBi)	Antenna Polarization	ERP Level (dBm)	Limit (dBm)	Margin (dB)	Azimuth (deg)
2	1431.8	-45.71	2.00	10.15	Horizontal	-39.71	-13.00	26.71	135
3	2147.5	-54.12	2.51	11.05	Horizontal	-47.73	-13.00	34.73	225
4	2863.3	-52.18	4.20	11.15	Horizontal	-47.38	-13.00	34.38	315
5	3579.5	-58.60	5.20	11.15	Horizontal	-54.80	-13.00	41.80	45
6	4295.4	-59.11	5.50	11.95	Horizontal	-54.81	-13.00	41.81	90
7	5011.3	-60.62	5.70	13.55	Horizontal	-54.92	-13.00	41.92	0
8	5727.2	-58.45	6.30	13.75	Horizontal	-53.15	-13.00	40.15	45
9	6443.1	-56.09	6.80	13.85	Horizontal	-51.19	-13.00	38.19	135
10	7159.0	-54.62	6.90	14.25	Horizontal	-49.42	-13.00	36.42	315

Note: 1.The other Spurious RF Radiated emissions level is no more than noise floor.
2. The worst emission was found in the antenna is Horizontal position.



6 Main Test Instruments

Name	Manufacturer	Type	Serial Number	Calibration Date	Expiration Date
Base Station Simulator	R&S	CMW500	113824	2019-05-19	2020-05-18
Power Splitter	Hua Xiang	SHX-GF2-2-13	10120101	/	/
Spectrum Analyzer	Key sight	N9010A	MY50210259	2019-05-19	2020-05-18
Signal Analyzer	R&S	FSV40	101298	2019-05-19	2020-05-18
Loop Antenna	SCHWARZBECK	FMZB1519	1519-047	2017-09-26	2020-09-25
Trilog Antenna	SCHWARZBECK	VUBL 9163	9163-201	2017-11-18	2020-11-17
Horn Antenna	R&S	HF907	100126	2018-07-07	2020-07-06
Horn Antenna	ETS-Lindgren	3160-09	00102643	2018-06-20	2020-06-19
Horn Antenna	STEATITE	QSH-SL-26-40-K-15	16779	2017-07-20	2020-07-19
Signal generator	R&S	SMB 100A	102594	2019-05-19	2020-05-18
Climatic Chamber	ESPEC	SU-242	93000506	2017-12-17	2020-12-16
Preamplifier	R&S	SCU18	102327	2019-05-19	2020-05-18
MOB COMMS DC SUPPLY	Keysight	66319D	MY43004105	2019-05-19	2020-05-18
RF Cable	Agilent	SMA 15cm	0001	2019-12-13	2020-6-12
Software	R&S	EMC32	9.26.0	/	/

*****END OF REPORT *****