

FCC RF Test Report

For

Mikrotiks SIA

Test Standards:	<u>FCC 47 CFR Part 2, 22(H), 24(E), 27</u>
Product Description:	Mini-pcie card R11e-LTE6
Brand Name:	Mikrotik
Model Name:	R11e-LTE6
Additional Model:	N/A
FCC ID:	TV7R11ELTE6
Classification	PCS Licensed Transmitter (PCB)
Report No.:	<u>EC1812017F02</u>
Tested Date:	<u>2018-12-20 to 2019-02-16</u>
Issued Date:	<u>2019-02-16</u>
Prepared By:	<u>Tiny yang</u> Tiny yang/ Engineer
Approved By:	<u>Bacon Wu</u> Bacon Wu / RF Manager

Hunan Ecloud Testing Technology Co., Ltd.
Building A1, Changsha E Center, No. 18 Xiangtai Avenue, Liuyang Economic and
Technological Development Zone, Hunan, P.R.C
Tel.: +86-731-89634887 Fax.: +86-731-89634887
www.hn-ecloud.com

Note: The test results in this report apply exclusively to the tested model / sample. Without written approval of Hunan Ecloud Testing Technology Co., Ltd., the test report shall not be reproduced except in full.

Report Revise Record

Report Version	Revise Time	Issued Date	Valid Version	Notes
V1.0	/	2019.02.16	Valid	Original Report

TABLE OF CONTENTS

SUMMARY OF TEST RESULT	4
1 TEST LABORATORY.....	6
1.1 Test facility.....	6
2 GENERAL DESCRIPTION.....	7
2.1 Applicant.....	7
2.2 Manufacturer	7
2.3 Product Feature of Equipment Under Test	7
2.4 Product Specification of Equipment Under Test	9
2.5 Modification of EUT	10
2.6 Applicable Standards	10
3 TEST CONFIGURATION OF EQUIPMENT UNDER TEST.....	11
3.1 Test Mode.....	11
3.2 Frequency List of Low/Middle/High Channels.....	14
3.3 Connection Diagram of Test System	18
3.4 Support Unit used in test configuration	18
3.5 Measurement Results Explanation Example	19
4 CONDUCTED TEST RESULT.....	20
4.1 Measuring Instruments.....	20
4.2 Conducted Output Power and E.R.P./E.I.R.P.....	20
4.3 Peak-to-Average Ratio	22
4.4 99% Occupied Bandwidth and 26dB Bandwidth Measurement.....	23
4.5 Conducted Band Edge and Emission Mask.....	25
4.6 Conducted Spurious Emission	28
4.7 Frequency Stability.....	30
5 RADIATED TEST ITEMS	32
5.1 Measuring Instruments.....	32
5.2 Radiated Spurious Emission	32
6 LIST OF MEASURING EQUIPMENT	36
7 UNCERTAINTY OF EVALUATION	37
APPENDIX A: TEST RESULTS OF CONDUCTED TEST	38
APPENDIX B: TEST RESULTS OF RADIATED TEST	584
APPENDIX C:TEST SETUP PHOTOGRAPHS.....	627

Summary Of Test Result

Report Section	FCC Rule	Description	Limit	Result	Remark
4.2	§2.1046	Conducted Output Power	Reporting Only	PASS	-
	§22.913(a)(2)	Effective Radiated Power (Band 5) (Band 26)	ERP < 7 Watt	PASS	
	§27.50(b)(10) §27.50(c)(10)	Effective Radiated Power (Band 12) (Band 17)	ERP < 3 Watt	PASS	
	§24.232(c) §27.50(h)(2)	Equivalent Isotropic Radiated Power (Band 2)(Band 25) (Band 7) (Band 38)(Band 39) (Band 41)	EIRP < 2Watt	PASS	
4.3	§24.232(d)	Peak-to-Average Ratio	< 13 dB	PASS	-
4.4	§2.1049	Occupied Bandwidth	Reporting Only	PASS	-
4.5	§2.1051 §22.359(a) §22.917(a) §24.238(a) §27.53(g) §27.53(h)	Conducted Band Edge Measurement (Band 2) (Band 5) (Band 12) (Band 17)(Band 25) (Band 26)(Band 39)	< 43+10log ₁₀ (P[Watts])	PASS	-
	§27.53(m)(4)	Adjacent Channel Power (Band 7) (Band 38) (Band 41)	§27.53(m)(4)	PASS	
4.6	§2.1051 §22.917(a) §24.238(a) §27.53(g) §27.53(h)	Conducted Spurious Emission (Band 2) (Band 5) (Band 12) (Band 17) (Band 25) (Band 26) (Band 39)	< 43+10log ₁₀ (P[Watts])	PASS	-
	§2.1051 §27.53(m)(4)	Conducted Spurious Emission (Band 7) (Band 38)(Band 41)	< 55+10log ₁₀ (P[Watts])	PASS	
4.7	§2.1055 §22.355	Frequency Stability for Temperature & Voltage	< 2.5 ppm	PASS	-
	§2.1055 §24.235 §27.54		Within Authorized Band		

Report Section	FCC Rule	Description	Limit	Result	Remark
5.2	§2.1053 §22.917(a) §24.238(a) §27.53(g) §27.53(h)	Radiated Spurious Emission (Band 2) (Band 5) (Band 12) (Band 17) (Band 25)(Band 26)	$< 43+10\log_{10}(P[\text{Watts}])$	PASS	Under limit -13.55 dB at 10380 MHz
	§2.1053 §27.53(m)(4)	Radiated Spurious Emission (Band 7) (Band 38)(Band 41)	$< 55+10\log_{10}(P[\text{Watts}])$		

1 Test Laboratory

1.1 Test facility

CNAS (accreditation number: L11138)

Hunan Ecloud Testing Technology Co., Ltd. has obtained the accreditation of China National Accreditation Service for Conformity Assessment (CNAS).

FCC (Designation number: CN1244 , Test Firm Registration Number: 793308)

Hunan Ecloud Testing Technology Co., Ltd. has been listed on the US Federal Communications Commission list of test facilities recognized to perform electromagnetic emissions measurements.

ISED(CAB identifier: CN0012)

Hunan Ecloud Testing Technology Co., Ltd. has been listed on the Wireless Device Testing Laboratories list of innovation, Science and Economic Development Canada to test to Canadian radio equipment requirements.

A2LA (Certificate Code: 4895.01)

Hunan Ecloud Testing Technology Co., Ltd. has been listed by American Association for Laboratory Accreditation to perform electromagnetic emission measurement.

2 General Description

2.1 Applicant

Mikrotikls SIA

Brivibas gatve 214i, Riga, LV-1039 LATVIA

2.2 Manufacturer

Shanghai Notion information technology CO. LTD

Room 501, Building 5, NO 289, Bisheng Rd, Pudong district, Shanghai, China

2.3 Product Feature of Equipment Under Test

Product Feature	
Equipment	Mini-pcie card R11e-LTE6
Brand Name	Mikrotik
Model Name	R11e-LTE6
Additional Model	N/A
FCC ID	TV7R11ELTE6
Nominal Voltage	3.8 Vdc (From Test fixture)
Extreme Voltage	DC 3.2V and DC 4.3V
Extreme Temperature	-40°C and 80°C
Modulation Type	GSM GSMK, 8PSK
	WCDMA BPSK
	LTE QPSK, 16QAM
Operating frequency	GSM 824.2 MHz ~ 848.8 MHz (FOR GSM 850) 1850.2 MHz ~ 1909.8MHz (FOR DCS 1900)
	WCDMA 826.4 MHz ~ 846.6 MHz (FOR WCDMA 850) 1852.4 MHz ~ 1907.6 MHz (FOR WCDMA 1900)
	LTE LTE Band 2: 1805.7 MHz ~ 1909.3MHz LTE Band 5: 824.7 MHz ~ 848.3 MHz LTE Band 7: 2502.5 MHz ~ 2567.5 MHz LTE Band 12: 699.7 MHz ~ 715.3 MHz LTE Band 17: 706.5 MHz ~ 713.5 MHz LTE Band 25: 1850.7MHz ~ 1914.3 MHz LTE Band 26: 824.7MHz ~ 848.3 MHz LTE Band 38: 2572.5 MHz ~ 2617.5 MHz LTE Band 39: 1882.5 MHz ~ 1907.5 MHz LTE Band 40: 2307.5 MHz ~ 2312.5 MHz &

		2352.5MHz~2357.5MHz LTE Band 41: 2498.5 MHz ~ 2687.5 MHz
HW Version	M26H_1_10	
SW Version	R11e_LTE6	
EUT Stage	Production Unit	

Remark:

1. The above EUT's information was declared by manufacturer. Please refer to the specifications or user's manual for more detailed description.
2. The EUT was investigated in three orthogonal orientations X/Y/Z on antennas. For Main antenna, it was determined that worst-case orientation Y (Landscape) orientation.

2.4 Product Specification of Equipment Under Test

Standards-related Product Specification	
Tx Frequency	LTE Band 2: 1805.7 MHz ~ 1909.3MHz LTE Band 5 : 824.7 MHz ~ 848.3 MHz LTE Band 7 : 2502.5 MHz ~ 2567.5 MHz LTE Band 12 : 699.7 MHz ~ 715.3 MHz LTE Band 17 : 706.5 MHz ~ 713.5 MHz LTE Band 25 : 1850.7MHz ~ 1914.3 MHz LTE Band 26 : 824.7MHz ~ 848.3 MHz LTE Band 38 : 2572.5 MHz ~ 2617.5 MHz LTE Band 39 : 1882.5 MHz ~ 1907.5 MHz LTE Band 41 : 2498.5 MHz ~ 2687.5 MHz
Rx Frequency	LTE Band 2: 1930.7 MHz ~ 1989.3 MHz LTE Band 5 : 869.7 MHz ~ 893.3 MHz LTE Band 7 : 2622.5 MHz ~ 2687.5 MHz LTE Band 12 : 729.7 MHz ~ 745.3 MHz LTE Band 17 : 736.5 MHz ~ 743.5 MHz LTE Band 25 : 1930.7 MHz ~ 1994.3 MHz LTE Band 26 : 869.7 MHz ~ 893.3 MHz LTE Band 38 : 2572.5 MHz ~ 2617.5 MHz LTE Band 39 : 1882.5 MHz ~ 1907.5 MHz LTE Band 41 : 2498.5 MHz ~ 2687.5 MHz
Bandwidth	LTE Band 2 : 1.4MHz / 3MHz / 5MHz / 10MHz / 15MHz / 20MHz LTE Band 5 : 1.4MHz / 3MHz / 5MHz / 10MHz LTE Band 7 : 5MHz/ 10MHz / 15MHz / 20MHz LTE Band 12 : 1.4MHz / 3MHz / 5MHz / 10MHz LTE Band 17 : 5MHz / 10MHz LTE Band 25 : 1.4MHz / 3MHz / 5MHz / 10MHz / 15MHz / 20MHz LTE Band 26 : 1.4MHz / 3MHz / 5MHz / 10MHz / 15MHz LTE Band 38 : 5MHz / 10MHz / 15MHz / 20MHz LTE Band 39 : 5MHz/ 10MHz / 15MHz / 20MHz LTE Band 41 : 5MHz / 10MHz / 15MHz / 20MHz
Maximum EIRP Power	LTE Band 2: 24.00 dBm LTE Band 5: 28.41 dBm LTE Band 7: 22.40 dBm LTE Band 12: 28.57 dBm LTE Band 17: 27.90 dBm LTE Band 25: 24.09 dBm LTE Band 26: 28.52 dBm LTE Band 38: 22.85 dBm LTE Band 39: 24.22 dBm LTE Band 41: 24.68 dBm
Antenna Type	Omni Antenna
Antenna Gain (Main)	LTE Band 2: -0.21 dBi LTE Band 5: 4.83 dBi LTE Band 7: -0.52 dBi LTE Band 12: 5.0 dBi LTE Band 17: 5.0 dBi

	LTE Band 25: -0.21 dBi LTE Band 26: 4.83 dBi LTE Band 38: -0.55 dBi LTE Band 39: -0.21 dBi LTE Band 41: -0.52 dBi
Antenna Gain (AUX -Only RX)	LTE Band 2: -0.21 dBi LTE Band 5: 4.83 dBi LTE Band 7: -0.52 dBi LTE Band 12: 5.0 dBi LTE Band 17: 5.0 dBi LTE Band 25: -0.21 dBi LTE Band 26: 4.83 dBi LTE Band 38: -0.55 dBi LTE Band 39: -0.21 dBi LTE Band 41: -0.52 dBi
Type of Modulation	QPSK/ 16QAM

2.5 Modification of EUT

No modifications are made to the EUT during all test items.

2.6 Applicable Standards

According to the specifications of the manufacturer, the EUT must comply with the requirements of the following standards:

- ♦ 47 CFR Part 2, 22(H), 24(E), 27
 - ♦ ANSI / TIA / EIA-603-E-2016
 - ♦ ANSI C63.26-2015
- FCC KDB 971168 D01 Power Meas. License Digital Systems v03r01

Remark:

1. All test items were verified and recorded according to the standards and without any deviation during the test.
2. This EUT has also been tested and complied with the requirements of FCC Part 15, Subpart B, recorded in a separate test report.

3 Test Configuration of Equipment Under Test

3.1 Test Mode

Antenna port conducted and radiated test items were performed according to KDB 971168 D01 Power Meas. License Digital Systems v03r01 with maximum output power.

Radiated measurements were performed with rotating EUT in different three orthogonal test planes to find the maximum emission.

Radiated emissions were investigated from 30 MHz to 10th harmonic.

Test modes are chosen to be reported as the worst case configuration below:

Test Items	Band	Bandwidth(MHz)						Modulation			RB#			Test Channel		
		1.4	3	5	10	15	20	QPSK		16QAM	1	Half	Full	L	M	H
Max. Output Power and E.R.P./ E.I.R.P.	2	•	•	•	•	•	•	•		•	•	•	•	•	•	•
	4	•	•	•	•	•	•	•		•	•	•	•	•	•	•
	5	•	•	•	•	-	-	•		•	•	•	•	•	•	•
	7	-	-	•	•	•	•	•		•	•	•	•	•	•	•
	12	•	•	•	•	-	-	•		•	•	•	•	•	•	•
	17	-	-	•	•	-	-	•		•	•	•	•	•	•	•
	25	•	•	•	•	•	•	•		•	•	•	•	•	•	•
	26	•	•	•	•	•	-	•		•	•	•	•	•	•	•
	38	-	-	•	•	•	•	•		•	•	•	•	•	•	•
	39	-	-	•	•	•	•	•		•	•	•	•	•	•	•
	41	-	-	•	•	•	•	•		•	•	•	•	•	•	•
66	•	•	•	•	•	•	•		•	•	•	•	•	•	•	
Peak-to-Average Ratio	2	•	•	•	•	•	•	•		•	•	-	•	•	•	•
	4	•	•	•	•	•	•	•		•	•	-	•	•	•	•
	5	•	•	•	•	-	-	•		•	•	-	•	•	•	•
	7	-	-	•	•	•	•	•		•	•	-	•	•	•	•
	12	•	•	•	•	-	-	•		•	•	-	•	•	•	•
	17	-	-	•	•	-	-	•		•	•	-	•	•	•	•
	25	•	•	•	•	•	•	•		•	•	-	•	•	•	•
	26	•	•	•	•	•	-	•		•	•	-	•	•	•	•
	38	-	-	•	•	•	•	•		•	•	-	•	•	•	•
	39	-	-	•	•	•	•	•		•	•	-	•	•	•	•
	41	-	-	•	•	•	•	•		•	•	-	•	•	•	•
66	•	•	•	•	•	•	•		•	•	-	•	•	•	•	

Test Items	Band	Bandwidth(MHz)						Modulation			RB#			Test Channel		
		1.4	3	5	10	15	20	QPSK		16QAM	1	Half	Full	L	M	H
26dB and 99% Bandwidth	2	•	•	•	•	•	•	•		•	-	-	•	•	•	•
	5	•	•	•	•	-	-	•		•	-	-	•	•	•	•
	7	-	-	•	•	•	•	•		•	-	-	•	•	•	•
	12	•	•	•	•	-	-	•		•	-	-	•	•	•	•
	17	-	-	•	•	-	-	•		•	-	-	•	•	•	•
	25	•	•	•	•	•	•	•		•	-	-	•	•	•	•
	26	•	•	•	•	•	-	•		•	-	-	•	•	•	•
	38	-	-	•	•	•	•	•		•	-	-	•	•	•	•
	39	-	-	•	•	•	•	•		•	-	-	•	•	•	•
	41	-	-	•	•	•	•	•		•	-	-	•	•	•	•
Conducted Band Edge	2	•	•	•	•	•	•	•		•	•	-	•	•	•	•
	5	•	•	•	•	-	-	•		•	•	-	•	•	•	•
	7	-	-	•	•	•	•	•		•	•	-	•	•	•	•
	12	•	•	•	•	-	-	•		•	•	-	•	•	•	•
	17	-	-	•	•	-	-	•		•	•	-	•	•	•	•
	25	•	•	•	•	•	•	•		•	•	-	•	•	•	•
	26	•	•	•	•	•	-	•		•	•	-	•	•	•	•
	38	-	-	•	•	•	•	•		•	•	-	•	•	•	•
	39	-	-	•	•	•	•	•		•	•	-	•	•	•	•
	41	-	-	•	•	•	•	•		•	•	-	•	•	•	•
Conducted Spurious Emission	2	•	•	•	•	•	•	•		•	•	-	•	•	•	•
	5	•	•	•	•	-	-	•		•	-	-	•	•	•	•
	7	-	-	•	•	•	•	•		•	-	-	•	•	•	•
	12	•	•	•	•	-	-	•		•	-	-	•	•	•	•
	17	-	-	•	•	-	-	•		•	-	-	•	•	•	•
	25	•	•	•	•	•	•	•		•	-	-	•	•	•	•
	26	•	•	•	•	•	-	•		•	-	-	•	•	•	•
	38	-	-	•	•	•	•	•		•	-	-	•	•	•	•
	39	-	-	•	•	•	•	•		•	-	-	•	•	•	•
	41	-	-	•	•	•	•	•		•	-	-	•	•	•	•
Test Items	Band	Bandwidth(MHz)						Modulation			RB#			Test Channel		

		1.4	3	5	10	15	20	QPSK		16QAM	1	Half	Full	L	M	H
Frequency Stability	2	•	•	•	•	•	•	•		•	-	-	•	•	•	•
	5	•	•	•	•	-	-	•		•	-	-	•	•	•	•
	7	-	-	•	•	•	•	•		•	-	-	•	•	•	•
	12	•	•	•	•	-	-	•		•	-	-	•	•	•	•
	17	-	-	•	•	-	-	•		•	-	-	•	•	•	•
	25	•	•	•	•	•	•	•		•	-	-	•	•	•	•
	26	•	•	•	•	•	-	•		•	-	-	•	•	•	•
	38	-	-	•	•	•	•	•		•	-	-	•	•	•	•
	39	-	-	•	•	•	•	•		•	-	-	•	•	•	•
	41	-	-	•	•	•	•	•		•	-	-	•	•	•	•
Radiated Spurious Emission	2	•	•	•	•	•	•	•		•	•	•	•	•	•	•
	5	•	•	•	•	-	-	•		•	•	•	•	•	•	•
	7	-	-	•	•	•	•	•		•	•	•	•	•	•	•
	12	•	•	•	•	-	-	•		•	•	•	•	•	•	•
	17	-	-	•	•	-	-	•		•	•	•	•	•	•	•
	25	•	•	•	•	•	•	•		•	•	•	•	•	•	•
	26	•	•	•	•	•	-	•		•	•	•	•	•	•	•
	38	-	-	•	•	•	•	•		•	•	•	•	•	•	•
	39	-	-	•	•	•	•	•		•	•	•	•	•	•	•
	41	-	-	•	•	•	•	•		•	•	•	•	•	•	•
Note	<ol style="list-style-type: none"> 1. The mark "•" means that this configuration is chosen for testing. 2. The mark "-" means that this bandwidth is not supported. 3. The device is investigated from 30MHz to 10 times of fundamental signal for radiated spurious emission test under different RB size/offset and modulations in exploratory test. Subsequently, only the worst case emissions are reported. 															

3.2 Frequency List of Low/Middle/High Channels

LTE Band 2 Channel	Bandwidth [MHz]	N _{UL}	Frequency of Uplink [MHz]	N _{DL}	Frequency of Downlink [MHz]
Low Range	1.4	18607	1850.7	607	1930.7
	3	18615	1851.5	615	1931.5
	5	18625	1852.5	625	1932.5
	10	18650	1855	650	1935
	15	18675	1857.5	675	1937.5
	20	18700	1860	700	1940
Middle Range	1.4/3/5/10/15/20	18900	1880	900	1960
High Range	1.4	19193	1909.3	1193	1989.3
	3	19185	1908.5	1185	1988.5
	5	19175	1907.5	1175	1987.5
	10	19150	1905	1150	1985
	15	19125	1902.5	1125	1982.5
	20	19100	1900	1100	1980

LTE Band 5 Channel	Bandwidth [MHz]	N _{UL}	Frequency of Uplink [MHz]	N _{DL}	Frequency of Downlink [MHz]
Low Range	1.4	20407	824.7	2407	869.7
	3	20415	825.5	2415	870.5
	5	20425	826.5	2425	871.5
	10	20450	829	2450	874
Middle Range	1.4/3/5/10	20525	836.5	2525	881.5
High Range	1.4	20643	848.3	2643	893.3
	3	20635	847.5	2635	892.5
	5	20625	846.5	2625	891.5
	10	20600	844	2600	889

LTE Band 7 Channel	Bandwidth[MHz]	N _{UL}	Frequency of Uplink [MHz]	N _{DL}	Frequency of Downlink [MHz]
Low Range	5	20775	2502.5	2775	2622.5
	10	20800	2505	2800	2625
	15	20825	2507.5	2825	2627.5
	20	20850	2510	2850	2630
Middle Range	5/10/15/20	21100	2535	3100	2655
High Range	5	21425	2567.5	3425	2687.5
	10	21400	2565	3400	2685
	15	21375	2562.5	3375	2682.5
	20	21350	2560	3350	2680

LTE Band 17 Channel	Bandwidth[MHz]	N _{UL}	Frequency of Uplink [MHz]	N _{DL}	Frequency of Downlink [MHz]
Low Range	5	23755	706.5	5755	736.5
	10	23780	709	5780	739
Middle Range	5/10/15/20	23790	710	5790	740
High Range	5	23825	713.5	5825	743.5
	10	23800	711	5800	741

LTE Band 12 Channel	Bandwidth[MHz]	N _{UL}	Frequency of Uplink [MHz]	N _{DL}	Frequency of Downlink [MHz]
Low Range	1.4	23017	699.7	5017	729.7
	3	23025	700.5	5025	730.5
	5	23035	701.5	5035	731.5
	10	23060	704	5060	734
Middle Range	1.4/3/5/10	23095	707.5	5095	737.5
High Range	1.4	23173	715.3	5173	745.3
	3	23165	714.5	5165	744.5
	5	23155	713.5	5155	743.5
	10	23130	711	5130	741

LTE Band 25 Channel	Bandwidth[MHz]	N _{UL}	Frequency of Uplink [MHz]	N _{DL}	Frequency of Downlink [MHz]
Low Range	1.4	26047	1850.7	8047	1930.7
	3	26055	1851.5	8055	1931.5
	5	26065	1852.5	8065	1932.5
	10	26090	1855	8090	1935
	15	26115	1857.5	8115	1937.5
	20	26140	1860	8140	1940
Middle Range	1.4/3/5/10/15/20	26365	1882.5	8365	1962.5
High Range	1.4	26683	1914.3	8683	1994.3
	3	26675	1913.5	8675	1993.5
	5	26665	1912.5	8665	1992.5
	10	26640	1910	8640	1990
	15	26615	1907.5	8615	1987.5
	20	26590	1905	8590	1985

LTE Band 26 Channel	Bandwidth[MHz]	N _{UL}	Frequency of Uplink [MHz]	N _{DL}	Frequency of Downlink [MHz]
Low Range	1.4	26797	824.7	8797	869.7
	3	26805	825.5	8805	870.5
	5	26815	826.5	8815	871.5
	10	26840	829	8840	874
	15	26865	831.5	8865	876.5
Middle Range	1.4/3/5/10/15	26915	836.5	8865	876.5
High Range	1.4	27033	848.3	9033	893.3
	3	27025	847.5	9025	892.5
	5	27015	846.5	9015	891.5
	10	26990	844	8990	889
	15	26965	841.5	8965	886.5

LTE Band 38 Channel	Bandwidth [MHz]	EARFCN	Frequency (UL and DL) [MHz]
Low Range	5	37775	2572.5
	10	37800	2575
	15	37825	2577.5
	20	37850	2580
Middle Range	5/10/15/20	38000	2595
High Range	5	38225	2617.5
	10	38200	2615
	15	38175	2612.5
	20	38150	2610

LTE Band 39 Channel	Bandwidth [MHz]	EARFCN	Frequency (UL and DL) [MHz]
Low Range	5	38275	1882.5
	10	38300	1885
	15	38325	1887.5
	20	38350	1890
Mid Range	5/10/15/20	38400	1895
High Range	5	38525	1907.5
	10	38500	1905
	15	38475	1902.5
	20	38450	1900

LTE Band 41 Channel	Bandwidth [MHz]	EARFCN	Frequency (UL and DL) [MHz]
Low Range	5	39675	2498.5
	10	39700	2501
	15	39725	2503.5
	20	39750	2506
Middle Range	5/10/15/20	40620	2593
High Range	5	41565	2687.5
	10	41540	2685
	15	41515	2682.5
	20	41490	2680

3.3 Connection Diagram of Test System

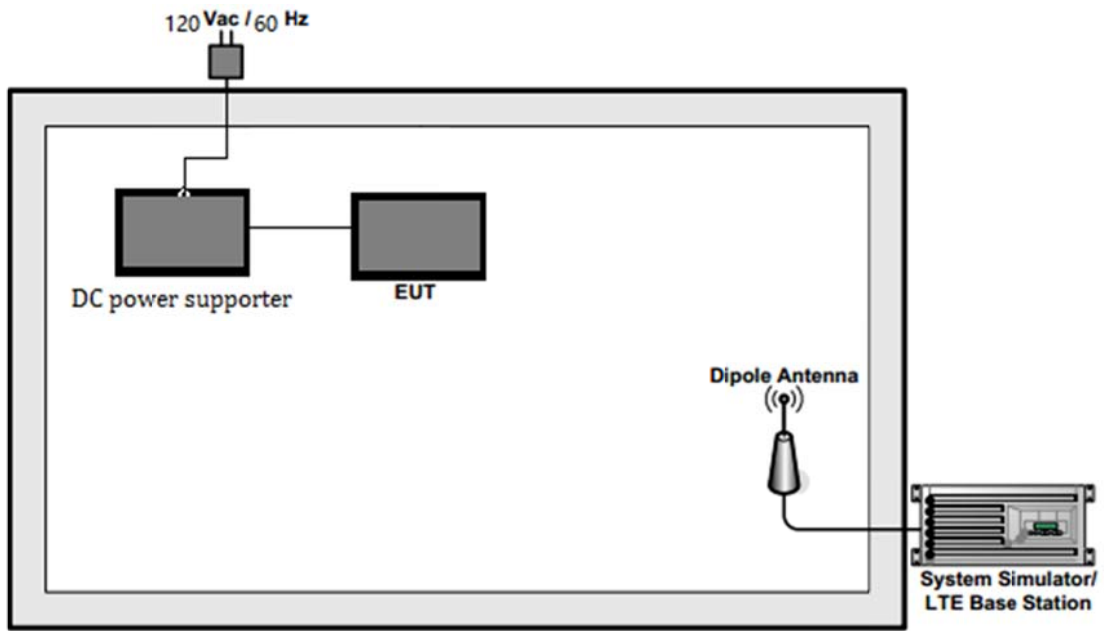

Radiated Setup

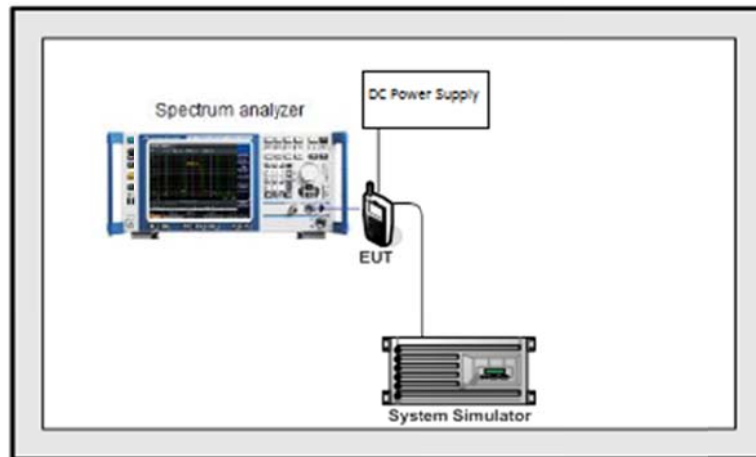

Conducted Setup

3.4 Support Unit used in test configuration

Item	Equipment	Trade Name	Model No.	FCC ID	Data Cable	Power Cord
1.	System Simulator	R&S	CMU 500	N/A	N/A	Unshielded, 1.8 m
2.	DC Power Supply	Keysight	E3642A	N/A	N/A	Unshielded, 1.8 m

3.5 Measurement Results Explanation Example

For all conducted test items:

The offset level is set in the spectrum analyzer to compensate the RF cable loss and attenuator factor between RF conducted output port and spectrum analyzer. With the offset compensation, the spectrum analyzer reading level will be exactly the RF output level.

The spectrum analyzer offset is derived from RF cable loss and attenuator factor.

Offset = RF cable loss + attenuator factor.

The following shows an offset computation example with RF cable loss 4.5 dB and a 10dB attenuator.

Example :

$$\begin{aligned} \text{Offset(dB)} &= \text{RF cable loss(dB)} + \text{attenuator factor(dB)}. \\ &= 4.5 + 10 = 14.5 \text{ (dB)} \end{aligned}$$

4 Conducted Test Result

4.1 Measuring Instruments

See list of measuring instruments of this test report.

4.2 Conducted Output Power and E.R.P./E.I.R.P.

4.2.1 Description of the Conducted Output Power

All LTE bands conducted average power is obtained from the CMW500 telecommunication test set.

The following tests were conducted according to the test requirements outlined in section 6.2 of the 3GPP TS36.101 specification.

UE Power Class: 3 (23 +/- 2dBm). The allowed Maximum Power Reduction (MPR) for the maximum output power due to higher order modulation and transmit bandwidth configuration (resource blocks) is specified in Table 6.2.3-1 of the 3GPP TS36.101.

Table 6.2.3-1: Maximum Power Reduction (MPR) for Power Class 1, 2 and 3

Modulation	Channel bandwidth / Transmission bandwidth (N_{RB})						MPR (dB)
	1.4 MHz	3.0 MHz	5 MHz	10 MHz	15 MHz	20 MHz	
QPSK	> 5	> 4	> 8	> 12	> 16	> 18	≤ 1
16 QAM	≤ 5	≤ 4	≤ 8	≤ 12	≤ 16	≤ 18	≤ 1
16 QAM	> 5	> 4	> 8	> 12	> 16	> 18	≤ 2
64 QAM	≤ 5	≤ 4	≤ 8	≤ 12	≤ 16	≤ 18	≤ 2
64 QAM	> 5	> 4	> 8	> 12	> 16	> 18	≤ 3
256 QAM	≥ 1						≤ 5

4.2.2 E.R.P. /E.I.R.P. Limit

FCC: §2.1046, §22.913, §24.232, §27.50

22.913(a) - The ERP of mobile transmitters and auxiliary test transmitters must not exceed 7 Watts

24.232(c) - Mobile/portable stations are limited to 2 watts e.i.r.p. peak power and the equipment must employ means to limit the power to the minimum necessary for successful communications

27.50 (c) (10) the following power and antenna height requirements apply to stations transmitting in the 698–746 MHz band, the portable stations (hand-held devices) are limited to 3 watts ERP.

27.50 (b)(10) Portable stations (hand-held devices) transmitting in the 746–757 MHz, 758–763 MHz, 776–793 MHz, and 805–806 MHz bands are limited to 3 watts ERP.

27.50 (d)(4) The following power and antenna height requirements apply to stations transmitting in the 1710–1755 MHz and 2110–2155 MHz bands: Fixed, mobile, and portable (hand-held) stations operating in the 1710–1755 MHz band are limited to 1 watt EIRP

27.50 (h) The following power limits shall apply in the BRS and EBS: (2) Mobile and other user stations. Mobile stations are limited to 2.0 watts EIRP. All user stations are limited to 2.0 watts transmitter output power.

4.2.3 Test Procedures

1. The transmitter output port was connected to the system simulator.
2. Set EUT at maximum power through the system simulator.
3. Select lowest, middle, and highest channels for each band and different modulation.
4. Measure and record the power level from the system simulator.

4.2.4 Test Setup

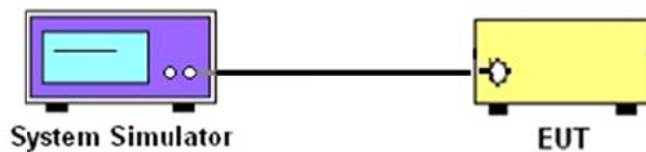

4.2.5 Test Results

Refer to Appendix A of this test report.

4.3 Peak-to-Average Ratio

4.3.1 Description of the PAR Measurement

Power Complementary Cumulative Distribution Function (CCDF) curves provide a means for characterizing the power peaks of a digitally modulated signal on a statistical basis. A CCDF curve depicts the probability of the peak signal amplitude exceeding the average power level. Most contemporary measurement instrumentation include the capability to produce CCDF curves for an input signal provided that the instrument's resolution bandwidth can be set wide enough to accommodate the entire input signal bandwidth.

4.3.2 Limit

In measuring transmissions in this band using an average power technique, the peak-to-average ratio (PAR) of the transmission may not exceed 13 dB.

4.3.3 Test Procedures

1. The testing follows ANSI C63.26 Section 5.2.3.4 (CCDF)
 2. The EUT was connected to spectrum analyzer and system simulator via a power divider.
 3. Set EUT to transmit at maximum output power.
 4. The signal analyzer's CCDF measurement profile is enabled
 5. Frequency = carrier center frequency
 6. Measurement BW > Emission bandwidth of signal
 7. When the duty cycle is less than 98%, then signal gating will be implemented on the spectrum analyzer by triggering from the system simulator.
 8. Set the CCDF (Complementary Cumulative Distribution Function) option of the spectrum analyzer.
- Record the maximum PAPR level associated with a probability of 0.1%.

4.3.4 Test Setup

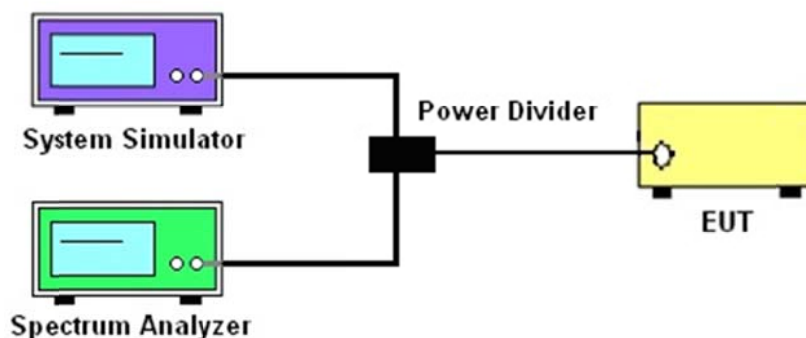

4.3.5 Test Results

Refer to Appendix A of this test report.

4.4 99% Occupied Bandwidth and 26dB Bandwidth Measurement

4.4.1 Description of 99% Occupied Bandwidth and 26dB Bandwidth Measurement

The occupied bandwidth is the width of a frequency band such that, below the lower and above the upper frequency limits, the mean powers emitted are each equal to a specified percentage 0.5% of the total mean transmitted power.

The 26 dB emission bandwidth is defined as the frequency range between two points, one above and one below the carrier frequency, at which the spectral density of the emission is attenuated 26 dB below the maximum in-band spectral density of the modulated signal. Spectral density (power per unit bandwidth) is to be measured with a detector of resolution bandwidth equal to approximately 1.0% of the emission bandwidth.

4.4.2 Limit

For reporting purposes only

4.4.3 Test Procedures

1. The testing follows Sub clause 5.4.3 of ANSI C63.26-2015
2. The EUT was connected to spectrum analyzer and system simulator via a power divider.
3. The signal analyzer's automatic bandwidth measurement capability was used to perform the 99% occupied bandwidth and the 26dB bandwidth the bandwidth measurement was not influenced by any intermediate power nulls in the fundamental emission.
4. $RBW = 1\sim 5\%$ of the expected OBW, $VBW \geq 3 \times RBW$
5. Set the detection mode to peak, and the trace mode to max hold.
6. Determine the reference value: Set the EUT to transmit a modulated signal. Allow the trace to stabilize. Set the spectrum analyzer marker to the highest level of the displayed trace.(this is the reference value)
7. Determine the "-26 dB down amplitude" as equal to (Reference Value – X).
8. Place two markers, one at the lowest and the other at the highest frequency of the envelope of the spectral display such that each marker is at or slightly below the "-X dB down amplitude" determined in step 6. If a marker is below this "-X dB down amplitude" value it shall be placed as close as possible to this value. The OBW is the positive frequency difference between the two markers.
9. Use the 99 % power bandwidth function of the spectrum analyzer and report the measured bandwidth.

4.4.4 Test Setup

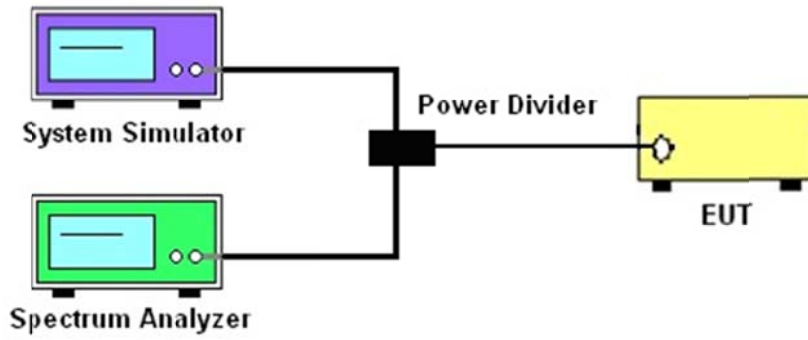

4.4.5 Test Results

Refer to Appendix A of this test report.

4.5 Conducted Band Edge and Emission Mask

4.5.1 Description of Conducted Band Edge and Emission Measurement

The transmitter output was connected to a calibrated coaxial cable, attenuator and Spectrum analyser, the other end of which was connected to a Base Station Simulator. The Base Station Simulator was set to force the EUT to its maximum power setting. The tests were performed at three frequencies (low channel and high channel) in the 1MHz bands immediately outside and adjacent to the frequency block a resolution bandwidth of 100kHz or 1% of the emission bandwidth of the fundamental emission of the transmitter may be employed. The EUT emission bandwidth is measured as the width of the signal between two points, outside of which all emission are attenuated at least 26dB below the transmitter power. The video bandwidth of the spectrum analyzer was set at thrice the resolution bandwidth. Detector Mode was set to peak or peak hold power.

4.5.2 Limit

FCC: §22.359, §22.917, §24.238, §27.53

The power of any emission outside of the authorized operating frequency ranges must be attenuated below the transmitting power (P) by a factor of at least $43 + 10 \log (P)$ dB.

FCC: §27.53

(c) For operations in the 776-788 MHz band, the power of any emission outside the licensee's frequency band(s) of operation shall be attenuated below the transmitter power (P) within the licensed band(s) of operation, measured in watts, in accordance with the following: (2) On any frequency outside the 776-788 MHz band, the power of any emission shall be attenuated outside the band below the transmitter power (P) by at least $43 + 10 \log (P)$ dB; (4) On all frequencies between 763-775 MHz and 793-805 MHz, by a factor not less than $65 + 10 \log (P)$ dB in a 6.25 kHz band segment, for mobile and portable stations; (5) Compliance with the provisions of paragraphs (c)(2) of this section is based on the use of measurement instrumentation employing a resolution bandwidth of 100 kHz or greater. However, in the 100 kHz bands immediately outside and adjacent to the frequency block, a resolution bandwidth of at least 30 kHz may be employed; (6) Compliance with the provisions of paragraphs (c)(4) of this section is based on the use of measurement instrumentation such that the reading taken with any resolution bandwidth setting should be adjusted to indicate spectral energy in a 6.25 kHz segment.

FCC: §27.53

(m)(6) Measurement procedure. Compliance with these rules is based on the use of measurement instrumentation employing a resolution bandwidth of 1 megahertz or greater. However, in the 1 MHz bands immediately outside and adjacent to the frequency block a resolution bandwidth of at least one percent of the emission bandwidth of the fundamental emission of the transmitter may be employed;

for mobile digital stations, in the 1 megahertz bands immediately outside and adjacent to the frequency block a resolution bandwidth of at least two percent may be employed, except when the 1 megahertz band is 2495-2496 MHz, in which case a resolution bandwidth of at least one percent may be employed. A narrower resolution bandwidth is permitted in all cases to improve measurement accuracy provided the measured power is integrated over the full required measurement bandwidth (i.e. 1 megahertz or 1 percent of emission bandwidth, as specified; or 1 megahertz or 2 percent for mobile digital stations, except in the band 2495-2496 MHz). The emission bandwidth is defined as the width of the signal between two points, one below the carrier center frequency and one above the carrier center frequency, outside of which all emissions are attenuated at least 26 dB below the transmitter power. With respect to television operations, measurements must be made of the separate visual and aural operating powers at sufficiently frequent intervals to ensure compliance with the rules.

(m)(4) For mobile digital stations, the attenuation factor shall be not less than $40 + 10 \log (P)$ dB on all frequencies between the channel edge and 5 megahertz from the channel edge, $43 + 10 \log (P)$ dB on all frequencies between 5 megahertz and X megahertz from the channel edge, and $55 + 10 \log (P)$ dB on all frequencies more than X megahertz from the channel edge, where X is the greater of 6 megahertz or the actual emission bandwidth as defined in paragraph (m)(6) of this section. In addition, the attenuation factor shall not be less than $43 + 10 \log (P)$ dB on all frequencies between 2490.5 MHz and 2496 MHz and $55 + 10 \log (P)$ dB at or below 2490.5 MHz. Mobile Satellite Service licensees operating on frequencies below 2495 MHz may also submit a documented interference complaint against BRS licensees operating on channel BRS Channel 1 on the same terms and conditions as adjacent channel BRS or EBS licensees. Show citation box.

4.5.3 Test Procedures

1. The testing follows ANSI C63.26 Section 5.7.
2. The EUT was connected to the spectrum analyzer and system simulator via a power divider.
3. Start and stop frequency were set such that the band edge would be placed in the center of the plot
4. Span was set large enough so as to capture all out of band emissions near the band edge
5. RBW \geq 1% of the emission bandwidth
6. VBW \geq 3 x RBW
7. Detector = RMS
8. Number of sweep points \geq 2 x Span/RBW
9. Trace mode = trace average for continuous emissions, max hold for pulse emissions
10. Sweep time = auto couple
11. The trace was allowed to stabilize
12. The RF fundamental frequency should be excluded against the limit line in the operating

frequency band.

13. Checked that all the results comply with the emission limit line.

Example:

The limit line is derived from $43 + 10\log(P)$ dB below the transmitter power P(Watts)

$$= P(W) - [43 + 10\log(P)] \text{ (dB)}$$

$$= [30 + 10\log(P)] \text{ (dBm)} - [43 + 10\log(P)] \text{ (dB)}$$

$$= -13\text{dBm.}$$

For LTE Band 7, 38, 41, the other 40 dB, and 55 dB have additionally applied same calculation above.

4.5.4 Test Setup

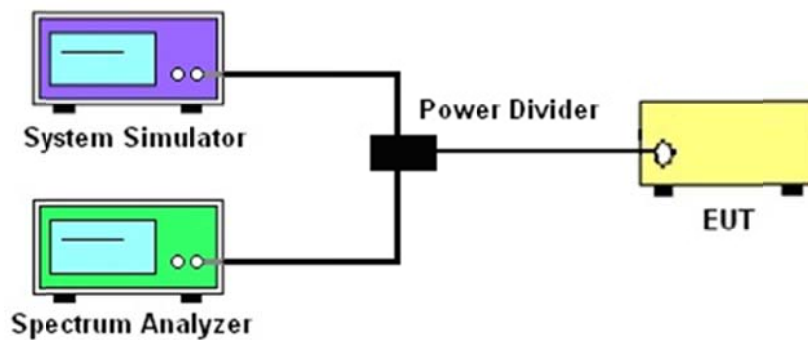

4.5.5 Test Results

Refer to Appendix A of this test report.

4.6 Conducted Spurious Emission

4.6.1 Description of Conducted Spurious Emission Measurement

The transmitter output was connected to a calibrated coaxial cable, attenuator and Spectrum analyzer, the other end of which was connected to a Base Station Simulator. The Base Station Simulator was set to force the EUT to its maximum power setting. The tests were performed at three frequencies (low channel and high channel). The level of the carrier and the various conducted spurious and harmonic frequencies is measured by means of a calibrated spectrum analyzer. The spectrum is scanned from the lowest frequency generated in the equipment up to a frequency including its 10th harmonic. On any frequency outside a licensee's frequency block, the power of any emission shall be attenuated below the transmitter power (P) by at least $43 + 10 \log(P)$ dB. Compliance with these provisions is based on the use of measurement instrumentation employing a resolution bandwidth of 1 MHz or greater. However, in the 1 MHz bands immediately outside and adjacent to the frequency block a resolution bandwidth of at least one percent of the emission bandwidth of the fundamental emission of the transmitter may be employed. The emission bandwidth is defined as the width of the signal between two points, one below the carrier center frequency and one above the carrier center frequency, outside of which all emission are attenuated at least 26 dB below the transmitter power.

4.6.2 Limit

The power of any emission outside of the authorized operating frequency ranges must be attenuated below the transmitting power (P) by a factor of at least $43 + 10 \log(P)$ dB.

§27.53(a)(4) For mobile and portable stations operating in the 2305-2315 MHz: by a factor of not less than $43 + 10 \log(P)$ dB on all frequencies between 2360 and 2365 MHz, and not less than $70 + 10 \log(P)$ dB above 2365 MHz.

§27.53(m)(4) For mobile digital stations, the attenuation factor shall be not less than $40 + 10 \log(P)$ dB on all frequencies between the channel edge and 5 megahertz from the channel edge, $43 + 10 \log(P)$ dB on all frequencies between 5 megahertz and X megahertz from the channel edge, and $55 + 10 \log(P)$ dB on all frequencies more than X megahertz from the channel edge, where X is the greater of 6 megahertz or the actual emission bandwidth as defined in paragraph (m)(6) of this section. In addition, the attenuation factor shall not be less than $43 + 10 \log(P)$ dB on all frequencies between 2490.5 MHz and 2496 MHz and $55 + 10 \log(P)$ dB at or below 2490.5 MHz. Mobile Satellite Service licensees operating on frequencies below 2495 MHz may also submit a documented interference complaint against BRS licensees operating on channel BRS Channel 1 on the same terms and conditions as adjacent channel BRS or EBS licensees.

4.6.3 Test Procedures

1. The testing follows ANSI C63.26 section 5.7.
2. The EUT was connected to the spectrum analyzer and system simulator via a power divider.
3. The RF output of EUT was connected to the spectrum analyzer by an RF cable and attenuator. The path loss was compensated to the results for each measurement.
4. The middle channel for the highest RF power within the transmitting frequency was measured.
5. The conducted spurious emission for the whole frequency range was taken.
6. The RF fundamental frequency should be excluded against the limit line in the operating frequency band.
7. The limit line is derived from $43 + 10\log(P)$ dB below the transmitter power P(Watts)

$$= P(W) - [43 + 10\log(P)] \text{ (dB)}$$

$$= [30 + 10\log(P)] \text{ (dBm)} - [43 + 10\log(P)] \text{ (dB)}$$

$$= -13\text{dBm}.$$
8. For Band 7, 38, 41

The limit line is derived from $55 + 10\log(P)$ dB below the transmitter power P(Watts)

$$= P(W) - [55 + 10\log(P)] \text{ (dB)}$$

$$= [30 + 10\log(P)] \text{ (dBm)} - [55 + 10\log(P)] \text{ (dB)}$$

$$= -25\text{dBm}.$$

4.6.4 Test Setup

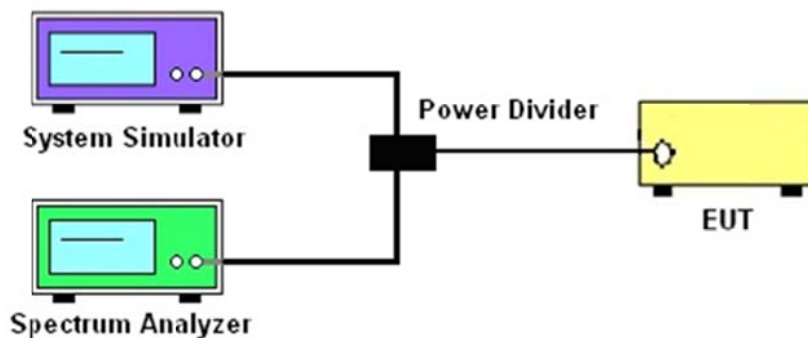

4.6.5 Test Results

Refer to Appendix A of this test report.

4.7 Frequency Stability

4.7.1 Description of Frequency Stability Measurement

The frequency stability shall be measured by variation of ambient temperature and variation of primary supply voltage to ensure that the fundamental emission stays within the authorized frequency block.

FCC §22.355

The carrier frequency shall not depart from the reference frequency in excess of ± 2.5 ppm for mobile stations.

FCC §24.235 & §27.54

The frequency stability shall be sufficient to ensure that the fundamental emission stays within the authorized frequency block.

4.7.2 Test Condition

Temp. = -30° to $+50^{\circ}$ C

Voltage = (85% - 115%)

4.7.3 Test Procedures for Temperature Variation

1. The testing follows ANSI C63.26 section 5.6.4.
2. The EUT was set up in the thermal chamber and connected with the system simulator.
3. With power OFF, the temperature was decreased to -30° C and the EUT was stabilized before testing. Power was applied and the maximum change in frequency was recorded within one minute.
4. With power OFF, the temperature was raised in 10° C steps up to 50° C. The EUT was stabilized at each step for at least half an hour. Power was applied and the maximum frequency change was recorded within one minute.

4.7.4 Test Procedures for Voltage Variation

1. The testing follows ANSI C63.26 section 5.6.5.
2. The EUT was placed in a temperature chamber at $25 \pm 5^{\circ}$ C and connected with the system simulator.
3. The power supply voltage to the EUT was varied from 85% to 115% of the nominal value measured at the input to the EUT.
4. The variation in frequency was measured for the worst case.

4.7.5 Test Setup

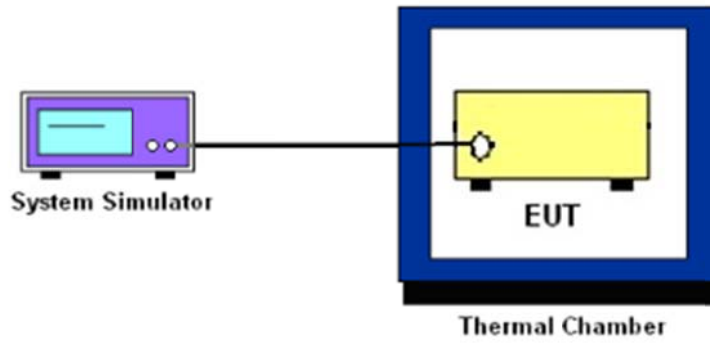

4.7.6 Test Results

Refer to Appendix A of this test report.

5 Radiated Test Items

5.1 Measuring Instruments

See list of measuring instruments of this test report.

5.2 Radiated Spurious Emission

5.2.1 Description of the Radiated Spurious Emission

The radiated spurious emission was measured by substitution method according to ANSI / TIA / EIA-603-E-2016. The power of any emission outside of the authorized operating frequency ranges must be attenuated below the transmitter power (P) by a factor of at least $43 + 10 \log (P)$ dB.

For Band 7, 38, 41

The power of any emission outside of the authorized operating frequency ranges must be attenuated below the transmitter power (P) by a factor of at least $55 + 10 \log (P)$ dB.

For LTE Band 12, 17

For operations in the 746-758 MHz, 775-788 MHz, and 805-806 MHz bands, emissions in the band 1559-1610 MHz shall be limited to -70 dBW/MHz equivalent isotropically radiated power (EIRP) for wideband signals, and -80 dBW EIRP for discrete emissions of less than 700 Hz bandwidth.

The spectrum is scanned from 30 MHz up to a frequency including its 10th harmonic.

5.2.2 Test Procedures

The testing follows FCC KDB 971168 D01 v03r01 Section 5.8 and ANSI / TIA-603-E-2016 Section 2.2.12.

Below 1GHz test procedure as below:

1. The EUT was powered ON and placed on a 80cm high table in the chamber. The antenna of the transmitter was extended to its maximum length.
2. Make the measurement with the spectrum analyzer's RBW = 100KHz, VBW = 100KHz, taking record of maximum spurious emission.
3. The disturbance of the transmitter was maximized on the test receiver display by raising and lowering from 1m to 4m (for the test frequency of below 30MHz, the antenna was tuned to heights 1 meter) the receive antenna and by rotating through 360° the turntable. After the fundamental emission was maximized, a field strength measurement was made.
4. Steps 1) and 2) were performed with the EUT and the receive antenna in both vertical and horizontal polarization.
5. The transmitter was then removed and replaced with another antenna. The center of the antenna was approximately at the same location as the center of the transmitter.
6. A signal at the disturbance was fed to the substitution antenna by means of a non-radiating cable. With both the substitution and the receive antennas horizontally polarized, the receive antenna was raised and lowered to obtain a maximum reading at the test receiver.

The level of the signal generator was adjusted until the measured field strength level in step 2) is obtained for this set of conditions.

7. The output power into the substitution antenna was then measured.
8. Steps 5) and 6) were repeated with both antennas polarized.
9. Calculate power in dBm by the following formula:

$$\text{ERP(dBm)} = \text{Pg(dBm)} - \text{cable loss (dB)} + \text{antenna gain (dBd)} - 2.15$$

Where:

P_d is the dipole equivalent power, P_g is the generator output into the substitution antenna, and the antenna gain is the gain of the substitute antenna used relative to either a half-wave dipole (dBd) or an isotropic source (dBi). The substitute level is equal to P_g [dBm] – cable loss [dB]. The calculated P_d levels are then compared to the absolute spurious emission limit of -13dBm which is equivalent to the required minimum attenuation of $43 + 10\log_{10}(\text{Power [Watts]})$.

10. For Band 7, 38, 41:

The limit line is derived from $55 + 10\log(P)$ dB below the transmitter power P (Watts)

Above 1GHz test procedure as below:

1. The EUT was powered ON and placed on a 150cm high table in the chamber. The antenna of the transmitter was extended to its maximum length.
2. Make the measurement with the spectrum analyzer's RBW = 1MHz, VBW = 3MHz, taking record of maximum spurious emission.
3. The disturbance of the transmitter was maximized on the test receiver display by raising and lowering from 1m to 4m (for the test frequency of below 30MHz, the antenna was tuned to heights 1 meter) the receive antenna and by rotating through 360° the turntable. After the fundamental emission was maximized, a field strength measurement was made.
4. Steps 1) and 2) were performed with the EUT and the receive antenna in both vertical and horizontal polarization.
5. The transmitter was then removed and replaced with another antenna. The center of the antenna was approximately at the same location as the center of the transmitter.
6. A signal at the disturbance was fed to the substitution antenna by means of a non-radiating cable. With both the substitution and the receive antennas horizontally polarized, the receive antenna was raised and lowered to obtain a maximum reading at the test receiver. The level of the signal generator was adjusted until the measured field strength level in step 2) is obtained for this set of conditions.
7. The output power into the substitution antenna was then measured.
8. Steps 5) and 6) were repeated with both antennas polarized.
9. Calculate power in dBm by the following formula:

$$\text{EIRP(dBm)} = \text{Pg(dBm)} - \text{cable loss (dB)} + \text{antenna gain (dBd)}$$

Where:

P_d is the dipole equivalent power, P_g is the generator output into the substitution antenna, and the antenna gain is the gain of the substitute antenna used relative to either a half-wave dipole (dBd) or an isotropic source (dBi). The substitute level is equal to P_g [dBm] – cable loss [dB]. The calculated P_d levels are then compared to the absolute spurious emission limit of -13dBm which is equivalent to the required minimum attenuation of $43 + 10\log_{10}(\text{Power [Watts]})$. $\text{EIRP (dBm)} = \text{S.G. Power} - \text{Tx Cable Loss} + \text{Tx Antenna Gain}$

11. $\text{ERP (dBm)} = \text{EIRP} - 2.15$

12. The RF fundamental frequency should be excluded against the limit line in the operating frequency band.

The limit line is derived from $43 + 10\log(P)$ dB below the transmitter power P (Watts)
 $= P(W) - [43 + 10\log(P)]$ (dB)
 $= [30 + 10\log(P)]$ (dBm) - $[43 + 10\log(P)]$ (dB)
 $= -13\text{dBm}$.

13. For Band 7, 38, 41:

The limit line is derived from $55 + 10\log(P)$ dB below the transmitter power P (Watts)

5.2.3 Test Setup

For radiated test from 30MHz to 1GHz

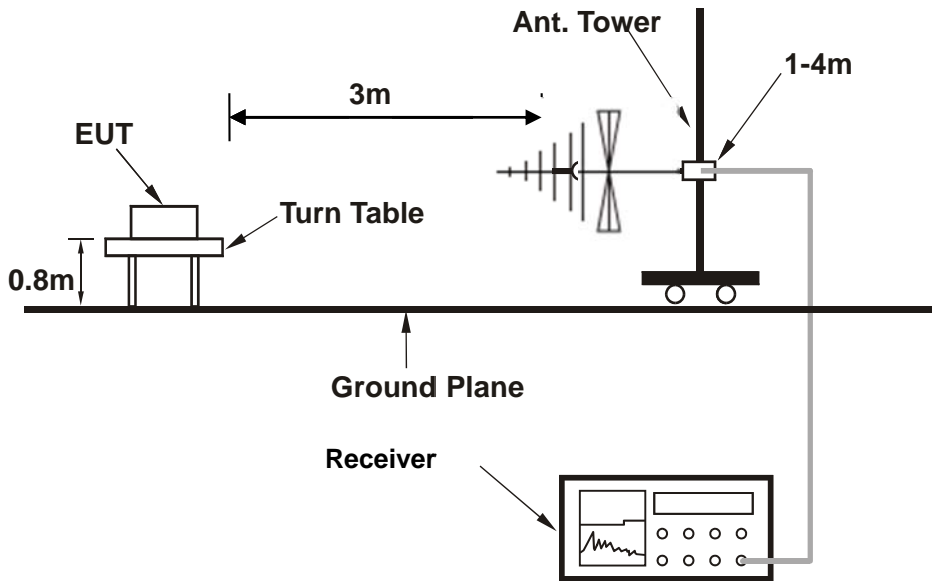

For radiated test above 1GHz

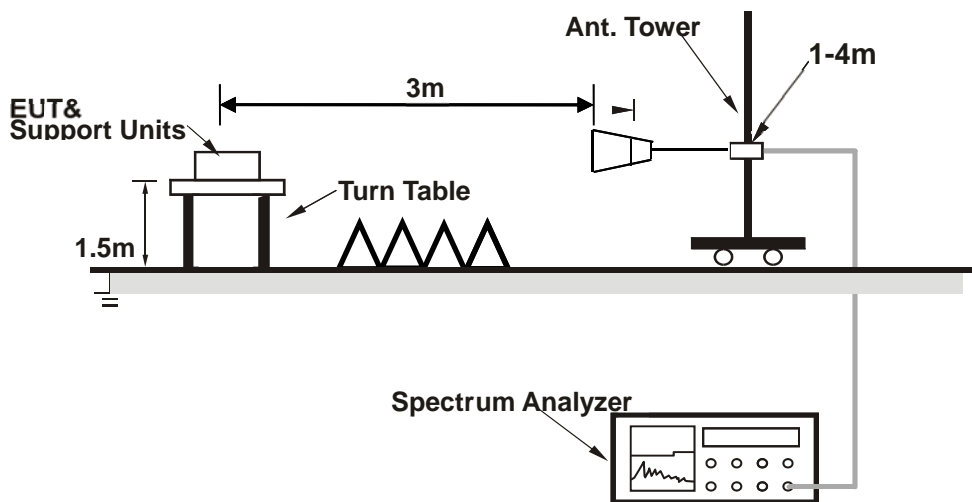

5.2.4 Test Results

Refer to Appendix B of this test report.

6 List of Measuring Equipment

Instrument	Manufacturer	Model No.	Serial No.	Calibration Date	Due Date	Remark
Spectrum Analyzer	Keysight	N9010A	MY56070788	2018/3/2	2019/3/1	Conducted
Base Station	R&S	CMW500	164998	2018/3/17	2019/3/16	Conducted
Thermal Chamber	Sanmtest	SMC-408-CD	2435	2018/7/05	2019/7/04	Conducted
Signal Generator (Interferer)	Keysight	N5182B	MY56200384	2018/4/10	2019/4/09	Conducted
Signal Generator (Blocker)	Keysight	N5171B	MY56200661	2018/3/2	2019/3/1	Conducted

Instrument	Manufacturer	Model No.	Serial No.	Calibration Date	Due Date	Remark
Spectrum Analyzer	R&S	FSV 40	101433	2018/3/14	2019/3/13	Radiation
Amplifier	Sonoma	310	363917	2018/3/6	2019/3/5	Radiation
Amplifier	Schwarzbeck	BBV 9718	327	2018/3/14	2019/3/13	Radiation
Amplifier	Narda	TTA1840-35-HG	2034380	2018-07-18	2019-07-17	Radiation
Loop Antenna	Schwarzbeck	FMZB 1519 B	1519B-051	2017/3/3	2020/3/2	Radiation
Broadband Antenna	Schwarzbeck	VULB 9168	9168-757	2017/3/3	2020/3/2	Radiation
Horn Antenna	Schwarzbeck	BBHA 9120 D	1677	2017/3/3	2020/3/2	Radiation
Horn Antenna	COM-POWER	AH-1840	101117	2018-06-20	2021-06-19	Radiation
Signal Generator (Blocker)	R&S	SMB100A	180717	2018/3/15	2019/3/14	Radiation
Test Software	Auidx	E3	6.111221a	N/A	N/A	Radiation

N/A: No Calibration Required

7 Uncertainty of Evaluation

Uncertainty of Radiated Emission Measurement (30 MHz ~ 1000 MHz)

Measuring Uncertainty for a Level of Confidence of 95% ($U = 2Uc(y)$)	2.5 dB
---	--------

Uncertainty of Radiated Emission Measurement (1GHz ~ 18GHz)

Measuring Uncertainty for a Level of Confidence of 95% ($U = 2Uc(y)$)	3.51dB
---	--------

Uncertainty of Radiated Emission Measurement (18GHz ~ 40GHz)

Measuring Uncertainty for a Level of Confidence of 95% ($U = 2Uc(y)$)	3.96dB
---	--------

Appendix A: TEST RESULTS OF CONDUCTED TEST

Conducted Output Power(Average power)

Band	Bandwidth	Modulation	Channel	RB Configuration	Result(dBm)
Band2	1.4MHz	QPSK	18607	1RB#0	23.12
Band2	1.4MHz	QPSK	18607	1RB#2	23.11
Band2	1.4MHz	QPSK	18607	1RB#5	23.14
Band2	1.4MHz	QPSK	18607	3RB#0	23.59
Band2	1.4MHz	QPSK	18607	3RB#1	23.59
Band2	1.4MHz	QPSK	18607	3RB#3	23.59
Band2	1.4MHz	QPSK	18607	6RB#0	22.58
Band2	1.4MHz	QPSK	18900	1RB#0	23.66
Band2	1.4MHz	QPSK	18900	1RB#2	23.69
Band2	1.4MHz	QPSK	18900	1RB#5	23.76
Band2	1.4MHz	QPSK	18900	3RB#0	24.20
Band2	1.4MHz	QPSK	18900	3RB#1	24.21
Band2	1.4MHz	QPSK	18900	3RB#3	24.15
Band2	1.4MHz	QPSK	18900	6RB#0	23.19
Band2	1.4MHz	QPSK	19193	1RB#0	23.46
Band2	1.4MHz	QPSK	19193	1RB#2	23.54
Band2	1.4MHz	QPSK	19193	1RB#5	23.46
Band2	1.4MHz	QPSK	19193	3RB#0	23.86
Band2	1.4MHz	QPSK	19193	3RB#1	23.87
Band2	1.4MHz	QPSK	19193	3RB#3	23.88
Band2	1.4MHz	QPSK	19193	6RB#0	22.87
Band2	1.4MHz	16QAM	18607	1RB#0	23.36
Band2	1.4MHz	16QAM	18607	1RB#2	23.38
Band2	1.4MHz	16QAM	18607	1RB#5	23.38
Band2	1.4MHz	16QAM	18607	3RB#0	22.46
Band2	1.4MHz	16QAM	18607	3RB#1	22.43
Band2	1.4MHz	16QAM	18607	3RB#3	22.49
Band2	1.4MHz	16QAM	18607	6RB#0	21.77
Band2	1.4MHz	16QAM	18900	1RB#0	23.99
Band2	1.4MHz	16QAM	18900	1RB#2	24.02
Band2	1.4MHz	16QAM	18900	1RB#5	24.08
Band2	1.4MHz	16QAM	18900	3RB#0	23.06
Band2	1.4MHz	16QAM	18900	3RB#1	23.06

Band2	1.4MHz	16QAM	18900	3RB#3	23.05
Band2	1.4MHz	16QAM	18900	6RB#0	22.44
Band2	1.4MHz	16QAM	19193	1RB#0	23.86
Band2	1.4MHz	16QAM	19193	1RB#2	23.71
Band2	1.4MHz	16QAM	19193	1RB#5	23.66
Band2	1.4MHz	16QAM	19193	3RB#0	22.87
Band2	1.4MHz	16QAM	19193	3RB#1	22.86
Band2	1.4MHz	16QAM	19193	3RB#3	22.84
Band2	1.4MHz	16QAM	19193	6RB#0	22.21
Band2	3MHz	QPSK	18615	1RB#0	23.12
Band2	3MHz	QPSK	18615	1RB#8	23.15
Band2	3MHz	QPSK	18615	1RB#14	23.16
Band2	3MHz	QPSK	18615	8RB#0	22.38
Band2	3MHz	QPSK	18615	8RB#4	22.37
Band2	3MHz	QPSK	18615	8RB#7	22.41
Band2	3MHz	QPSK	18615	15RB#0	22.37
Band2	3MHz	QPSK	18900	1RB#0	23.50
Band2	3MHz	QPSK	18900	1RB#8	23.48
Band2	3MHz	QPSK	18900	1RB#14	23.54
Band2	3MHz	QPSK	18900	8RB#0	23.07
Band2	3MHz	QPSK	18900	8RB#4	23.07
Band2	3MHz	QPSK	18900	8RB#7	23.10
Band2	3MHz	QPSK	18900	15RB#0	23.06
Band2	3MHz	QPSK	19185	1RB#0	23.20
Band2	3MHz	QPSK	19185	1RB#8	23.20
Band2	3MHz	QPSK	19185	1RB#14	23.08
Band2	3MHz	QPSK	19185	8RB#0	22.81
Band2	3MHz	QPSK	19185	8RB#4	22.80
Band2	3MHz	QPSK	19185	8RB#7	22.80
Band2	3MHz	QPSK	19185	15RB#0	22.78
Band2	3MHz	16QAM	18615	1RB#0	22.99
Band2	3MHz	16QAM	18615	1RB#8	23.05
Band2	3MHz	16QAM	18615	1RB#14	22.94
Band2	3MHz	16QAM	18615	8RB#0	21.80
Band2	3MHz	16QAM	18615	8RB#4	21.81
Band2	3MHz	16QAM	18615	8RB#7	21.81
Band2	3MHz	16QAM	18615	15RB#0	21.30
Band2	3MHz	16QAM	18900	1RB#0	23.20

Band2	3MHz	16QAM	18900	1RB#8	23.20
Band2	3MHz	16QAM	18900	1RB#14	23.22
Band2	3MHz	16QAM	18900	8RB#0	22.38
Band2	3MHz	16QAM	18900	8RB#4	22.39
Band2	3MHz	16QAM	18900	8RB#7	22.38
Band2	3MHz	16QAM	18900	15RB#0	22.20
Band2	3MHz	16QAM	19185	1RB#0	23.02
Band2	3MHz	16QAM	19185	1RB#8	23.04
Band2	3MHz	16QAM	19185	1RB#14	22.99
Band2	3MHz	16QAM	19185	8RB#0	22.15
Band2	3MHz	16QAM	19185	8RB#4	22.11
Band2	3MHz	16QAM	19185	8RB#7	22.15
Band2	3MHz	16QAM	19185	15RB#0	21.97
Band2	5MHz	QPSK	18625	1RB#0	23.00
Band2	5MHz	QPSK	18625	1RB#12	23.07
Band2	5MHz	QPSK	18625	1RB#24	22.99
Band2	5MHz	QPSK	18625	12RB#0	22.39
Band2	5MHz	QPSK	18625	12RB#6	22.41
Band2	5MHz	QPSK	18625	12RB#13	22.42
Band2	5MHz	QPSK	18625	25RB#0	22.38
Band2	5MHz	QPSK	18900	1RB#0	23.72
Band2	5MHz	QPSK	18900	1RB#12	23.75
Band2	5MHz	QPSK	18900	1RB#24	23.76
Band2	5MHz	QPSK	18900	12RB#0	23.02
Band2	5MHz	QPSK	18900	12RB#6	23.02
Band2	5MHz	QPSK	18900	12RB#13	23.04
Band2	5MHz	QPSK	18900	25RB#0	23.04
Band2	5MHz	QPSK	19175	1RB#0	23.46
Band2	5MHz	QPSK	19175	1RB#12	23.42
Band2	5MHz	QPSK	19175	1RB#24	23.54
Band2	5MHz	QPSK	19175	12RB#0	22.78
Band2	5MHz	QPSK	19175	12RB#6	22.79
Band2	5MHz	QPSK	19175	12RB#13	22.78
Band2	5MHz	QPSK	19175	25RB#0	22.78
Band2	5MHz	16QAM	18625	1RB#0	22.84
Band2	5MHz	16QAM	18625	1RB#12	22.85
Band2	5MHz	16QAM	18625	1RB#24	22.88
Band2	5MHz	16QAM	18625	12RB#0	21.70

Band2	5MHz	16QAM	18625	12RB#6	21.70
Band2	5MHz	16QAM	18625	12RB#13	21.60
Band2	5MHz	16QAM	18625	25RB#0	21.48
Band2	5MHz	16QAM	18900	1RB#0	23.22
Band2	5MHz	16QAM	18900	1RB#12	23.24
Band2	5MHz	16QAM	18900	1RB#24	23.24
Band2	5MHz	16QAM	18900	12RB#0	22.15
Band2	5MHz	16QAM	18900	12RB#6	22.16
Band2	5MHz	16QAM	18900	12RB#13	22.17
Band2	5MHz	16QAM	18900	25RB#0	22.15
Band2	5MHz	16QAM	19175	1RB#0	22.99
Band2	5MHz	16QAM	19175	1RB#12	22.95
Band2	5MHz	16QAM	19175	1RB#24	22.95
Band2	5MHz	16QAM	19175	12RB#0	21.93
Band2	5MHz	16QAM	19175	12RB#6	21.94
Band2	5MHz	16QAM	19175	12RB#13	21.98
Band2	5MHz	16QAM	19175	25RB#0	21.97
Band2	10MHz	QPSK	18650	1RB#0	23.04
Band2	10MHz	QPSK	18650	1RB#24	23.01
Band2	10MHz	QPSK	18650	1RB#49	22.97
Band2	10MHz	QPSK	18650	25RB#0	22.33
Band2	10MHz	QPSK	18650	25RB#12	22.35
Band2	10MHz	QPSK	18650	25RB#25	22.28
Band2	10MHz	QPSK	18650	50RB#0	22.22
Band2	10MHz	QPSK	18900	1RB#0	23.52
Band2	10MHz	QPSK	18900	1RB#24	23.45
Band2	10MHz	QPSK	18900	1RB#49	23.36
Band2	10MHz	QPSK	18900	25RB#0	23.04
Band2	10MHz	QPSK	18900	25RB#12	23.05
Band2	10MHz	QPSK	18900	25RB#25	23.06
Band2	10MHz	QPSK	18900	50RB#0	23.03
Band2	10MHz	QPSK	19150	1RB#0	23.18
Band2	10MHz	QPSK	19150	1RB#24	23.19
Band2	10MHz	QPSK	19150	1RB#49	23.00
Band2	10MHz	QPSK	19150	25RB#0	22.82
Band2	10MHz	QPSK	19150	25RB#12	22.79
Band2	10MHz	QPSK	19150	25RB#25	22.77
Band2	10MHz	QPSK	19150	50RB#0	22.78



Band2	10MHz	16QAM	18650	1RB#0	22.99
Band2	10MHz	16QAM	18650	1RB#24	22.84
Band2	10MHz	16QAM	18650	1RB#49	22.79
Band2	10MHz	16QAM	18650	25RB#0	21.51
Band2	10MHz	16QAM	18650	25RB#12	21.50
Band2	10MHz	16QAM	18650	25RB#25	21.49
Band2	10MHz	16QAM	18650	50RB#0	21.46
Band2	10MHz	16QAM	18900	1RB#0	23.28
Band2	10MHz	16QAM	18900	1RB#24	23.31
Band2	10MHz	16QAM	18900	1RB#49	23.38
Band2	10MHz	16QAM	18900	25RB#0	22.09
Band2	10MHz	16QAM	18900	25RB#12	22.06
Band2	10MHz	16QAM	18900	25RB#25	22.08
Band2	10MHz	16QAM	18900	50RB#0	22.09
Band2	10MHz	16QAM	19150	1RB#0	23.09
Band2	10MHz	16QAM	19150	1RB#24	23.09
Band2	10MHz	16QAM	19150	1RB#49	23.07
Band2	10MHz	16QAM	19150	25RB#0	21.85
Band2	10MHz	16QAM	19150	25RB#12	21.84
Band2	10MHz	16QAM	19150	25RB#25	21.87
Band2	10MHz	16QAM	19150	50RB#0	21.86
Band2	15MHz	QPSK	18675	1RB#0	22.98
Band2	15MHz	QPSK	18675	1RB#38	22.90
Band2	15MHz	QPSK	18675	1RB#74	22.86
Band2	15MHz	QPSK	18675	38RB#0	22.95
Band2	15MHz	QPSK	18675	38RB#18	22.89
Band2	15MHz	QPSK	18675	38RB#37	22.90
Band2	15MHz	QPSK	18675	75RB#0	22.23
Band2	15MHz	QPSK	18900	1RB#0	23.49
Band2	15MHz	QPSK	18900	1RB#38	23.44
Band2	15MHz	QPSK	18900	1RB#74	23.52
Band2	15MHz	QPSK	18900	38RB#0	23.50
Band2	15MHz	QPSK	18900	38RB#18	23.38
Band2	15MHz	QPSK	18900	38RB#37	23.53
Band2	15MHz	QPSK	18900	75RB#0	23.03
Band2	15MHz	QPSK	19125	1RB#0	23.28
Band2	15MHz	QPSK	19125	1RB#38	23.19
Band2	15MHz	QPSK	19125	1RB#74	23.03

Band2	15MHz	QPSK	19125	38RB#0	23.29
Band2	15MHz	QPSK	19125	38RB#18	23.19
Band2	15MHz	QPSK	19125	38RB#37	23.05
Band2	15MHz	QPSK	19125	75RB#0	22.80
Band2	15MHz	16QAM	18675	1RB#0	22.71
Band2	15MHz	16QAM	18675	1RB#38	22.60
Band2	15MHz	16QAM	18675	1RB#74	22.61
Band2	15MHz	16QAM	18675	38RB#0	22.70
Band2	15MHz	16QAM	18675	38RB#18	22.58
Band2	15MHz	16QAM	18675	38RB#37	22.59
Band2	15MHz	16QAM	18675	75RB#0	21.36
Band2	15MHz	16QAM	18900	1RB#0	23.27
Band2	15MHz	16QAM	18900	1RB#38	23.25
Band2	15MHz	16QAM	18900	1RB#74	23.35
Band2	15MHz	16QAM	18900	38RB#0	23.22
Band2	15MHz	16QAM	18900	38RB#18	23.24
Band2	15MHz	16QAM	18900	38RB#37	23.36
Band2	15MHz	16QAM	18900	75RB#0	22.08
Band2	15MHz	16QAM	19125	1RB#0	23.09
Band2	15MHz	16QAM	19125	1RB#38	23.00
Band2	15MHz	16QAM	19125	1RB#74	23.01
Band2	15MHz	16QAM	19125	38RB#0	23.13
Band2	15MHz	16QAM	19125	38RB#18	23.04
Band2	15MHz	16QAM	19125	38RB#37	23.03
Band2	15MHz	16QAM	19125	75RB#0	21.85
Band2	20MHz	QPSK	18700	1RB#0	23.24
Band2	20MHz	QPSK	18700	1RB#49	23.15
Band2	20MHz	QPSK	18700	1RB#99	23.26
Band2	20MHz	QPSK	18700	50RB#0	22.22
Band2	20MHz	QPSK	18700	50RB#25	22.18
Band2	20MHz	QPSK	18700	50RB#50	22.17
Band2	20MHz	QPSK	18700	100RB#0	22.16
Band2	20MHz	QPSK	18900	1RB#0	23.65
Band2	20MHz	QPSK	18900	1RB#49	23.62
Band2	20MHz	QPSK	18900	1RB#99	23.68
Band2	20MHz	QPSK	18900	50RB#0	23.04
Band2	20MHz	QPSK	18900	50RB#25	23.04
Band2	20MHz	QPSK	18900	50RB#50	23.04

Band2	20MHz	QPSK	18900	100RB#0	23.06
Band2	20MHz	QPSK	19100	1RB#0	23.40
Band2	20MHz	QPSK	19100	1RB#49	23.27
Band2	20MHz	QPSK	19100	1RB#99	23.23
Band2	20MHz	QPSK	19100	50RB#0	22.37
Band2	20MHz	QPSK	19100	50RB#25	22.37
Band2	20MHz	QPSK	19100	50RB#50	22.30
Band2	20MHz	QPSK	19100	100RB#0	22.32
Band2	20MHz	16QAM	18700	1RB#0	22.87
Band2	20MHz	16QAM	18700	1RB#49	22.70
Band2	20MHz	16QAM	18700	1RB#99	22.89
Band2	20MHz	16QAM	18700	50RB#0	21.41
Band2	20MHz	16QAM	18700	50RB#25	21.42
Band2	20MHz	16QAM	18700	50RB#50	21.46
Band2	20MHz	16QAM	18700	100RB#0	21.35
Band2	20MHz	16QAM	18900	1RB#0	23.15
Band2	20MHz	16QAM	18900	1RB#49	23.02
Band2	20MHz	16QAM	18900	1RB#99	23.07
Band2	20MHz	16QAM	18900	50RB#0	22.07
Band2	20MHz	16QAM	18900	50RB#25	22.08
Band2	20MHz	16QAM	18900	50RB#50	22.11
Band2	20MHz	16QAM	18900	100RB#0	22.11
Band2	20MHz	16QAM	19100	1RB#0	22.53
Band2	20MHz	16QAM	19100	1RB#49	22.49
Band2	20MHz	16QAM	19100	1RB#99	22.38
Band2	20MHz	16QAM	19100	50RB#0	21.47
Band2	20MHz	16QAM	19100	50RB#25	21.46
Band2	20MHz	16QAM	19100	50RB#50	21.41
Band2	20MHz	16QAM	19100	100RB#0	21.48
Band5	1.4MHz	QPSK	20407	1RB#0	22.20
Band5	1.4MHz	QPSK	20407	1RB#2	22.22
Band5	1.4MHz	QPSK	20407	1RB#5	22.19
Band5	1.4MHz	QPSK	20407	3RB#0	22.65
Band5	1.4MHz	QPSK	20407	3RB#1	22.65
Band5	1.4MHz	QPSK	20407	3RB#3	22.65
Band5	1.4MHz	QPSK	20407	6RB#0	21.52
Band5	1.4MHz	QPSK	20525	1RB#0	22.24
Band5	1.4MHz	QPSK	20525	1RB#2	22.29

Band5	1.4MHz	QPSK	20525	1RB#5	22.26
Band5	1.4MHz	QPSK	20525	3RB#0	22.81
Band5	1.4MHz	QPSK	20525	3RB#1	22.79
Band5	1.4MHz	QPSK	20525	3RB#3	22.78
Band5	1.4MHz	QPSK	20525	6RB#0	21.68
Band5	1.4MHz	QPSK	20643	1RB#0	22.79
Band5	1.4MHz	QPSK	20643	1RB#2	22.75
Band5	1.4MHz	QPSK	20643	1RB#5	22.97
Band5	1.4MHz	QPSK	20643	3RB#0	23.58
Band5	1.4MHz	QPSK	20643	3RB#1	23.54
Band5	1.4MHz	QPSK	20643	3RB#3	23.30
Band5	1.4MHz	QPSK	20643	6RB#0	21.90
Band5	1.4MHz	16QAM	20407	1RB#0	22.36
Band5	1.4MHz	16QAM	20407	1RB#2	22.36
Band5	1.4MHz	16QAM	20407	1RB#5	22.35
Band5	1.4MHz	16QAM	20407	3RB#0	21.51
Band5	1.4MHz	16QAM	20407	3RB#1	21.50
Band5	1.4MHz	16QAM	20407	3RB#3	21.46
Band5	1.4MHz	16QAM	20407	6RB#0	20.98
Band5	1.4MHz	16QAM	20525	1RB#0	22.44
Band5	1.4MHz	16QAM	20525	1RB#2	22.48
Band5	1.4MHz	16QAM	20525	1RB#5	22.46
Band5	1.4MHz	16QAM	20525	3RB#0	21.69
Band5	1.4MHz	16QAM	20525	3RB#1	21.69
Band5	1.4MHz	16QAM	20525	3RB#3	21.62
Band5	1.4MHz	16QAM	20525	6RB#0	21.23
Band5	1.4MHz	16QAM	20643	1RB#0	22.99
Band5	1.4MHz	16QAM	20643	1RB#2	23.16
Band5	1.4MHz	16QAM	20643	1RB#5	22.99
Band5	1.4MHz	16QAM	20643	3RB#0	22.00
Band5	1.4MHz	16QAM	20643	3RB#1	22.02
Band5	1.4MHz	16QAM	20643	3RB#3	22.10
Band5	1.4MHz	16QAM	20643	6RB#0	21.65
Band5	3MHz	QPSK	20415	1RB#0	21.73
Band5	3MHz	QPSK	20415	1RB#8	21.70
Band5	3MHz	QPSK	20415	1RB#14	21.72
Band5	3MHz	QPSK	20415	8RB#0	21.12
Band5	3MHz	QPSK	20415	8RB#4	21.05

Band5	3MHz	QPSK	20415	8RB#7	21.15
Band5	3MHz	QPSK	20415	15RB#0	21.10
Band5	3MHz	QPSK	20525	1RB#0	22.03
Band5	3MHz	QPSK	20525	1RB#8	22.10
Band5	3MHz	QPSK	20525	1RB#14	22.03
Band5	3MHz	QPSK	20525	8RB#0	21.55
Band5	3MHz	QPSK	20525	8RB#4	21.57
Band5	3MHz	QPSK	20525	8RB#7	21.54
Band5	3MHz	QPSK	20525	15RB#0	21.55
Band5	3MHz	QPSK	20635	1RB#0	22.64
Band5	3MHz	QPSK	20635	1RB#8	22.61
Band5	3MHz	QPSK	20635	1RB#14	22.30
Band5	3MHz	QPSK	20635	8RB#0	22.03
Band5	3MHz	QPSK	20635	8RB#4	22.02
Band5	3MHz	QPSK	20635	8RB#7	21.88
Band5	3MHz	QPSK	20635	15RB#0	22.00
Band5	3MHz	16QAM	20415	1RB#0	21.41
Band5	3MHz	16QAM	20415	1RB#8	21.40
Band5	3MHz	16QAM	20415	1RB#14	21.38
Band5	3MHz	16QAM	20415	8RB#0	20.74
Band5	3MHz	16QAM	20415	8RB#4	20.76
Band5	3MHz	16QAM	20415	8RB#7	20.74
Band5	3MHz	16QAM	20415	15RB#0	20.60
Band5	3MHz	16QAM	20525	1RB#0	21.78
Band5	3MHz	16QAM	20525	1RB#8	21.71
Band5	3MHz	16QAM	20525	1RB#14	21.74
Band5	3MHz	16QAM	20525	8RB#0	21.12
Band5	3MHz	16QAM	20525	8RB#4	21.11
Band5	3MHz	16QAM	20525	8RB#7	21.08
Band5	3MHz	16QAM	20525	15RB#0	20.90
Band5	3MHz	16QAM	20635	1RB#0	22.31
Band5	3MHz	16QAM	20635	1RB#8	22.20
Band5	3MHz	16QAM	20635	1RB#14	22.17
Band5	3MHz	16QAM	20635	8RB#0	21.56
Band5	3MHz	16QAM	20635	8RB#4	21.54
Band5	3MHz	16QAM	20635	8RB#7	21.55
Band5	3MHz	16QAM	20635	15RB#0	21.44
Band5	5MHz	QPSK	20425	1RB#0	21.99

Band5	5MHz	QPSK	20425	1RB#12	22.20
Band5	5MHz	QPSK	20425	1RB#24	22.17
Band5	5MHz	QPSK	20425	12RB#0	21.16
Band5	5MHz	QPSK	20425	12RB#6	21.13
Band5	5MHz	QPSK	20425	12RB#13	21.17
Band5	5MHz	QPSK	20425	25RB#0	21.15
Band5	5MHz	QPSK	20525	1RB#0	22.43
Band5	5MHz	QPSK	20525	1RB#12	22.37
Band5	5MHz	QPSK	20525	1RB#24	22.31
Band5	5MHz	QPSK	20525	12RB#0	21.56
Band5	5MHz	QPSK	20525	12RB#6	21.56
Band5	5MHz	QPSK	20525	12RB#13	21.51
Band5	5MHz	QPSK	20525	25RB#0	21.55
Band5	5MHz	QPSK	20625	1RB#0	22.94
Band5	5MHz	QPSK	20625	1RB#12	22.89
Band5	5MHz	QPSK	20625	1RB#24	22.88
Band5	5MHz	QPSK	20625	12RB#0	22.01
Band5	5MHz	QPSK	20625	12RB#6	21.99
Band5	5MHz	QPSK	20625	12RB#13	22.03
Band5	5MHz	QPSK	20625	25RB#0	21.94
Band5	5MHz	16QAM	20425	1RB#0	21.34
Band5	5MHz	16QAM	20425	1RB#12	21.36
Band5	5MHz	16QAM	20425	1RB#24	21.36
Band5	5MHz	16QAM	20425	12RB#0	20.53
Band5	5MHz	16QAM	20425	12RB#6	20.55
Band5	5MHz	16QAM	20425	12RB#13	20.50
Band5	5MHz	16QAM	20425	25RB#0	20.53
Band5	5MHz	16QAM	20525	1RB#0	21.71
Band5	5MHz	16QAM	20525	1RB#12	21.59
Band5	5MHz	16QAM	20525	1RB#24	21.56
Band5	5MHz	16QAM	20525	12RB#0	20.91
Band5	5MHz	16QAM	20525	12RB#6	20.88
Band5	5MHz	16QAM	20525	12RB#13	20.89
Band5	5MHz	16QAM	20525	25RB#0	20.85
Band5	5MHz	16QAM	20625	1RB#0	22.11
Band5	5MHz	16QAM	20625	1RB#12	22.11
Band5	5MHz	16QAM	20625	1RB#24	22.11
Band5	5MHz	16QAM	20625	12RB#0	21.18

Band5	5MHz	16QAM	20625	12RB#6	21.18
Band5	5MHz	16QAM	20625	12RB#13	21.36
Band5	5MHz	16QAM	20625	25RB#0	21.34
Band5	10MHz	QPSK	20450	1RB#0	21.66
Band5	10MHz	QPSK	20450	1RB#24	21.65
Band5	10MHz	QPSK	20450	1RB#49	21.61
Band5	10MHz	QPSK	20450	25RB#0	21.10
Band5	10MHz	QPSK	20450	25RB#12	21.14
Band5	10MHz	QPSK	20450	25RB#25	21.03
Band5	10MHz	QPSK	20450	50RB#0	21.14
Band5	10MHz	QPSK	20525	1RB#0	21.96
Band5	10MHz	QPSK	20525	1RB#24	22.03
Band5	10MHz	QPSK	20525	1RB#49	22.03
Band5	10MHz	QPSK	20525	25RB#0	21.55
Band5	10MHz	QPSK	20525	25RB#12	21.55
Band5	10MHz	QPSK	20525	25RB#25	21.43
Band5	10MHz	QPSK	20525	50RB#0	21.54
Band5	10MHz	QPSK	20600	1RB#0	22.32
Band5	10MHz	QPSK	20600	1RB#24	22.28
Band5	10MHz	QPSK	20600	1RB#49	22.31
Band5	10MHz	QPSK	20600	25RB#0	21.69
Band5	10MHz	QPSK	20600	25RB#12	21.68
Band5	10MHz	QPSK	20600	25RB#25	21.77
Band5	10MHz	QPSK	20600	50RB#0	21.75
Band5	10MHz	16QAM	20450	1RB#0	21.41
Band5	10MHz	16QAM	20450	1RB#24	21.40
Band5	10MHz	16QAM	20450	1RB#49	21.37
Band5	10MHz	16QAM	20450	25RB#0	20.52
Band5	10MHz	16QAM	20450	25RB#12	20.51
Band5	10MHz	16QAM	20450	25RB#25	20.53
Band5	10MHz	16QAM	20450	50RB#0	20.52
Band5	10MHz	16QAM	20525	1RB#0	21.79
Band5	10MHz	16QAM	20525	1RB#24	21.71
Band5	10MHz	16QAM	20525	1RB#49	21.78
Band5	10MHz	16QAM	20525	25RB#0	20.90
Band5	10MHz	16QAM	20525	25RB#12	20.90
Band5	10MHz	16QAM	20525	25RB#25	20.86
Band5	10MHz	16QAM	20525	50RB#0	20.90

Band5	10MHz	16QAM	20600	1RB#0	21.99
Band5	10MHz	16QAM	20600	1RB#24	22.08
Band5	10MHz	16QAM	20600	1RB#49	22.11
Band5	10MHz	16QAM	20600	25RB#0	21.08
Band5	10MHz	16QAM	20600	25RB#12	21.08
Band5	10MHz	16QAM	20600	25RB#25	21.27
Band5	10MHz	16QAM	20600	50RB#0	21.10
Band7	5MHz	QPSK	20775	1RB#0	22.64
Band7	5MHz	QPSK	20775	1RB#12	22.67
Band7	5MHz	QPSK	20775	1RB#24	22.69
Band7	5MHz	QPSK	20775	12RB#0	22.10
Band7	5MHz	QPSK	20775	12RB#6	22.11
Band7	5MHz	QPSK	20775	12RB#13	22.17
Band7	5MHz	QPSK	20775	25RB#0	22.09
Band7	5MHz	QPSK	21100	1RB#0	21.98
Band7	5MHz	QPSK	21100	1RB#12	22.02
Band7	5MHz	QPSK	21100	1RB#24	22.04
Band7	5MHz	QPSK	21100	12RB#0	21.42
Band7	5MHz	QPSK	21100	12RB#6	21.44
Band7	5MHz	QPSK	21100	12RB#13	21.52
Band7	5MHz	QPSK	21100	25RB#0	21.43
Band7	5MHz	QPSK	21425	1RB#0	21.66
Band7	5MHz	QPSK	21425	1RB#12	22.07
Band7	5MHz	QPSK	21425	1RB#24	22.12
Band7	5MHz	QPSK	21425	12RB#0	21.11
Band7	5MHz	QPSK	21425	12RB#6	21.10
Band7	5MHz	QPSK	21425	12RB#13	21.13
Band7	5MHz	QPSK	21425	25RB#0	21.08
Band7	5MHz	16QAM	20775	1RB#0	22.20
Band7	5MHz	16QAM	20775	1RB#12	22.18
Band7	5MHz	16QAM	20775	1RB#24	22.26
Band7	5MHz	16QAM	20775	12RB#0	21.33
Band7	5MHz	16QAM	20775	12RB#6	21.32
Band7	5MHz	16QAM	20775	12RB#13	21.30
Band7	5MHz	16QAM	20775	25RB#0	21.31
Band7	5MHz	16QAM	21100	1RB#0	21.49
Band7	5MHz	16QAM	21100	1RB#12	21.52
Band7	5MHz	16QAM	21100	1RB#24	21.56

Band7	5MHz	16QAM	21100	12RB#0	20.65
Band7	5MHz	16QAM	21100	12RB#6	20.64
Band7	5MHz	16QAM	21100	12RB#13	20.64
Band7	5MHz	16QAM	21100	25RB#0	20.63
Band7	5MHz	16QAM	21425	1RB#0	21.15
Band7	5MHz	16QAM	21425	1RB#12	20.88
Band7	5MHz	16QAM	21425	1RB#24	20.88
Band7	5MHz	16QAM	21425	12RB#0	20.25
Band7	5MHz	16QAM	21425	12RB#6	20.31
Band7	5MHz	16QAM	21425	12RB#13	20.54
Band7	5MHz	16QAM	21425	25RB#0	20.11
Band7	10MHz	QPSK	20800	1RB#0	22.38
Band7	10MHz	QPSK	20800	1RB#24	22.40
Band7	10MHz	QPSK	20800	1RB#49	22.24
Band7	10MHz	QPSK	20800	25RB#0	21.95
Band7	10MHz	QPSK	20800	25RB#12	21.96
Band7	10MHz	QPSK	20800	25RB#25	22.00
Band7	10MHz	QPSK	20800	50RB#0	21.98
Band7	10MHz	QPSK	21100	1RB#0	21.52
Band7	10MHz	QPSK	21100	1RB#24	21.71
Band7	10MHz	QPSK	21100	1RB#49	21.74
Band7	10MHz	QPSK	21100	25RB#0	21.32
Band7	10MHz	QPSK	21100	25RB#12	21.29
Band7	10MHz	QPSK	21100	25RB#25	21.23
Band7	10MHz	QPSK	21100	50RB#0	21.20
Band7	10MHz	QPSK	21400	1RB#0	21.45
Band7	10MHz	QPSK	21400	1RB#24	21.23
Band7	10MHz	QPSK	21400	1RB#49	21.05
Band7	10MHz	QPSK	21400	25RB#0	21.02
Band7	10MHz	QPSK	21400	25RB#12	21.02
Band7	10MHz	QPSK	21400	25RB#25	20.99
Band7	10MHz	QPSK	21400	50RB#0	20.99
Band7	10MHz	16QAM	20800	1RB#0	22.15
Band7	10MHz	16QAM	20800	1RB#24	22.05
Band7	10MHz	16QAM	20800	1RB#49	22.21
Band7	10MHz	16QAM	20800	25RB#0	21.27
Band7	10MHz	16QAM	20800	25RB#12	21.27
Band7	10MHz	16QAM	20800	25RB#25	21.21

Band7	10MHz	16QAM	20800	50RB#0	21.27
Band7	10MHz	16QAM	21100	1RB#0	21.38
Band7	10MHz	16QAM	21100	1RB#24	21.59
Band7	10MHz	16QAM	21100	1RB#49	21.46
Band7	10MHz	16QAM	21100	25RB#0	20.57
Band7	10MHz	16QAM	21100	25RB#12	20.56
Band7	10MHz	16QAM	21100	25RB#25	20.60
Band7	10MHz	16QAM	21100	50RB#0	20.58
Band7	10MHz	16QAM	21400	1RB#0	21.43
Band7	10MHz	16QAM	21400	1RB#24	21.17
Band7	10MHz	16QAM	21400	1RB#49	21.13
Band7	10MHz	16QAM	21400	25RB#0	20.31
Band7	10MHz	16QAM	21400	25RB#12	20.31
Band7	10MHz	16QAM	21400	25RB#25	20.27
Band7	10MHz	16QAM	21400	50RB#0	20.28
Band7	15MHz	QPSK	20825	1RB#0	22.39
Band7	15MHz	QPSK	20825	1RB#38	22.36
Band7	15MHz	QPSK	20825	1RB#74	22.24
Band7	15MHz	QPSK	20825	38RB#0	22.21
Band7	15MHz	QPSK	20825	38RB#18	22.19
Band7	15MHz	QPSK	20825	38RB#37	22.20
Band7	15MHz	QPSK	20825	75RB#0	21.93
Band7	15MHz	QPSK	21100	1RB#0	21.50
Band7	15MHz	QPSK	21100	1RB#38	21.68
Band7	15MHz	QPSK	21100	1RB#74	21.78
Band7	15MHz	QPSK	21100	38RB#0	21.53
Band7	15MHz	QPSK	21100	38RB#18	21.48
Band7	15MHz	QPSK	21100	38RB#37	21.52
Band7	15MHz	QPSK	21100	75RB#0	21.25
Band7	15MHz	QPSK	21375	1RB#0	21.45
Band7	15MHz	QPSK	21375	1RB#38	21.23
Band7	15MHz	QPSK	21375	1RB#74	21.12
Band7	15MHz	QPSK	21375	38RB#0	21.33
Band7	15MHz	QPSK	21375	38RB#18	21.22
Band7	15MHz	QPSK	21375	38RB#37	21.14
Band7	15MHz	QPSK	21375	75RB#0	21.00
Band7	15MHz	16QAM	20825	1RB#0	22.24
Band7	15MHz	16QAM	20825	1RB#38	22.26

Band7	15MHz	16QAM	20825	1RB#74	22.20
Band7	15MHz	16QAM	20825	38RB#0	22.20
Band7	15MHz	16QAM	20825	38RB#18	22.19
Band7	15MHz	16QAM	20825	38RB#37	22.20
Band7	15MHz	16QAM	20825	75RB#0	21.23
Band7	15MHz	16QAM	21100	1RB#0	21.35
Band7	15MHz	16QAM	21100	1RB#38	21.48
Band7	15MHz	16QAM	21100	1RB#74	21.47
Band7	15MHz	16QAM	21100	38RB#0	21.56
Band7	15MHz	16QAM	21100	38RB#18	21.47
Band7	15MHz	16QAM	21100	38RB#37	21.52
Band7	15MHz	16QAM	21100	75RB#0	20.54
Band7	15MHz	16QAM	21375	1RB#0	21.37
Band7	15MHz	16QAM	21375	1RB#38	21.23
Band7	15MHz	16QAM	21375	1RB#74	21.14
Band7	15MHz	16QAM	21375	38RB#0	21.35
Band7	15MHz	16QAM	21375	38RB#18	21.22
Band7	15MHz	16QAM	21375	38RB#37	21.14
Band7	15MHz	16QAM	21375	75RB#0	20.29
Band7	20MHz	QPSK	20850	1RB#0	22.67
Band7	20MHz	QPSK	20850	1RB#49	22.88
Band7	20MHz	QPSK	20850	1RB#99	22.92
Band7	20MHz	QPSK	20850	50RB#0	21.99
Band7	20MHz	QPSK	20850	50RB#25	21.92
Band7	20MHz	QPSK	20850	50RB#50	22.00
Band7	20MHz	QPSK	20850	100RB#0	21.98
Band7	20MHz	QPSK	21100	1RB#0	22.08
Band7	20MHz	QPSK	21100	1RB#49	21.94
Band7	20MHz	QPSK	21100	1RB#99	22.18
Band7	20MHz	QPSK	21100	50RB#0	21.28
Band7	20MHz	QPSK	21100	50RB#25	21.24
Band7	20MHz	QPSK	21100	50RB#50	21.26
Band7	20MHz	QPSK	21100	100RB#0	21.36
Band7	20MHz	QPSK	21350	1RB#0	22.36
Band7	20MHz	QPSK	21350	1RB#49	21.96
Band7	20MHz	QPSK	21350	1RB#99	21.95
Band7	20MHz	QPSK	21350	50RB#0	21.63
Band7	20MHz	QPSK	21350	50RB#25	21.64

Band7	20MHz	QPSK	21350	50RB#50	21.49
Band7	20MHz	QPSK	21350	100RB#0	21.46
Band7	20MHz	16QAM	20850	1RB#0	22.15
Band7	20MHz	16QAM	20850	1RB#49	21.94
Band7	20MHz	16QAM	20850	1RB#99	22.00
Band7	20MHz	16QAM	20850	50RB#0	21.14
Band7	20MHz	16QAM	20850	50RB#25	21.19
Band7	20MHz	16QAM	20850	50RB#50	21.21
Band7	20MHz	16QAM	20850	100RB#0	21.24
Band7	20MHz	16QAM	21100	1RB#0	21.43
Band7	20MHz	16QAM	21100	1RB#49	21.37
Band7	20MHz	16QAM	21100	1RB#99	21.59
Band7	20MHz	16QAM	21100	50RB#0	20.48
Band7	20MHz	16QAM	21100	50RB#25	20.48
Band7	20MHz	16QAM	21100	50RB#50	20.55
Band7	20MHz	16QAM	21100	100RB#0	20.55
Band7	20MHz	16QAM	21350	1RB#0	21.75
Band7	20MHz	16QAM	21350	1RB#49	21.23
Band7	20MHz	16QAM	21350	1RB#99	21.19
Band7	20MHz	16QAM	21350	50RB#0	20.79
Band7	20MHz	16QAM	21350	50RB#25	20.74
Band7	20MHz	16QAM	21350	50RB#50	20.70
Band7	20MHz	16QAM	21350	100RB#0	20.80
Band12	1.4MHz	QPSK	23017	1RB#0	23.05
Band12	1.4MHz	QPSK	23017	1RB#2	23.08
Band12	1.4MHz	QPSK	23017	1RB#5	23.05
Band12	1.4MHz	QPSK	23017	3RB#0	23.55
Band12	1.4MHz	QPSK	23017	3RB#1	23.54
Band12	1.4MHz	QPSK	23017	3RB#3	23.57
Band12	1.4MHz	QPSK	23017	6RB#0	22.44
Band12	1.4MHz	QPSK	23095	1RB#0	22.66
Band12	1.4MHz	QPSK	23095	1RB#2	22.55
Band12	1.4MHz	QPSK	23095	1RB#5	22.53
Band12	1.4MHz	QPSK	23095	3RB#0	23.08
Band12	1.4MHz	QPSK	23095	3RB#1	23.06
Band12	1.4MHz	QPSK	23095	3RB#3	23.06
Band12	1.4MHz	QPSK	23095	6RB#0	21.90
Band12	1.4MHz	QPSK	23173	1RB#0	22.61

Band12	1.4MHz	QPSK	23173	1RB#2	22.67
Band12	1.4MHz	QPSK	23173	1RB#5	22.63
Band12	1.4MHz	QPSK	23173	3RB#0	23.14
Band12	1.4MHz	QPSK	23173	3RB#1	23.13
Band12	1.4MHz	QPSK	23173	3RB#3	23.11
Band12	1.4MHz	QPSK	23173	6RB#0	21.99
Band12	1.4MHz	16QAM	23017	1RB#0	23.39
Band12	1.4MHz	16QAM	23017	1RB#2	23.43
Band12	1.4MHz	16QAM	23017	1RB#5	23.46
Band12	1.4MHz	16QAM	23017	3RB#0	22.47
Band12	1.4MHz	16QAM	23017	3RB#1	22.45
Band12	1.4MHz	16QAM	23017	3RB#3	22.43
Band12	1.4MHz	16QAM	23017	6RB#0	21.96
Band12	1.4MHz	16QAM	23095	1RB#0	23.01
Band12	1.4MHz	16QAM	23095	1RB#2	23.00
Band12	1.4MHz	16QAM	23095	1RB#5	22.98
Band12	1.4MHz	16QAM	23095	3RB#0	21.98
Band12	1.4MHz	16QAM	23095	3RB#1	21.96
Band12	1.4MHz	16QAM	23095	3RB#3	21.92
Band12	1.4MHz	16QAM	23095	6RB#0	21.37
Band12	1.4MHz	16QAM	23173	1RB#0	23.12
Band12	1.4MHz	16QAM	23173	1RB#2	23.03
Band12	1.4MHz	16QAM	23173	1RB#5	23.06
Band12	1.4MHz	16QAM	23173	3RB#0	22.05
Band12	1.4MHz	16QAM	23173	3RB#1	22.04
Band12	1.4MHz	16QAM	23173	3RB#3	22.04
Band12	1.4MHz	16QAM	23173	6RB#0	21.44
Band12	3MHz	QPSK	23025	1RB#0	22.30
Band12	3MHz	QPSK	23025	1RB#8	22.36
Band12	3MHz	QPSK	23025	1RB#14	22.38
Band12	3MHz	QPSK	23025	8RB#0	21.77
Band12	3MHz	QPSK	23025	8RB#4	21.77
Band12	3MHz	QPSK	23025	8RB#7	21.79
Band12	3MHz	QPSK	23025	15RB#0	21.80
Band12	3MHz	QPSK	23095	1RB#0	22.77
Band12	3MHz	QPSK	23095	1RB#8	22.80
Band12	3MHz	QPSK	23095	1RB#14	22.86
Band12	3MHz	QPSK	23095	8RB#0	21.89

Band12	3MHz	QPSK	23095	8RB#4	21.88
Band12	3MHz	QPSK	23095	8RB#7	21.88
Band12	3MHz	QPSK	23095	15RB#0	21.82
Band12	3MHz	QPSK	23165	1RB#0	22.57
Band12	3MHz	QPSK	23165	1RB#8	22.50
Band12	3MHz	QPSK	23165	1RB#14	22.49
Band12	3MHz	QPSK	23165	8RB#0	21.98
Band12	3MHz	QPSK	23165	8RB#4	21.97
Band12	3MHz	QPSK	23165	8RB#7	21.96
Band12	3MHz	QPSK	23165	15RB#0	21.96
Band12	3MHz	16QAM	23025	1RB#0	21.97
Band12	3MHz	16QAM	23025	1RB#8	22.05
Band12	3MHz	16QAM	23025	1RB#14	22.03
Band12	3MHz	16QAM	23025	8RB#0	21.26
Band12	3MHz	16QAM	23025	8RB#4	21.26
Band12	3MHz	16QAM	23025	8RB#7	21.27
Band12	3MHz	16QAM	23025	15RB#0	21.09
Band12	3MHz	16QAM	23095	1RB#0	22.56
Band12	3MHz	16QAM	23095	1RB#8	22.58
Band12	3MHz	16QAM	23095	1RB#14	22.49
Band12	3MHz	16QAM	23095	8RB#0	21.38
Band12	3MHz	16QAM	23095	8RB#4	21.38
Band12	3MHz	16QAM	23095	8RB#7	21.38
Band12	3MHz	16QAM	23095	15RB#0	20.96
Band12	3MHz	16QAM	23165	1RB#0	22.21
Band12	3MHz	16QAM	23165	1RB#8	22.26
Band12	3MHz	16QAM	23165	1RB#14	22.23
Band12	3MHz	16QAM	23165	8RB#0	21.43
Band12	3MHz	16QAM	23165	8RB#4	21.42
Band12	3MHz	16QAM	23165	8RB#7	21.45
Band12	3MHz	16QAM	23165	15RB#0	21.23
Band12	5MHz	QPSK	23035	1RB#0	22.61
Band12	5MHz	QPSK	23035	1RB#12	22.64
Band12	5MHz	QPSK	23035	1RB#24	22.68
Band12	5MHz	QPSK	23035	12RB#0	21.73
Band12	5MHz	QPSK	23035	12RB#6	21.74
Band12	5MHz	QPSK	23035	12RB#13	21.82
Band12	5MHz	QPSK	23035	25RB#0	21.74

Band12	5MHz	QPSK	23095	1RB#0	22.66
Band12	5MHz	QPSK	23095	1RB#12	22.65
Band12	5MHz	QPSK	23095	1RB#24	22.64
Band12	5MHz	QPSK	23095	12RB#0	21.90
Band12	5MHz	QPSK	23095	12RB#6	21.92
Band12	5MHz	QPSK	23095	12RB#13	21.94
Band12	5MHz	QPSK	23095	25RB#0	21.85
Band12	5MHz	QPSK	23155	1RB#0	22.86
Band12	5MHz	QPSK	23155	1RB#12	22.87
Band12	5MHz	QPSK	23155	1RB#24	22.84
Band12	5MHz	QPSK	23155	12RB#0	21.99
Band12	5MHz	QPSK	23155	12RB#6	21.99
Band12	5MHz	QPSK	23155	12RB#13	21.96
Band12	5MHz	QPSK	23155	25RB#0	21.98
Band12	5MHz	16QAM	23035	1RB#0	21.98
Band12	5MHz	16QAM	23035	1RB#12	22.03
Band12	5MHz	16QAM	23035	1RB#24	22.07
Band12	5MHz	16QAM	23035	12RB#0	21.03
Band12	5MHz	16QAM	23035	12RB#6	21.02
Band12	5MHz	16QAM	23035	12RB#13	21.06
Band12	5MHz	16QAM	23035	25RB#0	20.96
Band12	5MHz	16QAM	23095	1RB#0	22.44
Band12	5MHz	16QAM	23095	1RB#12	22.40
Band12	5MHz	16QAM	23095	1RB#24	22.37
Band12	5MHz	16QAM	23095	12RB#0	21.28
Band12	5MHz	16QAM	23095	12RB#6	21.29
Band12	5MHz	16QAM	23095	12RB#13	21.24
Band12	5MHz	16QAM	23095	25RB#0	21.08
Band12	5MHz	16QAM	23155	1RB#0	22.20
Band12	5MHz	16QAM	23155	1RB#12	22.20
Band12	5MHz	16QAM	23155	1RB#24	22.17
Band12	5MHz	16QAM	23155	12RB#0	21.24
Band12	5MHz	16QAM	23155	12RB#6	21.25
Band12	5MHz	16QAM	23155	12RB#13	21.19
Band12	5MHz	16QAM	23155	25RB#0	21.21
Band12	10MHz	QPSK	23060	1RB#0	22.29
Band12	10MHz	QPSK	23060	1RB#24	22.42
Band12	10MHz	QPSK	23060	1RB#49	22.38

Band12	10MHz	QPSK	23060	25RB#0	21.72
Band12	10MHz	QPSK	23060	25RB#12	21.71
Band12	10MHz	QPSK	23060	25RB#25	21.80
Band12	10MHz	QPSK	23060	50RB#0	21.73
Band12	10MHz	QPSK	23095	1RB#0	22.80
Band12	10MHz	QPSK	23095	1RB#24	22.78
Band12	10MHz	QPSK	23095	1RB#49	22.74
Band12	10MHz	QPSK	23095	25RB#0	21.87
Band12	10MHz	QPSK	23095	25RB#12	21.84
Band12	10MHz	QPSK	23095	25RB#25	21.83
Band12	10MHz	QPSK	23095	50RB#0	21.81
Band12	10MHz	QPSK	23130	1RB#0	22.66
Band12	10MHz	QPSK	23130	1RB#24	22.62
Band12	10MHz	QPSK	23130	1RB#49	22.57
Band12	10MHz	QPSK	23130	25RB#0	22.02
Band12	10MHz	QPSK	23130	25RB#12	21.97
Band12	10MHz	QPSK	23130	25RB#25	21.94
Band12	10MHz	QPSK	23130	50RB#0	21.99
Band12	10MHz	16QAM	23060	1RB#0	22.00
Band12	10MHz	16QAM	23060	1RB#24	22.16
Band12	10MHz	16QAM	23060	1RB#49	22.10
Band12	10MHz	16QAM	23060	25RB#0	21.01
Band12	10MHz	16QAM	23060	25RB#12	21.04
Band12	10MHz	16QAM	23060	25RB#25	21.11
Band12	10MHz	16QAM	23060	50RB#0	21.09
Band12	10MHz	16QAM	23095	1RB#0	22.51
Band12	10MHz	16QAM	23095	1RB#24	22.53
Band12	10MHz	16QAM	23095	1RB#49	22.44
Band12	10MHz	16QAM	23095	25RB#0	21.20
Band12	10MHz	16QAM	23095	25RB#12	21.19
Band12	10MHz	16QAM	23095	25RB#25	21.17
Band12	10MHz	16QAM	23095	50RB#0	21.20
Band12	10MHz	16QAM	23130	1RB#0	22.31
Band12	10MHz	16QAM	23130	1RB#24	22.25
Band12	10MHz	16QAM	23130	1RB#49	22.23
Band12	10MHz	16QAM	23130	25RB#0	21.29
Band12	10MHz	16QAM	23130	25RB#12	21.28
Band12	10MHz	16QAM	23130	25RB#25	21.20

Band12	10MHz	16QAM	23130	50RB#0	21.27
Band17	5MHz	QPSK	23755	1RB#0	22.69
Band17	5MHz	QPSK	23755	1RB#12	22.73
Band17	5MHz	QPSK	23755	1RB#24	22.74
Band17	5MHz	QPSK	23755	12RB#0	21.81
Band17	5MHz	QPSK	23755	12RB#6	21.83
Band17	5MHz	QPSK	23755	12RB#13	21.86
Band17	5MHz	QPSK	23755	25RB#0	21.77
Band17	5MHz	QPSK	23790	1RB#0	22.67
Band17	5MHz	QPSK	23790	1RB#12	22.64
Band17	5MHz	QPSK	23790	1RB#24	22.62
Band17	5MHz	QPSK	23790	12RB#0	21.86
Band17	5MHz	QPSK	23790	12RB#6	21.86
Band17	5MHz	QPSK	23790	12RB#13	21.84
Band17	5MHz	QPSK	23790	25RB#0	21.79
Band17	5MHz	QPSK	23825	1RB#0	22.90
Band17	5MHz	QPSK	23825	1RB#12	22.85
Band17	5MHz	QPSK	23825	1RB#24	22.86
Band17	5MHz	QPSK	23825	12RB#0	21.97
Band17	5MHz	QPSK	23825	12RB#6	21.98
Band17	5MHz	QPSK	23825	12RB#13	22.00
Band17	5MHz	QPSK	23825	25RB#0	21.99
Band17	5MHz	16QAM	23755	1RB#0	22.06
Band17	5MHz	16QAM	23755	1RB#12	21.99
Band17	5MHz	16QAM	23755	1RB#24	22.07
Band17	5MHz	16QAM	23755	12RB#0	21.07
Band17	5MHz	16QAM	23755	12RB#6	21.10
Band17	5MHz	16QAM	23755	12RB#13	21.10
Band17	5MHz	16QAM	23755	25RB#0	21.09
Band17	5MHz	16QAM	23790	1RB#0	22.38
Band17	5MHz	16QAM	23790	1RB#12	22.44
Band17	5MHz	16QAM	23790	1RB#24	22.31
Band17	5MHz	16QAM	23790	12RB#0	21.25
Band17	5MHz	16QAM	23790	12RB#6	21.25
Band17	5MHz	16QAM	23790	12RB#13	21.21
Band17	5MHz	16QAM	23790	25RB#0	21.10
Band17	5MHz	16QAM	23825	1RB#0	22.18
Band17	5MHz	16QAM	23825	1RB#12	22.19

Band17	5MHz	16QAM	23825	1RB#24	22.21
Band17	5MHz	16QAM	23825	12RB#0	21.22
Band17	5MHz	16QAM	23825	12RB#6	21.18
Band17	5MHz	16QAM	23825	12RB#13	21.24
Band17	5MHz	16QAM	23825	25RB#0	21.27
Band17	10MHz	QPSK	23780	1RB#0	22.42
Band17	10MHz	QPSK	23780	1RB#24	22.47
Band17	10MHz	QPSK	23780	1RB#49	22.46
Band17	10MHz	QPSK	23780	25RB#0	21.77
Band17	10MHz	QPSK	23780	25RB#12	21.80
Band17	10MHz	QPSK	23780	25RB#25	21.74
Band17	10MHz	QPSK	23780	50RB#0	21.79
Band17	10MHz	QPSK	23790	1RB#0	22.88
Band17	10MHz	QPSK	23790	1RB#24	22.78
Band17	10MHz	QPSK	23790	1RB#49	22.87
Band17	10MHz	QPSK	23790	25RB#0	21.80
Band17	10MHz	QPSK	23790	25RB#12	21.80
Band17	10MHz	QPSK	23790	25RB#25	21.76
Band17	10MHz	QPSK	23790	50RB#0	21.80
Band17	10MHz	QPSK	23800	1RB#0	22.70
Band17	10MHz	QPSK	23800	1RB#24	22.55
Band17	10MHz	QPSK	23800	1RB#49	22.56
Band17	10MHz	QPSK	23800	25RB#0	22.01
Band17	10MHz	QPSK	23800	25RB#12	21.99
Band17	10MHz	QPSK	23800	25RB#25	21.99
Band17	10MHz	QPSK	23800	50RB#0	21.98
Band17	10MHz	16QAM	23780	1RB#0	22.12
Band17	10MHz	16QAM	23780	1RB#24	22.17
Band17	10MHz	16QAM	23780	1RB#49	22.03
Band17	10MHz	16QAM	23780	25RB#0	21.12
Band17	10MHz	16QAM	23780	25RB#12	21.10
Band17	10MHz	16QAM	23780	25RB#25	21.08
Band17	10MHz	16QAM	23780	50RB#0	21.13
Band17	10MHz	16QAM	23790	1RB#0	22.51
Band17	10MHz	16QAM	23790	1RB#24	22.53
Band17	10MHz	16QAM	23790	1RB#49	22.54
Band17	10MHz	16QAM	23790	25RB#0	21.19
Band17	10MHz	16QAM	23790	25RB#12	21.20

Band17	10MHz	16QAM	23790	25RB#25	21.15
Band17	10MHz	16QAM	23790	50RB#0	21.18
Band17	10MHz	16QAM	23800	1RB#0	22.26
Band17	10MHz	16QAM	23800	1RB#24	22.23
Band17	10MHz	16QAM	23800	1RB#49	22.27
Band17	10MHz	16QAM	23800	25RB#0	21.28
Band17	10MHz	16QAM	23800	25RB#12	21.30
Band17	10MHz	16QAM	23800	25RB#25	21.24
Band17	10MHz	16QAM	23800	50RB#0	21.28
Band25	1.4MHz	QPSK	26047	1RB#0	22.98
Band25	1.4MHz	QPSK	26047	1RB#2	22.99
Band25	1.4MHz	QPSK	26047	1RB#5	23.04
Band25	1.4MHz	QPSK	26047	3RB#0	23.58
Band25	1.4MHz	QPSK	26047	3RB#1	23.54
Band25	1.4MHz	QPSK	26047	3RB#3	23.57
Band25	1.4MHz	QPSK	26047	6RB#0	22.29
Band25	1.4MHz	QPSK	26365	1RB#0	23.62
Band25	1.4MHz	QPSK	26365	1RB#2	23.60
Band25	1.4MHz	QPSK	26365	1RB#5	23.61
Band25	1.4MHz	QPSK	26365	3RB#0	24.09
Band25	1.4MHz	QPSK	26365	3RB#1	24.27
Band25	1.4MHz	QPSK	26365	3RB#3	24.27
Band25	1.4MHz	QPSK	26365	6RB#0	22.92
Band25	1.4MHz	QPSK	26683	1RB#0	23.76
Band25	1.4MHz	QPSK	26683	1RB#2	23.56
Band25	1.4MHz	QPSK	26683	1RB#5	23.55
Band25	1.4MHz	QPSK	26683	3RB#0	24.11
Band25	1.4MHz	QPSK	26683	3RB#1	24.05
Band25	1.4MHz	QPSK	26683	3RB#3	24.30
Band25	1.4MHz	QPSK	26683	6RB#0	22.88
Band25	1.4MHz	16QAM	26047	1RB#0	23.26
Band25	1.4MHz	16QAM	26047	1RB#2	23.30
Band25	1.4MHz	16QAM	26047	1RB#5	23.30
Band25	1.4MHz	16QAM	26047	3RB#0	22.33
Band25	1.4MHz	16QAM	26047	3RB#1	22.34
Band25	1.4MHz	16QAM	26047	3RB#3	22.31
Band25	1.4MHz	16QAM	26047	6RB#0	21.94
Band25	1.4MHz	16QAM	26365	1RB#0	23.89

Band25	1.4MHz	16QAM	26365	1RB#2	23.87
Band25	1.4MHz	16QAM	26365	1RB#5	23.89
Band25	1.4MHz	16QAM	26365	3RB#0	22.93
Band25	1.4MHz	16QAM	26365	3RB#1	22.92
Band25	1.4MHz	16QAM	26365	3RB#3	22.91
Band25	1.4MHz	16QAM	26365	6RB#0	22.48
Band25	1.4MHz	16QAM	26683	1RB#0	23.74
Band25	1.4MHz	16QAM	26683	1RB#2	23.62
Band25	1.4MHz	16QAM	26683	1RB#5	23.57
Band25	1.4MHz	16QAM	26683	3RB#0	22.91
Band25	1.4MHz	16QAM	26683	3RB#1	22.93
Band25	1.4MHz	16QAM	26683	3RB#3	22.80
Band25	1.4MHz	16QAM	26683	6RB#0	22.47
Band25	3MHz	QPSK	26055	1RB#0	22.85
Band25	3MHz	QPSK	26055	1RB#8	22.86
Band25	3MHz	QPSK	26055	1RB#14	22.91
Band25	3MHz	QPSK	26055	8RB#0	22.28
Band25	3MHz	QPSK	26055	8RB#4	22.25
Band25	3MHz	QPSK	26055	8RB#7	22.28
Band25	3MHz	QPSK	26055	15RB#0	22.31
Band25	3MHz	QPSK	26365	1RB#0	23.49
Band25	3MHz	QPSK	26365	1RB#8	23.51
Band25	3MHz	QPSK	26365	1RB#14	23.49
Band25	3MHz	QPSK	26365	8RB#0	22.86
Band25	3MHz	QPSK	26365	8RB#4	22.86
Band25	3MHz	QPSK	26365	8RB#7	22.86
Band25	3MHz	QPSK	26365	15RB#0	22.86
Band25	3MHz	QPSK	26675	1RB#0	23.51
Band25	3MHz	QPSK	26675	1RB#8	23.33
Band25	3MHz	QPSK	26675	1RB#14	23.38
Band25	3MHz	QPSK	26675	8RB#0	22.86
Band25	3MHz	QPSK	26675	8RB#4	22.87
Band25	3MHz	QPSK	26675	8RB#7	22.89
Band25	3MHz	QPSK	26675	15RB#0	22.93
Band25	3MHz	16QAM	26055	1RB#0	22.50
Band25	3MHz	16QAM	26055	1RB#8	22.51
Band25	3MHz	16QAM	26055	1RB#14	22.56
Band25	3MHz	16QAM	26055	8RB#0	21.81

Band25	3MHz	16QAM	26055	8RB#4	21.84
Band25	3MHz	16QAM	26055	8RB#7	21.89
Band25	3MHz	16QAM	26055	15RB#0	21.75
Band25	3MHz	16QAM	26365	1RB#0	23.13
Band25	3MHz	16QAM	26365	1RB#8	23.09
Band25	3MHz	16QAM	26365	1RB#14	23.07
Band25	3MHz	16QAM	26365	8RB#0	22.46
Band25	3MHz	16QAM	26365	8RB#4	22.49
Band25	3MHz	16QAM	26365	8RB#7	22.41
Band25	3MHz	16QAM	26365	15RB#0	22.27
Band25	3MHz	16QAM	26675	1RB#0	23.19
Band25	3MHz	16QAM	26675	1RB#8	23.16
Band25	3MHz	16QAM	26675	1RB#14	23.00
Band25	3MHz	16QAM	26675	8RB#0	22.48
Band25	3MHz	16QAM	26675	8RB#4	22.47
Band25	3MHz	16QAM	26675	8RB#7	22.35
Band25	3MHz	16QAM	26675	15RB#0	22.29
Band25	5MHz	QPSK	26065	1RB#0	23.15
Band25	5MHz	QPSK	26065	1RB#12	23.24
Band25	5MHz	QPSK	26065	1RB#24	23.27
Band25	5MHz	QPSK	26065	12RB#0	22.30
Band25	5MHz	QPSK	26065	12RB#6	22.25
Band25	5MHz	QPSK	26065	12RB#13	22.33
Band25	5MHz	QPSK	26065	25RB#0	22.27
Band25	5MHz	QPSK	26365	1RB#0	23.82
Band25	5MHz	QPSK	26365	1RB#12	23.75
Band25	5MHz	QPSK	26365	1RB#24	23.75
Band25	5MHz	QPSK	26365	12RB#0	22.87
Band25	5MHz	QPSK	26365	12RB#6	22.86
Band25	5MHz	QPSK	26365	12RB#13	22.87
Band25	5MHz	QPSK	26365	25RB#0	22.86
Band25	5MHz	QPSK	26665	1RB#0	23.82
Band25	5MHz	QPSK	26665	1RB#12	23.70
Band25	5MHz	QPSK	26665	1RB#24	23.62
Band25	5MHz	QPSK	26665	12RB#0	22.97
Band25	5MHz	QPSK	26665	12RB#6	22.99
Band25	5MHz	QPSK	26665	12RB#13	22.95
Band25	5MHz	QPSK	26665	25RB#0	23.06

Band25	5MHz	16QAM	26065	1RB#0	22.47
Band25	5MHz	16QAM	26065	1RB#12	22.54
Band25	5MHz	16QAM	26065	1RB#24	22.63
Band25	5MHz	16QAM	26065	12RB#0	21.63
Band25	5MHz	16QAM	26065	12RB#6	21.64
Band25	5MHz	16QAM	26065	12RB#13	21.64
Band25	5MHz	16QAM	26065	25RB#0	21.64
Band25	5MHz	16QAM	26365	1RB#0	23.07
Band25	5MHz	16QAM	26365	1RB#12	23.07
Band25	5MHz	16QAM	26365	1RB#24	23.08
Band25	5MHz	16QAM	26365	12RB#0	22.21
Band25	5MHz	16QAM	26365	12RB#6	22.19
Band25	5MHz	16QAM	26365	12RB#13	22.15
Band25	5MHz	16QAM	26365	25RB#0	22.16
Band25	5MHz	16QAM	26665	1RB#0	23.14
Band25	5MHz	16QAM	26665	1RB#12	23.25
Band25	5MHz	16QAM	26665	1RB#24	22.94
Band25	5MHz	16QAM	26665	12RB#0	22.40
Band25	5MHz	16QAM	26665	12RB#6	22.41
Band25	5MHz	16QAM	26665	12RB#13	22.29
Band25	5MHz	16QAM	26665	25RB#0	22.34
Band25	10MHz	QPSK	26090	1RB#0	22.83
Band25	10MHz	QPSK	26090	1RB#24	23.03
Band25	10MHz	QPSK	26090	1RB#49	23.00
Band25	10MHz	QPSK	26090	25RB#0	22.24
Band25	10MHz	QPSK	26090	25RB#12	22.25
Band25	10MHz	QPSK	26090	25RB#25	22.33
Band25	10MHz	QPSK	26090	50RB#0	22.29
Band25	10MHz	QPSK	26365	1RB#0	23.55
Band25	10MHz	QPSK	26365	1RB#24	23.50
Band25	10MHz	QPSK	26365	1RB#49	23.41
Band25	10MHz	QPSK	26365	25RB#0	22.84
Band25	10MHz	QPSK	26365	25RB#12	22.84
Band25	10MHz	QPSK	26365	25RB#25	22.78
Band25	10MHz	QPSK	26365	50RB#0	22.81
Band25	10MHz	QPSK	26640	1RB#0	23.32
Band25	10MHz	QPSK	26640	1RB#24	23.19
Band25	10MHz	QPSK	26640	1RB#49	23.08

Band25	10MHz	QPSK	26640	25RB#0	22.68
Band25	10MHz	QPSK	26640	25RB#12	22.70
Band25	10MHz	QPSK	26640	25RB#25	22.62
Band25	10MHz	QPSK	26640	50RB#0	22.64
Band25	10MHz	16QAM	26090	1RB#0	22.50
Band25	10MHz	16QAM	26090	1RB#24	22.67
Band25	10MHz	16QAM	26090	1RB#49	22.68
Band25	10MHz	16QAM	26090	25RB#0	21.65
Band25	10MHz	16QAM	26090	25RB#12	21.66
Band25	10MHz	16QAM	26090	25RB#25	21.71
Band25	10MHz	16QAM	26090	50RB#0	21.68
Band25	10MHz	16QAM	26365	1RB#0	23.18
Band25	10MHz	16QAM	26365	1RB#24	23.14
Band25	10MHz	16QAM	26365	1RB#49	23.06
Band25	10MHz	16QAM	26365	25RB#0	22.20
Band25	10MHz	16QAM	26365	25RB#12	22.20
Band25	10MHz	16QAM	26365	25RB#25	22.19
Band25	10MHz	16QAM	26365	50RB#0	22.21
Band25	10MHz	16QAM	26640	1RB#0	23.05
Band25	10MHz	16QAM	26640	1RB#24	22.93
Band25	10MHz	16QAM	26640	1RB#49	22.76
Band25	10MHz	16QAM	26640	25RB#0	22.02
Band25	10MHz	16QAM	26640	25RB#12	22.02
Band25	10MHz	16QAM	26640	25RB#25	21.97
Band25	10MHz	16QAM	26640	50RB#0	21.98
Band25	15MHz	QPSK	26115	1RB#0	22.86
Band25	15MHz	QPSK	26115	1RB#38	22.98
Band25	15MHz	QPSK	26115	1RB#74	23.04
Band25	15MHz	QPSK	26115	38RB#0	22.57
Band25	15MHz	QPSK	26115	38RB#18	22.65
Band25	15MHz	QPSK	26115	38RB#37	22.63
Band25	15MHz	QPSK	26115	75RB#0	22.34
Band25	15MHz	QPSK	26365	1RB#0	23.49
Band25	15MHz	QPSK	26365	1RB#38	23.46
Band25	15MHz	QPSK	26365	1RB#74	23.36
Band25	15MHz	QPSK	26365	38RB#0	23.12
Band25	15MHz	QPSK	26365	38RB#18	23.10
Band25	15MHz	QPSK	26365	38RB#37	23.02

Band25	15MHz	QPSK	26365	75RB#0	22.81
Band25	15MHz	QPSK	26615	1RB#0	23.40
Band25	15MHz	QPSK	26615	1RB#38	23.16
Band25	15MHz	QPSK	26615	1RB#74	22.91
Band25	15MHz	QPSK	26615	38RB#0	23.09
Band25	15MHz	QPSK	26615	38RB#18	22.98
Band25	15MHz	QPSK	26615	38RB#37	22.79
Band25	15MHz	QPSK	26615	75RB#0	22.68
Band25	15MHz	16QAM	26115	1RB#0	22.55
Band25	15MHz	16QAM	26115	1RB#38	22.69
Band25	15MHz	16QAM	26115	1RB#74	22.68
Band25	15MHz	16QAM	26115	38RB#0	22.54
Band25	15MHz	16QAM	26115	38RB#18	22.66
Band25	15MHz	16QAM	26115	38RB#37	22.63
Band25	15MHz	16QAM	26115	75RB#0	21.64
Band25	15MHz	16QAM	26365	1RB#0	23.15
Band25	15MHz	16QAM	26365	1RB#38	23.10
Band25	15MHz	16QAM	26365	1RB#74	23.03
Band25	15MHz	16QAM	26365	38RB#0	23.12
Band25	15MHz	16QAM	26365	38RB#18	23.12
Band25	15MHz	16QAM	26365	38RB#37	23.05
Band25	15MHz	16QAM	26365	75RB#0	22.18
Band25	15MHz	16QAM	26615	1RB#0	23.08
Band25	15MHz	16QAM	26615	1RB#38	22.96
Band25	15MHz	16QAM	26615	1RB#74	22.80
Band25	15MHz	16QAM	26615	38RB#0	23.10
Band25	15MHz	16QAM	26615	38RB#18	22.98
Band25	15MHz	16QAM	26615	38RB#37	22.78
Band25	15MHz	16QAM	26615	75RB#0	22.00
Band25	20MHz	QPSK	26140	1RB#0	23.35
Band25	20MHz	QPSK	26140	1RB#49	23.49
Band25	20MHz	QPSK	26140	1RB#99	23.49
Band25	20MHz	QPSK	26140	50RB#0	22.31
Band25	20MHz	QPSK	26140	50RB#25	22.28
Band25	20MHz	QPSK	26140	50RB#50	22.36
Band25	20MHz	QPSK	26140	100RB#0	22.42
Band25	20MHz	QPSK	26365	1RB#0	23.97
Band25	20MHz	QPSK	26365	1RB#49	23.88

Band25	20MHz	QPSK	26365	1RB#99	23.79
Band25	20MHz	QPSK	26365	50RB#0	22.86
Band25	20MHz	QPSK	26365	50RB#25	22.85
Band25	20MHz	QPSK	26365	50RB#50	22.77
Band25	20MHz	QPSK	26365	100RB#0	22.83
Band25	20MHz	QPSK	26590	1RB#0	23.91
Band25	20MHz	QPSK	26590	1RB#49	23.87
Band25	20MHz	QPSK	26590	1RB#99	23.62
Band25	20MHz	QPSK	26590	50RB#0	22.78
Band25	20MHz	QPSK	26590	50RB#25	22.77
Band25	20MHz	QPSK	26590	50RB#50	22.69
Band25	20MHz	QPSK	26590	100RB#0	22.77
Band25	20MHz	16QAM	26140	1RB#0	22.39
Band25	20MHz	16QAM	26140	1RB#49	22.44
Band25	20MHz	16QAM	26140	1RB#99	22.48
Band25	20MHz	16QAM	26140	50RB#0	21.62
Band25	20MHz	16QAM	26140	50RB#25	21.58
Band25	20MHz	16QAM	26140	50RB#50	21.64
Band25	20MHz	16QAM	26140	100RB#0	21.67
Band25	20MHz	16QAM	26365	1RB#0	23.03
Band25	20MHz	16QAM	26365	1RB#49	22.90
Band25	20MHz	16QAM	26365	1RB#99	22.82
Band25	20MHz	16QAM	26365	50RB#0	22.16
Band25	20MHz	16QAM	26365	50RB#25	22.15
Band25	20MHz	16QAM	26365	50RB#50	22.06
Band25	20MHz	16QAM	26365	100RB#0	22.15
Band25	20MHz	16QAM	26590	1RB#0	22.93
Band25	20MHz	16QAM	26590	1RB#49	22.89
Band25	20MHz	16QAM	26590	1RB#99	22.64
Band25	20MHz	16QAM	26590	50RB#0	22.06
Band25	20MHz	16QAM	26590	50RB#25	22.05
Band25	20MHz	16QAM	26590	50RB#50	21.96
Band25	20MHz	16QAM	26590	100RB#0	22.07
Band26	1.4MHz	QPSK	26797	1RB#0	22.16
Band26	1.4MHz	QPSK	26797	1RB#2	22.19
Band26	1.4MHz	QPSK	26797	1RB#5	22.17
Band26	1.4MHz	QPSK	26797	3RB#0	22.69
Band26	1.4MHz	QPSK	26797	3RB#1	22.68

Band26	1.4MHz	QPSK	26797	3RB#3	22.90
Band26	1.4MHz	QPSK	26797	6RB#0	21.42
Band26	1.4MHz	QPSK	26915	1RB#0	22.70
Band26	1.4MHz	QPSK	26915	1RB#2	22.71
Band26	1.4MHz	QPSK	26915	1RB#5	22.75
Band26	1.4MHz	QPSK	26915	3RB#0	23.17
Band26	1.4MHz	QPSK	26915	3RB#1	23.23
Band26	1.4MHz	QPSK	26915	3RB#3	23.21
Band26	1.4MHz	QPSK	26915	6RB#0	21.96
Band26	1.4MHz	QPSK	27033	1RB#0	23.43
Band26	1.4MHz	QPSK	27033	1RB#2	23.09
Band26	1.4MHz	QPSK	27033	1RB#5	23.06
Band26	1.4MHz	QPSK	27033	3RB#0	23.69
Band26	1.4MHz	QPSK	27033	3RB#1	23.69
Band26	1.4MHz	QPSK	27033	3RB#3	23.61
Band26	1.4MHz	QPSK	27033	6RB#0	22.40
Band26	1.4MHz	16QAM	26797	1RB#0	22.43
Band26	1.4MHz	16QAM	26797	1RB#2	22.42
Band26	1.4MHz	16QAM	26797	1RB#5	22.43
Band26	1.4MHz	16QAM	26797	3RB#0	21.43
Band26	1.4MHz	16QAM	26797	3RB#1	21.43
Band26	1.4MHz	16QAM	26797	3RB#3	21.44
Band26	1.4MHz	16QAM	26797	6RB#0	21.11
Band26	1.4MHz	16QAM	26915	1RB#0	23.04
Band26	1.4MHz	16QAM	26915	1RB#2	23.04
Band26	1.4MHz	16QAM	26915	1RB#5	22.97
Band26	1.4MHz	16QAM	26915	3RB#0	21.99
Band26	1.4MHz	16QAM	26915	3RB#1	22.03
Band26	1.4MHz	16QAM	26915	3RB#3	21.96
Band26	1.4MHz	16QAM	26915	6RB#0	21.62
Band26	1.4MHz	16QAM	27033	1RB#0	23.42
Band26	1.4MHz	16QAM	27033	1RB#2	23.24
Band26	1.4MHz	16QAM	27033	1RB#5	23.18
Band26	1.4MHz	16QAM	27033	3RB#0	22.45
Band26	1.4MHz	16QAM	27033	3RB#1	22.43
Band26	1.4MHz	16QAM	27033	3RB#3	22.24
Band26	1.4MHz	16QAM	27033	6RB#0	22.08
Band26	3MHz	QPSK	26805	1RB#0	22.04

Band26	3MHz	QPSK	26805	1RB#8	22.04
Band26	3MHz	QPSK	26805	1RB#14	22.10
Band26	3MHz	QPSK	26805	8RB#0	21.32
Band26	3MHz	QPSK	26805	8RB#4	21.42
Band26	3MHz	QPSK	26805	8RB#7	21.44
Band26	3MHz	QPSK	26805	15RB#0	21.41
Band26	3MHz	QPSK	26915	1RB#0	22.54
Band26	3MHz	QPSK	26915	1RB#8	22.50
Band26	3MHz	QPSK	26915	1RB#14	22.40
Band26	3MHz	QPSK	26915	8RB#0	21.89
Band26	3MHz	QPSK	26915	8RB#4	21.88
Band26	3MHz	QPSK	26915	8RB#7	21.94
Band26	3MHz	QPSK	26915	15RB#0	21.98
Band26	3MHz	QPSK	27025	1RB#0	23.03
Band26	3MHz	QPSK	27025	1RB#8	22.79
Band26	3MHz	QPSK	27025	1RB#14	22.88
Band26	3MHz	QPSK	27025	8RB#0	22.43
Band26	3MHz	QPSK	27025	8RB#4	22.41
Band26	3MHz	QPSK	27025	8RB#7	22.39
Band26	3MHz	QPSK	27025	15RB#0	22.38
Band26	3MHz	16QAM	26805	1RB#0	21.65
Band26	3MHz	16QAM	26805	1RB#8	21.63
Band26	3MHz	16QAM	26805	1RB#14	21.64
Band26	3MHz	16QAM	26805	8RB#0	21.00
Band26	3MHz	16QAM	26805	8RB#4	21.01
Band26	3MHz	16QAM	26805	8RB#7	21.10
Band26	3MHz	16QAM	26805	15RB#0	20.91
Band26	3MHz	16QAM	26915	1RB#0	22.27
Band26	3MHz	16QAM	26915	1RB#8	22.17
Band26	3MHz	16QAM	26915	1RB#14	22.10
Band26	3MHz	16QAM	26915	8RB#0	21.55
Band26	3MHz	16QAM	26915	8RB#4	21.55
Band26	3MHz	16QAM	26915	8RB#7	21.57
Band26	3MHz	16QAM	26915	15RB#0	21.41
Band26	3MHz	16QAM	27025	1RB#0	22.77
Band26	3MHz	16QAM	27025	1RB#8	22.67
Band26	3MHz	16QAM	27025	1RB#14	22.43
Band26	3MHz	16QAM	27025	8RB#0	21.94

Band26	3MHz	16QAM	27025	8RB#4	21.90
Band26	3MHz	16QAM	27025	8RB#7	22.03
Band26	3MHz	16QAM	27025	15RB#0	21.75
Band26	5MHz	QPSK	26815	1RB#0	22.35
Band26	5MHz	QPSK	26815	1RB#12	22.39
Band26	5MHz	QPSK	26815	1RB#24	22.40
Band26	5MHz	QPSK	26815	12RB#0	21.42
Band26	5MHz	QPSK	26815	12RB#6	21.43
Band26	5MHz	QPSK	26815	12RB#13	21.49
Band26	5MHz	QPSK	26815	25RB#0	21.41
Band26	5MHz	QPSK	26915	1RB#0	22.88
Band26	5MHz	QPSK	26915	1RB#12	22.96
Band26	5MHz	QPSK	26915	1RB#24	22.81
Band26	5MHz	QPSK	26915	12RB#0	22.05
Band26	5MHz	QPSK	26915	12RB#6	22.04
Band26	5MHz	QPSK	26915	12RB#13	21.93
Band26	5MHz	QPSK	26915	25RB#0	21.92
Band26	5MHz	QPSK	27015	1RB#0	23.36
Band26	5MHz	QPSK	27015	1RB#12	23.27
Band26	5MHz	QPSK	27015	1RB#24	23.07
Band26	5MHz	QPSK	27015	12RB#0	22.35
Band26	5MHz	QPSK	27015	12RB#6	22.34
Band26	5MHz	QPSK	27015	12RB#13	22.38
Band26	5MHz	QPSK	27015	25RB#0	22.30
Band26	5MHz	16QAM	26815	1RB#0	21.59
Band26	5MHz	16QAM	26815	1RB#12	21.60
Band26	5MHz	16QAM	26815	1RB#24	21.62
Band26	5MHz	16QAM	26815	12RB#0	20.91
Band26	5MHz	16QAM	26815	12RB#6	20.89
Band26	5MHz	16QAM	26815	12RB#13	20.92
Band26	5MHz	16QAM	26815	25RB#0	20.88
Band26	5MHz	16QAM	26915	1RB#0	22.22
Band26	5MHz	16QAM	26915	1RB#12	22.15
Band26	5MHz	16QAM	26915	1RB#24	22.09
Band26	5MHz	16QAM	26915	12RB#0	21.37
Band26	5MHz	16QAM	26915	12RB#6	21.37
Band26	5MHz	16QAM	26915	12RB#13	21.32
Band26	5MHz	16QAM	26915	25RB#0	21.39

Band26	5MHz	16QAM	27015	1RB#0	22.72
Band26	5MHz	16QAM	27015	1RB#12	22.70
Band26	5MHz	16QAM	27015	1RB#24	22.37
Band26	5MHz	16QAM	27015	12RB#0	21.80
Band26	5MHz	16QAM	27015	12RB#6	21.79
Band26	5MHz	16QAM	27015	12RB#13	21.78
Band26	5MHz	16QAM	27015	25RB#0	21.77
Band26	10MHz	QPSK	26840	1RB#0	22.06
Band26	10MHz	QPSK	26840	1RB#24	22.18
Band26	10MHz	QPSK	26840	1RB#49	22.15
Band26	10MHz	QPSK	26840	25RB#0	21.39
Band26	10MHz	QPSK	26840	25RB#12	21.42
Band26	10MHz	QPSK	26840	25RB#25	21.47
Band26	10MHz	QPSK	26840	50RB#0	21.49
Band26	10MHz	QPSK	26915	1RB#0	22.67
Band26	10MHz	QPSK	26915	1RB#24	22.49
Band26	10MHz	QPSK	26915	1RB#49	22.57
Band26	10MHz	QPSK	26915	25RB#0	21.94
Band26	10MHz	QPSK	26915	25RB#12	21.94
Band26	10MHz	QPSK	26915	25RB#25	21.89
Band26	10MHz	QPSK	26915	50RB#0	21.96
Band26	10MHz	QPSK	26990	1RB#0	22.60
Band26	10MHz	QPSK	26990	1RB#24	22.90
Band26	10MHz	QPSK	26990	1RB#49	22.62
Band26	10MHz	QPSK	26990	25RB#0	22.12
Band26	10MHz	QPSK	26990	25RB#12	22.13
Band26	10MHz	QPSK	26990	25RB#25	22.24
Band26	10MHz	QPSK	26990	50RB#0	22.13
Band26	10MHz	16QAM	26840	1RB#0	21.69
Band26	10MHz	16QAM	26840	1RB#24	21.76
Band26	10MHz	16QAM	26840	1RB#49	21.77
Band26	10MHz	16QAM	26840	25RB#0	20.95
Band26	10MHz	16QAM	26840	25RB#12	20.93
Band26	10MHz	16QAM	26840	25RB#25	20.99
Band26	10MHz	16QAM	26840	50RB#0	20.98
Band26	10MHz	16QAM	26915	1RB#0	22.24
Band26	10MHz	16QAM	26915	1RB#24	22.20
Band26	10MHz	16QAM	26915	1RB#49	22.18

Band26	10MHz	16QAM	26915	25RB#0	21.42
Band26	10MHz	16QAM	26915	25RB#12	21.42
Band26	10MHz	16QAM	26915	25RB#25	21.34
Band26	10MHz	16QAM	26915	50RB#0	21.39
Band26	10MHz	16QAM	26990	1RB#0	22.41
Band26	10MHz	16QAM	26990	1RB#24	22.40
Band26	10MHz	16QAM	26990	1RB#49	22.51
Band26	10MHz	16QAM	26990	25RB#0	21.62
Band26	10MHz	16QAM	26990	25RB#12	21.62
Band26	10MHz	16QAM	26990	25RB#25	21.73
Band26	10MHz	16QAM	26990	50RB#0	21.58
Band26	15MHz	QPSK	26865	1RB#0	22.39
Band26	15MHz	QPSK	26865	1RB#38	22.65
Band26	15MHz	QPSK	26865	1RB#74	22.51
Band26	15MHz	QPSK	26865	38RB#0	22.13
Band26	15MHz	QPSK	26865	38RB#18	22.22
Band26	15MHz	QPSK	26865	38RB#37	22.14
Band26	15MHz	QPSK	26865	75RB#0	21.99
Band26	15MHz	QPSK	26915	1RB#0	22.90
Band26	15MHz	QPSK	26915	1RB#38	22.69
Band26	15MHz	QPSK	26915	1RB#74	22.89
Band26	15MHz	QPSK	26915	38RB#0	22.24
Band26	15MHz	QPSK	26915	38RB#18	22.31
Band26	15MHz	QPSK	26915	38RB#37	22.19
Band26	15MHz	QPSK	26915	75RB#0	21.97
Band26	15MHz	QPSK	26965	1RB#0	22.87
Band26	15MHz	QPSK	26965	1RB#38	22.83
Band26	15MHz	QPSK	26965	1RB#74	22.76
Band26	15MHz	QPSK	26965	38RB#0	22.47
Band26	15MHz	QPSK	26965	38RB#18	22.42
Band26	15MHz	QPSK	26965	38RB#37	22.58
Band26	15MHz	QPSK	26965	75RB#0	22.17
Band26	15MHz	16QAM	26865	1RB#0	22.15
Band26	15MHz	16QAM	26865	1RB#38	22.27
Band26	15MHz	16QAM	26865	1RB#74	22.13
Band26	15MHz	16QAM	26865	38RB#0	22.13
Band26	15MHz	16QAM	26865	38RB#18	22.21
Band26	15MHz	16QAM	26865	38RB#37	22.14

Band26	15MHz	16QAM	26865	75RB#0	21.40
Band26	15MHz	16QAM	26915	1RB#0	22.25
Band26	15MHz	16QAM	26915	1RB#38	22.31
Band26	15MHz	16QAM	26915	1RB#74	22.20
Band26	15MHz	16QAM	26915	38RB#0	22.24
Band26	15MHz	16QAM	26915	38RB#18	22.29
Band26	15MHz	16QAM	26915	38RB#37	22.18
Band26	15MHz	16QAM	26915	75RB#0	21.45
Band26	15MHz	16QAM	26965	1RB#0	22.49
Band26	15MHz	16QAM	26965	1RB#38	22.44
Band26	15MHz	16QAM	26965	1RB#74	22.57
Band26	15MHz	16QAM	26965	38RB#0	22.48
Band26	15MHz	16QAM	26965	38RB#18	22.42
Band26	15MHz	16QAM	26965	38RB#37	22.57
Band26	15MHz	16QAM	26965	75RB#0	21.58
Band38	5MHz	QPSK	37775	1RB#0	22.42
Band38	5MHz	QPSK	37775	1RB#12	22.42
Band38	5MHz	QPSK	37775	1RB#24	22.53
Band38	5MHz	QPSK	37775	12RB#0	21.53
Band38	5MHz	QPSK	37775	12RB#6	21.50
Band38	5MHz	QPSK	37775	12RB#13	21.62
Band38	5MHz	QPSK	37775	25RB#0	21.50
Band38	5MHz	QPSK	38000	1RB#0	23.07
Band38	5MHz	QPSK	38000	1RB#12	22.77
Band38	5MHz	QPSK	38000	1RB#24	22.88
Band38	5MHz	QPSK	38000	12RB#0	22.07
Band38	5MHz	QPSK	38000	12RB#6	22.07
Band38	5MHz	QPSK	38000	12RB#13	21.96
Band38	5MHz	QPSK	38000	25RB#0	21.99
Band38	5MHz	QPSK	38225	1RB#0	22.28
Band38	5MHz	QPSK	38225	1RB#12	22.25
Band38	5MHz	QPSK	38225	1RB#24	22.29
Band38	5MHz	QPSK	38225	12RB#0	21.27
Band38	5MHz	QPSK	38225	12RB#6	21.27
Band38	5MHz	QPSK	38225	12RB#13	21.28
Band38	5MHz	QPSK	38225	25RB#0	21.34
Band38	5MHz	16QAM	37775	1RB#0	21.54
Band38	5MHz	16QAM	37775	1RB#12	21.54

Band38	5MHz	16QAM	37775	1RB#24	21.65
Band38	5MHz	16QAM	37775	12RB#0	20.62
Band38	5MHz	16QAM	37775	12RB#6	20.59
Band38	5MHz	16QAM	37775	12RB#13	20.72
Band38	5MHz	16QAM	37775	25RB#0	20.62
Band38	5MHz	16QAM	38000	1RB#0	22.14
Band38	5MHz	16QAM	38000	1RB#12	21.89
Band38	5MHz	16QAM	38000	1RB#24	21.99
Band38	5MHz	16QAM	38000	12RB#0	21.18
Band38	5MHz	16QAM	38000	12RB#6	21.17
Band38	5MHz	16QAM	38000	12RB#13	21.05
Band38	5MHz	16QAM	38000	25RB#0	21.11
Band38	5MHz	16QAM	38225	1RB#0	21.32
Band38	5MHz	16QAM	38225	1RB#12	21.35
Band38	5MHz	16QAM	38225	1RB#24	21.30
Band38	5MHz	16QAM	38225	12RB#0	20.36
Band38	5MHz	16QAM	38225	12RB#6	20.35
Band38	5MHz	16QAM	38225	12RB#13	20.43
Band38	5MHz	16QAM	38225	25RB#0	20.46
Band38	10MHz	QPSK	37800	1RB#0	22.57
Band38	10MHz	QPSK	37800	1RB#24	22.63
Band38	10MHz	QPSK	37800	1RB#49	22.81
Band38	10MHz	QPSK	37800	25RB#0	21.75
Band38	10MHz	QPSK	37800	25RB#12	21.71
Band38	10MHz	QPSK	37800	25RB#25	21.90
Band38	10MHz	QPSK	37800	50RB#0	21.75
Band38	10MHz	QPSK	38000	1RB#0	23.11
Band38	10MHz	QPSK	38000	1RB#24	22.85
Band38	10MHz	QPSK	38000	1RB#49	22.94
Band38	10MHz	QPSK	38000	25RB#0	22.18
Band38	10MHz	QPSK	38000	25RB#12	22.17
Band38	10MHz	QPSK	38000	25RB#25	22.12
Band38	10MHz	QPSK	38000	50RB#0	22.11
Band38	10MHz	QPSK	38200	1RB#0	22.41
Band38	10MHz	QPSK	38200	1RB#24	22.16
Band38	10MHz	QPSK	38200	1RB#49	22.44
Band38	10MHz	QPSK	38200	25RB#0	21.22
Band38	10MHz	QPSK	38200	25RB#12	21.21

Band38	10MHz	QPSK	38200	25RB#25	21.47
Band38	10MHz	QPSK	38200	50RB#0	21.29
Band38	10MHz	16QAM	37800	1RB#0	21.82
Band38	10MHz	16QAM	37800	1RB#24	21.89
Band38	10MHz	16QAM	37800	1RB#49	22.11
Band38	10MHz	16QAM	37800	25RB#0	20.83
Band38	10MHz	16QAM	37800	25RB#12	20.79
Band38	10MHz	16QAM	37800	25RB#25	20.96
Band38	10MHz	16QAM	37800	50RB#0	20.86
Band38	10MHz	16QAM	38000	1RB#0	22.34
Band38	10MHz	16QAM	38000	1RB#24	22.14
Band38	10MHz	16QAM	38000	1RB#49	22.23
Band38	10MHz	16QAM	38000	25RB#0	21.27
Band38	10MHz	16QAM	38000	25RB#12	21.26
Band38	10MHz	16QAM	38000	25RB#25	21.21
Band38	10MHz	16QAM	38000	50RB#0	21.21
Band38	10MHz	16QAM	38200	1RB#0	21.62
Band38	10MHz	16QAM	38200	1RB#24	21.42
Band38	10MHz	16QAM	38200	1RB#49	21.62
Band38	10MHz	16QAM	38200	25RB#0	20.31
Band38	10MHz	16QAM	38200	25RB#12	20.29
Band38	10MHz	16QAM	38200	25RB#25	20.55
Band38	10MHz	16QAM	38200	50RB#0	20.39
Band38	15MHz	QPSK	37825	1RB#0	22.60
Band38	15MHz	QPSK	37825	1RB#38	22.50
Band38	15MHz	QPSK	37825	1RB#74	23.00
Band38	15MHz	QPSK	37825	38RB#0	21.74
Band38	15MHz	QPSK	37825	38RB#18	21.70
Band38	15MHz	QPSK	37825	38RB#37	22.25
Band38	15MHz	QPSK	37825	75RB#0	21.77
Band38	15MHz	QPSK	38000	1RB#0	23.28
Band38	15MHz	QPSK	38000	1RB#38	22.68
Band38	15MHz	QPSK	38000	1RB#74	22.92
Band38	15MHz	QPSK	38000	38RB#0	22.49
Band38	15MHz	QPSK	38000	38RB#18	21.89
Band38	15MHz	QPSK	38000	38RB#37	22.18
Band38	15MHz	QPSK	38000	75RB#0	21.98
Band38	15MHz	QPSK	38175	1RB#0	22.34

Band38	15MHz	QPSK	38175	1RB#38	21.79
Band38	15MHz	QPSK	38175	1RB#74	22.47
Band38	15MHz	QPSK	38175	38RB#0	21.47
Band38	15MHz	QPSK	38175	38RB#18	20.99
Band38	15MHz	QPSK	38175	38RB#37	21.63
Band38	15MHz	QPSK	38175	75RB#0	21.21
Band38	15MHz	16QAM	37825	1RB#0	21.85
Band38	15MHz	16QAM	37825	1RB#38	21.81
Band38	15MHz	16QAM	37825	1RB#74	22.32
Band38	15MHz	16QAM	37825	38RB#0	21.72
Band38	15MHz	16QAM	37825	38RB#18	21.70
Band38	15MHz	16QAM	37825	38RB#37	22.24
Band38	15MHz	16QAM	37825	75RB#0	20.82
Band38	15MHz	16QAM	38000	1RB#0	22.57
Band38	15MHz	16QAM	38000	1RB#38	21.94
Band38	15MHz	16QAM	38000	1RB#74	22.21
Band38	15MHz	16QAM	38000	38RB#0	22.49
Band38	15MHz	16QAM	38000	38RB#18	21.88
Band38	15MHz	16QAM	38000	38RB#37	22.17
Band38	15MHz	16QAM	38000	75RB#0	21.07
Band38	15MHz	16QAM	38175	1RB#0	21.55
Band38	15MHz	16QAM	38175	1RB#38	21.03
Band38	15MHz	16QAM	38175	1RB#74	21.65
Band38	15MHz	16QAM	38175	38RB#0	21.47
Band38	15MHz	16QAM	38175	38RB#18	20.99
Band38	15MHz	16QAM	38175	38RB#37	21.62
Band38	15MHz	16QAM	38175	75RB#0	20.29
Band38	20MHz	QPSK	37850	1RB#0	22.77
Band38	20MHz	QPSK	37850	1RB#49	23.09
Band38	20MHz	QPSK	37850	1RB#99	23.40
Band38	20MHz	QPSK	37850	50RB#0	22.13
Band38	20MHz	QPSK	37850	50RB#25	22.09
Band38	20MHz	QPSK	37850	50RB#50	22.41
Band38	20MHz	QPSK	37850	100RB#0	22.09
Band38	20MHz	QPSK	38000	1RB#0	23.40
Band38	20MHz	QPSK	38000	1RB#49	23.08
Band38	20MHz	QPSK	38000	1RB#99	22.96
Band38	20MHz	QPSK	38000	50RB#0	22.44

Band38	20MHz	QPSK	38000	50RB#25	22.40
Band38	20MHz	QPSK	38000	50RB#50	22.25
Band38	20MHz	QPSK	38000	100RB#0	22.24
Band38	20MHz	QPSK	38150	1RB#0	22.46
Band38	20MHz	QPSK	38150	1RB#49	22.03
Band38	20MHz	QPSK	38150	1RB#99	22.33
Band38	20MHz	QPSK	38150	50RB#0	21.17
Band38	20MHz	QPSK	38150	50RB#25	21.16
Band38	20MHz	QPSK	38150	50RB#50	21.19
Band38	20MHz	QPSK	38150	100RB#0	21.20
Band38	20MHz	16QAM	37850	1RB#0	21.85
Band38	20MHz	16QAM	37850	1RB#49	22.11
Band38	20MHz	16QAM	37850	1RB#99	22.54
Band38	20MHz	16QAM	37850	50RB#0	21.19
Band38	20MHz	16QAM	37850	50RB#25	21.16
Band38	20MHz	16QAM	37850	50RB#50	21.46
Band38	20MHz	16QAM	37850	100RB#0	21.17
Band38	20MHz	16QAM	38000	1RB#0	22.52
Band38	20MHz	16QAM	38000	1RB#49	22.18
Band38	20MHz	16QAM	38000	1RB#99	22.04
Band38	20MHz	16QAM	38000	50RB#0	21.53
Band38	20MHz	16QAM	38000	50RB#25	21.48
Band38	20MHz	16QAM	38000	50RB#50	21.33
Band38	20MHz	16QAM	38000	100RB#0	21.32
Band38	20MHz	16QAM	38150	1RB#0	21.51
Band38	20MHz	16QAM	38150	1RB#49	21.10
Band38	20MHz	16QAM	38150	1RB#99	21.33
Band38	20MHz	16QAM	38150	50RB#0	20.28
Band38	20MHz	16QAM	38150	50RB#25	20.24
Band38	20MHz	16QAM	38150	50RB#50	20.26
Band38	20MHz	16QAM	38150	100RB#0	20.27
Band39	5MHz	QPSK	38275	1RB#0	24.25
Band39	5MHz	QPSK	38275	1RB#12	24.10
Band39	5MHz	QPSK	38275	1RB#24	24.10
Band39	5MHz	QPSK	38275	12RB#0	23.17
Band39	5MHz	QPSK	38275	12RB#6	23.17
Band39	5MHz	QPSK	38275	12RB#13	23.17
Band39	5MHz	QPSK	38275	25RB#0	23.16

Band39	5MHz	QPSK	38400	1RB#0	23.70
Band39	5MHz	QPSK	38400	1RB#12	23.61
Band39	5MHz	QPSK	38400	1RB#24	23.65
Band39	5MHz	QPSK	38400	12RB#0	22.66
Band39	5MHz	QPSK	38400	12RB#6	22.65
Band39	5MHz	QPSK	38400	12RB#13	22.65
Band39	5MHz	QPSK	38400	25RB#0	22.65
Band39	5MHz	QPSK	38525	1RB#0	23.89
Band39	5MHz	QPSK	38525	1RB#12	23.79
Band39	5MHz	QPSK	38525	1RB#24	23.78
Band39	5MHz	QPSK	38525	12RB#0	22.84
Band39	5MHz	QPSK	38525	12RB#6	22.84
Band39	5MHz	QPSK	38525	12RB#13	22.83
Band39	5MHz	QPSK	38525	25RB#0	22.83
Band39	5MHz	16QAM	38275	1RB#0	23.34
Band39	5MHz	16QAM	38275	1RB#12	23.18
Band39	5MHz	16QAM	38275	1RB#24	23.18
Band39	5MHz	16QAM	38275	12RB#0	22.27
Band39	5MHz	16QAM	38275	12RB#6	22.26
Band39	5MHz	16QAM	38275	12RB#13	22.27
Band39	5MHz	16QAM	38275	25RB#0	22.28
Band39	5MHz	16QAM	38400	1RB#0	22.75
Band39	5MHz	16QAM	38400	1RB#12	22.68
Band39	5MHz	16QAM	38400	1RB#24	22.72
Band39	5MHz	16QAM	38400	12RB#0	21.76
Band39	5MHz	16QAM	38400	12RB#6	21.75
Band39	5MHz	16QAM	38400	12RB#13	21.75
Band39	5MHz	16QAM	38400	25RB#0	21.76
Band39	5MHz	16QAM	38525	1RB#0	22.94
Band39	5MHz	16QAM	38525	1RB#12	22.86
Band39	5MHz	16QAM	38525	1RB#24	22.85
Band39	5MHz	16QAM	38525	12RB#0	21.94
Band39	5MHz	16QAM	38525	12RB#6	21.93
Band39	5MHz	16QAM	38525	12RB#13	21.93
Band39	5MHz	16QAM	38525	25RB#0	21.95
Band39	10MHz	QPSK	38300	1RB#0	24.31
Band39	10MHz	QPSK	38300	1RB#24	24.07
Band39	10MHz	QPSK	38300	1RB#49	24.19

Band39	10MHz	QPSK	38300	25RB#0	23.27
Band39	10MHz	QPSK	38300	25RB#12	23.26
Band39	10MHz	QPSK	38300	25RB#25	23.20
Band39	10MHz	QPSK	38300	50RB#0	23.19
Band39	10MHz	QPSK	38400	1RB#0	23.85
Band39	10MHz	QPSK	38400	1RB#24	23.58
Band39	10MHz	QPSK	38400	1RB#49	23.71
Band39	10MHz	QPSK	38400	25RB#0	22.71
Band39	10MHz	QPSK	38400	25RB#12	22.71
Band39	10MHz	QPSK	38400	25RB#25	22.71
Band39	10MHz	QPSK	38400	50RB#0	22.70
Band39	10MHz	QPSK	38500	1RB#0	24.08
Band39	10MHz	QPSK	38500	1RB#24	23.81
Band39	10MHz	QPSK	38500	1RB#49	23.94
Band39	10MHz	QPSK	38500	25RB#0	22.99
Band39	10MHz	QPSK	38500	25RB#12	22.99
Band39	10MHz	QPSK	38500	25RB#25	22.94
Band39	10MHz	QPSK	38500	50RB#0	22.93
Band39	10MHz	16QAM	38300	1RB#0	23.58
Band39	10MHz	16QAM	38300	1RB#24	23.33
Band39	10MHz	16QAM	38300	1RB#49	23.46
Band39	10MHz	16QAM	38300	25RB#0	22.35
Band39	10MHz	16QAM	38300	25RB#12	22.34
Band39	10MHz	16QAM	38300	25RB#25	22.29
Band39	10MHz	16QAM	38300	50RB#0	22.27
Band39	10MHz	16QAM	38400	1RB#0	23.09
Band39	10MHz	16QAM	38400	1RB#24	22.84
Band39	10MHz	16QAM	38400	1RB#49	22.97
Band39	10MHz	16QAM	38400	25RB#0	21.80
Band39	10MHz	16QAM	38400	25RB#12	21.79
Band39	10MHz	16QAM	38400	25RB#25	21.80
Band39	10MHz	16QAM	38400	50RB#0	21.78
Band39	10MHz	16QAM	38500	1RB#0	23.33
Band39	10MHz	16QAM	38500	1RB#24	23.07
Band39	10MHz	16QAM	38500	1RB#49	23.20
Band39	10MHz	16QAM	38500	25RB#0	22.08
Band39	10MHz	16QAM	38500	25RB#12	22.07
Band39	10MHz	16QAM	38500	25RB#25	22.03

Band39	10MHz	16QAM	38500	50RB#0	22.02
Band39	15MHz	QPSK	38325	1RB#0	24.43
Band39	15MHz	QPSK	38325	1RB#38	23.95
Band39	15MHz	QPSK	38325	1RB#74	24.24
Band39	15MHz	QPSK	38325	38RB#0	23.68
Band39	15MHz	QPSK	38325	38RB#18	23.19
Band39	15MHz	QPSK	38325	38RB#37	23.50
Band39	15MHz	QPSK	38325	75RB#0	23.14
Band39	15MHz	QPSK	38400	1RB#0	24.00
Band39	15MHz	QPSK	38400	1RB#38	23.52
Band39	15MHz	QPSK	38400	1RB#74	23.83
Band39	15MHz	QPSK	38400	38RB#0	23.22
Band39	15MHz	QPSK	38400	38RB#18	22.76
Band39	15MHz	QPSK	38400	38RB#37	23.09
Band39	15MHz	QPSK	38400	75RB#0	22.71
Band39	15MHz	QPSK	38475	1RB#0	24.28
Band39	15MHz	QPSK	38475	1RB#38	23.82
Band39	15MHz	QPSK	38475	1RB#74	24.08
Band39	15MHz	QPSK	38475	38RB#0	23.51
Band39	15MHz	QPSK	38475	38RB#18	23.06
Band39	15MHz	QPSK	38475	38RB#37	23.34
Band39	15MHz	QPSK	38475	75RB#0	23.01
Band39	15MHz	16QAM	38325	1RB#0	23.71
Band39	15MHz	16QAM	38325	1RB#38	23.22
Band39	15MHz	16QAM	38325	1RB#74	23.52
Band39	15MHz	16QAM	38325	38RB#0	23.68
Band39	15MHz	16QAM	38325	38RB#18	23.19
Band39	15MHz	16QAM	38325	38RB#37	23.50
Band39	15MHz	16QAM	38325	75RB#0	22.20
Band39	15MHz	16QAM	38400	1RB#0	23.25
Band39	15MHz	16QAM	38400	1RB#38	22.78
Band39	15MHz	16QAM	38400	1RB#74	23.10
Band39	15MHz	16QAM	38400	38RB#0	23.22
Band39	15MHz	16QAM	38400	38RB#18	22.76
Band39	15MHz	16QAM	38400	38RB#37	23.09
Band39	15MHz	16QAM	38400	75RB#0	21.78
Band39	15MHz	16QAM	38475	1RB#0	23.53
Band39	15MHz	16QAM	38475	1RB#38	23.08

Band39	15MHz	16QAM	38475	1RB#74	23.35
Band39	15MHz	16QAM	38475	38RB#0	23.51
Band39	15MHz	16QAM	38475	38RB#18	23.06
Band39	15MHz	16QAM	38475	38RB#37	23.34
Band39	15MHz	16QAM	38475	75RB#0	22.08
Band39	20MHz	QPSK	38350	1RB#0	24.27
Band39	20MHz	QPSK	38350	1RB#49	23.95
Band39	20MHz	QPSK	38350	1RB#99	24.02
Band39	20MHz	QPSK	38350	50RB#0	23.24
Band39	20MHz	QPSK	38350	50RB#25	23.23
Band39	20MHz	QPSK	38350	50RB#50	23.10
Band39	20MHz	QPSK	38350	100RB#0	23.18
Band39	20MHz	QPSK	38400	1RB#0	23.87
Band39	20MHz	QPSK	38400	1RB#49	23.52
Band39	20MHz	QPSK	38400	1RB#99	23.61
Band39	20MHz	QPSK	38400	50RB#0	22.83
Band39	20MHz	QPSK	38400	50RB#25	22.82
Band39	20MHz	QPSK	38400	50RB#50	22.69
Band39	20MHz	QPSK	38400	100RB#0	22.78
Band39	20MHz	QPSK	38450	1RB#0	23.89
Band39	20MHz	QPSK	38450	1RB#49	23.57
Band39	20MHz	QPSK	38450	1RB#99	23.63
Band39	20MHz	QPSK	38450	50RB#0	22.84
Band39	20MHz	QPSK	38450	50RB#25	22.83
Band39	20MHz	QPSK	38450	50RB#50	22.70
Band39	20MHz	QPSK	38450	100RB#0	22.77
Band39	20MHz	16QAM	38350	1RB#0	23.39
Band39	20MHz	16QAM	38350	1RB#49	23.05
Band39	20MHz	16QAM	38350	1RB#99	23.13
Band39	20MHz	16QAM	38350	50RB#0	22.34
Band39	20MHz	16QAM	38350	50RB#25	22.33
Band39	20MHz	16QAM	38350	50RB#50	22.20
Band39	20MHz	16QAM	38350	100RB#0	22.28
Band39	20MHz	16QAM	38400	1RB#0	22.98
Band39	20MHz	16QAM	38400	1RB#49	22.62
Band39	20MHz	16QAM	38400	1RB#99	22.73
Band39	20MHz	16QAM	38400	50RB#0	21.93
Band39	20MHz	16QAM	38400	50RB#25	21.92

Band39	20MHz	16QAM	38400	50RB#50	21.79
Band39	20MHz	16QAM	38400	100RB#0	21.88
Band39	20MHz	16QAM	38450	1RB#0	23.00
Band39	20MHz	16QAM	38450	1RB#49	22.66
Band39	20MHz	16QAM	38450	1RB#99	22.74
Band39	20MHz	16QAM	38450	50RB#0	21.94
Band39	20MHz	16QAM	38450	50RB#25	21.92
Band39	20MHz	16QAM	38450	50RB#50	21.79
Band39	20MHz	16QAM	38450	100RB#0	21.86
Band41	5MHz	QPSK	40265	1RB#0	25.20
Band41	5MHz	QPSK	40265	1RB#12	24.96
Band41	5MHz	QPSK	40265	1RB#24	24.74
Band41	5MHz	QPSK	40265	12RB#0	24.06
Band41	5MHz	QPSK	40265	12RB#6	24.04
Band41	5MHz	QPSK	40265	12RB#13	23.91
Band41	5MHz	QPSK	40265	25RB#0	23.95
Band41	5MHz	QPSK	40740	1RB#0	24.27
Band41	5MHz	QPSK	40740	1RB#12	24.02
Band41	5MHz	QPSK	40740	1RB#24	23.93
Band41	5MHz	QPSK	40740	12RB#0	22.99
Band41	5MHz	QPSK	40740	12RB#6	23.00
Band41	5MHz	QPSK	40740	12RB#13	22.97
Band41	5MHz	QPSK	40740	25RB#0	23.00
Band41	5MHz	QPSK	41265	1RB#0	23.97
Band41	5MHz	QPSK	41265	1RB#12	23.65
Band41	5MHz	QPSK	41265	1RB#24	23.72
Band41	5MHz	QPSK	41265	12RB#0	22.37
Band41	5MHz	QPSK	41265	12RB#6	22.38
Band41	5MHz	QPSK	41265	12RB#13	22.33
Band41	5MHz	QPSK	41265	25RB#0	22.35
Band41	5MHz	16QAM	40265	1RB#0	24.29
Band41	5MHz	16QAM	40265	1RB#12	24.08
Band41	5MHz	16QAM	40265	1RB#24	23.84
Band41	5MHz	16QAM	40265	12RB#0	23.16
Band41	5MHz	16QAM	40265	12RB#6	23.14
Band41	5MHz	16QAM	40265	12RB#13	23.01
Band41	5MHz	16QAM	40265	25RB#0	23.08
Band41	5MHz	16QAM	40740	1RB#0	23.25

Band41	5MHz	16QAM	40740	1RB#12	23.08
Band41	5MHz	16QAM	40740	1RB#24	22.99
Band41	5MHz	16QAM	40740	12RB#0	22.16
Band41	5MHz	16QAM	40740	12RB#6	22.15
Band41	5MHz	16QAM	40740	12RB#13	22.13
Band41	5MHz	16QAM	40740	25RB#0	22.19
Band41	5MHz	16QAM	41265	1RB#0	22.61
Band41	5MHz	16QAM	41265	1RB#12	22.39
Band41	5MHz	16QAM	41265	1RB#24	22.44
Band41	5MHz	16QAM	41265	12RB#0	21.45
Band41	5MHz	16QAM	41265	12RB#6	21.45
Band41	5MHz	16QAM	41265	12RB#13	21.39
Band41	5MHz	16QAM	41265	25RB#0	21.44
Band41	10MHz	QPSK	40290	1RB#0	24.86
Band41	10MHz	QPSK	40290	1RB#24	24.39
Band41	10MHz	QPSK	40290	1RB#49	24.30
Band41	10MHz	QPSK	40290	25RB#0	23.65
Band41	10MHz	QPSK	40290	25RB#12	23.65
Band41	10MHz	QPSK	40290	25RB#25	23.44
Band41	10MHz	QPSK	40290	50RB#0	23.50
Band41	10MHz	QPSK	40740	1RB#0	23.99
Band41	10MHz	QPSK	40740	1RB#24	23.66
Band41	10MHz	QPSK	40740	1RB#49	23.63
Band41	10MHz	QPSK	40740	25RB#0	22.74
Band41	10MHz	QPSK	40740	25RB#12	22.77
Band41	10MHz	QPSK	40740	25RB#25	22.69
Band41	10MHz	QPSK	40740	50RB#0	22.77
Band41	10MHz	QPSK	41290	1RB#0	23.67
Band41	10MHz	QPSK	41290	1RB#24	23.49
Band41	10MHz	QPSK	41290	1RB#49	23.96
Band41	10MHz	QPSK	41290	25RB#0	22.14
Band41	10MHz	QPSK	41290	25RB#12	22.13
Band41	10MHz	QPSK	41290	25RB#25	22.50
Band41	10MHz	QPSK	41290	50RB#0	22.31
Band41	10MHz	16QAM	40290	1RB#0	23.94
Band41	10MHz	16QAM	40290	1RB#24	23.59
Band41	10MHz	16QAM	40290	1RB#49	23.50
Band41	10MHz	16QAM	40290	25RB#0	22.79

Band41	10MHz	16QAM	40290	25RB#12	22.78
Band41	10MHz	16QAM	40290	25RB#25	22.58
Band41	10MHz	16QAM	40290	50RB#0	22.63
Band41	10MHz	16QAM	40740	1RB#0	23.19
Band41	10MHz	16QAM	40740	1RB#24	22.91
Band41	10MHz	16QAM	40740	1RB#49	22.89
Band41	10MHz	16QAM	40740	25RB#0	21.91
Band41	10MHz	16QAM	40740	25RB#12	21.92
Band41	10MHz	16QAM	40740	25RB#25	21.84
Band41	10MHz	16QAM	40740	50RB#0	21.93
Band41	10MHz	16QAM	41290	1RB#0	22.46
Band41	10MHz	16QAM	41290	1RB#24	22.40
Band41	10MHz	16QAM	41290	1RB#49	22.90
Band41	10MHz	16QAM	41290	25RB#0	21.18
Band41	10MHz	16QAM	41290	25RB#12	21.18
Band41	10MHz	16QAM	41290	25RB#25	21.53
Band41	10MHz	16QAM	41290	50RB#0	21.36
Band41	15MHz	QPSK	40315	1RB#0	24.31
Band41	15MHz	QPSK	40315	1RB#38	23.73
Band41	15MHz	QPSK	40315	1RB#74	23.87
Band41	15MHz	QPSK	40315	38RB#0	23.46
Band41	15MHz	QPSK	40315	38RB#18	23.02
Band41	15MHz	QPSK	40315	38RB#37	23.11
Band41	15MHz	QPSK	40315	75RB#0	22.88
Band41	15MHz	QPSK	40740	1RB#0	24.06
Band41	15MHz	QPSK	40740	1RB#38	23.54
Band41	15MHz	QPSK	40740	1RB#74	23.55
Band41	15MHz	QPSK	40740	38RB#0	23.18
Band41	15MHz	QPSK	40740	38RB#18	22.78
Band41	15MHz	QPSK	40740	38RB#37	22.82
Band41	15MHz	QPSK	40740	75RB#0	22.71
Band41	15MHz	QPSK	41315	1RB#0	23.95
Band41	15MHz	QPSK	41315	1RB#38	24.07
Band41	15MHz	QPSK	41315	1RB#74	22.65
Band41	15MHz	QPSK	41315	38RB#0	22.72
Band41	15MHz	QPSK	41315	38RB#18	22.96
Band41	15MHz	QPSK	41315	38RB#37	21.83
Band41	15MHz	QPSK	41315	75RB#0	22.62

Band41	15MHz	16QAM	40315	1RB#0	23.49
Band41	15MHz	16QAM	40315	1RB#38	23.03
Band41	15MHz	16QAM	40315	1RB#74	23.13
Band41	15MHz	16QAM	40315	38RB#0	23.44
Band41	15MHz	16QAM	40315	38RB#18	23.02
Band41	15MHz	16QAM	40315	38RB#37	23.12
Band41	15MHz	16QAM	40315	75RB#0	22.00
Band41	15MHz	16QAM	40740	1RB#0	23.24
Band41	15MHz	16QAM	40740	1RB#38	22.78
Band41	15MHz	16QAM	40740	1RB#74	22.81
Band41	15MHz	16QAM	40740	38RB#0	23.20
Band41	15MHz	16QAM	40740	38RB#18	22.77
Band41	15MHz	16QAM	40740	38RB#37	22.82
Band41	15MHz	16QAM	40740	75RB#0	21.84
Band41	15MHz	16QAM	41315	1RB#0	22.72
Band41	15MHz	16QAM	41315	1RB#38	22.98
Band41	15MHz	16QAM	41315	1RB#74	21.81
Band41	15MHz	16QAM	41315	38RB#0	22.70
Band41	15MHz	16QAM	41315	38RB#18	22.97
Band41	15MHz	16QAM	41315	38RB#37	21.84
Band41	15MHz	16QAM	41315	75RB#0	21.64
Band41	20MHz	QPSK	40340	1RB#0	24.04
Band41	20MHz	QPSK	40340	1RB#49	23.76
Band41	20MHz	QPSK	40340	1RB#99	23.79
Band41	20MHz	QPSK	40340	50RB#0	22.93
Band41	20MHz	QPSK	40340	50RB#25	22.91
Band41	20MHz	QPSK	40340	50RB#50	22.85
Band41	20MHz	QPSK	40340	100RB#0	22.88
Band41	20MHz	QPSK	40740	1RB#0	23.77
Band41	20MHz	QPSK	40740	1RB#49	23.55
Band41	20MHz	QPSK	40740	1RB#99	23.19
Band41	20MHz	QPSK	40740	50RB#0	22.77
Band41	20MHz	QPSK	40740	50RB#25	22.79
Band41	20MHz	QPSK	40740	50RB#50	22.53
Band41	20MHz	QPSK	40740	100RB#0	22.76
Band41	20MHz	QPSK	41140	1RB#0	24.33
Band41	20MHz	QPSK	41140	1RB#49	23.72
Band41	20MHz	QPSK	41140	1RB#99	23.38

Band41	20MHz	QPSK	41140	50RB#0	23.22
Band41	20MHz	QPSK	41140	50RB#25	23.30
Band41	20MHz	QPSK	41140	50RB#50	22.45
Band41	20MHz	QPSK	41140	100RB#0	22.90
Band41	20MHz	16QAM	40340	1RB#0	23.27
Band41	20MHz	16QAM	40340	1RB#49	23.06
Band41	20MHz	16QAM	40340	1RB#99	23.06
Band41	20MHz	16QAM	40340	50RB#0	22.05
Band41	20MHz	16QAM	40340	50RB#25	22.04
Band41	20MHz	16QAM	40340	50RB#50	21.95
Band41	20MHz	16QAM	40340	100RB#0	21.99
Band41	20MHz	16QAM	40740	1RB#0	22.84
Band41	20MHz	16QAM	40740	1RB#49	22.66
Band41	20MHz	16QAM	40740	1RB#99	22.28
Band41	20MHz	16QAM	40740	50RB#0	21.90
Band41	20MHz	16QAM	40740	50RB#25	21.91
Band41	20MHz	16QAM	40740	50RB#50	21.69
Band41	20MHz	16QAM	40740	100RB#0	21.92
Band41	20MHz	16QAM	41140	1RB#0	23.41
Band41	20MHz	16QAM	41140	1RB#49	22.82
Band41	20MHz	16QAM	41140	1RB#99	22.06
Band41	20MHz	16QAM	41140	50RB#0	22.36
Band41	20MHz	16QAM	41140	50RB#25	22.39
Band41	20MHz	16QAM	41140	50RB#50	21.54
Band41	20MHz	16QAM	41140	100RB#0	22.03

Effective (Isotropic) Radiated Power Output Data

Band	Bandwidth	Modulation	Channel	RB Configuration	Result(dBm)
Band2	1.4MHz	QPSK	18607	1RB#0	22.91
Band2	1.4MHz	QPSK	18607	1RB#2	22.9
Band2	1.4MHz	QPSK	18607	1RB#5	22.93
Band2	1.4MHz	QPSK	18607	3RB#0	23.38
Band2	1.4MHz	QPSK	18607	3RB#1	23.38
Band2	1.4MHz	QPSK	18607	3RB#3	23.38
Band2	1.4MHz	QPSK	18607	6RB#0	22.37
Band2	1.4MHz	QPSK	18900	1RB#0	23.45
Band2	1.4MHz	QPSK	18900	1RB#2	23.48
Band2	1.4MHz	QPSK	18900	1RB#5	23.55
Band2	1.4MHz	QPSK	18900	3RB#0	23.99
Band2	1.4MHz	QPSK	18900	3RB#1	24
Band2	1.4MHz	QPSK	18900	3RB#3	23.94
Band2	1.4MHz	QPSK	18900	6RB#0	22.98
Band2	1.4MHz	QPSK	19193	1RB#0	23.25
Band2	1.4MHz	QPSK	19193	1RB#2	23.33
Band2	1.4MHz	QPSK	19193	1RB#5	23.25
Band2	1.4MHz	QPSK	19193	3RB#0	23.65
Band2	1.4MHz	QPSK	19193	3RB#1	23.66
Band2	1.4MHz	QPSK	19193	3RB#3	23.67
Band2	1.4MHz	QPSK	19193	6RB#0	22.66
Band2	1.4MHz	16QAM	18607	1RB#0	23.15
Band2	1.4MHz	16QAM	18607	1RB#2	23.17
Band2	1.4MHz	16QAM	18607	1RB#5	23.17
Band2	1.4MHz	16QAM	18607	3RB#0	22.25
Band2	1.4MHz	16QAM	18607	3RB#1	22.22
Band2	1.4MHz	16QAM	18607	3RB#3	22.28
Band2	1.4MHz	16QAM	18607	6RB#0	21.56
Band2	1.4MHz	16QAM	18900	1RB#0	23.78
Band2	1.4MHz	16QAM	18900	1RB#2	23.81
Band2	1.4MHz	16QAM	18900	1RB#5	23.87
Band2	1.4MHz	16QAM	18900	3RB#0	22.85
Band2	1.4MHz	16QAM	18900	3RB#1	22.85
Band2	1.4MHz	16QAM	18900	3RB#3	22.84

Band2	1.4MHz	16QAM	18900	6RB#0	22.23
Band2	1.4MHz	16QAM	19193	1RB#0	23.65
Band2	1.4MHz	16QAM	19193	1RB#2	23.5
Band2	1.4MHz	16QAM	19193	1RB#5	23.45
Band2	1.4MHz	16QAM	19193	3RB#0	22.66
Band2	1.4MHz	16QAM	19193	3RB#1	22.65
Band2	1.4MHz	16QAM	19193	3RB#3	22.63
Band2	1.4MHz	16QAM	19193	6RB#0	22
Band2	3MHz	QPSK	18615	1RB#0	22.91
Band2	3MHz	QPSK	18615	1RB#8	22.94
Band2	3MHz	QPSK	18615	1RB#14	22.95
Band2	3MHz	QPSK	18615	8RB#0	22.17
Band2	3MHz	QPSK	18615	8RB#4	22.16
Band2	3MHz	QPSK	18615	8RB#7	22.2
Band2	3MHz	QPSK	18615	15RB#0	22.16
Band2	3MHz	QPSK	18900	1RB#0	23.29
Band2	3MHz	QPSK	18900	1RB#8	23.27
Band2	3MHz	QPSK	18900	1RB#14	23.33
Band2	3MHz	QPSK	18900	8RB#0	22.86
Band2	3MHz	QPSK	18900	8RB#4	22.86
Band2	3MHz	QPSK	18900	8RB#7	22.89
Band2	3MHz	QPSK	18900	15RB#0	22.85
Band2	3MHz	QPSK	19185	1RB#0	22.99
Band2	3MHz	QPSK	19185	1RB#8	22.99
Band2	3MHz	QPSK	19185	1RB#14	22.87
Band2	3MHz	QPSK	19185	8RB#0	22.6
Band2	3MHz	QPSK	19185	8RB#4	22.59
Band2	3MHz	QPSK	19185	8RB#7	22.59
Band2	3MHz	QPSK	19185	15RB#0	22.57
Band2	3MHz	16QAM	18615	1RB#0	22.78
Band2	3MHz	16QAM	18615	1RB#8	22.84
Band2	3MHz	16QAM	18615	1RB#14	22.73
Band2	3MHz	16QAM	18615	8RB#0	21.59
Band2	3MHz	16QAM	18615	8RB#4	21.6
Band2	3MHz	16QAM	18615	8RB#7	21.6
Band2	3MHz	16QAM	18615	15RB#0	21.09
Band2	3MHz	16QAM	18900	1RB#0	22.99
Band2	3MHz	16QAM	18900	1RB#8	22.99

Band2	3MHz	16QAM	18900	1RB#14	23.01
Band2	3MHz	16QAM	18900	8RB#0	22.17
Band2	3MHz	16QAM	18900	8RB#4	22.18
Band2	3MHz	16QAM	18900	8RB#7	22.17
Band2	3MHz	16QAM	18900	15RB#0	21.99
Band2	3MHz	16QAM	19185	1RB#0	22.81
Band2	3MHz	16QAM	19185	1RB#8	22.83
Band2	3MHz	16QAM	19185	1RB#14	22.78
Band2	3MHz	16QAM	19185	8RB#0	21.94
Band2	3MHz	16QAM	19185	8RB#4	21.9
Band2	3MHz	16QAM	19185	8RB#7	21.94
Band2	3MHz	16QAM	19185	15RB#0	21.76
Band2	5MHz	QPSK	18625	1RB#0	22.79
Band2	5MHz	QPSK	18625	1RB#12	22.86
Band2	5MHz	QPSK	18625	1RB#24	22.78
Band2	5MHz	QPSK	18625	12RB#0	22.18
Band2	5MHz	QPSK	18625	12RB#6	22.2
Band2	5MHz	QPSK	18625	12RB#13	22.21
Band2	5MHz	QPSK	18625	25RB#0	22.17
Band2	5MHz	QPSK	18900	1RB#0	23.51
Band2	5MHz	QPSK	18900	1RB#12	23.54
Band2	5MHz	QPSK	18900	1RB#24	23.55
Band2	5MHz	QPSK	18900	12RB#0	22.81
Band2	5MHz	QPSK	18900	12RB#6	22.81
Band2	5MHz	QPSK	18900	12RB#13	22.83
Band2	5MHz	QPSK	18900	25RB#0	22.83
Band2	5MHz	QPSK	19175	1RB#0	23.25
Band2	5MHz	QPSK	19175	1RB#12	23.21
Band2	5MHz	QPSK	19175	1RB#24	23.33
Band2	5MHz	QPSK	19175	12RB#0	22.57
Band2	5MHz	QPSK	19175	12RB#6	22.58
Band2	5MHz	QPSK	19175	12RB#13	22.57
Band2	5MHz	QPSK	19175	25RB#0	22.57
Band2	5MHz	16QAM	18625	1RB#0	22.63
Band2	5MHz	16QAM	18625	1RB#12	22.64
Band2	5MHz	16QAM	18625	1RB#24	22.67
Band2	5MHz	16QAM	18625	12RB#0	21.49
Band2	5MHz	16QAM	18625	12RB#6	21.49

Band2	5MHz	16QAM	18625	12RB#13	21.39
Band2	5MHz	16QAM	18625	25RB#0	21.27
Band2	5MHz	16QAM	18900	1RB#0	23.01
Band2	5MHz	16QAM	18900	1RB#12	23.03
Band2	5MHz	16QAM	18900	1RB#24	23.03
Band2	5MHz	16QAM	18900	12RB#0	21.94
Band2	5MHz	16QAM	18900	12RB#6	21.95
Band2	5MHz	16QAM	18900	12RB#13	21.96
Band2	5MHz	16QAM	18900	25RB#0	21.94
Band2	5MHz	16QAM	19175	1RB#0	22.78
Band2	5MHz	16QAM	19175	1RB#12	22.74
Band2	5MHz	16QAM	19175	1RB#24	22.74
Band2	5MHz	16QAM	19175	12RB#0	21.72
Band2	5MHz	16QAM	19175	12RB#6	21.73
Band2	5MHz	16QAM	19175	12RB#13	21.77
Band2	5MHz	16QAM	19175	25RB#0	21.76
Band2	10MHz	QPSK	18650	1RB#0	22.83
Band2	10MHz	QPSK	18650	1RB#24	22.8
Band2	10MHz	QPSK	18650	1RB#49	22.76
Band2	10MHz	QPSK	18650	25RB#0	22.12
Band2	10MHz	QPSK	18650	25RB#12	22.14
Band2	10MHz	QPSK	18650	25RB#25	22.07
Band2	10MHz	QPSK	18650	50RB#0	22.01
Band2	10MHz	QPSK	18900	1RB#0	23.31
Band2	10MHz	QPSK	18900	1RB#24	23.24
Band2	10MHz	QPSK	18900	1RB#49	23.15
Band2	10MHz	QPSK	18900	25RB#0	22.83
Band2	10MHz	QPSK	18900	25RB#12	22.84
Band2	10MHz	QPSK	18900	25RB#25	22.85
Band2	10MHz	QPSK	18900	50RB#0	22.82
Band2	10MHz	QPSK	19150	1RB#0	22.97
Band2	10MHz	QPSK	19150	1RB#24	22.98
Band2	10MHz	QPSK	19150	1RB#49	22.79
Band2	10MHz	QPSK	19150	25RB#0	22.61
Band2	10MHz	QPSK	19150	25RB#12	22.58
Band2	10MHz	QPSK	19150	25RB#25	22.56
Band2	10MHz	QPSK	19150	50RB#0	22.57
Band2	10MHz	16QAM	18650	1RB#0	22.78

Band2	10MHz	16QAM	18650	1RB#24	22.63
Band2	10MHz	16QAM	18650	1RB#49	22.58
Band2	10MHz	16QAM	18650	25RB#0	21.3
Band2	10MHz	16QAM	18650	25RB#12	21.29
Band2	10MHz	16QAM	18650	25RB#25	21.28
Band2	10MHz	16QAM	18650	50RB#0	21.25
Band2	10MHz	16QAM	18900	1RB#0	23.07
Band2	10MHz	16QAM	18900	1RB#24	23.1
Band2	10MHz	16QAM	18900	1RB#49	23.17
Band2	10MHz	16QAM	18900	25RB#0	21.88
Band2	10MHz	16QAM	18900	25RB#12	21.85
Band2	10MHz	16QAM	18900	25RB#25	21.87
Band2	10MHz	16QAM	18900	50RB#0	21.88
Band2	10MHz	16QAM	19150	1RB#0	22.88
Band2	10MHz	16QAM	19150	1RB#24	22.88
Band2	10MHz	16QAM	19150	1RB#49	22.86
Band2	10MHz	16QAM	19150	25RB#0	21.64
Band2	10MHz	16QAM	19150	25RB#12	21.63
Band2	10MHz	16QAM	19150	25RB#25	21.66
Band2	10MHz	16QAM	19150	50RB#0	21.65
Band2	15MHz	QPSK	18675	1RB#0	22.77
Band2	15MHz	QPSK	18675	1RB#38	22.69
Band2	15MHz	QPSK	18675	1RB#74	22.65
Band2	15MHz	QPSK	18675	38RB#0	22.74
Band2	15MHz	QPSK	18675	38RB#18	22.68
Band2	15MHz	QPSK	18675	38RB#37	22.69
Band2	15MHz	QPSK	18675	75RB#0	22.02
Band2	15MHz	QPSK	18900	1RB#0	23.28
Band2	15MHz	QPSK	18900	1RB#38	23.23
Band2	15MHz	QPSK	18900	1RB#74	23.31
Band2	15MHz	QPSK	18900	38RB#0	23.29
Band2	15MHz	QPSK	18900	38RB#18	23.17
Band2	15MHz	QPSK	18900	38RB#37	23.32
Band2	15MHz	QPSK	18900	75RB#0	22.82
Band2	15MHz	QPSK	19125	1RB#0	23.07
Band2	15MHz	QPSK	19125	1RB#38	22.98
Band2	15MHz	QPSK	19125	1RB#74	22.82
Band2	15MHz	QPSK	19125	38RB#0	23.08

Band2	15MHz	QPSK	19125	38RB#18	22.98
Band2	15MHz	QPSK	19125	38RB#37	22.84
Band2	15MHz	QPSK	19125	75RB#0	22.59
Band2	15MHz	16QAM	18675	1RB#0	22.5
Band2	15MHz	16QAM	18675	1RB#38	22.39
Band2	15MHz	16QAM	18675	1RB#74	22.4
Band2	15MHz	16QAM	18675	38RB#0	22.49
Band2	15MHz	16QAM	18675	38RB#18	22.37
Band2	15MHz	16QAM	18675	38RB#37	22.38
Band2	15MHz	16QAM	18675	75RB#0	21.15
Band2	15MHz	16QAM	18900	1RB#0	23.06
Band2	15MHz	16QAM	18900	1RB#38	23.04
Band2	15MHz	16QAM	18900	1RB#74	23.14
Band2	15MHz	16QAM	18900	38RB#0	23.01
Band2	15MHz	16QAM	18900	38RB#18	23.03
Band2	15MHz	16QAM	18900	38RB#37	23.15
Band2	15MHz	16QAM	18900	75RB#0	21.87
Band2	15MHz	16QAM	19125	1RB#0	22.88
Band2	15MHz	16QAM	19125	1RB#38	22.79
Band2	15MHz	16QAM	19125	1RB#74	22.8
Band2	15MHz	16QAM	19125	38RB#0	22.92
Band2	15MHz	16QAM	19125	38RB#18	22.83
Band2	15MHz	16QAM	19125	38RB#37	22.82
Band2	15MHz	16QAM	19125	75RB#0	21.64
Band2	20MHz	QPSK	18700	1RB#0	23.03
Band2	20MHz	QPSK	18700	1RB#49	22.94
Band2	20MHz	QPSK	18700	1RB#99	23.05
Band2	20MHz	QPSK	18700	50RB#0	22.01
Band2	20MHz	QPSK	18700	50RB#25	21.97
Band2	20MHz	QPSK	18700	50RB#50	21.96
Band2	20MHz	QPSK	18700	100RB#0	21.95
Band2	20MHz	QPSK	18900	1RB#0	23.44
Band2	20MHz	QPSK	18900	1RB#49	23.41
Band2	20MHz	QPSK	18900	1RB#99	23.47
Band2	20MHz	QPSK	18900	50RB#0	22.83
Band2	20MHz	QPSK	18900	50RB#25	22.83
Band2	20MHz	QPSK	18900	50RB#50	22.83
Band2	20MHz	QPSK	18900	100RB#0	22.85

Band2	20MHz	QPSK	19100	1RB#0	23.19
Band2	20MHz	QPSK	19100	1RB#49	23.06
Band2	20MHz	QPSK	19100	1RB#99	23.02
Band2	20MHz	QPSK	19100	50RB#0	22.16
Band2	20MHz	QPSK	19100	50RB#25	22.16
Band2	20MHz	QPSK	19100	50RB#50	22.09
Band2	20MHz	QPSK	19100	100RB#0	22.11
Band2	20MHz	16QAM	18700	1RB#0	22.66
Band2	20MHz	16QAM	18700	1RB#49	22.49
Band2	20MHz	16QAM	18700	1RB#99	22.68
Band2	20MHz	16QAM	18700	50RB#0	21.2
Band2	20MHz	16QAM	18700	50RB#25	21.21
Band2	20MHz	16QAM	18700	50RB#50	21.25
Band2	20MHz	16QAM	18700	100RB#0	21.14
Band2	20MHz	16QAM	18900	1RB#0	22.94
Band2	20MHz	16QAM	18900	1RB#49	22.81
Band2	20MHz	16QAM	18900	1RB#99	22.86
Band2	20MHz	16QAM	18900	50RB#0	21.86
Band2	20MHz	16QAM	18900	50RB#25	21.87
Band2	20MHz	16QAM	18900	50RB#50	21.9
Band2	20MHz	16QAM	18900	100RB#0	21.9
Band2	20MHz	16QAM	19100	1RB#0	22.32
Band2	20MHz	16QAM	19100	1RB#49	22.28
Band2	20MHz	16QAM	19100	1RB#99	22.17
Band2	20MHz	16QAM	19100	50RB#0	21.26
Band2	20MHz	16QAM	19100	50RB#25	21.25
Band2	20MHz	16QAM	19100	50RB#50	21.2
Band2	20MHz	16QAM	19100	100RB#0	21.27
Band5	1.4MHz	QPSK	20407	1RB#0	27.03
Band5	1.4MHz	QPSK	20407	1RB#2	27.05
Band5	1.4MHz	QPSK	20407	1RB#5	27.02
Band5	1.4MHz	QPSK	20407	3RB#0	27.48
Band5	1.4MHz	QPSK	20407	3RB#1	27.48
Band5	1.4MHz	QPSK	20407	3RB#3	27.48
Band5	1.4MHz	QPSK	20407	6RB#0	26.35
Band5	1.4MHz	QPSK	20525	1RB#0	27.07
Band5	1.4MHz	QPSK	20525	1RB#2	27.12
Band5	1.4MHz	QPSK	20525	1RB#5	27.09

Band5	1.4MHz	QPSK	20525	3RB#0	27.64
Band5	1.4MHz	QPSK	20525	3RB#1	27.62
Band5	1.4MHz	QPSK	20525	3RB#3	27.61
Band5	1.4MHz	QPSK	20525	6RB#0	26.51
Band5	1.4MHz	QPSK	20643	1RB#0	27.62
Band5	1.4MHz	QPSK	20643	1RB#2	27.58
Band5	1.4MHz	QPSK	20643	1RB#5	27.8
Band5	1.4MHz	QPSK	20643	3RB#0	28.41
Band5	1.4MHz	QPSK	20643	3RB#1	28.37
Band5	1.4MHz	QPSK	20643	3RB#3	28.13
Band5	1.4MHz	QPSK	20643	6RB#0	26.73
Band5	1.4MHz	16QAM	20407	1RB#0	27.19
Band5	1.4MHz	16QAM	20407	1RB#2	27.19
Band5	1.4MHz	16QAM	20407	1RB#5	27.18
Band5	1.4MHz	16QAM	20407	3RB#0	26.34
Band5	1.4MHz	16QAM	20407	3RB#1	26.33
Band5	1.4MHz	16QAM	20407	3RB#3	26.29
Band5	1.4MHz	16QAM	20407	6RB#0	25.81
Band5	1.4MHz	16QAM	20525	1RB#0	27.27
Band5	1.4MHz	16QAM	20525	1RB#2	27.31
Band5	1.4MHz	16QAM	20525	1RB#5	27.29
Band5	1.4MHz	16QAM	20525	3RB#0	26.52
Band5	1.4MHz	16QAM	20525	3RB#1	26.52
Band5	1.4MHz	16QAM	20525	3RB#3	26.45
Band5	1.4MHz	16QAM	20525	6RB#0	26.06
Band5	1.4MHz	16QAM	20643	1RB#0	27.82
Band5	1.4MHz	16QAM	20643	1RB#2	27.99
Band5	1.4MHz	16QAM	20643	1RB#5	27.82
Band5	1.4MHz	16QAM	20643	3RB#0	26.83
Band5	1.4MHz	16QAM	20643	3RB#1	26.85
Band5	1.4MHz	16QAM	20643	3RB#3	26.93
Band5	1.4MHz	16QAM	20643	6RB#0	26.48
Band5	3MHz	QPSK	20415	1RB#0	26.56
Band5	3MHz	QPSK	20415	1RB#8	26.53
Band5	3MHz	QPSK	20415	1RB#14	26.55
Band5	3MHz	QPSK	20415	8RB#0	25.95
Band5	3MHz	QPSK	20415	8RB#4	25.88
Band5	3MHz	QPSK	20415	8RB#7	25.98

Band5	3MHz	QPSK	20415	15RB#0	25.93
Band5	3MHz	QPSK	20525	1RB#0	26.86
Band5	3MHz	QPSK	20525	1RB#8	26.93
Band5	3MHz	QPSK	20525	1RB#14	26.86
Band5	3MHz	QPSK	20525	8RB#0	26.38
Band5	3MHz	QPSK	20525	8RB#4	26.4
Band5	3MHz	QPSK	20525	8RB#7	26.37
Band5	3MHz	QPSK	20525	15RB#0	26.38
Band5	3MHz	QPSK	20635	1RB#0	27.47
Band5	3MHz	QPSK	20635	1RB#8	27.44
Band5	3MHz	QPSK	20635	1RB#14	27.13
Band5	3MHz	QPSK	20635	8RB#0	26.86
Band5	3MHz	QPSK	20635	8RB#4	26.85
Band5	3MHz	QPSK	20635	8RB#7	26.71
Band5	3MHz	QPSK	20635	15RB#0	26.83
Band5	3MHz	16QAM	20415	1RB#0	26.24
Band5	3MHz	16QAM	20415	1RB#8	26.23
Band5	3MHz	16QAM	20415	1RB#14	26.21
Band5	3MHz	16QAM	20415	8RB#0	25.57
Band5	3MHz	16QAM	20415	8RB#4	25.59
Band5	3MHz	16QAM	20415	8RB#7	25.57
Band5	3MHz	16QAM	20415	15RB#0	25.43
Band5	3MHz	16QAM	20525	1RB#0	26.61
Band5	3MHz	16QAM	20525	1RB#8	26.54
Band5	3MHz	16QAM	20525	1RB#14	26.57
Band5	3MHz	16QAM	20525	8RB#0	25.95
Band5	3MHz	16QAM	20525	8RB#4	25.94
Band5	3MHz	16QAM	20525	8RB#7	25.91
Band5	3MHz	16QAM	20525	15RB#0	25.73
Band5	3MHz	16QAM	20635	1RB#0	27.14
Band5	3MHz	16QAM	20635	1RB#8	27.03
Band5	3MHz	16QAM	20635	1RB#14	27
Band5	3MHz	16QAM	20635	8RB#0	26.39
Band5	3MHz	16QAM	20635	8RB#4	26.37
Band5	3MHz	16QAM	20635	8RB#7	26.38
Band5	3MHz	16QAM	20635	15RB#0	26.27
Band5	5MHz	QPSK	20425	1RB#0	26.82
Band5	5MHz	QPSK	20425	1RB#12	27.03

Band5	5MHz	QPSK	20425	1RB#24	27
Band5	5MHz	QPSK	20425	12RB#0	25.99
Band5	5MHz	QPSK	20425	12RB#6	25.96
Band5	5MHz	QPSK	20425	12RB#13	26
Band5	5MHz	QPSK	20425	25RB#0	25.98
Band5	5MHz	QPSK	20525	1RB#0	27.26
Band5	5MHz	QPSK	20525	1RB#12	27.2
Band5	5MHz	QPSK	20525	1RB#24	27.14
Band5	5MHz	QPSK	20525	12RB#0	26.39
Band5	5MHz	QPSK	20525	12RB#6	26.39
Band5	5MHz	QPSK	20525	12RB#13	26.34
Band5	5MHz	QPSK	20525	25RB#0	26.38
Band5	5MHz	QPSK	20625	1RB#0	27.77
Band5	5MHz	QPSK	20625	1RB#12	27.72
Band5	5MHz	QPSK	20625	1RB#24	27.71
Band5	5MHz	QPSK	20625	12RB#0	26.84
Band5	5MHz	QPSK	20625	12RB#6	26.82
Band5	5MHz	QPSK	20625	12RB#13	26.86
Band5	5MHz	QPSK	20625	25RB#0	26.77
Band5	5MHz	16QAM	20425	1RB#0	26.17
Band5	5MHz	16QAM	20425	1RB#12	26.19
Band5	5MHz	16QAM	20425	1RB#24	26.19
Band5	5MHz	16QAM	20425	12RB#0	25.36
Band5	5MHz	16QAM	20425	12RB#6	25.38
Band5	5MHz	16QAM	20425	12RB#13	25.33
Band5	5MHz	16QAM	20425	25RB#0	25.36
Band5	5MHz	16QAM	20525	1RB#0	26.54
Band5	5MHz	16QAM	20525	1RB#12	26.42
Band5	5MHz	16QAM	20525	1RB#24	26.39
Band5	5MHz	16QAM	20525	12RB#0	25.74
Band5	5MHz	16QAM	20525	12RB#6	25.71
Band5	5MHz	16QAM	20525	12RB#13	25.72
Band5	5MHz	16QAM	20525	25RB#0	25.68
Band5	5MHz	16QAM	20625	1RB#0	26.94
Band5	5MHz	16QAM	20625	1RB#12	26.94
Band5	5MHz	16QAM	20625	1RB#24	26.94
Band5	5MHz	16QAM	20625	12RB#0	26.01
Band5	5MHz	16QAM	20625	12RB#6	26.01

Band5	5MHz	16QAM	20625	12RB#13	26.19
Band5	5MHz	16QAM	20625	25RB#0	26.17
Band5	10MHz	QPSK	20450	1RB#0	26.49
Band5	10MHz	QPSK	20450	1RB#24	26.48
Band5	10MHz	QPSK	20450	1RB#49	26.44
Band5	10MHz	QPSK	20450	25RB#0	25.93
Band5	10MHz	QPSK	20450	25RB#12	25.97
Band5	10MHz	QPSK	20450	25RB#25	25.86
Band5	10MHz	QPSK	20450	50RB#0	25.97
Band5	10MHz	QPSK	20525	1RB#0	26.79
Band5	10MHz	QPSK	20525	1RB#24	26.86
Band5	10MHz	QPSK	20525	1RB#49	26.86
Band5	10MHz	QPSK	20525	25RB#0	26.38
Band5	10MHz	QPSK	20525	25RB#12	26.38
Band5	10MHz	QPSK	20525	25RB#25	26.26
Band5	10MHz	QPSK	20525	50RB#0	26.37
Band5	10MHz	QPSK	20600	1RB#0	27.15
Band5	10MHz	QPSK	20600	1RB#24	27.11
Band5	10MHz	QPSK	20600	1RB#49	27.14
Band5	10MHz	QPSK	20600	25RB#0	26.52
Band5	10MHz	QPSK	20600	25RB#12	26.51
Band5	10MHz	QPSK	20600	25RB#25	26.6
Band5	10MHz	QPSK	20600	50RB#0	26.58
Band5	10MHz	16QAM	20450	1RB#0	26.24
Band5	10MHz	16QAM	20450	1RB#24	26.23
Band5	10MHz	16QAM	20450	1RB#49	26.2
Band5	10MHz	16QAM	20450	25RB#0	25.35
Band5	10MHz	16QAM	20450	25RB#12	25.34
Band5	10MHz	16QAM	20450	25RB#25	25.36
Band5	10MHz	16QAM	20450	50RB#0	25.35
Band5	10MHz	16QAM	20525	1RB#0	26.62
Band5	10MHz	16QAM	20525	1RB#24	26.54
Band5	10MHz	16QAM	20525	1RB#49	26.61
Band5	10MHz	16QAM	20525	25RB#0	25.73
Band5	10MHz	16QAM	20525	25RB#12	25.73
Band5	10MHz	16QAM	20525	25RB#25	25.69
Band5	10MHz	16QAM	20525	50RB#0	25.73
Band5	10MHz	16QAM	20600	1RB#0	26.82

Band5	10MHz	16QAM	20600	1RB#24	26.91
Band5	10MHz	16QAM	20600	1RB#49	26.94
Band5	10MHz	16QAM	20600	25RB#0	25.91
Band5	10MHz	16QAM	20600	25RB#12	25.91
Band5	10MHz	16QAM	20600	25RB#25	26.1
Band5	10MHz	16QAM	20600	50RB#0	25.93
Band7	5MHz	QPSK	20775	1RB#0	22.12
Band7	5MHz	QPSK	20775	1RB#12	22.15
Band7	5MHz	QPSK	20775	1RB#24	22.17
Band7	5MHz	QPSK	20775	12RB#0	21.58
Band7	5MHz	QPSK	20775	12RB#6	21.59
Band7	5MHz	QPSK	20775	12RB#13	21.65
Band7	5MHz	QPSK	20775	25RB#0	21.57
Band7	5MHz	QPSK	21100	1RB#0	21.46
Band7	5MHz	QPSK	21100	1RB#12	21.5
Band7	5MHz	QPSK	21100	1RB#24	21.52
Band7	5MHz	QPSK	21100	12RB#0	20.9
Band7	5MHz	QPSK	21100	12RB#6	20.92
Band7	5MHz	QPSK	21100	12RB#13	21
Band7	5MHz	QPSK	21100	25RB#0	20.91
Band7	5MHz	QPSK	21425	1RB#0	21.14
Band7	5MHz	QPSK	21425	1RB#12	21.55
Band7	5MHz	QPSK	21425	1RB#24	21.6
Band7	5MHz	QPSK	21425	12RB#0	20.59
Band7	5MHz	QPSK	21425	12RB#6	20.58
Band7	5MHz	QPSK	21425	12RB#13	20.61
Band7	5MHz	QPSK	21425	25RB#0	20.56
Band7	5MHz	16QAM	20775	1RB#0	21.68
Band7	5MHz	16QAM	20775	1RB#12	21.66
Band7	5MHz	16QAM	20775	1RB#24	21.74
Band7	5MHz	16QAM	20775	12RB#0	20.81
Band7	5MHz	16QAM	20775	12RB#6	20.8
Band7	5MHz	16QAM	20775	12RB#13	20.78
Band7	5MHz	16QAM	20775	25RB#0	20.79
Band7	5MHz	16QAM	21100	1RB#0	20.97
Band7	5MHz	16QAM	21100	1RB#12	21
Band7	5MHz	16QAM	21100	1RB#24	21.04
Band7	5MHz	16QAM	21100	12RB#0	20.13

Band7	5MHz	16QAM	21100	12RB#6	20.12
Band7	5MHz	16QAM	21100	12RB#13	20.12
Band7	5MHz	16QAM	21100	25RB#0	20.11
Band7	5MHz	16QAM	21425	1RB#0	20.63
Band7	5MHz	16QAM	21425	1RB#12	20.36
Band7	5MHz	16QAM	21425	1RB#24	20.36
Band7	5MHz	16QAM	21425	12RB#0	19.73
Band7	5MHz	16QAM	21425	12RB#6	19.79
Band7	5MHz	16QAM	21425	12RB#13	20.02
Band7	5MHz	16QAM	21425	25RB#0	19.59
Band7	10MHz	QPSK	20800	1RB#0	21.86
Band7	10MHz	QPSK	20800	1RB#24	21.88
Band7	10MHz	QPSK	20800	1RB#49	21.72
Band7	10MHz	QPSK	20800	25RB#0	21.43
Band7	10MHz	QPSK	20800	25RB#12	21.44
Band7	10MHz	QPSK	20800	25RB#25	21.48
Band7	10MHz	QPSK	20800	50RB#0	21.46
Band7	10MHz	QPSK	21100	1RB#0	21
Band7	10MHz	QPSK	21100	1RB#24	21.19
Band7	10MHz	QPSK	21100	1RB#49	21.22
Band7	10MHz	QPSK	21100	25RB#0	20.8
Band7	10MHz	QPSK	21100	25RB#12	20.77
Band7	10MHz	QPSK	21100	25RB#25	20.71
Band7	10MHz	QPSK	21100	50RB#0	20.68
Band7	10MHz	QPSK	21400	1RB#0	20.93
Band7	10MHz	QPSK	21400	1RB#24	20.71
Band7	10MHz	QPSK	21400	1RB#49	20.53
Band7	10MHz	QPSK	21400	25RB#0	20.5
Band7	10MHz	QPSK	21400	25RB#12	20.5
Band7	10MHz	QPSK	21400	25RB#25	20.47
Band7	10MHz	QPSK	21400	50RB#0	20.47
Band7	10MHz	16QAM	20800	1RB#0	21.63
Band7	10MHz	16QAM	20800	1RB#24	21.53
Band7	10MHz	16QAM	20800	1RB#49	21.69
Band7	10MHz	16QAM	20800	25RB#0	20.75
Band7	10MHz	16QAM	20800	25RB#12	20.75
Band7	10MHz	16QAM	20800	25RB#25	20.69
Band7	10MHz	16QAM	20800	50RB#0	20.75

Band7	10MHz	16QAM	21100	1RB#0	20.86
Band7	10MHz	16QAM	21100	1RB#24	21.07
Band7	10MHz	16QAM	21100	1RB#49	20.94
Band7	10MHz	16QAM	21100	25RB#0	20.05
Band7	10MHz	16QAM	21100	25RB#12	20.04
Band7	10MHz	16QAM	21100	25RB#25	20.08
Band7	10MHz	16QAM	21100	50RB#0	20.06
Band7	10MHz	16QAM	21400	1RB#0	20.91
Band7	10MHz	16QAM	21400	1RB#24	20.65
Band7	10MHz	16QAM	21400	1RB#49	20.61
Band7	10MHz	16QAM	21400	25RB#0	19.79
Band7	10MHz	16QAM	21400	25RB#12	19.79
Band7	10MHz	16QAM	21400	25RB#25	19.75
Band7	10MHz	16QAM	21400	50RB#0	19.76
Band7	15MHz	QPSK	20825	1RB#0	21.87
Band7	15MHz	QPSK	20825	1RB#38	21.84
Band7	15MHz	QPSK	20825	1RB#74	21.72
Band7	15MHz	QPSK	20825	38RB#0	21.69
Band7	15MHz	QPSK	20825	38RB#18	21.67
Band7	15MHz	QPSK	20825	38RB#37	21.68
Band7	15MHz	QPSK	20825	75RB#0	21.41
Band7	15MHz	QPSK	21100	1RB#0	20.98
Band7	15MHz	QPSK	21100	1RB#38	21.16
Band7	15MHz	QPSK	21100	1RB#74	21.26
Band7	15MHz	QPSK	21100	38RB#0	21.01
Band7	15MHz	QPSK	21100	38RB#18	20.96
Band7	15MHz	QPSK	21100	38RB#37	21
Band7	15MHz	QPSK	21100	75RB#0	20.73
Band7	15MHz	QPSK	21375	1RB#0	20.93
Band7	15MHz	QPSK	21375	1RB#38	20.71
Band7	15MHz	QPSK	21375	1RB#74	20.6
Band7	15MHz	QPSK	21375	38RB#0	20.81
Band7	15MHz	QPSK	21375	38RB#18	20.7
Band7	15MHz	QPSK	21375	38RB#37	20.62
Band7	15MHz	QPSK	21375	75RB#0	20.48
Band7	15MHz	16QAM	20825	1RB#0	21.72
Band7	15MHz	16QAM	20825	1RB#38	21.74
Band7	15MHz	16QAM	20825	1RB#74	21.68

Band7	15MHz	16QAM	20825	38RB#0	21.68
Band7	15MHz	16QAM	20825	38RB#18	21.67
Band7	15MHz	16QAM	20825	38RB#37	21.68
Band7	15MHz	16QAM	20825	75RB#0	20.71
Band7	15MHz	16QAM	21100	1RB#0	20.83
Band7	15MHz	16QAM	21100	1RB#38	20.96
Band7	15MHz	16QAM	21100	1RB#74	20.95
Band7	15MHz	16QAM	21100	38RB#0	21.04
Band7	15MHz	16QAM	21100	38RB#18	20.95
Band7	15MHz	16QAM	21100	38RB#37	21
Band7	15MHz	16QAM	21100	75RB#0	20.02
Band7	15MHz	16QAM	21375	1RB#0	20.85
Band7	15MHz	16QAM	21375	1RB#38	20.71
Band7	15MHz	16QAM	21375	1RB#74	20.62
Band7	15MHz	16QAM	21375	38RB#0	20.83
Band7	15MHz	16QAM	21375	38RB#18	20.7
Band7	15MHz	16QAM	21375	38RB#37	20.62
Band7	15MHz	16QAM	21375	75RB#0	19.77
Band7	20MHz	QPSK	20850	1RB#0	22.15
Band7	20MHz	QPSK	20850	1RB#49	22.36
Band7	20MHz	QPSK	20850	1RB#99	22.4
Band7	20MHz	QPSK	20850	50RB#0	21.47
Band7	20MHz	QPSK	20850	50RB#25	21.4
Band7	20MHz	QPSK	20850	50RB#50	21.48
Band7	20MHz	QPSK	20850	100RB#0	21.46
Band7	20MHz	QPSK	21100	1RB#0	21.56
Band7	20MHz	QPSK	21100	1RB#49	21.42
Band7	20MHz	QPSK	21100	1RB#99	21.66
Band7	20MHz	QPSK	21100	50RB#0	20.76
Band7	20MHz	QPSK	21100	50RB#25	20.72
Band7	20MHz	QPSK	21100	50RB#50	20.74
Band7	20MHz	QPSK	21100	100RB#0	20.84
Band7	20MHz	QPSK	21350	1RB#0	21.84
Band7	20MHz	QPSK	21350	1RB#49	21.44
Band7	20MHz	QPSK	21350	1RB#99	21.43
Band7	20MHz	QPSK	21350	50RB#0	21.11
Band7	20MHz	QPSK	21350	50RB#25	21.12
Band7	20MHz	QPSK	21350	50RB#50	20.97

Band7	20MHz	QPSK	21350	100RB#0	20.94
Band7	20MHz	16QAM	20850	1RB#0	21.63
Band7	20MHz	16QAM	20850	1RB#49	21.42
Band7	20MHz	16QAM	20850	1RB#99	21.48
Band7	20MHz	16QAM	20850	50RB#0	20.62
Band7	20MHz	16QAM	20850	50RB#25	20.67
Band7	20MHz	16QAM	20850	50RB#50	20.69
Band7	20MHz	16QAM	20850	100RB#0	20.72
Band7	20MHz	16QAM	21100	1RB#0	20.91
Band7	20MHz	16QAM	21100	1RB#49	20.85
Band7	20MHz	16QAM	21100	1RB#99	21.07
Band7	20MHz	16QAM	21100	50RB#0	19.96
Band7	20MHz	16QAM	21100	50RB#25	19.96
Band7	20MHz	16QAM	21100	50RB#50	20.03
Band7	20MHz	16QAM	21100	100RB#0	20.03
Band7	20MHz	16QAM	21350	1RB#0	21.23
Band7	20MHz	16QAM	21350	1RB#49	20.71
Band7	20MHz	16QAM	21350	1RB#99	20.67
Band7	20MHz	16QAM	21350	50RB#0	20.27
Band7	20MHz	16QAM	21350	50RB#25	20.22
Band7	20MHz	16QAM	21350	50RB#50	20.18
Band7	20MHz	16QAM	21350	100RB#0	20.28
Band12	1.4MHz	QPSK	23017	1RB#0	28.05
Band12	1.4MHz	QPSK	23017	1RB#2	28.08
Band12	1.4MHz	QPSK	23017	1RB#5	28.05
Band12	1.4MHz	QPSK	23017	3RB#0	28.55
Band12	1.4MHz	QPSK	23017	3RB#1	28.54
Band12	1.4MHz	QPSK	23017	3RB#3	28.57
Band12	1.4MHz	QPSK	23017	6RB#0	27.44
Band12	1.4MHz	QPSK	23095	1RB#0	27.66
Band12	1.4MHz	QPSK	23095	1RB#2	27.55
Band12	1.4MHz	QPSK	23095	1RB#5	27.53
Band12	1.4MHz	QPSK	23095	3RB#0	28.08
Band12	1.4MHz	QPSK	23095	3RB#1	28.06
Band12	1.4MHz	QPSK	23095	3RB#3	28.06
Band12	1.4MHz	QPSK	23095	6RB#0	26.9
Band12	1.4MHz	QPSK	23173	1RB#0	27.61
Band12	1.4MHz	QPSK	23173	1RB#2	27.67

Band12	1.4MHz	QPSK	23173	1RB#5	27.63
Band12	1.4MHz	QPSK	23173	3RB#0	28.14
Band12	1.4MHz	QPSK	23173	3RB#1	28.13
Band12	1.4MHz	QPSK	23173	3RB#3	28.11
Band12	1.4MHz	QPSK	23173	6RB#0	26.99
Band12	1.4MHz	16QAM	23017	1RB#0	28.39
Band12	1.4MHz	16QAM	23017	1RB#2	28.43
Band12	1.4MHz	16QAM	23017	1RB#5	28.46
Band12	1.4MHz	16QAM	23017	3RB#0	27.47
Band12	1.4MHz	16QAM	23017	3RB#1	27.45
Band12	1.4MHz	16QAM	23017	3RB#3	27.43
Band12	1.4MHz	16QAM	23017	6RB#0	26.96
Band12	1.4MHz	16QAM	23095	1RB#0	28.01
Band12	1.4MHz	16QAM	23095	1RB#2	28
Band12	1.4MHz	16QAM	23095	1RB#5	27.98
Band12	1.4MHz	16QAM	23095	3RB#0	26.98
Band12	1.4MHz	16QAM	23095	3RB#1	26.96
Band12	1.4MHz	16QAM	23095	3RB#3	26.92
Band12	1.4MHz	16QAM	23095	6RB#0	26.37
Band12	1.4MHz	16QAM	23173	1RB#0	28.12
Band12	1.4MHz	16QAM	23173	1RB#2	28.03
Band12	1.4MHz	16QAM	23173	1RB#5	28.06
Band12	1.4MHz	16QAM	23173	3RB#0	27.05
Band12	1.4MHz	16QAM	23173	3RB#1	27.04
Band12	1.4MHz	16QAM	23173	3RB#3	27.04
Band12	1.4MHz	16QAM	23173	6RB#0	26.44
Band12	3MHz	QPSK	23025	1RB#0	27.3
Band12	3MHz	QPSK	23025	1RB#8	27.36
Band12	3MHz	QPSK	23025	1RB#14	27.38
Band12	3MHz	QPSK	23025	8RB#0	26.77
Band12	3MHz	QPSK	23025	8RB#4	26.77
Band12	3MHz	QPSK	23025	8RB#7	26.79
Band12	3MHz	QPSK	23025	15RB#0	26.8
Band12	3MHz	QPSK	23095	1RB#0	27.77
Band12	3MHz	QPSK	23095	1RB#8	27.8
Band12	3MHz	QPSK	23095	1RB#14	27.86
Band12	3MHz	QPSK	23095	8RB#0	26.89
Band12	3MHz	QPSK	23095	8RB#4	26.88

Band12	3MHz	QPSK	23095	8RB#7	26.88
Band12	3MHz	QPSK	23095	15RB#0	26.82
Band12	3MHz	QPSK	23165	1RB#0	27.57
Band12	3MHz	QPSK	23165	1RB#8	27.5
Band12	3MHz	QPSK	23165	1RB#14	27.49
Band12	3MHz	QPSK	23165	8RB#0	26.98
Band12	3MHz	QPSK	23165	8RB#4	26.97
Band12	3MHz	QPSK	23165	8RB#7	26.96
Band12	3MHz	QPSK	23165	15RB#0	26.96
Band12	3MHz	16QAM	23025	1RB#0	26.97
Band12	3MHz	16QAM	23025	1RB#8	27.05
Band12	3MHz	16QAM	23025	1RB#14	27.03
Band12	3MHz	16QAM	23025	8RB#0	26.26
Band12	3MHz	16QAM	23025	8RB#4	26.26
Band12	3MHz	16QAM	23025	8RB#7	26.27
Band12	3MHz	16QAM	23025	15RB#0	26.09
Band12	3MHz	16QAM	23095	1RB#0	27.56
Band12	3MHz	16QAM	23095	1RB#8	27.58
Band12	3MHz	16QAM	23095	1RB#14	27.49
Band12	3MHz	16QAM	23095	8RB#0	26.38
Band12	3MHz	16QAM	23095	8RB#4	26.38
Band12	3MHz	16QAM	23095	8RB#7	26.38
Band12	3MHz	16QAM	23095	15RB#0	25.96
Band12	3MHz	16QAM	23165	1RB#0	27.21
Band12	3MHz	16QAM	23165	1RB#8	27.26
Band12	3MHz	16QAM	23165	1RB#14	27.23
Band12	3MHz	16QAM	23165	8RB#0	26.43
Band12	3MHz	16QAM	23165	8RB#4	26.42
Band12	3MHz	16QAM	23165	8RB#7	26.45
Band12	3MHz	16QAM	23165	15RB#0	26.23
Band12	5MHz	QPSK	23035	1RB#0	27.61
Band12	5MHz	QPSK	23035	1RB#12	27.64
Band12	5MHz	QPSK	23035	1RB#24	27.68
Band12	5MHz	QPSK	23035	12RB#0	26.73
Band12	5MHz	QPSK	23035	12RB#6	26.74
Band12	5MHz	QPSK	23035	12RB#13	26.82
Band12	5MHz	QPSK	23035	25RB#0	26.74
Band12	5MHz	QPSK	23095	1RB#0	27.66

Band12	5MHz	QPSK	23095	1RB#12	27.65
Band12	5MHz	QPSK	23095	1RB#24	27.64
Band12	5MHz	QPSK	23095	12RB#0	26.9
Band12	5MHz	QPSK	23095	12RB#6	26.92
Band12	5MHz	QPSK	23095	12RB#13	26.94
Band12	5MHz	QPSK	23095	25RB#0	26.85
Band12	5MHz	QPSK	23155	1RB#0	27.86
Band12	5MHz	QPSK	23155	1RB#12	27.87
Band12	5MHz	QPSK	23155	1RB#24	27.84
Band12	5MHz	QPSK	23155	12RB#0	26.99
Band12	5MHz	QPSK	23155	12RB#6	26.99
Band12	5MHz	QPSK	23155	12RB#13	26.96
Band12	5MHz	QPSK	23155	25RB#0	26.98
Band12	5MHz	16QAM	23035	1RB#0	26.98
Band12	5MHz	16QAM	23035	1RB#12	27.03
Band12	5MHz	16QAM	23035	1RB#24	27.07
Band12	5MHz	16QAM	23035	12RB#0	26.03
Band12	5MHz	16QAM	23035	12RB#6	26.02
Band12	5MHz	16QAM	23035	12RB#13	26.06
Band12	5MHz	16QAM	23035	25RB#0	25.96
Band12	5MHz	16QAM	23095	1RB#0	27.44
Band12	5MHz	16QAM	23095	1RB#12	27.4
Band12	5MHz	16QAM	23095	1RB#24	27.37
Band12	5MHz	16QAM	23095	12RB#0	26.28
Band12	5MHz	16QAM	23095	12RB#6	26.29
Band12	5MHz	16QAM	23095	12RB#13	26.24
Band12	5MHz	16QAM	23095	25RB#0	26.08
Band12	5MHz	16QAM	23155	1RB#0	27.2
Band12	5MHz	16QAM	23155	1RB#12	27.2
Band12	5MHz	16QAM	23155	1RB#24	27.17
Band12	5MHz	16QAM	23155	12RB#0	26.24
Band12	5MHz	16QAM	23155	12RB#6	26.25
Band12	5MHz	16QAM	23155	12RB#13	26.19
Band12	5MHz	16QAM	23155	25RB#0	26.21
Band12	10MHz	QPSK	23060	1RB#0	27.29
Band12	10MHz	QPSK	23060	1RB#24	27.42
Band12	10MHz	QPSK	23060	1RB#49	27.38
Band12	10MHz	QPSK	23060	25RB#0	26.72

Band12	10MHz	QPSK	23060	25RB#12	26.71
Band12	10MHz	QPSK	23060	25RB#25	26.8
Band12	10MHz	QPSK	23060	50RB#0	26.73
Band12	10MHz	QPSK	23095	1RB#0	27.8
Band12	10MHz	QPSK	23095	1RB#24	27.78
Band12	10MHz	QPSK	23095	1RB#49	27.74
Band12	10MHz	QPSK	23095	25RB#0	26.87
Band12	10MHz	QPSK	23095	25RB#12	26.84
Band12	10MHz	QPSK	23095	25RB#25	26.83
Band12	10MHz	QPSK	23095	50RB#0	26.81
Band12	10MHz	QPSK	23130	1RB#0	27.66
Band12	10MHz	QPSK	23130	1RB#24	27.62
Band12	10MHz	QPSK	23130	1RB#49	27.57
Band12	10MHz	QPSK	23130	25RB#0	27.02
Band12	10MHz	QPSK	23130	25RB#12	26.97
Band12	10MHz	QPSK	23130	25RB#25	26.94
Band12	10MHz	QPSK	23130	50RB#0	26.99
Band12	10MHz	16QAM	23060	1RB#0	27
Band12	10MHz	16QAM	23060	1RB#24	27.16
Band12	10MHz	16QAM	23060	1RB#49	27.1
Band12	10MHz	16QAM	23060	25RB#0	26.01
Band12	10MHz	16QAM	23060	25RB#12	26.04
Band12	10MHz	16QAM	23060	25RB#25	26.11
Band12	10MHz	16QAM	23060	50RB#0	26.09
Band12	10MHz	16QAM	23095	1RB#0	27.51
Band12	10MHz	16QAM	23095	1RB#24	27.53
Band12	10MHz	16QAM	23095	1RB#49	27.44
Band12	10MHz	16QAM	23095	25RB#0	26.2
Band12	10MHz	16QAM	23095	25RB#12	26.19
Band12	10MHz	16QAM	23095	25RB#25	26.17
Band12	10MHz	16QAM	23095	50RB#0	26.2
Band12	10MHz	16QAM	23130	1RB#0	27.31
Band12	10MHz	16QAM	23130	1RB#24	27.25
Band12	10MHz	16QAM	23130	1RB#49	27.23
Band12	10MHz	16QAM	23130	25RB#0	26.29
Band12	10MHz	16QAM	23130	25RB#12	26.28
Band12	10MHz	16QAM	23130	25RB#25	26.2
Band12	10MHz	16QAM	23130	50RB#0	26.27

Band17	5MHz	QPSK	23755	1RB#0	27.69
Band17	5MHz	QPSK	23755	1RB#12	27.73
Band17	5MHz	QPSK	23755	1RB#24	27.74
Band17	5MHz	QPSK	23755	12RB#0	26.81
Band17	5MHz	QPSK	23755	12RB#6	26.83
Band17	5MHz	QPSK	23755	12RB#13	26.86
Band17	5MHz	QPSK	23755	25RB#0	26.77
Band17	5MHz	QPSK	23790	1RB#0	27.67
Band17	5MHz	QPSK	23790	1RB#12	27.64
Band17	5MHz	QPSK	23790	1RB#24	27.62
Band17	5MHz	QPSK	23790	12RB#0	26.86
Band17	5MHz	QPSK	23790	12RB#6	26.86
Band17	5MHz	QPSK	23790	12RB#13	26.84
Band17	5MHz	QPSK	23790	25RB#0	26.79
Band17	5MHz	QPSK	23825	1RB#0	27.9
Band17	5MHz	QPSK	23825	1RB#12	27.85
Band17	5MHz	QPSK	23825	1RB#24	27.86
Band17	5MHz	QPSK	23825	12RB#0	26.97
Band17	5MHz	QPSK	23825	12RB#6	26.98
Band17	5MHz	QPSK	23825	12RB#13	27
Band17	5MHz	QPSK	23825	25RB#0	26.99
Band17	5MHz	16QAM	23755	1RB#0	27.06
Band17	5MHz	16QAM	23755	1RB#12	26.99
Band17	5MHz	16QAM	23755	1RB#24	27.07
Band17	5MHz	16QAM	23755	12RB#0	26.07
Band17	5MHz	16QAM	23755	12RB#6	26.1
Band17	5MHz	16QAM	23755	12RB#13	26.1
Band17	5MHz	16QAM	23755	25RB#0	26.09
Band17	5MHz	16QAM	23790	1RB#0	27.38
Band17	5MHz	16QAM	23790	1RB#12	27.44
Band17	5MHz	16QAM	23790	1RB#24	27.31
Band17	5MHz	16QAM	23790	12RB#0	26.25
Band17	5MHz	16QAM	23790	12RB#6	26.25
Band17	5MHz	16QAM	23790	12RB#13	26.21
Band17	5MHz	16QAM	23790	25RB#0	26.1
Band17	5MHz	16QAM	23825	1RB#0	27.18
Band17	5MHz	16QAM	23825	1RB#12	27.19
Band17	5MHz	16QAM	23825	1RB#24	27.21

Band17	5MHz	16QAM	23825	12RB#0	26.22
Band17	5MHz	16QAM	23825	12RB#6	26.18
Band17	5MHz	16QAM	23825	12RB#13	26.24
Band17	5MHz	16QAM	23825	25RB#0	26.27
Band17	10MHz	QPSK	23780	1RB#0	27.42
Band17	10MHz	QPSK	23780	1RB#24	27.47
Band17	10MHz	QPSK	23780	1RB#49	27.46
Band17	10MHz	QPSK	23780	25RB#0	26.77
Band17	10MHz	QPSK	23780	25RB#12	26.8
Band17	10MHz	QPSK	23780	25RB#25	26.74
Band17	10MHz	QPSK	23780	50RB#0	26.79
Band17	10MHz	QPSK	23790	1RB#0	27.88
Band17	10MHz	QPSK	23790	1RB#24	27.78
Band17	10MHz	QPSK	23790	1RB#49	27.87
Band17	10MHz	QPSK	23790	25RB#0	26.8
Band17	10MHz	QPSK	23790	25RB#12	26.8
Band17	10MHz	QPSK	23790	25RB#25	26.76
Band17	10MHz	QPSK	23790	50RB#0	26.8
Band17	10MHz	QPSK	23800	1RB#0	27.7
Band17	10MHz	QPSK	23800	1RB#24	27.55
Band17	10MHz	QPSK	23800	1RB#49	27.56
Band17	10MHz	QPSK	23800	25RB#0	27.01
Band17	10MHz	QPSK	23800	25RB#12	26.99
Band17	10MHz	QPSK	23800	25RB#25	26.99
Band17	10MHz	QPSK	23800	50RB#0	26.98
Band17	10MHz	16QAM	23780	1RB#0	27.12
Band17	10MHz	16QAM	23780	1RB#24	27.17
Band17	10MHz	16QAM	23780	1RB#49	27.03
Band17	10MHz	16QAM	23780	25RB#0	26.12
Band17	10MHz	16QAM	23780	25RB#12	26.1
Band17	10MHz	16QAM	23780	25RB#25	26.08
Band17	10MHz	16QAM	23780	50RB#0	26.13
Band17	10MHz	16QAM	23790	1RB#0	27.51
Band17	10MHz	16QAM	23790	1RB#24	27.53
Band17	10MHz	16QAM	23790	1RB#49	27.54
Band17	10MHz	16QAM	23790	25RB#0	26.19
Band17	10MHz	16QAM	23790	25RB#12	26.2
Band17	10MHz	16QAM	23790	25RB#25	26.15

Band17	10MHz	16QAM	23790	50RB#0	26.18
Band17	10MHz	16QAM	23800	1RB#0	27.26
Band17	10MHz	16QAM	23800	1RB#24	27.23
Band17	10MHz	16QAM	23800	1RB#49	27.27
Band17	10MHz	16QAM	23800	25RB#0	26.28
Band17	10MHz	16QAM	23800	25RB#12	26.3
Band17	10MHz	16QAM	23800	25RB#25	26.24
Band17	10MHz	16QAM	23800	50RB#0	26.28
Band25	1.4MHz	QPSK	26047	1RB#0	22.77
Band25	1.4MHz	QPSK	26047	1RB#2	22.78
Band25	1.4MHz	QPSK	26047	1RB#5	22.83
Band25	1.4MHz	QPSK	26047	3RB#0	23.37
Band25	1.4MHz	QPSK	26047	3RB#1	23.33
Band25	1.4MHz	QPSK	26047	3RB#3	23.36
Band25	1.4MHz	QPSK	26047	6RB#0	22.08
Band25	1.4MHz	QPSK	26365	1RB#0	23.41
Band25	1.4MHz	QPSK	26365	1RB#2	23.39
Band25	1.4MHz	QPSK	26365	1RB#5	23.4
Band25	1.4MHz	QPSK	26365	3RB#0	23.88
Band25	1.4MHz	QPSK	26365	3RB#1	24.06
Band25	1.4MHz	QPSK	26365	3RB#3	24.06
Band25	1.4MHz	QPSK	26365	6RB#0	22.71
Band25	1.4MHz	QPSK	26683	1RB#0	23.55
Band25	1.4MHz	QPSK	26683	1RB#2	23.35
Band25	1.4MHz	QPSK	26683	1RB#5	23.34
Band25	1.4MHz	QPSK	26683	3RB#0	23.9
Band25	1.4MHz	QPSK	26683	3RB#1	23.84
Band25	1.4MHz	QPSK	26683	3RB#3	24.09
Band25	1.4MHz	QPSK	26683	6RB#0	22.67
Band25	1.4MHz	16QAM	26047	1RB#0	23.05
Band25	1.4MHz	16QAM	26047	1RB#2	23.09
Band25	1.4MHz	16QAM	26047	1RB#5	23.09
Band25	1.4MHz	16QAM	26047	3RB#0	22.12
Band25	1.4MHz	16QAM	26047	3RB#1	22.13
Band25	1.4MHz	16QAM	26047	3RB#3	22.1
Band25	1.4MHz	16QAM	26047	6RB#0	21.73
Band25	1.4MHz	16QAM	26365	1RB#0	23.68
Band25	1.4MHz	16QAM	26365	1RB#2	23.66

Band25	1.4MHz	16QAM	26365	1RB#5	23.68
Band25	1.4MHz	16QAM	26365	3RB#0	22.72
Band25	1.4MHz	16QAM	26365	3RB#1	22.71
Band25	1.4MHz	16QAM	26365	3RB#3	22.7
Band25	1.4MHz	16QAM	26365	6RB#0	22.27
Band25	1.4MHz	16QAM	26683	1RB#0	23.53
Band25	1.4MHz	16QAM	26683	1RB#2	23.41
Band25	1.4MHz	16QAM	26683	1RB#5	23.36
Band25	1.4MHz	16QAM	26683	3RB#0	22.7
Band25	1.4MHz	16QAM	26683	3RB#1	22.72
Band25	1.4MHz	16QAM	26683	3RB#3	22.59
Band25	1.4MHz	16QAM	26683	6RB#0	22.26
Band25	3MHz	QPSK	26055	1RB#0	22.64
Band25	3MHz	QPSK	26055	1RB#8	22.65
Band25	3MHz	QPSK	26055	1RB#14	22.7
Band25	3MHz	QPSK	26055	8RB#0	22.07
Band25	3MHz	QPSK	26055	8RB#4	22.04
Band25	3MHz	QPSK	26055	8RB#7	22.07
Band25	3MHz	QPSK	26055	15RB#0	22.1
Band25	3MHz	QPSK	26365	1RB#0	23.28
Band25	3MHz	QPSK	26365	1RB#8	23.3
Band25	3MHz	QPSK	26365	1RB#14	23.28
Band25	3MHz	QPSK	26365	8RB#0	22.65
Band25	3MHz	QPSK	26365	8RB#4	22.65
Band25	3MHz	QPSK	26365	8RB#7	22.65
Band25	3MHz	QPSK	26365	15RB#0	22.65
Band25	3MHz	QPSK	26675	1RB#0	23.3
Band25	3MHz	QPSK	26675	1RB#8	23.12
Band25	3MHz	QPSK	26675	1RB#14	23.17
Band25	3MHz	QPSK	26675	8RB#0	22.65
Band25	3MHz	QPSK	26675	8RB#4	22.66
Band25	3MHz	QPSK	26675	8RB#7	22.68
Band25	3MHz	QPSK	26675	15RB#0	22.72
Band25	3MHz	16QAM	26055	1RB#0	22.29
Band25	3MHz	16QAM	26055	1RB#8	22.3
Band25	3MHz	16QAM	26055	1RB#14	22.35
Band25	3MHz	16QAM	26055	8RB#0	21.6
Band25	3MHz	16QAM	26055	8RB#4	21.63

Band25	3MHz	16QAM	26055	8RB#7	21.68
Band25	3MHz	16QAM	26055	15RB#0	21.54
Band25	3MHz	16QAM	26365	1RB#0	22.92
Band25	3MHz	16QAM	26365	1RB#8	22.88
Band25	3MHz	16QAM	26365	1RB#14	22.86
Band25	3MHz	16QAM	26365	8RB#0	22.25
Band25	3MHz	16QAM	26365	8RB#4	22.28
Band25	3MHz	16QAM	26365	8RB#7	22.2
Band25	3MHz	16QAM	26365	15RB#0	22.06
Band25	3MHz	16QAM	26675	1RB#0	22.98
Band25	3MHz	16QAM	26675	1RB#8	22.95
Band25	3MHz	16QAM	26675	1RB#14	22.79
Band25	3MHz	16QAM	26675	8RB#0	22.27
Band25	3MHz	16QAM	26675	8RB#4	22.26
Band25	3MHz	16QAM	26675	8RB#7	22.14
Band25	3MHz	16QAM	26675	15RB#0	22.08
Band25	5MHz	QPSK	26065	1RB#0	22.94
Band25	5MHz	QPSK	26065	1RB#12	23.03
Band25	5MHz	QPSK	26065	1RB#24	23.06
Band25	5MHz	QPSK	26065	12RB#0	22.09
Band25	5MHz	QPSK	26065	12RB#6	22.04
Band25	5MHz	QPSK	26065	12RB#13	22.12
Band25	5MHz	QPSK	26065	25RB#0	22.06
Band25	5MHz	QPSK	26365	1RB#0	23.61
Band25	5MHz	QPSK	26365	1RB#12	23.54
Band25	5MHz	QPSK	26365	1RB#24	23.54
Band25	5MHz	QPSK	26365	12RB#0	22.66
Band25	5MHz	QPSK	26365	12RB#6	22.65
Band25	5MHz	QPSK	26365	12RB#13	22.66
Band25	5MHz	QPSK	26365	25RB#0	22.65
Band25	5MHz	QPSK	26665	1RB#0	23.61
Band25	5MHz	QPSK	26665	1RB#12	23.49
Band25	5MHz	QPSK	26665	1RB#24	23.41
Band25	5MHz	QPSK	26665	12RB#0	22.76
Band25	5MHz	QPSK	26665	12RB#6	22.78
Band25	5MHz	QPSK	26665	12RB#13	22.74
Band25	5MHz	QPSK	26665	25RB#0	22.85
Band25	5MHz	16QAM	26065	1RB#0	22.26

Band25	5MHz	16QAM	26065	1RB#12	22.33
Band25	5MHz	16QAM	26065	1RB#24	22.42
Band25	5MHz	16QAM	26065	12RB#0	21.42
Band25	5MHz	16QAM	26065	12RB#6	21.43
Band25	5MHz	16QAM	26065	12RB#13	21.43
Band25	5MHz	16QAM	26065	25RB#0	21.43
Band25	5MHz	16QAM	26365	1RB#0	22.86
Band25	5MHz	16QAM	26365	1RB#12	22.86
Band25	5MHz	16QAM	26365	1RB#24	22.87
Band25	5MHz	16QAM	26365	12RB#0	22
Band25	5MHz	16QAM	26365	12RB#6	21.98
Band25	5MHz	16QAM	26365	12RB#13	21.94
Band25	5MHz	16QAM	26365	25RB#0	21.95
Band25	5MHz	16QAM	26665	1RB#0	22.93
Band25	5MHz	16QAM	26665	1RB#12	23.04
Band25	5MHz	16QAM	26665	1RB#24	22.73
Band25	5MHz	16QAM	26665	12RB#0	22.19
Band25	5MHz	16QAM	26665	12RB#6	22.2
Band25	5MHz	16QAM	26665	12RB#13	22.08
Band25	5MHz	16QAM	26665	25RB#0	22.13
Band25	10MHz	QPSK	26090	1RB#0	22.62
Band25	10MHz	QPSK	26090	1RB#24	22.82
Band25	10MHz	QPSK	26090	1RB#49	22.79
Band25	10MHz	QPSK	26090	25RB#0	22.03
Band25	10MHz	QPSK	26090	25RB#12	22.04
Band25	10MHz	QPSK	26090	25RB#25	22.12
Band25	10MHz	QPSK	26090	50RB#0	22.08
Band25	10MHz	QPSK	26365	1RB#0	23.34
Band25	10MHz	QPSK	26365	1RB#24	23.29
Band25	10MHz	QPSK	26365	1RB#49	23.2
Band25	10MHz	QPSK	26365	25RB#0	22.63
Band25	10MHz	QPSK	26365	25RB#12	22.63
Band25	10MHz	QPSK	26365	25RB#25	22.57
Band25	10MHz	QPSK	26365	50RB#0	22.6
Band25	10MHz	QPSK	26640	1RB#0	23.11
Band25	10MHz	QPSK	26640	1RB#24	22.98
Band25	10MHz	QPSK	26640	1RB#49	22.87
Band25	10MHz	QPSK	26640	25RB#0	22.47

Band25	10MHz	QPSK	26640	25RB#12	22.49
Band25	10MHz	QPSK	26640	25RB#25	22.41
Band25	10MHz	QPSK	26640	50RB#0	22.43
Band25	10MHz	16QAM	26090	1RB#0	22.29
Band25	10MHz	16QAM	26090	1RB#24	22.46
Band25	10MHz	16QAM	26090	1RB#49	22.47
Band25	10MHz	16QAM	26090	25RB#0	21.44
Band25	10MHz	16QAM	26090	25RB#12	21.45
Band25	10MHz	16QAM	26090	25RB#25	21.5
Band25	10MHz	16QAM	26090	50RB#0	21.47
Band25	10MHz	16QAM	26365	1RB#0	22.97
Band25	10MHz	16QAM	26365	1RB#24	22.93
Band25	10MHz	16QAM	26365	1RB#49	22.85
Band25	10MHz	16QAM	26365	25RB#0	21.99
Band25	10MHz	16QAM	26365	25RB#12	21.99
Band25	10MHz	16QAM	26365	25RB#25	21.98
Band25	10MHz	16QAM	26365	50RB#0	22
Band25	10MHz	16QAM	26640	1RB#0	22.84
Band25	10MHz	16QAM	26640	1RB#24	22.72
Band25	10MHz	16QAM	26640	1RB#49	22.55
Band25	10MHz	16QAM	26640	25RB#0	21.81
Band25	10MHz	16QAM	26640	25RB#12	21.81
Band25	10MHz	16QAM	26640	25RB#25	21.76
Band25	10MHz	16QAM	26640	50RB#0	21.77
Band25	15MHz	QPSK	26115	1RB#0	22.65
Band25	15MHz	QPSK	26115	1RB#38	22.77
Band25	15MHz	QPSK	26115	1RB#74	22.83
Band25	15MHz	QPSK	26115	38RB#0	22.36
Band25	15MHz	QPSK	26115	38RB#18	22.44
Band25	15MHz	QPSK	26115	38RB#37	22.42
Band25	15MHz	QPSK	26115	75RB#0	22.13
Band25	15MHz	QPSK	26365	1RB#0	23.28
Band25	15MHz	QPSK	26365	1RB#38	23.25
Band25	15MHz	QPSK	26365	1RB#74	23.15
Band25	15MHz	QPSK	26365	38RB#0	22.91
Band25	15MHz	QPSK	26365	38RB#18	22.89
Band25	15MHz	QPSK	26365	38RB#37	22.81
Band25	15MHz	QPSK	26365	75RB#0	22.6

Band25	15MHz	QPSK	26615	1RB#0	23.19
Band25	15MHz	QPSK	26615	1RB#38	22.95
Band25	15MHz	QPSK	26615	1RB#74	22.7
Band25	15MHz	QPSK	26615	38RB#0	22.88
Band25	15MHz	QPSK	26615	38RB#18	22.77
Band25	15MHz	QPSK	26615	38RB#37	22.58
Band25	15MHz	QPSK	26615	75RB#0	22.47
Band25	15MHz	16QAM	26115	1RB#0	22.34
Band25	15MHz	16QAM	26115	1RB#38	22.48
Band25	15MHz	16QAM	26115	1RB#74	22.47
Band25	15MHz	16QAM	26115	38RB#0	22.33
Band25	15MHz	16QAM	26115	38RB#18	22.45
Band25	15MHz	16QAM	26115	38RB#37	22.42
Band25	15MHz	16QAM	26115	75RB#0	21.43
Band25	15MHz	16QAM	26365	1RB#0	22.94
Band25	15MHz	16QAM	26365	1RB#38	22.89
Band25	15MHz	16QAM	26365	1RB#74	22.82
Band25	15MHz	16QAM	26365	38RB#0	22.91
Band25	15MHz	16QAM	26365	38RB#18	22.91
Band25	15MHz	16QAM	26365	38RB#37	22.84
Band25	15MHz	16QAM	26365	75RB#0	21.97
Band25	15MHz	16QAM	26615	1RB#0	22.87
Band25	15MHz	16QAM	26615	1RB#38	22.75
Band25	15MHz	16QAM	26615	1RB#74	22.59
Band25	15MHz	16QAM	26615	38RB#0	22.89
Band25	15MHz	16QAM	26615	38RB#18	22.77
Band25	15MHz	16QAM	26615	38RB#37	22.57
Band25	15MHz	16QAM	26615	75RB#0	21.79
Band25	20MHz	QPSK	26140	1RB#0	23.14
Band25	20MHz	QPSK	26140	1RB#49	23.28
Band25	20MHz	QPSK	26140	1RB#99	23.28
Band25	20MHz	QPSK	26140	50RB#0	22.1
Band25	20MHz	QPSK	26140	50RB#25	22.07
Band25	20MHz	QPSK	26140	50RB#50	22.15
Band25	20MHz	QPSK	26140	100RB#0	22.21
Band25	20MHz	QPSK	26365	1RB#0	23.76
Band25	20MHz	QPSK	26365	1RB#49	23.67
Band25	20MHz	QPSK	26365	1RB#99	23.58

Band25	20MHz	QPSK	26365	50RB#0	22.65
Band25	20MHz	QPSK	26365	50RB#25	22.64
Band25	20MHz	QPSK	26365	50RB#50	22.56
Band25	20MHz	QPSK	26365	100RB#0	22.62
Band25	20MHz	QPSK	26590	1RB#0	23.7
Band25	20MHz	QPSK	26590	1RB#49	23.66
Band25	20MHz	QPSK	26590	1RB#99	23.41
Band25	20MHz	QPSK	26590	50RB#0	22.57
Band25	20MHz	QPSK	26590	50RB#25	22.56
Band25	20MHz	QPSK	26590	50RB#50	22.48
Band25	20MHz	QPSK	26590	100RB#0	22.56
Band25	20MHz	16QAM	26140	1RB#0	22.18
Band25	20MHz	16QAM	26140	1RB#49	22.23
Band25	20MHz	16QAM	26140	1RB#99	22.27
Band25	20MHz	16QAM	26140	50RB#0	21.41
Band25	20MHz	16QAM	26140	50RB#25	21.37
Band25	20MHz	16QAM	26140	50RB#50	21.43
Band25	20MHz	16QAM	26140	100RB#0	21.46
Band25	20MHz	16QAM	26365	1RB#0	22.82
Band25	20MHz	16QAM	26365	1RB#49	22.69
Band25	20MHz	16QAM	26365	1RB#99	22.61
Band25	20MHz	16QAM	26365	50RB#0	21.95
Band25	20MHz	16QAM	26365	50RB#25	21.94
Band25	20MHz	16QAM	26365	50RB#50	21.85
Band25	20MHz	16QAM	26365	100RB#0	21.94
Band25	20MHz	16QAM	26590	1RB#0	22.72
Band25	20MHz	16QAM	26590	1RB#49	22.68
Band25	20MHz	16QAM	26590	1RB#99	22.43
Band25	20MHz	16QAM	26590	50RB#0	21.85
Band25	20MHz	16QAM	26590	50RB#25	21.84
Band25	20MHz	16QAM	26590	50RB#50	21.75
Band25	20MHz	16QAM	26590	100RB#0	21.86
Band26	1.4MHz	QPSK	26797	1RB#0	26.99
Band26	1.4MHz	QPSK	26797	1RB#2	27.02
Band26	1.4MHz	QPSK	26797	1RB#5	27
Band26	1.4MHz	QPSK	26797	3RB#0	27.52
Band26	1.4MHz	QPSK	26797	3RB#1	27.51
Band26	1.4MHz	QPSK	26797	3RB#3	27.73

Band26	1.4MHz	QPSK	26797	6RB#0	26.25
Band26	1.4MHz	QPSK	26915	1RB#0	27.53
Band26	1.4MHz	QPSK	26915	1RB#2	27.54
Band26	1.4MHz	QPSK	26915	1RB#5	27.58
Band26	1.4MHz	QPSK	26915	3RB#0	28
Band26	1.4MHz	QPSK	26915	3RB#1	28.06
Band26	1.4MHz	QPSK	26915	3RB#3	28.04
Band26	1.4MHz	QPSK	26915	6RB#0	26.79
Band26	1.4MHz	QPSK	27033	1RB#0	28.26
Band26	1.4MHz	QPSK	27033	1RB#2	27.92
Band26	1.4MHz	QPSK	27033	1RB#5	27.89
Band26	1.4MHz	QPSK	27033	3RB#0	28.52
Band26	1.4MHz	QPSK	27033	3RB#1	28.52
Band26	1.4MHz	QPSK	27033	3RB#3	28.44
Band26	1.4MHz	QPSK	27033	6RB#0	27.23
Band26	1.4MHz	16QAM	26797	1RB#0	27.26
Band26	1.4MHz	16QAM	26797	1RB#2	27.25
Band26	1.4MHz	16QAM	26797	1RB#5	27.26
Band26	1.4MHz	16QAM	26797	3RB#0	26.26
Band26	1.4MHz	16QAM	26797	3RB#1	26.26
Band26	1.4MHz	16QAM	26797	3RB#3	26.27
Band26	1.4MHz	16QAM	26797	6RB#0	25.94
Band26	1.4MHz	16QAM	26915	1RB#0	27.87
Band26	1.4MHz	16QAM	26915	1RB#2	27.87
Band26	1.4MHz	16QAM	26915	1RB#5	27.8
Band26	1.4MHz	16QAM	26915	3RB#0	26.82
Band26	1.4MHz	16QAM	26915	3RB#1	26.86
Band26	1.4MHz	16QAM	26915	3RB#3	26.79
Band26	1.4MHz	16QAM	26915	6RB#0	26.45
Band26	1.4MHz	16QAM	27033	1RB#0	28.25
Band26	1.4MHz	16QAM	27033	1RB#2	28.07
Band26	1.4MHz	16QAM	27033	1RB#5	28.01
Band26	1.4MHz	16QAM	27033	3RB#0	27.28
Band26	1.4MHz	16QAM	27033	3RB#1	27.26
Band26	1.4MHz	16QAM	27033	3RB#3	27.07
Band26	1.4MHz	16QAM	27033	6RB#0	26.91
Band26	3MHz	QPSK	26805	1RB#0	26.87
Band26	3MHz	QPSK	26805	1RB#8	26.87

Band26	3MHz	QPSK	26805	1RB#14	26.93
Band26	3MHz	QPSK	26805	8RB#0	26.15
Band26	3MHz	QPSK	26805	8RB#4	26.25
Band26	3MHz	QPSK	26805	8RB#7	26.27
Band26	3MHz	QPSK	26805	15RB#0	26.24
Band26	3MHz	QPSK	26915	1RB#0	27.37
Band26	3MHz	QPSK	26915	1RB#8	27.33
Band26	3MHz	QPSK	26915	1RB#14	27.23
Band26	3MHz	QPSK	26915	8RB#0	26.72
Band26	3MHz	QPSK	26915	8RB#4	26.71
Band26	3MHz	QPSK	26915	8RB#7	26.77
Band26	3MHz	QPSK	26915	15RB#0	26.81
Band26	3MHz	QPSK	27025	1RB#0	27.86
Band26	3MHz	QPSK	27025	1RB#8	27.62
Band26	3MHz	QPSK	27025	1RB#14	27.71
Band26	3MHz	QPSK	27025	8RB#0	27.26
Band26	3MHz	QPSK	27025	8RB#4	27.24
Band26	3MHz	QPSK	27025	8RB#7	27.22
Band26	3MHz	QPSK	27025	15RB#0	27.21
Band26	3MHz	16QAM	26805	1RB#0	26.48
Band26	3MHz	16QAM	26805	1RB#8	26.46
Band26	3MHz	16QAM	26805	1RB#14	26.47
Band26	3MHz	16QAM	26805	8RB#0	25.83
Band26	3MHz	16QAM	26805	8RB#4	25.84
Band26	3MHz	16QAM	26805	8RB#7	25.93
Band26	3MHz	16QAM	26805	15RB#0	25.74
Band26	3MHz	16QAM	26915	1RB#0	27.1
Band26	3MHz	16QAM	26915	1RB#8	27
Band26	3MHz	16QAM	26915	1RB#14	26.93
Band26	3MHz	16QAM	26915	8RB#0	26.38
Band26	3MHz	16QAM	26915	8RB#4	26.38
Band26	3MHz	16QAM	26915	8RB#7	26.4
Band26	3MHz	16QAM	26915	15RB#0	26.24
Band26	3MHz	16QAM	27025	1RB#0	27.6
Band26	3MHz	16QAM	27025	1RB#8	27.5
Band26	3MHz	16QAM	27025	1RB#14	27.26
Band26	3MHz	16QAM	27025	8RB#0	26.77
Band26	3MHz	16QAM	27025	8RB#4	26.73

Band26	3MHz	16QAM	27025	8RB#7	26.86
Band26	3MHz	16QAM	27025	15RB#0	26.58
Band26	5MHz	QPSK	26815	1RB#0	27.18
Band26	5MHz	QPSK	26815	1RB#12	27.22
Band26	5MHz	QPSK	26815	1RB#24	27.23
Band26	5MHz	QPSK	26815	12RB#0	26.25
Band26	5MHz	QPSK	26815	12RB#6	26.26
Band26	5MHz	QPSK	26815	12RB#13	26.32
Band26	5MHz	QPSK	26815	25RB#0	26.24
Band26	5MHz	QPSK	26915	1RB#0	27.71
Band26	5MHz	QPSK	26915	1RB#12	27.79
Band26	5MHz	QPSK	26915	1RB#24	27.64
Band26	5MHz	QPSK	26915	12RB#0	26.88
Band26	5MHz	QPSK	26915	12RB#6	26.87
Band26	5MHz	QPSK	26915	12RB#13	26.76
Band26	5MHz	QPSK	26915	25RB#0	26.75
Band26	5MHz	QPSK	27015	1RB#0	28.19
Band26	5MHz	QPSK	27015	1RB#12	28.1
Band26	5MHz	QPSK	27015	1RB#24	27.9
Band26	5MHz	QPSK	27015	12RB#0	27.18
Band26	5MHz	QPSK	27015	12RB#6	27.17
Band26	5MHz	QPSK	27015	12RB#13	27.21
Band26	5MHz	QPSK	27015	25RB#0	27.13
Band26	5MHz	16QAM	26815	1RB#0	26.42
Band26	5MHz	16QAM	26815	1RB#12	26.43
Band26	5MHz	16QAM	26815	1RB#24	26.45
Band26	5MHz	16QAM	26815	12RB#0	25.74
Band26	5MHz	16QAM	26815	12RB#6	25.72
Band26	5MHz	16QAM	26815	12RB#13	25.75
Band26	5MHz	16QAM	26815	25RB#0	25.71
Band26	5MHz	16QAM	26915	1RB#0	27.05
Band26	5MHz	16QAM	26915	1RB#12	26.98
Band26	5MHz	16QAM	26915	1RB#24	26.92
Band26	5MHz	16QAM	26915	12RB#0	26.2
Band26	5MHz	16QAM	26915	12RB#6	26.2
Band26	5MHz	16QAM	26915	12RB#13	26.15
Band26	5MHz	16QAM	26915	25RB#0	26.22
Band26	5MHz	16QAM	27015	1RB#0	27.55

Band26	5MHz	16QAM	27015	1RB#12	27.53
Band26	5MHz	16QAM	27015	1RB#24	27.2
Band26	5MHz	16QAM	27015	12RB#0	26.63
Band26	5MHz	16QAM	27015	12RB#6	26.62
Band26	5MHz	16QAM	27015	12RB#13	26.61
Band26	5MHz	16QAM	27015	25RB#0	26.6
Band26	10MHz	QPSK	26840	1RB#0	26.89
Band26	10MHz	QPSK	26840	1RB#24	27.01
Band26	10MHz	QPSK	26840	1RB#49	26.98
Band26	10MHz	QPSK	26840	25RB#0	26.22
Band26	10MHz	QPSK	26840	25RB#12	26.25
Band26	10MHz	QPSK	26840	25RB#25	26.3
Band26	10MHz	QPSK	26840	50RB#0	26.32
Band26	10MHz	QPSK	26915	1RB#0	27.5
Band26	10MHz	QPSK	26915	1RB#24	27.32
Band26	10MHz	QPSK	26915	1RB#49	27.4
Band26	10MHz	QPSK	26915	25RB#0	26.77
Band26	10MHz	QPSK	26915	25RB#12	26.77
Band26	10MHz	QPSK	26915	25RB#25	26.72
Band26	10MHz	QPSK	26915	50RB#0	26.79
Band26	10MHz	QPSK	26990	1RB#0	27.43
Band26	10MHz	QPSK	26990	1RB#24	27.73
Band26	10MHz	QPSK	26990	1RB#49	27.45
Band26	10MHz	QPSK	26990	25RB#0	26.95
Band26	10MHz	QPSK	26990	25RB#12	26.96
Band26	10MHz	QPSK	26990	25RB#25	27.07
Band26	10MHz	QPSK	26990	50RB#0	26.96
Band26	10MHz	16QAM	26840	1RB#0	26.52
Band26	10MHz	16QAM	26840	1RB#24	26.59
Band26	10MHz	16QAM	26840	1RB#49	26.6
Band26	10MHz	16QAM	26840	25RB#0	25.78
Band26	10MHz	16QAM	26840	25RB#12	25.76
Band26	10MHz	16QAM	26840	25RB#25	25.82
Band26	10MHz	16QAM	26840	50RB#0	25.81
Band26	10MHz	16QAM	26915	1RB#0	27.07
Band26	10MHz	16QAM	26915	1RB#24	27.03
Band26	10MHz	16QAM	26915	1RB#49	27.01
Band26	10MHz	16QAM	26915	25RB#0	26.25

Band26	10MHz	16QAM	26915	25RB#12	26.25
Band26	10MHz	16QAM	26915	25RB#25	26.17
Band26	10MHz	16QAM	26915	50RB#0	26.22
Band26	10MHz	16QAM	26990	1RB#0	27.24
Band26	10MHz	16QAM	26990	1RB#24	27.23
Band26	10MHz	16QAM	26990	1RB#49	27.34
Band26	10MHz	16QAM	26990	25RB#0	26.45
Band26	10MHz	16QAM	26990	25RB#12	26.45
Band26	10MHz	16QAM	26990	25RB#25	26.56
Band26	10MHz	16QAM	26990	50RB#0	26.41
Band26	15MHz	QPSK	26865	1RB#0	27.22
Band26	15MHz	QPSK	26865	1RB#38	27.48
Band26	15MHz	QPSK	26865	1RB#74	27.34
Band26	15MHz	QPSK	26865	38RB#0	26.96
Band26	15MHz	QPSK	26865	38RB#18	27.05
Band26	15MHz	QPSK	26865	38RB#37	26.97
Band26	15MHz	QPSK	26865	75RB#0	26.82
Band26	15MHz	QPSK	26915	1RB#0	27.73
Band26	15MHz	QPSK	26915	1RB#38	27.52
Band26	15MHz	QPSK	26915	1RB#74	27.72
Band26	15MHz	QPSK	26915	38RB#0	27.07
Band26	15MHz	QPSK	26915	38RB#18	27.14
Band26	15MHz	QPSK	26915	38RB#37	27.02
Band26	15MHz	QPSK	26915	75RB#0	26.8
Band26	15MHz	QPSK	26965	1RB#0	27.7
Band26	15MHz	QPSK	26965	1RB#38	27.66
Band26	15MHz	QPSK	26965	1RB#74	27.59
Band26	15MHz	QPSK	26965	38RB#0	27.3
Band26	15MHz	QPSK	26965	38RB#18	27.25
Band26	15MHz	QPSK	26965	38RB#37	27.41
Band26	15MHz	QPSK	26965	75RB#0	27
Band26	15MHz	16QAM	26865	1RB#0	26.98
Band26	15MHz	16QAM	26865	1RB#38	27.1
Band26	15MHz	16QAM	26865	1RB#74	26.96
Band26	15MHz	16QAM	26865	38RB#0	26.96
Band26	15MHz	16QAM	26865	38RB#18	27.04
Band26	15MHz	16QAM	26865	38RB#37	26.97
Band26	15MHz	16QAM	26865	75RB#0	26.23

Band26	15MHz	16QAM	26915	1RB#0	27.08
Band26	15MHz	16QAM	26915	1RB#38	27.14
Band26	15MHz	16QAM	26915	1RB#74	27.03
Band26	15MHz	16QAM	26915	38RB#0	27.07
Band26	15MHz	16QAM	26915	38RB#18	27.12
Band26	15MHz	16QAM	26915	38RB#37	27.01
Band26	15MHz	16QAM	26915	75RB#0	26.28
Band26	15MHz	16QAM	26965	1RB#0	27.32
Band26	15MHz	16QAM	26965	1RB#38	27.27
Band26	15MHz	16QAM	26965	1RB#74	27.4
Band26	15MHz	16QAM	26965	38RB#0	27.31
Band26	15MHz	16QAM	26965	38RB#18	27.25
Band26	15MHz	16QAM	26965	38RB#37	27.4
Band26	15MHz	16QAM	26965	75RB#0	26.41
Band38	5MHz	QPSK	37775	1RB#0	21.87
Band38	5MHz	QPSK	37775	1RB#12	21.87
Band38	5MHz	QPSK	37775	1RB#24	21.98
Band38	5MHz	QPSK	37775	12RB#0	20.98
Band38	5MHz	QPSK	37775	12RB#6	20.95
Band38	5MHz	QPSK	37775	12RB#13	21.07
Band38	5MHz	QPSK	37775	25RB#0	20.95
Band38	5MHz	QPSK	38000	1RB#0	22.52
Band38	5MHz	QPSK	38000	1RB#12	22.22
Band38	5MHz	QPSK	38000	1RB#24	22.33
Band38	5MHz	QPSK	38000	12RB#0	21.52
Band38	5MHz	QPSK	38000	12RB#6	21.52
Band38	5MHz	QPSK	38000	12RB#13	21.41
Band38	5MHz	QPSK	38000	25RB#0	21.44
Band38	5MHz	QPSK	38225	1RB#0	21.73
Band38	5MHz	QPSK	38225	1RB#12	21.7
Band38	5MHz	QPSK	38225	1RB#24	21.74
Band38	5MHz	QPSK	38225	12RB#0	20.72
Band38	5MHz	QPSK	38225	12RB#6	20.72
Band38	5MHz	QPSK	38225	12RB#13	20.73
Band38	5MHz	QPSK	38225	25RB#0	20.79
Band38	5MHz	16QAM	37775	1RB#0	20.99
Band38	5MHz	16QAM	37775	1RB#12	20.99
Band38	5MHz	16QAM	37775	1RB#24	21.1

Band38	5MHz	16QAM	37775	12RB#0	20.07
Band38	5MHz	16QAM	37775	12RB#6	20.04
Band38	5MHz	16QAM	37775	12RB#13	20.17
Band38	5MHz	16QAM	37775	25RB#0	20.07
Band38	5MHz	16QAM	38000	1RB#0	21.59
Band38	5MHz	16QAM	38000	1RB#12	21.34
Band38	5MHz	16QAM	38000	1RB#24	21.44
Band38	5MHz	16QAM	38000	12RB#0	20.63
Band38	5MHz	16QAM	38000	12RB#6	20.62
Band38	5MHz	16QAM	38000	12RB#13	20.5
Band38	5MHz	16QAM	38000	25RB#0	20.56
Band38	5MHz	16QAM	38225	1RB#0	20.77
Band38	5MHz	16QAM	38225	1RB#12	20.8
Band38	5MHz	16QAM	38225	1RB#24	20.75
Band38	5MHz	16QAM	38225	12RB#0	19.81
Band38	5MHz	16QAM	38225	12RB#6	19.8
Band38	5MHz	16QAM	38225	12RB#13	19.88
Band38	5MHz	16QAM	38225	25RB#0	19.91
Band38	10MHz	QPSK	37800	1RB#0	22.02
Band38	10MHz	QPSK	37800	1RB#24	22.08
Band38	10MHz	QPSK	37800	1RB#49	22.26
Band38	10MHz	QPSK	37800	25RB#0	21.2
Band38	10MHz	QPSK	37800	25RB#12	21.16
Band38	10MHz	QPSK	37800	25RB#25	21.35
Band38	10MHz	QPSK	37800	50RB#0	21.2
Band38	10MHz	QPSK	38000	1RB#0	22.56
Band38	10MHz	QPSK	38000	1RB#24	22.3
Band38	10MHz	QPSK	38000	1RB#49	22.39
Band38	10MHz	QPSK	38000	25RB#0	21.63
Band38	10MHz	QPSK	38000	25RB#12	21.62
Band38	10MHz	QPSK	38000	25RB#25	21.57
Band38	10MHz	QPSK	38000	50RB#0	21.56
Band38	10MHz	QPSK	38200	1RB#0	21.86
Band38	10MHz	QPSK	38200	1RB#24	21.61
Band38	10MHz	QPSK	38200	1RB#49	21.89
Band38	10MHz	QPSK	38200	25RB#0	20.67
Band38	10MHz	QPSK	38200	25RB#12	20.66
Band38	10MHz	QPSK	38200	25RB#25	20.92

Band38	10MHz	QPSK	38200	50RB#0	20.74
Band38	10MHz	16QAM	37800	1RB#0	21.27
Band38	10MHz	16QAM	37800	1RB#24	21.34
Band38	10MHz	16QAM	37800	1RB#49	21.56
Band38	10MHz	16QAM	37800	25RB#0	20.28
Band38	10MHz	16QAM	37800	25RB#12	20.24
Band38	10MHz	16QAM	37800	25RB#25	20.41
Band38	10MHz	16QAM	37800	50RB#0	20.31
Band38	10MHz	16QAM	38000	1RB#0	21.79
Band38	10MHz	16QAM	38000	1RB#24	21.59
Band38	10MHz	16QAM	38000	1RB#49	21.68
Band38	10MHz	16QAM	38000	25RB#0	20.72
Band38	10MHz	16QAM	38000	25RB#12	20.71
Band38	10MHz	16QAM	38000	25RB#25	20.66
Band38	10MHz	16QAM	38000	50RB#0	20.66
Band38	10MHz	16QAM	38200	1RB#0	21.07
Band38	10MHz	16QAM	38200	1RB#24	20.87
Band38	10MHz	16QAM	38200	1RB#49	21.07
Band38	10MHz	16QAM	38200	25RB#0	19.76
Band38	10MHz	16QAM	38200	25RB#12	19.74
Band38	10MHz	16QAM	38200	25RB#25	20
Band38	10MHz	16QAM	38200	50RB#0	19.84
Band38	15MHz	QPSK	37825	1RB#0	22.05
Band38	15MHz	QPSK	37825	1RB#38	21.95
Band38	15MHz	QPSK	37825	1RB#74	22.45
Band38	15MHz	QPSK	37825	38RB#0	21.19
Band38	15MHz	QPSK	37825	38RB#18	21.15
Band38	15MHz	QPSK	37825	38RB#37	21.7
Band38	15MHz	QPSK	37825	75RB#0	21.22
Band38	15MHz	QPSK	38000	1RB#0	22.73
Band38	15MHz	QPSK	38000	1RB#38	22.13
Band38	15MHz	QPSK	38000	1RB#74	22.37
Band38	15MHz	QPSK	38000	38RB#0	21.94
Band38	15MHz	QPSK	38000	38RB#18	21.34
Band38	15MHz	QPSK	38000	38RB#37	21.63
Band38	15MHz	QPSK	38000	75RB#0	21.43
Band38	15MHz	QPSK	38175	1RB#0	21.79
Band38	15MHz	QPSK	38175	1RB#38	21.24

Band38	15MHz	QPSK	38175	1RB#74	21.92
Band38	15MHz	QPSK	38175	38RB#0	20.92
Band38	15MHz	QPSK	38175	38RB#18	20.44
Band38	15MHz	QPSK	38175	38RB#37	21.08
Band38	15MHz	QPSK	38175	75RB#0	20.66
Band38	15MHz	16QAM	37825	1RB#0	21.3
Band38	15MHz	16QAM	37825	1RB#38	21.26
Band38	15MHz	16QAM	37825	1RB#74	21.77
Band38	15MHz	16QAM	37825	38RB#0	21.17
Band38	15MHz	16QAM	37825	38RB#18	21.15
Band38	15MHz	16QAM	37825	38RB#37	21.69
Band38	15MHz	16QAM	37825	75RB#0	20.27
Band38	15MHz	16QAM	38000	1RB#0	22.02
Band38	15MHz	16QAM	38000	1RB#38	21.39
Band38	15MHz	16QAM	38000	1RB#74	21.66
Band38	15MHz	16QAM	38000	38RB#0	21.94
Band38	15MHz	16QAM	38000	38RB#18	21.33
Band38	15MHz	16QAM	38000	38RB#37	21.62
Band38	15MHz	16QAM	38000	75RB#0	20.52
Band38	15MHz	16QAM	38175	1RB#0	21
Band38	15MHz	16QAM	38175	1RB#38	20.48
Band38	15MHz	16QAM	38175	1RB#74	21.1
Band38	15MHz	16QAM	38175	38RB#0	20.92
Band38	15MHz	16QAM	38175	38RB#18	20.44
Band38	15MHz	16QAM	38175	38RB#37	21.07
Band38	15MHz	16QAM	38175	75RB#0	19.74
Band38	20MHz	QPSK	37850	1RB#0	22.22
Band38	20MHz	QPSK	37850	1RB#49	22.54
Band38	20MHz	QPSK	37850	1RB#99	22.85
Band38	20MHz	QPSK	37850	50RB#0	21.58
Band38	20MHz	QPSK	37850	50RB#25	21.54
Band38	20MHz	QPSK	37850	50RB#50	21.86
Band38	20MHz	QPSK	37850	100RB#0	21.54
Band38	20MHz	QPSK	38000	1RB#0	22.85
Band38	20MHz	QPSK	38000	1RB#49	22.53
Band38	20MHz	QPSK	38000	1RB#99	22.41
Band38	20MHz	QPSK	38000	50RB#0	21.89
Band38	20MHz	QPSK	38000	50RB#25	21.85

Band38	20MHz	QPSK	38000	50RB#50	21.7
Band38	20MHz	QPSK	38000	100RB#0	21.69
Band38	20MHz	QPSK	38150	1RB#0	21.91
Band38	20MHz	QPSK	38150	1RB#49	21.48
Band38	20MHz	QPSK	38150	1RB#99	21.78
Band38	20MHz	QPSK	38150	50RB#0	20.62
Band38	20MHz	QPSK	38150	50RB#25	20.61
Band38	20MHz	QPSK	38150	50RB#50	20.64
Band38	20MHz	QPSK	38150	100RB#0	20.65
Band38	20MHz	16QAM	37850	1RB#0	21.3
Band38	20MHz	16QAM	37850	1RB#49	21.56
Band38	20MHz	16QAM	37850	1RB#99	21.99
Band38	20MHz	16QAM	37850	50RB#0	20.64
Band38	20MHz	16QAM	37850	50RB#25	20.61
Band38	20MHz	16QAM	37850	50RB#50	20.91
Band38	20MHz	16QAM	37850	100RB#0	20.62
Band38	20MHz	16QAM	38000	1RB#0	21.97
Band38	20MHz	16QAM	38000	1RB#49	21.63
Band38	20MHz	16QAM	38000	1RB#99	21.49
Band38	20MHz	16QAM	38000	50RB#0	20.98
Band38	20MHz	16QAM	38000	50RB#25	20.93
Band38	20MHz	16QAM	38000	50RB#50	20.78
Band38	20MHz	16QAM	38000	100RB#0	20.77
Band38	20MHz	16QAM	38150	1RB#0	20.96
Band38	20MHz	16QAM	38150	1RB#49	20.55
Band38	20MHz	16QAM	38150	1RB#99	20.78
Band38	20MHz	16QAM	38150	50RB#0	19.73
Band38	20MHz	16QAM	38150	50RB#25	19.69
Band38	20MHz	16QAM	38150	50RB#50	19.71
Band38	20MHz	16QAM	38150	100RB#0	19.72
Band39	5MHz	QPSK	38275	1RB#0	24.04
Band39	5MHz	QPSK	38275	1RB#12	23.89
Band39	5MHz	QPSK	38275	1RB#24	23.89
Band39	5MHz	QPSK	38275	12RB#0	22.96
Band39	5MHz	QPSK	38275	12RB#6	22.96
Band39	5MHz	QPSK	38275	12RB#13	22.96
Band39	5MHz	QPSK	38275	25RB#0	22.95
Band39	5MHz	QPSK	38400	1RB#0	23.49

Band39	5MHz	QPSK	38400	1RB#12	23.4
Band39	5MHz	QPSK	38400	1RB#24	23.44
Band39	5MHz	QPSK	38400	12RB#0	22.45
Band39	5MHz	QPSK	38400	12RB#6	22.44
Band39	5MHz	QPSK	38400	12RB#13	22.44
Band39	5MHz	QPSK	38400	25RB#0	22.44
Band39	5MHz	QPSK	38525	1RB#0	23.68
Band39	5MHz	QPSK	38525	1RB#12	23.58
Band39	5MHz	QPSK	38525	1RB#24	23.57
Band39	5MHz	QPSK	38525	12RB#0	22.63
Band39	5MHz	QPSK	38525	12RB#6	22.63
Band39	5MHz	QPSK	38525	12RB#13	22.62
Band39	5MHz	QPSK	38525	25RB#0	22.62
Band39	5MHz	16QAM	38275	1RB#0	23.13
Band39	5MHz	16QAM	38275	1RB#12	22.97
Band39	5MHz	16QAM	38275	1RB#24	22.97
Band39	5MHz	16QAM	38275	12RB#0	22.06
Band39	5MHz	16QAM	38275	12RB#6	22.05
Band39	5MHz	16QAM	38275	12RB#13	22.06
Band39	5MHz	16QAM	38275	25RB#0	22.07
Band39	5MHz	16QAM	38400	1RB#0	22.54
Band39	5MHz	16QAM	38400	1RB#12	22.47
Band39	5MHz	16QAM	38400	1RB#24	22.51
Band39	5MHz	16QAM	38400	12RB#0	21.55
Band39	5MHz	16QAM	38400	12RB#6	21.54
Band39	5MHz	16QAM	38400	12RB#13	21.54
Band39	5MHz	16QAM	38400	25RB#0	21.55
Band39	5MHz	16QAM	38525	1RB#0	22.73
Band39	5MHz	16QAM	38525	1RB#12	22.65
Band39	5MHz	16QAM	38525	1RB#24	22.64
Band39	5MHz	16QAM	38525	12RB#0	21.73
Band39	5MHz	16QAM	38525	12RB#6	21.72
Band39	5MHz	16QAM	38525	12RB#13	21.72
Band39	5MHz	16QAM	38525	25RB#0	21.74
Band39	10MHz	QPSK	38300	1RB#0	24.1
Band39	10MHz	QPSK	38300	1RB#24	23.86
Band39	10MHz	QPSK	38300	1RB#49	23.98
Band39	10MHz	QPSK	38300	25RB#0	23.06

Band39	10MHz	QPSK	38300	25RB#12	23.05
Band39	10MHz	QPSK	38300	25RB#25	22.99
Band39	10MHz	QPSK	38300	50RB#0	22.98
Band39	10MHz	QPSK	38400	1RB#0	23.64
Band39	10MHz	QPSK	38400	1RB#24	23.37
Band39	10MHz	QPSK	38400	1RB#49	23.5
Band39	10MHz	QPSK	38400	25RB#0	22.5
Band39	10MHz	QPSK	38400	25RB#12	22.5
Band39	10MHz	QPSK	38400	25RB#25	22.5
Band39	10MHz	QPSK	38400	50RB#0	22.49
Band39	10MHz	QPSK	38500	1RB#0	23.87
Band39	10MHz	QPSK	38500	1RB#24	23.6
Band39	10MHz	QPSK	38500	1RB#49	23.73
Band39	10MHz	QPSK	38500	25RB#0	22.78
Band39	10MHz	QPSK	38500	25RB#12	22.78
Band39	10MHz	QPSK	38500	25RB#25	22.73
Band39	10MHz	QPSK	38500	50RB#0	22.72
Band39	10MHz	16QAM	38300	1RB#0	23.37
Band39	10MHz	16QAM	38300	1RB#24	23.12
Band39	10MHz	16QAM	38300	1RB#49	23.25
Band39	10MHz	16QAM	38300	25RB#0	22.14
Band39	10MHz	16QAM	38300	25RB#12	22.13
Band39	10MHz	16QAM	38300	25RB#25	22.08
Band39	10MHz	16QAM	38300	50RB#0	22.06
Band39	10MHz	16QAM	38400	1RB#0	22.88
Band39	10MHz	16QAM	38400	1RB#24	22.63
Band39	10MHz	16QAM	38400	1RB#49	22.76
Band39	10MHz	16QAM	38400	25RB#0	21.59
Band39	10MHz	16QAM	38400	25RB#12	21.58
Band39	10MHz	16QAM	38400	25RB#25	21.59
Band39	10MHz	16QAM	38400	50RB#0	21.57
Band39	10MHz	16QAM	38500	1RB#0	23.12
Band39	10MHz	16QAM	38500	1RB#24	22.86
Band39	10MHz	16QAM	38500	1RB#49	22.99
Band39	10MHz	16QAM	38500	25RB#0	21.87
Band39	10MHz	16QAM	38500	25RB#12	21.86
Band39	10MHz	16QAM	38500	25RB#25	21.82
Band39	10MHz	16QAM	38500	50RB#0	21.81

Band39	15MHz	QPSK	38325	1RB#0	24.22
Band39	15MHz	QPSK	38325	1RB#38	23.74
Band39	15MHz	QPSK	38325	1RB#74	24.03
Band39	15MHz	QPSK	38325	38RB#0	23.47
Band39	15MHz	QPSK	38325	38RB#18	22.98
Band39	15MHz	QPSK	38325	38RB#37	23.29
Band39	15MHz	QPSK	38325	75RB#0	22.93
Band39	15MHz	QPSK	38400	1RB#0	23.79
Band39	15MHz	QPSK	38400	1RB#38	23.31
Band39	15MHz	QPSK	38400	1RB#74	23.62
Band39	15MHz	QPSK	38400	38RB#0	23.01
Band39	15MHz	QPSK	38400	38RB#18	22.55
Band39	15MHz	QPSK	38400	38RB#37	22.88
Band39	15MHz	QPSK	38400	75RB#0	22.5
Band39	15MHz	QPSK	38475	1RB#0	24.07
Band39	15MHz	QPSK	38475	1RB#38	23.61
Band39	15MHz	QPSK	38475	1RB#74	23.87
Band39	15MHz	QPSK	38475	38RB#0	23.3
Band39	15MHz	QPSK	38475	38RB#18	22.85
Band39	15MHz	QPSK	38475	38RB#37	23.13
Band39	15MHz	QPSK	38475	75RB#0	22.8
Band39	15MHz	16QAM	38325	1RB#0	23.5
Band39	15MHz	16QAM	38325	1RB#38	23.01
Band39	15MHz	16QAM	38325	1RB#74	23.31
Band39	15MHz	16QAM	38325	38RB#0	23.47
Band39	15MHz	16QAM	38325	38RB#18	22.98
Band39	15MHz	16QAM	38325	38RB#37	23.29
Band39	15MHz	16QAM	38325	75RB#0	21.99
Band39	15MHz	16QAM	38400	1RB#0	23.04
Band39	15MHz	16QAM	38400	1RB#38	22.57
Band39	15MHz	16QAM	38400	1RB#74	22.89
Band39	15MHz	16QAM	38400	38RB#0	23.01
Band39	15MHz	16QAM	38400	38RB#18	22.55
Band39	15MHz	16QAM	38400	38RB#37	22.88
Band39	15MHz	16QAM	38400	75RB#0	21.57
Band39	15MHz	16QAM	38475	1RB#0	23.32
Band39	15MHz	16QAM	38475	1RB#38	22.87
Band39	15MHz	16QAM	38475	1RB#74	23.14

Band39	15MHz	16QAM	38475	38RB#0	23.3
Band39	15MHz	16QAM	38475	38RB#18	22.85
Band39	15MHz	16QAM	38475	38RB#37	23.13
Band39	15MHz	16QAM	38475	75RB#0	21.87
Band39	20MHz	QPSK	38350	1RB#0	24.06
Band39	20MHz	QPSK	38350	1RB#49	23.74
Band39	20MHz	QPSK	38350	1RB#99	23.81
Band39	20MHz	QPSK	38350	50RB#0	23.03
Band39	20MHz	QPSK	38350	50RB#25	23.02
Band39	20MHz	QPSK	38350	50RB#50	22.89
Band39	20MHz	QPSK	38350	100RB#0	22.97
Band39	20MHz	QPSK	38400	1RB#0	23.66
Band39	20MHz	QPSK	38400	1RB#49	23.31
Band39	20MHz	QPSK	38400	1RB#99	23.4
Band39	20MHz	QPSK	38400	50RB#0	22.62
Band39	20MHz	QPSK	38400	50RB#25	22.61
Band39	20MHz	QPSK	38400	50RB#50	22.48
Band39	20MHz	QPSK	38400	100RB#0	22.57
Band39	20MHz	QPSK	38450	1RB#0	23.68
Band39	20MHz	QPSK	38450	1RB#49	23.36
Band39	20MHz	QPSK	38450	1RB#99	23.42
Band39	20MHz	QPSK	38450	50RB#0	22.63
Band39	20MHz	QPSK	38450	50RB#25	22.62
Band39	20MHz	QPSK	38450	50RB#50	22.49
Band39	20MHz	QPSK	38450	100RB#0	22.56
Band39	20MHz	16QAM	38350	1RB#0	23.18
Band39	20MHz	16QAM	38350	1RB#49	22.84
Band39	20MHz	16QAM	38350	1RB#99	22.92
Band39	20MHz	16QAM	38350	50RB#0	22.13
Band39	20MHz	16QAM	38350	50RB#25	22.12
Band39	20MHz	16QAM	38350	50RB#50	21.99
Band39	20MHz	16QAM	38350	100RB#0	22.07
Band39	20MHz	16QAM	38400	1RB#0	22.77
Band39	20MHz	16QAM	38400	1RB#49	22.41
Band39	20MHz	16QAM	38400	1RB#99	22.52
Band39	20MHz	16QAM	38400	50RB#0	21.72
Band39	20MHz	16QAM	38400	50RB#25	21.71
Band39	20MHz	16QAM	38400	50RB#50	21.58

Band39	20MHz	16QAM	38400	100RB#0	21.67
Band39	20MHz	16QAM	38450	1RB#0	22.79
Band39	20MHz	16QAM	38450	1RB#49	22.45
Band39	20MHz	16QAM	38450	1RB#99	22.53
Band39	20MHz	16QAM	38450	50RB#0	21.73
Band39	20MHz	16QAM	38450	50RB#25	21.71
Band39	20MHz	16QAM	38450	50RB#50	21.58
Band39	20MHz	16QAM	38450	100RB#0	21.65
Band41	5MHz	QPSK	40265	1RB#0	24.68
Band41	5MHz	QPSK	40265	1RB#12	24.44
Band41	5MHz	QPSK	40265	1RB#24	24.22
Band41	5MHz	QPSK	40265	12RB#0	23.54
Band41	5MHz	QPSK	40265	12RB#6	23.52
Band41	5MHz	QPSK	40265	12RB#13	23.39
Band41	5MHz	QPSK	40265	25RB#0	23.43
Band41	5MHz	QPSK	40740	1RB#0	23.75
Band41	5MHz	QPSK	40740	1RB#12	23.5
Band41	5MHz	QPSK	40740	1RB#24	23.41
Band41	5MHz	QPSK	40740	12RB#0	22.47
Band41	5MHz	QPSK	40740	12RB#6	22.48
Band41	5MHz	QPSK	40740	12RB#13	22.45
Band41	5MHz	QPSK	40740	25RB#0	22.48
Band41	5MHz	QPSK	41265	1RB#0	23.45
Band41	5MHz	QPSK	41265	1RB#12	23.13
Band41	5MHz	QPSK	41265	1RB#24	23.2
Band41	5MHz	QPSK	41265	12RB#0	21.85
Band41	5MHz	QPSK	41265	12RB#6	21.86
Band41	5MHz	QPSK	41265	12RB#13	21.81
Band41	5MHz	QPSK	41265	25RB#0	21.83
Band41	5MHz	16QAM	40265	1RB#0	23.77
Band41	5MHz	16QAM	40265	1RB#12	23.56
Band41	5MHz	16QAM	40265	1RB#24	23.32
Band41	5MHz	16QAM	40265	12RB#0	22.64
Band41	5MHz	16QAM	40265	12RB#6	22.62
Band41	5MHz	16QAM	40265	12RB#13	22.49
Band41	5MHz	16QAM	40265	25RB#0	22.56
Band41	5MHz	16QAM	40740	1RB#0	22.73
Band41	5MHz	16QAM	40740	1RB#12	22.56

Band41	5MHz	16QAM	40740	1RB#24	22.47
Band41	5MHz	16QAM	40740	12RB#0	21.64
Band41	5MHz	16QAM	40740	12RB#6	21.63
Band41	5MHz	16QAM	40740	12RB#13	21.61
Band41	5MHz	16QAM	40740	25RB#0	21.67
Band41	5MHz	16QAM	41265	1RB#0	22.09
Band41	5MHz	16QAM	41265	1RB#12	21.87
Band41	5MHz	16QAM	41265	1RB#24	21.92
Band41	5MHz	16QAM	41265	12RB#0	20.93
Band41	5MHz	16QAM	41265	12RB#6	20.93
Band41	5MHz	16QAM	41265	12RB#13	20.87
Band41	5MHz	16QAM	41265	25RB#0	20.92
Band41	10MHz	QPSK	40290	1RB#0	24.34
Band41	10MHz	QPSK	40290	1RB#24	23.87
Band41	10MHz	QPSK	40290	1RB#49	23.78
Band41	10MHz	QPSK	40290	25RB#0	23.13
Band41	10MHz	QPSK	40290	25RB#12	23.13
Band41	10MHz	QPSK	40290	25RB#25	22.92
Band41	10MHz	QPSK	40290	50RB#0	22.98
Band41	10MHz	QPSK	40740	1RB#0	23.47
Band41	10MHz	QPSK	40740	1RB#24	23.14
Band41	10MHz	QPSK	40740	1RB#49	23.11
Band41	10MHz	QPSK	40740	25RB#0	22.22
Band41	10MHz	QPSK	40740	25RB#12	22.25
Band41	10MHz	QPSK	40740	25RB#25	22.17
Band41	10MHz	QPSK	40740	50RB#0	22.25
Band41	10MHz	QPSK	41290	1RB#0	23.15
Band41	10MHz	QPSK	41290	1RB#24	22.97
Band41	10MHz	QPSK	41290	1RB#49	23.44
Band41	10MHz	QPSK	41290	25RB#0	21.62
Band41	10MHz	QPSK	41290	25RB#12	21.61
Band41	10MHz	QPSK	41290	25RB#25	21.98
Band41	10MHz	QPSK	41290	50RB#0	21.79
Band41	10MHz	16QAM	40290	1RB#0	23.42
Band41	10MHz	16QAM	40290	1RB#24	23.07
Band41	10MHz	16QAM	40290	1RB#49	22.98
Band41	10MHz	16QAM	40290	25RB#0	22.27
Band41	10MHz	16QAM	40290	25RB#12	22.26

Band41	10MHz	16QAM	40290	25RB#25	22.06
Band41	10MHz	16QAM	40290	50RB#0	22.11
Band41	10MHz	16QAM	40740	1RB#0	22.67
Band41	10MHz	16QAM	40740	1RB#24	22.39
Band41	10MHz	16QAM	40740	1RB#49	22.37
Band41	10MHz	16QAM	40740	25RB#0	21.39
Band41	10MHz	16QAM	40740	25RB#12	21.4
Band41	10MHz	16QAM	40740	25RB#25	21.32
Band41	10MHz	16QAM	40740	50RB#0	21.41
Band41	10MHz	16QAM	41290	1RB#0	21.94
Band41	10MHz	16QAM	41290	1RB#24	21.88
Band41	10MHz	16QAM	41290	1RB#49	22.38
Band41	10MHz	16QAM	41290	25RB#0	20.66
Band41	10MHz	16QAM	41290	25RB#12	20.66
Band41	10MHz	16QAM	41290	25RB#25	21.01
Band41	10MHz	16QAM	41290	50RB#0	20.84
Band41	15MHz	QPSK	40315	1RB#0	23.79
Band41	15MHz	QPSK	40315	1RB#38	23.21
Band41	15MHz	QPSK	40315	1RB#74	23.35
Band41	15MHz	QPSK	40315	38RB#0	22.94
Band41	15MHz	QPSK	40315	38RB#18	22.5
Band41	15MHz	QPSK	40315	38RB#37	22.59
Band41	15MHz	QPSK	40315	75RB#0	22.36
Band41	15MHz	QPSK	40740	1RB#0	23.54
Band41	15MHz	QPSK	40740	1RB#38	23.02
Band41	15MHz	QPSK	40740	1RB#74	23.03
Band41	15MHz	QPSK	40740	38RB#0	22.66
Band41	15MHz	QPSK	40740	38RB#18	22.26
Band41	15MHz	QPSK	40740	38RB#37	22.3
Band41	15MHz	QPSK	40740	75RB#0	22.19
Band41	15MHz	QPSK	41315	1RB#0	23.43
Band41	15MHz	QPSK	41315	1RB#38	23.55
Band41	15MHz	QPSK	41315	1RB#74	22.13
Band41	15MHz	QPSK	41315	38RB#0	22.2
Band41	15MHz	QPSK	41315	38RB#18	22.44
Band41	15MHz	QPSK	41315	38RB#37	21.31
Band41	15MHz	QPSK	41315	75RB#0	22.1
Band41	15MHz	16QAM	40315	1RB#0	22.97

Band41	15MHz	16QAM	40315	1RB#38	22.51
Band41	15MHz	16QAM	40315	1RB#74	22.61
Band41	15MHz	16QAM	40315	38RB#0	22.92
Band41	15MHz	16QAM	40315	38RB#18	22.5
Band41	15MHz	16QAM	40315	38RB#37	22.6
Band41	15MHz	16QAM	40315	75RB#0	21.48
Band41	15MHz	16QAM	40740	1RB#0	22.72
Band41	15MHz	16QAM	40740	1RB#38	22.26
Band41	15MHz	16QAM	40740	1RB#74	22.29
Band41	15MHz	16QAM	40740	38RB#0	22.68
Band41	15MHz	16QAM	40740	38RB#18	22.25
Band41	15MHz	16QAM	40740	38RB#37	22.3
Band41	15MHz	16QAM	40740	75RB#0	21.32
Band41	15MHz	16QAM	41315	1RB#0	22.2
Band41	15MHz	16QAM	41315	1RB#38	22.46
Band41	15MHz	16QAM	41315	1RB#74	21.29
Band41	15MHz	16QAM	41315	38RB#0	22.18
Band41	15MHz	16QAM	41315	38RB#18	22.45
Band41	15MHz	16QAM	41315	38RB#37	21.32
Band41	15MHz	16QAM	41315	75RB#0	21.12
Band41	20MHz	QPSK	40340	1RB#0	23.52
Band41	20MHz	QPSK	40340	1RB#49	23.24
Band41	20MHz	QPSK	40340	1RB#99	23.27
Band41	20MHz	QPSK	40340	50RB#0	22.41
Band41	20MHz	QPSK	40340	50RB#25	22.39
Band41	20MHz	QPSK	40340	50RB#50	22.33
Band41	20MHz	QPSK	40340	100RB#0	22.36
Band41	20MHz	QPSK	40740	1RB#0	23.25
Band41	20MHz	QPSK	40740	1RB#49	23.03
Band41	20MHz	QPSK	40740	1RB#99	22.67
Band41	20MHz	QPSK	40740	50RB#0	22.25
Band41	20MHz	QPSK	40740	50RB#25	22.27
Band41	20MHz	QPSK	40740	50RB#50	22.01
Band41	20MHz	QPSK	40740	100RB#0	22.24
Band41	20MHz	QPSK	41140	1RB#0	23.81
Band41	20MHz	QPSK	41140	1RB#49	23.2
Band41	20MHz	QPSK	41140	1RB#99	22.86
Band41	20MHz	QPSK	41140	50RB#0	22.7

Band41	20MHz	QPSK	41140	50RB#25	22.78
Band41	20MHz	QPSK	41140	50RB#50	21.93
Band41	20MHz	QPSK	41140	100RB#0	22.38
Band41	20MHz	16QAM	40340	1RB#0	22.75
Band41	20MHz	16QAM	40340	1RB#49	22.54
Band41	20MHz	16QAM	40340	1RB#99	22.54
Band41	20MHz	16QAM	40340	50RB#0	21.53
Band41	20MHz	16QAM	40340	50RB#25	21.52
Band41	20MHz	16QAM	40340	50RB#50	21.43
Band41	20MHz	16QAM	40340	100RB#0	21.47
Band41	20MHz	16QAM	40740	1RB#0	22.32
Band41	20MHz	16QAM	40740	1RB#49	22.14
Band41	20MHz	16QAM	40740	1RB#99	21.76
Band41	20MHz	16QAM	40740	50RB#0	21.38
Band41	20MHz	16QAM	40740	50RB#25	21.39
Band41	20MHz	16QAM	40740	50RB#50	21.17
Band41	20MHz	16QAM	40740	100RB#0	21.4
Band41	20MHz	16QAM	41140	1RB#0	22.89
Band41	20MHz	16QAM	41140	1RB#49	22.3
Band41	20MHz	16QAM	41140	1RB#99	21.54
Band41	20MHz	16QAM	41140	50RB#0	21.84
Band41	20MHz	16QAM	41140	50RB#25	21.87
Band41	20MHz	16QAM	41140	50RB#50	21.02
Band41	20MHz	16QAM	41140	100RB#0	21.51

Peak-to-Average Ratio(CCDF)
Test Result

Band	Bandwidth	Modulation	Channel	RB Configuration	Result(dB)	Limit(dB)	Verdict
Band2	1.4MHz	QPSK	18607	1RB#0	4.70	13	PASS
Band2	1.4MHz	QPSK	18607	6RB#0	5.30	13	PASS
Band2	1.4MHz	QPSK	18900	1RB#0	4.99	13	PASS
Band2	1.4MHz	QPSK	18900	6RB#0	5.51	13	PASS
Band2	1.4MHz	QPSK	19193	1RB#0	4.32	13	PASS
Band2	1.4MHz	QPSK	19193	6RB#0	4.90	13	PASS
Band2	1.4MHz	16QAM	18607	1RB#0	4.90	13	PASS
Band2	1.4MHz	16QAM	18607	6RB#0	5.91	13	PASS
Band2	1.4MHz	16QAM	18900	1RB#0	5.07	13	PASS
Band2	1.4MHz	16QAM	18900	6RB#0	6.09	13	PASS
Band2	1.4MHz	16QAM	19193	1RB#0	4.41	13	PASS
Band2	1.4MHz	16QAM	19193	6RB#0	5.54	13	PASS
Band2	3MHz	QPSK	18615	1RB#0	4.52	13	PASS
Band2	3MHz	QPSK	18615	15RB#0	5.28	13	PASS
Band2	3MHz	QPSK	18900	1RB#0	4.93	13	PASS
Band2	3MHz	QPSK	18900	15RB#0	5.39	13	PASS
Band2	3MHz	QPSK	19185	1RB#0	4.38	13	PASS
Band2	3MHz	QPSK	19185	15RB#0	4.96	13	PASS
Band2	3MHz	16QAM	18615	1RB#0	5.01	13	PASS
Band2	3MHz	16QAM	18615	15RB#0	6.12	13	PASS
Band2	3MHz	16QAM	18900	1RB#0	5.62	13	PASS
Band2	3MHz	16QAM	18900	15RB#0	6.26	13	PASS
Band2	3MHz	16QAM	19185	1RB#0	5.01	13	PASS
Band2	3MHz	16QAM	19185	15RB#0	5.83	13	PASS
Band2	5MHz	QPSK	18625	1RB#0	4.23	13	PASS
Band2	5MHz	QPSK	18625	25RB#0	5.39	13	PASS
Band2	5MHz	QPSK	18900	1RB#0	5.13	13	PASS
Band2	5MHz	QPSK	18900	25RB#0	5.59	13	PASS
Band2	5MHz	QPSK	19175	1RB#0	4.58	13	PASS
Band2	5MHz	QPSK	19175	25RB#0	5.10	13	PASS
Band2	5MHz	16QAM	18625	1RB#0	5.07	13	PASS
Band2	5MHz	16QAM	18625	25RB#0	6.14	13	PASS
Band2	5MHz	16QAM	18900	1RB#0	5.45	13	PASS

Band2	5MHz	16QAM	18900	25RB#0	6.29	13	PASS
Band2	5MHz	16QAM	19175	1RB#0	4.87	13	PASS
Band2	5MHz	16QAM	19175	25RB#0	5.83	13	PASS
Band2	10MHz	QPSK	18650	1RB#0	4.55	13	PASS
Band2	10MHz	QPSK	18650	50RB#0	5.22	13	PASS
Band2	10MHz	QPSK	18900	1RB#0	4.93	13	PASS
Band2	10MHz	QPSK	18900	50RB#0	5.33	13	PASS
Band2	10MHz	QPSK	19150	1RB#0	4.64	13	PASS
Band2	10MHz	QPSK	19150	50RB#0	5.04	13	PASS
Band2	10MHz	16QAM	18650	1RB#0	4.90	13	PASS
Band2	10MHz	16QAM	18650	50RB#0	6.12	13	PASS
Band2	10MHz	16QAM	18900	1RB#0	5.45	13	PASS
Band2	10MHz	16QAM	18900	50RB#0	6.23	13	PASS
Band2	10MHz	16QAM	19150	1RB#0	5.28	13	PASS
Band2	10MHz	16QAM	19150	50RB#0	5.97	13	PASS
Band2	15MHz	QPSK	18675	1RB#0	4.75	13	PASS
Band2	15MHz	QPSK	18675	75RB#0	4.99	13	PASS
Band2	15MHz	QPSK	18900	1RB#0	4.93	13	PASS
Band2	15MHz	QPSK	18900	75RB#0	5.13	13	PASS
Band2	15MHz	QPSK	19125	1RB#0	4.64	13	PASS
Band2	15MHz	QPSK	19125	75RB#0	4.87	13	PASS
Band2	15MHz	16QAM	18675	1RB#0	4.93	13	PASS
Band2	15MHz	16QAM	18675	75RB#0	6.00	13	PASS
Band2	15MHz	16QAM	18900	1RB#0	5.59	13	PASS
Band2	15MHz	16QAM	18900	75RB#0	6.09	13	PASS
Band2	15MHz	16QAM	19125	1RB#0	5.22	13	PASS
Band2	15MHz	16QAM	19125	75RB#0	5.94	13	PASS
Band2	20MHz	QPSK	18700	1RB#0	4.46	13	PASS
Band2	20MHz	QPSK	18700	100RB#0	4.20	13	PASS
Band2	20MHz	QPSK	18900	1RB#0	4.64	13	PASS
Band2	20MHz	QPSK	18900	100RB#0	4.26	13	PASS
Band2	20MHz	QPSK	19100	1RB#0	4.49	13	PASS
Band2	20MHz	QPSK	19100	100RB#0	4.17	13	PASS
Band2	20MHz	16QAM	18700	1RB#0	5.39	13	PASS
Band2	20MHz	16QAM	18700	100RB#0	5.86	13	PASS
Band2	20MHz	16QAM	18900	1RB#0	5.33	13	PASS
Band2	20MHz	16QAM	18900	100RB#0	5.94	13	PASS
Band2	20MHz	16QAM	19100	1RB#0	5.07	13	PASS

Band2	20MHz	16QAM	19100	100RB#0	5.86	13	PASS
Band5	1.4MHz	QPSK	20407	1RB#0	8.49	13	PASS
Band5	1.4MHz	QPSK	20407	6RB#0	8.49	13	PASS
Band5	1.4MHz	QPSK	20525	1RB#0	8.49	13	PASS
Band5	1.4MHz	QPSK	20525	6RB#0	8.49	13	PASS
Band5	1.4MHz	QPSK	20643	1RB#0	8.49	13	PASS
Band5	1.4MHz	QPSK	20643	6RB#0	8.49	13	PASS
Band5	1.4MHz	16QAM	20407	1RB#0	8.49	13	PASS
Band5	1.4MHz	16QAM	20407	6RB#0	8.49	13	PASS
Band5	1.4MHz	16QAM	20525	1RB#0	8.49	13	PASS
Band5	1.4MHz	16QAM	20525	6RB#0	8.49	13	PASS
Band5	1.4MHz	16QAM	20643	1RB#0	8.49	13	PASS
Band5	1.4MHz	16QAM	20643	6RB#0	8.49	13	PASS
Band5	3MHz	QPSK	20415	1RB#0	4.29	13	PASS
Band5	3MHz	QPSK	20415	15RB#0	4.29	13	PASS
Band5	3MHz	QPSK	20525	1RB#0	4.29	13	PASS
Band5	3MHz	QPSK	20525	15RB#0	4.29	13	PASS
Band5	3MHz	QPSK	20635	1RB#0	4.29	13	PASS
Band5	3MHz	QPSK	20635	15RB#0	4.29	13	PASS
Band5	3MHz	16QAM	20415	1RB#0	4.29	13	PASS
Band5	3MHz	16QAM	20415	15RB#0	4.29	13	PASS
Band5	3MHz	16QAM	20525	1RB#0	4.29	13	PASS
Band5	3MHz	16QAM	20525	15RB#0	4.29	13	PASS
Band5	3MHz	16QAM	20635	1RB#0	4.29	13	PASS
Band5	3MHz	16QAM	20635	15RB#0	4.29	13	PASS
Band5	5MHz	QPSK	20425	1RB#0	4.35	13	PASS
Band5	5MHz	QPSK	20425	25RB#0	4.35	13	PASS
Band5	5MHz	QPSK	20525	1RB#0	4.35	13	PASS
Band5	5MHz	QPSK	20525	25RB#0	4.35	13	PASS
Band5	5MHz	QPSK	20625	1RB#0	4.35	13	PASS
Band5	5MHz	QPSK	20625	25RB#0	4.35	13	PASS
Band5	5MHz	16QAM	20425	1RB#0	4.35	13	PASS
Band5	5MHz	16QAM	20425	25RB#0	4.35	13	PASS
Band5	5MHz	16QAM	20525	1RB#0	4.35	13	PASS
Band5	5MHz	16QAM	20525	25RB#0	4.35	13	PASS
Band5	5MHz	16QAM	20625	1RB#0	4.35	13	PASS
Band5	5MHz	16QAM	20625	25RB#0	4.35	13	PASS
Band5	10MHz	QPSK	20450	1RB#0	4.29	13	PASS

Band5	10MHz	QPSK	20450	50RB#0	4.29	13	PASS
Band5	10MHz	QPSK	20525	1RB#0	4.29	13	PASS
Band5	10MHz	QPSK	20525	50RB#0	4.29	13	PASS
Band5	10MHz	QPSK	20600	1RB#0	4.29	13	PASS
Band5	10MHz	QPSK	20600	50RB#0	4.29	13	PASS
Band5	10MHz	16QAM	20450	1RB#0	4.29	13	PASS
Band5	10MHz	16QAM	20450	50RB#0	4.29	13	PASS
Band5	10MHz	16QAM	20525	1RB#0	4.29	13	PASS
Band5	10MHz	16QAM	20525	50RB#0	4.29	13	PASS
Band5	10MHz	16QAM	20600	1RB#0	4.29	13	PASS
Band5	10MHz	16QAM	20600	50RB#0	4.29	13	PASS
Band7	5MHz	QPSK	20775	1RB#0	2.93	13	PASS
Band7	5MHz	QPSK	20775	25RB#0	3.77	13	PASS
Band7	5MHz	QPSK	21100	1RB#0	3.36	13	PASS
Band7	5MHz	QPSK	21100	25RB#0	4.23	13	PASS
Band7	5MHz	QPSK	21425	1RB#0	2.99	13	PASS
Band7	5MHz	QPSK	21425	25RB#0	3.59	13	PASS
Band7	5MHz	16QAM	20775	1RB#0	3.62	13	PASS
Band7	5MHz	16QAM	20775	25RB#0	4.58	13	PASS
Band7	5MHz	16QAM	21100	1RB#0	4.06	13	PASS
Band7	5MHz	16QAM	21100	25RB#0	4.93	13	PASS
Band7	5MHz	16QAM	21425	1RB#0	3.57	13	PASS
Band7	5MHz	16QAM	21425	25RB#0	4.43	13	PASS
Band7	10MHz	QPSK	20800	1RB#0	2.96	13	PASS
Band7	10MHz	QPSK	20800	50RB#0	3.88	13	PASS
Band7	10MHz	QPSK	21100	1RB#0	3.45	13	PASS
Band7	10MHz	QPSK	21100	50RB#0	4.23	13	PASS
Band7	10MHz	QPSK	21400	1RB#0	3.33	13	PASS
Band7	10MHz	QPSK	21400	50RB#0	3.94	13	PASS
Band7	10MHz	16QAM	20800	1RB#0	3.57	13	PASS
Band7	10MHz	16QAM	20800	50RB#0	4.78	13	PASS
Band7	10MHz	16QAM	21100	1RB#0	4.14	13	PASS
Band7	10MHz	16QAM	21100	50RB#0	5.10	13	PASS
Band7	10MHz	16QAM	21400	1RB#0	3.68	13	PASS
Band7	10MHz	16QAM	21400	50RB#0	4.72	13	PASS
Band7	15MHz	QPSK	20825	1RB#0	3.45	13	PASS
Band7	15MHz	QPSK	20825	75RB#0	3.94	13	PASS
Band7	15MHz	QPSK	21100	1RB#0	3.62	13	PASS

Band7	15MHz	QPSK	21100	75RB#0	4.20	13	PASS
Band7	15MHz	QPSK	21375	1RB#0	6.20	13	PASS
Band7	15MHz	QPSK	21375	75RB#0	5.59	13	PASS
Band7	15MHz	16QAM	20825	1RB#0	3.71	13	PASS
Band7	15MHz	16QAM	20825	75RB#0	5.10	13	PASS
Band7	15MHz	16QAM	21100	1RB#0	4.20	13	PASS
Band7	15MHz	16QAM	21100	75RB#0	5.25	13	PASS
Band7	15MHz	16QAM	21375	1RB#0	8.03	13	PASS
Band7	15MHz	16QAM	21375	75RB#0	6.78	13	PASS
Band7	20MHz	QPSK	20850	1RB#0	3.33	13	PASS
Band7	20MHz	QPSK	20850	100RB#0	3.65	13	PASS
Band7	20MHz	QPSK	21100	1RB#0	3.65	13	PASS
Band7	20MHz	QPSK	21100	100RB#0	3.83	13	PASS
Band7	20MHz	QPSK	21350	1RB#0	3.36	13	PASS
Band7	20MHz	QPSK	21350	100RB#0	3.83	13	PASS
Band7	20MHz	16QAM	20850	1RB#0	4.00	13	PASS
Band7	20MHz	16QAM	20850	100RB#0	5.30	13	PASS
Band7	20MHz	16QAM	21100	1RB#0	4.14	13	PASS
Band7	20MHz	16QAM	21100	100RB#0	5.39	13	PASS
Band7	20MHz	16QAM	21350	1RB#0	4.12	13	PASS
Band7	20MHz	16QAM	21350	100RB#0	5.33	13	PASS
Band12	1.4MHz	QPSK	23017	1RB#0	5.77	13	PASS
Band12	1.4MHz	QPSK	23017	6RB#0	5.77	13	PASS
Band12	1.4MHz	QPSK	23095	1RB#0	6.32	13	PASS
Band12	1.4MHz	QPSK	23095	6RB#0	6.26	13	PASS
Band12	1.4MHz	QPSK	23173	1RB#0	5.88	13	PASS
Band12	1.4MHz	QPSK	23173	6RB#0	6.20	13	PASS
Band12	1.4MHz	16QAM	23017	1RB#0	5.94	13	PASS
Band12	1.4MHz	16QAM	23017	6RB#0	6.32	13	PASS
Band12	1.4MHz	16QAM	23095	1RB#0	6.75	13	PASS
Band12	1.4MHz	16QAM	23095	6RB#0	6.78	13	PASS
Band12	1.4MHz	16QAM	23173	1RB#0	6.14	13	PASS
Band12	1.4MHz	16QAM	23173	6RB#0	6.72	13	PASS
Band12	3MHz	QPSK	23025	1RB#0	5.19	13	PASS
Band12	3MHz	QPSK	23025	15RB#0	5.62	13	PASS
Band12	3MHz	QPSK	23095	1RB#0	6.09	13	PASS
Band12	3MHz	QPSK	23095	15RB#0	5.77	13	PASS
Band12	3MHz	QPSK	23165	1RB#0	5.91	13	PASS

Band12	3MHz	QPSK	23165	15RB#0	5.88	13	PASS
Band12	3MHz	16QAM	23025	1RB#0	5.71	13	PASS
Band12	3MHz	16QAM	23025	15RB#0	6.38	13	PASS
Band12	3MHz	16QAM	23095	1RB#0	6.75	13	PASS
Band12	3MHz	16QAM	23095	15RB#0	6.70	13	PASS
Band12	3MHz	16QAM	23165	1RB#0	6.55	13	PASS
Band12	3MHz	16QAM	23165	15RB#0	6.72	13	PASS
Band12	5MHz	QPSK	23035	1RB#0	5.48	13	PASS
Band12	5MHz	QPSK	23035	25RB#0	6.06	13	PASS
Band12	5MHz	QPSK	23095	1RB#0	5.94	13	PASS
Band12	5MHz	QPSK	23095	25RB#0	6.23	13	PASS
Band12	5MHz	QPSK	23155	1RB#0	6.00	13	PASS
Band12	5MHz	QPSK	23155	25RB#0	6.14	13	PASS
Band12	5MHz	16QAM	23035	1RB#0	5.86	13	PASS
Band12	5MHz	16QAM	23035	25RB#0	6.70	13	PASS
Band12	5MHz	16QAM	23095	1RB#0	6.43	13	PASS
Band12	5MHz	16QAM	23095	25RB#0	6.78	13	PASS
Band12	5MHz	16QAM	23155	1RB#0	6.26	13	PASS
Band12	5MHz	16QAM	23155	25RB#0	6.70	13	PASS
Band12	10MHz	QPSK	23060	1RB#0	5.07	13	PASS
Band12	10MHz	QPSK	23060	50RB#0	5.86	13	PASS
Band12	10MHz	QPSK	23095	1RB#0	5.97	13	PASS
Band12	10MHz	QPSK	23095	50RB#0	5.74	13	PASS
Band12	10MHz	QPSK	23130	1RB#0	6.09	13	PASS
Band12	10MHz	QPSK	23130	50RB#0	5.57	13	PASS
Band12	10MHz	16QAM	23060	1RB#0	5.74	13	PASS
Band12	10MHz	16QAM	23060	50RB#0	6.67	13	PASS
Band12	10MHz	16QAM	23095	1RB#0	6.41	13	PASS
Band12	10MHz	16QAM	23095	50RB#0	6.55	13	PASS
Band12	10MHz	16QAM	23130	1RB#0	6.93	13	PASS
Band12	10MHz	16QAM	23130	50RB#0	6.38	13	PASS
Band17	5MHz	QPSK	23755	1RB#0	6.35	13	PASS
Band17	5MHz	QPSK	23755	25RB#0	6.70	13	PASS
Band17	5MHz	QPSK	23790	1RB#0	6.14	13	PASS
Band17	5MHz	QPSK	23790	25RB#0	6.41	13	PASS
Band17	5MHz	QPSK	23825	1RB#0	6.17	13	PASS
Band17	5MHz	QPSK	23825	25RB#0	6.49	13	PASS
Band17	5MHz	16QAM	23755	1RB#0	6.58	13	PASS

Band17	5MHz	16QAM	23755	25RB#0	7.28	13	PASS
Band17	5MHz	16QAM	23790	1RB#0	6.52	13	PASS
Band17	5MHz	16QAM	23790	25RB#0	7.13	13	PASS
Band17	5MHz	16QAM	23825	1RB#0	6.35	13	PASS
Band17	5MHz	16QAM	23825	25RB#0	7.07	13	PASS
Band17	10MHz	QPSK	23780	1RB#0	6.03	13	PASS
Band17	10MHz	QPSK	23780	50RB#0	6.06	13	PASS
Band17	10MHz	QPSK	23790	1RB#0	5.97	13	PASS
Band17	10MHz	QPSK	23790	50RB#0	5.97	13	PASS
Band17	10MHz	QPSK	23800	1RB#0	6.29	13	PASS
Band17	10MHz	QPSK	23800	50RB#0	6.00	13	PASS
Band17	10MHz	16QAM	23780	1RB#0	6.84	13	PASS
Band17	10MHz	16QAM	23780	50RB#0	6.90	13	PASS
Band17	10MHz	16QAM	23790	1RB#0	6.35	13	PASS
Band17	10MHz	16QAM	23790	50RB#0	6.93	13	PASS
Band17	10MHz	16QAM	23800	1RB#0	7.01	13	PASS
Band17	10MHz	16QAM	23800	50RB#0	6.84	13	PASS
Band25	1.4MHz	QPSK	26047	1RB#0	4.81	13	PASS
Band25	1.4MHz	QPSK	26047	6RB#0	5.42	13	PASS
Band25	1.4MHz	QPSK	26365	1RB#0	5.04	13	PASS
Band25	1.4MHz	QPSK	26365	6RB#0	5.54	13	PASS
Band25	1.4MHz	QPSK	26683	1RB#0	3.74	13	PASS
Band25	1.4MHz	QPSK	26683	6RB#0	4.35	13	PASS
Band25	1.4MHz	16QAM	26047	1RB#0	5.07	13	PASS
Band25	1.4MHz	16QAM	26047	6RB#0	5.88	13	PASS
Band25	1.4MHz	16QAM	26365	1RB#0	5.39	13	PASS
Band25	1.4MHz	16QAM	26365	6RB#0	6.06	13	PASS
Band25	1.4MHz	16QAM	26683	1RB#0	4.06	13	PASS
Band25	1.4MHz	16QAM	26683	6RB#0	4.90	13	PASS
Band25	3MHz	QPSK	26055	1RB#0	4.72	13	PASS
Band25	3MHz	QPSK	26055	15RB#0	5.30	13	PASS
Band25	3MHz	QPSK	26365	1RB#0	5.04	13	PASS
Band25	3MHz	QPSK	26365	15RB#0	5.42	13	PASS
Band25	3MHz	QPSK	26675	1RB#0	4.00	13	PASS
Band25	3MHz	QPSK	26675	15RB#0	4.67	13	PASS
Band25	3MHz	16QAM	26055	1RB#0	5.48	13	PASS
Band25	3MHz	16QAM	26055	15RB#0	6.09	13	PASS
Band25	3MHz	16QAM	26365	1RB#0	5.71	13	PASS

Band25	3MHz	16QAM	26365	15RB#0	6.20	13	PASS
Band25	3MHz	16QAM	26675	1RB#0	4.75	13	PASS
Band25	3MHz	16QAM	26675	15RB#0	5.36	13	PASS
Band25	5MHz	QPSK	26065	1RB#0	5.25	13	PASS
Band25	5MHz	QPSK	26065	25RB#0	5.83	13	PASS
Band25	5MHz	QPSK	26365	1RB#0	5.51	13	PASS
Band25	5MHz	QPSK	26365	25RB#0	5.86	13	PASS
Band25	5MHz	QPSK	26665	1RB#0	4.72	13	PASS
Band25	5MHz	QPSK	26665	25RB#0	5.22	13	PASS
Band25	5MHz	16QAM	26065	1RB#0	5.68	13	PASS
Band25	5MHz	16QAM	26065	25RB#0	6.46	13	PASS
Band25	5MHz	16QAM	26365	1RB#0	5.86	13	PASS
Band25	5MHz	16QAM	26365	25RB#0	6.49	13	PASS
Band25	5MHz	16QAM	26665	1RB#0	5.16	13	PASS
Band25	5MHz	16QAM	26665	25RB#0	5.86	13	PASS
Band25	10MHz	QPSK	26090	1RB#0	4.67	13	PASS
Band25	10MHz	QPSK	26090	50RB#0	5.30	13	PASS
Band25	10MHz	QPSK	26365	1RB#0	5.04	13	PASS
Band25	10MHz	QPSK	26365	50RB#0	5.42	13	PASS
Band25	10MHz	QPSK	26640	1RB#0	4.52	13	PASS
Band25	10MHz	QPSK	26640	50RB#0	4.99	13	PASS
Band25	10MHz	16QAM	26090	1RB#0	5.33	13	PASS
Band25	10MHz	16QAM	26090	50RB#0	6.12	13	PASS
Band25	10MHz	16QAM	26365	1RB#0	5.54	13	PASS
Band25	10MHz	16QAM	26365	50RB#0	6.17	13	PASS
Band25	10MHz	16QAM	26640	1RB#0	5.22	13	PASS
Band25	10MHz	16QAM	26640	50RB#0	5.83	13	PASS
Band25	15MHz	QPSK	26115	1RB#0	4.70	13	PASS
Band25	15MHz	QPSK	26115	75RB#0	5.10	13	PASS
Band25	15MHz	QPSK	26365	1RB#0	5.07	13	PASS
Band25	15MHz	QPSK	26365	75RB#0	5.19	13	PASS
Band25	15MHz	QPSK	26615	1RB#0	4.78	13	PASS
Band25	15MHz	QPSK	26615	75RB#0	4.90	13	PASS
Band25	15MHz	16QAM	26115	1RB#0	5.33	13	PASS
Band25	15MHz	16QAM	26115	75RB#0	6.00	13	PASS
Band25	15MHz	16QAM	26365	1RB#0	5.68	13	PASS
Band25	15MHz	16QAM	26365	75RB#0	6.06	13	PASS
Band25	15MHz	16QAM	26615	1RB#0	5.45	13	PASS

Band25	15MHz	16QAM	26615	75RB#0	5.83	13	PASS
Band25	20MHz	QPSK	26140	1RB#0	4.55	13	PASS
Band25	20MHz	QPSK	26140	100RB#0	4.35	13	PASS
Band25	20MHz	QPSK	26365	1RB#0	4.87	13	PASS
Band25	20MHz	QPSK	26365	100RB#0	4.38	13	PASS
Band25	20MHz	QPSK	26590	1RB#0	4.67	13	PASS
Band25	20MHz	QPSK	26590	100RB#0	4.20	13	PASS
Band25	20MHz	16QAM	26140	1RB#0	5.16	13	PASS
Band25	20MHz	16QAM	26140	100RB#0	5.88	13	PASS
Band25	20MHz	16QAM	26365	1RB#0	5.51	13	PASS
Band25	20MHz	16QAM	26365	100RB#0	5.88	13	PASS
Band25	20MHz	16QAM	26590	1RB#0	5.22	13	PASS
Band25	20MHz	16QAM	26590	100RB#0	5.77	13	PASS
Band26	1.4MHz	QPSK	26797	1RB#0	5.13	13	PASS
Band26	1.4MHz	QPSK	26797	6RB#0	5.62	13	PASS
Band26	1.4MHz	QPSK	26915	1RB#0	4.75	13	PASS
Band26	1.4MHz	QPSK	26915	6RB#0	5.10	13	PASS
Band26	1.4MHz	QPSK	27033	1RB#0	4.32	13	PASS
Band26	1.4MHz	QPSK	27033	6RB#0	4.61	13	PASS
Band26	1.4MHz	16QAM	26797	1RB#0	5.45	13	PASS
Band26	1.4MHz	16QAM	26797	6RB#0	6.20	13	PASS
Band26	1.4MHz	16QAM	26915	1RB#0	4.72	13	PASS
Band26	1.4MHz	16QAM	26915	6RB#0	5.65	13	PASS
Band26	1.4MHz	16QAM	27033	1RB#0	4.26	13	PASS
Band26	1.4MHz	16QAM	27033	6RB#0	5.13	13	PASS
Band26	3MHz	QPSK	26805	1RB#0	5.19	13	PASS
Band26	3MHz	QPSK	26805	15RB#0	5.51	13	PASS
Band26	3MHz	QPSK	26915	1RB#0	4.78	13	PASS
Band26	3MHz	QPSK	26915	15RB#0	5.04	13	PASS
Band26	3MHz	QPSK	27025	1RB#0	5.19	13	PASS
Band26	3MHz	QPSK	27025	15RB#0	5.10	13	PASS
Band26	3MHz	16QAM	26805	1RB#0	5.86	13	PASS
Band26	3MHz	16QAM	26805	15RB#0	6.26	13	PASS
Band26	3MHz	16QAM	26915	1RB#0	5.30	13	PASS
Band26	3MHz	16QAM	26915	15RB#0	5.83	13	PASS
Band26	3MHz	16QAM	27025	1RB#0	5.74	13	PASS
Band26	3MHz	16QAM	27025	15RB#0	5.86	13	PASS
Band26	5MHz	QPSK	26815	1RB#0	5.01	13	PASS

Band26	5MHz	QPSK	26815	25RB#0	5.77	13	PASS
Band26	5MHz	QPSK	26915	1RB#0	4.84	13	PASS
Band26	5MHz	QPSK	26915	25RB#0	5.25	13	PASS
Band26	5MHz	QPSK	27015	1RB#0	5.65	13	PASS
Band26	5MHz	QPSK	27015	25RB#0	5.59	13	PASS
Band26	5MHz	16QAM	26815	1RB#0	5.68	13	PASS
Band26	5MHz	16QAM	26815	25RB#0	6.38	13	PASS
Band26	5MHz	16QAM	26915	1RB#0	5.28	13	PASS
Band26	5MHz	16QAM	26915	25RB#0	5.83	13	PASS
Band26	5MHz	16QAM	27015	1RB#0	6.06	13	PASS
Band26	5MHz	16QAM	27015	25RB#0	6.29	13	PASS
Band26	10MHz	QPSK	26840	1RB#0	4.96	13	PASS
Band26	10MHz	QPSK	26840	50RB#0	5.45	13	PASS
Band26	10MHz	QPSK	26915	1RB#0	5.13	13	PASS
Band26	10MHz	QPSK	26915	50RB#0	5.16	13	PASS
Band26	10MHz	QPSK	26990	1RB#0	4.78	13	PASS
Band26	10MHz	QPSK	26990	50RB#0	5.51	13	PASS
Band26	10MHz	16QAM	26840	1RB#0	5.86	13	PASS
Band26	10MHz	16QAM	26840	50RB#0	6.23	13	PASS
Band26	10MHz	16QAM	26915	1RB#0	5.65	13	PASS
Band26	10MHz	16QAM	26915	50RB#0	5.88	13	PASS
Band26	10MHz	16QAM	26990	1RB#0	5.45	13	PASS
Band26	10MHz	16QAM	26990	50RB#0	6.32	13	PASS
Band26	15MHz	QPSK	26865	1RB#0	5.30	13	PASS
Band26	15MHz	QPSK	26865	75RB#0	5.04	13	PASS
Band26	15MHz	QPSK	26915	1RB#0	5.28	13	PASS
Band26	15MHz	QPSK	26915	75RB#0	5.10	13	PASS
Band26	15MHz	QPSK	26965	1RB#0	4.78	13	PASS
Band26	15MHz	QPSK	26965	75RB#0	5.22	13	PASS
Band26	15MHz	16QAM	26865	1RB#0	5.83	13	PASS
Band26	15MHz	16QAM	26865	75RB#0	5.97	13	PASS
Band26	15MHz	16QAM	26915	1RB#0	5.57	13	PASS
Band26	15MHz	16QAM	26915	75RB#0	5.86	13	PASS
Band26	15MHz	16QAM	26965	1RB#0	5.30	13	PASS
Band26	15MHz	16QAM	26965	75RB#0	6.12	13	PASS
Band38	5MHz	QPSK	37775	1RB#0	5.36	13	PASS
Band38	5MHz	QPSK	37775	25RB#0	9.04	13	PASS
Band38	5MHz	QPSK	38000	1RB#0	8.58	13	PASS

Band38	5MHz	QPSK	38000	25RB#0	9.13	13	PASS
Band38	5MHz	QPSK	38225	1RB#0	8.72	13	PASS
Band38	5MHz	QPSK	38225	25RB#0	9.19	13	PASS
Band38	5MHz	16QAM	37775	1RB#0	9.36	13	PASS
Band38	5MHz	16QAM	37775	25RB#0	9.62	13	PASS
Band38	5MHz	16QAM	38000	1RB#0	9.16	13	PASS
Band38	5MHz	16QAM	38000	25RB#0	9.83	13	PASS
Band38	5MHz	16QAM	38225	1RB#0	9.16	13	PASS
Band38	5MHz	16QAM	38225	25RB#0	9.74	13	PASS
Band38	10MHz	QPSK	37800	1RB#0	7.59	13	PASS
Band38	10MHz	QPSK	37800	50RB#0	8.81	13	PASS
Band38	10MHz	QPSK	38000	1RB#0	8.58	13	PASS
Band38	10MHz	QPSK	38000	50RB#0	8.90	13	PASS
Band38	10MHz	QPSK	38200	1RB#0	8.52	13	PASS
Band38	10MHz	QPSK	38200	50RB#0	8.93	13	PASS
Band38	10MHz	16QAM	37800	1RB#0	9.39	13	PASS
Band38	10MHz	16QAM	37800	50RB#0	9.57	13	PASS
Band38	10MHz	16QAM	38000	1RB#0	9.57	13	PASS
Band38	10MHz	16QAM	38000	50RB#0	10.00	13	PASS
Band38	10MHz	16QAM	38200	1RB#0	9.39	13	PASS
Band38	10MHz	16QAM	38200	50RB#0	9.71	13	PASS
Band38	15MHz	QPSK	37825	1RB#0	8.46	13	PASS
Band38	15MHz	QPSK	37825	75RB#0	8.70	13	PASS
Band38	15MHz	QPSK	38000	1RB#0	8.67	13	PASS
Band38	15MHz	QPSK	38000	75RB#0	8.75	13	PASS
Band38	15MHz	QPSK	38175	1RB#0	8.64	13	PASS
Band38	15MHz	QPSK	38175	75RB#0	8.81	13	PASS
Band38	15MHz	16QAM	37825	1RB#0	9.54	13	PASS
Band38	15MHz	16QAM	37825	75RB#0	9.51	13	PASS
Band38	15MHz	16QAM	38000	1RB#0	9.54	13	PASS
Band38	15MHz	16QAM	38000	75RB#0	9.57	13	PASS
Band38	15MHz	16QAM	38175	1RB#0	9.59	13	PASS
Band38	15MHz	16QAM	38175	75RB#0	9.83	13	PASS
Band38	20MHz	QPSK	37850	1RB#0	7.91	13	PASS
Band38	20MHz	QPSK	37850	100RB#0	7.94	13	PASS
Band38	20MHz	QPSK	38000	1RB#0	8.67	13	PASS
Band38	20MHz	QPSK	38000	100RB#0	8.03	13	PASS
Band38	20MHz	QPSK	38150	1RB#0	8.72	13	PASS

Band38	20MHz	QPSK	38150	100RB#0	8.06	13	PASS
Band38	20MHz	16QAM	37850	1RB#0	9.16	13	PASS
Band38	20MHz	16QAM	37850	100RB#0	9.39	13	PASS
Band38	20MHz	16QAM	38000	1RB#0	9.16	13	PASS
Band38	20MHz	16QAM	38000	100RB#0	9.45	13	PASS
Band38	20MHz	16QAM	38150	1RB#0	9.07	13	PASS
Band38	20MHz	16QAM	38150	100RB#0	9.45	13	PASS
Band39	5MHz	QPSK	38275	1RB#0	4.70	13	PASS
Band39	5MHz	QPSK	38275	25RB#0	9.25	13	PASS
Band39	5MHz	QPSK	38400	1RB#0	9.28	13	PASS
Band39	5MHz	QPSK	38400	25RB#0	9.59	13	PASS
Band39	5MHz	QPSK	38525	1RB#0	8.87	13	PASS
Band39	5MHz	QPSK	38525	25RB#0	9.39	13	PASS
Band39	5MHz	16QAM	38275	1RB#0	9.36	13	PASS
Band39	5MHz	16QAM	38275	25RB#0	10.23	13	PASS
Band39	5MHz	16QAM	38400	1RB#0	9.39	13	PASS
Band39	5MHz	16QAM	38400	25RB#0	10.32	13	PASS
Band39	5MHz	16QAM	38525	1RB#0	9.57	13	PASS
Band39	5MHz	16QAM	38525	25RB#0	10.03	13	PASS
Band39	10MHz	QPSK	38300	1RB#0	8.52	13	PASS
Band39	10MHz	QPSK	38300	50RB#0	9.01	13	PASS
Band39	10MHz	QPSK	38400	1RB#0	8.81	13	PASS
Band39	10MHz	QPSK	38400	50RB#0	9.28	13	PASS
Band39	10MHz	QPSK	38500	1RB#0	8.90	13	PASS
Band39	10MHz	QPSK	38500	50RB#0	9.13	13	PASS
Band39	10MHz	16QAM	38300	1RB#0	9.48	13	PASS
Band39	10MHz	16QAM	38300	50RB#0	9.83	13	PASS
Band39	10MHz	16QAM	38400	1RB#0	10.06	13	PASS
Band39	10MHz	16QAM	38400	50RB#0	10.12	13	PASS
Band39	10MHz	16QAM	38500	1RB#0	9.65	13	PASS
Band39	10MHz	16QAM	38500	50RB#0	9.91	13	PASS
Band39	15MHz	QPSK	38325	1RB#0	6.38	13	PASS
Band39	15MHz	QPSK	38325	75RB#0	9.19	13	PASS
Band39	15MHz	QPSK	38400	1RB#0	8.81	13	PASS
Band39	15MHz	QPSK	38400	75RB#0	8.93	13	PASS
Band39	15MHz	QPSK	38475	1RB#0	8.93	13	PASS
Band39	15MHz	QPSK	38475	75RB#0	8.99	13	PASS
Band39	15MHz	16QAM	38325	1RB#0	9.54	13	PASS

Band39	15MHz	16QAM	38325	75RB#0	9.91	13	PASS
Band39	15MHz	16QAM	38400	1RB#0	9.59	13	PASS
Band39	15MHz	16QAM	38400	75RB#0	9.71	13	PASS
Band39	15MHz	16QAM	38475	1RB#0	9.74	13	PASS
Band39	15MHz	16QAM	38475	75RB#0	9.94	13	PASS
Band39	20MHz	QPSK	38350	1RB#0	8.03	13	PASS
Band39	20MHz	QPSK	38350	100RB#0	8.09	13	PASS
Band39	20MHz	QPSK	38400	1RB#0	8.70	13	PASS
Band39	20MHz	QPSK	38400	100RB#0	8.12	13	PASS
Band39	20MHz	QPSK	38450	1RB#0	9.07	13	PASS
Band39	20MHz	QPSK	38450	100RB#0	8.26	13	PASS
Band39	20MHz	16QAM	38350	1RB#0	9.36	13	PASS
Band39	20MHz	16QAM	38350	100RB#0	9.62	13	PASS
Band39	20MHz	16QAM	38400	1RB#0	9.39	13	PASS
Band39	20MHz	16QAM	38400	100RB#0	9.54	13	PASS
Band39	20MHz	16QAM	38450	1RB#0	9.71	13	PASS
Band39	20MHz	16QAM	38450	100RB#0	9.86	13	PASS
Band41	5MHz	QPSK	40265	1RB#0	4.38	13	PASS
Band41	5MHz	QPSK	40265	25RB#0	9.42	13	PASS
Band41	5MHz	QPSK	40740	1RB#0	8.87	13	PASS
Band41	5MHz	QPSK	40740	25RB#0	9.39	13	PASS
Band41	5MHz	QPSK	41265	1RB#0	10.03	13	PASS
Band41	5MHz	QPSK	41265	25RB#0	9.71	13	PASS
Band41	5MHz	16QAM	40265	1RB#0	8.87	13	PASS
Band41	5MHz	16QAM	40265	25RB#0	9.71	13	PASS
Band41	5MHz	16QAM	40740	1RB#0	9.33	13	PASS
Band41	5MHz	16QAM	40740	25RB#0	10.03	13	PASS
Band41	5MHz	16QAM	41265	1RB#0	10.03	13	PASS
Band41	5MHz	16QAM	41265	25RB#0	10.00	13	PASS
Band41	10MHz	QPSK	40290	1RB#0	5.62	13	PASS
Band41	10MHz	QPSK	40290	50RB#0	8.93	13	PASS
Band41	10MHz	QPSK	40740	1RB#0	8.78	13	PASS
Band41	10MHz	QPSK	40740	50RB#0	9.13	13	PASS
Band41	10MHz	QPSK	41290	1RB#0	9.88	13	PASS
Band41	10MHz	QPSK	41290	50RB#0	9.42	13	PASS
Band41	10MHz	16QAM	40290	1RB#0	9.13	13	PASS
Band41	10MHz	16QAM	40290	50RB#0	9.71	13	PASS
Band41	10MHz	16QAM	40740	1RB#0	9.68	13	PASS

Band41	10MHz	16QAM	40740	50RB#0	9.88	13	PASS
Band41	10MHz	16QAM	41290	1RB#0	9.83	13	PASS
Band41	10MHz	16QAM	41290	50RB#0	9.86	13	PASS
Band41	15MHz	QPSK	40315	1RB#0	10.93	13	PASS
Band41	15MHz	QPSK	40315	75RB#0	9.19	13	PASS
Band41	15MHz	QPSK	40740	1RB#0	8.81	13	PASS
Band41	15MHz	QPSK	40740	75RB#0	9.33	13	PASS
Band41	15MHz	QPSK	41315	1RB#0	9.74	13	PASS
Band41	15MHz	QPSK	41315	75RB#0	9.13	13	PASS
Band41	15MHz	16QAM	40315	1RB#0	9.07	13	PASS
Band41	15MHz	16QAM	40315	75RB#0	9.97	13	PASS
Band41	15MHz	16QAM	40740	1RB#0	9.74	13	PASS
Band41	15MHz	16QAM	40740	75RB#0	9.74	13	PASS
Band41	15MHz	16QAM	41315	1RB#0	9.57	13	PASS
Band41	15MHz	16QAM	41315	75RB#0	9.62	13	PASS
Band41	20MHz	QPSK	40340	1RB#0	8.32	13	PASS
Band41	20MHz	QPSK	40340	100RB#0	8.35	13	PASS
Band41	20MHz	QPSK	40740	1RB#0	8.75	13	PASS
Band41	20MHz	QPSK	40740	100RB#0	8.17	13	PASS
Band41	20MHz	QPSK	41140	1RB#0	8.70	13	PASS
Band41	20MHz	QPSK	41140	100RB#0	8.14	13	PASS
Band41	20MHz	16QAM	40340	1RB#0	8.87	13	PASS
Band41	20MHz	16QAM	40340	100RB#0	9.48	13	PASS
Band41	20MHz	16QAM	40740	1RB#0	9.22	13	PASS
Band41	20MHz	16QAM	40740	100RB#0	9.57	13	PASS
Band41	20MHz	16QAM	41140	1RB#0	9.22	13	PASS
Band41	20MHz	16QAM	41140	100RB#0	9.51	13	PASS

Test Graphs

Band2_1.4MHz_QPSK_18607_1RB#0

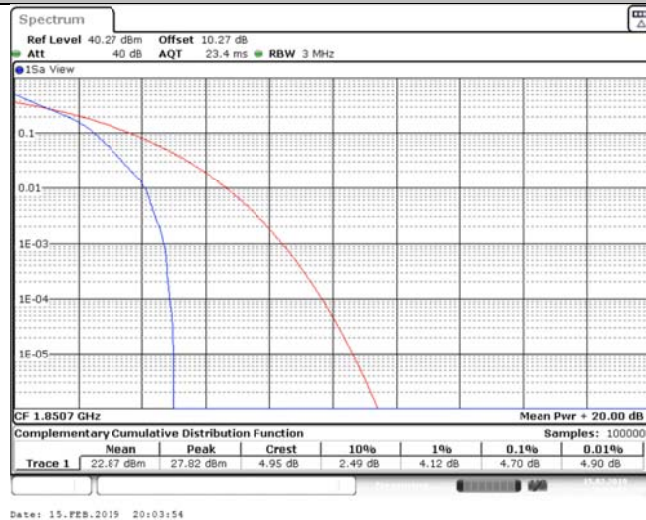

Band2_1.4MHz_QPSK_18607_6RB#0

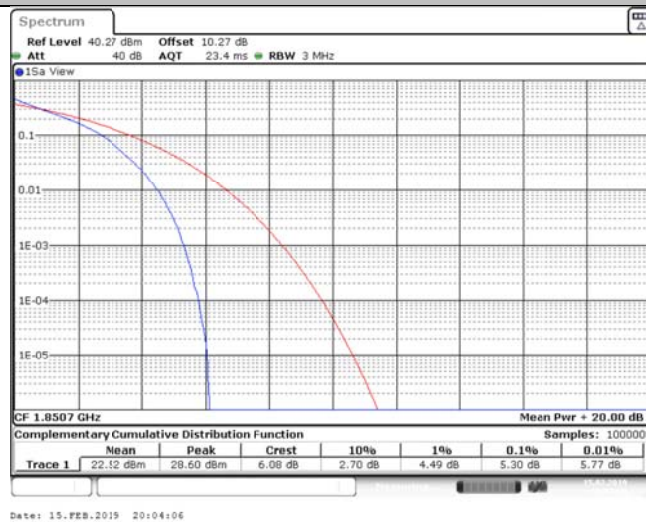

Band2_1.4MHz_QPSK_18900_1RB#0

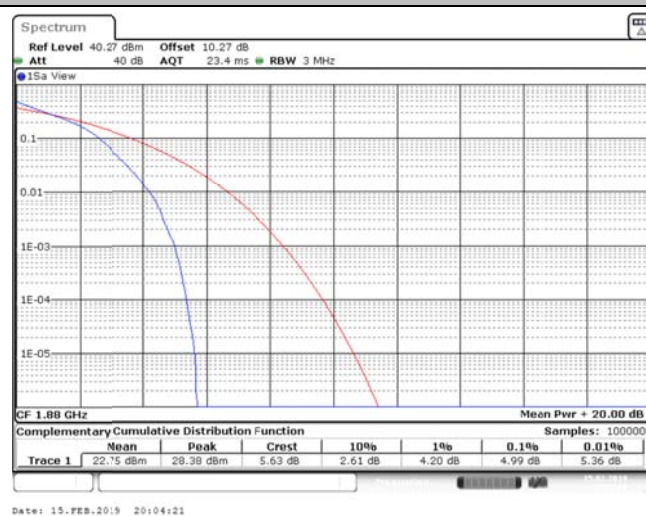

Band2_1.4MHz_QPSK_18900_6RB#0

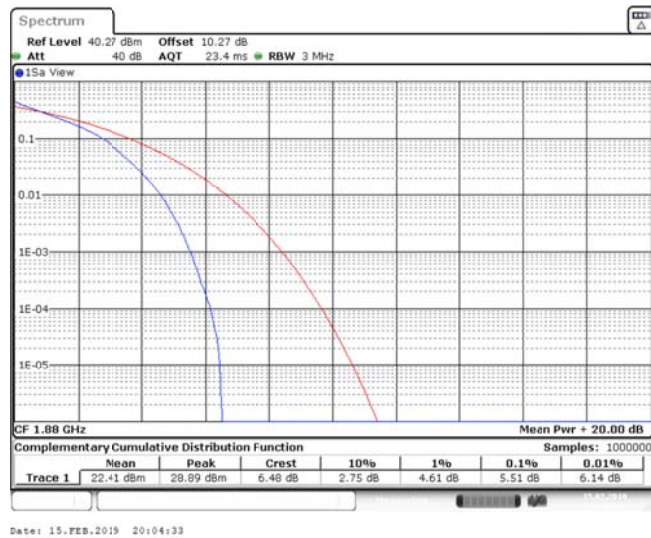

Band2_1.4MHz_QPSK_19193_1RB#0

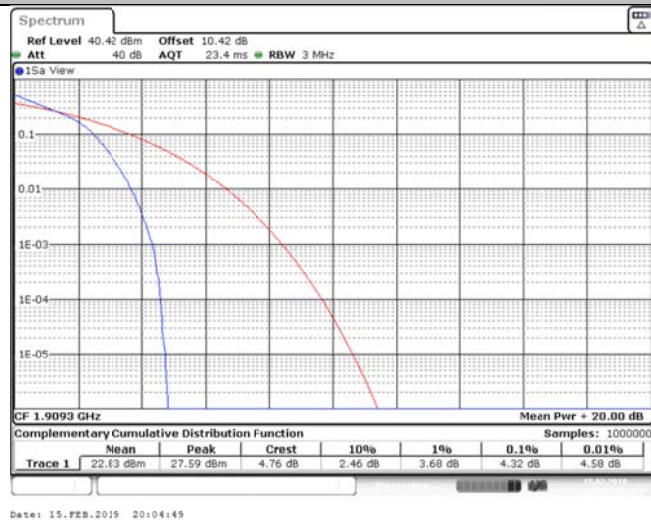

Band2_1.4MHz_QPSK_19193_6RB#0

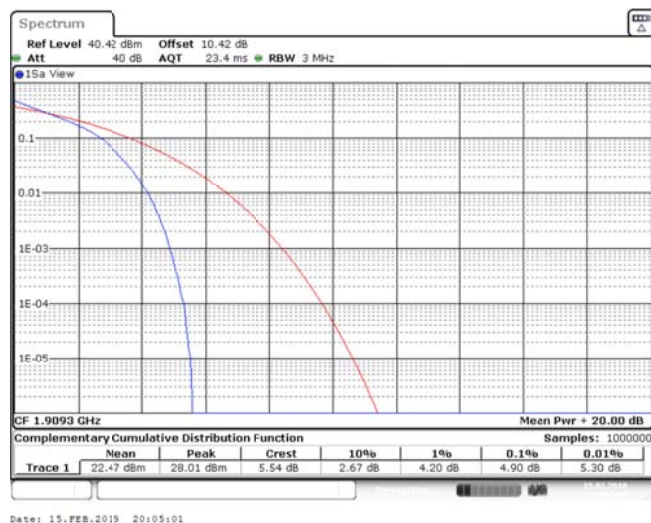

Band2_1.4MHz_16QAM_18607_1RB#0

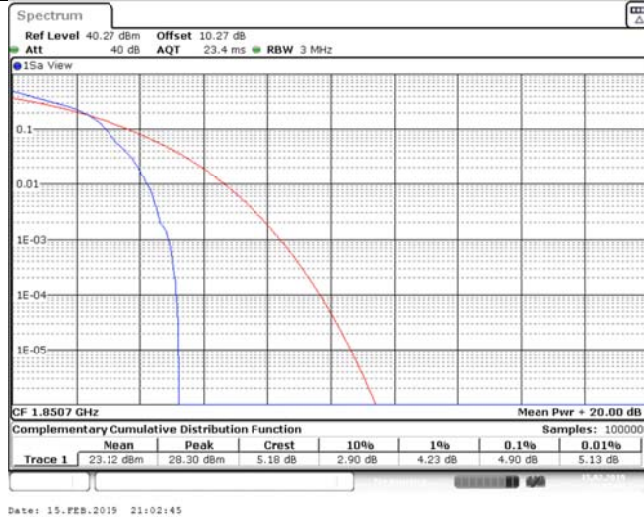

Band2_1.4MHz_16QAM_18607_6RB#0

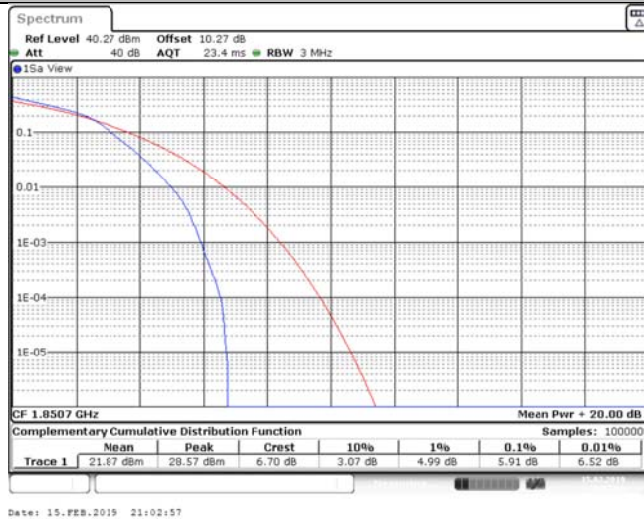

Band2_1.4MHz_16QAM_18900_1RB#0

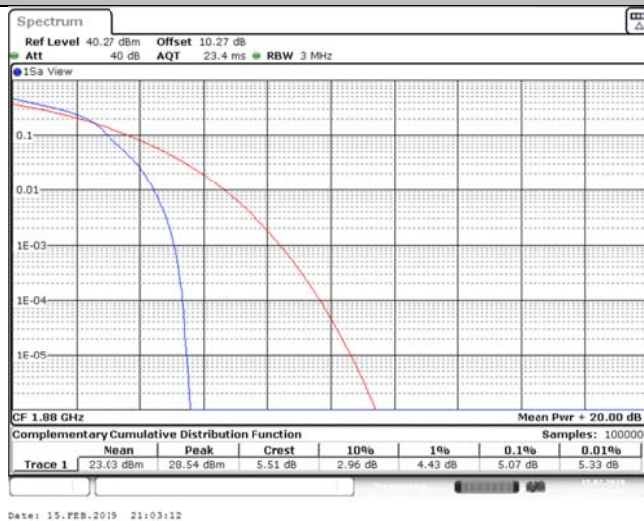

Band2_1.4MHz_16QAM_18900_6RB#0

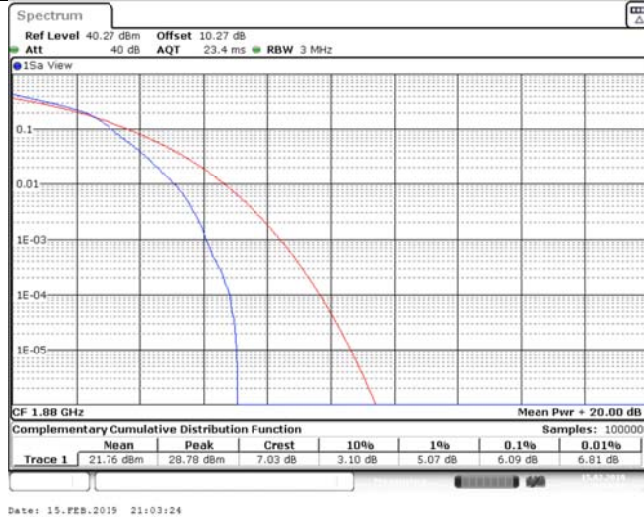

Band2_1.4MHz_16QAM_19193_1RB#0

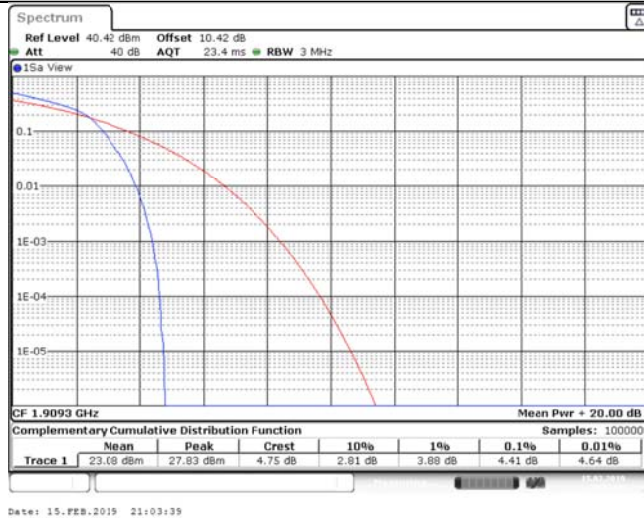

Band2_1.4MHz_16QAM_19193_6RB#0

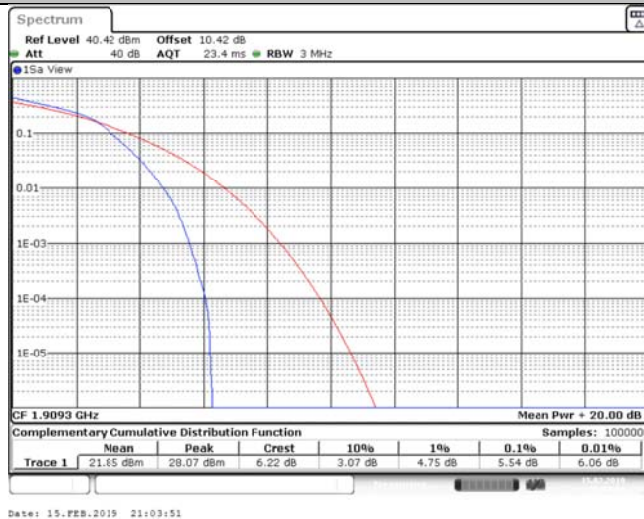

Band2_3MHz_QPSK_18615_1RB#0

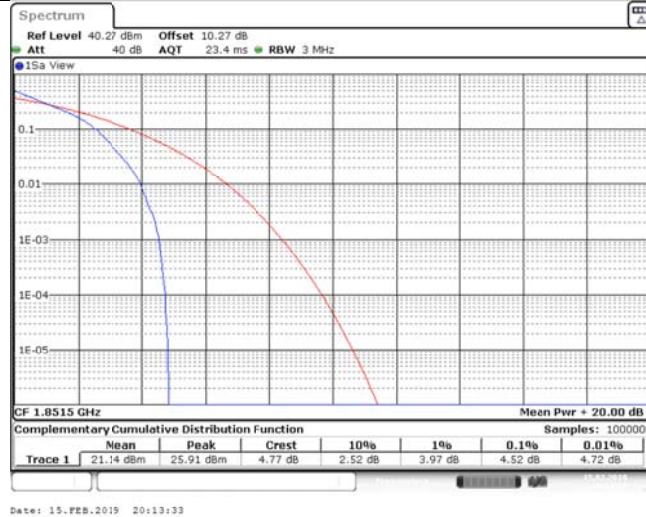

Band2_3MHz_QPSK_18615_15RB#0

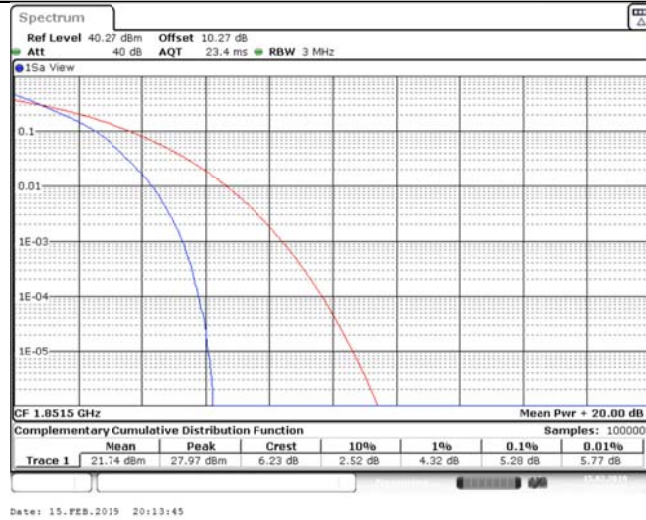

Band2_3MHz_QPSK_18900_1RB#0

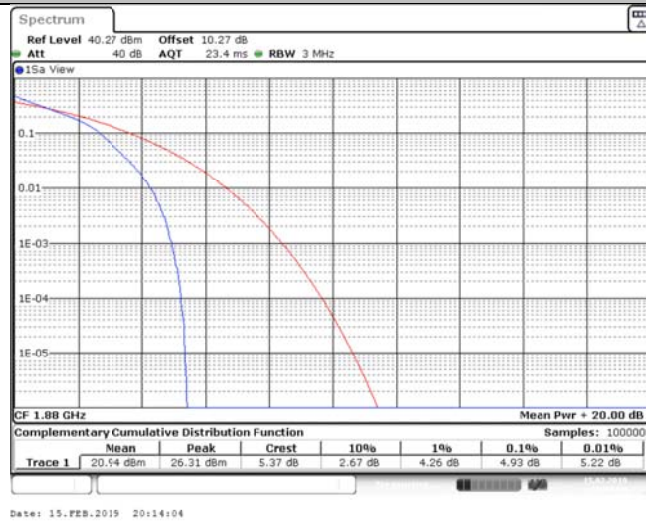

Band2_3MHz_QPSK_18900_15RB#0

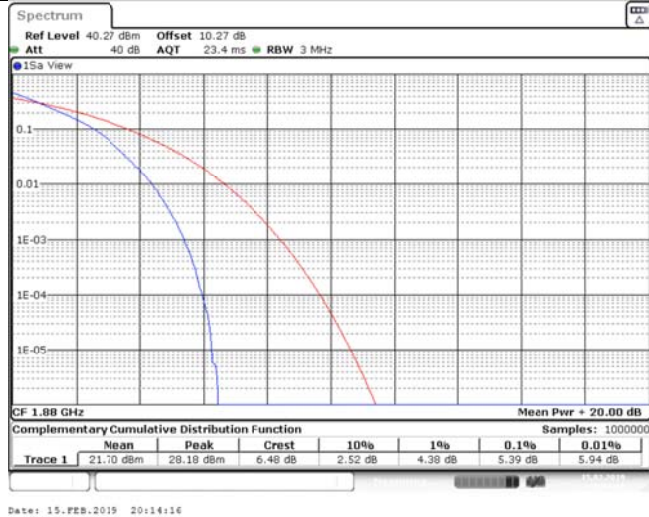

Band2_3MHz_QPSK_19185_1RB#0

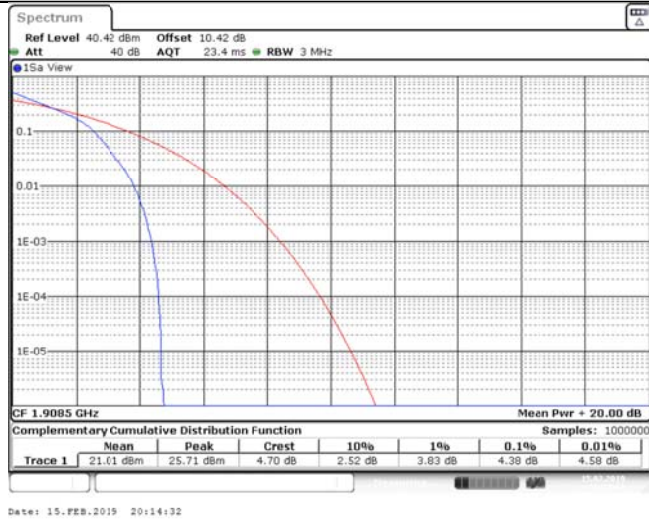

Band2_3MHz_QPSK_19185_15RB#0

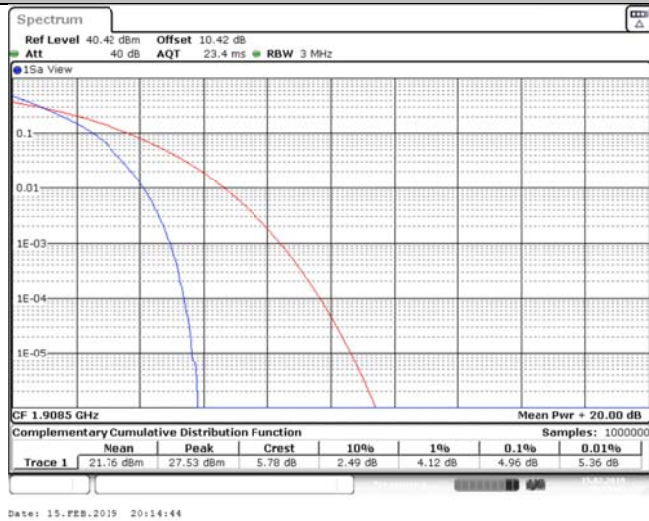

Band2_3MHz_16QAM_18615_1RB#0

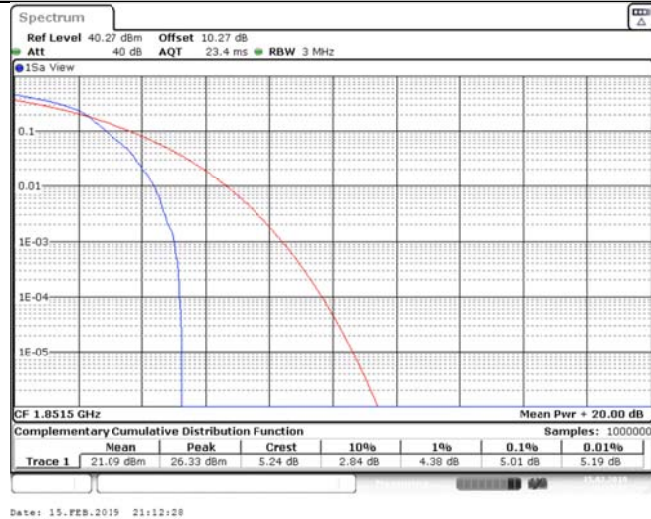

Band2_3MHz_16QAM_18615_15RB#0

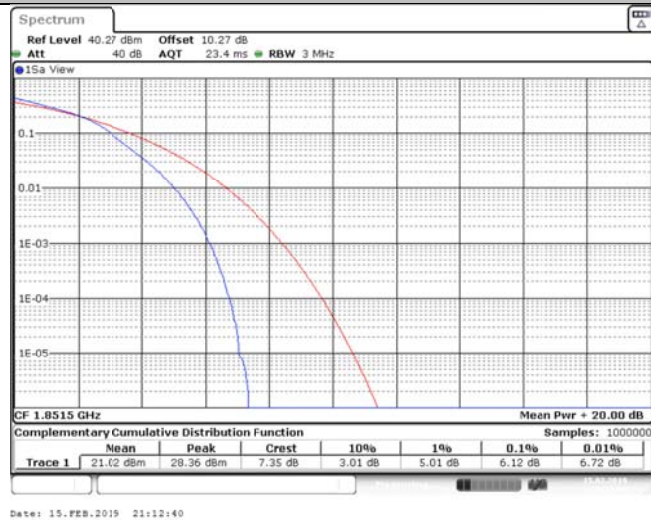

Band2_3MHz_16QAM_18900_1RB#0

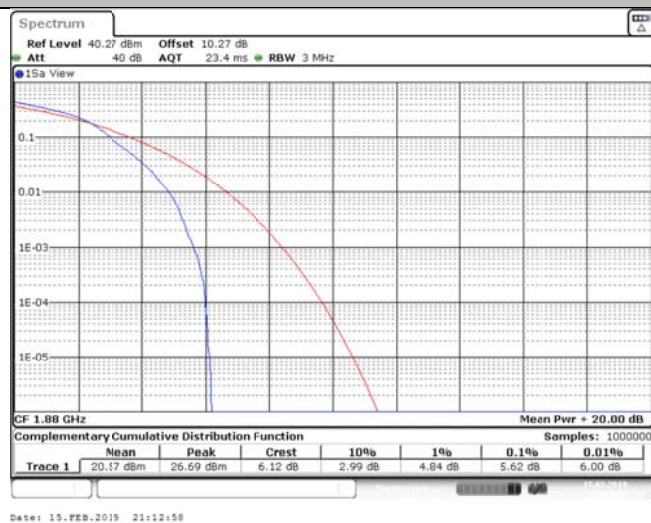

Band2_3MHz_16QAM_18900_15RB#0

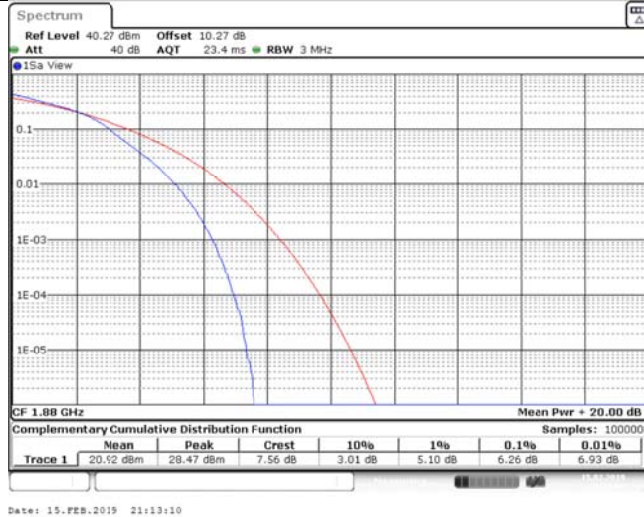

Band2_3MHz_16QAM_19185_1RB#0

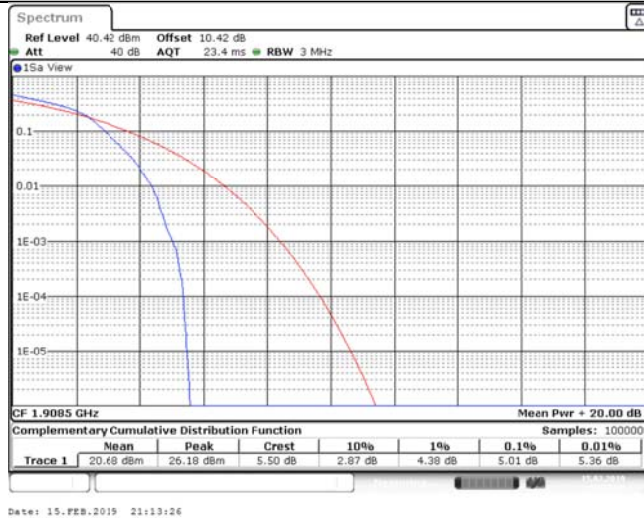

Band2_3MHz_16QAM_19185_15RB#0

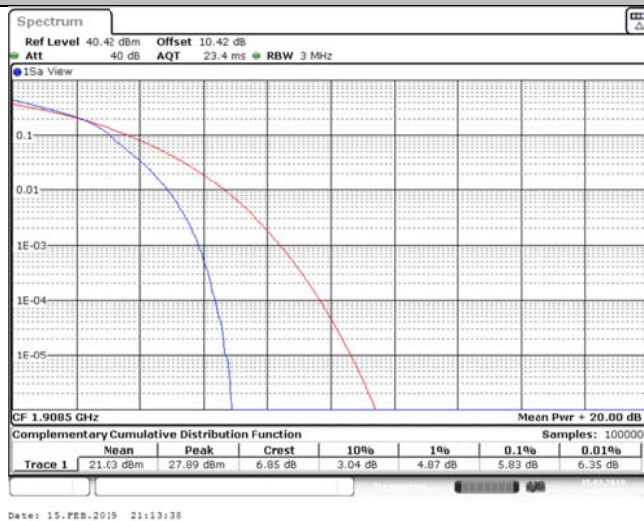

Band2_5MHz_QPSK_18625_1RB#0

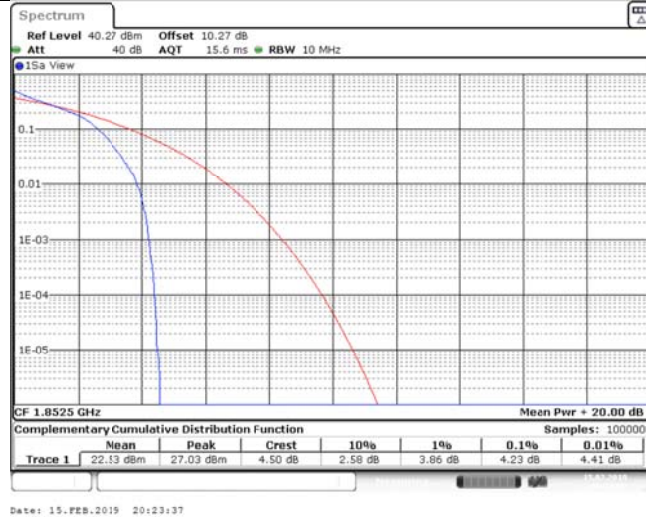

Band2_5MHz_QPSK_18625_25RB#0

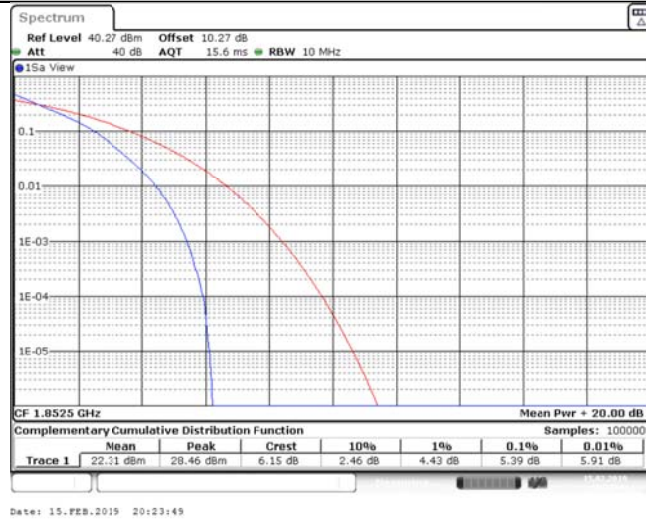

Band2_5MHz_QPSK_18900_1RB#0

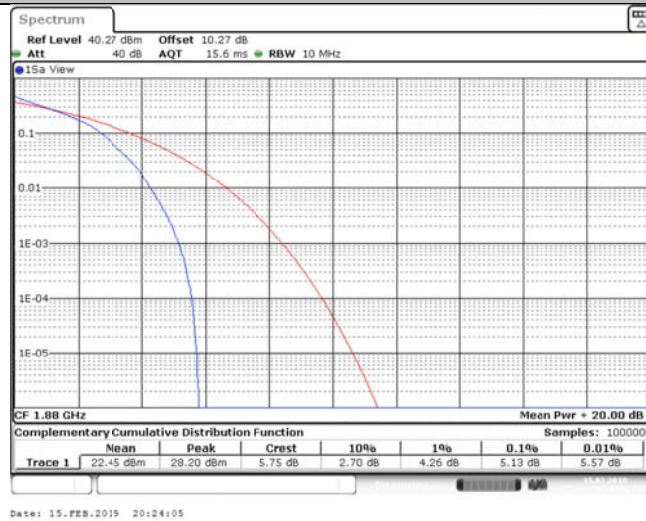

Band2_5MHz_QPSK_18900_25RB#0

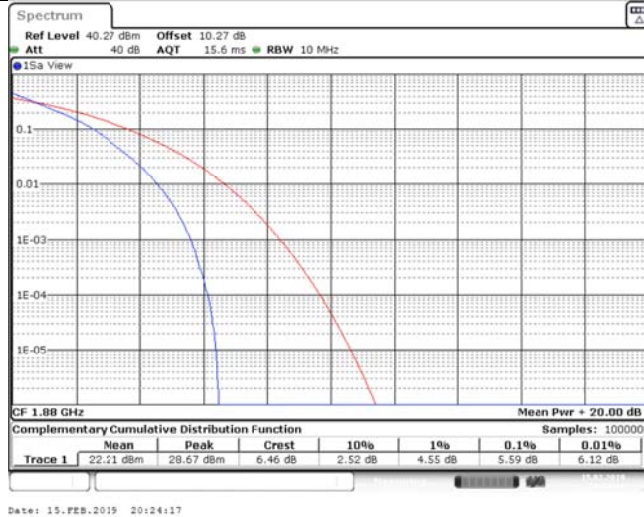

Band2_5MHz_QPSK_19175_1RB#0

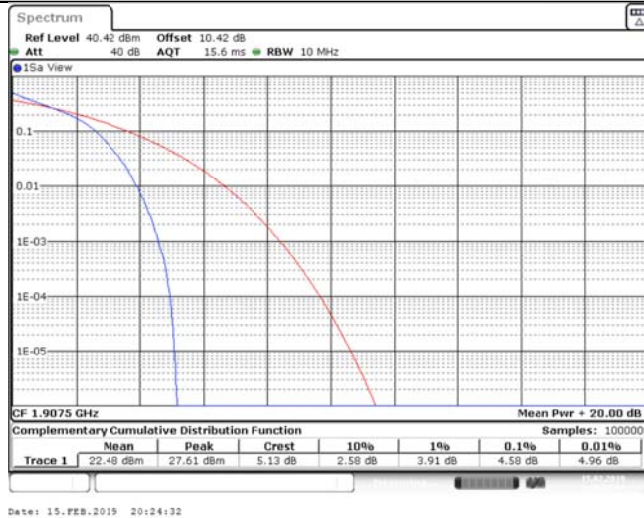

Band2_5MHz_QPSK_19175_25RB#0

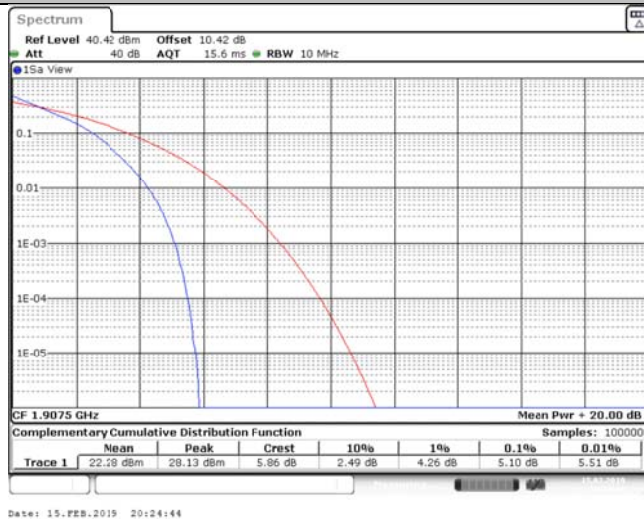

Band2_5MHz_16QAM_18625_1RB#0

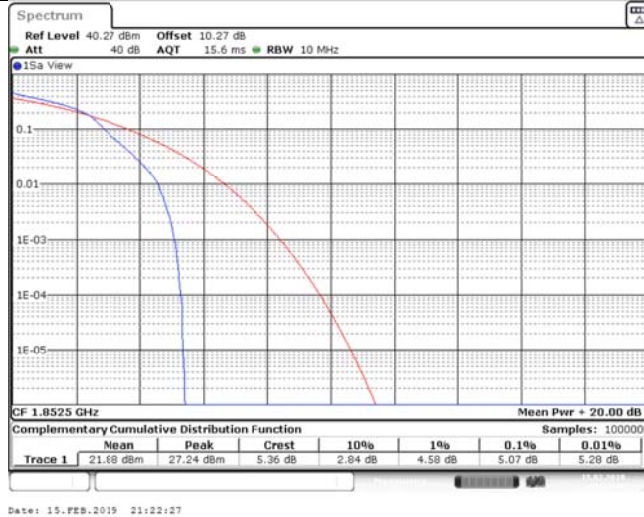

Band2_5MHz_16QAM_18625_25RB#0

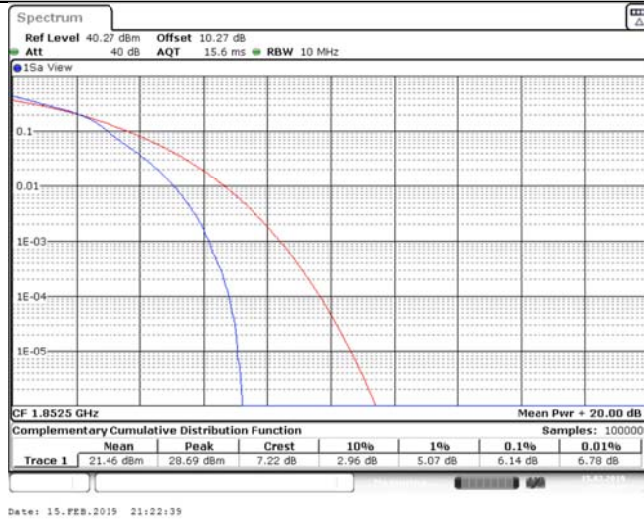

Band2_5MHz_16QAM_18900_1RB#0

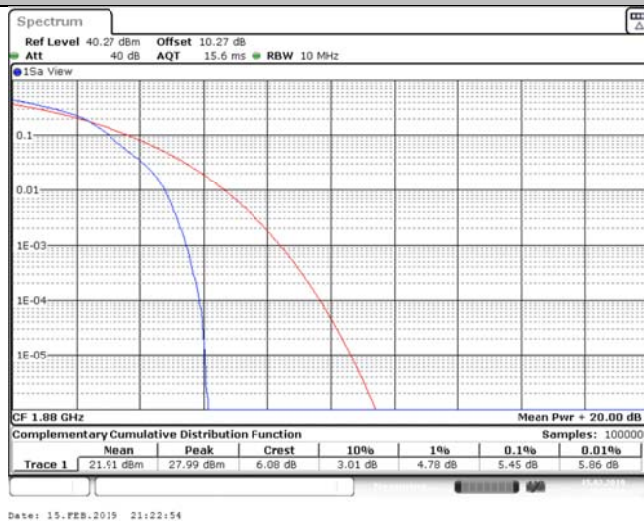

Band2_5MHz_16QAM_18900_25RB#0

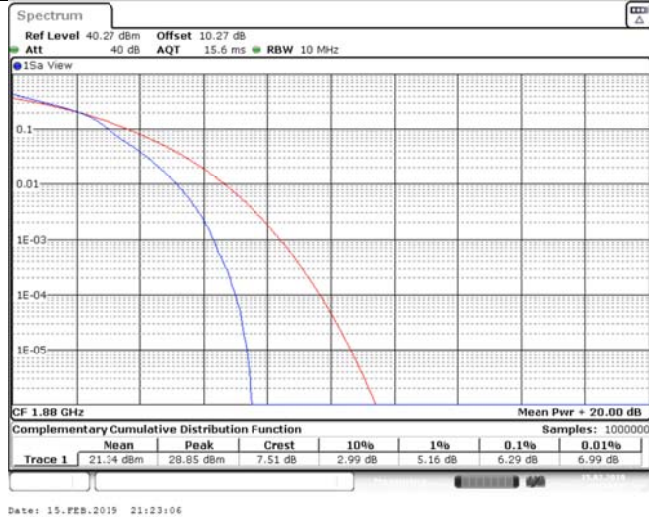

Band2_5MHz_16QAM_19175_1RB#0

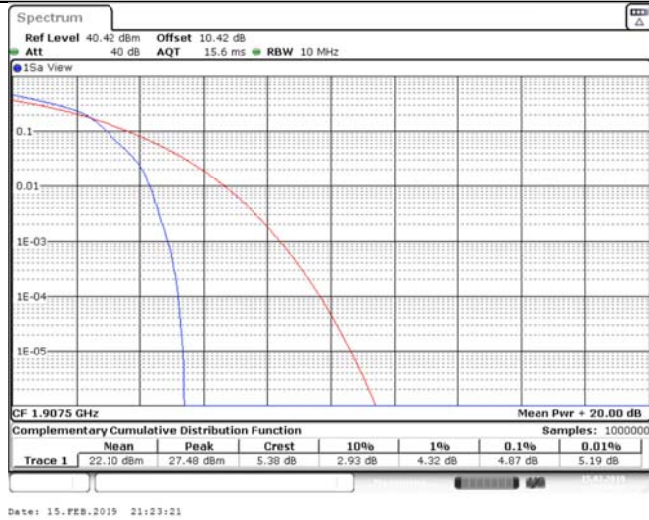

Band2_5MHz_16QAM_19175_25RB#0

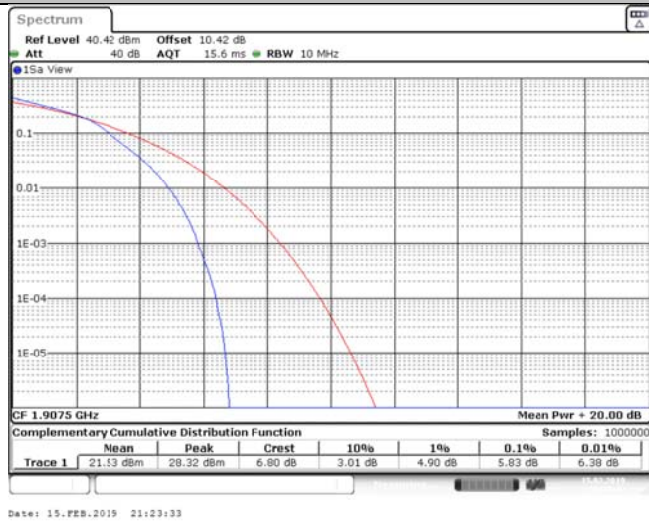

Band2_10MHz_QPSK_18650_1RB#0

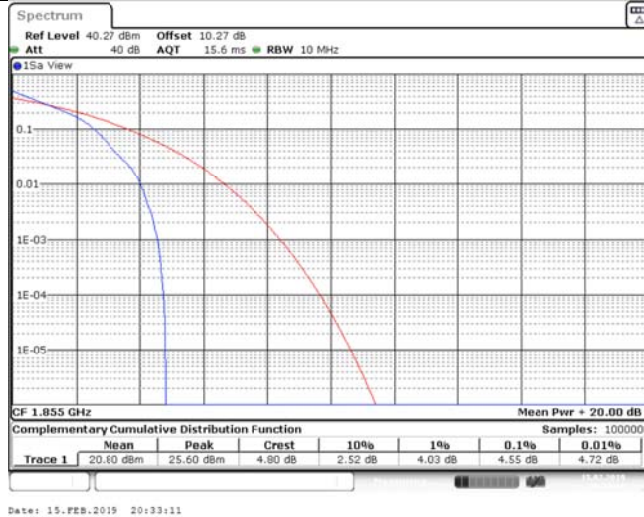

Band2_10MHz_QPSK_18650_50RB#0

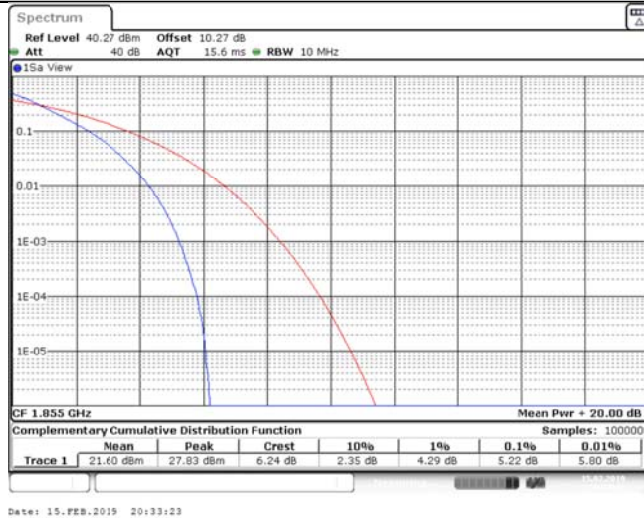

Band2_10MHz_QPSK_18900_1RB#0

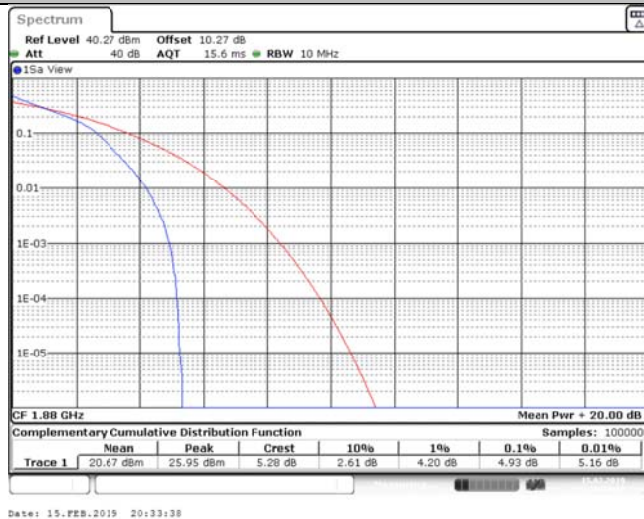

Band2_10MHz_QPSK_18900_50RB#0

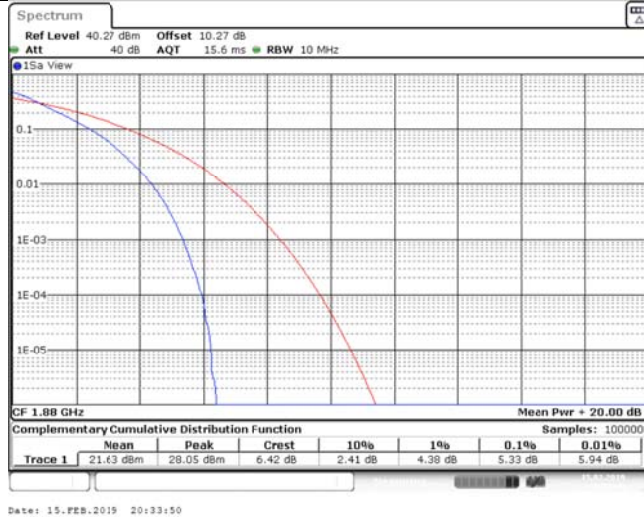

Band2_10MHz_QPSK_19150_1RB#0

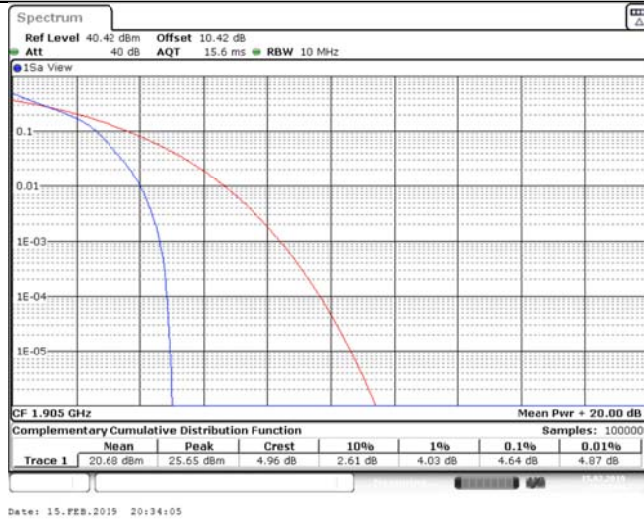

Band2_10MHz_QPSK_19150_50RB#0

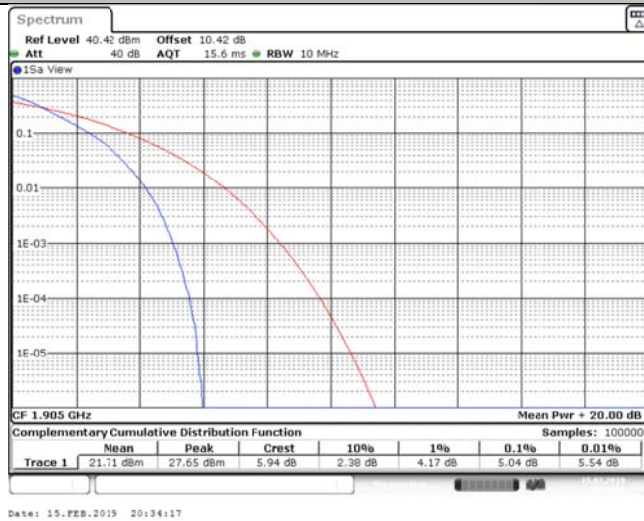

Band2_10MHz_16QAM_18650_1RB#0

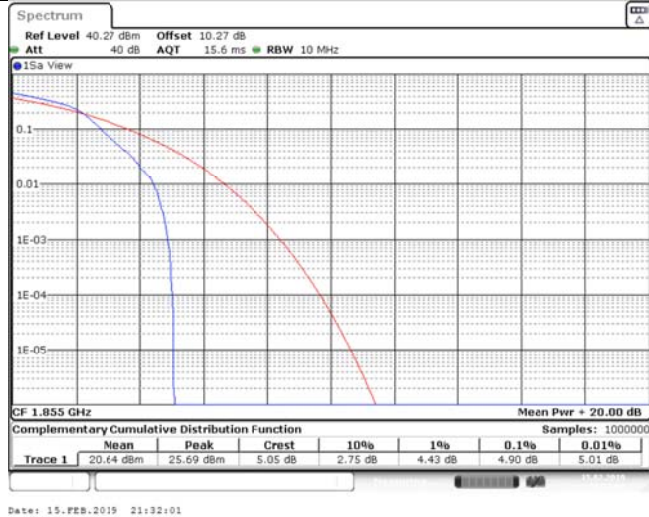

Band2_10MHz_16QAM_18650_50RB#0

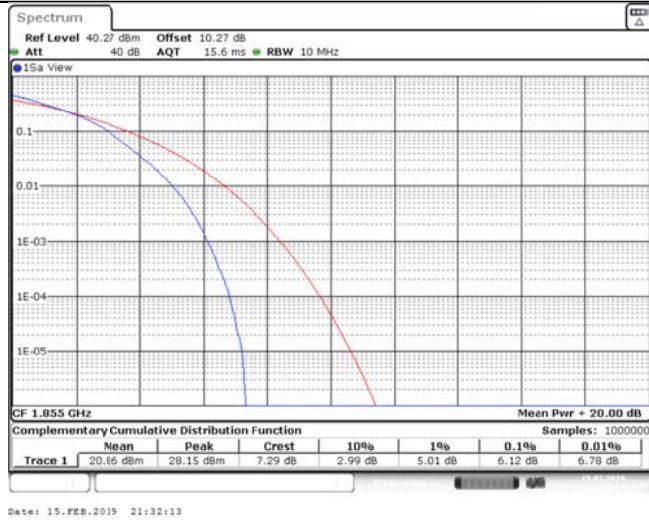

Band2_10MHz_16QAM_18900_1RB#0

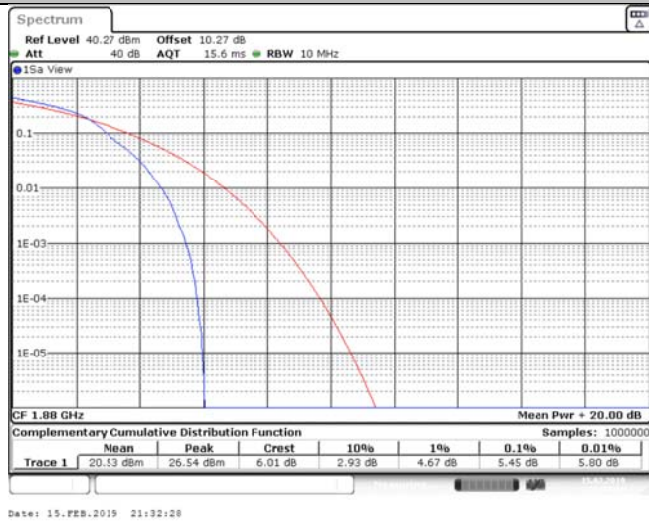

Band2_10MHz_16QAM_18900_50RB#0

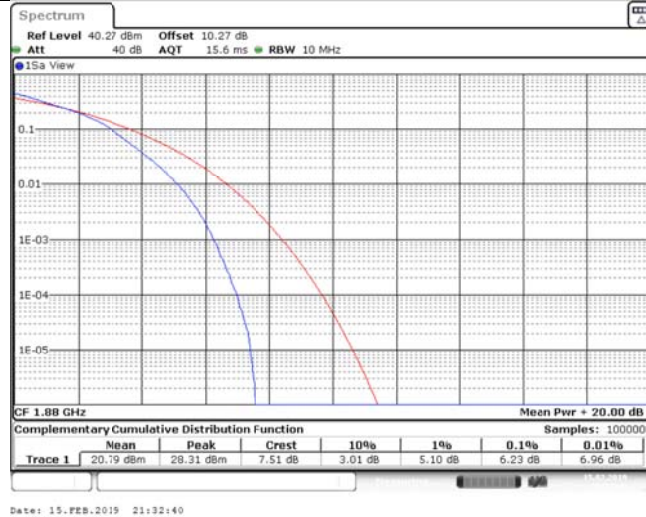

Band2_10MHz_16QAM_19150_1RB#0

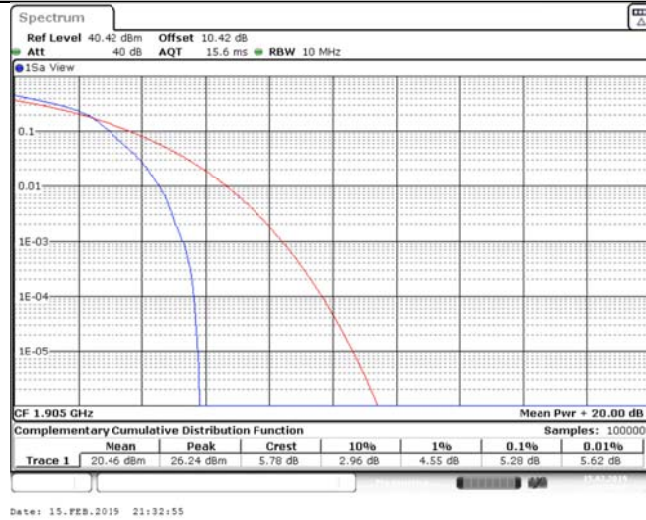

Band2_10MHz_16QAM_19150_50RB#0

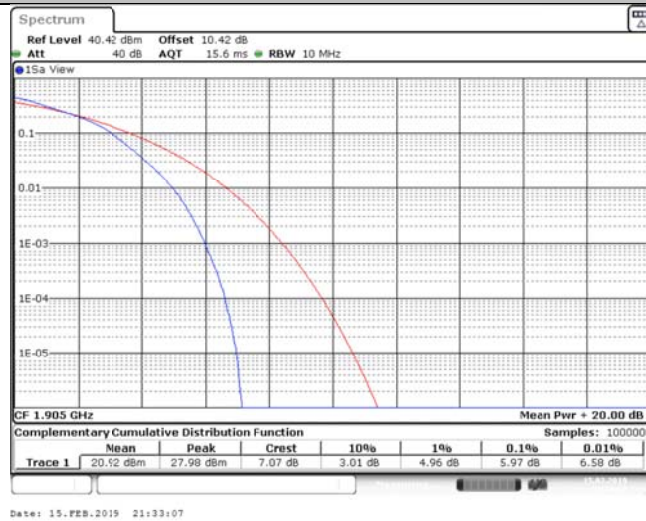

Band2_15MHz_QPSK_18675_1RB#0

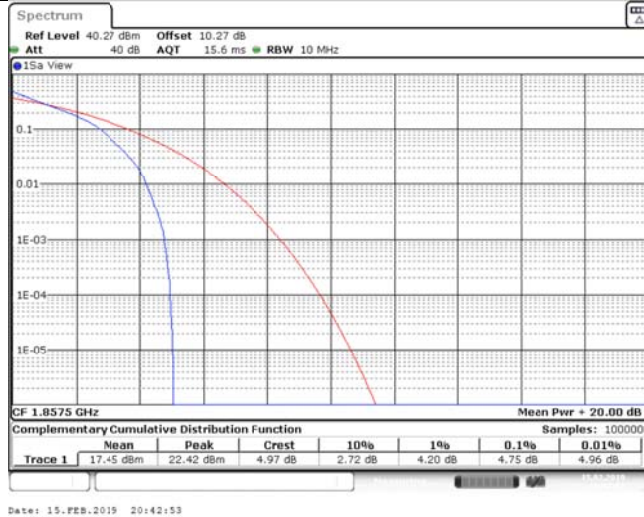

Band2_15MHz_QPSK_18675_75RB#0

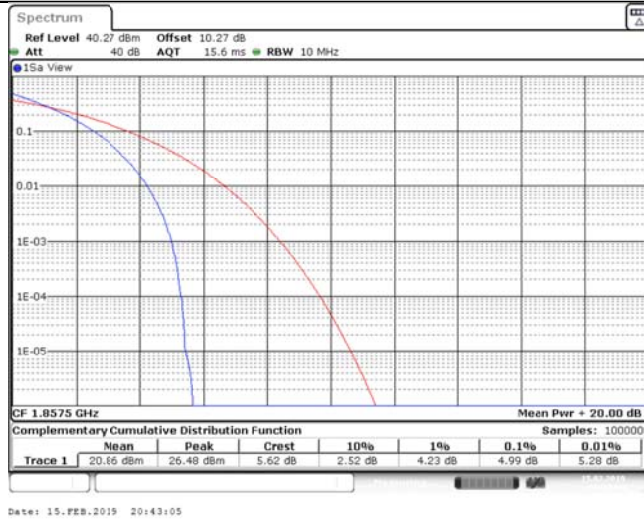

Band2_15MHz_QPSK_18900_1RB#0

