

Spectrum Report (LTE)

Applicant: Mikrotiks SIA
Address of Applicant: Brivibas gatve 214i, Riga, LV-1039 LATVIA
Manufacturer/Factory: Shanghai Notion information technology CO. LTD
Address of Manufacturer/Factory: Room 501, Building 5, NO 289, Bisheng Rd, Pudong district, Shanghai, China
Equipment Under Test (EUT)
Product Name: Mini-pcie card R11e-LTE6
Model No.: R11e-LTE6
Trade Mark: Mikrotik
FCC ID: TV7R11ELTE6
Applicable standards: FCC CFR Title 47 Part 2
FCC CFR Title 47 Part 90(S)
Date of sample receipt: December 14, 2018
Date of Test: December 15, 2018 ~ March 4, 2019
Date of report issued: March 4, 2019
Test Result : PASS *

* In the configuration tested, the EUT complied with the standards specified above.

Authorized Signature:



Robinson Lo

Laboratory Manager

This results shown in this test report refer only to the sample(s) tested, this test report cannot be reproduced, except in full, without prior written permission of the company. The report would be invalid without specific stamp of test institute and the signatures of compiler and approver.

1 Version

Version No.	Date	Description
00	March 4, 2019	Original

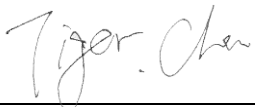
Prepared By:  **Date:** March 4, 2019
Project Engineer

Check By:  **Date:** March 4, 2019
Reviewer

2 Contents

Page

SPECTRUM REPORT (LTE)	1
1 VERSION	2
2 CONTENTS	3
3 TEST SUMMARY	4
3.1 MEASUREMENT UNCERTAINTY	4
4 GENERAL INFORMATION	5
4.1 GENERAL DESCRIPTION OF EUT	5
4.2 RELATED SUBMITTAL(S) / GRANT (S)	6
4.3 TEST METHODOLOGY	6
4.4 TEST FACILITY	6
4.5 TEST LOCATION	6
5 TEST INSTRUMENTS LIST	7
6 SYSTEM TEST CONFIGURATION	8
6.1 TEST MODE	8
6.2 CONFIGURATION OF TESTED SYSTEM	8
6.3 CONDUCTED AVERAGE OUTPUT POWER	9
6.4 ADJACENT CHANNEL POWER	14
6.5 OCCUPY BANDWIDTH	16
6.6 MODULATION CHARACTERISTIC	22
6.7 OUT OF BAND EMISSION AT ANTENNA TERMINALS	22
6.8 FIELD STRENGTH OF SPURIOUS RADIATION MEASUREMENT	35
6.9 FREQUENCY STABILITY V.S. TEMPERATURE MEASUREMENT	43
6.10 FREQUENCY STABILITY V.S. VOLTAGE MEASUREMENT	45
7 TEST SETUP PHOTO	47
8 EUT CONSTRUCTIONAL DETAILS	错误! 未定义书签。

3 Test Summary

Test Item	Section in CFR 47	Result
RF Exposure (SAR)	Part 1.1307 Part 2.1093	Pass* (Please refer to MPE Report)
RF Output Power	Part 2.1046 Part 90.635	Pass
Adjacent channel power	Part 90.221(c)	Pass
Modulation Characteristics	Part 2.1047	N/A
99% & -26 dB Occupied Bandwidth	Part 2.1049 Part 90.209	Pass
Spurious Emissions at Antenna Terminal	Part 2.1051 Part 90.691	Pass
Field Strength of Spurious Radiation	Part 2.1053 Part 90.691	Pass
Out of band emission, Band Edge	Part 2.1051 Part 90.691	Pass
Frequency stability for temperature & voltage	Part 2.1055	Pass

Pass: The EUT complies with the essential requirements in the standard.

N/A: Not applicable.

3.1 Measurement Uncertainty

Test Item	Frequency Range	Measurement Uncertainty	Notes
Radiated Emission	9kHz ~ 30MHz	± 4.34dB	(1)
Radiated Emission	30MHz ~ 1000MHz	± 4.24dB	(1)
Radiated Emission	1GHz ~ 26.5GHz	± 4.68dB	(1)

Note (1): The measurement uncertainty is for coverage factor of k=2 and a level of confidence of 95%.

4 General Information

4.1 General Description of EUT

Product Name:	Mini-pcie card R11e-LTE6
Model No.:	R11e-LTE6
S/N:	AE3903E95BA5
IMEI:	355654090960142
Tested Sample(s) ID:	GTS201812000107-01
Hardware Version:	M26H_1_10
Software Version:	R11e_LTE6
Support Networks:	LTE
Support Bands:	LTE Band 26
Channel Bandwidth:	LTE Band 26: 1.4MHz; 3MHz; 5MHz; 10MHz;
Maximum output power to antenna	23.47dBm
TX Frequency:	LTE Band 26: 814.7MHz-823.3MHz
Modulation type:	QPSK, 16QAM
Power supply:	DC 3.8V

Test antenna specifications:	
Product code	MTAO-LTE-5D-SQ
Wireless band	699-2690MHz
Number of chains	2
Connectors	2 SMA
Antenna type:	Omni
Antenna gain(Band 26):	4.83dBi
Antenna outlook	

4.2 Related Submittal(s) / Grant (s)

This submittal(s) (test report) is filing to comply with Section Part 90 of the FCC CFR 47 Rules.

4.3 Test Methodology

Both conducted and radiated testing were performed according to the procedures document on TIA/EIA 603 and ANSI C63.4, FCC CFR 47.1046, 2.1047, 2.1049, 2.1051, 2.1053, 2.1055 and 2.1057

4.4 Test Facility

The test facility is recognized, certified, or accredited by the following organizations:

- **FCC —Registration No.: 381383**

Global United Technology Services Co., Ltd., Shenzhen EMC Laboratory has been registered and fully described in a report filed with the (FCC) Federal Communications Commission. The acceptance letter from the FCC is maintained in files. Registration 381383.

- **Industry Canada (IC) —Registration No.: 9079A-2**

The 3m Semi-anechoic chamber of Global United Technology Services Co., Ltd. has been registered by Certification and Engineering Bureau of Industry Canada for radio equipment testing with Registration No.: 9079A-2.

- **NVLAP (LAB CODE:600179-0)**

Global United Technology Services Co., Ltd., is accredited by the National Voluntary Laboratory Accreditation Program (NVLAP). LAB CODE:600179-0

- **CNAS (No. CNAS L5775)**

CNAS has accredited Global United Technology Services Co., Ltd., to ISO/IEC 17025:2017 General Requirements for the Competence of Testing and Calibration Laboratories (CNAS-CL01 Accreditation Criteria for the Competence of Testing and Calibration Laboratories) for the competence in the field of testing.

4.5 Test Location

All tests were performed at:

Global United Technology Services Co., Ltd.

Address: No. 301-309, 3/F., Jinyuan Business Building, No.2, Laodong Industrial Zone, Xixiang Road, Baoan District, Shenzhen, Guangdong, China 518102

Tel: 0755-27798480

Fax: 0755-27798960

5 Test Instruments list

Radiated Emission:						
Item	Test Equipment	Manufacturer	Model No.	Inventory No.	Cal.Date (mm-dd-yy)	Cal.Due date (mm-dd-yy)
1	3m Semi- Anechoic Chamber	ZhongYu Electron	9.2(L)*6.2(W)* 6.4(H)	GTS250	July. 03 2015	July. 02 2020
2	Control Room	ZhongYu Electron	6.2(L)*2.5(W)* 2.4(H)	GTS251	N/A	N/A
3	EMI Test Receiver	Rohde & Schwarz	ESU26	GTS203	June. 27 2018	June. 26 2019
4	BiConiLog Antenna	SCHWARZBECK MESS-ELEKTRONIK	VULB9163	GTS214	June. 27 2018	June. 26 2019
5	Double -ridged waveguide horn	SCHWARZBECK MESS-ELEKTRONIK	BBHA 9120 D	GTS208	June. 27 2018	June. 26 2019
6	Horn Antenna	ETS-LINDGREN	3160	GTS217	June. 27 2018	June. 26 2019
7	EMI Test Software	AUDIX	E3	N/A	N/A	N/A
8	Coaxial Cable	GTS	N/A	GTS213	June. 27 2018	June. 26 2019
9	Coaxial Cable	GTS	N/A	GTS211	June. 27 2018	June. 26 2019
10	Coaxial cable	GTS	N/A	GTS210	June. 27 2018	June. 26 2019
11	Coaxial Cable	GTS	N/A	GTS212	June. 27 2018	June. 26 2019
12	Amplifier(100kHz-3GHz)	HP	8347A	GTS204	June. 27 2018	June. 26 2019
13	Amplifier(2GHz-20GHz)	HP	84722A	GTS206	June. 27 2018	June. 26 2019
14	Amplifier (18-26GHz)	Rohde & Schwarz	AFS33-18002 650-30-8P-44	GTS218	June. 27 2018	June. 26 2019
15	Band filter	Amindeon	82346	GTS219	June. 27 2018	June. 26 2019
16	Power Meter	Anritsu	ML2495A	GTS540	June. 27 2018	June. 26 2019
17	Power Sensor	Anritsu	MA2411B	GTS541	June. 27 2018	June. 26 2019
18	Wideband Radio Communication Tester	Rohde & Schwarz	CMW500	GTS575	June. 27 2018	June. 26 2019
19	Splitter	Agilent	11636B	GTS237	June. 27 2018	June. 26 2019
20	Loop Antenna	ZHINAN	ZN30900A	GTS534	June. 27 2018	June. 26 2019

General used equipment:						
Item	Test Equipment	Manufacturer	Model No.	Inventory No.	Cal.Date (mm-dd-yy)	Cal.Due date (mm-dd-yy)
1	Humidity/ Temperature Indicator	KTJ	TA328	GTS243	June. 27 2018	June. 26 2019
2	Barometer	ChangChun	DYM3	GTS255	June. 27 2018	June. 26 2019

6 System test configuration

6.1 Test mode

During all testing, EUT is in link mode with base station emulator at maximum power level. The spurious emission measurements were carried out in semi-anechoic chamber with 3-meter test range, and EUT is rotated on three test planes to find out the worst emission.

Test modes		
Band	Radiated	Conducted
LTE Band 26	■ QPSK and 16QAM link	■ QPSK and 16QAM link

6.2 Configuration of Tested System

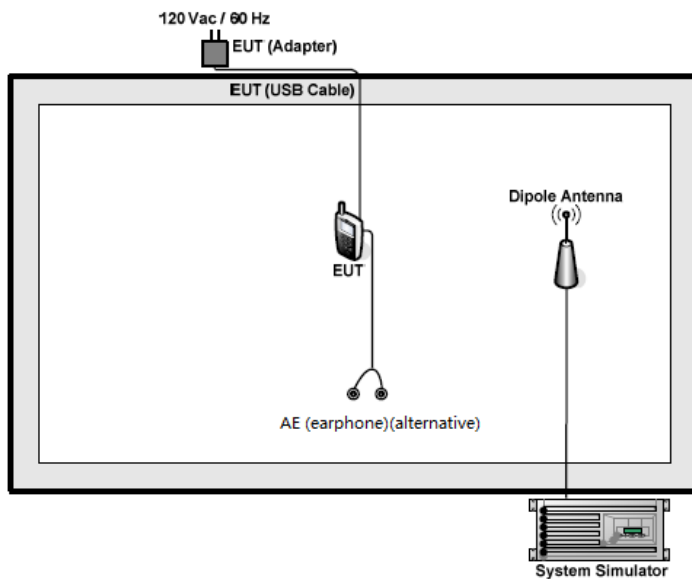

6.3 Conducted Average Output Power

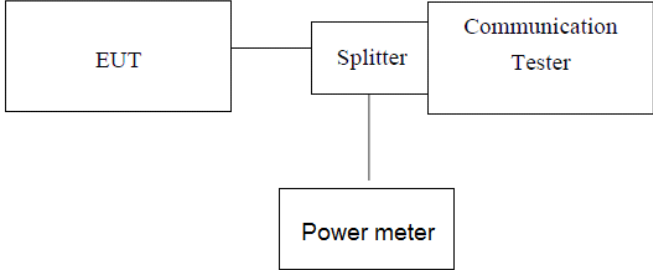
Test Requirement:	Part 90
Limit:	1W
Test setup:	 <p><i>Note: Measurement setup for testing on Antenna connector</i></p>
Test Procedure:	<ol style="list-style-type: none"> 1. The transmitter output port was connected to base station. 2. The RF output of EUT was connected to the power meter by RF cable and attenuator, the path loss was compensated to the results for each measurement. 3. Set EUT at maximum power through base station. 4. Select lowest, middle, and highest channels for each band and different modulation. 5. Measure the maximum burst average power.
Test Instruments:	Refer to section 5.0 for details
Test mode:	Refer to section 6.1 for details
Test results:	Pass

Measurement Data

Band 26						
Bandwidth	Mode	RB Size	RB Offset	Actual output power(dBm)		
				Channel 26697 814.7MHz	Channel 26740 819.0MHz	Channel 26783 823.3MHz
1.4MHz	QPSK	1	0	22.51	22.39	22.43
		1	2	22.64	22.08	22.11
		1	5	22.64	22.06	22.30
		3	0	22.29	22.16	22.14
		3	1	22.30	22.97	22.55
		3	2	22.58	22.73	22.94
		6	0	22.96	22.46	22.26
	16QAM	1	0	21.74	21.13	21.54
		1	2	21.35	21.53	22.00
		1	5	21.88	21.14	21.45
		3	0	21.26	21.24	21.25
		3	1	21.81	21.43	21.43
		3	2	21.56	21.78	21.65
		6	0	21.70	21.35	21.03
Bandwidth	Mode	RB Size	RB Offset	Actual output power(dBm)		
				Channel 26705 815.5MHz	Channel 26740 819.0MHz	Channel 26775 822.5MHz
3MHz	QPSK	1	0	22.46	22.38	22.33
		1	8	22.29	22.67	22.74
		1	14	22.80	22.65	22.15
		8	0	22.79	22.52	22.54
		8	4	22.80	22.20	22.45
		8	7	22.53	22.50	22.93
		15	0	22.84	22.03	22.77
	16QAM	1	0	21.76	21.69	21.91
		1	8	21.11	21.14	21.77
		1	14	21.47	21.39	21.58
		8	0	21.03	21.68	21.74
		8	4	21.29	21.48	21.37
		8	7	21.80	21.07	21.87
		15	0	21.55	21.93	21.81

Bandwidth	Mode	RB Size	RB Offset	Actual output power(dBm)		
				Channel 26715 816.5MHz	Channel 26740 819.0MHz	Channel 26765 821.5MHz
5MHz	QPSK	1	0	22.76	22.73	22.56
		1	13	21.72	21.40	21.19
		1	24	21.44	21.61	22.73
		12	0	21.30	22.75	22.63
		12	6	21.76	22.28	22.26
		12	13	21.83	22.22	22.98
		25	0	23.47	23.08	22.99
	16QAM	1	0	21.73	21.72	21.81
		1	13	22.90	22.44	21.86
		1	24	21.98	22.13	21.68
		12	0	22.05	22.27	21.43
		12	6	21.84	22.13	21.66
		12	13	22.76	22.02	22.06
		25	0	23.28	22.56	22.71
Bandwidth	Mode	RB Size	RB Offset	Actual output power(dBm)		
10MHz	QPSK	1	0		22.57	
		1	25		22.07	
		1	49		22.40	
		25	0		22.26	
		25	13		22.90	
		25	25		22.51	
		50	0		22.01	
	16QAM	1	0		21.76	
		1	25		21.66	
		1	49		21.55	
		25	0		21.36	
		25	13		21.99	
		25	25		21.50	
		50	0		21.97	

ERP

Band 26						
Bandwidth	Mode	RB Size	RB Offset	Actual output power(dBm)		
				Channel 26697 814.7MHz	Channel 26740 819.0MHz	Channel 26783 823.3MHz
1.4MHz	QPSK	1	0	25.19	25.07	25.11
		1	2	25.32	24.76	24.79
		1	5	25.32	24.74	24.98
		3	0	24.97	24.84	24.82
		3	1	24.98	25.65	25.23
		3	2	25.26	25.41	25.62
		6	0	25.64	25.14	24.94
	16QAM	1	0	24.42	23.81	24.22
		1	2	24.03	24.21	24.68
		1	5	24.56	23.82	24.13
		3	0	23.94	23.92	23.93
		3	1	24.49	24.11	24.11
		3	2	24.24	24.46	24.33
		6	0	24.38	24.03	23.71
Bandwidth	Mode	RB Size	RB Offset	Actual output power(dBm)		
				Channel 26705 815.5MHz	Channel 26740 819.0MHz	Channel 26775 822.5MHz
3MHz	QPSK	1	0	25.14	25.06	25.01
		1	8	24.97	25.35	25.42
		1	14	25.48	25.33	24.83
		8	0	25.47	25.2	25.22
		8	4	25.48	24.88	25.13
		8	7	25.21	25.18	25.61
		15	0	25.52	24.71	25.45
	16QAM	1	0	24.44	24.37	24.59
		1	8	23.79	23.82	24.45
		1	14	24.15	24.07	24.26
		8	0	23.71	24.36	24.42
		8	4	23.97	24.16	24.05
		8	7	24.48	23.75	24.55
		15	0	24.23	24.61	24.49

Bandwidth	Mode	RB Size	RB Offset	Actual output power(dBm)		
				Channel 26715 816.5MHz	Channel 26740 819.0MHz	Channel 26765 821.5MHz
5MHz	QPSK	1	0	25.44	25.41	25.24
		1	13	24.4	24.08	23.87
		1	24	24.12	24.29	25.41
		12	0	23.98	25.43	25.31
		12	6	24.44	24.96	24.94
		12	13	24.51	24.9	25.66
		25	0	26.15	25.76	25.67
	16QAM	1	0	24.41	24.4	24.49
		1	13	25.58	25.12	24.54
		1	24	24.66	24.81	24.36
		12	0	24.73	24.95	24.11
		12	6	24.52	24.81	24.34
		12	13	25.44	24.7	24.74
		25	0	25.96	25.24	25.39
Bandwidth	Mode	RB Size	RB Offset	Actual output power(dBm)		
10MHz	QPSK	1	0		25.25	
		1	25		24.75	
		1	49		25.08	
		25	0		24.94	
		25	13		25.58	
		25	25		25.19	
		50	0		24.69	
	16QAM	1	0		24.44	
		1	25		24.34	
		1	49		24.23	
		25	0		24.04	
		25	13		24.67	
		25	25		24.18	
		50	0		24.65	

6.4 Adjacent channel power

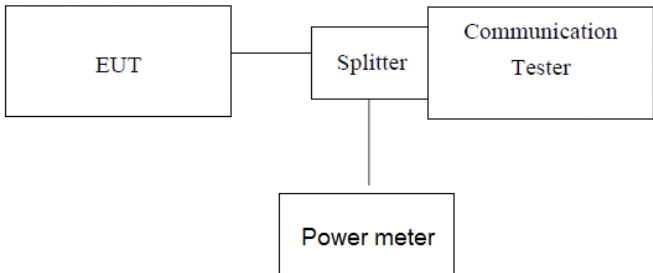
Test Requirement:	Part 90.221	
Limit:	Frequency offset	Maximum ACP (dBc) for devices less than 15 watts
	25kHz	-55dBc
	50kHz	-65dBc
	75kHz	-65dBc
Test setup:	 <p style="text-align: center;"><i>Note: Measurement setup for testing on Antenna connector</i></p>	
Test Procedure:	<ol style="list-style-type: none"> 6. The transmitter output port was connected to base station. 7. The RF output of EUT was connected to the power meter by RF cable and attenuator, the path loss was compensated to the results for each measurement. 8. Set EUT at maximum power through base station. 9. Select lowest, middle, and highest channels for each band and different modulation. 10. Measure the adjacent power levels. 	
Test Instruments:	Refer to section 5.0 for details	
Test mode:	Refer to section 6.1 for details	
Test results:	Pass	

Measurement data:

EUT Mode	Channel Bandwidth	Channel	RB Configure		Maximum ACP(dBc)		
			RB Size	RB Offset	25kHz	50kHz	75kHz
LTE Band 26	1.4MHz	Low range	6	0	-62.33	-69.81	-70.45
		Mid range	6	0	-62.34	-69.73	-70.66
		High range	6	0	-61.07	-70.58	-70.42
	3MHz	Low range	15	0	-61.54	-69.87	-71.47
		Mid range	15	0	-61.73	-71.55	-70.89
		High range	15	0	-61.36	-70.54	-70.94
	5MHz	Low range	25	0	-62.94	-73.05	-73.38
		Mid range	25	0	-64.07	-72.16	-72.81
		High range	25	0	-64.36	-69.62	-73.74
	10MHz	Mid range	50	0	-61.98	-69.95	-71.24

6.5 Occupancy Bandwidth

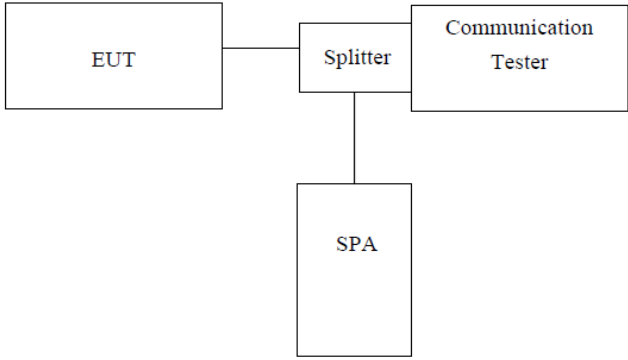
Test Requirement :	Part 90.209
Test setup:	 <p style="text-align: center;"><i>Note: Measurement setup for testing on Antenna connector</i></p>
Test Procedure:	<ol style="list-style-type: none"> 1. The EUT's output RF connector was connected with a short cable to the spectrum analyzer 2. RBW was set to about 1% of emission BW, VBW= 3 times RBW. 3. -26dBc display line was placed on the screen (or 99% bandwidth), the occupied bandwidth is the delta frequency between the two points where the display line intersects the signal trace.
Test Instruments:	Refer to section 5.0 for details
Test mode:	Refer to section 6.1 for details
Test results:	Pass

Measurement Data

EUT Mode	Channel Bandwidth	Channel	RB Configure		-26dB bandwidth (MHz)	
			RB Size	RB Offset	QPSK	16QAM
LTE Band 26	1.4MHz	Low range	6	0	1.644	1.712
		Mid range	6	0	1.694	1.690
		High range	6	0	1.593	1.674
	3MHz	Low range	15	0	3.369	3.404
		Mid range	15	0	3.374	3.404
		High range	15	0	3.192	3.207
	5MHz	Low range	25	0	5.530	5.328
		Mid range	25	0	5.412	5.422
		High range	25	0	5.572	5.551
	10MHz	Mid range	50	0	10.190	10.359

EUT Mode	Channel Bandwidth	Channel	RB Configure		99% OBW (MHz)	
			RB Size	RB Offset	QPSK	16QAM
LTE Band 26	1.4MHz	Low range	6	0	1.1347	1.1332
		Mid range	6	0	1.1285	1.1216
		High range	6	0	1.1255	1.1282
	3MHz	Low range	15	0	2.6914	2.6956
		Mid range	15	0	2.6978	2.6925
		High range	15	0	2.6957	2.6921
	5MHz	Low range	25	0	4.5375	4.5353
		Mid range	25	0	4.5370	4.5572
		High range	25	0	4.5278	4.5331
	10MHz	Mid range	50	0	8.9726	8.9882

Test plot as follows:

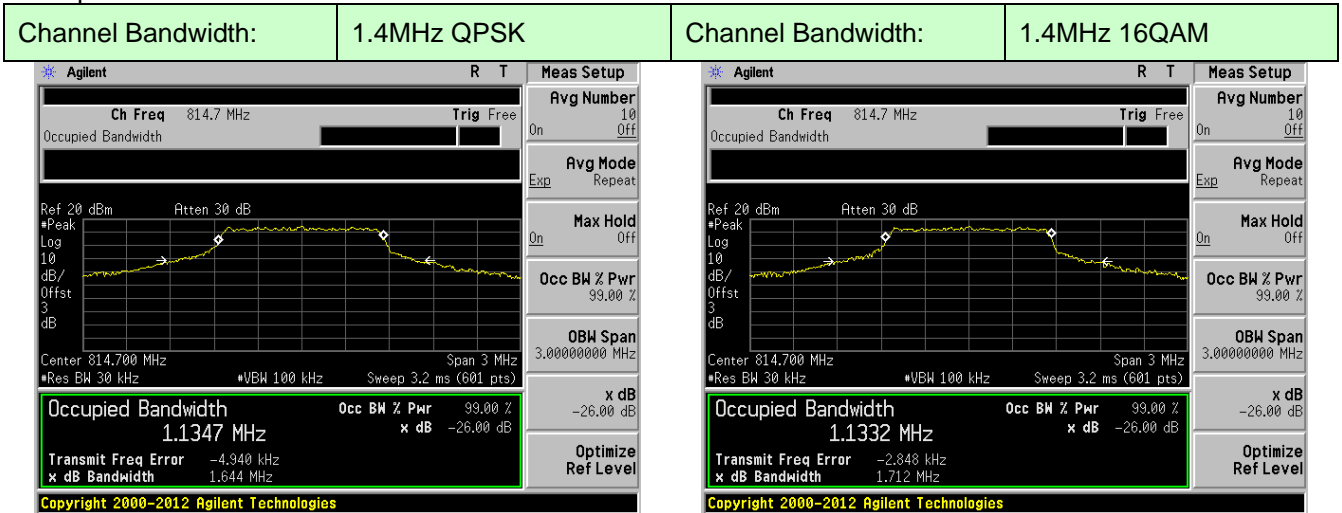

Lowest channel

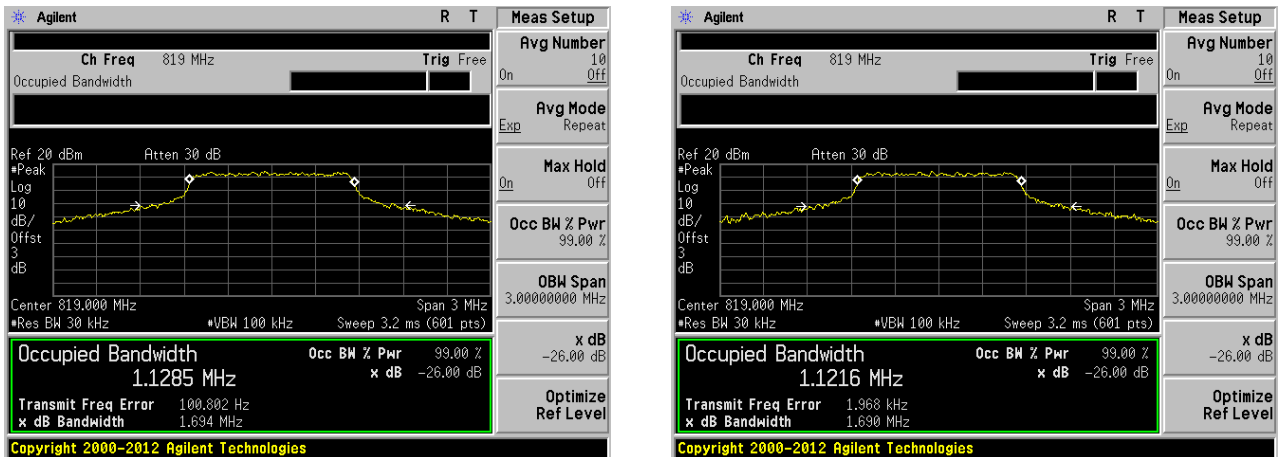

Middle channel

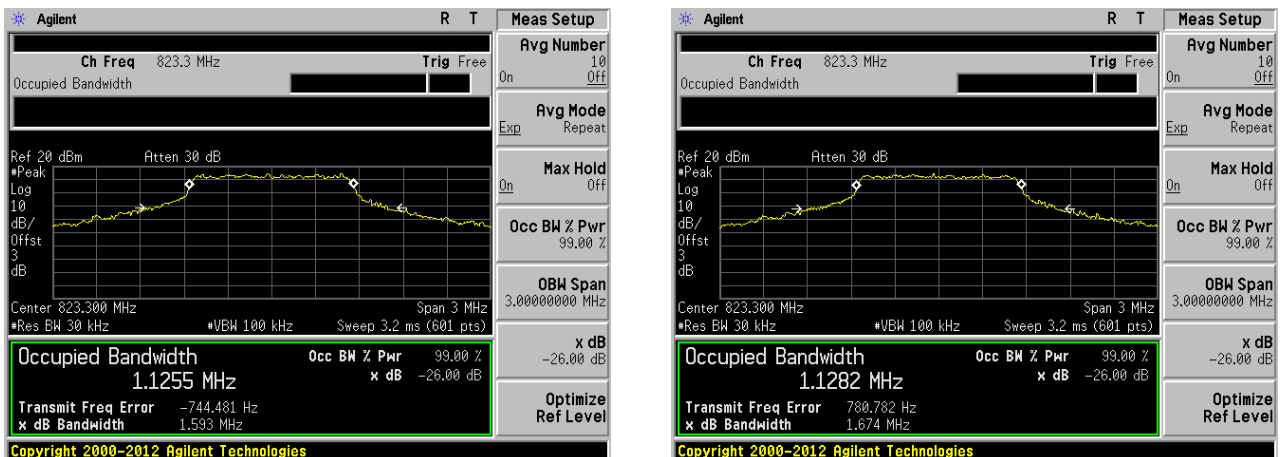

Highest channel

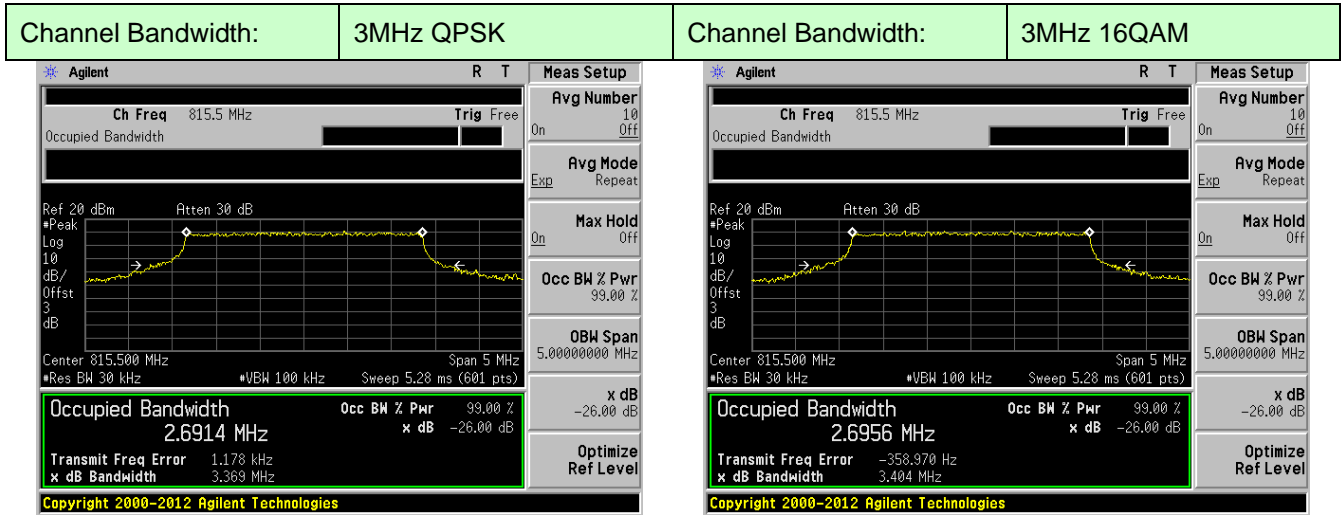

Lowest channel

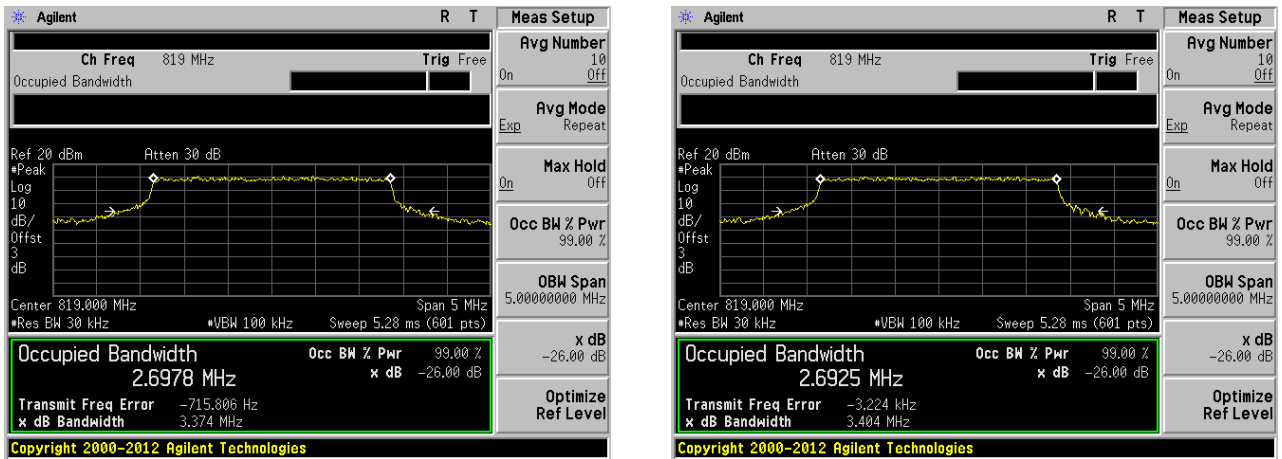

Middle channel

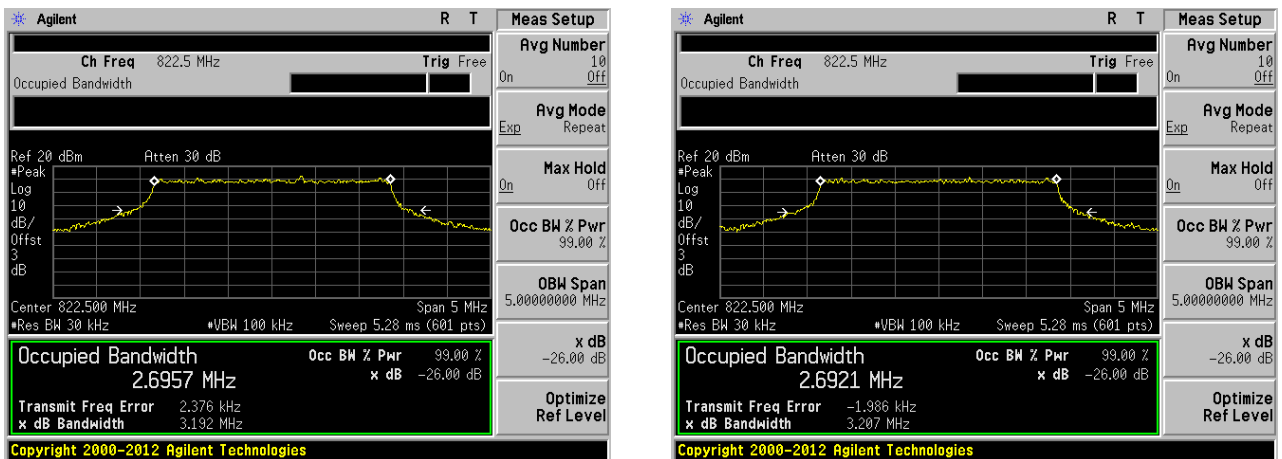

Highest channel

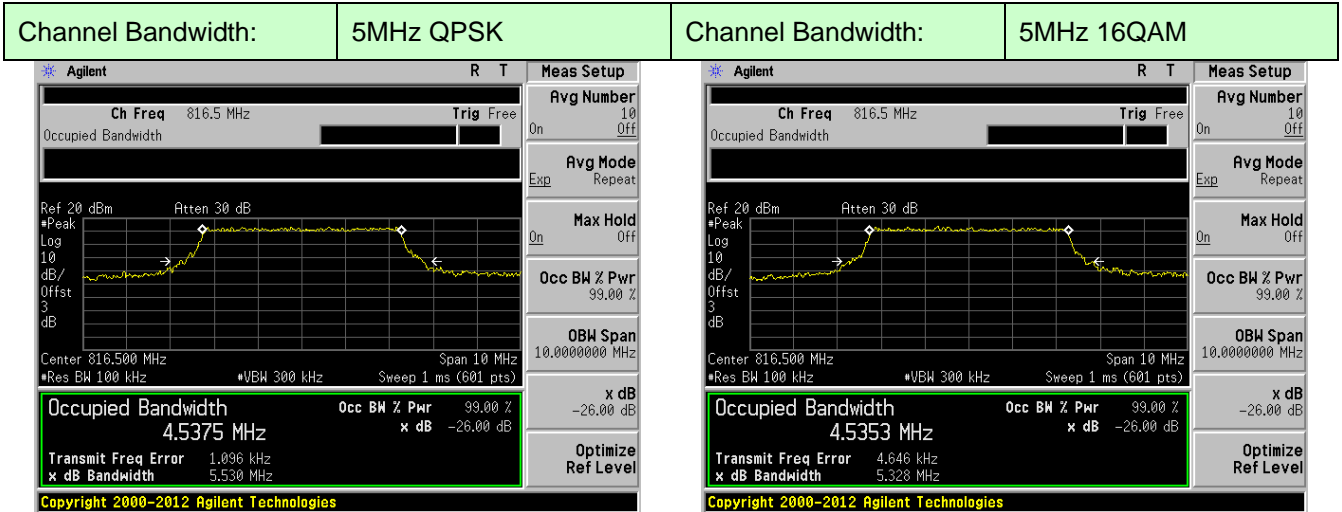

Lowest channel

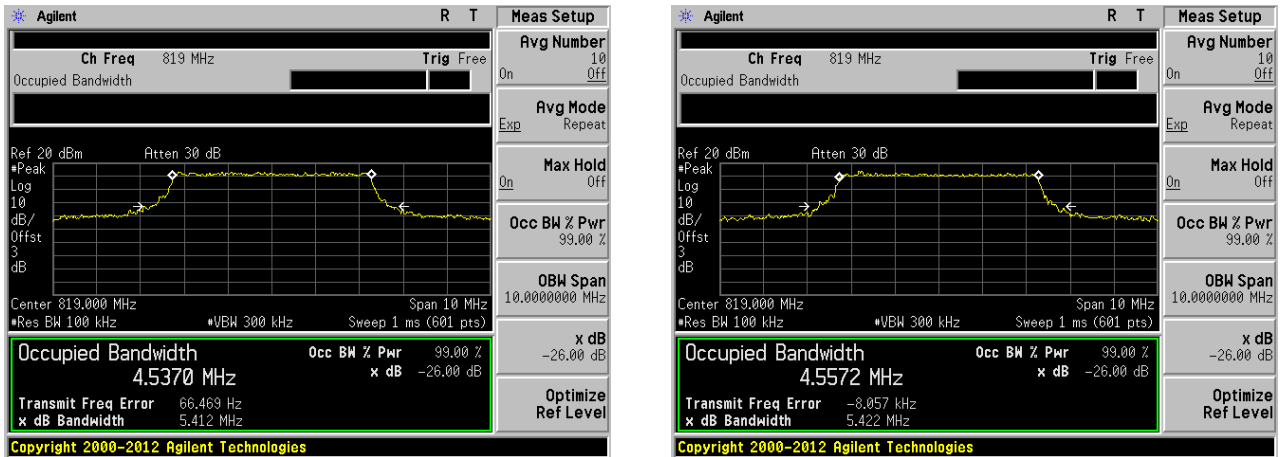

Middle channel

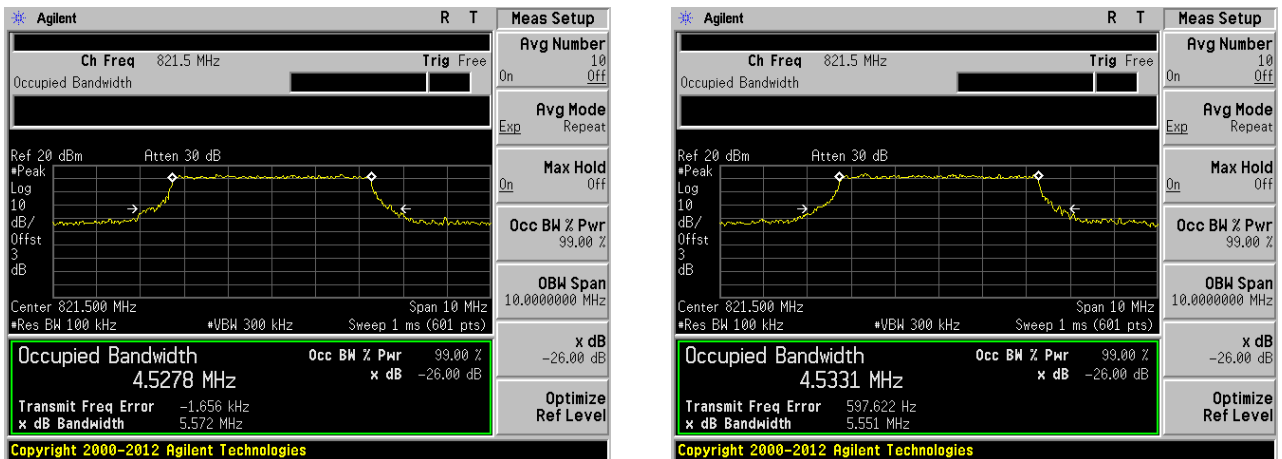

Highest channel

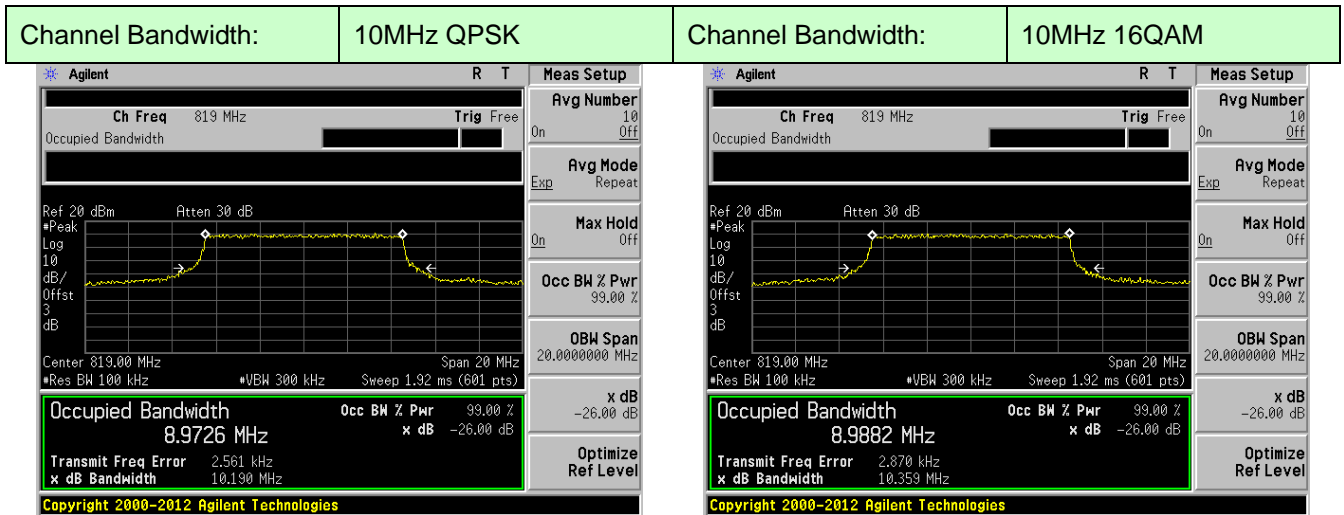

Middle channel

6.6 MODULATION CHARACTERISTIC

According to FCC § 2.1047(d), Part 27 there is no specific requirement for digital modulation, therefore modulation characteristic is not presented.

6.7 Out of band emission at antenna terminals

Test Requirement :	Part 90.691
Limit:	-13dBm
Test setup:	<pre> graph LR EUT[EUT] --- Splitter[Splitter] Splitter --- CT[Communication Tester] Splitter --- Filter[Filter] Filter --- SPA[SPA] </pre> <p><i>Note: Measurement setup for testing on Antenna connector</i></p>
Test Procedure:	<ol style="list-style-type: none"> 1 The RF output of the transceiver was connected to a spectrum analyzer through appropriate attenuation. 2 The resolution bandwidth of the spectrum analyzer was set at 1MHz, sufficient scans were taken to show the out of band Emissions if any up to 10th harmonic. 3 For the out of band: Set the RBW, VBW = 1MHz, Start=30MHz, Stop= 10th harmonic. 4 Band Edge Requirements: In the 1 MHz bands immediately outside and adjacent to the frequency block, a resolution bandwidth of at least 1 percent of the emission bandwidth of the fundamental emission of the transmitter may be employed to measure the out of band Emissions.
Test Instruments:	Refer to section 5.0 for details
Test mode:	Refer to section 6.1 for details
Test results:	Pass

Test plot as follows:

Test Mode: LTE Band 26 Channel Bandwidth: 1.4MHz

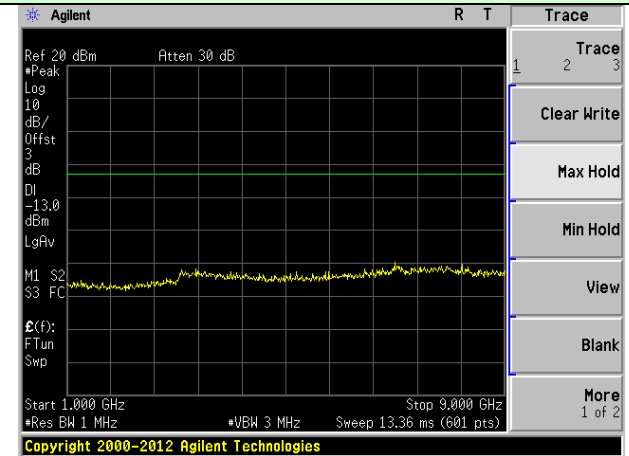
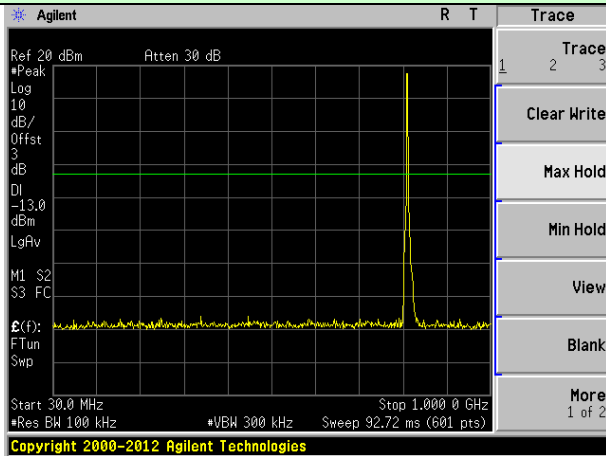

Lowest channel

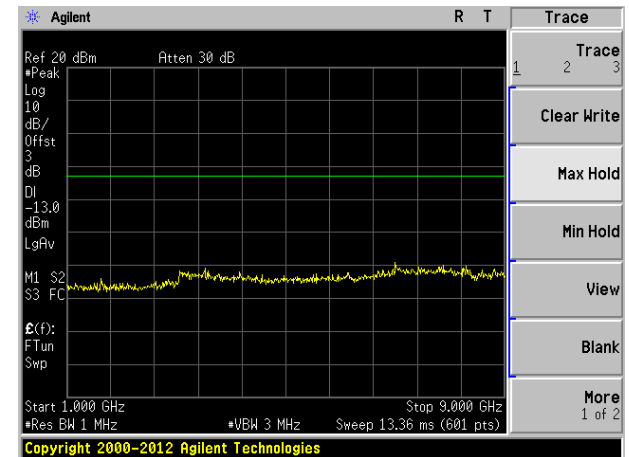
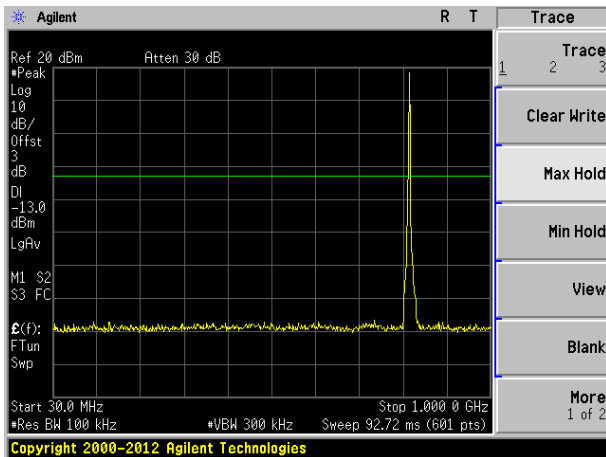

Middle channel

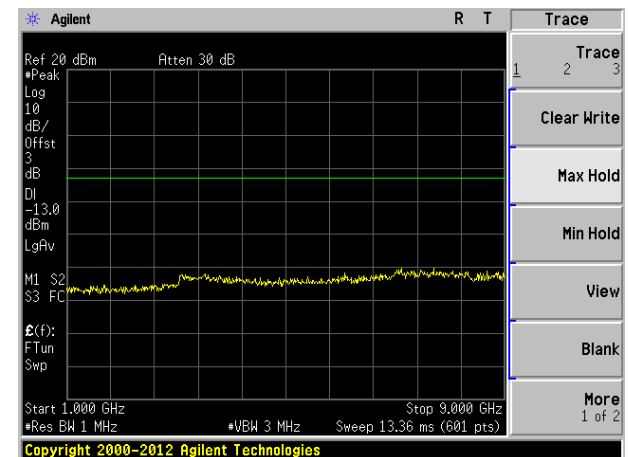
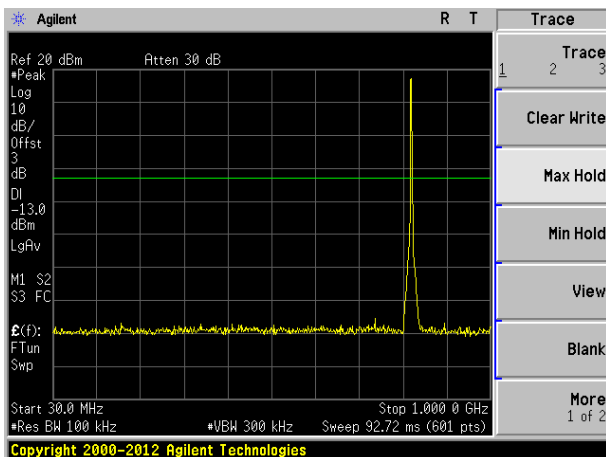

Highest channel

Test Mode: LTE Band 26

Channel Bandwidth: 3MHz

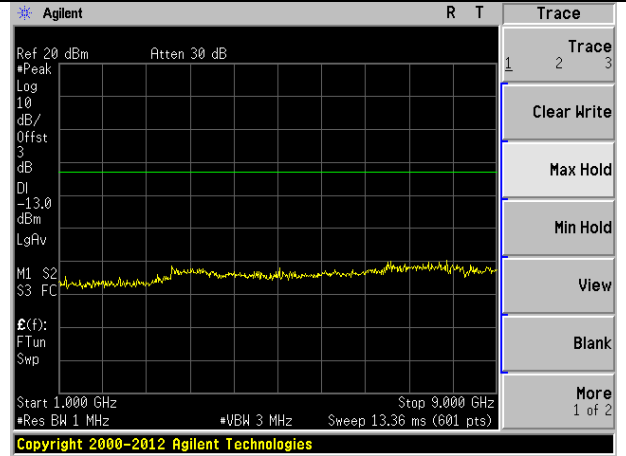
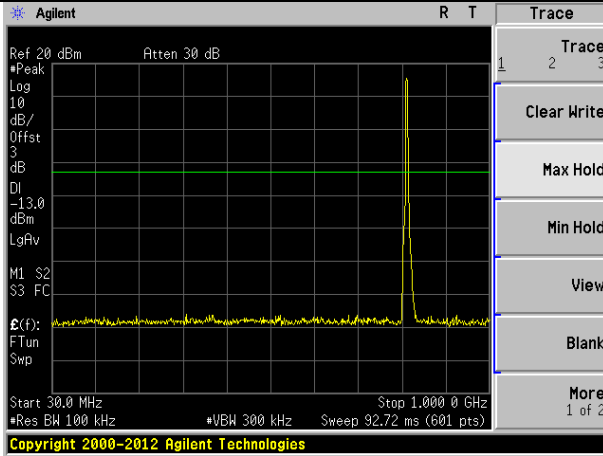

Lowest channel

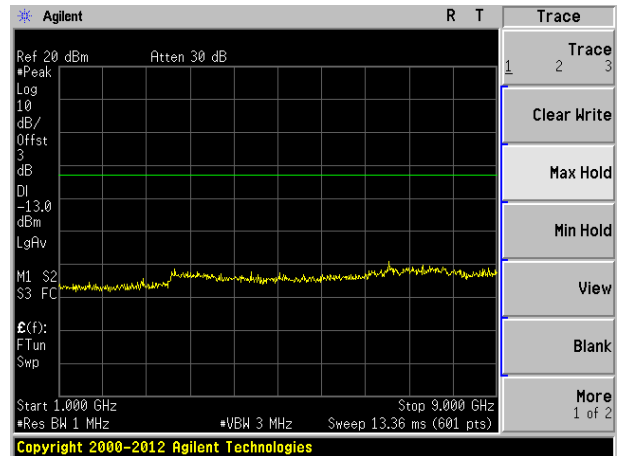
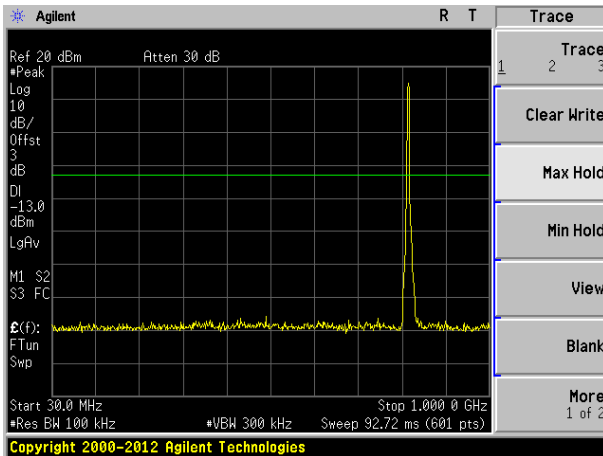

Middle channel

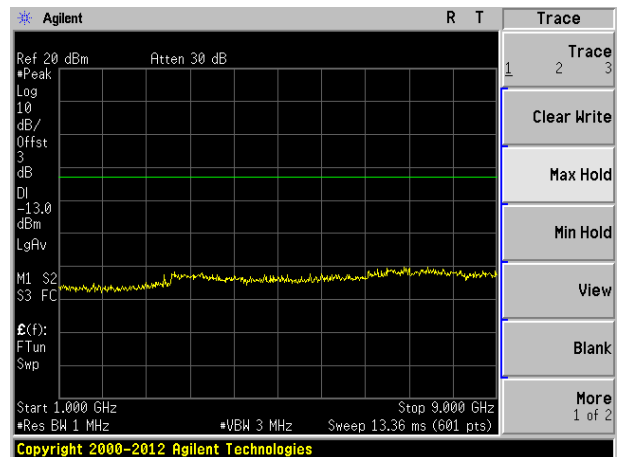
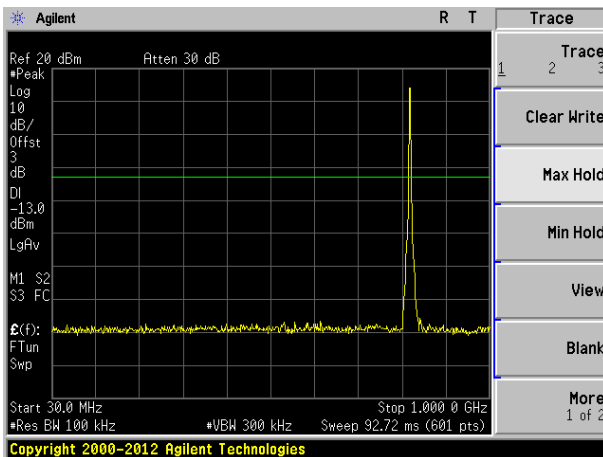

Highest channel

Test Mode: LTE Band 26

Channel Bandwidth: 5MHz

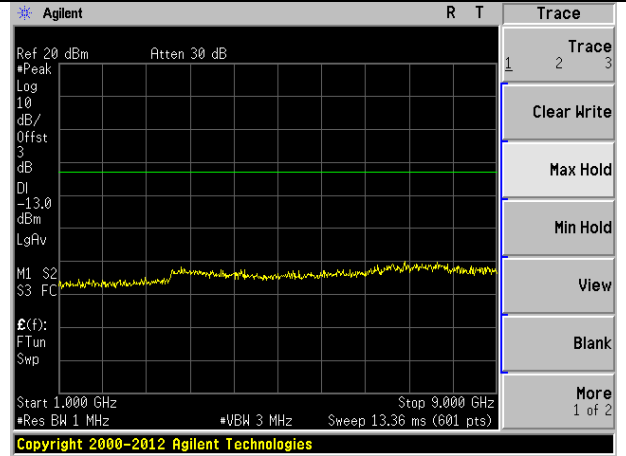
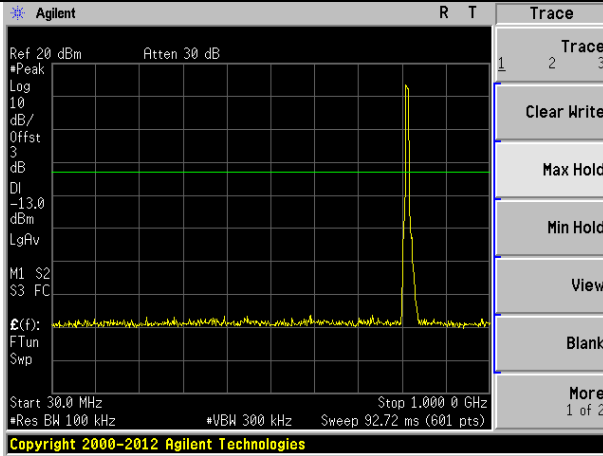

Lowest channel

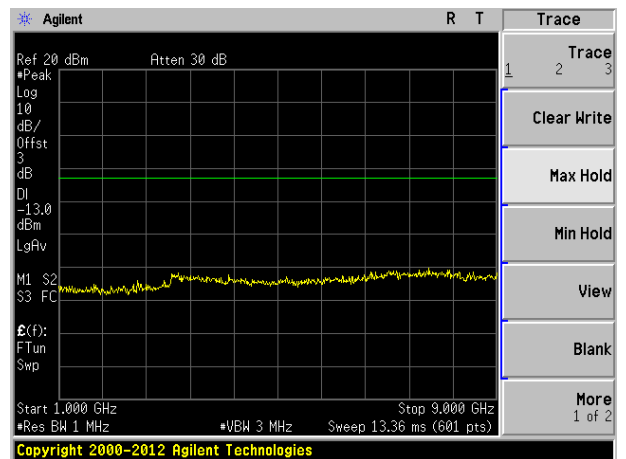
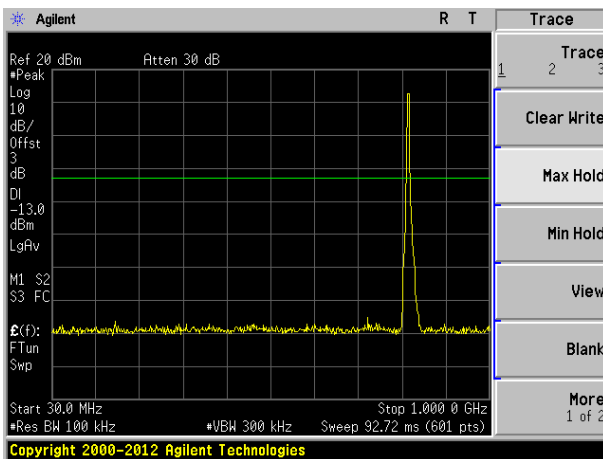

Middle channel

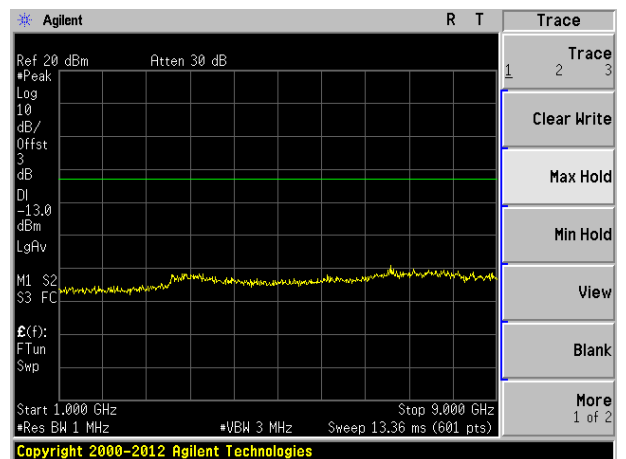
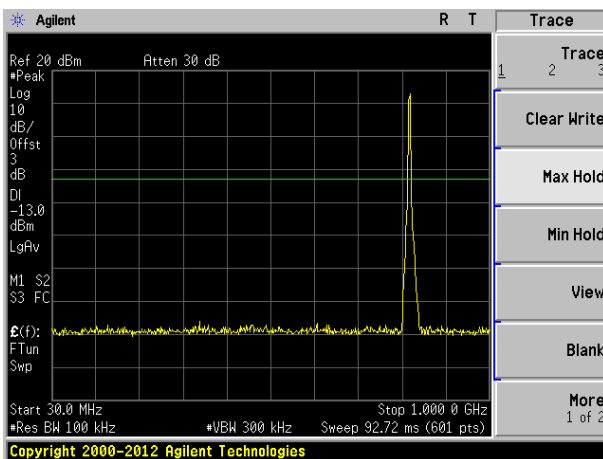

Highest channel

Test Mode: LTE Band 26 Channel Bandwidth: 10MHz

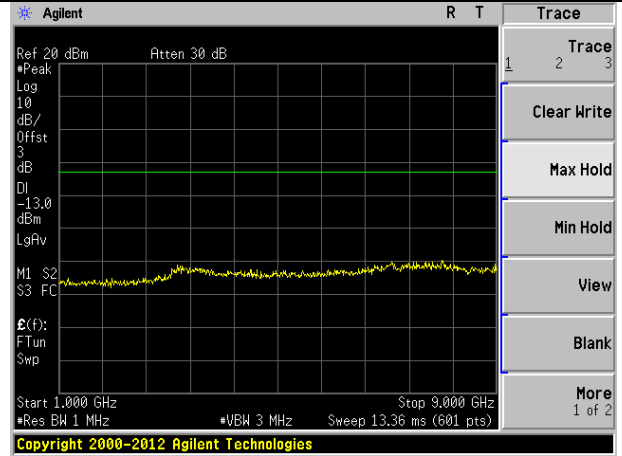
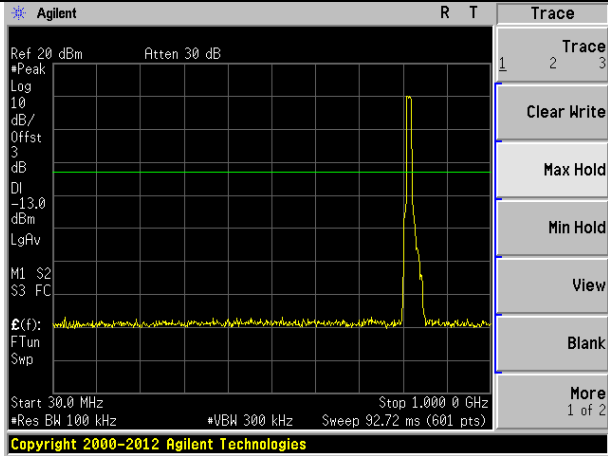

Middle channel

**Band Edge:
QPSK mode:**

1.4MHz Bandwidth (RB size:1# RB offset:0#)

1.4MHz Bandwidth (RB size:1# RB offset:5#)

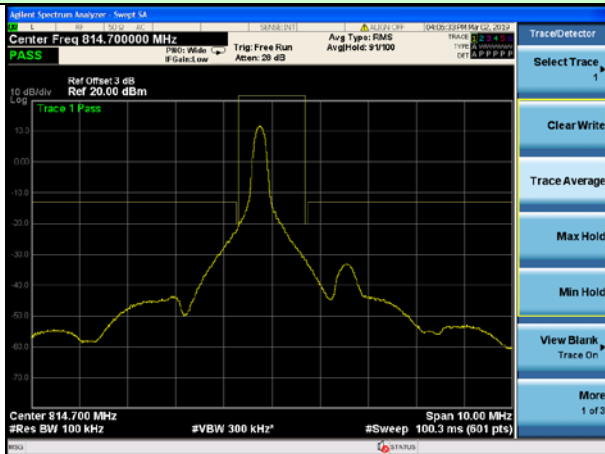

Lowest channel

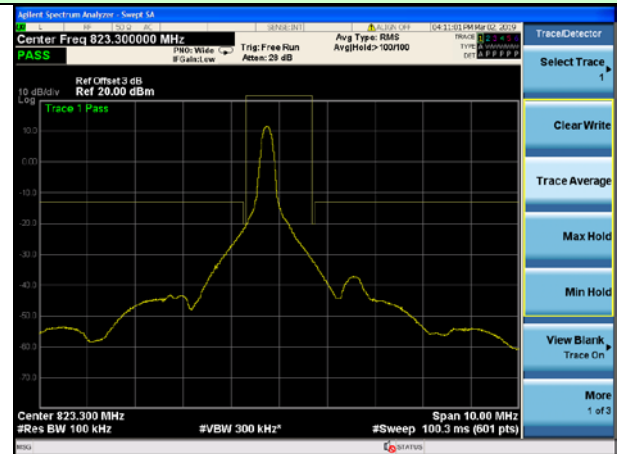

Highest channel

1.4MHz Bandwidth (RB size:3# RB offset:0#)

1.4MHz Bandwidth (RB size:3# RB offset:2#)

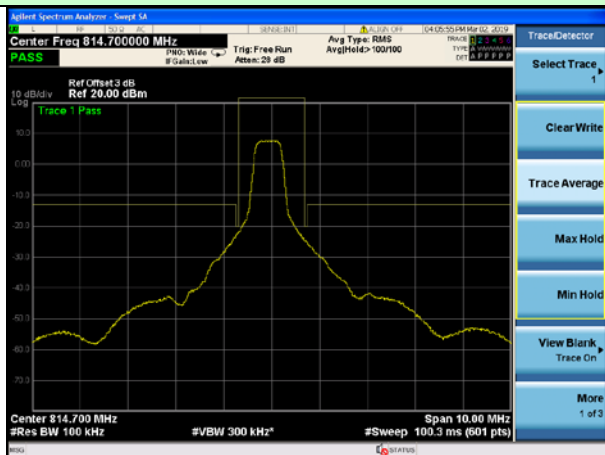

Lowest channel

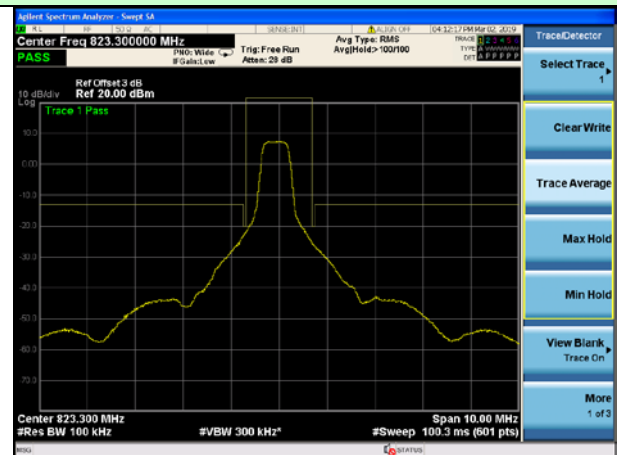

Highest channel

1.4MHz Bandwidth (RB size:6# RB offset:0#)

1.4MHz Bandwidth (RB size:6# RB offset:0#)

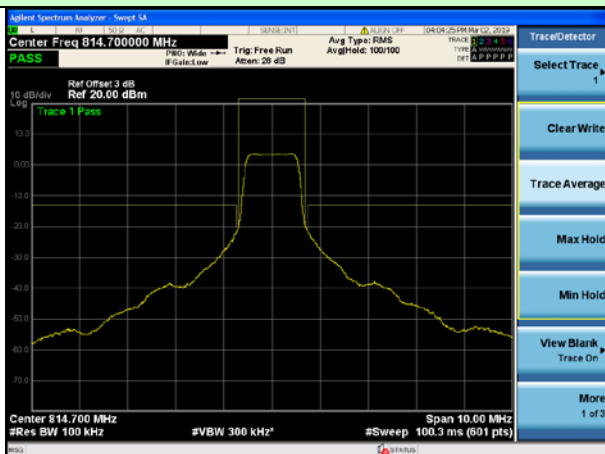

Lowest channel

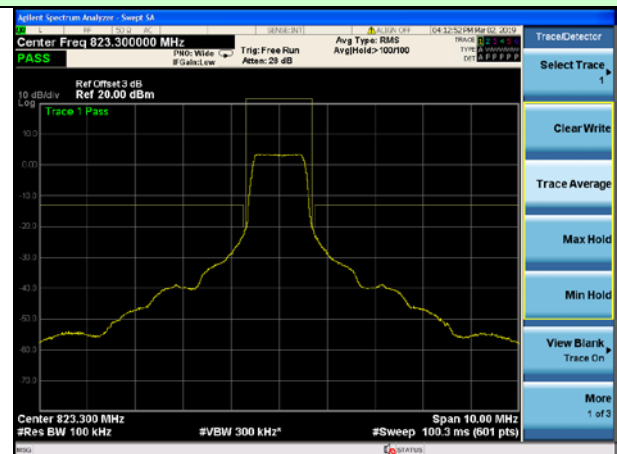

Highest channel

3MHz Bandwidth (RB size:1# RB offset:0#)

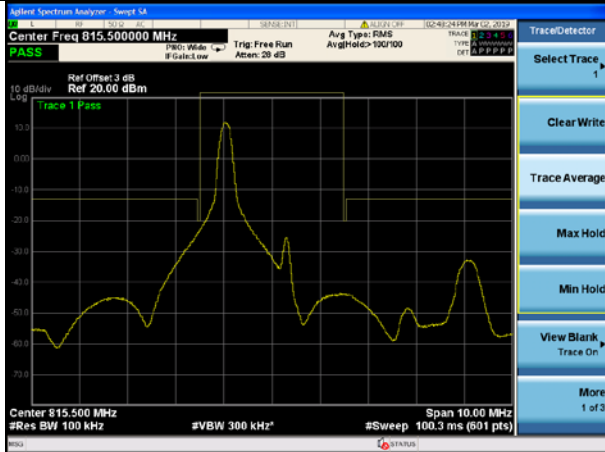

Lowest channel

3MHz Bandwidth (RB size:1# RB offset:14#)

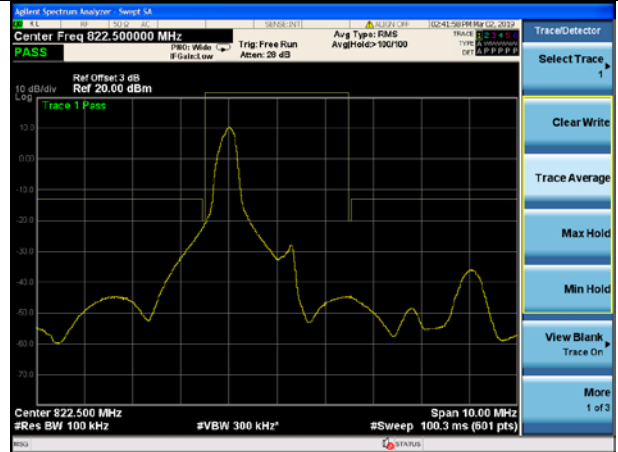

Highest channel

3MHz Bandwidth (RB size:8# RB offset:0#)

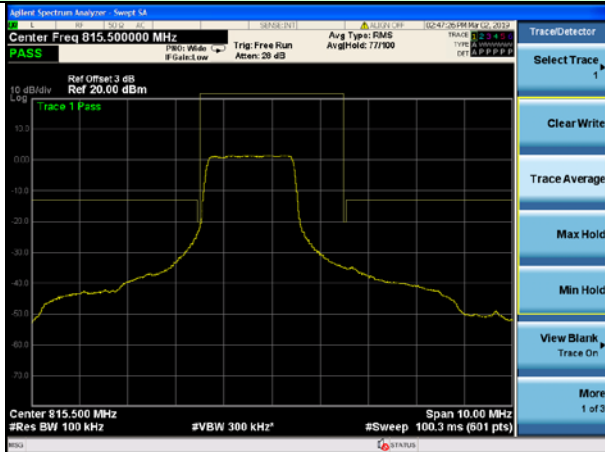

Lowest channel

3MHz Bandwidth (RB size:8# RB offset:7#)

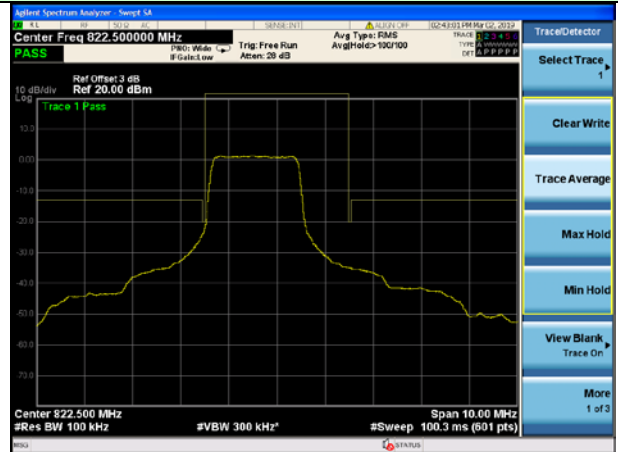

Highest channel

3MHz Bandwidth (RB size:15# RB offset:0#)

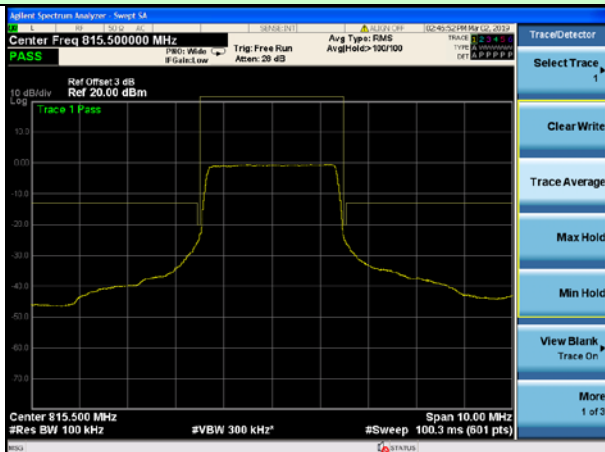

Lowest channel

3MHz Bandwidth (RB size:15# RB offset:0#)

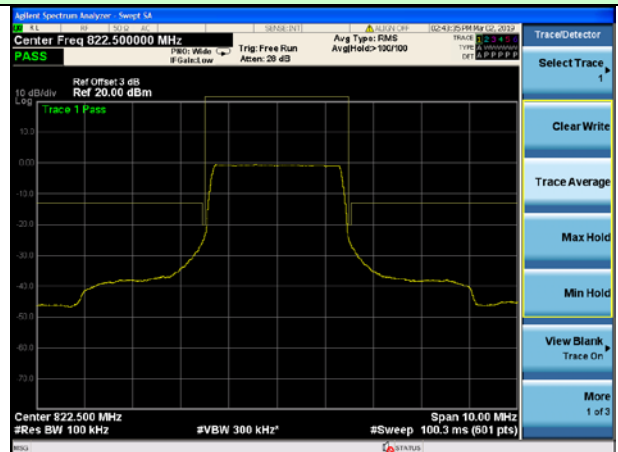

Highest channel

5MHz Bandwidth (RB size:1# RB offset:0#) 5MHz Bandwidth (RB size:1# RB offset:24#)

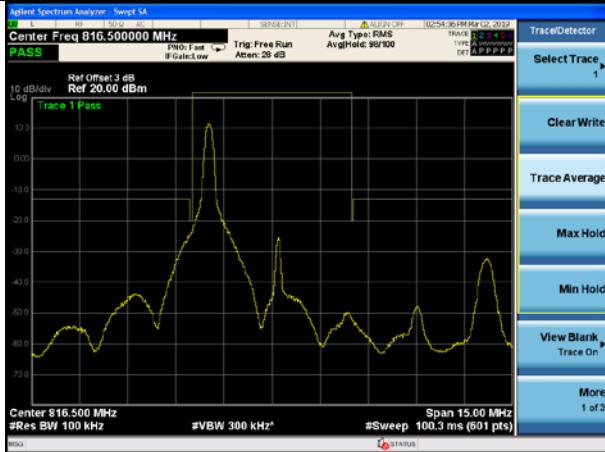

Lowest channel

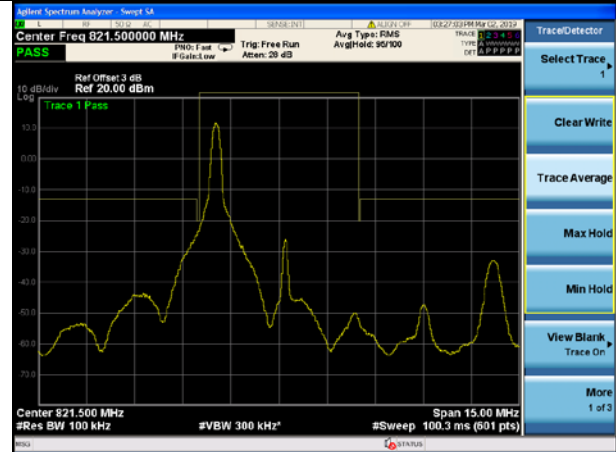

Highest channel

5MHz Bandwidth (RB size:12# RB offset:0#) 5MHz Bandwidth (RB size:12# RB offset:13#)

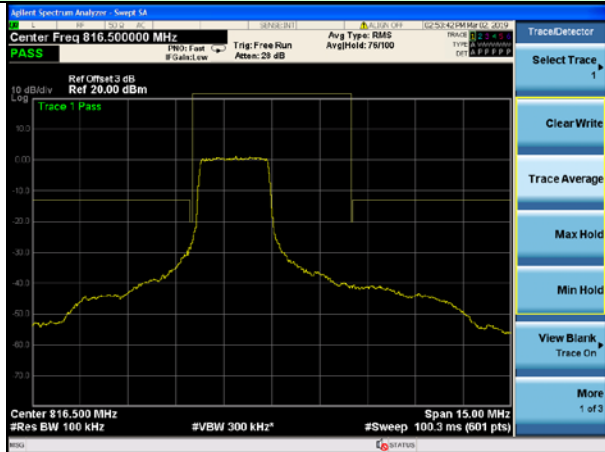

Lowest channel

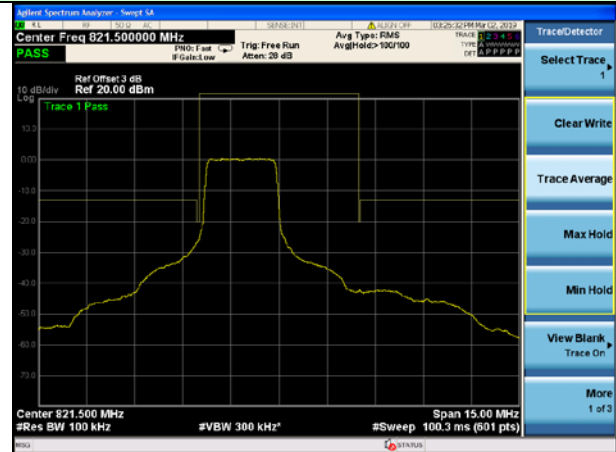

Highest channel

5MHz Bandwidth (RB size:25# RB offset:0#) 5MHz Bandwidth (RB size:25# RB offset:0#)

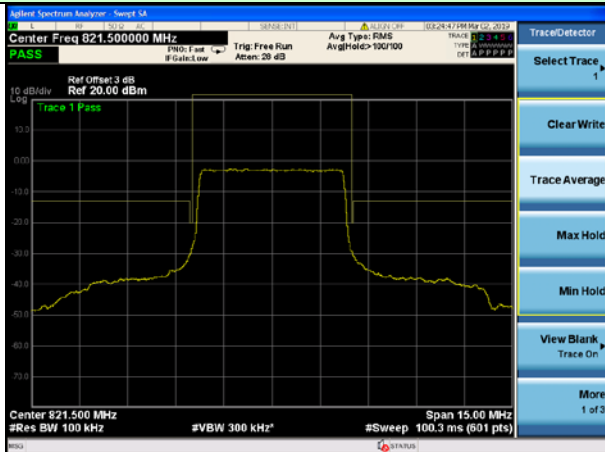

Lowest channel

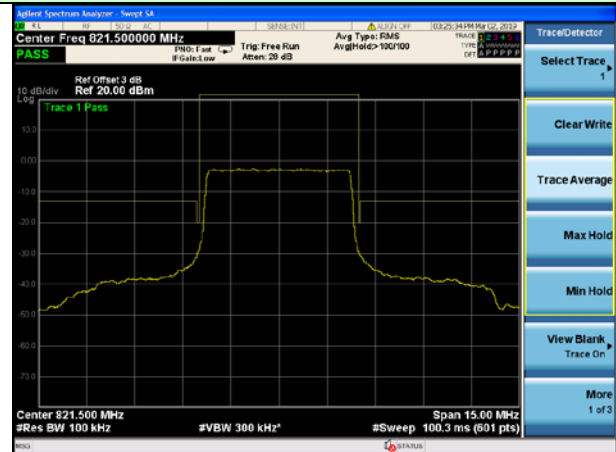

Highest channel

10MHz Bandwidth (RB size:1# RB offset:0#)

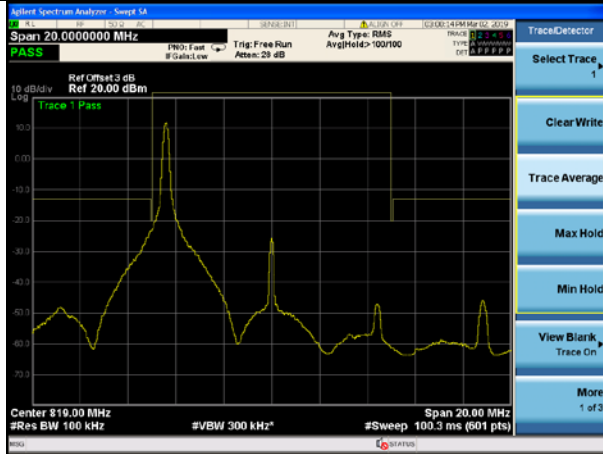

Middle channel

10MHz Bandwidth (RB size:25# RB offset:0#)

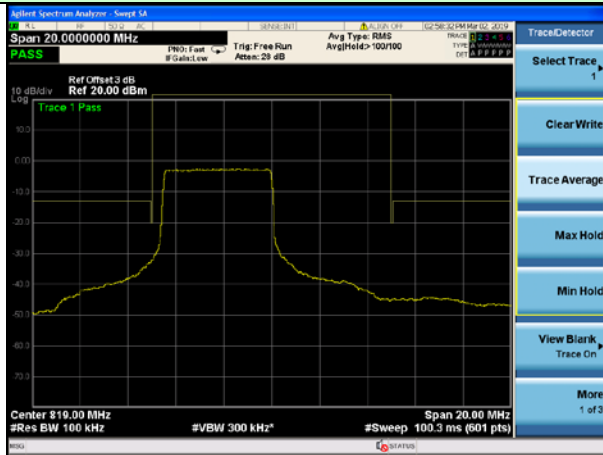

Middle channel

10MHz Bandwidth (RB size:50# RB offset:0#)

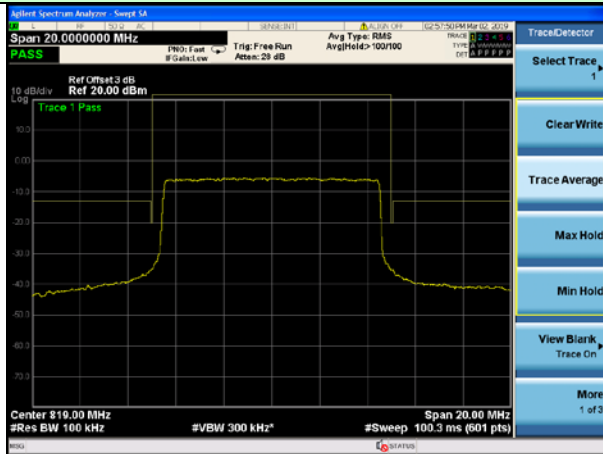

Middle channel

16QAM mode:

1.4MHz Bandwidth (RB size:1# RB offset:0#)

1.4MHz Bandwidth (RB size:1# RB offset:5#)

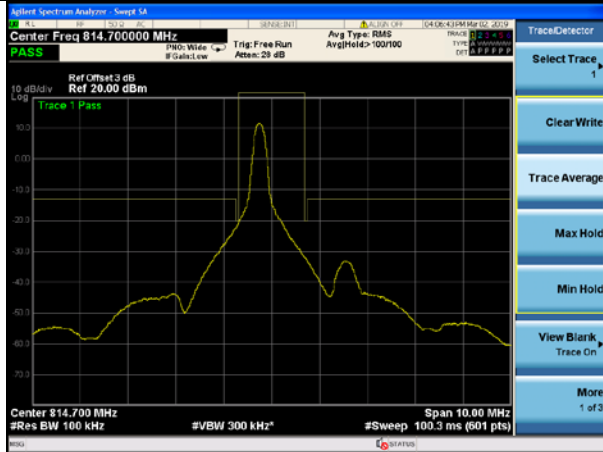

Lowest channel

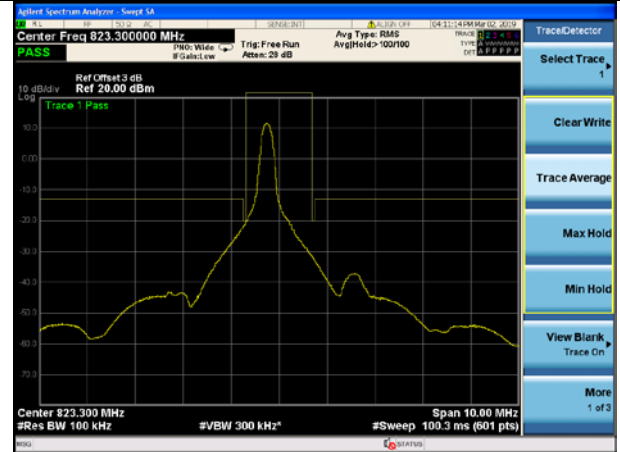

Highest channel

1.4MHz Bandwidth (RB size:3# RB offset:0#)

1.4MHz Bandwidth (RB size:3# RB offset:2#)

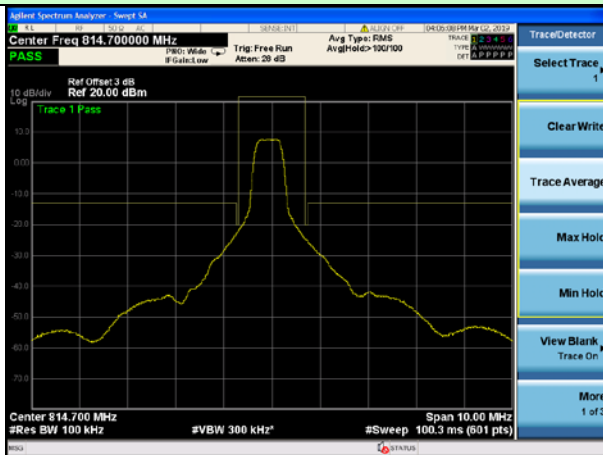

Lowest channel

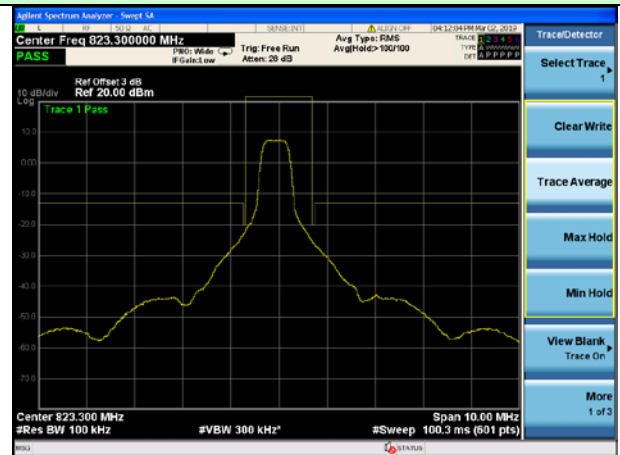

Highest channel

1.4MHz Bandwidth (RB size:6# RB offset:0#)

1.4MHz Bandwidth (RB size:6# RB offset:0#)

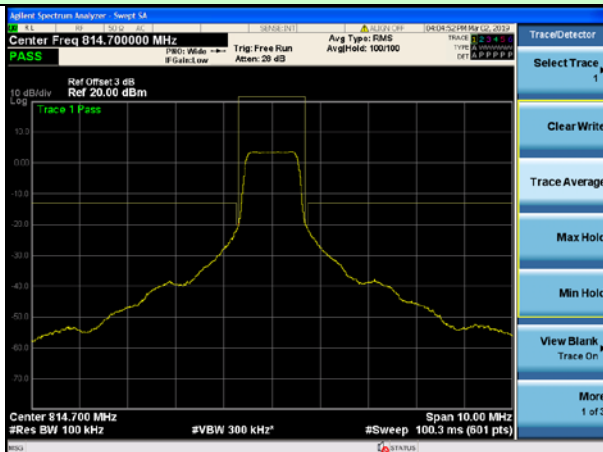

Lowest channel

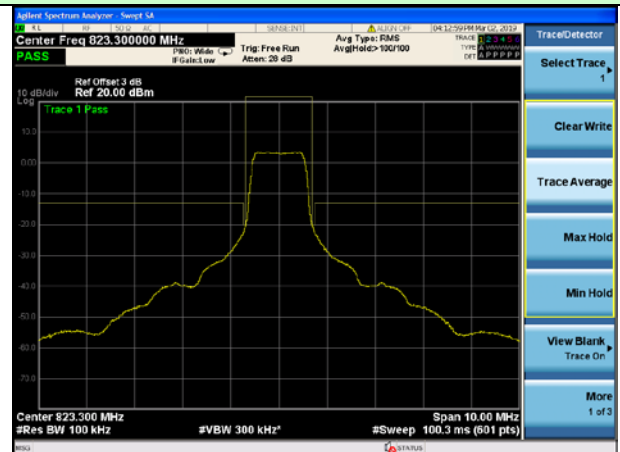

Highest channel

3MHz Bandwidth (RB size:1# RB offset:0#)

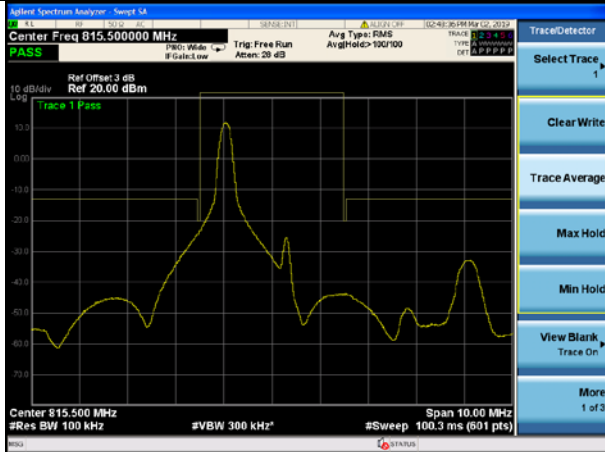

Lowest channel

3MHz Bandwidth (RB size:1# RB offset:14#)

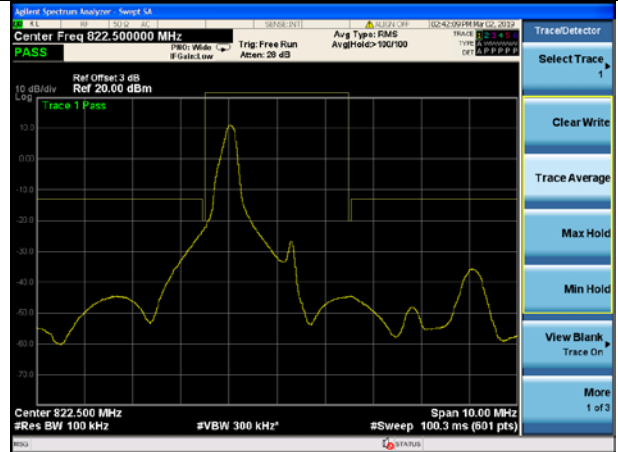

Highest channel

3MHz Bandwidth (RB size:8# RB offset:0#)

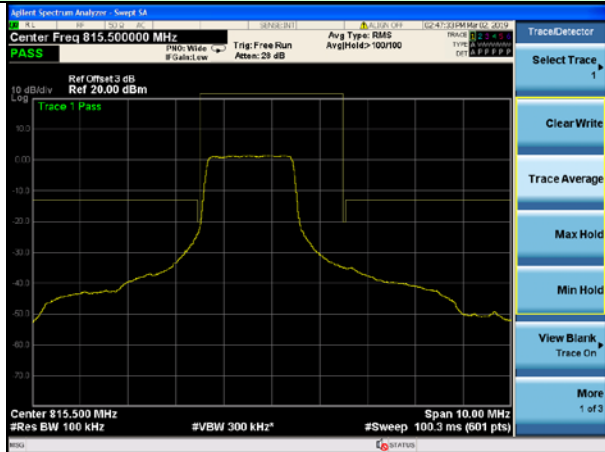

Lowest channel

3MHz Bandwidth (RB size:8# RB offset:7#)

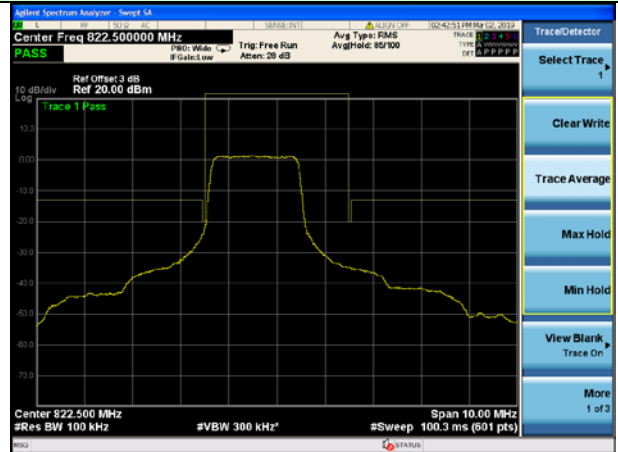

Highest channel

3MHz Bandwidth (RB size:15# RB offset:0#)

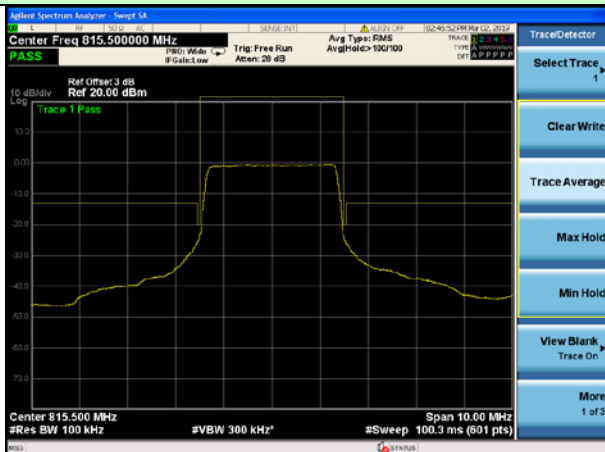

Lowest channel

3MHz Bandwidth (RB size:15# RB offset:0#)

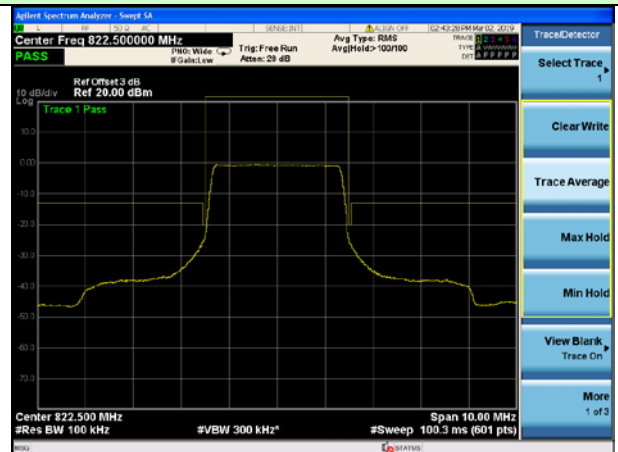

Highest channel

5MHz Bandwidth (RB size:1# RB offset:0#)

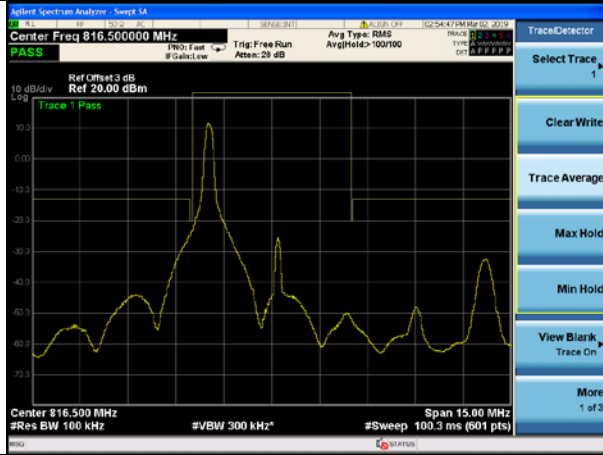

Lowest channel

5MHz Bandwidth (RB size:1# RB offset:24#)

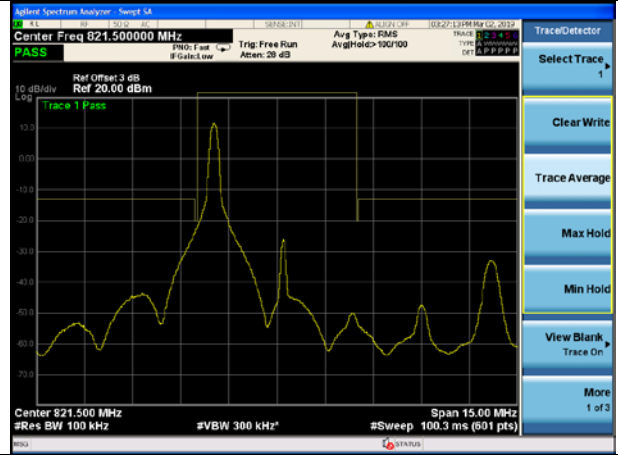

Highest channel

5MHz Bandwidth (RB size:12# RB offset:0#)

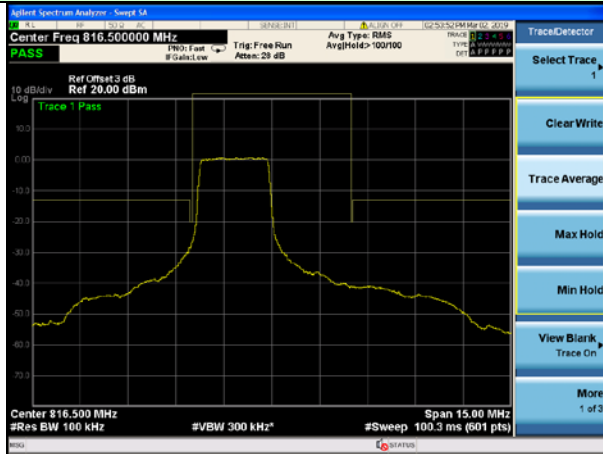

Lowest channel

5MHz Bandwidth (RB size:12# RB offset:13#)

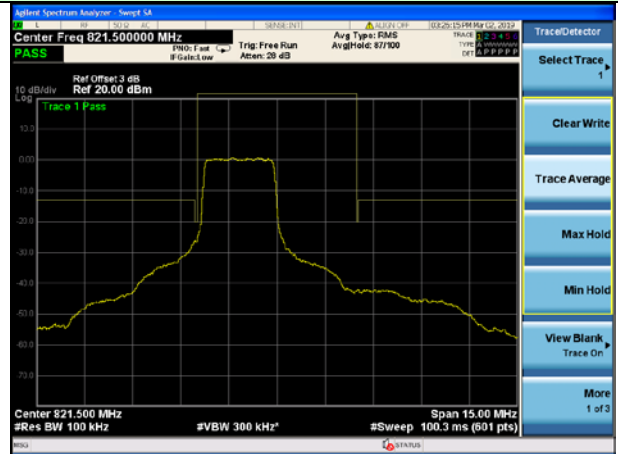

Highest channel

5MHz Bandwidth (RB size:25# RB offset:0#)

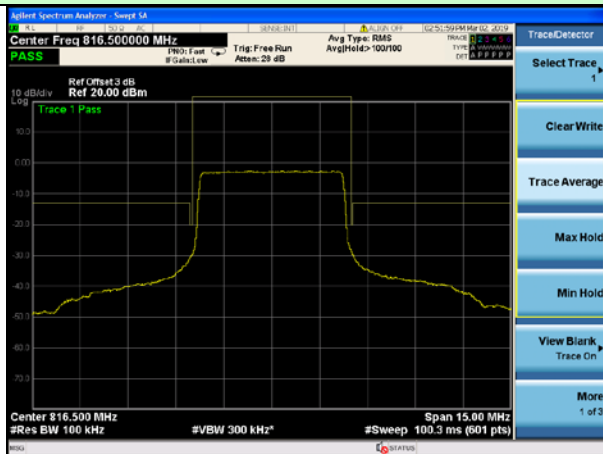

Lowest channel

5MHz Bandwidth (RB size:25# RB offset:0#)

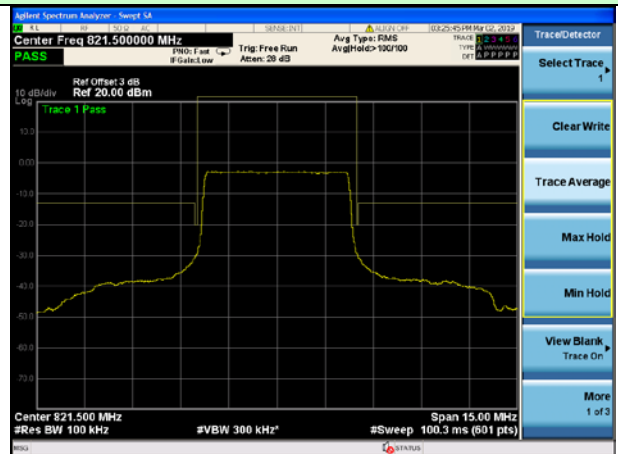

Highest channel

10MHz Bandwidth (RB size:1# RB offset:0#)

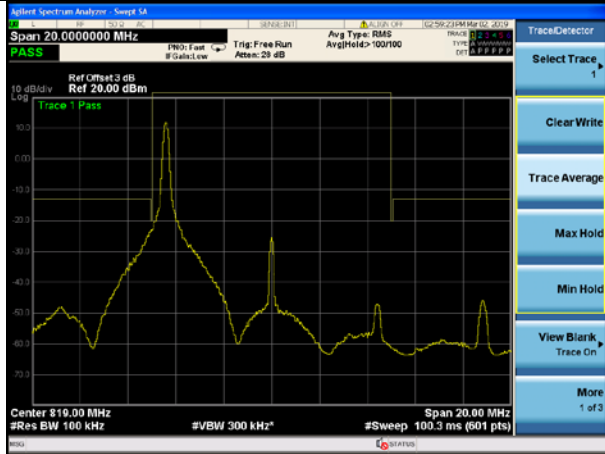

Middle channel

10MHz Bandwidth (RB size:25# RB offset:0#)

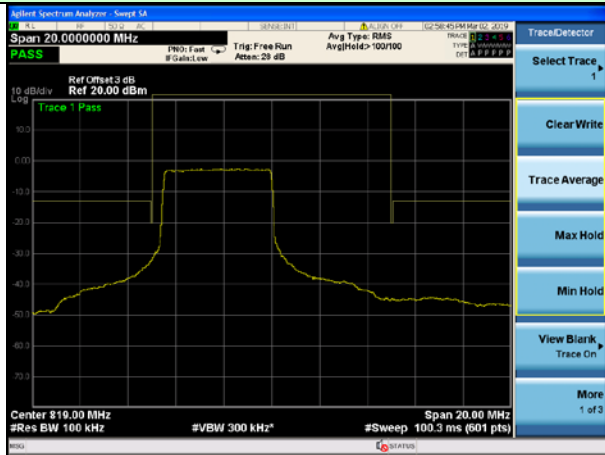

Middle channel

10MHz Bandwidth (RB size:50# RB offset:0#)

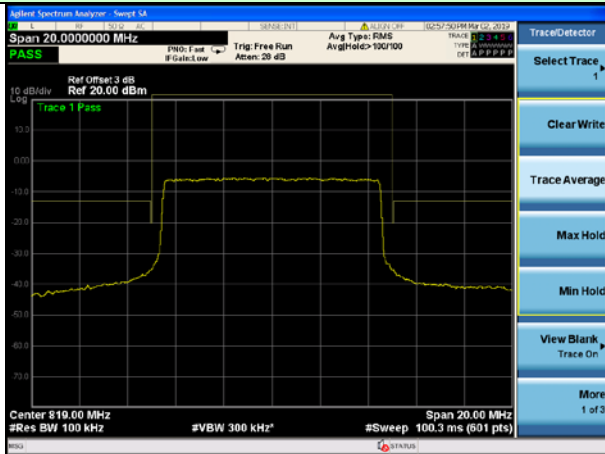

Middle channel

6.8 Field strength of spurious radiation measurement

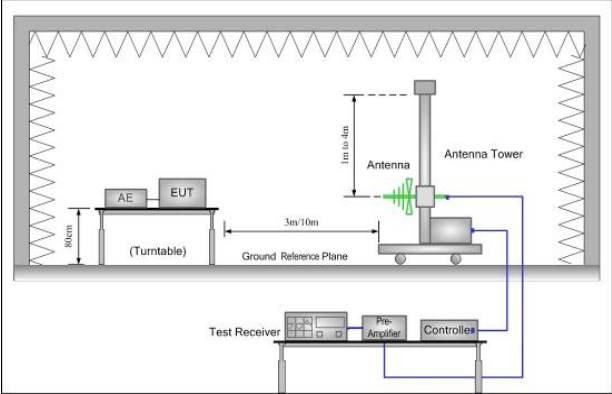
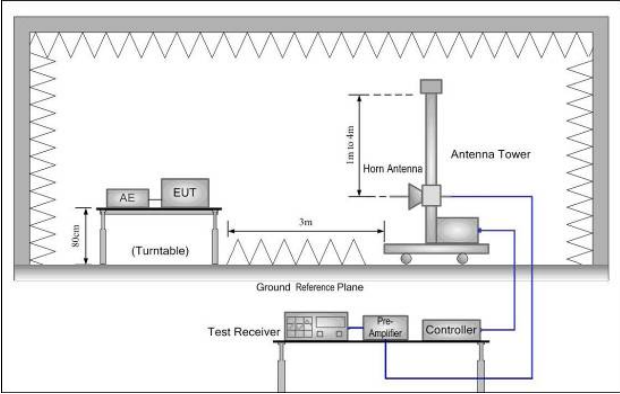
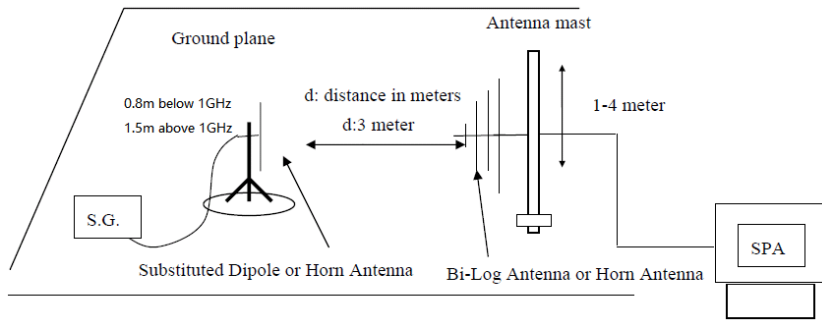
Test Requirement:	Part 90
Limit:	-13dBm
Test setup:	<p>Below 1GHz</p>  <p>Above 1GHz</p>  <p>Substituted method:</p> 

<p>Test Procedure:</p>	<ol style="list-style-type: none"> 1. The EUT was placed on a non-conductive turntable using a non-conductive support. The radiated emission at the fundamental frequency was measured at 3 m with a test antenna and EMI spectrum analyzer. 2. During the tests, the antenna height and the EUT azimuth were varied in order to identify the maximum level of emissions from the EUT. This maximization process was repeated with the EUT positioned in each of its three orthogonal orientations. 3. The frequency range up to tenth harmonic was investigated for each of three fundamental frequency (low, middle and high channels). Once spurious emission was identified, the power of the emission was determined using the substitution method. 4. The spurious emissions attenuation was calculated as the difference between radiated power at the fundamental frequency and the spurious emissions frequency. $\text{ERP / EIRP} = \text{S.G. output (dBm)} + \text{Antenna Gain(dB/dBi)} - \text{Cable Loss (dB)}$ 					
<p>Test environment:</p>	Temp.:	25 °C	Humid.:	52%	Press.:	1 012mbar
<p>Test Instruments:</p>	Refer to section 5.0 for details					
<p>Test mode:</p>	Refer to section 6.1 for details					
<p>Test results:</p>	Pass					

Measurement Data

Remark:

1. The emission behavior belongs to narrowband spurious emission.
2. The emission levels of below 1 GHz are very lower than the limit and not show in test report.

QPSK mode:

Test mode:	LTE Band 26(1.4MHz)		Test channel:	Lowest
Frequency (MHz)	Spurious Emission		Limit (dBm)	Result
	Polarization	Level (dBm)		
1629.40	Vertical	-42.36	-13.00	Pass
2444.10	V	-44.08		
3258.80	V	-41.33		
4073.50	V	-43.48		
4888.20	V	-42.76		
1629.40	Horizontal	-41.57	-13.00	Pass
2444.10	H	-45.42		
3258.80	H	-44.97		
4073.50	H	-44.67		
4888.20	H	-44.12		
Test mode:	LTE Band 26(1.4MHz)		Test channel:	Middle
Frequency (MHz)	Spurious Emission		Limit (dBm)	Result
	Polarization	Level (dBm)		
1638.00	Vertical	-43.48	-13.00	Pass
2457.00	V	-41.75		
3276.00	V	-41.64		
4095.00	V	-43.44		
4914.00	V	-44.80		
1638.00	Horizontal	-41.84	-13.00	Pass
2457.00	H	-45.06		
3276.00	H	-44.36		
4095.00	H	-45.62		
4914.00	H	-43.03		
Test mode:	LTE Band 26(1.4MHz)		Test channel:	Highest
Frequency (MHz)	Spurious Emission		Limit (dBm)	Result
	Polarization	Level (dBm)		
1646.60	Vertical	-42.52	-13.00	Pass
2469.90	V	-43.55		
3293.20	V	-44.23		
4116.50	V	-42.84		
4939.80	V	-43.10		
1646.60	Horizontal	-41.41	-13.00	Pass
2469.90	H	-44.29		
3293.20	H	-45.45		
4116.50	H	-47.47		
4939.80	H	-44.34		

Test mode:		LTE Band 26(5MHz)		Test channel:	Lowest
Frequency (MHz)	Spurious Emission		Limit (dBm)	Result	
	Polarization	Level (dBm)			
1633.00	Vertical	-42.45	-13.00	Pass	
2449.50	V	-43.86			
3266.00	V	-44.86			
4082.50	V	-42.76			
4899.00	V	-39.56			
1633.00	Horizontal	-41.07	-13.00	Pass	
2449.50	H	-44.48			
3266.00	H	-42.86			
4082.50	H	-43.26			
4899.00	H	-40.35			
Test mode:		LTE Band 26(5MHz)		Test channel:	Middle
Frequency (MHz)	Spurious Emission		Limit (dBm)	Result	
	Polarization	Level (dBm)			
1638.00	Vertical	-43.41	-13.00	Pass	
2457.00	V	-44.89			
3276.00	V	-42.94			
4095.00	V	-43.91			
4914.00	V	-42.83			
1638.00	Horizontal	-44.17	-13.00	Pass	
2457.00	H	-42.67			
3276.00	H	-44.10			
4095.00	H	-42.57			
4914.00	H	-40.93			
Test mode:		LTE Band 26(5MHz)		Test channel:	Highest
Frequency (MHz)	Spurious Emission		Limit (dBm)	Result	
	Polarization	Level (dBm)			
1643.00	Vertical	-43.46	-13.00	Pass	
2464.50	V	-44.87			
3286.00	V	-43.87			
4107.50	V	-41.77			
4929.00	V	-40.84			
1643.00	Horizontal	-42.08	-13.00	Pass	
2464.50	H	-43.49			
3286.00	H	-44.87			
4107.50	H	-43.27			
4929.00	H	-41.11			

Test mode:	LTE Band 26(10MHz)		Test channel:	Lowest
Frequency (MHz)	Spurious Emission		Limit (dBm)	Result
	Polarization	Level (dBm)		
1643.00	Vertical	-43.92	-13.00	Pass
2464.50	V	-43.00		
3286.00	V	-44.54		
4107.50	V	-42.99		
4929.00	V	-40.56		
1643.00	Horizontal	-44.83	-13.00	Pass
2464.50	H	-45.17		
3286.00	H	-45.43		
4107.50	H	-43.96		
4929.00	H	-41.47		

16QAM mode:

Test mode:		LTE Band 26(1.4MHz)		Test channel:	Lowest
Frequency (MHz)	Spurious Emission		Limit (dBm)	Result	
	Polarization	Level (dBm)			
1629.40	Vertical	-44.74	-13.00	Pass	
2444.10	V	-44.45			
3258.80	V	-41.89			
4073.50	V	-44.13			
4888.20	V	-43.10			
1629.40	Horizontal	-42.95	-13.00	Pass	
2444.10	H	-44.63			
3258.80	H	-45.57			
4073.50	H	-48.51			
4888.20	H	-43.58			
Test mode:		LTE Band 26(1.4MHz)		Test channel:	Middle
Frequency (MHz)	Spurious Emission		Limit (dBm)	Result	
	Polarization	Level (dBm)			
1638.00	Vertical	-44.37	-13.00	Pass	
2457.00	V	-42.50			
3276.00	V	-44.10			
4095.00	V	-48.20			
4914.00	V	-42.45			
1638.00	Horizontal	-43.58	-13.00	Pass	
2457.00	H	-44.47			
3276.00	H	-46.72			
4095.00	H	-49.81			
4914.00	H	-44.38			
Test mode:		LTE Band 26(1.4MHz)		Test channel:	Highest
Frequency (MHz)	Spurious Emission		Limit (dBm)	Result	
	Polarization	Level (dBm)			
1646.60	Vertical	-46.09	-13.00	Pass	
2469.90	V	-43.53			
3293.20	V	-44.62			
4116.50	V	-42.83			
4939.80	V	-43.26			
1646.60	Horizontal	-43.92	-13.00	Pass	
2469.90	H	-47.79			
3293.20	H	-46.90			
4116.50	H	-44.92			
4939.80	H	-43.63			

Test mode:		LTE Band 26(5MHz)		Test channel:	Lowest
Frequency (MHz)	Spurious Emission		Limit (dBm)	Result	
	Polarization	Level (dBm)			
1633.00	Vertical	-44.95	-13.00	Pass	
2449.50	V	-43.71			
3266.00	V	-43.47			
4082.50	V	-43.01			
4899.00	V	-42.22			
1633.00	Horizontal	-43.79	-13.00	Pass	
2449.50	H	-42.50			
3266.00	H	-47.94			
4082.50	H	-45.59			
4899.00	H	-43.24			
Test mode:		LTE Band 26(5MHz)		Test channel:	Middle
Frequency (MHz)	Spurious Emission		Limit (dBm)	Result	
	Polarization	Level (dBm)			
1638.00	Vertical	-43.88	-13.00	Pass	
2457.00	V	-46.21			
3276.00	V	-43.86			
4095.00	V	-43.34			
4914.00	V	-41.69			
1638.00	Horizontal	-45.38	-13.00	Pass	
2457.00	H	-43.31			
3276.00	H	-44.89			
4095.00	H	-43.13			
4914.00	H	-42.10			
Test mode:		LTE Band 26(5MHz)		Test channel:	Highest
Frequency (MHz)	Spurious Emission		Limit (dBm)	Result	
	Polarization	Level (dBm)			
1643.00	Vertical	-45.30	-13.00	Pass	
2464.50	V	-43.76			
3286.00	V	-42.42			
4107.50	V	-44.33			
4929.00	V	-42.98			
1643.00	Horizontal	-42.79	-13.00	Pass	
2464.50	H	-43.15			
3286.00	H	-44.56			
4107.50	H	-45.73			
4929.00	H	-43.46			

Test mode:	LTE Band 26(10MHz)		Test channel:	Lowest
Frequency (MHz)	Spurious Emission		Limit (dBm)	Result
	Polarization	Level (dBm)		
3800.00	Vertical	-43.50	-13.00	Pass
5700.00	V	-42.43		
7600.00	V	-44.84		
9500.00	V	-44.17		
11400.00	V	-42.11		
3800.00	Horizontal	-45.12	-13.00	Pass
5700.00	H	-47.25		
7600.00	H	-44.92		
9500.00	H	-43.83		
11400.00	H	-42.06		

6.9 Frequency stability V.S. Temperature measurement

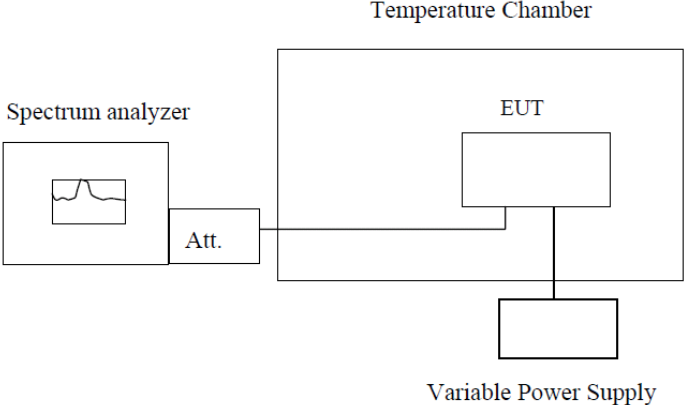
Test Requirement:	FCC Part2.1055(a)(1)(b)
Limit:	$\pm 2.5\text{ppm}$
Test setup:	 <p style="text-align: center;">Note : Measurement setup for testing on Antenna connector</p>
Test procedure:	<ol style="list-style-type: none"> 1. The equipment under test was connected to an external DC power supply and input rated voltage. 2. RF output was connected to a frequency counter or spectrum analyzer via feed through attenuators. 3. The EUT was placed inside the temperature chamber. 4. Set the spectrum analyzer RBW low enough to obtain the desired frequency resolution and measure EUT 25°C operating frequency as reference frequency. 5. Turn EUT off and set the chamber temperature to -20°C. After the temperature stabilized for approximately 30 minutes recorded the frequency. 6. Repeat step measure with 10°C increased per stage until the highest temperature of $+50^{\circ}\text{C}$ reached.
Test Instruments:	Refer to section 5.0 for details
Test mode:	Refer to section 6.1 for details
Test results:	Pass

Measurement Data

QPSK mode:

Reference Frequency: LTE Band 26 Middle channel=26740 channel=819MHz					
Power supplied (Vdc)	Temperature (°C)	Frequency error		Limit (ppm)	Result
		Hz	ppm		
3.8	-30	144	0.0768	±2.5	Pass
	-20	163	0.0869		
	-10	138	0.0734		
	0	113	0.0599		
	10	132	0.0700		
	20	113	0.0599		
	30	189	0.1003		
	40	170	0.0902		
	50	163	0.0869		

16QAM mode:

Reference Frequency: LTE Band 26 Middle channel=26740 channel=819MHz					
Power supplied (Vdc)	Temperature (°C)	Frequency error		Limit (ppm)	Result
		Hz	ppm		
3.8	-30	174	0.0687	±2.5	Pass
	-20	201	0.0794		
	-10	169	0.0665		
	0	147	0.0580		
	10	164	0.0648		
	20	143	0.0565		
	30	241	0.0950		
	40	210	0.0828		
	50	199	0.0784		

6.10 Frequency stability V.S. Voltage measurement

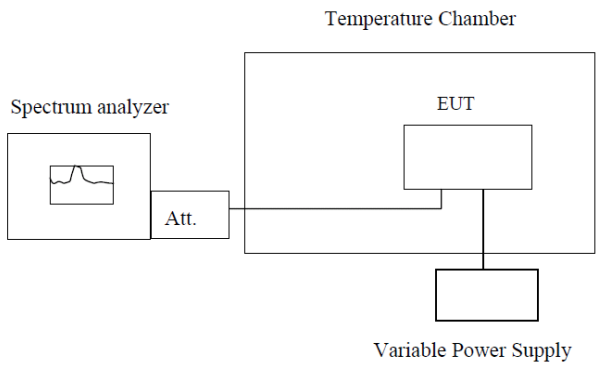
Test Requirement:	FCC Part2.1055(d)(1)(2)
Limit:	$\pm 2.5\text{ppm}$
Test setup:	 <p style="text-align: center;">Temperature Chamber</p> <p style="text-align: center;">Spectrum analyzer Att. EUT</p> <p style="text-align: center;">Variable Power Supply</p> <p>Note : Measurement setup for testing on Antenna connector</p>
Test procedure:	<ol style="list-style-type: none"> 1. Set chamber temperature to 25°C. Use a variable DC power source to power the EUT and set the voltage to rated voltage. 2. Set the spectrum analyzer RBW low enough to obtain the desired frequency resolution and recorded the frequency. 3. Reduce the input voltage to specified extreme voltage variation (+/- 15%) and endpoint, record the maximum frequency change.
Test Instruments:	Refer to section 5.0 for details
Test mode:	Refer to section 6.1 for details
Test results:	Pass

Measurement Data

QPSK mode:

Reference Frequency: LTE Band 26 Middle channel=26740 channel=819MHz					
Temperature (°C)	Power supplied (Vdc)	Frequency error		Limit (ppm)	Result
		Hz	ppm		
25	3.3	96	0.1364	±2.5	Pass
	3.8	118	0.1670		
	4.4	118	0.1670		

16QAM mode:

Reference Frequency: LTE Band 26 Middle channel=26740 channel=819MHz					
Temperature (°C)	Power supplied (Vdc)	Frequency error		Limit (ppm)	Result
		Hz	ppm		
25	3.3	112	0.1578	±2.5	Pass
	3.8	128	0.1804		
	4.4	143	0.2025		

7 Test Setup Photo

Radiated Emission

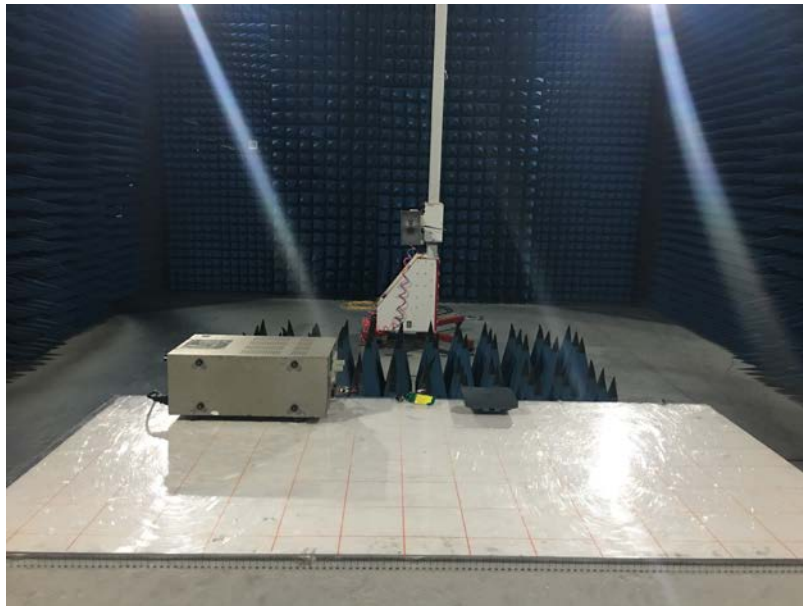
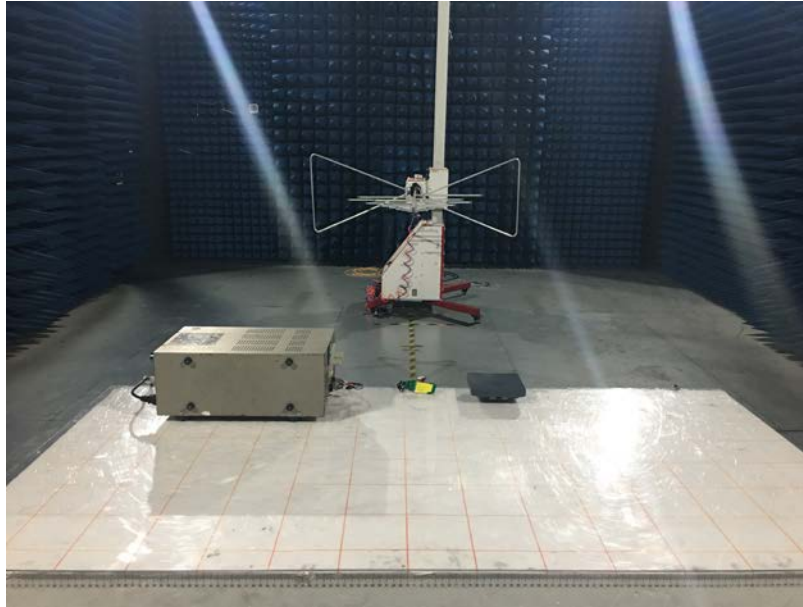

-----End-----