

# TEST REPORT

**FCC ID: TUVX-08**

**Product: Wireless Optical Mouse**

**Model No.: X-08**

**Additional Model: DS-2472, DS-2712, DS-2567, DS-2572, CA32, PC066A**

**Trade Mark: N/A**

**Report No.: TCT170608E018**

**Issued Date: Jun. 21, 2017**

Issued for:

**Eastern Times Technology Co., Ltd.**

**Building D, Nan An Industrial Area, Youganpu Village, Fenggang Town,  
Dongguan City, Guangdong, China.**

Issued By:

**Shenzhen Tongce Testing Lab.**

**1F, Leinuo Watch Building, Fuyong Town, Baoan Dist, Shenzhen, China**

**TEL: +86-755-27673339**

**FAX: +86-755-27673332**

**Note:** This report shall not be reproduced except in full, without the written approval of Shenzhen Tongce Testing Lab.

This document may be altered or revised by Shenzhen Tongce Testing Lab. personnel only, and shall be noted in the revision section of the document. The test results in the report only apply to the tested sample.

**TABLE OF CONTENTS**

1. Test Certification..... 3

2. Test Result Summary ..... 4

3. EUT Description..... 5

4. Genera Information..... 6

    4.1. Test Environment and Mode ..... 6

    4.2. Description of Support Units ..... 6

5. Facilities and Accreditations ..... 7

    5.1. Facilities ..... 7

    5.2. Location ..... 7

    5.3. Measurement Uncertainty ..... 7

6. Test Results and Measurement Data ..... 8

    6.1. Antenna Requirement..... 8

    6.2. Conducted Emission..... 9

    6.3. Radiated Emission Measurement..... 10

    6.4. 20dB Occupied Bandwidth..... 18

**Appendix A: Photographs of Test Setup**

**Appendix B: Photographs of EUT**

## 1. Test Certification

<b>Product:</b>	Wireless Optical Mouse
<b>Model No.:</b>	X-08
<b>Additional Model:</b>	DS-2472, DS-2712, DS-2567, DS-2572, CA32, PC066A
<b>Applicant:</b>	Eastern Times Technology Co., Ltd.
<b>Address:</b>	Building D, Nan An Industrial Area, Youganpu Village, Fenggang Town, Dongguan City, Guangdong, China.
<b>Manufacturer:</b>	Eastern Times Technology Co., Ltd.
<b>Address:</b>	Building D, Nan An Industrial Area, Youganpu Village, Fenggang Town, Dongguan City, Guangdong, China.
<b>Date of Test:</b>	Jun. 09 – Jun. 20, 2017
<b>Applicable Standards:</b>	FCC CFR Title 47 Part 15 Subpart C Section 15.249

The above equipment has been tested by Shenzhen Tongce Testing Lab. and found compliance with the requirements set forth in the technical standards mentioned above. The results of testing in this report apply only to the product/system, which was tested. Other similar equipment will not necessarily produce the same results due to production tolerance and measurement uncertainties.

**Tested By:**

*Brews Xu*

**Brews Xu**

**Date:**

**Jun. 20, 2017**

**Reviewed By:**



**Date:**

**Jun. 21, 2017**

**Approved By:**

**Tomsin**

**Date:**

**Jun. 21, 2017**

## 2. Test Result Summary

Requirement	CFR 47 Section	Result
Antenna Requirement	§15.203	PASS
AC Power Line Conducted Emission	§15.207	N/A
Field Strength of Fundamental	§15.249 (a)	PASS
Spurious Emissions	§2.1053 §15.249 (a) (d)/ §15.209	PASS
Band Edge	§2.1053 §15.249 (d)/ §15.205	PASS
20dB Occupied Bandwidth	§2.1049 §15.215 (c)	PASS

**Note:**

1. Pass: Test item meets the requirement.
2. Fail: Test item does not meet the requirement.
3. N/A: Test case does not apply to the test object.
4. The test result judgment is decided by the limit of test standard.

### 3. EUT Description

<b>Product Name:</b>	Wireless Optical Mouse
<b>Model :</b>	X-08
<b>Additional Model:</b>	DS-2472, DS-2712, DS-2567, DS-2572, CA32, PC066A
<b>Trade Mark:</b>	N/A
<b>Hardware Version:</b>	V1.2
<b>Software Version:</b>	V1.0
<b>Operation Frequency:</b>	2408-2474MHz
<b>Number of Channel:</b>	34
<b>Modulation Technology:</b>	FSK
<b>Antenna Type:</b>	PCB Antenna
<b>Antenna Gain:</b>	-2 dBi
<b>Power Supply:</b>	DC 1.5V(Single AA Battery)
<b>Remark:</b>	All models above are identical in interior structure, electrical circuits and components, and just model names are different for the marketing requirement.

#### Operation Frequency Each of Channel

Channel	Frequency	Channel	Frequency	Channel	Frequency	Channel	Frequency
0	2408MHz	10	2428 MHz	20	2448 MHz	30	2468 MHz
1	2410 MHz	11	2430 MHz	21	2450 MHz	31	2470 MHz
2	2412 MHz	12	2432 MHz	22	2452 MHz	32	2472 MHz
3	2414 MHz	13	2434 MHz	23	2454 MHz	33	2474 MHz
4	2416 MHz	14	2436 MHz	24	2456 MHz		
5	2418 MHz	15	2438 MHz	25	2458 MHz		
6	2420 MHz	16	2440 MHz	26	2460 MHz		
7	2422 MHz	17	2442 MHz	27	2462 MHz		
8	2424 MHz	18	2444 MHz	28	2464 MHz		
9	2426 MHz	19	2446 MHz	29	2466 MHz		

**Note:**

In section 15.31(m), regards to the operating frequency range over 10 MHz, the Lowest frequency, the middle frequency, and the highest frequency of channel were selected to perform the test, and the selected channel see below:

Channel	Frequency
The lowest channel	2408MHz
The middle channel	2440MHz
The Highest channel	2474MHz

## 4. Genera Information

### 4.1. Test Environment and Mode

Operating Environment:	
Temperature:	25.0 °C
Humidity:	54 % RH
Atmospheric Pressure:	1010 mbar
Test Mode:	
Engineering mode:	Keep the EUT in continuous transmitting by select channel
<p>The sample was placed (0.8m below 1GHz, 1.5m above 1GHz) above the ground plane of 3m chamber. Measurements in both horizontal and vertical polarities were performed. During the test, each emission was maximized by: having the EUT continuously working, investigated all operating modes, rotated about all 3 axis (X, Y &amp; Z) and considered typical configuration to obtain worst position, manipulating interconnecting cables, rotating the turntable, varying antenna height from 1m to 4m in both horizontal and vertical polarizations. The emissions worst-case are shown in Test Results of the following pages.</p>	

### 4.2. Description of Support Units

The EUT has been tested as an independent unit together with other necessary accessories or support units. The following support units or accessories were used to form a representative test configuration during the tests.

Equipment	Model No.	Serial No.	FCC ID	Trade Name
/	/	/	/	/

**Note:**

1. All the equipment/cables were placed in the worst-case configuration to maximize the emission during the test.
2. Grounding was established in accordance with the manufacturer's requirements and conditions for the intended use.

## 5. Facilities and Accreditations

### 5.1. Facilities

The test facility is recognized, certified, or accredited by the following organizations:

- FCC - Registration No.: 572331

Shenzhen Tongce Testing Lab

The 3m Semi-anechoic chamber has been registered and fully described in a report with the (FCC) Federal Communications Commission. The acceptance letter from the FCC is maintained in our files.

- IC - Registration No.: 10668A-1

The 3m Semi-anechoic chamber of Shenzhen TCT Testing Technology Co., Ltd. has been registered by Certification and Engineering Bureau of Industry Canada for radio equipment testing

### 5.2. Location

Shenzhen Tongce Testing Lab

Address: 1F, Leinuo Watch Building, Fuyong Town, Baoan Dist, Shenzhen, China

TEL: +86-755-27673339

### 5.3. Measurement Uncertainty

The reported uncertainty of measurement  $y \pm U$ , where expanded uncertainty  $U$  is based on a standard uncertainty multiplied by a coverage factor of  $k=2$ , providing a level of confidence of approximately 95 %.

No.	Item	MU
1	Conducted Emission	$\pm 2.56\text{dB}$
2	RF power, conducted	$\pm 0.12\text{dB}$
3	Spurious emissions, conducted	$\pm 0.11\text{dB}$
4	All emissions, radiated(<1GHz)	$\pm 3.92\text{dB}$
5	All emissions, radiated(>1GHz)	$\pm 4.28\text{dB}$
6	Temperature	$\pm 0.1^\circ\text{C}$
7	Humidity	$\pm 1.0\%$

## 6. Test Results and Measurement Data

### 6.1. Antenna Requirement

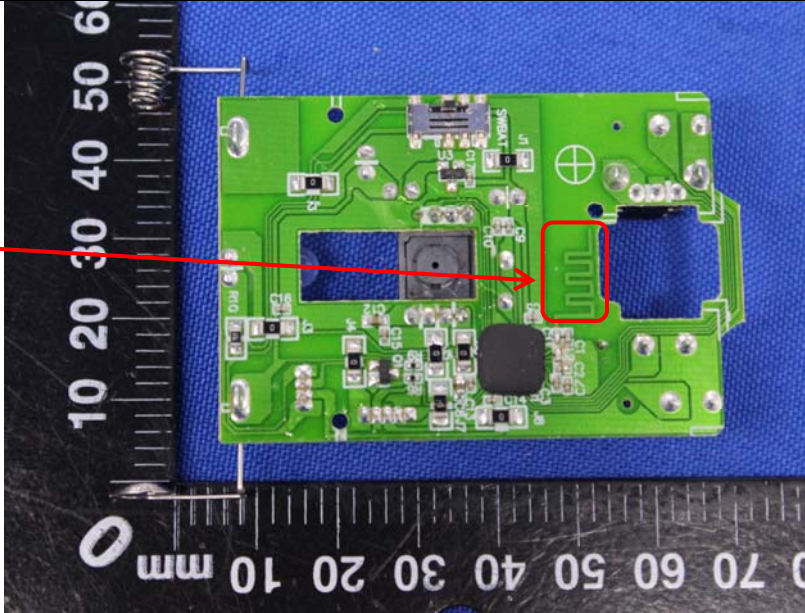
<b>Standard requirement:</b>	FCC Part15 C Section 15.203
15.203 requirement: An intentional radiator shall be designed to ensure that no antenna other than that furnished by the responsible party shall be used with the device. The use of a permanently attached antenna or of an antenna that uses a unique coupling to the intentional radiator, the manufacturer may design the unit so that a broken antenna can be replaced by the user, but the use of a standard antenna jack or electrical connector is prohibited.	
<b>E.U.T Antenna:</b>	
The EUT antenna is PCB antenna which permanently attached, and the best case gain of the antenna is -2dBi.	
	



## 6.2. Conducted Emission

### 6.2.1. Test Specification

<b>Test Requirement:</b>	FCC Part15 C Section 15.207														
<b>Test Method:</b>	ANSI C63.10:2013														
<b>Frequency Range:</b>	150 kHz to 30 MHz														
<b>Receiver setup:</b>	RBW=9 kHz, VBW=30 kHz, Sweep time=auto														
<b>Limits:</b>	<table border="1"> <thead> <tr> <th rowspan="2">Frequency range (MHz)</th> <th colspan="2">Limit (dBuV)</th> </tr> <tr> <th>Quasi-peak</th> <th>Average</th> </tr> </thead> <tbody> <tr> <td>0.15-0.5</td> <td>66 to 56*</td> <td>56 to 46*</td> </tr> <tr> <td>0.5-5</td> <td>56</td> <td>46</td> </tr> <tr> <td>5-30</td> <td>60</td> <td>50</td> </tr> </tbody> </table>	Frequency range (MHz)	Limit (dBuV)		Quasi-peak	Average	0.15-0.5	66 to 56*	56 to 46*	0.5-5	56	46	5-30	60	50
Frequency range (MHz)	Limit (dBuV)														
	Quasi-peak	Average													
0.15-0.5	66 to 56*	56 to 46*													
0.5-5	56	46													
5-30	60	50													
<b>Test Setup:</b>	<p><i>Remark</i> E.U.T: Equipment Under Test LISN: Line Impedance Stabilization Network Test table height=0.8m</p>														
<b>Test Mode:</b>	Transmitting mode with modulation														
<b>Test Procedure:</b>	<ol style="list-style-type: none"> <li>1. The E.U.T and simulators are connected to the main power through a line impedance stabilization network (L.I.S.N.). This provides a 50ohm/50uH coupling impedance for the measuring equipment.</li> <li>2. The peripheral devices are also connected to the main power through a LISN that provides a 50ohm/50uH coupling impedance with 50ohm termination. (Please refer to the block diagram of the test setup and photographs).</li> <li>3. Both sides of A.C. line are checked for maximum conducted interference. In order to find the maximum emission, the relative positions of equipment and all of the interface cables must be changed according to ANSI C63.10:2013 on conducted measurement.</li> </ol>														
<b>Test Result:</b>	N/A; The EUT is supplied by 3V from AA battery, so Conducted Emission is not applicable.														

### 6.3. Radiated Emission Measurement

#### 6.3.1. Test Specification

<b>Test Requirement:</b>	FCC Part15 C Section 15.209/ Part 2 J Section 2.1053				
<b>Test Method:</b>	ANSI C63.10:2013				
<b>Frequency Range:</b>	9 kHz to 25 GHz				
<b>Measurement Distance:</b>	3 m				
<b>Antenna Polarization:</b>	Horizontal & Vertical				
<b>Receiver Setup:</b>	Frequency	Detector	RBW	VBW	Remark
	9kHz- 150kHz	Quasi-peak	200Hz	1kHz	Quasi-peak Value
	150kHz- 30MHz	Quasi-peak	9kHz	30kHz	Quasi-peak Value
	30MHz-1GHz	Quasi-peak	120kHz	300kHz	Quasi-peak Value
	Above 1GHz	Peak	1MHz	3MHz	Peak Value
		Peak	1MHz	10Hz	Average Value
<b>Limit(Field strength of the fundamental signal):</b>	Frequency	Limit (dBuV/m @3m)		Remark	
	2400MHz-2483.5MHz	94.00		Average Value	
		114.00		Peak Value	
<b>Limit(Spurious Emissions):</b>	Frequency	Limit (dBuV/m @3m)		Remark	
	0.009-0.490	2400/F(KHz)		Quasi-peak Value	
	0.490-1.705	24000/F(KHz)		Quasi-peak Value	
	1.705-30	30		Quasi-peak Value	
	30MHz-88MHz	40.0		Quasi-peak Value	
	88MHz-216MHz	43.5		Quasi-peak Value	
	216MHz-960MHz	46.0		Quasi-peak Value	
	960MHz-1GHz	54.0		Quasi-peak Value	
	Above 1GHz	54.0		Average Value	
	74.0		Peak Value		
<b>Limit (band edge) :</b>	Emissions radiated outside of the specified frequency bands, except for harmonics, shall be attenuated by at least 50 dB below the level of the fundamental or to the general radiated emission limits in Section 15.209, whichever is the lesser attenuation.				
<b>Test Procedure:</b>	<ol style="list-style-type: none"> <li>1. The EUT was placed on the top of a rotating table 0.8 meters above the ground at a 3 meter chamber in below 1GHz, 1.5m above the ground in above 1GHz. The table was rotated 360 degrees to determine the position of the highest radiation.</li> <li>2. The EUT was set 3 meters away from the interference-receiving antenna, which was mounted on the top of a variable-height antenna tower.</li> <li>3. The antenna height is varied from one meter to four meters above the ground to determine the maximum value of the field strength. Both horizontal and vertical polarizations of the antenna are set to make</li> </ol>				



**Test setup:**

- the measurement.
4. For each suspected emission, the EUT was arranged to its worst case and then the antenna was tuned to heights from 1 meter to 4 meters and the rotatable table was turned from 0 degrees to 360 degrees to find the maximum reading.
  5. The test-receiver system was set to Peak Detect Function and Specified Bandwidth with Maximum Hold Mode.
  6. If the emission level of the EUT in peak mode was 10dB lower than the limit specified, then testing could be stopped and the peak values of the EUT would be reported. Otherwise the emissions that did not have 10dB margin would be re-tested one by one using peak, quasi-peak or average method as specified and then reported in a data sheet.

For radiated emissions below 30MHz

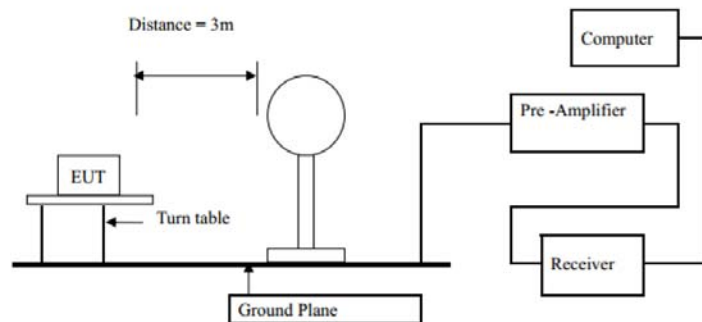

30MHz to 1GHz

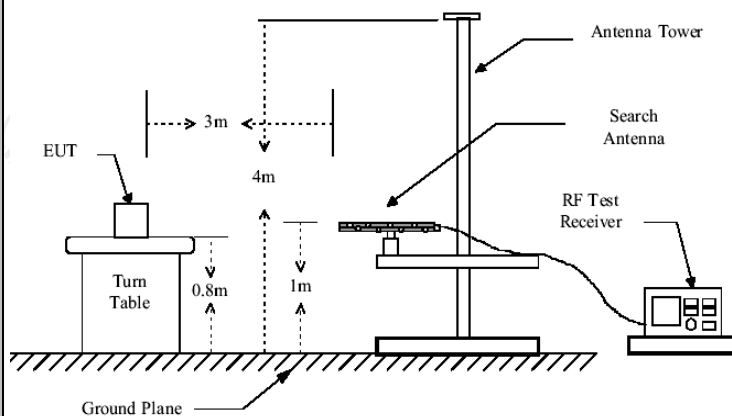

Above 1GHz

(The diagram below shows the test setup that is utilized to make the measurements for emission from 1GHz to the tenth harmonic of the highest fundamental frequency or to 40GHz emissions, whichever is lower.)

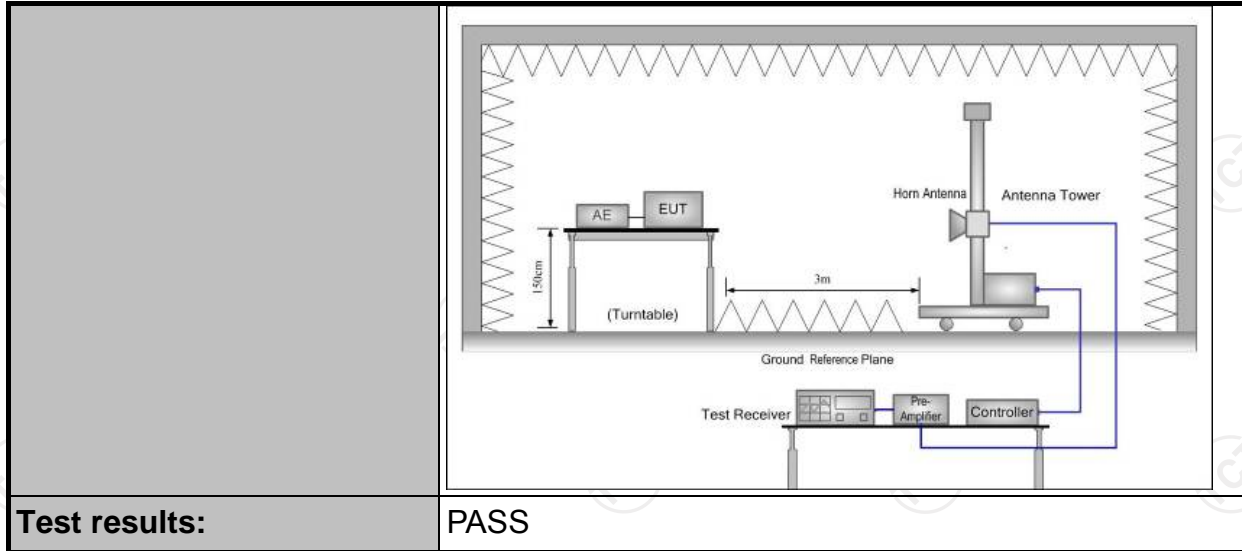

**Test results:**

**PASS**

**6.3.2. Test Instruments**

ESPI Test Receiver	ROHDE&SCHW ARZ	ESVD	100008	Aug. 11, 2017
Spectrum Analyzer	ROHDE&SCHW ARZ	FSEM	848597/001	Aug. 11, 2017
Spectrum Analyzer	Agilent	N9020A	MY49100060	Aug. 12, 2017
Pre-amplifier	EM Electronics Corporation CO.,LTD	EM30265	07032613	Aug. 11, 2017
Pre-amplifier	HP	8447D	2727A05017	Aug. 11, 2017
Loop antenna	ZHINAN	ZN30900A	12024	Aug. 13, 2017
Broadband Antenna	Schwarzbeck	VULB9163	340	Aug. 13, 2017
Horn Antenna	Schwarzbeck	BBHA 9120D	631	Aug. 13, 2017
Horn Antenna	Schwarzbeck	BBHA 9170	373	Aug. 13, 2017
Coax cable	TCT	RE-low-01	N/A	Aug. 11, 2017
Coax cable	TCT	RE-high-02	N/A	Aug. 11, 2017
Coax cable	TCT	RE-low-03	N/A	Aug. 11, 2017
Coax cable	TCT	RE-high-04	N/A	Aug. 11, 2017
Antenna Mast	CCS	CC-A-4M	N/A	N/A
EMI Test Software	Shurple Technology	EZ-EMC	N/A	N/A

**Note:** The calibration interval of the above test instruments is 12 months and the calibrations are traceable to international system unit (SI).

### 6.3.3. Test Data

#### Field Strength of Fundamental

Frequency (MHz)	Emission PK (dBuV/m)	Horizontal /Vertical	Limits PK (dBuV/m)	Margin (dB)
2408	86.68	H	114	-27.32
2408	83.02	V	114	-30.98
2440	87.79	H	114	-26.21
2440	82.11	V	114	-31.89
2474	87.83	H	114	-26.17
2474	80.22	V	114	-33.78

Frequency (MHz)	Emission AV (dBuV/m)	Horizontal /Vertical	Limits AV (dBuV/m)	Margin (dB)
2408	84.42	H	94	-9.58
2408	80.53	V	94	-13.47
2440	85.71	H	94	-8.29
2440	79.70	V	94	-14.30
2474	85.48	H	94	-8.52
2474	77.54	V	94	-16.46

#### Spurious Emissions

##### Frequency Range (9 kHz-30MHz)

Frequency (MHz)	Level@3m (dB $\mu$ V/m)	Limit@3m (dB $\mu$ V/m)
--	--	--
--	--	--
--	--	--
--	--	--

**Note:** 1. Emission Level=Reading+ Cable loss-Antenna factor-Amp factor

2. The emission levels are 20 dB below the limit value, which are not reported. It is deemed to comply with the requirement

Frequency Range (30MHz-1GHz)

Horizontal:

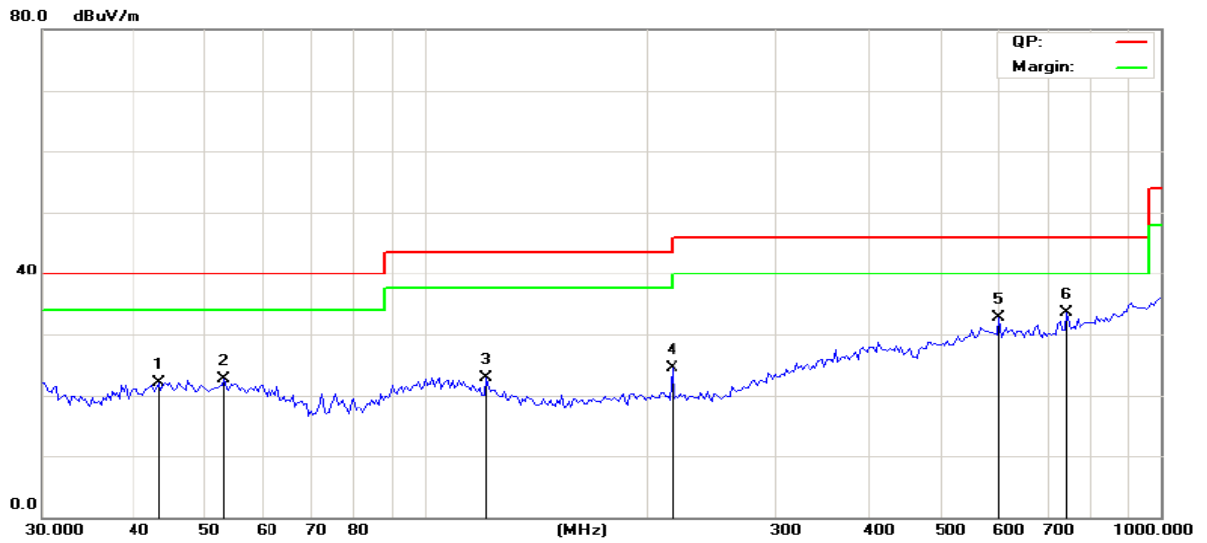

Site Chamber #2

Polarization: **Horizontal**

Temperature: 25 (C)

Limit: FCC Part 15B Class B 3M Radiation

Power: DC 1.5V

Humidity: 55 %

No.	Mk.	Freq. MHz	Reading Level dBuV	Correct Factor dB	Measure- ment dBuV/m	Limit dBuV/m	Over dB	Detector	Comment
1		43.2331	29.12	-6.95	22.17	40.00	-17.83	QP	
2		53.0056	29.64	-6.96	22.68	40.00	-17.32	QP	
3		120.6118	31.75	-8.82	22.93	43.50	-20.57	QP	
4		216.1194	33.50	-9.07	24.43	46.00	-21.57	QP	
5		602.9287	30.35	2.43	32.78	46.00	-13.22	QP	
6	*	744.4265	28.58	4.90	33.48	46.00	-12.52	QP	

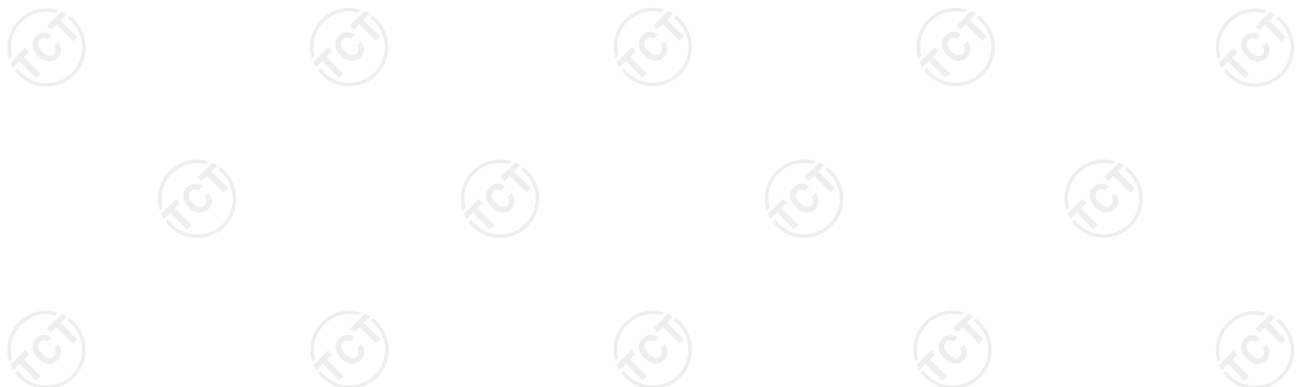

Vertical:

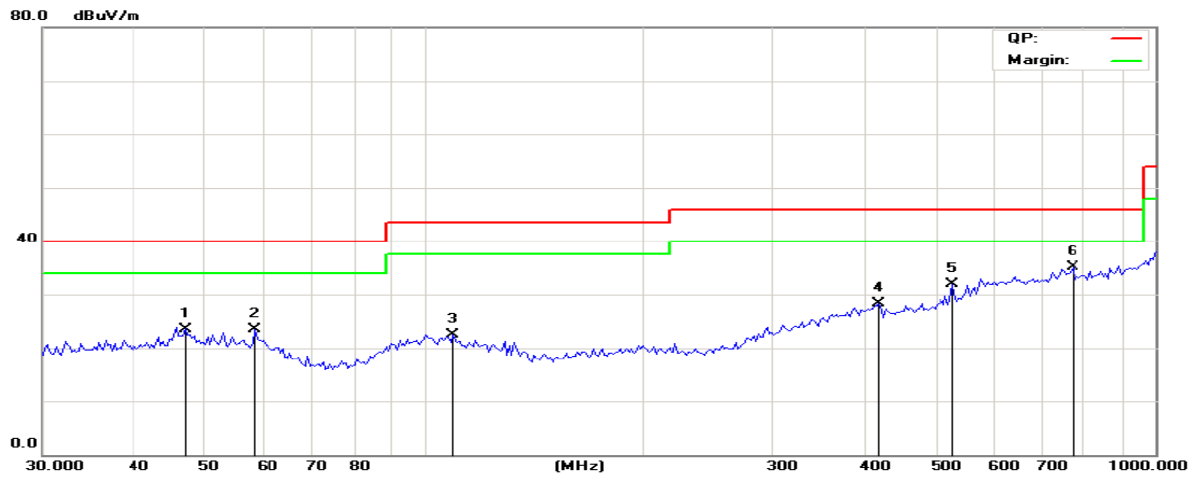

Site Chamber #2      Polarization: **Vertical**      Temperature: 25 (C)  
 Limit: FCC Part 15B Class B 3M Radiation      Power: DC 1.5V      Humidity: 55 %

No.	Mk.	Freq. MHz	Reading Level dBuV	Correct Factor dB	Measure- ment dBuV/m	Limit dBuV/m	Over dB	Detector	Comment
1		47.0371	30.44	-6.84	23.60	40.00	-16.40	QP	
2		58.4855	30.77	-7.33	23.44	40.00	-16.56	QP	
3		109.3110	29.51	-6.98	22.53	43.50	-20.97	QP	
4		418.3783	29.83	-1.59	28.24	46.00	-17.76	QP	
5		527.5706	32.36	-0.37	31.99	46.00	-14.01	QP	
6	*	771.0475	29.79	5.37	35.16	46.00	-10.84	QP	

**Note:** Measurements were conducted in all channels (high, middle, low), and the worst case (low channel) was submitted only.

### Above 1GHz

Low channel: 2408MHz									
Frequency (MHz)	Ant. Pol. H/V	Peak reading (dB $\mu$ V)	AV reading (dB $\mu$ V)	Correction Factor (dB/m)	Emission Level		Peak limit (dB $\mu$ V/m)	AV limit (dB $\mu$ V/m)	Margin (dB)
					Peak (dB $\mu$ V/m)	AV (dB $\mu$ V/m)			
2387.50	H	46.45	---	-4.2	42.25	---	74.00	54.00	-11.75
4816.00	H	49.63	---	-3.94	45.69	---	74.00	54.00	-8.31
7224.00	H	42.56	---	0.52	43.08	---	74.00	54.00	-10.92
---	---	---	---	---	---	---	---	---	---
2387.50	V	44.21	---	-4.2	40.01	---	74.00	54.00	-13.99
4816.00	V	47.63	---	-3.94	43.69	---	74.00	54.00	-10.31
7224.00	V	40.58	---	0.52	41.10	---	74.00	54.00	-12.90
---	---	---	---	---	---	---	---	---	---

Middle channel: 2440MHz									
Frequency (MHz)	Ant. Pol. H/V	Peak reading (dB $\mu$ V)	AV reading (dB $\mu$ V)	Correction Factor (dB/m)	Emission Level		Peak limit (dB $\mu$ V/m)	AV limit (dB $\mu$ V/m)	Margin (dB)
					Peak (dB $\mu$ V/m)	AV (dB $\mu$ V/m)			
4880.00	H	50.48	---	-3.98	46.5	---	74.00	54.00	-7.50
7320.00	H	43.62	---	0.57	44.19	---	74.00	54.00	-9.81
---	---	---	---	---	---	---	---	---	---
---	---	---	---	---	---	---	---	---	---
---	---	---	---	---	---	---	---	---	---
4880.00	V	48.52	---	-3.98	44.54	---	74.00	54.00	-9.46
7320.00	V	43.23	---	0.57	43.8	---	74.00	54.00	-10.2
---	---	---	---	---	---	---	---	---	---
---	---	---	---	---	---	---	---	---	---
---	---	---	---	---	---	---	---	---	---

High channel: 2474MHz									
Frequency (MHz)	Ant. Pol. H/V	Peak reading (dB $\mu$ V)	AV reading (dB $\mu$ V)	Correction Factor (dB/m)	Emission Level		Peak limit (dB $\mu$ V/m)	AV limit (dB $\mu$ V/m)	Margin (dB)
					Peak (dB $\mu$ V/m)	AV (dB $\mu$ V/m)			
2486.58	H	45.49	---	-2.38	43.11	---	74.00	54.00	-10.89
4948.00	H	48.21	---	-3.98	44.23	---	74.00	54.00	-9.77
7422.00	H	42.16	---	0.57	42.73	---	74.00	54.00	-11.27
---	---	---	---	---	---	---	---	---	---
2483.51	V	46.25	---	-2.38	43.87	---	74.00	54.00	-10.13
4948.00	V	47.62	---	-3.98	43.64	---	74.00	54.00	-10.36
7422.00	V	41.36	---	0.57	41.93	---	74.00	54.00	-12.07
---	---	---	---	---	---	---	---	---	---

**Note:**

1. Emission Level=Peak Reading + Correction Factor; Correction Factor= Antenna Factor + Cable loss – Pre-amplifier
2. Margin (dB) = Emission Level (Peak) (dB $\mu$ V/m)-Average limit (dB $\mu$ V/m)
3. The emission levels of other frequencies are very lower than the limit and not show in test report.
4. Measurements were conducted from 1 GHz to the 10th harmonic of highest fundamental frequency.
5. Data of measurement shown “---“in the above table mean that the reading of emissions is attenuated more than 20 dB below the limits or the field strength is too small to be measured.



**Band Edge Requirement**

Low channel: 2408 MHz									
Frequency (MHz)	Ant. Pol. H/V	Peak reading (dBμV)	AV reading (dBuV)	Correction Factor (dB/m)	Emission Level		Peak limit (dBμV/m)	AV limit (dBμV/m)	Margin (dB)
					Peak (dBμV/m)	AV (dBμV/m)			
2400	H	61.35	---	-4.2	57.15	---	74	---	-16.85
2400	H	---	50.86	-4.2	---	46.66	---	54	-7.34
---	---	---	---	---	---	---	---	---	---
2400	V	59.45	---	-4.2	55.25	---	74	---	-18.75
2400	V	---	48.62	-4.2	---	44.42	---	54	-9.58
---	---	---	---	---	---	---	---	---	---

High channel: 2474MHz									
Frequency (MHz)	Ant. Pol. H/V	Peak reading (dBμV)	AV reading (dBuV)	Correction Factor (dB/m)	Emission Level		Peak limit (dBμV/m)	AV limit (dBμV/m)	Margin (dB)
					Peak (dBμV/m)	AV (dBμV/m)			
2483.5	H	56.73	---	-4.2	52.53	---	74	---	-21.47
2483.5	H	---	45.38	-4.2	---	41.18	---	54	-12.82
---	---	---	---	---	---	---	---	---	---
2483.5	V	54.95	---	-4.2	50.75	---	74	---	-23.25
2483.5	V	---	43.55	-4.2	---	39.35	---	54	-14.65
---	---	---	---	---	---	---	---	---	---

**Note:**

1. Emission Level=Peak Reading + Correction Factor; Correction Factor= Antenna Factor + Cable loss – Pre-amplifier
2. Margin (dB) = Emission Level (Peak/Average)(dBμV/m)-(Peak/Average) limit (dBμV/m)
3. The emission levels of other frequencies are very lower than the limit and not show in test report.
4. Measurements were conducted from 1 GHz to the 10th harmonic of highest fundamental frequency.
5. Data of measurement shown “---“in the above table mean that the reading of emissions is attenuated more than 20 dB below the limits or the field strength is too small to be measured.

## 6.4.20dB Occupied Bandwidth

### 6.4.1. Test Specification

<b>Test Requirement:</b>	FCC Part15 C Section 15.215(c)/ Part 2 J Section 2.1049
<b>Test Method:</b>	ANSI C63.10: 2013
<b>Limit:</b>	N/A
	<ol style="list-style-type: none"> <li>1. According to the follow Test-setup, keep the relative position between the artificial antenna and the EUT.</li> <li>2. Set to the maximum power setting and enable the EUT transmit continuously.</li> <li>3. Use the following spectrum analyzer settings for 20dB Bandwidth measurement. Span = approximately 2 to 3 times the 20 dB bandwidth, centered on a hopping channel; RBW<math>\geq</math>1% of the 20 dB bandwidth; VBW<math>\geq</math>RBW; Sweep = auto; Detector function = peak; Trace = max hold.</li> <li>4. Measure and record the results in the test report.</li> </ol>
<b>Test setup:</b>	 <p>The diagram illustrates the test setup. On the left is a green Spectrum Analyzer with a screen and two knobs. A cable connects it to a yellow rectangular box on the right labeled 'EUT'.</p>
<b>Test Mode:</b>	Transmitting mode with modulation
<b>Test results:</b>	PASS

### 6.4.2. Test Instruments

RF Test Room				
Equipment	Manufacturer	Model	Serial Number	Calibration Due
Spectrum Analyzer	R&S	FSU	200054	Aug. 11, 2017

**Note:** The calibration interval of the above test instruments is 12 months and the calibrations are traceable to international system unit (SI).

**6.4.3. Test data**

Test Channel	20dB Occupy Bandwidth (kHz)	Limit	Conclusion
Lowest	2091.35	---	PASS
Middle	2102.37	---	PASS
Highest	2099.36	---	PASS

Test plots as follows:



### Lowest channel

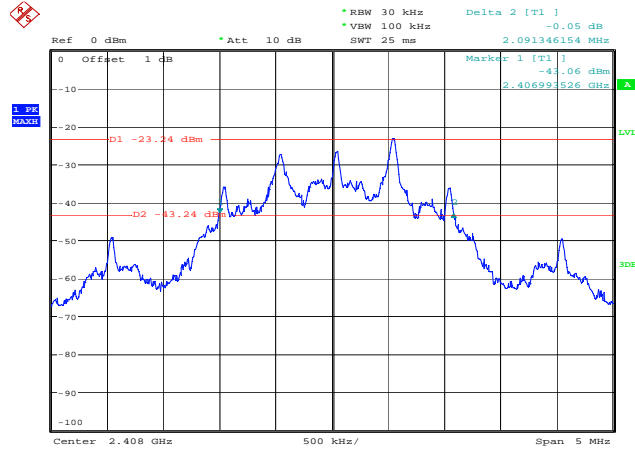

Date: 22.JUN.2017 18:01:43

### Middle channel

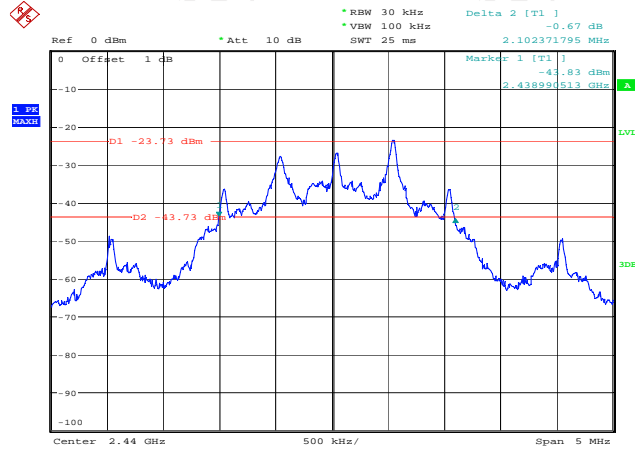

Date: 22.JUN.2017 18:05:36

### Highest channel

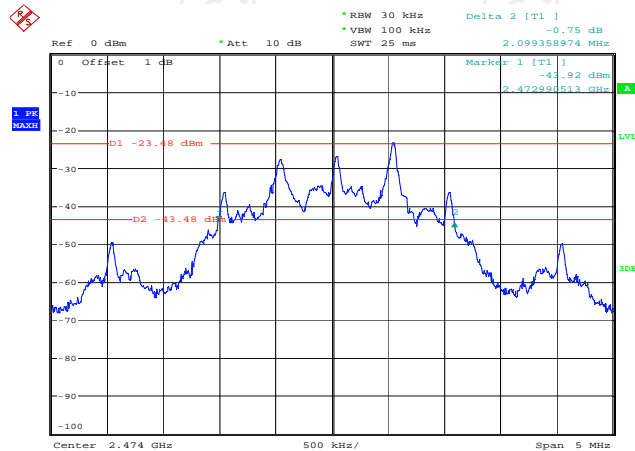

Date: 22.JUN.2017 18:06:28

## Appendix A: Photographs of Test Setup

Product: Wireless Optical Mouse

Model: X-08

Radiated Emission

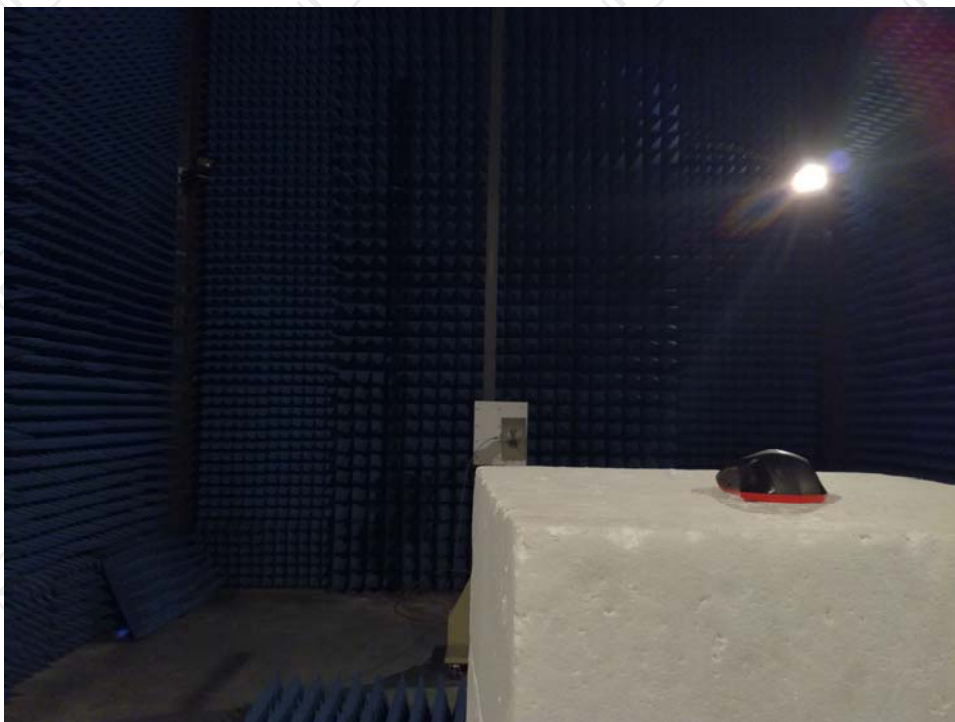
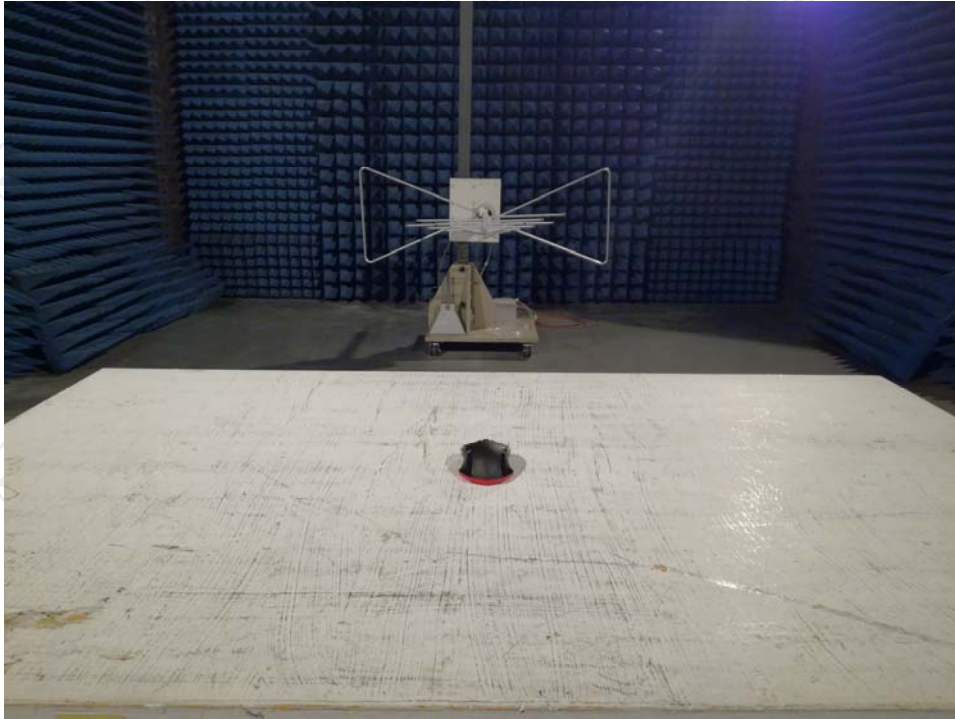

**Appendix B: Photographs of EUT  
Product: Wireless Optical Mouse  
Model: X-08  
External Photos**









**Model: X-08**  
**Internal Photos**

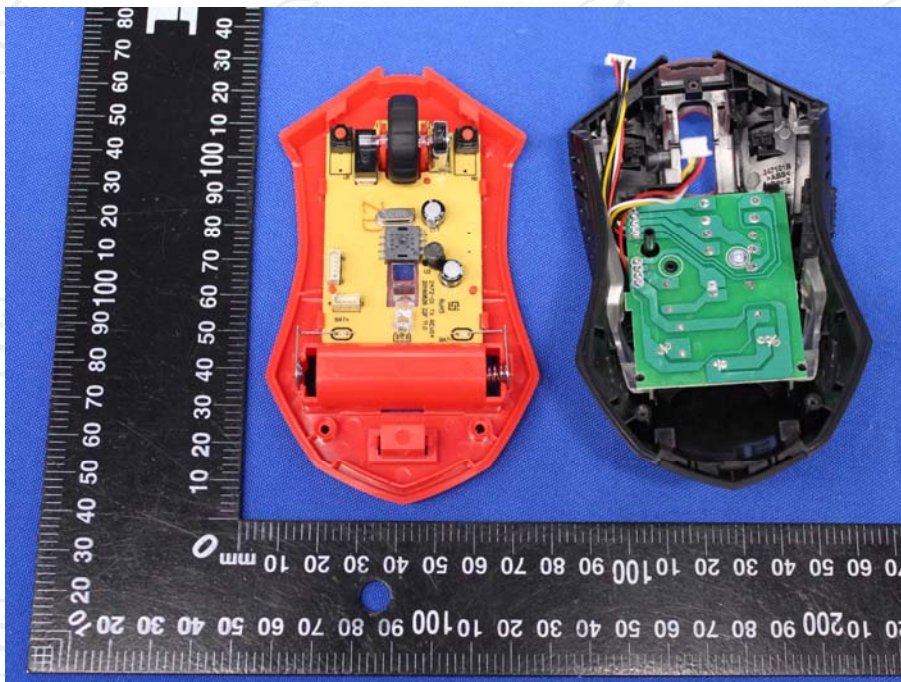

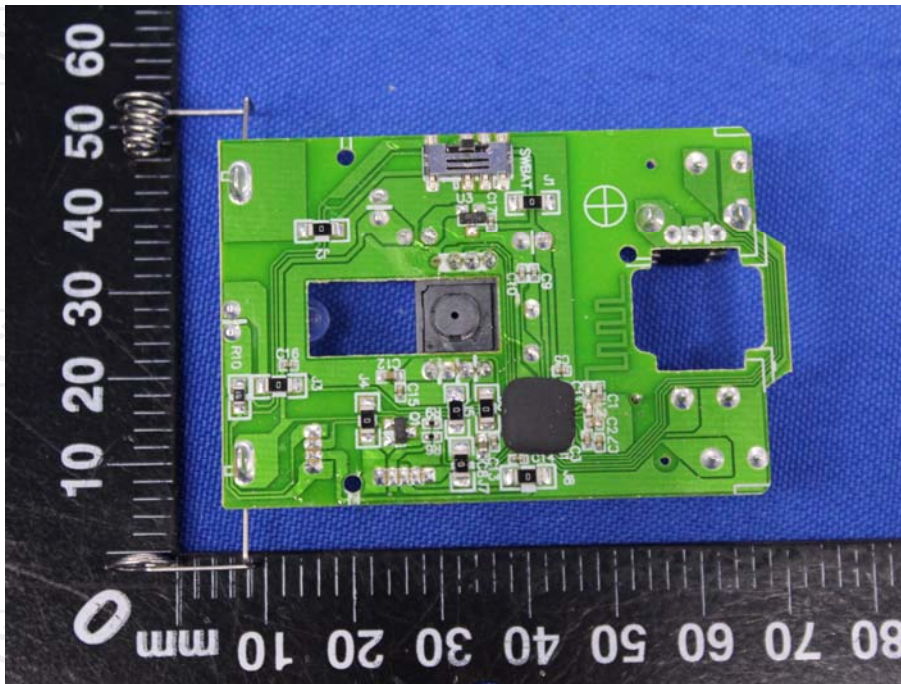
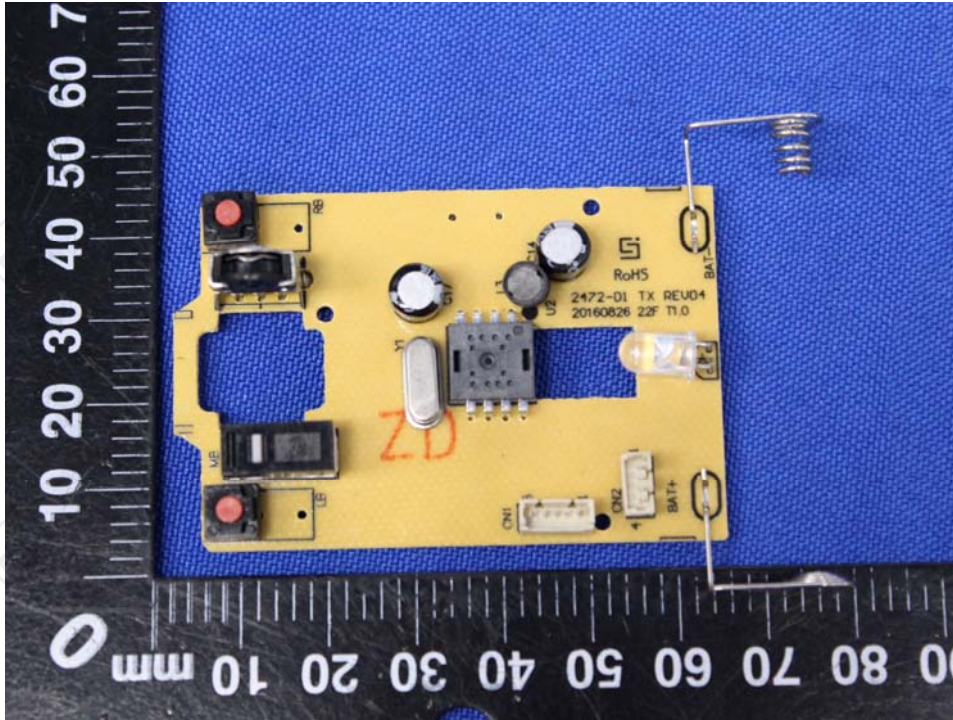

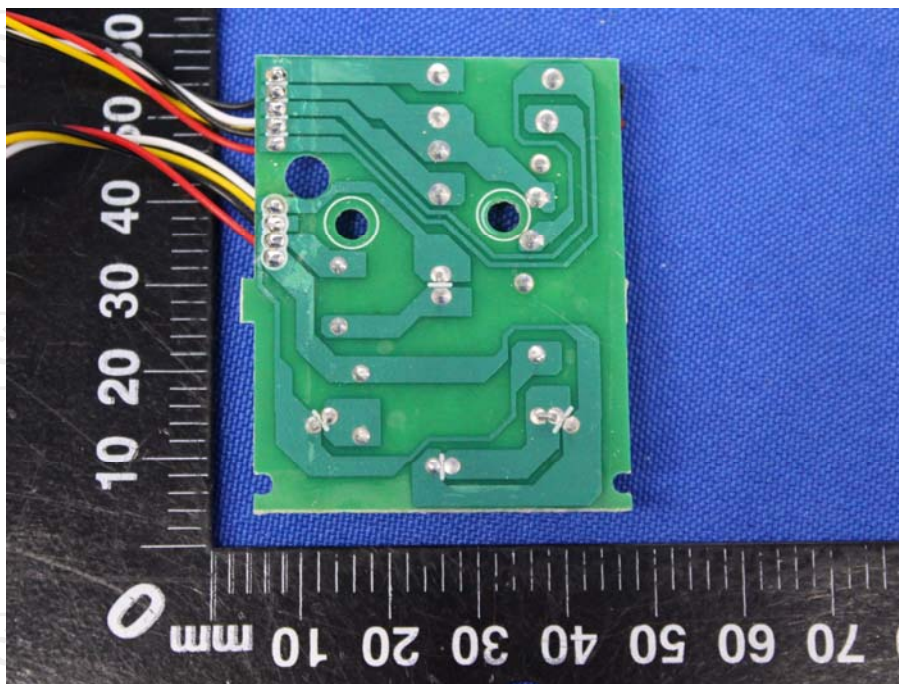
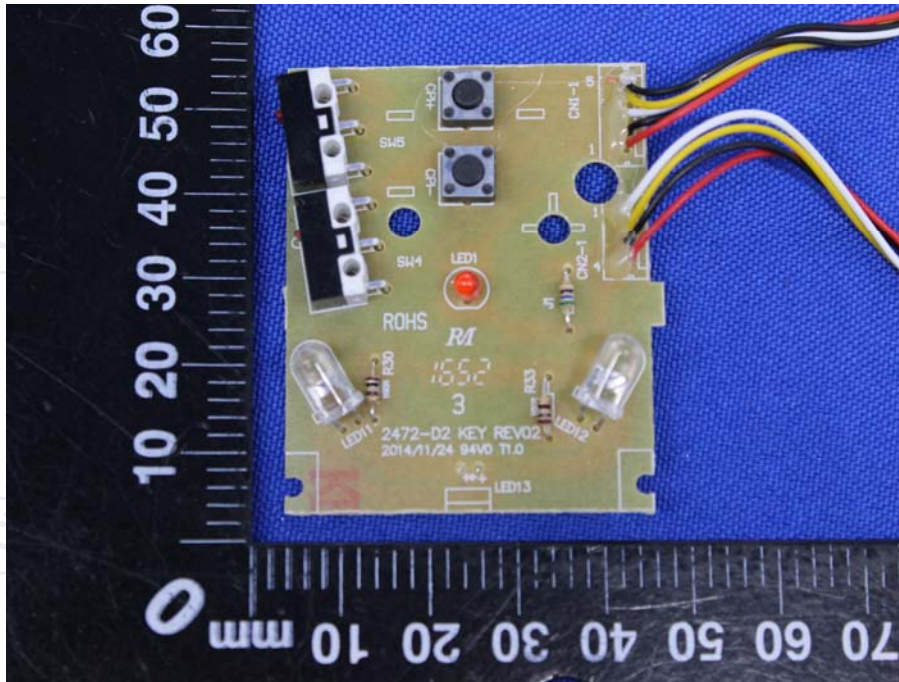

**\*\*\*\*\*END OF REPORT\*\*\*\*\***