

TEST REPORT

FCC ID: TUVET-9025

Product: Bluetooth Headphone

Model No.: GFT-BH11

Additional Model No.: ET-9025

Trade Mark: N/A

Report No.: TCT180122E012

Issued Date: Jan. 30, 2018

Issued for:

Eastern Times Technology Co., Ltd.

**Building D, Nan An Industry Park, Youganpu Village, Fenggang Town,
Dongguan City, Guangdong, China**

Issued By:

Shenzhen Tongce Testing Lab.

**1B/F., Building 1, Yibaolai Industrial Park, Qiaotou, Fuyong, Baoan District,
Shenzhen, Guangdong, China**

TEL: +86-755-27673339

FAX: +86-755-27673332

Note: This report shall not be reproduced except in full, without the written approval of Shenzhen Tongce Testing Lab.

This document may be altered or revised by Shenzhen Tongce Testing Lab. personnel only, and shall be noted in the revision section of the document. The test results in the report only apply to the tested sample.

TABLE OF CONTENTS

1. Test Certification.....	3
2. Test Result Summary	4
3. EUT Description.....	5
4. Genera Information.....	6
4.1. Test environment and mode.....	6
4.2. Description of Support Units.....	6
5. Facilities and Accreditations	7
5.1. Facilities	7
5.2. Location	7
5.3. Measurement Uncertainty.....	7
6. Test Results and Measurement Data	8
6.1. Antenna requirement	8
6.2. Conducted Emission.....	9
6.3. Conducted Output Power	13
6.4. 20dB Occupy Bandwidth	14
6.5. Carrier Frequencies Separation	15
6.6. Hopping Channel Number	16
6.7. Dwell Time.....	17
6.8. Pseudorandom Frequency Hopping Sequence.....	18
6.9. Conducted Band Edge Measurement.....	19
6.10. Conducted Spurious Emission Measurement.....	20
6.11. Radiated Spurious Emission Measurement	21
Appendix A: Test Result of Conducted Test	
Appendix B: Photographs of Test Setup	
Appendix C: Photographs of EUT	

1. Test Certification

Product:	Bluetooth Headphone
Model No.:	GFT-BH11
Additional Model:	ET-9025
Trade Mark:	N/A
Applicant:	Eastern Times Technology Co., Ltd.
Address:	Building D, Nan An Industry Park, Youganpu Village, Fenggang Town, Dongguan City, Guangdong, China
Manufacturer:	Eastern Times Technology Co., Ltd.
Address:	Building D, Nan An Industry Park, Youganpu Village, Fenggang Town, Dongguan City, Guangdong, China
Date of Test:	Jan. 23, 2018 – Jan. 29, 2018
Applicable Standards:	FCC CFR Title 47 Part 15 Subpart C Section 15.247

The above equipment has been tested by Shenzhen Tongce Testing Lab. and found compliance with the requirements set forth in the technical standards mentioned above. The results of testing in this report apply only to the product/system, which was tested. Other similar equipment will not necessarily produce the same results due to production tolerance and measurement uncertainties.

Tested By:

Garen

Date:

Jan. 29, 2018

Garen

Reviewed By:

Beryl Zhao

Date:

Jan. 30, 2018

Beryl Zhao

Approved By:

Tomsin

Date:

Jan. 30, 2018

Tomsin



2. Test Result Summary

Requirement	CFR 47 Section	Result
Antenna Requirement	§15.203/§15.247 (c)	PASS
AC Power Line Conducted Emission	§15.207	PASS
Conducted Peak Output Power	§15.247 (b)(1) §2.1046	PASS
20dB Occupied Bandwidth	§15.247 (a)(1) §2.1049	PASS
Carrier Frequencies Separation	§15.247 (a)(1)	PASS
Hopping Channel Number	§15.247 (a)(1)	PASS
Dwell Time	§15.247 (a)(1)	PASS
Radiated Emission	§15.205/§15.209 §2.1053, §2.1057	PASS
Band Edge	§15.247(d) §2.1051, §2.1057	PASS

Note:

1. PASS: Test item meets the requirement.
2. Fail: Test item does not meet the requirement.
3. N/A: Test case does not apply to the test object.
4. The test result judgment is decided by the limit of test standard.

3. EUT Description

Product:	Bluetooth Headphone
Model No.:	GFT-BH11
Additional Model:	ET-9025
Trade Mark:	N/A
Hardware Version:	HV1.0
Software Version:	SV1.0
BT Version:	V4.1
Operation Frequency:	2402MHz~2480MHz
Transfer Rate:	1/2/3 Mbits/s
Number of Channel:	79
Modulation Type:	GFSK, $\pi/4$ -DQPSK, 8DPSK
Modulation Technology:	FHSS
Antenna Type:	Internal Antenna
Antenna Gain:	0dBi
Power Supply:	Rechargeable Li-ion battery DC 3.7V
Remark:	All models above are identical in interior structure, electrical circuits and components, and just model names are different for the marketing requirement.

Operation Frequency each of channel for GFSK, $\pi/4$ -DQPSK, 8DPSK

Channel	Frequency	Channel	Frequency	Channel	Frequency	Channel	Frequency
0	2402MHz	20	2422MHz	40	2442MHz	60	2462MHz
1	2403MHz	21	2423MHz	41	2443MHz	61	2463MHz
...
10	2412MHz	30	2432MHz	50	2452MHz	70	2472MHz
11	2413MHz	31	2433MHz	51	2453MHz	71	2473MHz
...
18	2420MHz	38	2440MHz	58	2460MHz	78	2480MHz
19	2421MHz	39	2441MHz	59	2461MHz		-

Remark: Channel 0, 39 & 78 have been tested for GFSK, $\pi/4$ -DQPSK, 8DPSK modulation mode.

4. Genera Information

4.1. Test environment and mode

Operating Environment:	
Temperature:	25.0 °C
Humidity:	56 % RH
Atmospheric Pressure:	1010 mbar
Test Mode:	
Engineering mode:	Keep the EUT in continuous transmitting by select channel and modulations with Fully-charged battery
<p>The sample was placed 0.8m & 1.5m for the measurement below & above 1GHz above the ground plane of 3m chamber. Measurements in both horizontal and vertical polarities were performed. During the test, each emission was maximized by: having the EUT continuously working, investigated all operating modes, rotated about all 3 axis (X, Y & Z) and considered typical configuration to obtain worst position, manipulating interconnecting cables, rotating the turntable, varying antenna height from 1m to 4m in both horizontal and vertical polarizations. The emissions worst-case are shown in Test Results of the following pages.</p>	

4.2. Description of Support Units

The EUT has been tested as an independent unit together with other necessary accessories or support units. The following support units or accessories were used to form a representative test configuration during the tests.

Equipment	Model No.	Serial No.	FCC ID	Trade Name
/	/	/	/	/

Note:

1. All the equipment/cables were placed in the worst-case configuration to maximize the emission during the test.
2. Grounding was established in accordance with the manufacturer's requirements and conditions for the intended use.
3. For conducted measurements (Output Power, 20dB Occupied Bandwidth, Carrier Frequencies Separation, Hopping Channel Number, Dwell Time, Spurious Emissions), the antenna of EUT is connected to the test equipment via temporary antenna connector, the antenna connector is soldered on the antenna port of EUT, and the temporary antenna connector is listed in the Test Instruments.

5. Facilities and Accreditations

5.1. Facilities

The test facility is recognized, certified, or accredited by the following organizations:

- FCC - Registration No.: 645098

Shenzhen Tongce Testing Lab

The 3m Semi-anechoic chamber has been registered and fully described in a report with the (FCC) Federal Communications Commission. The acceptance letter from the FCC is maintained in our files.

- IC - Registration No.: 10668A-1

The 3m Semi-anechoic chamber of Shenzhen TCT Testing Technology Co., Ltd. has been registered by Certification and Engineering Bureau of Industry Canada for radio equipment testing

5.2. Location

Shenzhen Tongce Testing Lab

Address: 1B/F., Building 1, Yibaolai Industrial Park, Qiaotou, Fuyong, Baoan District, Shenzhen, Guangdong, China

Tel: 86-755-27673339

5.3. Measurement Uncertainty

The reported uncertainty of measurement $y \pm U$, where expanded uncertainty U is based on a standard uncertainty multiplied by a coverage factor of $k=2$, providing a level of confidence of approximately 95 %.

No.	Item	MU
1	Conducted Emission	$\pm 2.56\text{dB}$
2	RF power, conducted	$\pm 0.12\text{dB}$
3	Spurious emissions, conducted	$\pm 0.11\text{dB}$
4	All emissions, radiated(<1G)	$\pm 3.92\text{dB}$
5	All emissions, radiated(>1G)	$\pm 4.28\text{dB}$
6	Temperature	$\pm 0.1^\circ\text{C}$
7	Humidity	$\pm 1.0\%$

6. Test Results and Measurement Data

6.1. Antenna requirement

Standard requirement:	FCC Part15 C Section 15.203 /247(c)
<p>15.203 requirement: An intentional radiator shall be designed to ensure that no antenna other than that furnished by the responsible party shall be used with the device. The use of a permanently attached antenna or of an antenna that uses a unique coupling to the intentional radiator, the manufacturer may design the unit so that a broken antenna can be replaced by the user, but the use of a standard antenna jack or electrical connector is prohibited.</p> <p>15.247(c) (1)(i) requirement: (i) Systems operating in the 2400-2483.5 MHz band that is used exclusively for fixed. Point-to-point operations may employ transmitting antennas with directional gain greater than 6dBi provided the maximum conducted output power of the intentional radiator is reduced by 1 dB for every 3 dB that the directional gain of the antenna exceeds 6dBi.</p>	
E.U.T Antenna:	
<p>The Bluetooth antenna is internal antenna which permanently attached, and the best case gain of the antenna is 0dBi.</p>	

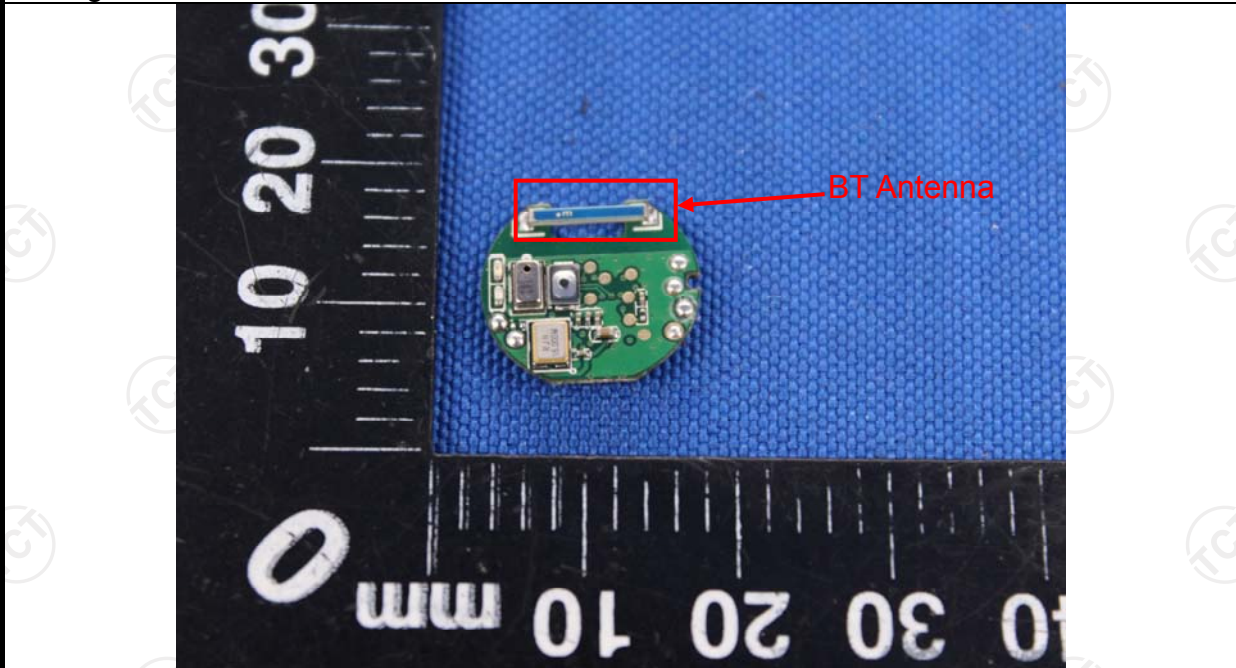

6.2. Conducted Emission

6.2.1. Test Specification

Test Requirement:	FCC Part15 C Section 15.207														
Test Method:	ANSI C63.10:2013														
Frequency Range:	150 kHz to 30 MHz														
Receiver setup:	RBW=9 kHz, VBW=30 kHz, Sweep time=auto														
Limits:	<table border="1"> <thead> <tr> <th rowspan="2">Frequency range (MHz)</th> <th colspan="2">Limit (dBuV)</th> </tr> <tr> <th>Quasi-peak</th> <th>Average</th> </tr> </thead> <tbody> <tr> <td>0.15-0.5</td> <td>66 to 56*</td> <td>56 to 46*</td> </tr> <tr> <td>0.5-5</td> <td>56</td> <td>46</td> </tr> <tr> <td>5-30</td> <td>60</td> <td>50</td> </tr> </tbody> </table>	Frequency range (MHz)	Limit (dBuV)		Quasi-peak	Average	0.15-0.5	66 to 56*	56 to 46*	0.5-5	56	46	5-30	60	50
Frequency range (MHz)	Limit (dBuV)														
	Quasi-peak	Average													
0.15-0.5	66 to 56*	56 to 46*													
0.5-5	56	46													
5-30	60	50													
Test Setup:	<p><i>Remark</i> E.U.T: Equipment Under Test LISN: Line Impedance Stabilization Network Test table height=0.8m</p>														
Test Mode:	Refer to item 4.1														
Test Procedure:	<ol style="list-style-type: none"> 1. The E.U.T is connected to an adapter through a line impedance stabilization network (L.I.S.N.). This provides a 50ohm/50uH coupling impedance for the measuring equipment. 2. The peripheral devices are also connected to the main power through a LISN that provides a 50ohm/50uH coupling impedance with 50ohm termination. (Please refer to the block diagram of the test setup and photographs). 3. Both sides of A.C. line are checked for maximum conducted interference. In order to find the maximum emission, the relative positions of equipment and all of the interface cables must be changed according to ANSI C63.10:2013 on conducted measurement. 														
Test Result:	PASS														

6.2.2. Test Instruments

Conducted Emission Shielding Room Test Site (843)				
Equipment	Manufacturer	Model	Serial Number	Calibration Due
Test Receiver	R&S	ESPI	101401	Jun. 12, 2018
LISN	Schwarzbeck	NSLK 8126	8126453	Sep. 27, 2018
Coax cable (9KHz-30MHz)	TCT	CE-05	N/A	Sep. 27, 2018
EMI Test Software	Shurple Technology	EZ-EMC	N/A	N/A

Note: The calibration interval of the above test instruments is 12 months and the calibrations are traceable to international system unit (SI).

6.2.3. Test data

Please refer to following diagram for individual

Conducted Emission on Line Terminal of the power line (150 kHz to 30MHz)

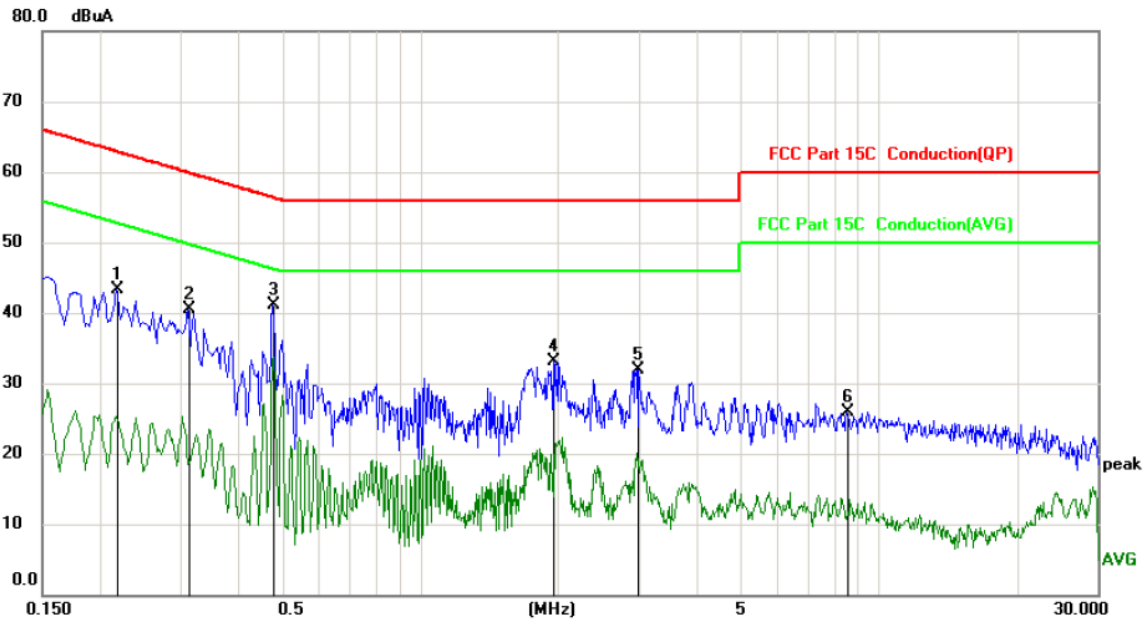

Site: Phase: **L1** Temperature: 25
Limit: FCC Part 15C Conduction(QP) Power: Humidity: 55 %

No.	Mk.	Freq. MHz	Reading Level dBuA	Correct Factor dB	Measure- ment dBuA	Limit dBuA	Over dB	Detector	Comment
1		0.2174	31.78	11.46	43.24	62.92	-19.68	peak	
2		0.3119	29.09	11.41	40.50	59.92	-19.42	peak	
3	*	0.4784	29.83	11.32	41.15	56.37	-15.22	peak	
4		1.9543	21.52	11.68	33.20	56.00	-22.80	peak	
5		2.9759	20.56	11.35	31.91	56.00	-24.09	peak	
6		8.5109	14.78	11.17	25.95	60.00	-34.05	peak	

Note:

Freq. = Emission frequency in MHz

Reading level (dBuV) = Receiver reading

Corr. Factor (dB) = Antenna factor + Cable loss

Measurement (dBuV) = Reading level (dBuV) + Corr. Factor (dB)

Limit (dBuV) = Limit stated in standard

Margin (dB) = Measurement (dBuV) – Limits (dBuV)

Q.P. =Quasi-Peak

AVG =average

* is meaning the worst frequency has been tested in the frequency range 150 kHz to 30MHz

Conducted Emission on Neutral Terminal of the power line (150 kHz to 30MHz)

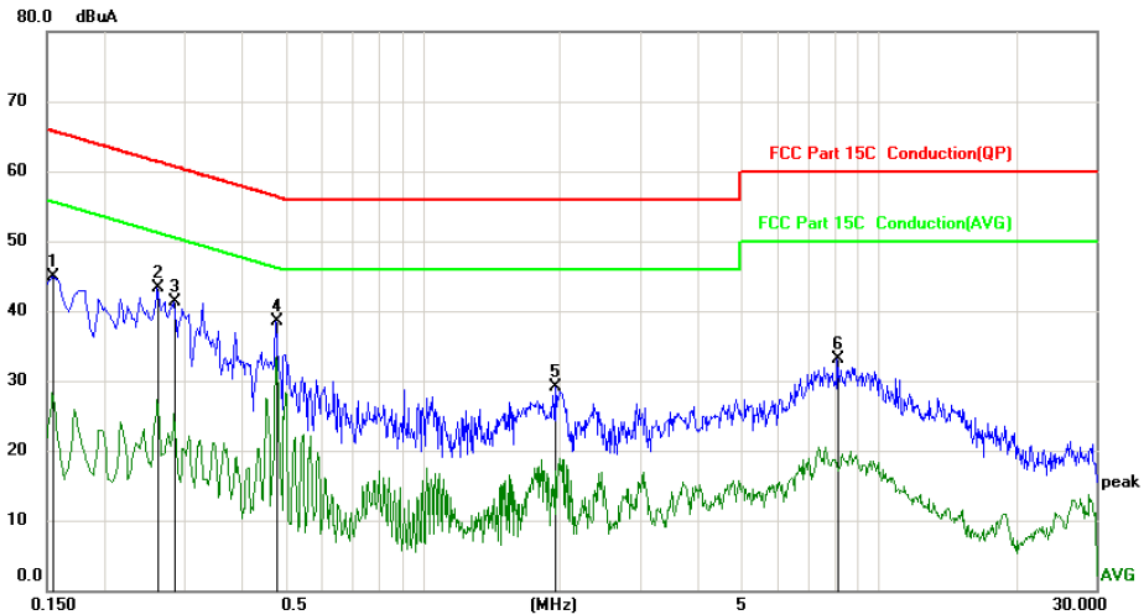

Site: _____ Phase: **N** Temperature: 25
Limit: FCC Part 15C Conduction(QP) Power: _____ Humidity: 55 %

No.	Mk.	Freq. MHz	Reading Level dBuA	Correct Factor dB	Measure- ment dBuA	Limit dBuA	Over dB	Detector	Comment
1		0.1544	33.47	11.49	44.96	65.76	-20.80	peak	
2		0.2625	31.85	11.44	43.29	61.35	-18.06	peak	
3		0.2849	29.97	11.43	41.40	60.67	-19.27	peak	
4	*	0.4784	27.25	11.32	38.57	56.37	-17.80	peak	
5		1.9543	17.41	11.68	29.09	56.00	-26.91	peak	
6		8.1240	22.05	11.11	33.16	60.00	-26.84	peak	

Note1:

- Freq. = Emission frequency in MHz
- Reading level (dBμV) = Receiver reading
- Corr. Factor (dB) = Antenna factor + Cable loss
- Measurement (dBμV) = Reading level (dBμV) + Corr. Factor (dB)
- Limit (dBμV) = Limit stated in standard
- Margin (dB) = Measurement (dBμV) – Limits (dBμV)
- Q.P. =Quasi-Peak AVG =average
- * is meaning the worst frequency has been tested in the frequency range 150 kHz to 30MHz.

Note2:

Measurements were conducted in all three channels (high, middle, low) and three modulation (GFSK, Pi/4 DQPSK, 8DPSK), and the worst case Mode (Low channel and GFSK) was submitted only.

6.3. Conducted Output Power

6.3.1. Test Specification

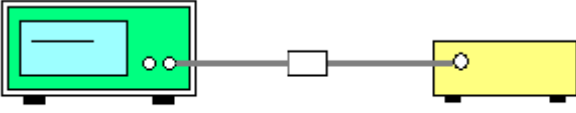
Test Requirement:	FCC Part15 C Section 15.247 (b)(3)
Test Method:	ANSI C63.10:2013
Limit:	Section 15.247 (b) The maximum peak conducted output power of the intentional radiator shall not exceed the following: (1) For frequency hopping systems operating in the 2400-2483.5 MHz band employing at least 75 non-overlapping hopping channels, and all frequency hopping systems in the 5725-5850 MHz band: 1 watt. For all other frequency hopping systems in the 2400-2483.5 MHz band 0.125 watts.
Test Setup:	 <p style="text-align: center;">Spectrum Analyzer EUT</p>
Test Mode:	Transmitting mode with modulation
Test Procedure:	Use the following spectrum analyzer settings: Span = approximately 5 times the 20 dB bandwidth, centered on a hopping channel RBW > the 20 dB bandwidth of the emission being measured VBW ≥ RBW Sweep = auto Detector function = peak Trace = max hold Allow the trace to stabilize. Use the marker-to-peak function to set the marker to the peak of the emission.
Test Result:	PASS

6.3.2. Test Instruments

Equipment	Manufacturer	Model	Serial Number	Calibration Due
Spectrum Analyzer	Agilent	N9020A	MY49100060	Sep. 27, 2018
RF Cable (9KHz-26.5GHz)	TCT	RE-06	N/A	Sep. 27, 2018
Antenna Connector	TCT	RFC-01	N/A	Sep. 27, 2018

Note: The calibration interval of the above test instruments is 12 months and the calibrations are traceable to international system unit (SI).

6.4. 20dB Occupy Bandwidth

6.4.1. Test Specification

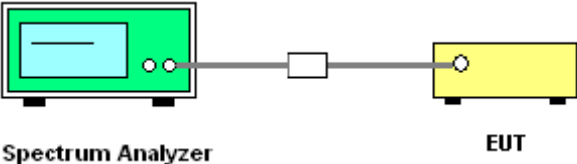
Test Requirement:	FCC Part15 C Section 15.247 (a)(1)
Test Method:	ANSI C63.10:2013
Limit:	N/A
Test Setup:	 <p style="text-align: center;">Spectrum Analyzer EUT</p>
Test Mode:	Transmitting mode with modulation
Test Procedure:	<ol style="list-style-type: none"> 1. The testing follows ANSI C63.10:2013 Measurement Guidelines. 2. The RF output of EUT was connected to the spectrum analyzer by RF cable and attenuator. The path loss was compensated to the results for each measurement. 3. Set to the maximum power setting and enable the EUT transmit continuously. 4. Use the following spectrum analyzer settings for 20dB Bandwidth measurement. Span = approximately 2 to 5 times the 20 dB bandwidth, centered on a hopping channel; $1\% \leq RBW \leq 5\%$ of the 20 dB bandwidth; $VBW \geq 3RBW$; Sweep = auto; Detector function = peak; Trace = max hold. 5. Measure and record the results in the test report.
Test Result:	PASS

6.4.2. Test Instruments

Equipment	Manufacturer	Model	Serial Number	Calibration Due
Spectrum Analyzer	Agilent	N9020A	MY49100060	Sep. 27, 2018
RF Cable (9KHz-26.5GHz)	TCT	RE-06	N/A	Sep. 27, 2018
Antenna Connector	TCT	RFC-01	N/A	Sep. 27, 2018

Note: The calibration interval of the above test instruments is 12 months and the calibrations are traceable to international system unit (SI).

6.5. Carrier Frequencies Separation

6.5.1. Test Specification

Test Requirement:	FCC Part15 C Section 15.247 (a)(1)
Test Method:	ANSI C63.10:2013
Limit:	Frequency hopping systems operating in the 2400-2483.5 MHz band may have hopping channel carrier frequencies that are separated by 25 kHz or two-thirds of the 20 dB bandwidth of the hopping channel, whichever is greater.
Test Setup:	<p style="text-align: center;">Spectrum Analyzer EUT</p>
Test Mode:	Hopping mode
Test Procedure:	<ol style="list-style-type: none">1. The testing follows ANSI C63.10:2013 Measurement Guidelines.2. The RF output of EUT was connected to the spectrum analyzer by RF cable and attenuator. The path loss was compensated to the results for each measurement.3. Set to the maximum power setting and enable the EUT transmit continuously.4. Enable the EUT hopping function.5. Use the following spectrum analyzer settings: Span = wide enough to capture the peaks of two adjacent channels; RBW is set to approximately 30% of the channel spacing, adjust as necessary to best identify the center of each individual channel; VBW\geqRBW; Sweep = auto; Detector function = peak; Trace = max hold.6. Use the marker-delta function to determine the separation between the peaks of the adjacent channels. Record the value in report.
Test Result:	PASS

6.5.2. Test Instruments

Equipment	Manufacturer	Model	Serial Number	Calibration Due
Spectrum Analyzer	Agilent	N9020A	MY49100060	Sep. 27, 2018
RF Cable (9KHz-26.5GHz)	TCT	RE-06	N/A	Sep. 27, 2018
Antenna Connector	TCT	RFC-01	N/A	Sep. 27, 2018

Note: The calibration interval of the above test instruments is 12 months and the calibrations are traceable to international system unit (SI).

6.6. Hopping Channel Number

6.6.1. Test Specification

Test Requirement:	FCC Part15 C Section 15.247 (a)(1)
Test Method:	ANSI C63.10:2013
Limit:	Frequency hopping systems in the 2400-2483.5 MHz band shall use at least 15 channels.
Test Setup:	 <p style="text-align: center;">Spectrum Analyzer EUT</p>
Test Mode:	Hopping mode
Test Procedure:	<ol style="list-style-type: none"> 1. The testing follows ANSI C63.10:2013 Measurement Guidelines. 2. The RF output of EUT was connected to the spectrum analyzer by RF cable and attenuator. The path loss was compensated to the results for each measurement. 3. Set to the maximum power setting and enable the EUT transmit continuously. 4. Enable the EUT hopping function. 5. Use the following spectrum analyzer settings: Span = the frequency band of operation; set the RBW to less than 30% of the channel spacing or the 20 dB bandwidth, whichever is smaller; VBW\geqRBW; Sweep = auto; Detector function = peak; Trace = max hold. 6. The number of hopping frequency used is defined as the number of total channel. 7. Record the measurement data in report.
Test Result:	PASS

6.6.2. Test Instruments

Equipment	Manufacturer	Model	Serial Number	Calibration Due
Spectrum Analyzer	Agilent	N9020A	MY49100060	Sep. 27, 2018
RF Cable (9KHz-26.5GHz)	TCT	RE-06	N/A	Sep. 27, 2018
Antenna Connector	TCT	RFC-01	N/A	Sep. 27, 2018

Note: The calibration interval of the above test instruments is 12 months and the calibrations are traceable to international system unit (SI).

6.7. Dwell Time

6.7.1. Test Specification

Test Requirement:	FCC Part15 C Section 15.247 (a)(1)
Test Method:	ANSI C63.10:2013
Limit:	The average time of occupancy on any channel shall not be greater than 0.4 seconds within a period of 0.4 seconds multiplied by the number of hopping channels employed.
Test Setup:	 <p style="text-align: center;">Spectrum Analyzer EUT</p>
Test Mode:	Hopping mode
Test Procedure:	<ol style="list-style-type: none"> The testing follows ANSI C63.10:2013 Measurement Guidelines. The RF output of EUT was connected to the spectrum analyzer by RF cable and attenuator. The path loss was compensated to the results for each measurement. Set to the maximum power setting and enable the EUT transmit continuously. Enable the EUT hopping function. Use the following spectrum analyzer settings: Span = zero span, centered on a hopping channel; RBW shall be \leq channel spacing and where possible RBW should be set $\gg 1 / T$, where T is the expected dwell time per channel; VBW \geq RBW; Sweep = as necessary to capture the entire dwell time per hopping channel; Detector function = peak; Trace = max hold. Measure and record the results in the test report.
Test Result:	PASS

6.7.2. Test Instruments

Equipment	Manufacturer	Model	Serial Number	Calibration Due
Spectrum Analyzer	Agilent	N9020A	MY49100060	Sep. 27, 2018
RF Cable (9KHz-26.5GHz)	TCT	RE-06	N/A	Sep. 27, 2018
Antenna Connector	TCT	RFC-01	N/A	Sep. 27, 2018

Note: The calibration interval of the above test instruments is 12 months and the calibrations are traceable to international system unit (SI).

6.8. Pseudorandom Frequency Hopping Sequence

Test Requirement:	FCC Part15 C Section 15.247 (a)(1) requirement:
--------------------------	--

Frequency hopping systems shall have hopping channel carrier frequencies separated by a minimum of 25 kHz or the 20 dB bandwidth of the hopping channel, whichever is greater.

Alternatively, Frequency hopping systems operating in the 2400-2483.5 MHz band may have hopping channel carrier frequencies that are separated by 25 kHz or two-thirds of the 20 dB bandwidth of the hopping channel, whichever is greater, provided the systems operate with an output power no greater than 125 mW. The system shall hop to channel frequencies that are selected at the system hopping rate from a Pseudorandom ordered list of hopping frequencies. Each frequency must be used equally on the average by each transmitter. The system receivers shall have input bandwidths that match the hopping channel bandwidths of their corresponding transmitters and shall shift frequencies in synchronization with the transmitted signals.

EUT Pseudorandom Frequency Hopping Sequence

The pseudorandom sequence may be generated in a nine-stage shift register whose 5th and 9th stage outputs are added in a modulo-two addition stage. And the result is fed back to the input of the first stage. The sequence begins with the first one of 9 consecutive ones; i.e. the shift register is initialized with nine ones.

- Number of shift register stages: 9
- Length of pseudo-random sequence: $2^9 - 1 = 511$ bits
- Longest sequence of zeros: 8 (non-inverted signal)

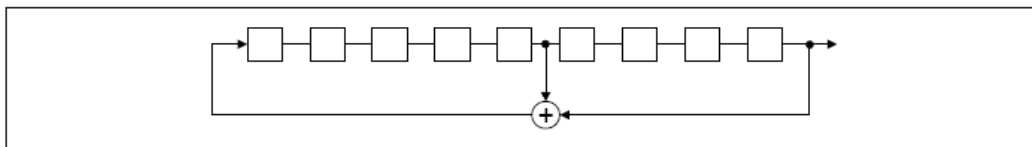

Linear Feedback Shift Register for Generation of the PRBS sequence

An example of Pseudorandom Frequency Hopping Sequence as follow:

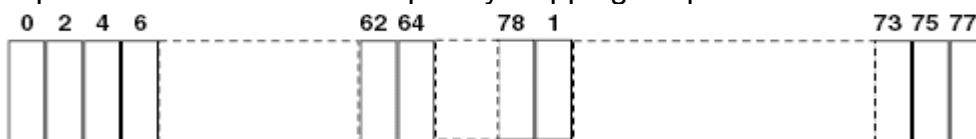

Each frequency used equally on the average by each transmitter. The system receivers have input bandwidths that match the hopping channel bandwidths of their corresponding transmitters and shift frequencies in synchronization with the transmitted signals.

6.9. Conducted Band Edge Measurement

6.9.1. Test Specification

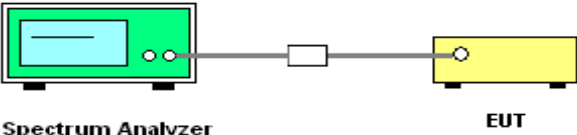
Test Requirement:	FCC Part15 C Section 15.247 (d)
Test Method:	ANSI C63.10:2013
Limit:	In any 100 kHz bandwidth outside the intentional radiation frequency band, the radio frequency power shall be at least 20 dB below the highest level of the radiated power. In addition, radiated emissions which fall in the restricted bands must also comply with the radiated emission limits.
Test Setup:	 <p style="text-align: center;">Spectrum Analyzer EUT</p>
Test Mode:	Transmitting mode with modulation
Test Procedure:	<ol style="list-style-type: none"> 1. The testing follows the guidelines in Band-edge Compliance of RF Conducted Emissions of ANSI C63.10:2013 Measurement Guidelines. 2. Set to the maximum power setting and enable the EUT transmit continuously. 3. Set RBW = 100 kHz ($\geq 1\%$ span=10MHz), VBW = 300 kHz (\geqRBW). Band edge emissions must be at least 20 dB down from the highest emission level within the authorized band as measured with a 100kHz RBW. The attenuation shall be 30 dB instead of 20 dB when RMS conducted output power procedure is used. 4. Enable hopping function of the EUT and then repeat step 2 and 3. 5. Measure and record the results in the test report.
Test Result:	PASS

6.9.2. Test Instruments

Equipment	Manufacturer	Model	Serial Number	Calibration Due
Spectrum Analyzer	Agilent	N9020A	MY49100060	Sep. 27, 2018
RF Cable (9KHz-26.5GHz)	TCT	RE-06	N/A	Sep. 27, 2018
Antenna Connector	TCT	RFC-01	N/A	Sep. 27, 2018

Note: The calibration interval of the above test instruments is 12 months and the calibrations are traceable to international system unit (SI).

6.10. Conducted Spurious Emission Measurement

6.10.1. Test Specification

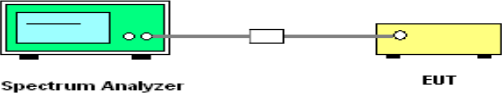
Test Requirement:	FCC Part15 C Section 15.247 (d)
Test Method:	ANSI C63.10:2013
Limit:	In any 100 kHz bandwidth outside the intentional radiation frequency band, the radio frequency power shall be at least 20 dB below the highest level of the radiated power. In addition, radiated emissions which fall in the restricted bands must also comply with the radiated emission limits.
Test Setup:	 <p style="text-align: center;">Spectrum Analyzer EUT</p>
Test Mode:	Transmitting mode with modulation
Test Procedure:	<ol style="list-style-type: none"> 1. The testing follows the guidelines in Spurious RF Conducted Emissions of ANSI C63.10:2013 Measurement Guidelines 2. The RF output of EUT was connected to the spectrum analyzer by RF cable and attenuator. The path loss was compensated to the results for each measurement. 3. Set to the maximum power setting and enable the EUT transmit continuously. 4. Set RBW = 100 kHz, VBW = 300kHz, scan up through 10th harmonic. All harmonics / spurs must be at least 20 dB down from the highest emission level within the authorized band as measured with a 100 kHz RBW. 5. Measure and record the results in the test report. 6. The RF fundamental frequency should be excluded against the limit line in the operating frequency band.
Test Result:	PASS

6.10.2. Test Instruments

RF Test Room				
Equipment	Manufacturer	Model	Serial Number	Calibration Due
Spectrum Analyzer	Agilent	N9020A	MY49100060	Sep. 27, 2018
RF Cable (9KHz-40GHz)	TCT	RE-06	N/A	Sep. 27, 2018
Antenna Connector	TCT	RFC-01	N/A	Sep. 27, 2018

Note: The calibration interval of the above test instruments is 12 months and the calibrations are traceable to international system unit (SI).

6.11. Radiated Spurious Emission Measurement

6.11.1. Test Specification

Test Requirement:	FCC Part15 C Section 15.209					
Test Method:	ANSI C63.10:2013					
Frequency Range:	9 kHz to 25 GHz					
Measurement Distance:	3 m					
Antenna Polarization:	Horizontal & Vertical					
Receiver Setup:	Frequency	Detector	RBW	VBW	Remark	
	9kHz- 150kHz	Quasi-peak	200Hz	1kHz	Quasi-peak Value	
	150kHz- 30MHz	Quasi-peak	9kHz	30kHz	Quasi-peak Value	
	30MHz-1GHz	Quasi-peak	100KHz	300KHz	Quasi-peak Value	
	Above 1GHz	Peak	1MHz	3MHz	Peak Value	
		Peak	1MHz	10Hz	Average Value	
Limit:	Frequency		Field Strength (microvolts/meter)		Measurement Distance (meters)	
	0.009-0.490		2400/F(KHz)		300	
	0.490-1.705		24000/F(KHz)		30	
	1.705-30		30		30	
	30-88		100		3	
	88-216		150		3	
	216-960		200		3	
	Above 960		500		3	
	Frequency		Field Strength (microvolts/meter)		Measurement Distance (meters)	Detector
	Above 1GHz		500		3	Average
		5000		3	Peak	
Test setup:	For radiated emissions below 30MHz					
	<p>Distance = 3m</p> <p>EUT</p> <p>Turn table</p> <p>Ground Plane</p> <p>Computer</p> <p>Pre -Amplifier</p> <p>Receiver</p>					
	30MHz to 1GHz					

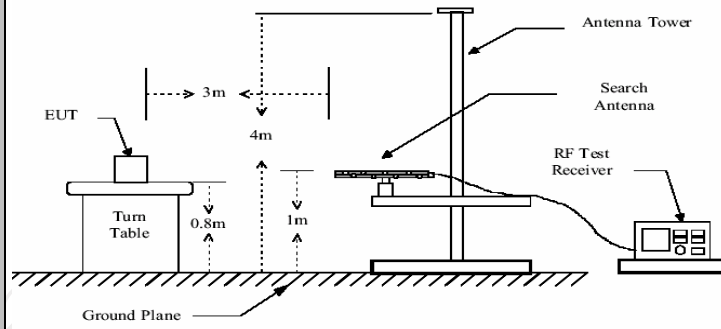

Above 1GHz



Test Mode:

Transmitting mode with modulation

Test Procedure:

1. The testing follows the guidelines in Spurious Radiated Emissions of ANSI C63.10:2013 Measurement Guidelines.
2. For the radiated emission test below 1GHz:
The EUT was placed on a turntable with 0.8 meter above ground. The EUT was set 3 meters from the interference receiving antenna, which was mounted on the top of a variable height antenna tower. The EUT was arranged to its worst case and then tune the antenna tower (from 1 m to 4 m) and turntable (from 0 degree to 360 degrees) to find the maximum reading. A pre-amp and a high PASS filter are used for the test in order to get better signal level.
- For the radiated emission test above 1GHz:
Place the measurement antenna on a turntable with 1.5 meter above ground, which is away from each area of the EUT determined to be a source of emissions at the specified measurement distance, while keeping the measurement antenna aimed at the source of emissions at each frequency of significant emissions, with polarization oriented for maximum response. The measurement antenna may have to be higher or lower than the EUT,

	<p>depending on the radiation pattern of the emission and staying aimed at the emission source for receiving the maximum signal. The final measurement antenna elevation shall be that which maximizes the emissions. The measurement antenna elevation for maximum emissions shall be restricted to a range of heights of from 1 m to 4 m above the ground or reference ground plane.</p> <p>3. Set to the maximum power setting and enable the EUT transmit continuously.</p> <p>4. Use the following spectrum analyzer settings:</p> <p>(1) Span shall wide enough to fully capture the emission being measured;</p> <p>(2) Set RBW=100 kHz for f < 1 GHz, RBW=1MHz for f>1GHz ; VBW≥RBW; Sweep = auto; Detector function = peak; Trace = max hold for peak</p> <p>(3) For average measurement: use duty cycle correction factor method per 15.35(c). Duty cycle = On time/100 milliseconds On time =N1*L1+N2*L2+...+Nn-1*LNn-1+Nn*Ln Where N1 is number of type 1 pulses, L1 is length of type 1 pulses, etc. Average Emission Level = Peak Emission Level + 20*log(Duty cycle)</p> <p>Corrected Reading: Antenna Factor + Cable Loss + Read Level - Preamp Factor = Level</p>
Test results:	PASS

6.11.2. Test Instruments

Radiated Emission Test Site (966)				
Name of Equipment	Manufacturer	Model	Serial Number	Calibration Due
Test Receiver	ROHDE&SCHW ARZ	ESVD	100008	Sep. 27, 2018
Spectrum Analyzer	ROHDE&SCHW ARZ	FSQ	200061	Sep. 27, 2018
Pre-amplifier	EM Electronics Corporation CO.,LTD	EM30265	07032613	Sep. 27, 2018
Pre-amplifier	HP	8447D	2727A05017	Sep. 27, 2018
Loop antenna	ZHINAN	ZN30900A	12024	Sep. 27, 2018
Broadband Antenna	Schwarzbeck	VULB9163	340	Sep. 27, 2018
Horn Antenna	Schwarzbeck	BBHA 9120D	631	Sep. 27, 2018
Horn Antenna	Schwarzbeck	BBH 9170	582	Jun. 07, 2018
Antenna Mast	Keleto	CC-A-4M	N/A	N/A
Coax cable (9KHz-1GHz)	TCT	RE-low-01	N/A	Sep. 27, 2018
Coax cable (9KHz-40GHz)	TCT	RE-high-02	N/A	Sep. 27, 2018
Coax cable (9KHz-1GHz)	TCT	RE-low-03	N/A	Sep. 27, 2018
Coax cable (9KHz-40GHz)	TCT	RE-high-04	N/A	Sep. 27, 2018
EMI Test Software	Shurple Technology	EZ-EMC	N/A	N/A

Note: The calibration interval of the above test instruments is 12 months and the calibrations are traceable to international system unit (SI).

6.11.3. Test Data

Duty cycle correction factor for average measurement

3DH5 on time (One Pulse) Plot on Channel 39

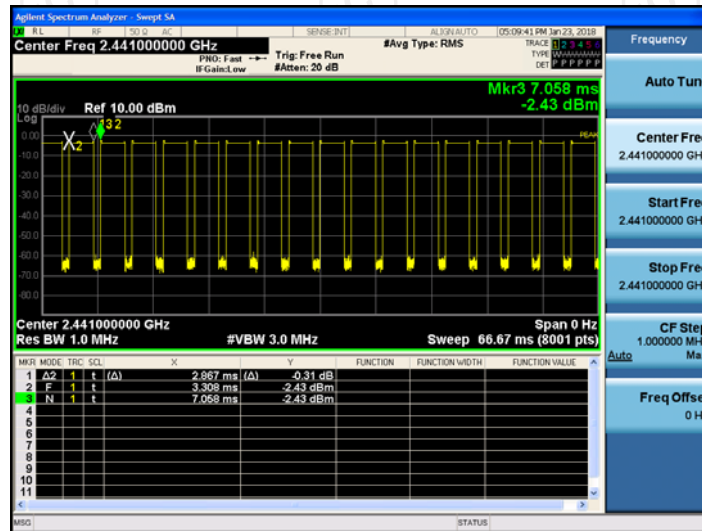

3DH5 on time (Count Pulses) Plot on Channel 39

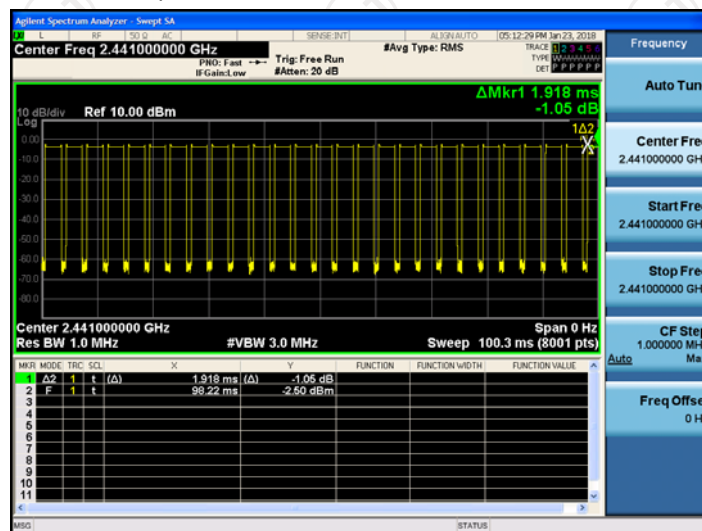

Note:

1. Worst case Duty cycle = on time/100 milliseconds = (2.867*26+1.918)/100= 0.7646
2. Worst case Duty cycle correction factor = 20*log (Duty cycle) = -2.33dB
3. 3DH5 has the highest duty cycle worst case and is reported.
4. The average levels were calculated from the peak level corrected with duty cycle correction factor (-2.33dB) derived from 20log (dwell time/100ms). This correction is only for signals that hop with the fundamental signal, such as band-edge and harmonic. Other spurious signals that are independent of the hopping signal would not use this correction.

Please refer to following diagram for individual

Below 1GHz

Horizontal:

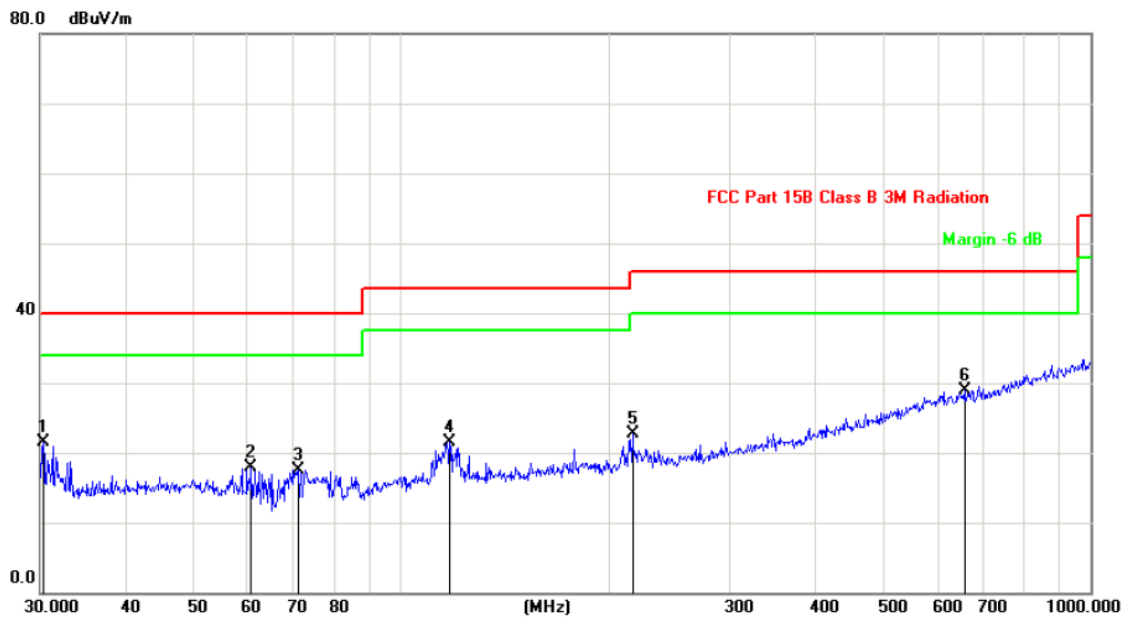

Site: Polarization: **Horizontal** Temperature: 25
 Limit: FCC Part 15B Class B 3M Radiation Power: DC 3.7V Humidity: 55 %

No.	Mk.	Freq.	Reading Level	Correct Factor	Measurement	Limit	Over	Antenna Height	Table Degree	
		MHz	dBuV	dB	dBuV/m	dB/m	dB	cm	degree	Comment
1		30.3173	35.20	-13.76	21.44	40.00	-18.56			peak
2		60.7044	31.62	-13.71	17.91	40.00	-22.09			peak
3		71.0803	34.79	-17.24	17.55	40.00	-22.45			peak
4		117.7725	35.22	-13.81	21.41	43.50	-22.09			peak
5		216.7828	34.81	-12.09	22.72	46.00	-23.28			peak
6	*	656.5300	29.29	-0.34	28.95	46.00	-17.05			peak

Vertical:

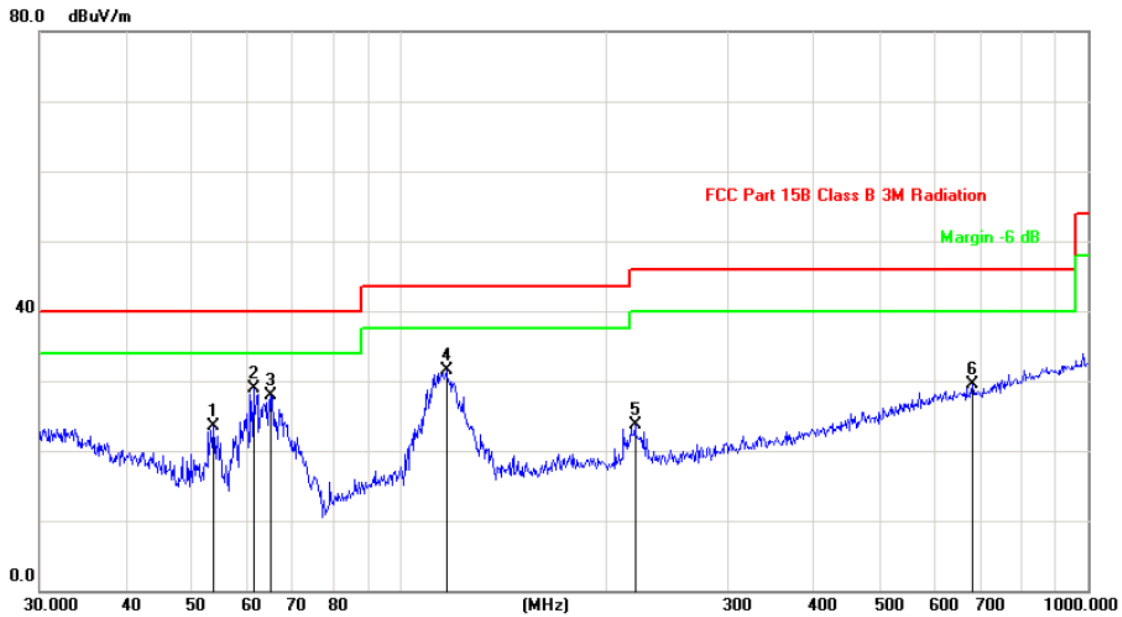

Site: Polarization: **Vertical** Temperature: 25
 Limit: FCC Part 15B Class B 3M Radiation Power: DC 3.7V Humidity: 55 %

No.	Mk.	Freq.	Reading Level	Correct Factor	Measurement	Limit	Over	Antenna Height	Table Degree	
		MHz	dBuV	dB	dBuV/m	dB/m	dB	cm	degree	Comment
1		53.6932	36.40	-12.92	23.48	40.00	-16.52	peak		
2	*	61.3463	42.78	-13.96	28.82	40.00	-11.18	peak		
3		65.1145	43.36	-15.38	27.98	40.00	-12.02	peak		
4		116.9495	45.27	-13.67	31.60	43.50	-11.90	peak		
5		219.8449	35.69	-11.98	23.71	46.00	-22.29	peak		
6		679.9600	29.65	-0.17	29.48	46.00	-16.52	peak		

Note: 1. The low frequency, which started from 9KHz~30MHz, was pre-scanned and the result which was 20dB lower than the limit line per 15.31(o) was not reported

2. Measurements were conducted in all three channels (high, middle, low) and three modulation (GFSK, Pi/4 DQPSK, 8DPSK) and the worst case Mode (Low channel and GFSK) was submitted only.

Above 1GHz

Modulation Type: GFSK									
Low channel: 2402 MHz									
Frequency (MHz)	Ant. Pol. H/V	Peak reading (dBμV)	AV reading (dBμV)	Correction Factor (dB/m)	Emission Level		Peak limit (dBμV/m)	AV limit (dBμV/m)	Margin (dB)
					Peak (dBμV/m)	AV (dBμV/m)			
2390	H	45.64	---	-8.27	37.37	---	74	54	-16.63
4804	H	47.38	---	0.66	48.04	---	74	54	-5.96
7206	H	37.82	---	9.5	47.32	---	74	54	-6.68
---	H	---	---	---	---	---	---	---	---
2390	V	42.81	---	-8.27	34.54	---	74	54	-19.46
4804	V	43.2	---	0.66	43.86	---	74	54	-10.14
7206	V	38.75	---	9.5	48.25	---	74	54	-5.75
---	V	---	---	---	---	---	---	---	---

Middle channel: 2441 MHz									
Frequency (MHz)	Ant. Pol. H/V	Peak reading (dBμV)	AV reading (dBμV)	Correction Factor (dB/m)	Emission Level		Peak limit (dBμV/m)	AV limit (dBμV/m)	Margin (dB)
					Peak (dBμV/m)	AV (dBμV/m)			
4882	H	45.06	---	0.99	46.05	---	74	54	-7.95
7323	H	39.13	---	9.87	49	---	74	54	-5
---	H	---	---	---	---	---	---	---	---
4882	V	45.18	---	0.99	46.17	---	74	54	-7.83
7323	V	38.65	---	9.87	48.52	---	74	54	-5.48
---	V	---	---	---	---	---	---	---	---

High channel: 2480 MHz									
Frequency (MHz)	Ant. Pol. H/V	Peak reading (dBμV)	AV reading (dBμV)	Correction Factor (dB/m)	Emission Level		Peak limit (dBμV/m)	AV limit (dBμV/m)	Margin (dB)
					Peak (dBμV/m)	AV (dBμV/m)			
2483.5	H	45.63	---	-7.83	37.8	---	74	54	-16.2
4960	H	48.33	---	1.33	49.66	---	74	54	-4.34
7440	H	39.7	---	10.22	49.92	---	74	54	-4.08
---	H	---	---	---	---	---	---	---	---
2483.5	V	48.12	---	-7.83	40.29	---	74	54	-13.71
4960	V	45.83	---	1.33	47.16	---	74	54	-6.84
7440	V	37.61	---	10.22	47.83	---	74	54	-6.17
---	V	---	---	---	---	---	---	---	---

Note:

1. Emission Level=Peak Reading + Correction Factor; Correction Factor= Antenna Factor + Cable loss – Pre-amplifier
2. Margin (dB) = Emission Level (Peak) (dBμV/m)-Average limit (dBμV/m)
3. The emission levels of other frequencies are very lower than the limit and not show in test report.
4. Measurements were conducted from 1 GHz to the 10th harmonic of highest fundamental frequency.
5. Data of measurement shown “---“in the above table mean that the reading of emissions is attenuated more than 20 dB below the limits or the field strength is too small to be measured.
6. Measurements were conducted in all three modulation (GFSK, Pi/4 DQPSK, 8DPSK), and the worst case Mode (GFSK) was submitted only.

Appendix A: Test Result of Conducted Test 20dB Occupied Bandwidth

Test Result

Mode	Channel.	20dB Bandwidth [MHz]	99% OBW [MHz]	Verdict
GFSK	LCH	1.099	0.92084	PASS
GFSK	MCH	1.083	0.92015	PASS
GFSK	HCH	1.086	0.93199	PASS
$\pi/4$ DQPSK	LCH	1.275	1.1524	PASS
$\pi/4$ DQPSK	MCH	1.263	1.1486	PASS
$\pi/4$ DQPSK	HCH	1.275	1.1455	PASS
8DPSK	LCH	1.268	1.1480	PASS
8DPSK	MCH	1.265	1.1521	PASS
8DPSK	HCH	1.264	1.1464	PASS

Test Graph

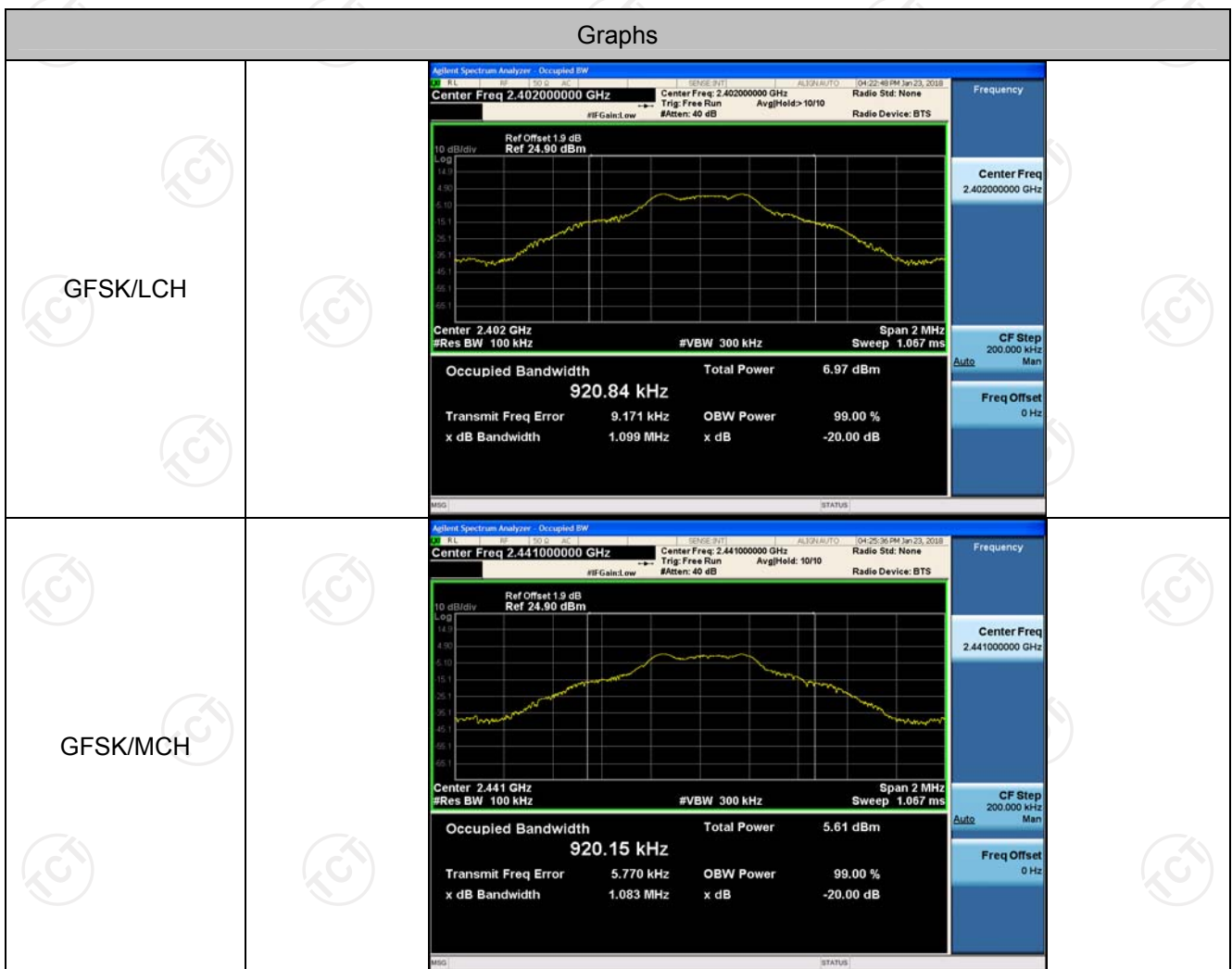

<p>GFSK/HCH</p>	 <p>Agilent Spectrum Analyzer - Occupied BW</p> <p>Center Freq 2.480000000 GHz</p> <p>Ref Offset 1.9 dB Ref 24.90 dBm</p> <p>Center 2.48 GHz #Res BW 100 kHz</p> <p>Occupied Bandwidth 931.99 kHz</p> <p>Total Power 4.15 dBm</p> <p>Transmit Freq Error 4.560 kHz</p> <p>x dB Bandwidth 1.086 MHz</p> <p>OBW Power 99.00 %</p> <p>x dB -20.00 dB</p>
<p>$\pi/4$DQPSK/LCH</p>	 <p>Agilent Spectrum Analyzer - Occupied BW</p> <p>Center Freq 2.402000000 GHz</p> <p>Ref Offset 1.9 dB Ref 24.90 dBm</p> <p>Center 2.402 GHz #Res BW 100 kHz</p> <p>Occupied Bandwidth 1.1524 MHz</p> <p>Total Power 6.44 dBm</p> <p>Transmit Freq Error 2.939 kHz</p> <p>x dB Bandwidth 1.275 MHz</p> <p>OBW Power 99.00 %</p> <p>x dB -20.00 dB</p>
<p>$\pi/4$DQPSK/MCH</p>	 <p>Agilent Spectrum Analyzer - Occupied BW</p> <p>Center Freq 2.441000000 GHz</p> <p>Ref Offset 1.9 dB Ref 24.90 dBm</p> <p>Center 2.441 GHz #Res BW 100 kHz</p> <p>Occupied Bandwidth 1.1486 MHz</p> <p>Total Power 5.22 dBm</p> <p>Transmit Freq Error -1.218 kHz</p> <p>x dB Bandwidth 1.263 MHz</p> <p>OBW Power 99.00 %</p> <p>x dB -20.00 dB</p>

<p>TT/4DQPSK/HCH</p>	<p>Agilent Spectrum Analyzer - Occupied BW</p> <p>Center Freq 2.480000000 GHz</p> <p>Center Freq: 2.480000000 GHz</p> <p>Trig: Free Run</p> <p>Avg/Hold: 10/10</p> <p>Radio Std: None</p> <p>Radio Device: BTS</p> <p>Ref Offset 1.9 dB</p> <p>Ref 24.90 dBm</p> <p>Center 2.48 GHz</p> <p>#Res BW 100 kHz</p> <p>#VBW 300 kHz</p> <p>Span 2 MHz</p> <p>Sweep 1.067 ms</p> <p>Occupied Bandwidth 1.1455 MHz</p> <p>Total Power 3.65 dBm</p> <p>Transmit Freq Error -610 Hz</p> <p>OBW Power 99.00 %</p> <p>x dB Bandwidth 1.275 MHz</p> <p>x dB -20.00 dB</p> <p>Frequency 2.480000000 GHz</p> <p>CF Step 200.000 kHz</p> <p>Freq Offset 0 Hz</p>
<p>8DPSK/LCH</p>	<p>Agilent Spectrum Analyzer - Occupied BW</p> <p>Center Freq 2.402000000 GHz</p> <p>Center Freq: 2.402000000 GHz</p> <p>Trig: Free Run</p> <p>Avg/Hold: 10/10</p> <p>Radio Std: None</p> <p>Radio Device: BTS</p> <p>Ref Offset 1.9 dB</p> <p>Ref 24.90 dBm</p> <p>Center 2.402 GHz</p> <p>#Res BW 100 kHz</p> <p>#VBW 300 kHz</p> <p>Span 2 MHz</p> <p>Sweep 1.067 ms</p> <p>Occupied Bandwidth 1.1480 MHz</p> <p>Total Power 6.54 dBm</p> <p>Transmit Freq Error 10.279 kHz</p> <p>OBW Power 99.00 %</p> <p>x dB Bandwidth 1.268 MHz</p> <p>x dB -20.00 dB</p> <p>Frequency 2.402000000 GHz</p> <p>CF Step 200.000 kHz</p> <p>Freq Offset 0 Hz</p>
<p>8DPSK/MCH</p>	<p>Agilent Spectrum Analyzer - Occupied BW</p> <p>Center Freq 2.441000000 GHz</p> <p>Center Freq: 2.441000000 GHz</p> <p>Trig: Free Run</p> <p>Avg/Hold: 10/10</p> <p>Radio Std: None</p> <p>Radio Device: BTS</p> <p>Ref Offset 1.9 dB</p> <p>Ref 24.90 dBm</p> <p>Center 2.441 GHz</p> <p>#Res BW 100 kHz</p> <p>#VBW 300 kHz</p> <p>Span 2 MHz</p> <p>Sweep 1.067 ms</p> <p>Occupied Bandwidth 1.1521 MHz</p> <p>Total Power 5.26 dBm</p> <p>Transmit Freq Error 11.780 kHz</p> <p>OBW Power 99.00 %</p> <p>x dB Bandwidth 1.265 MHz</p> <p>x dB -20.00 dB</p> <p>Frequency 2.441000000 GHz</p> <p>CF Step 200.000 kHz</p> <p>Freq Offset 0 Hz</p>

8DPSK/HCH



Carrier Frequency Separation

Result Table

Mode	Channel.	Carrier Frequency Separation [MHz]	Verdict
GFSK	LCH	0.996	PASS
GFSK	MCH	0.999	PASS
GFSK	HCH	1.003	PASS
$\pi/4$ DQPSK	LCH	0.997	PASS
$\pi/4$ DQPSK	MCH	1.004	PASS
$\pi/4$ DQPSK	HCH	1.003	PASS
8DPSK	LCH	1.004	PASS
8DPSK	MCH	1.003	PASS
8DPSK	HCH	0.998	PASS

Test Graph



<p>GFSK/HCH</p>		<p>Frequency</p> <p>Auto Tune</p> <p>Center Freq 2.479500000 GHz</p> <p>Start Freq 2.478500000 GHz</p> <p>Stop Freq 2.480500000 GHz</p> <p>CF Step 200.000 kHz</p> <p>Freq Offset 0 Hz</p>
<p>$\pi/4$DQPSK/LCH</p>		<p>Frequency</p> <p>Auto Tune</p> <p>Center Freq 2.402500000 GHz</p> <p>Start Freq 2.401500000 GHz</p> <p>Stop Freq 2.403500000 GHz</p> <p>CF Step 200.000 kHz</p> <p>Freq Offset 0 Hz</p>
<p>$\pi/4$DQPSK/MCH</p>		<p>Frequency</p> <p>Auto Tune</p> <p>Center Freq 2.440500000 GHz</p> <p>Start Freq 2.439500000 GHz</p> <p>Stop Freq 2.441500000 GHz</p> <p>CF Step 200.000 kHz</p> <p>Freq Offset 0 Hz</p>

<p>TT/4DQPSK/HCH</p>		<p>Frequency</p> <p>Auto Tune</p> <p>Center Freq 2.479500000 GHz</p> <p>Start Freq 2.478500000 GHz</p> <p>Stop Freq 2.480500000 GHz</p> <p>CF Step 200.000 kHz</p> <p>Freq Offset 0 Hz</p>
<p>8DPSK/LCH</p>		<p>Frequency</p> <p>Auto Tune</p> <p>Center Freq 2.402500000 GHz</p> <p>Start Freq 2.401500000 GHz</p> <p>Stop Freq 2.403500000 GHz</p> <p>CF Step 200.000 kHz</p> <p>Freq Offset 0 Hz</p>
<p>8DPSK/MCH</p>		<p>Frequency</p> <p>Auto Tune</p> <p>Center Freq 2.440500000 GHz</p> <p>Start Freq 2.439500000 GHz</p> <p>Stop Freq 2.441500000 GHz</p> <p>CF Step 200.000 kHz</p> <p>Freq Offset 0 Hz</p>

8DPSK/HCH

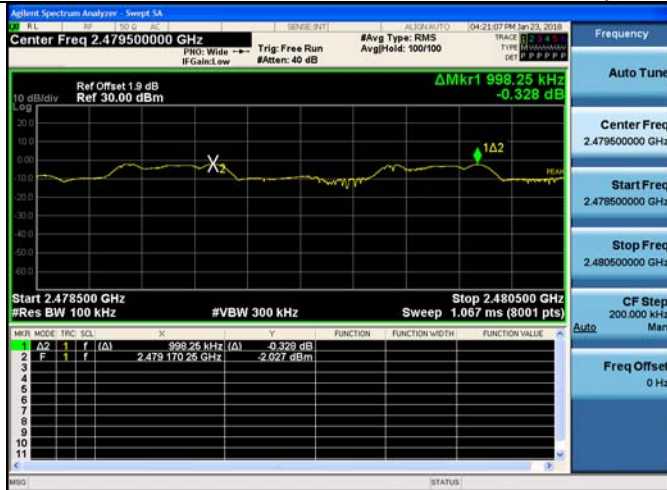

Dwell Time

Result Table

Mode	Packet	Hops Over Occupancy Time (hops)	Package Transfer Time (ms)	Dwell time (second)	Limit (second)	Result
GFSK	DH1	320	0.350	0.112	0.4	PASS
GFSK	DH3	160	1.608	0.257	0.4	PASS
GFSK	DH5	106.67	2.858	0.305	0.4	PASS
Pi/4 DQPSK	2-DH1	320	0.367	0.117	0.4	PASS
Pi/4 DQPSK	2-DH3	160	1.617	0.259	0.4	PASS
Pi/4 DQPSK	2-DH5	106.67	2.858	0.305	0.4	PASS
8DPSK	3-DH1	320	0.367	0.117	0.4	PASS
8DPSK	3-DH3	160	1.617	0.259	0.4	PASS
8DPSK	3-DH5	106.67	2.867	0.306	0.4	PASS

Note: 1. In normal mode, hopping rate is 1600 hops/s with 6 slots in 79 hopping channels.

For DH1, With channel hopping rate (1600 / 2 / 79) in Occupancy Time Limit (0.4 x 79) (s), Hops Over Occupancy Time comes to (1600 / 2 / 79) x (0.4 x 79) = 320 hops

For DH3, With channel hopping rate (1600 / 6 / 79) in Occupancy Time Limit (0.4 x 79) (s), Hops Over Occupancy Time comes to (1600 / 4 / 79) x (0.4 x 79) = 160 hops

For DH5, With channel hopping rate (1600 / 6 / 79) in Occupancy Time Limit (0.4 x 79) (s), Hops Over Occupancy Time comes to (1600 / 6 / 79) x (0.4 x 79) = 106.67 hops

2. Dwell Time(s) = Hops Over Occupancy Time (hops) x Package Transfer Time

Test plots as follows:

GFSK
DH1

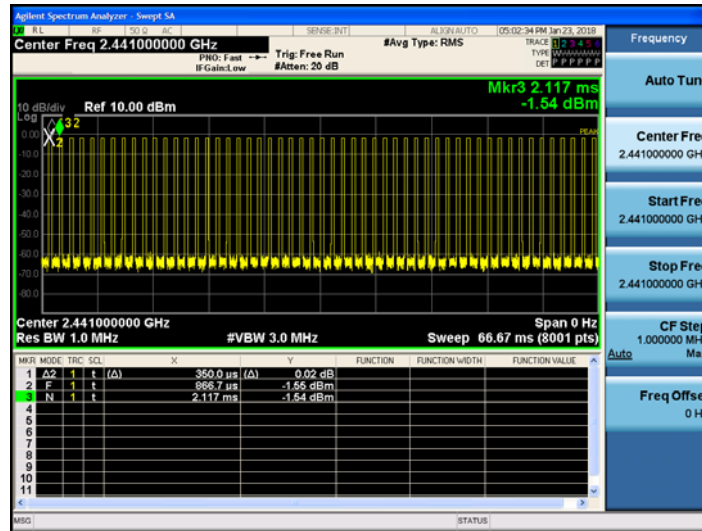

DH3

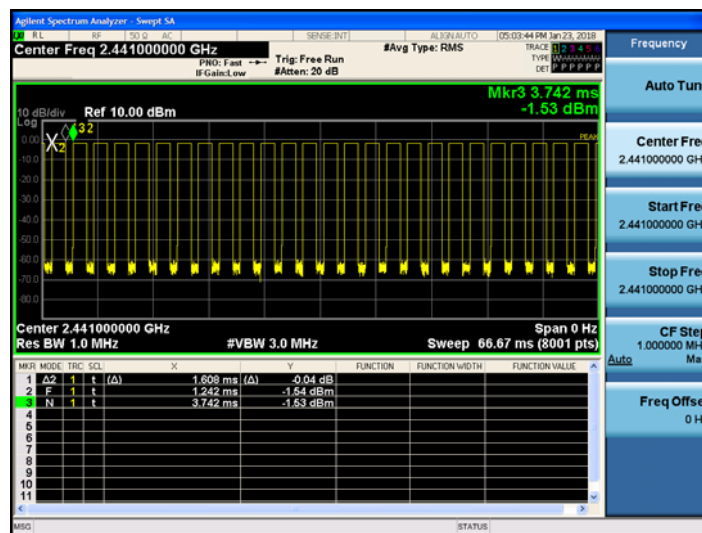

DH5

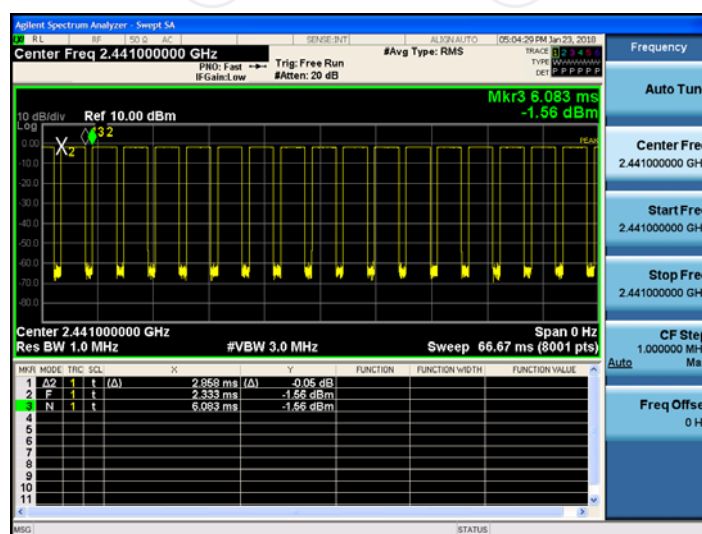

Pi/4DQPSK
2-DH1

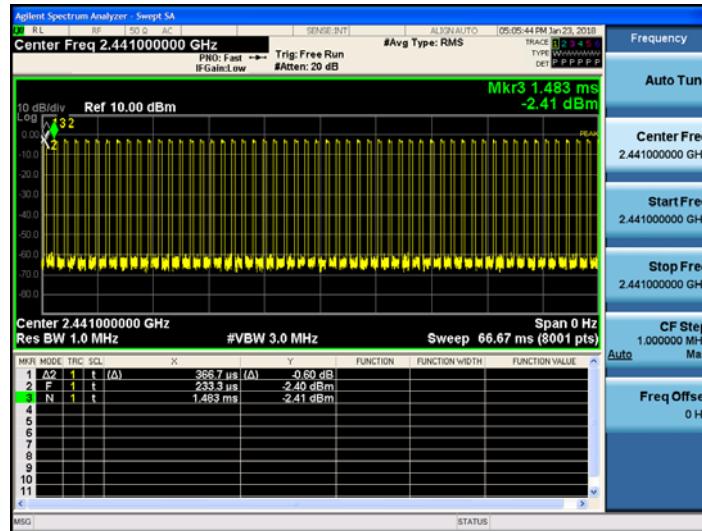

2-DH3

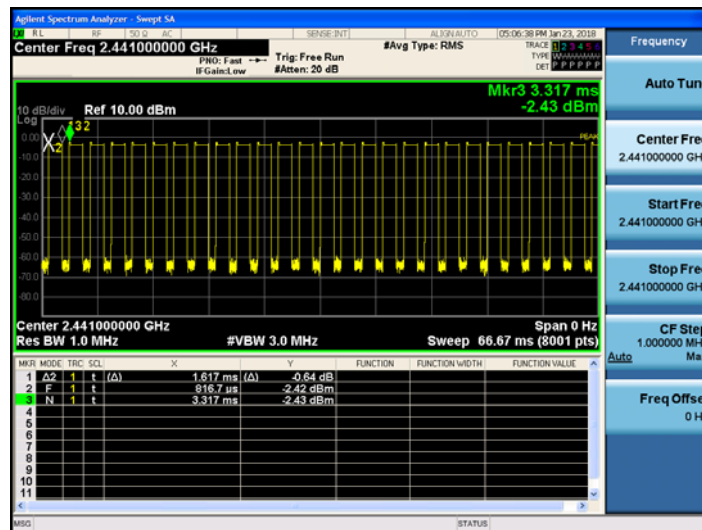

2-DH5

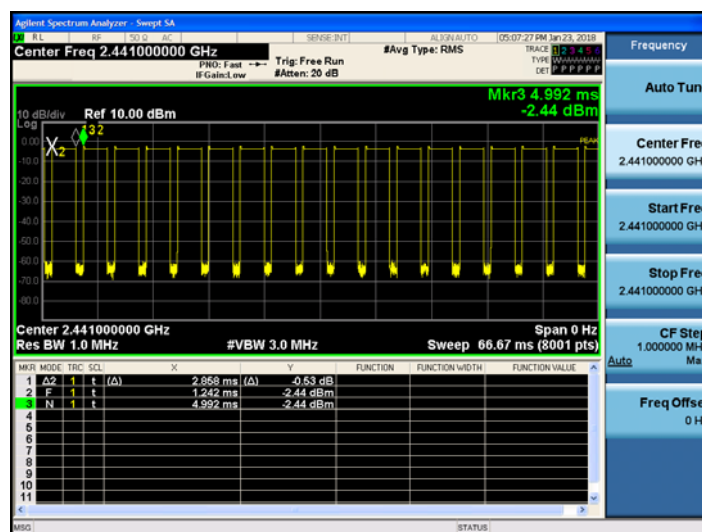

8DPSK
3-DH1

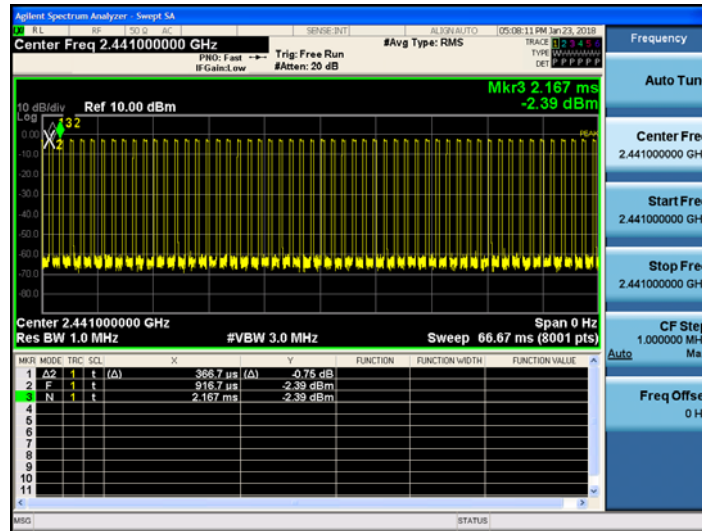

3-DH3

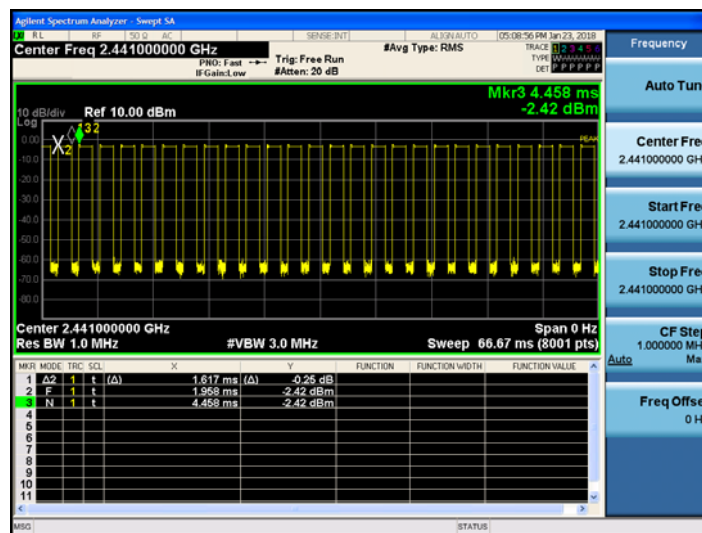

3-DH5

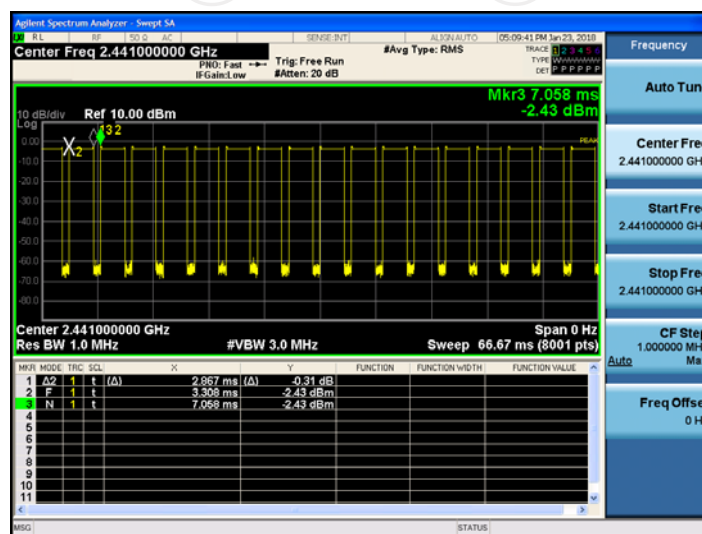

Hopping Channel Number

Result Table

Mode	Channel.	Number of Hopping Channel	Verdict
GFSK	Hop	79	PASS
$\pi/4$ DQPSK	Hop	79	PASS
8DPSK	Hop	79	PASS

Test Graph

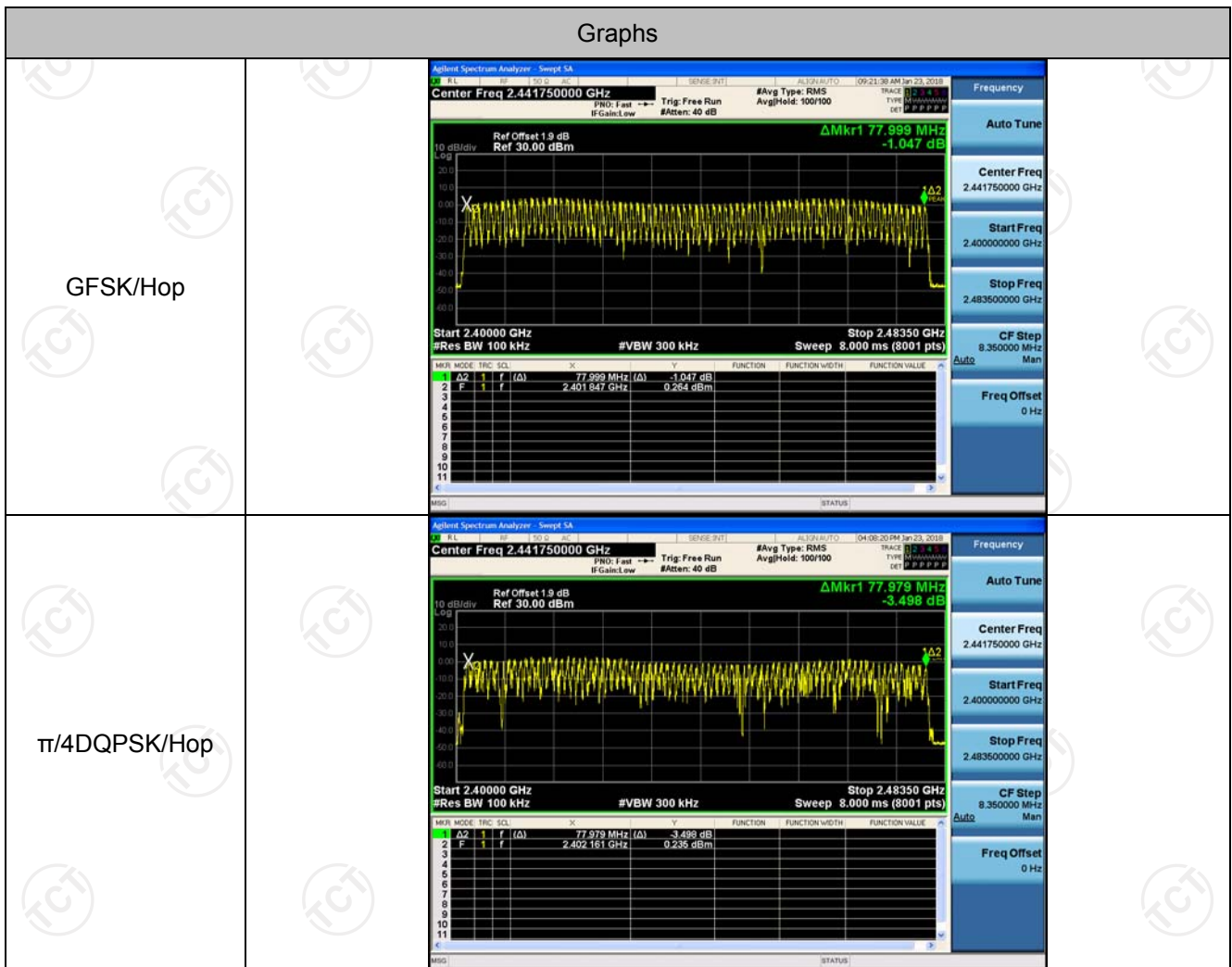

8DPSK/Hop

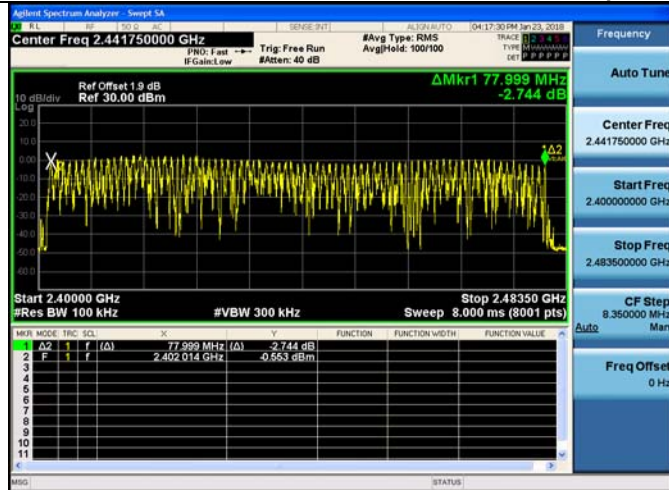





Conducted Peak Output Power

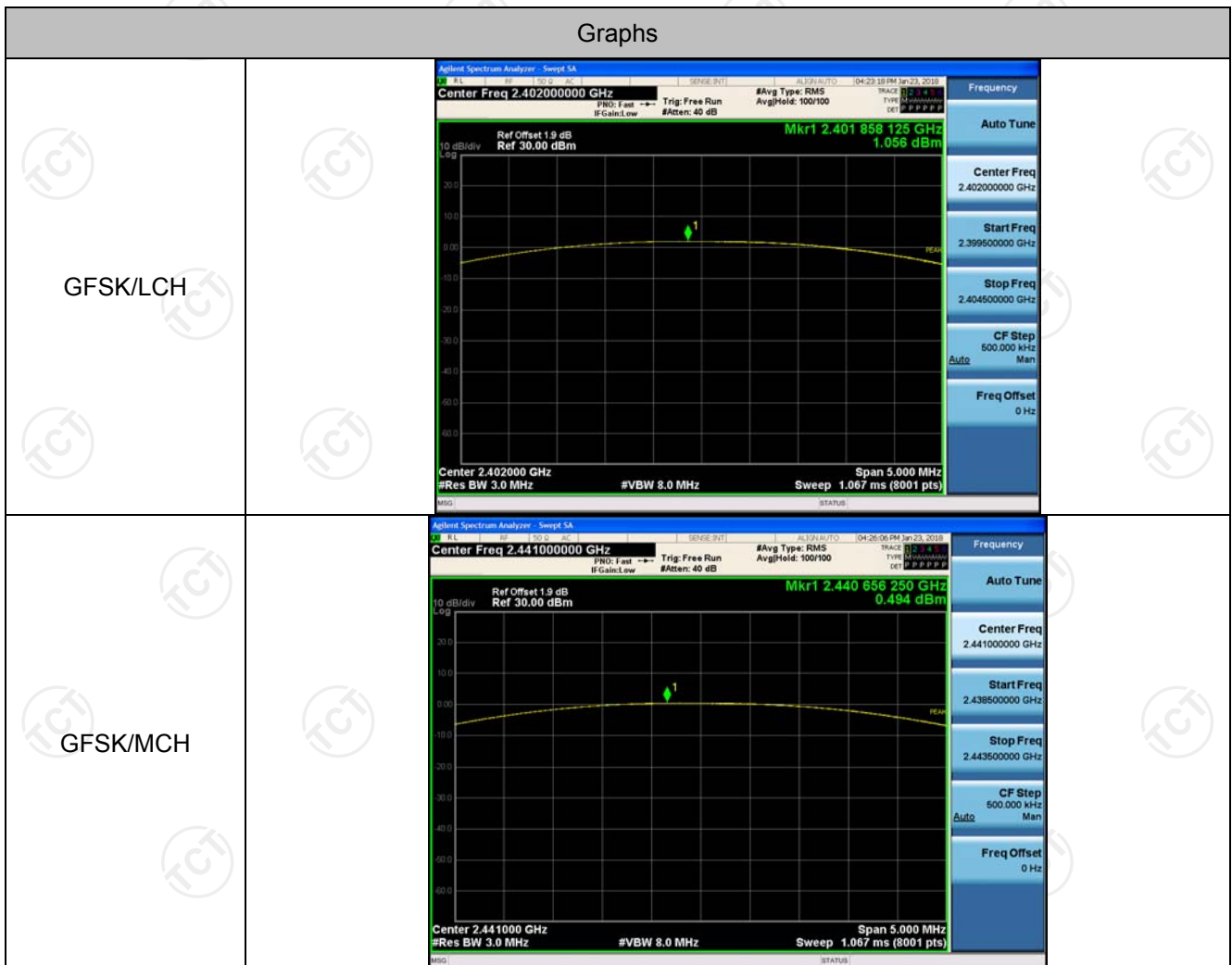

Result Table

Mode	Channel.	Maximum Peak Output Power [dBm]	Verdict
GFSK	LCH	1.056	PASS
GFSK	MCH	0.494	PASS
GFSK	HCH	-1.013	PASS
$\pi/4$ DQPSK	LCH	1.011	PASS
$\pi/4$ DQPSK	MCH	-0.229	PASS
$\pi/4$ DQPSK	HCH	-1.824	PASS
8DPSK	LCH	1.278	PASS
8DPSK	MCH	-0.246	PASS
8DPSK	HCH	-1.812	PASS

Test Graph



<p>GFSK/HCH</p>	
<p>$\pi/4$DQPSK/LCH</p>	
<p>$\pi/4$DQPSK/MCH</p>	

<p>TT/4DQPSK/HCH</p>	
<p>8DPSK/LCH</p>	
<p>8DPSK/MCH</p>	





Band-edge for RF Conducted Emissions

Result Table

Mode	Channel	Carrier Frequency [MHz]	Carrier Power [dBm]	Frequency Hopping	Max Spurious Level [dBm]	Limit [dBm]	Verdict
GFSK	LCH	2402	1.709	Off	-56.484	-18.29	PASS
			1.161	On	-56.082	-18.84	PASS
GFSK	HCH	2480	-1.182	Off	-55.969	-21.18	PASS
			-0.067	On	-55.731	-20.07	PASS
π /4DQPSK	LCH	2402	0.546	Off	-56.392	-19.45	PASS
			-0.332	On	-56.470	-20.33	PASS
π /4DQPSK	HCH	2480	-2.275	Off	-56.246	-22.28	PASS
			-1.802	On	-55.359	-21.8	PASS
8DPSK	LCH	2402	0.594	Off	-56.710	-19.41	PASS
			0.275	On	-56.244	-19.73	PASS
8DPSK	HCH	2480	-2.279	Off	-55.671	-22.28	PASS
			-1.871	On	-56.728	-21.87	PASS

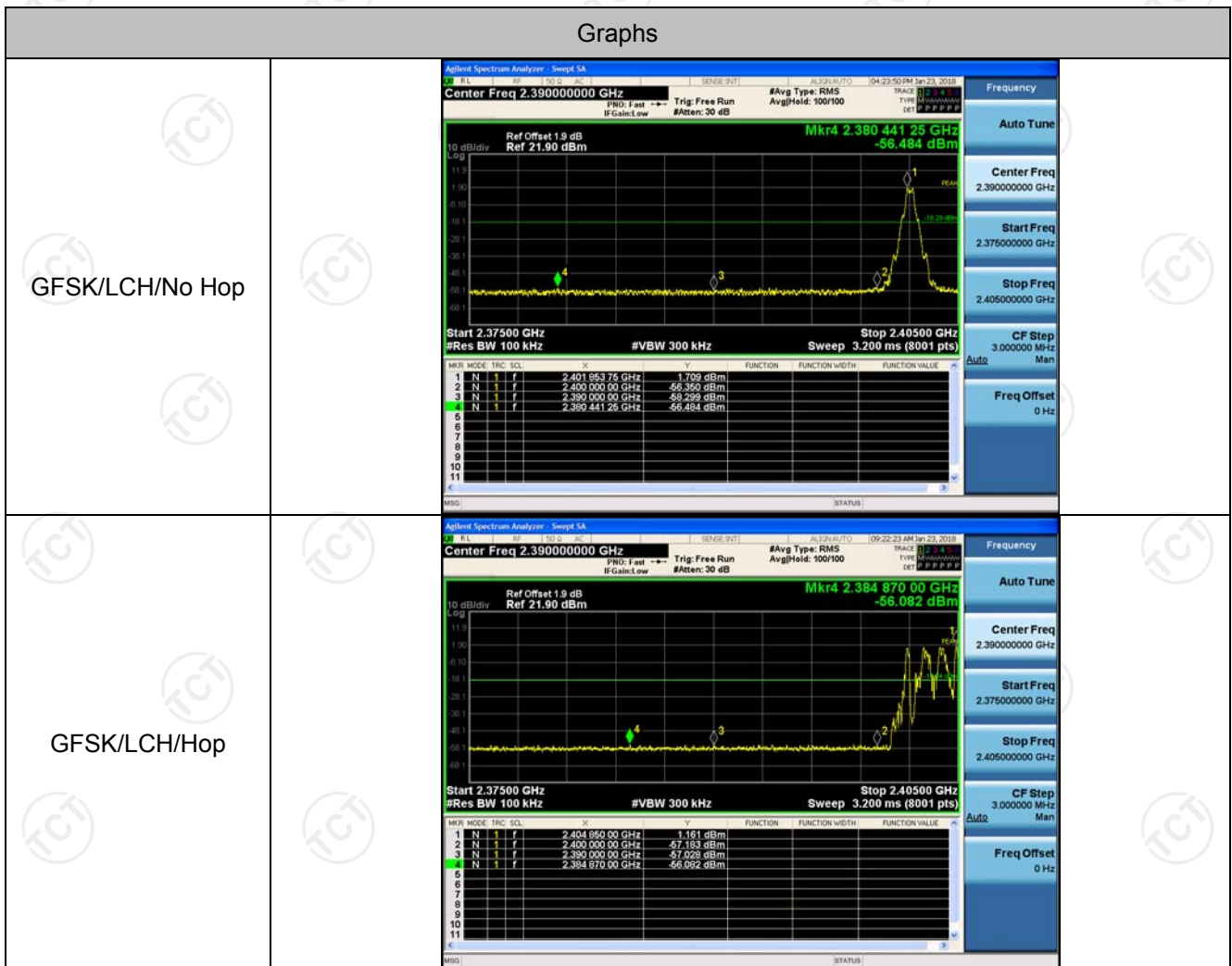
Test Graph

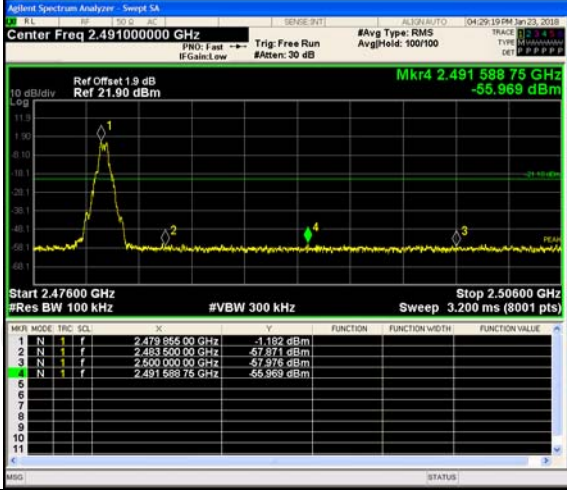
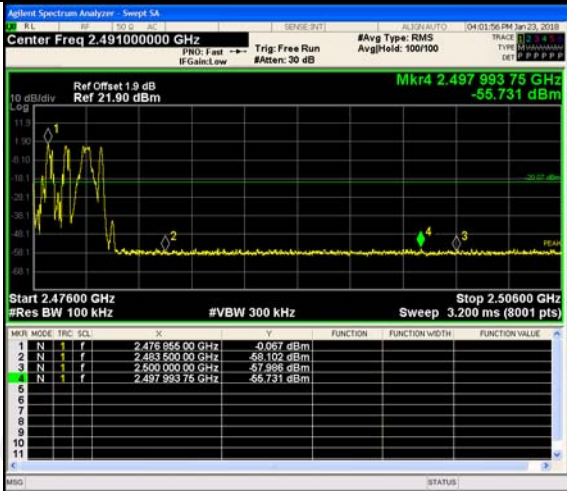

<p>GFSK/HCH/No Hop</p>	 <table border="1" data-bbox="608 517 1177 651"> <thead> <tr> <th>MNR</th> <th>MODE</th> <th>TRC</th> <th>SCL</th> <th>X</th> <th>Y</th> <th>FUNCTION</th> <th>FUNCTION WIDTH</th> <th>FUNCTION VALUE</th> </tr> </thead> <tbody> <tr> <td>1</td> <td>N</td> <td>1</td> <td>f</td> <td>2.479 956 00 GHz</td> <td>-1.182 dBm</td> <td></td> <td></td> <td></td> </tr> <tr> <td>2</td> <td>N</td> <td>1</td> <td>f</td> <td>2.483 500 00 GHz</td> <td>-57.871 dBm</td> <td></td> <td></td> <td></td> </tr> <tr> <td>3</td> <td>N</td> <td>1</td> <td>f</td> <td>2.500 000 00 GHz</td> <td>-57.576 dBm</td> <td></td> <td></td> <td></td> </tr> <tr> <td>4</td> <td>N</td> <td>1</td> <td>f</td> <td>2.491 598 75 GHz</td> <td>-55.969 dBm</td> <td></td> <td></td> <td></td> </tr> </tbody> </table>	MNR	MODE	TRC	SCL	X	Y	FUNCTION	FUNCTION WIDTH	FUNCTION VALUE	1	N	1	f	2.479 956 00 GHz	-1.182 dBm				2	N	1	f	2.483 500 00 GHz	-57.871 dBm				3	N	1	f	2.500 000 00 GHz	-57.576 dBm				4	N	1	f	2.491 598 75 GHz	-55.969 dBm			
MNR	MODE	TRC	SCL	X	Y	FUNCTION	FUNCTION WIDTH	FUNCTION VALUE																																						
1	N	1	f	2.479 956 00 GHz	-1.182 dBm																																									
2	N	1	f	2.483 500 00 GHz	-57.871 dBm																																									
3	N	1	f	2.500 000 00 GHz	-57.576 dBm																																									
4	N	1	f	2.491 598 75 GHz	-55.969 dBm																																									
<p>GFSK/HCH/Hop</p>	 <table border="1" data-bbox="608 1010 1177 1144"> <thead> <tr> <th>MNR</th> <th>MODE</th> <th>TRC</th> <th>SCL</th> <th>X</th> <th>Y</th> <th>FUNCTION</th> <th>FUNCTION WIDTH</th> <th>FUNCTION VALUE</th> </tr> </thead> <tbody> <tr> <td>1</td> <td>N</td> <td>1</td> <td>f</td> <td>2.476 956 00 GHz</td> <td>-0.067 dBm</td> <td></td> <td></td> <td></td> </tr> <tr> <td>2</td> <td>N</td> <td>1</td> <td>f</td> <td>2.483 500 00 GHz</td> <td>-58.102 dBm</td> <td></td> <td></td> <td></td> </tr> <tr> <td>3</td> <td>N</td> <td>1</td> <td>f</td> <td>2.500 000 00 GHz</td> <td>-57.988 dBm</td> <td></td> <td></td> <td></td> </tr> <tr> <td>4</td> <td>N</td> <td>1</td> <td>f</td> <td>2.497 993 75 GHz</td> <td>-55.731 dBm</td> <td></td> <td></td> <td></td> </tr> </tbody> </table>	MNR	MODE	TRC	SCL	X	Y	FUNCTION	FUNCTION WIDTH	FUNCTION VALUE	1	N	1	f	2.476 956 00 GHz	-0.067 dBm				2	N	1	f	2.483 500 00 GHz	-58.102 dBm				3	N	1	f	2.500 000 00 GHz	-57.988 dBm				4	N	1	f	2.497 993 75 GHz	-55.731 dBm			
MNR	MODE	TRC	SCL	X	Y	FUNCTION	FUNCTION WIDTH	FUNCTION VALUE																																						
1	N	1	f	2.476 956 00 GHz	-0.067 dBm																																									
2	N	1	f	2.483 500 00 GHz	-58.102 dBm																																									
3	N	1	f	2.500 000 00 GHz	-57.988 dBm																																									
4	N	1	f	2.497 993 75 GHz	-55.731 dBm																																									
<p>$\pi/4$DQPSK/LCH/No Hop</p>	 <table border="1" data-bbox="608 1491 1177 1626"> <thead> <tr> <th>MNR</th> <th>MODE</th> <th>TRC</th> <th>SCL</th> <th>X</th> <th>Y</th> <th>FUNCTION</th> <th>FUNCTION WIDTH</th> <th>FUNCTION VALUE</th> </tr> </thead> <tbody> <tr> <td>1</td> <td>N</td> <td>1</td> <td>f</td> <td>2.402 189 76 GHz</td> <td>0.546 dBm</td> <td></td> <td></td> <td></td> </tr> <tr> <td>2</td> <td>N</td> <td>1</td> <td>f</td> <td>2.400 000 00 GHz</td> <td>-58.511 dBm</td> <td></td> <td></td> <td></td> </tr> <tr> <td>3</td> <td>N</td> <td>1</td> <td>f</td> <td>2.380 000 00 GHz</td> <td>-60.088 dBm</td> <td></td> <td></td> <td></td> </tr> <tr> <td>4</td> <td>N</td> <td>1</td> <td>f</td> <td>2.380 943 75 GHz</td> <td>-56.392 dBm</td> <td></td> <td></td> <td></td> </tr> </tbody> </table>	MNR	MODE	TRC	SCL	X	Y	FUNCTION	FUNCTION WIDTH	FUNCTION VALUE	1	N	1	f	2.402 189 76 GHz	0.546 dBm				2	N	1	f	2.400 000 00 GHz	-58.511 dBm				3	N	1	f	2.380 000 00 GHz	-60.088 dBm				4	N	1	f	2.380 943 75 GHz	-56.392 dBm			
MNR	MODE	TRC	SCL	X	Y	FUNCTION	FUNCTION WIDTH	FUNCTION VALUE																																						
1	N	1	f	2.402 189 76 GHz	0.546 dBm																																									
2	N	1	f	2.400 000 00 GHz	-58.511 dBm																																									
3	N	1	f	2.380 000 00 GHz	-60.088 dBm																																									
4	N	1	f	2.380 943 75 GHz	-56.392 dBm																																									

<p>$\pi/4$DQPSK/LCH/Hop</p>	
<p>$\pi/4$DQPSK/HCH/No Hop</p>	
<p>$\pi/4$DQPSK/HCH/Hop</p>	

<p>8DPSK/LCH/No Hop</p>	<p>Agilent Spectrum Analyzer - Swept SA</p> <p>Center Freq 2.390000000 GHz</p> <p>Ref Offset 1.9 dB Ref 21.90 dBm</p> <p>Mkr4 2.388 672 50 GHz -56.710 dBm</p> <p>Start 2.37500 GHz #Res BW 100 kHz #VBW 300 kHz Stop 2.40500 GHz Sweep 3.200 ms (8001 pts)</p> <table border="1"> <thead> <tr> <th>MNR</th> <th>MODE</th> <th>TRIG</th> <th>SCL</th> <th>X</th> <th>Y</th> <th>FUNCTION</th> <th>FUNCTION WIDTH</th> <th>FUNCTION VALUE</th> </tr> </thead> <tbody> <tr><td>1</td><td>N</td><td>1</td><td>f</td><td>2.402 172 50 GHz</td><td>0.694 dBm</td><td></td><td></td><td></td></tr> <tr><td>2</td><td>N</td><td>1</td><td>f</td><td>2.400 000 00 GHz</td><td>-58.208 dBm</td><td></td><td></td><td></td></tr> <tr><td>3</td><td>N</td><td>1</td><td>f</td><td>2.398 000 00 GHz</td><td>-59.533 dBm</td><td></td><td></td><td></td></tr> <tr><td>4</td><td>N</td><td>1</td><td>f</td><td>2.388 672 50 GHz</td><td>-56.710 dBm</td><td></td><td></td><td></td></tr> </tbody> </table>	MNR	MODE	TRIG	SCL	X	Y	FUNCTION	FUNCTION WIDTH	FUNCTION VALUE	1	N	1	f	2.402 172 50 GHz	0.694 dBm				2	N	1	f	2.400 000 00 GHz	-58.208 dBm				3	N	1	f	2.398 000 00 GHz	-59.533 dBm				4	N	1	f	2.388 672 50 GHz	-56.710 dBm			
MNR	MODE	TRIG	SCL	X	Y	FUNCTION	FUNCTION WIDTH	FUNCTION VALUE																																						
1	N	1	f	2.402 172 50 GHz	0.694 dBm																																									
2	N	1	f	2.400 000 00 GHz	-58.208 dBm																																									
3	N	1	f	2.398 000 00 GHz	-59.533 dBm																																									
4	N	1	f	2.388 672 50 GHz	-56.710 dBm																																									
<p>8DPSK/LCH/Hop</p>	<p>Agilent Spectrum Analyzer - Swept SA</p> <p>Center Freq 2.390000000 GHz</p> <p>Ref Offset 1.9 dB Ref 21.90 dBm</p> <p>Mkr4 2.379 455 00 GHz -56.244 dBm</p> <p>Start 2.37500 GHz #Res BW 100 kHz #VBW 300 kHz Stop 2.40500 GHz Sweep 3.200 ms (8001 pts)</p> <table border="1"> <thead> <tr> <th>MNR</th> <th>MODE</th> <th>TRIG</th> <th>SCL</th> <th>X</th> <th>Y</th> <th>FUNCTION</th> <th>FUNCTION WIDTH</th> <th>FUNCTION VALUE</th> </tr> </thead> <tbody> <tr><td>1</td><td>N</td><td>1</td><td>f</td><td>2.402 076 25 GHz</td><td>0.275 dBm</td><td></td><td></td><td></td></tr> <tr><td>2</td><td>N</td><td>1</td><td>f</td><td>2.400 000 00 GHz</td><td>-57.503 dBm</td><td></td><td></td><td></td></tr> <tr><td>3</td><td>N</td><td>1</td><td>f</td><td>2.390 000 00 GHz</td><td>-59.291 dBm</td><td></td><td></td><td></td></tr> <tr><td>4</td><td>N</td><td>1</td><td>f</td><td>2.379 455 00 GHz</td><td>-56.244 dBm</td><td></td><td></td><td></td></tr> </tbody> </table>	MNR	MODE	TRIG	SCL	X	Y	FUNCTION	FUNCTION WIDTH	FUNCTION VALUE	1	N	1	f	2.402 076 25 GHz	0.275 dBm				2	N	1	f	2.400 000 00 GHz	-57.503 dBm				3	N	1	f	2.390 000 00 GHz	-59.291 dBm				4	N	1	f	2.379 455 00 GHz	-56.244 dBm			
MNR	MODE	TRIG	SCL	X	Y	FUNCTION	FUNCTION WIDTH	FUNCTION VALUE																																						
1	N	1	f	2.402 076 25 GHz	0.275 dBm																																									
2	N	1	f	2.400 000 00 GHz	-57.503 dBm																																									
3	N	1	f	2.390 000 00 GHz	-59.291 dBm																																									
4	N	1	f	2.379 455 00 GHz	-56.244 dBm																																									
<p>8DPSK/HCH/No Hop</p>	<p>Agilent Spectrum Analyzer - Swept SA</p> <p>Center Freq 2.491000000 GHz</p> <p>Ref Offset 1.9 dB Ref 21.90 dBm</p> <p>Mkr4 2.488 435 00 GHz -55.671 dBm</p> <p>Start 2.47600 GHz #Res BW 100 kHz #VBW 300 kHz Stop 2.50600 GHz Sweep 3.200 ms (8001 pts)</p> <table border="1"> <thead> <tr> <th>MNR</th> <th>MODE</th> <th>TRIG</th> <th>SCL</th> <th>X</th> <th>Y</th> <th>FUNCTION</th> <th>FUNCTION WIDTH</th> <th>FUNCTION VALUE</th> </tr> </thead> <tbody> <tr><td>1</td><td>N</td><td>1</td><td>f</td><td>2.488 173 75 GHz</td><td>2.279 dBm</td><td></td><td></td><td></td></tr> <tr><td>2</td><td>N</td><td>1</td><td>f</td><td>2.483 500 00 GHz</td><td>-57.929 dBm</td><td></td><td></td><td></td></tr> <tr><td>3</td><td>N</td><td>1</td><td>f</td><td>2.500 000 00 GHz</td><td>-58.141 dBm</td><td></td><td></td><td></td></tr> <tr><td>4</td><td>N</td><td>1</td><td>f</td><td>2.488 435 00 GHz</td><td>-55.671 dBm</td><td></td><td></td><td></td></tr> </tbody> </table>	MNR	MODE	TRIG	SCL	X	Y	FUNCTION	FUNCTION WIDTH	FUNCTION VALUE	1	N	1	f	2.488 173 75 GHz	2.279 dBm				2	N	1	f	2.483 500 00 GHz	-57.929 dBm				3	N	1	f	2.500 000 00 GHz	-58.141 dBm				4	N	1	f	2.488 435 00 GHz	-55.671 dBm			
MNR	MODE	TRIG	SCL	X	Y	FUNCTION	FUNCTION WIDTH	FUNCTION VALUE																																						
1	N	1	f	2.488 173 75 GHz	2.279 dBm																																									
2	N	1	f	2.483 500 00 GHz	-57.929 dBm																																									
3	N	1	f	2.500 000 00 GHz	-58.141 dBm																																									
4	N	1	f	2.488 435 00 GHz	-55.671 dBm																																									

8DPSK/HCH/Hop

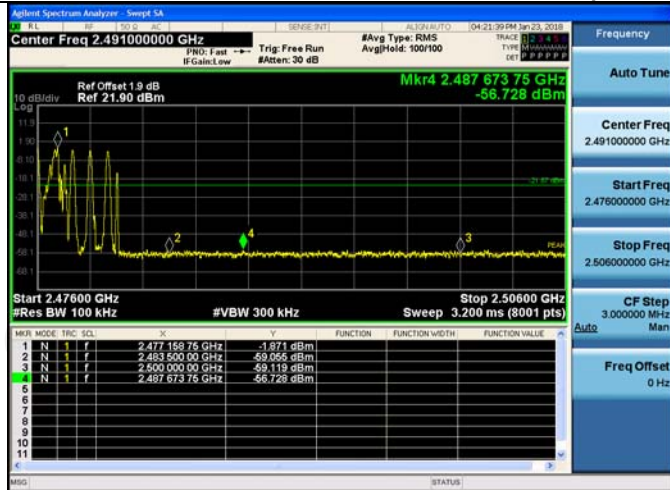

RF Conducted Spurious Emissions

Result Table

Mode	Channel	Pref [dBm]	Puw [dBm]	Verdict
GFSK	LCH	1.622	<Limit	PASS
GFSK	MCH	0.299	<Limit	PASS
GFSK	HCH	-1.244	<Limit	PASS
$\pi/4$ DQPSK	LCH	-0.113	<Limit	PASS
$\pi/4$ DQPSK	MCH	-0.775	<Limit	PASS
$\pi/4$ DQPSK	HCH	-2.283	<Limit	PASS
8DPSK	LCH	0.547	<Limit	PASS
8DPSK	MCH	-1.426	<Limit	PASS
8DPSK	HCH	-2.337	<Limit	PASS

Test Graph

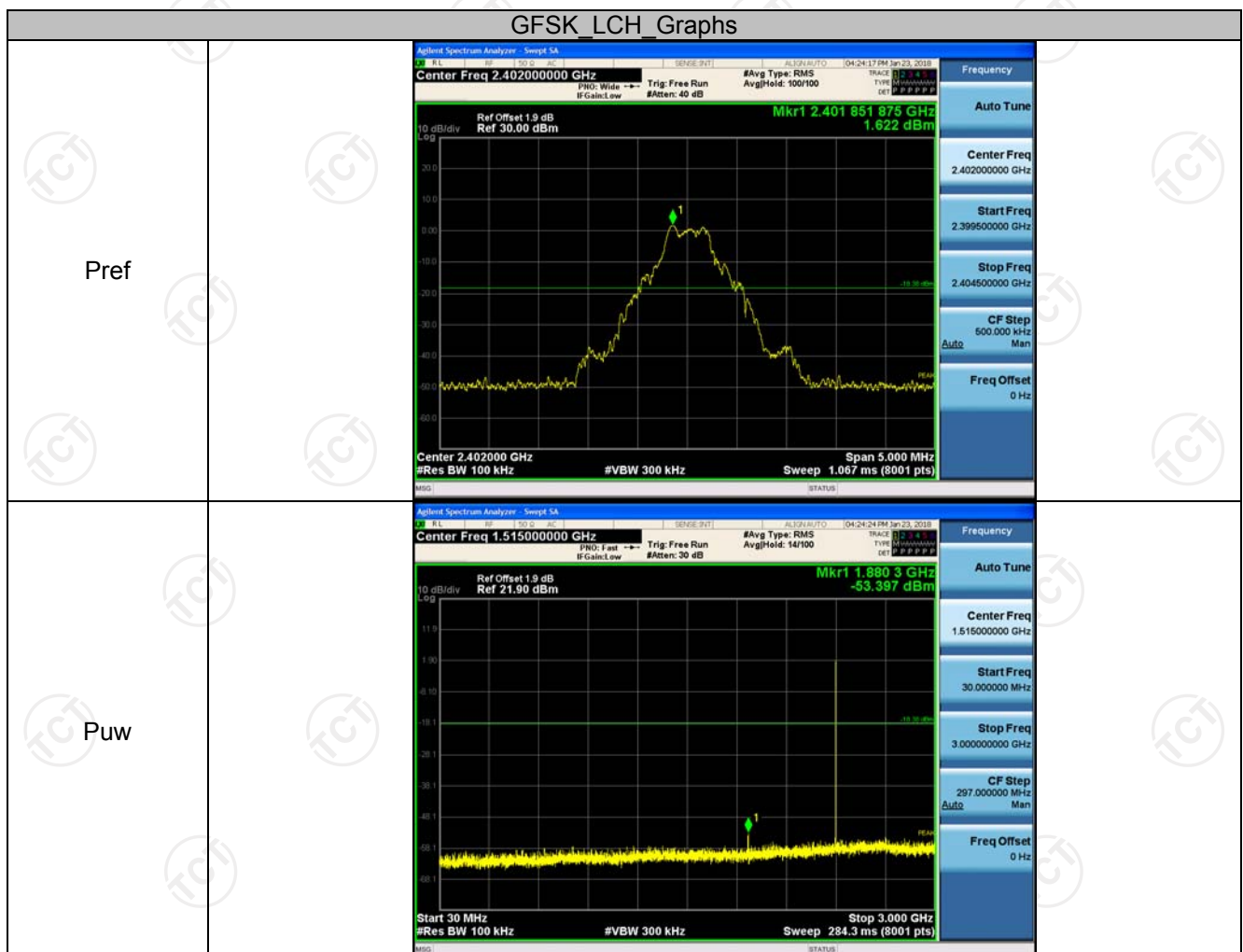

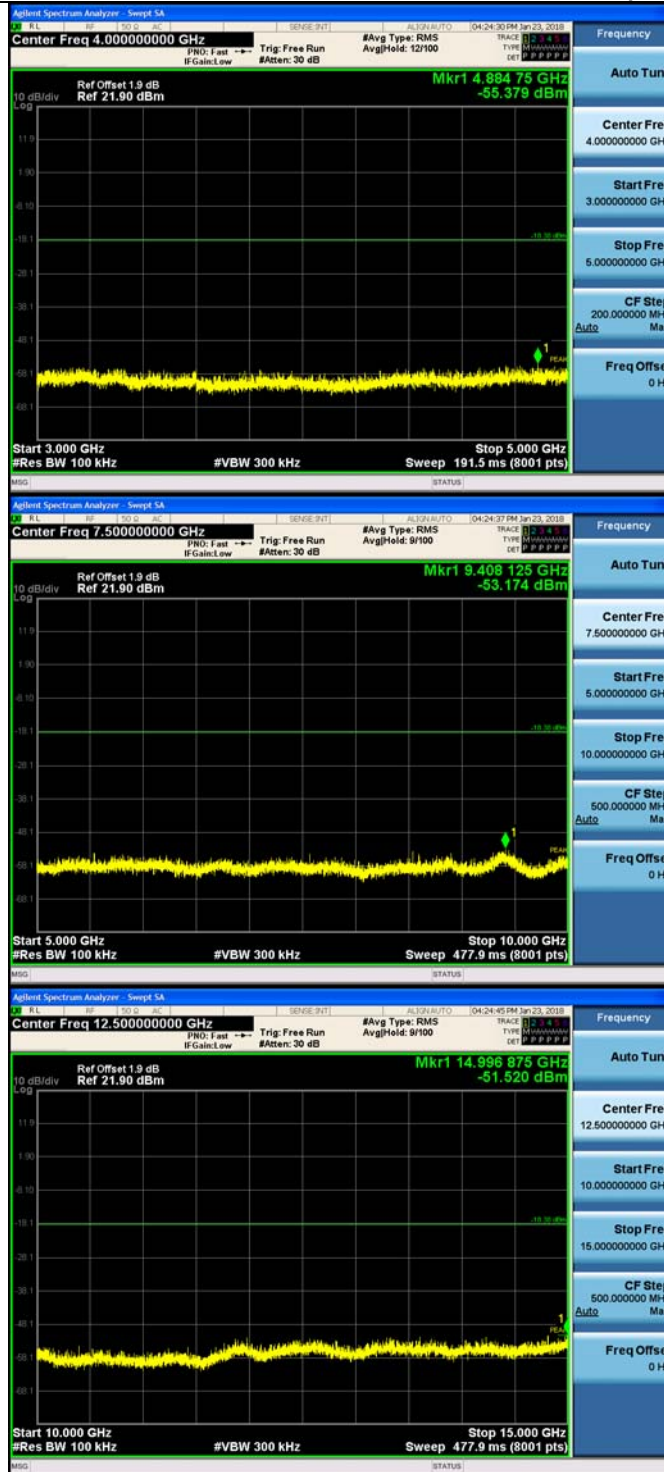

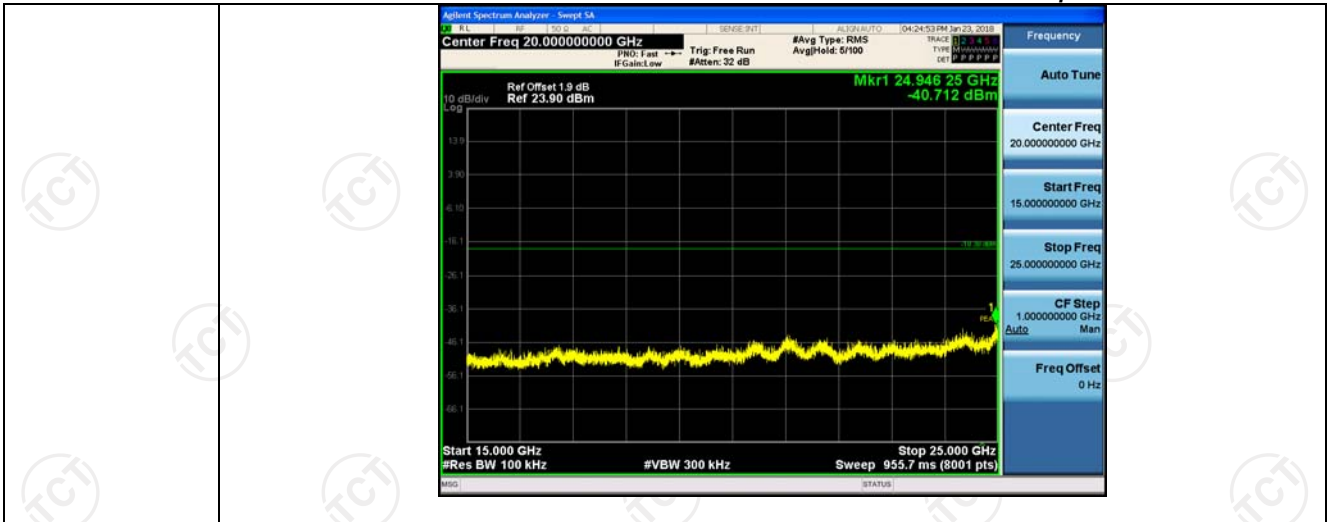

GFSK_MCH_Graphs

