

Antenna Specification

Specifications Summary

ITEM	SPEC.	
Model Name	IBM 2.4 GHz	
Center Frequency	2402 MHz	2.34 dBi
	2441 MHz	2.07dBi
	2480 MHz	1.45 dBi
MAX. GAIN	2.34 dBi	
Polarization	Horizontal	
Azimuth Beam Pattern	Omni-directional	
Impedance	50 Ω	
Antenna Length	3.45cm	

Antenna Photo & Length (mm)

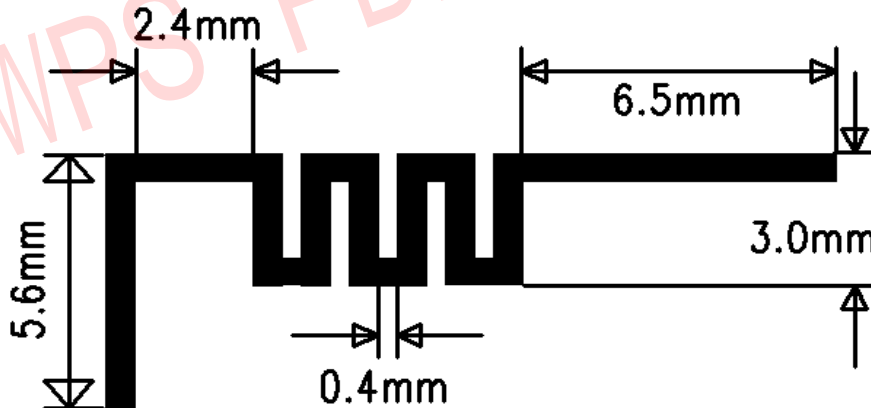

Test Address	16 Tzu Chiang Road, Hsinchu Industrial District Hsinchu Hsien 303, Taiwan
Test Date	2009-04-14
Test Instrument	vector network analyzer - R&S ZVB20

1. Main antenna : 2402 MHz

1.1 Horizontal

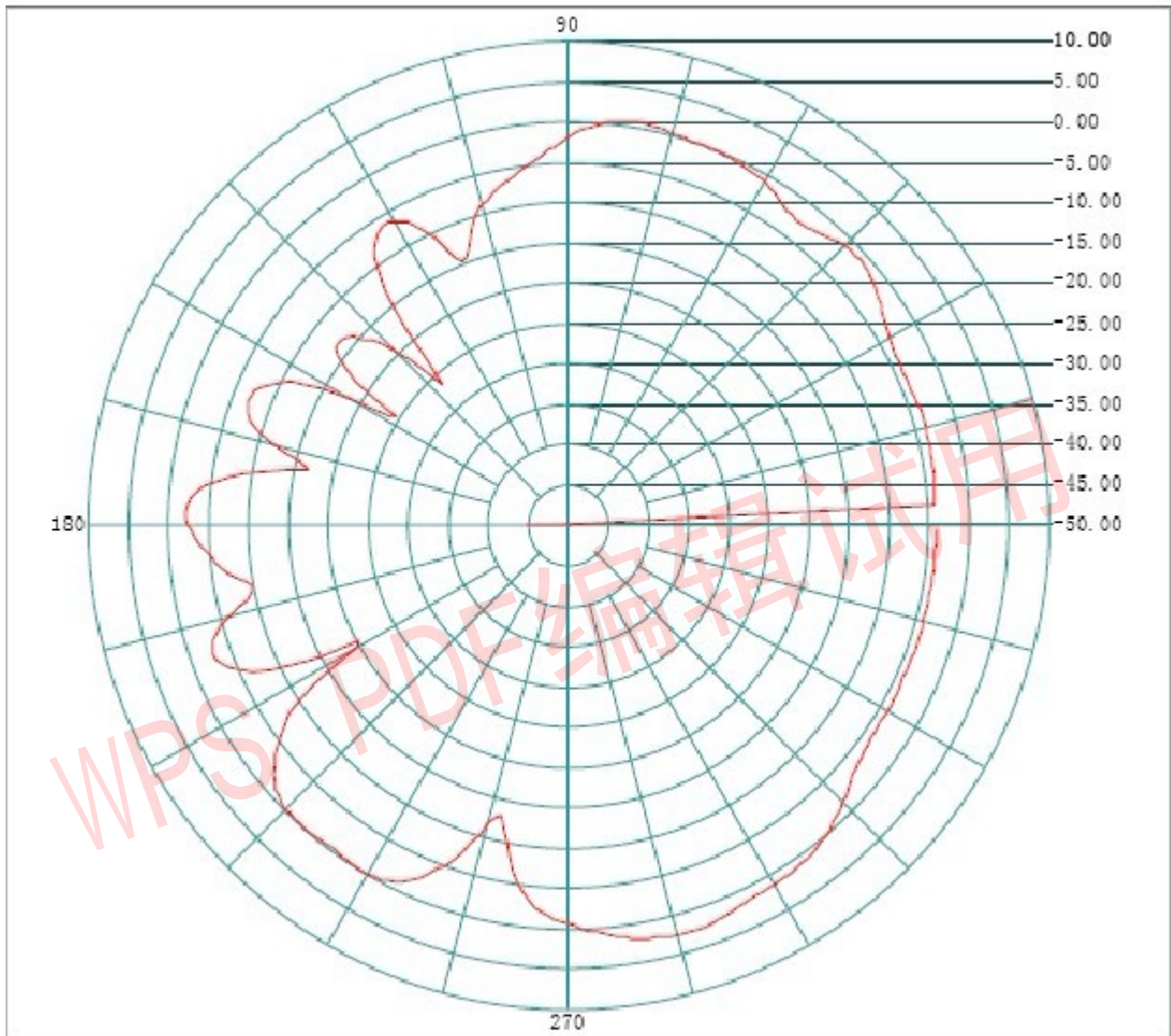

Frequency(MHZ): **2402**

Antenna Polarity: **Horizontal**

Maximum Gain(dBi): **'2.54**

Average Gain(dBi) : **-2.48**

Minimum Gain(dBi): **-55.18**

1.2 Vertical

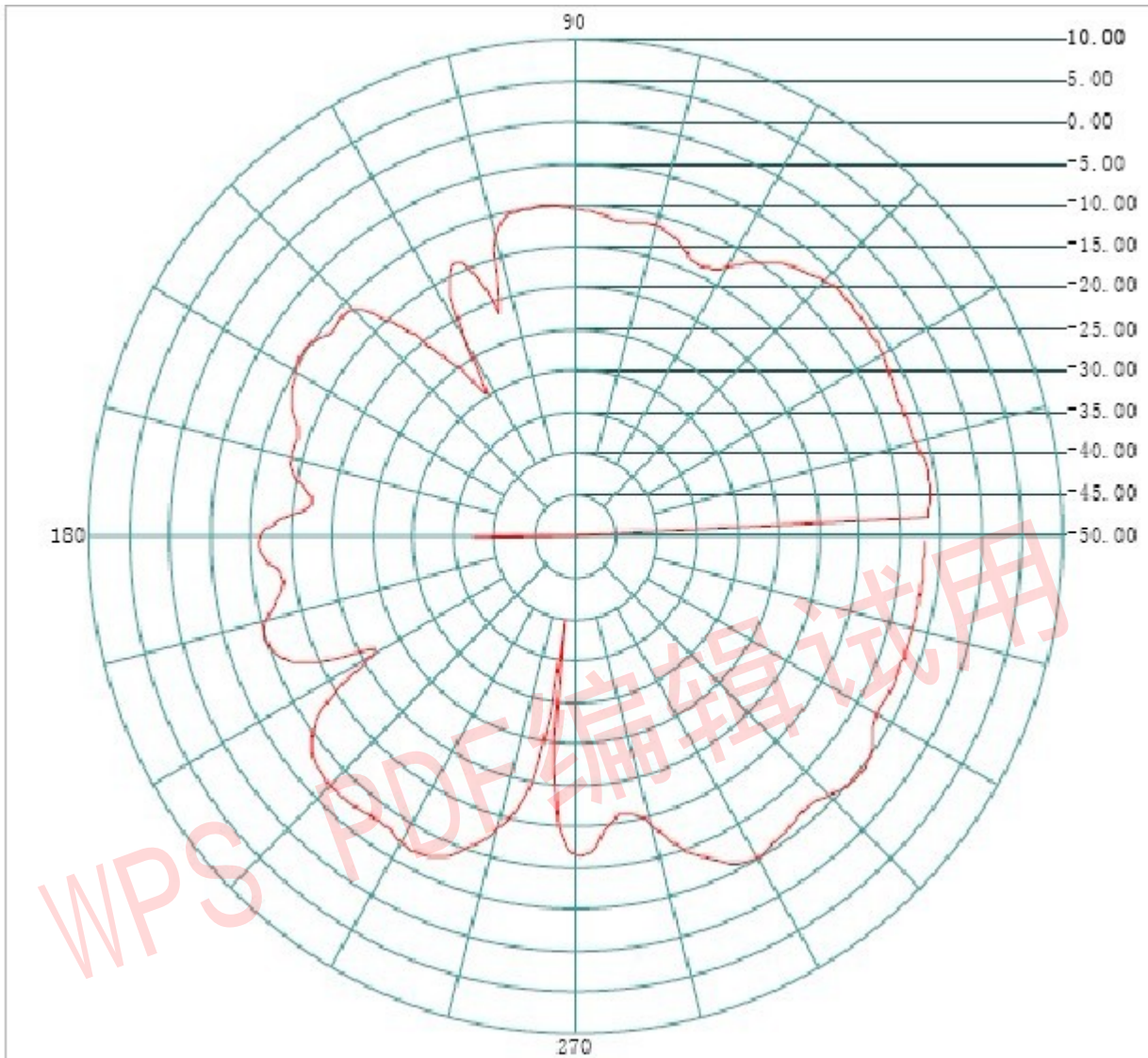

Frequency(MHZ): **2402**

Antenna Polarity: **Vertical**

Maximum Gain(dBi): **-4.51**

Average Gain(dBi) : **-8.98**

Minimum Gain(dBi): **-62.3**

2. Main antenna : 2441 MHz

2.1 Horizontal

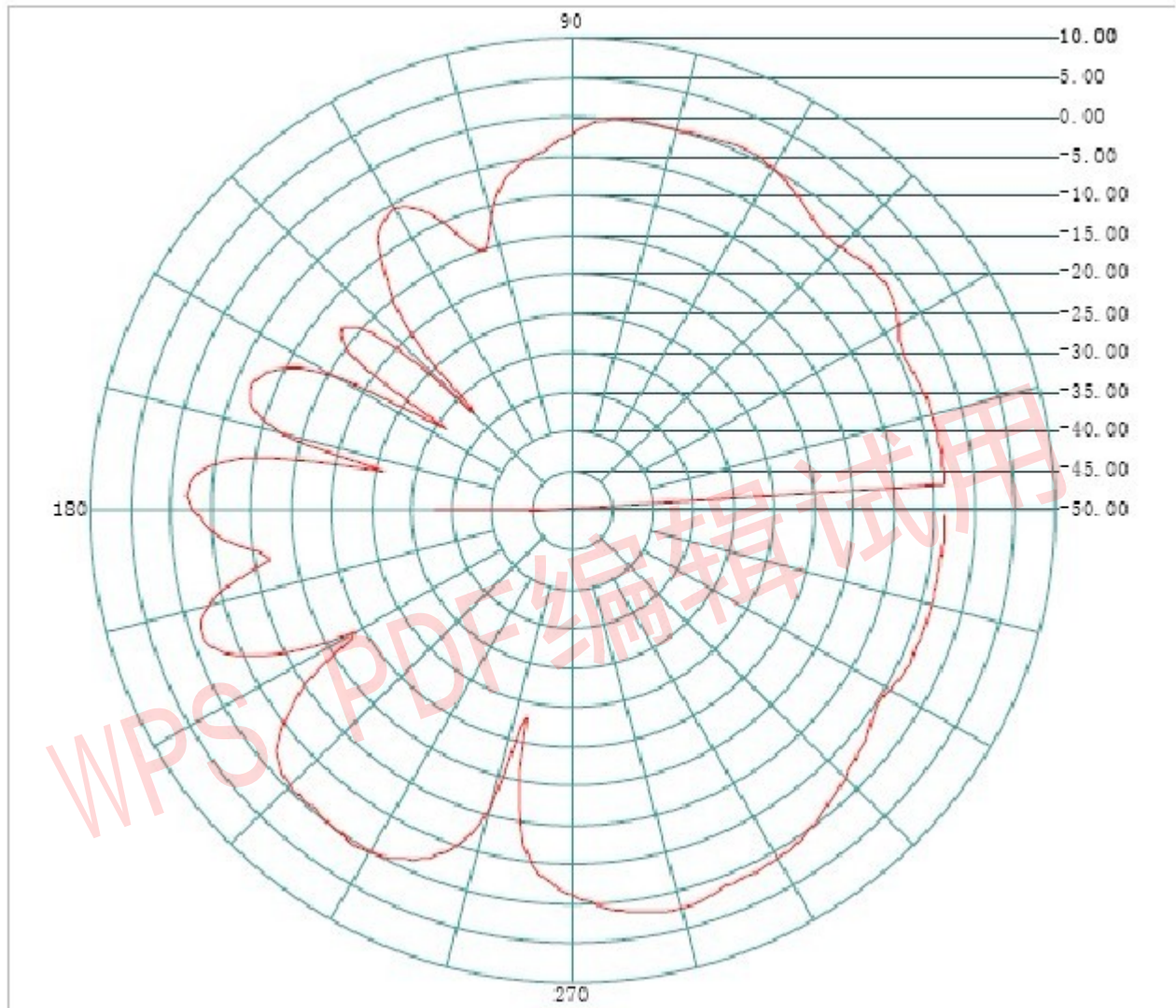

Frequency(MHZ): **2441**

Antenna Polarity: **Horizontal**

Maximum Gain(dBi): **2.07**

Average Gain(dBi) : **-2.54**

Minimum Gain(dBi): **-66.98**

''

2.2 Vertical

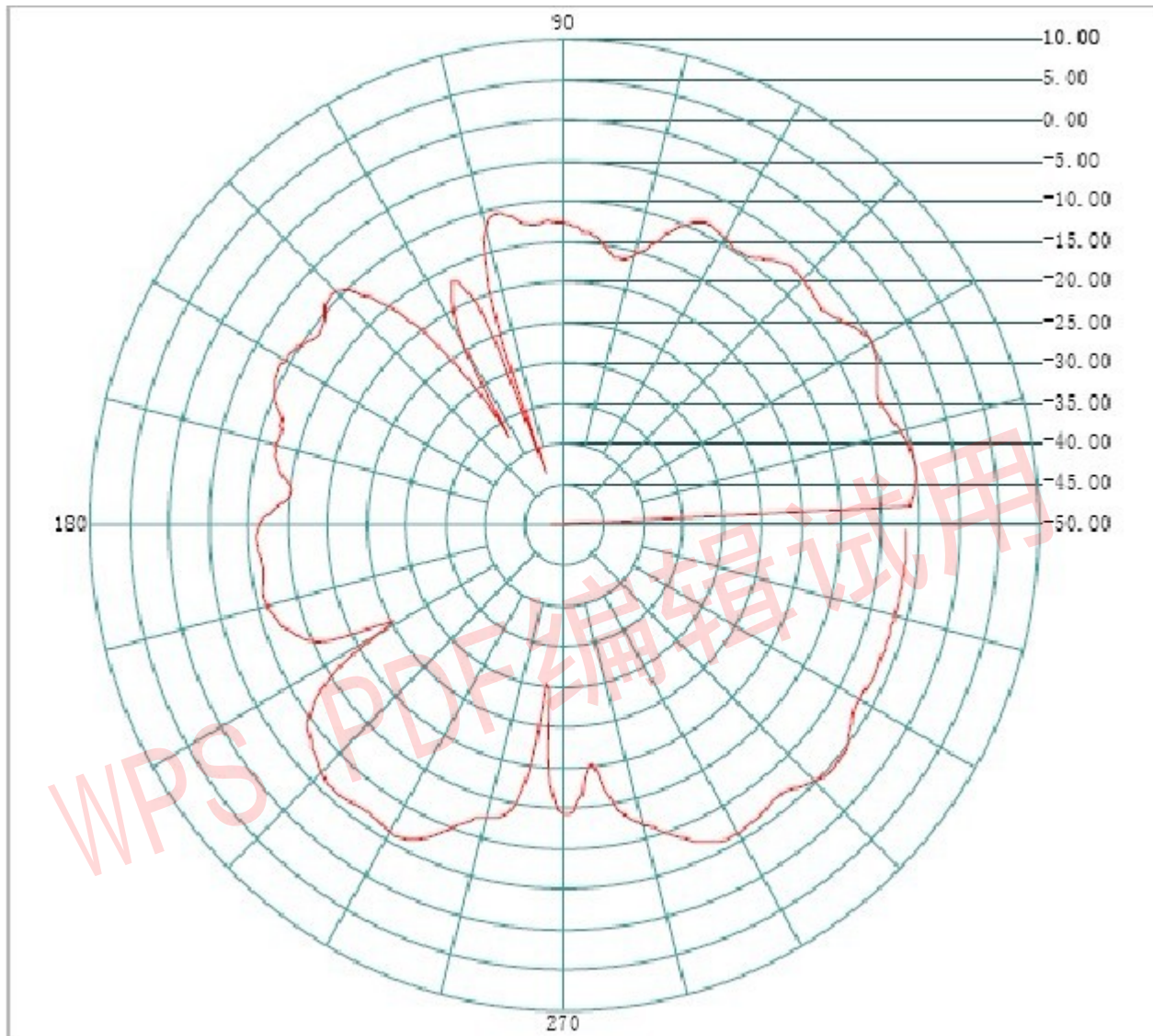

Frequency(MHZ): **2441**

Antenna Polarity: **Vertical**

Maximum Gain(dBi): **-4.29**

Average Gain(dBi) : **-8.81**

Minimum Gain(dBi): **-51.4**

2. Main antenna : 2480 MHz

2.1 Horizontal

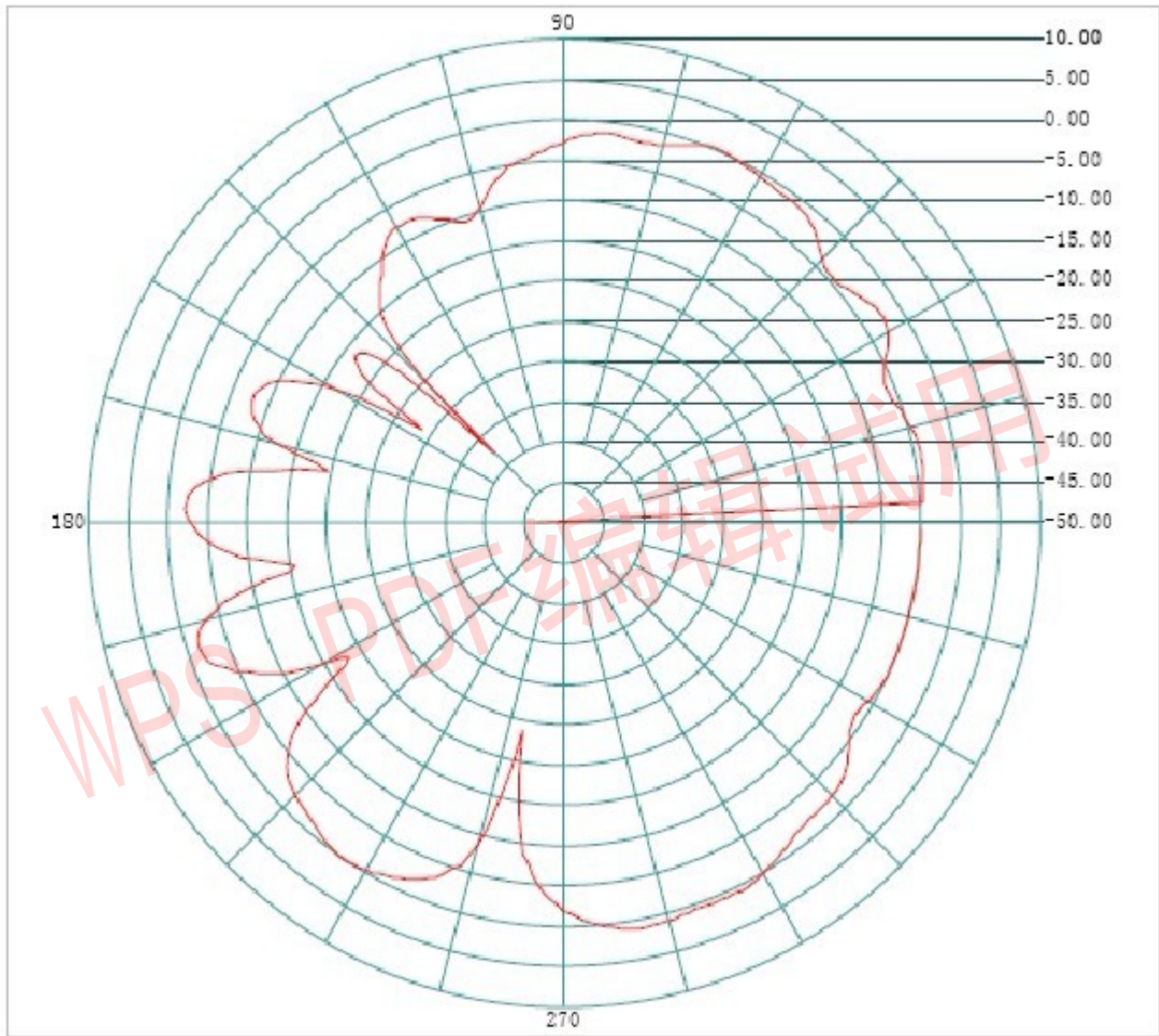

Frequency(MHZ): **2480**

Antenna Polarity: **Horizontal**

Maximum Gain(dBi): **1.45**

Average Gain(dBi) : **-3.34**

Minimum Gain(dBi): **-53.4**

2.2 Vertical

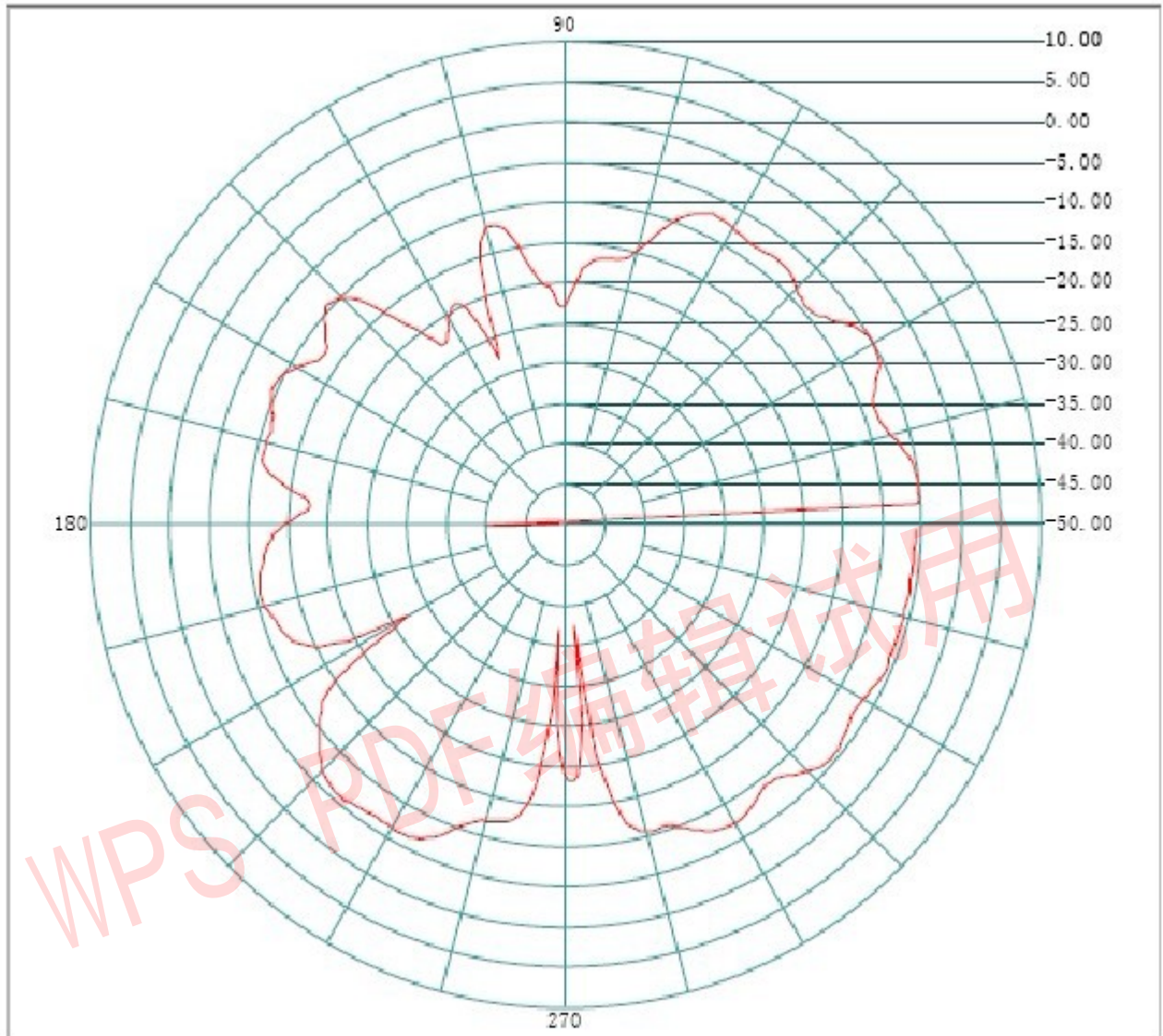

Frequency(MHZ): **2480**

Antenna Polarity: **Vertical**

Maximum Gain(dBi): **-4.95**

Average Gain(dBi) : **-9.06**

Minimum Gain(dBi): **-60.00**