

Antenna Specification

Specifications Summary

| ITEM | SPEC. | |
|----------------------|------------------|----------|
| Model Name | IBM 2.4 GHz | |
| Center Frequency | 2402 MHz | 2.34 dBi |
| | 2441 MHz | 2.07dBi |
| | 2480 MHz | 1.45 dBi |
| MAX. GAIN | 2.34 dBi | |
| Polarization | Horizontal | |
| Azimuth Beam Pattern | Omni-directional | |
| Impedance | 50 Ω | |
| Antenna Length | 3.1cm | |

Antenna Photo & Length (mm)

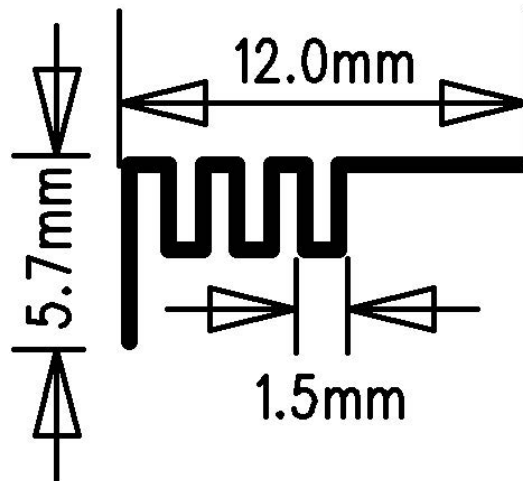

| | |
|-----------------|---|
| Test Address | 16 Tzu Chiang Road, Hsinchu Industrial District Hsinchu Hsien 303, Taiwan |
| Test Date | 2009-04-14 |
| Test Instrument | vector network analyzer - R&S ZVB20 |

1. Main antenna : 2402 MHz

1.1 Horizontal

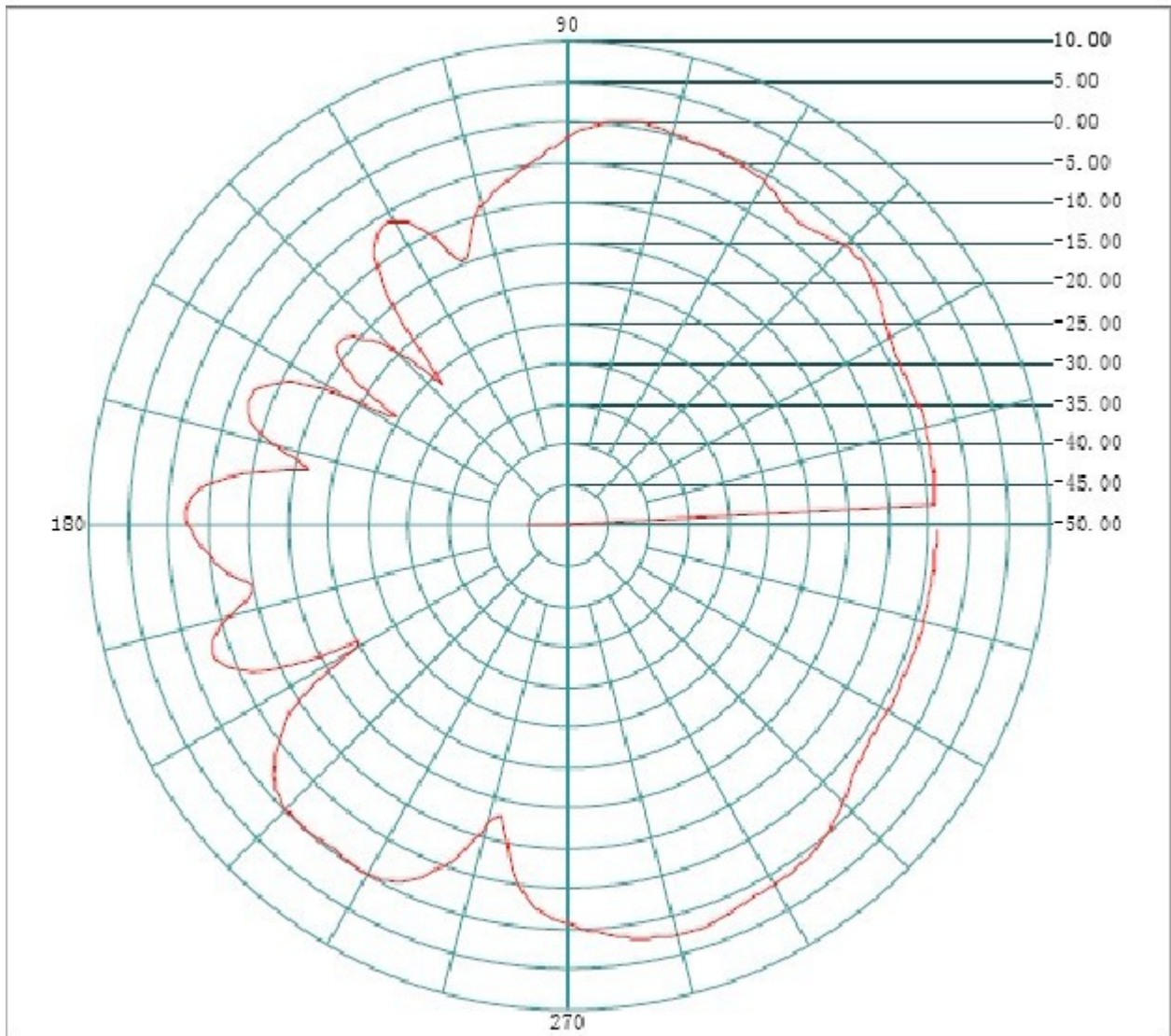

Frequency(MHZ): **2402**

Antenna Polarity: **Horizontal**

Maximum Value(dBi): **2.34**

Average Gain(dBi) : **-2.48**

Minimum Gain(dBi): **-55.18**

1.2 Vertical

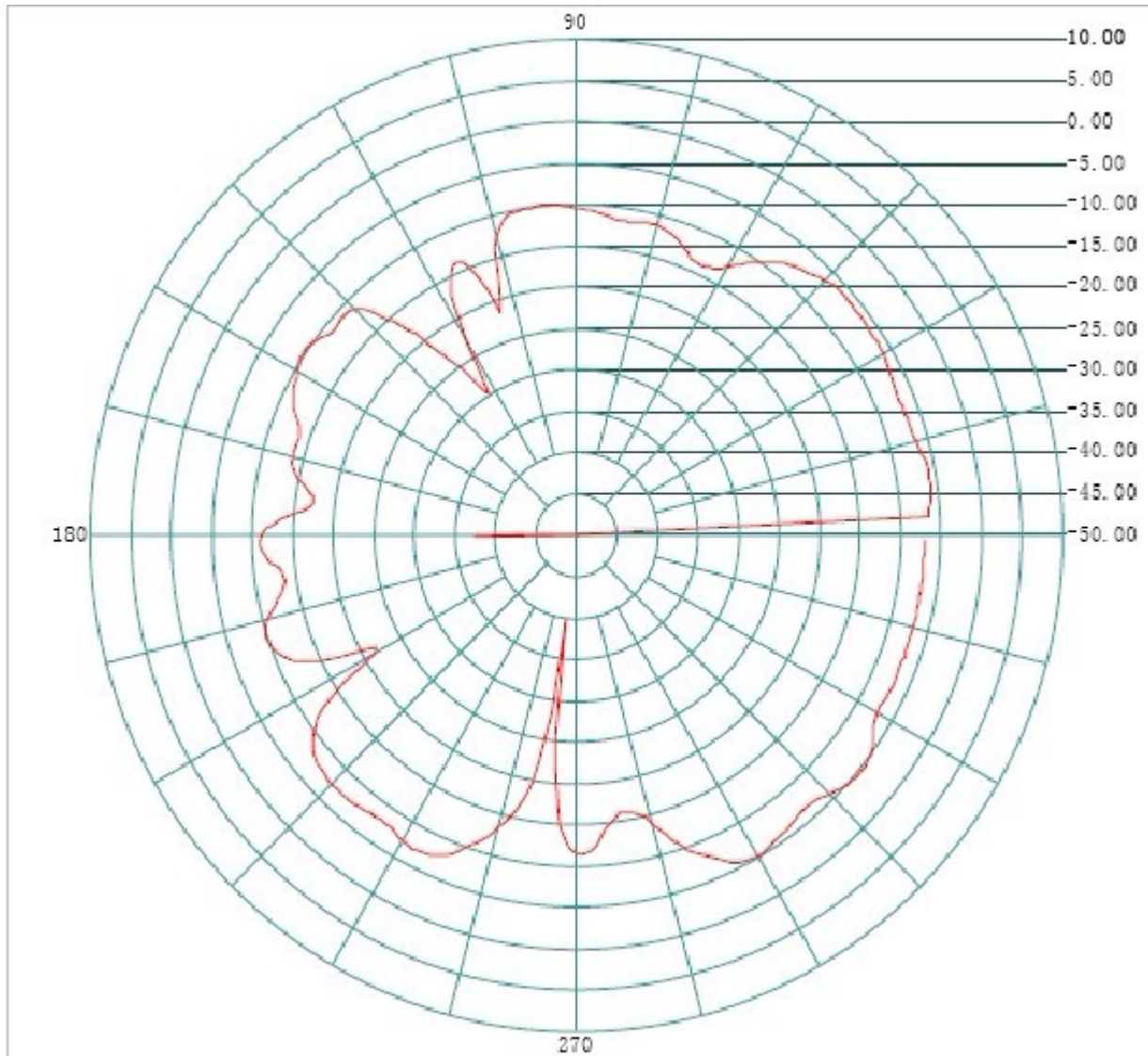

Frequency(MHZ): **2402**

Antenna Polarity: **Vertical**

Maximum Value(dBi): **-4.51**

Average Gain(dBi) : **-8.98**

Minimum Gain(dBi): **-62.3**

2. Main antenna : 2441 MHz

2.1 Horizontal

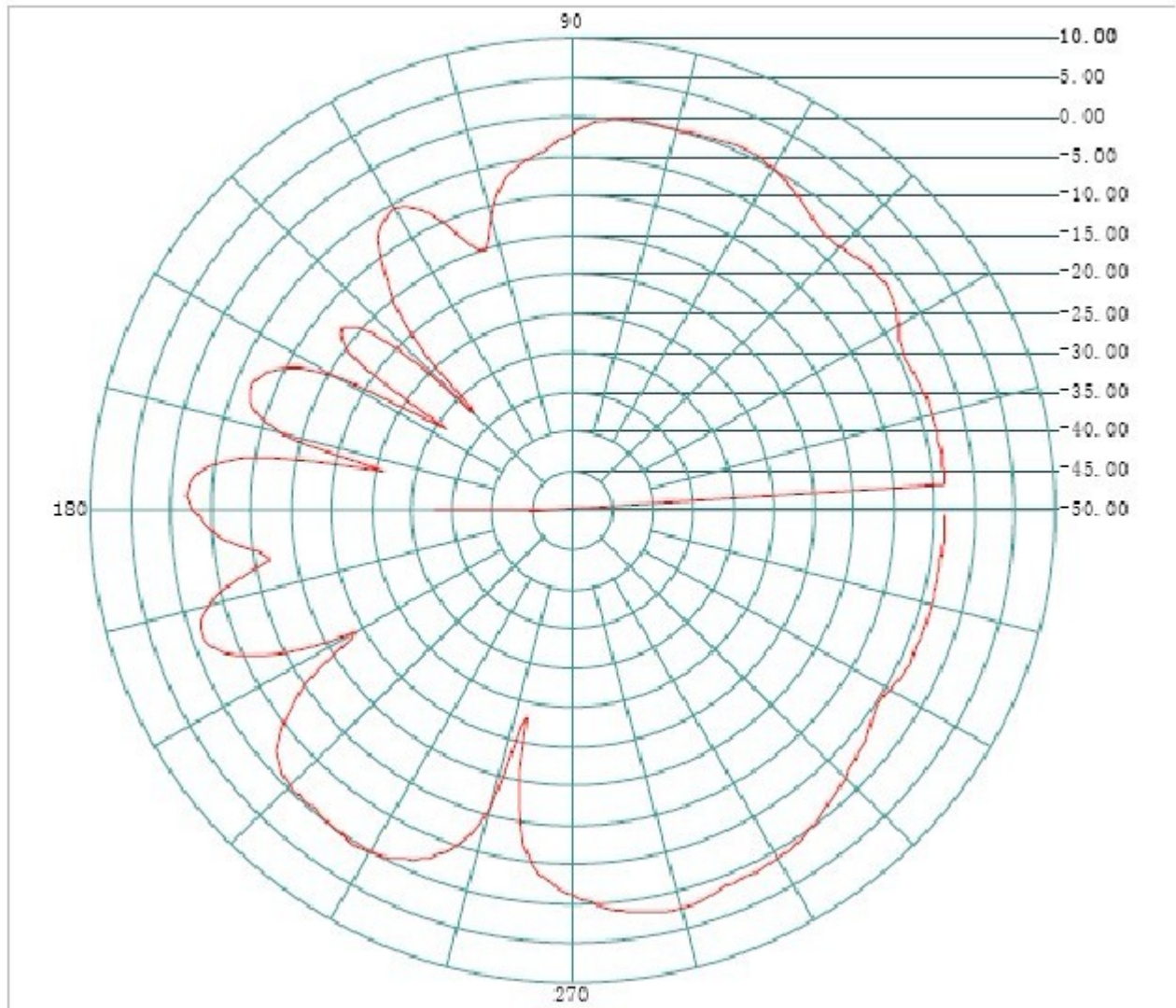

Frequency(MHZ): **2441**

Antenna Polarity: **Horizontal**

Maximum Value(dBi): **2.07**

Average Gain(dBi) : **-2.54**

Minimum Gain(dBi): **-66.98**

2.2 Vertical

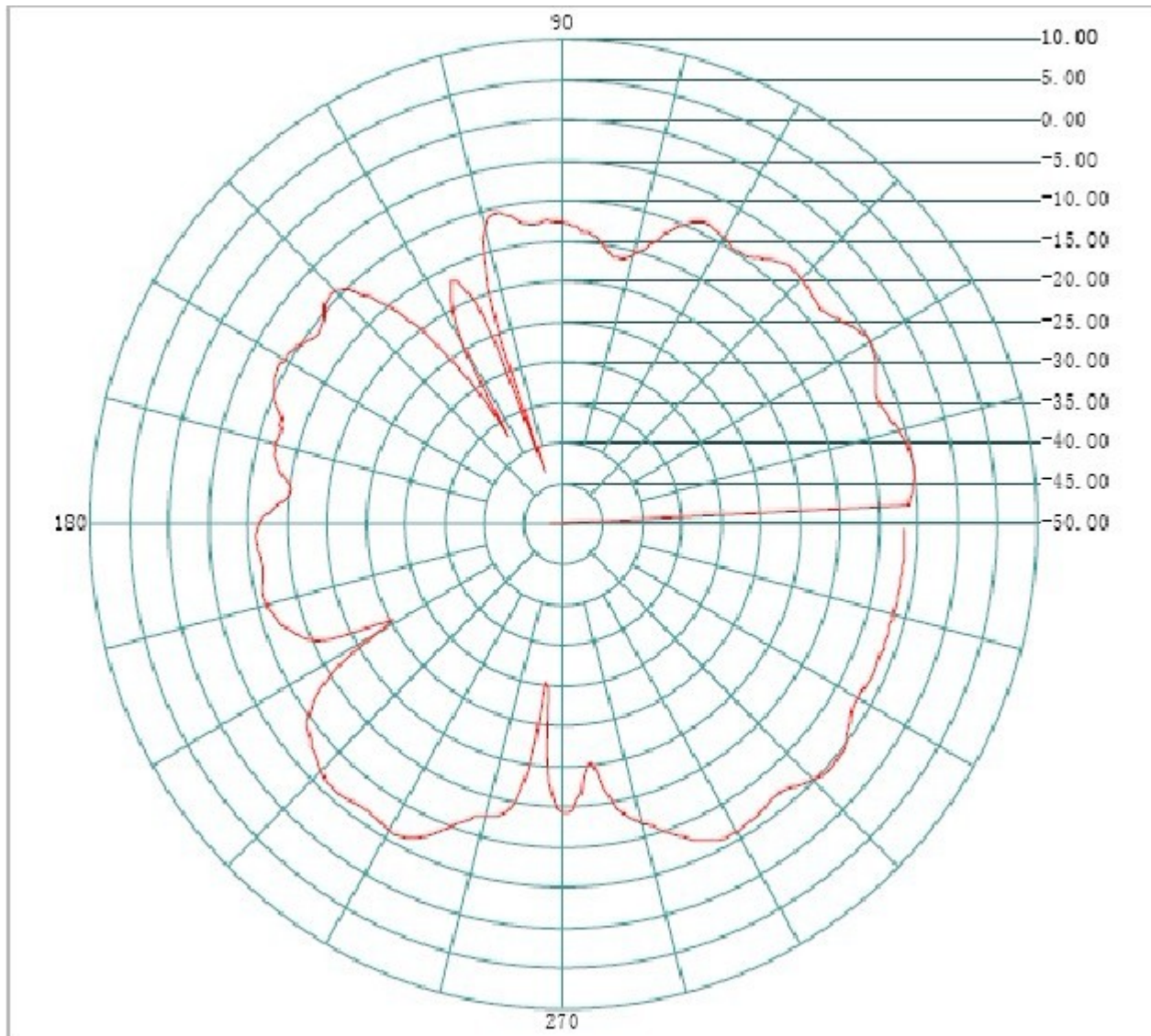

Frequency(MHZ): **2441**

Antenna Polarity: **Vertical**

Maximum Value(dBi): **-4.29**

Average Gain(dBi) : **-8.81**

Minimum Gain(dBi): **-51.4**

2. Main antenna : 2480 MHz

2.1 Horizontal

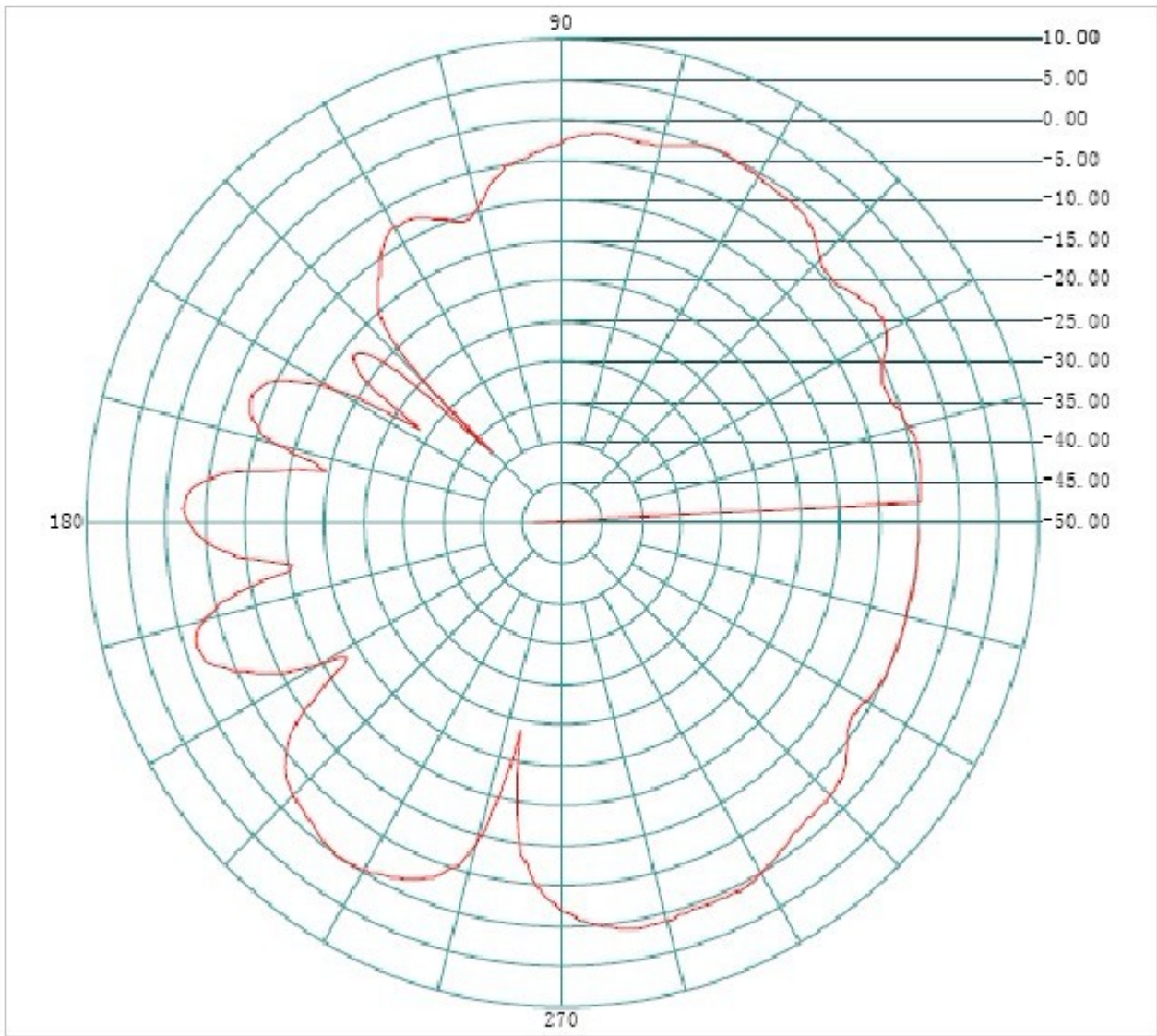

Frequency(MHZ): **2480**

Antenna Polarity: **Horizontal**

Maximum Value(dBi): **1.45**

Average Gain(dBi) : **-3.34**

Minimum Gain(dBi): **-53.4**

2.2 Vertical

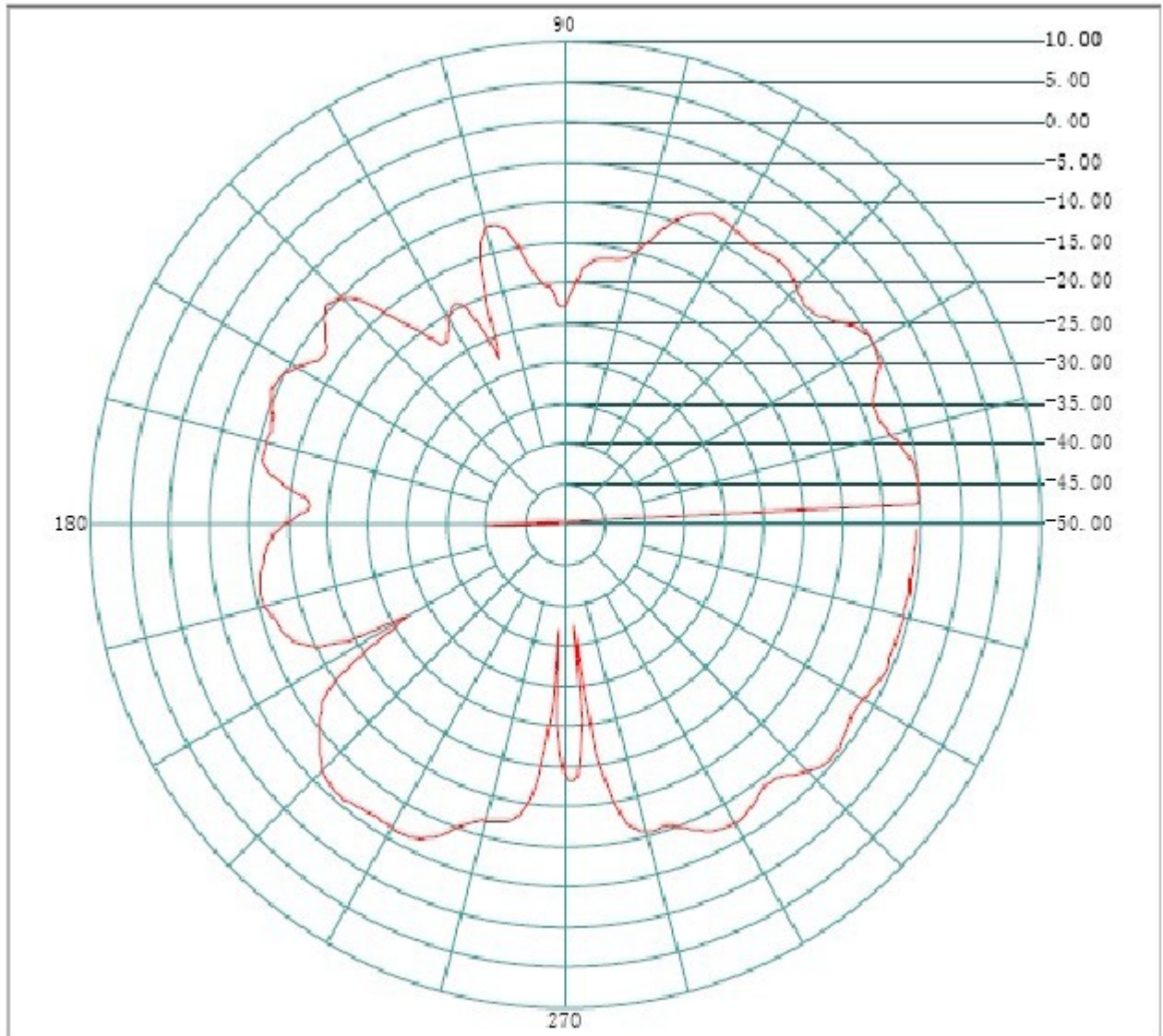

Frequency(MHZ): **2480**

Antenna Polarity: **Vertical**

Maximum Value(dBi): **-4.95**

Average Gain(dBi) : **-9.06**

Minimum Gain(dBi): **-60.00**