

TEST REPORT

1. Applicant

Name : LG-Ericsson Co.,Ltd.
Address : 533, Hogue-1dong, Dongan-gu, Anyang-si, Gyeonggi-do,
431-749, Korea

2. Products

Name : DECT Base Station
Model : GDC-600BE
Manufacturer : LN Srithai Comm Co.,Ltd.

3. Test Standard/Method : FCC Part 15 Subpart D & RSS-213 / ANSI C63.17

4. Test Results : Positive

5. Use of Report : -

6. Date of Application : August 22, 2011

7. Date of Issue : September 20, 2011

Tested by



Jong-gon Ban

Telecommunication Center
Senior Engineer

Approved by



Jeong-min Kim

Telecommunication Center
Manager

The test results contained apply only to the test sample(s) supplied by the applicant, and this test report shall not be reproduced in full or in part without approval of the KTL in advance.

Korea Testing Laboratory

TABLE OF CONTENTS

1. GENERAL INFORMATIONS	3
2. SUMMARY OF TEST RESULTS	5
3. TEST RESULTS	7
3.1 ANTENNA REQUIREMENTS	7
3.2 DIGITAL MODULATION TECHNICS	8
3.3 EMISSION BANDWIDTH.....	9
3.4 POWER ADJUSTMENT FOR ANTENNA GAIN.....	11
3.5 RADIATED OUT OF BAND EMISSION.....	12
3.6 PEAK TRANSMIT POWER	13
3.7 POWER SPECTRAL DENSITY	16
3.8 AUTOMATICALLY DISCONTINUED TRANSMISSION.....	18
3.9 IN-BAND EMISSIONS	19
3.10 OUT-OF-BAND EMISSIONS	21
3.11 CARRIER FREQUENCY STABILITY	28
3.12 FRAME REPETITION STABILITY	29
3.13 FRAME PERIOD AND JITTER.....	30
3.14 MONITORING TIME	31
3.15 MONITORING THRESHOLD.....	32
3.16 MAXIMUM TRANSMIT TIME.....	33
3.17 SYSTEM ACKNOWLEDGEMENT.....	34
3.18 LEAST INTERFERED CHANNEL & CHANNEL CONFIRMATION.....	35
3.19 RANDOM WAITTING.....	36
3.20 MONITORING BANDWIDTH.....	37
3.21 MAXIMUM REACTION TIME	40
3.22 MONITORING ANTENNA.....	42
3.23 DUPLEX CONNECTIONS	43
3.24 ALTERNATIVE MONITORING INTERVAL FOR CO-LOCATED DEVICE.....	44
4. SELF DECLARATION	45
5. TEST SET UP	46
6. TEST EQUIPMENT	47

1. GENERAL INFORMATIONS

1.1 Applicant (Client)

Name	LG-Ericsson Co., Ltd.
Address	533, Hoggye-1dong, Dongan-gu, Anyang-si, Gyeonggi-do, 431-749, Korea
Contact Person	James Kang
Telephone No.	+82 31 450 4803
Facsimile No.	+82 31 450 4745
E-mail address	korjunma@lgericsson.com
Manufacturer	LN Srithai Comm Co.,Ltd.
Manufacturer Address	71/12 Moo 5 Bangna Trad Rd. KM 52 ThakarmBanpakong Chachoengsao 24130, Thailand

1.2 Equipment (EUT)

Name	DECT Base Station
Model Name	GDC-600BE
FCC ID	TUIGDC-600BE
IC Number	6241A-GDC600BE
Operating Frequency	1921.536 ~ 1928.448 MHz
Number of channels	5
Type of Modulation	GFSK
Hardware Version	V1.0
Software Version	V1.0
Serial No.	Prototype
EUT Information	GDC-600BE is a DECT base station and function as a Remote Fixed Part. GDC-600BE is connected to a Fixed Part of LG-Ericsson system and supports 6 simultaneous dect calls.
Operation During Under Test	GDC-600BE is connected to IPLDK-60 system via WDIB4, DECT fixed part and works in theTBR6 (loop back) mode. To test normal working condition, GDC-600BE should work in the normal mode, and DECT call set-up should be established between DECT terminal,GDC-450H, and Key Telephone Unit, LDP-7024D.

1.3 Technical specifications

Frequency Band	1920 ~ 1930 MHz
Frame Period	10 ms
Time Slot Length	416.67 us
Slots	12 RX, 12 TX slots
Slot Structure	6 active duplex pairs per frame
Bit Rate	1.152 Mbit
Number of channels	5 RF Channels, 5x12=60 TDMA duplex Channels

Frequency Band	Frequency
Channel 1	1921.536 MHz
Channel 2	1923.264 MHz
Channel 3	1924.992 MHz
Channel 4	1926.720 MHz
Channel 5	1928.448 MHz

1.4 Testing Laboratory

Testing Place	Korea Testing Laboratory (KTL) 723, Hae-an-ro, Sangnok-gu, Ansan-si Gyunggi-Do, Korea
FCC registration number	408324
Industry Canada filing number	6298A
Test Engineer	Jong gon Ban
Telephone number	+82 31 5000 133
Facsimile number	+82 31 5000 149
E-mail address	banjg@ktl.re.kr

2. SUMMARY OF TEST RESULTS

Name of Test	FCC Part	RSS-212	Test Procedure ANSIC63.17	Verdict
Antenna Requirements	15.317, 15.203	7.1.4	Declaration	Attestation
Digital Modulation Techniques	15.319(b)	6.1	6.1.4	Attestation
Emission Bandwidth	15.323(a)	6.4	6.1.3	Complies
Power adjustment for antenna gain	15.319(e)	4.1(e)	4	Attestation
Conducted Emission	15.207(a)	6.3	ANSI C63.4	N/A
Radiated Out of Band Emission	15.209(a)	6.8	ANSI C63.4	N/A
Peak transmit power	15.319(c)(e)	6.5	6.1.2	Complies
Power spectral density	15.319(d)	6.6	6.1.5	Complies
Automatically discontinue transmission	15.319(f)	4.3.4(a)	--	Complies
In-band emissions	15.323(d)	6.7.2	6.1.6.1	Complies
Out-of-band emission	15.323(d)	6.7.1	6.1.6.2	Complies
Carrier frequency stability	15.323(f)	6.2	6.2.1	Complies
Frame repetition stability	15.323(e)	4.3.4(c)	6.2.2	Complies
Frame period and jitter	15.323(e)	4.3.4(c)	6.2.3	Complies
Monitoring time	15.323(c)(1)	4.3.4(b1)	7.3.4	Complies
Monitoring threshold	15.323(c)(2)	4.3.4(c5&c9)	7.3.1	Complies
Maximum transmit time	15.323(c)(3)	4.3.4(b3)	8.2.2	Complies
System acknowledgement	15.323(c)(4)	4.3.4(b4)	8.1.1 & 8.2.1	Complies
Least Interfered Channel	15.323(c)(5)	4.3.4(b5)	7.3.2, 7.3.3	Complies
Random waiting	15.323(c)(6)	4.3.4(b6)	8.1.3	Attestation
Monitoring Bandwidth	15.323(c)(7)	4.3.4(b7)	7.4	Complies
Maximum reaction time	15.323(c)(7)	4.3.4(b7)	7.5	Complies
Monitoring antenna	15.323(c)(8)	4.3.4(b8)	4	Attestation
Duplex Connections	15.323(c)(10)	4.3.4(b10)	8.3	Attestation
Alternative Monitoring Interval for Co-located Device	15.323(c)(11)	4.3.4(b11)	8.4	Attestation
Receiver Spurious Emission	15.109	6.8	ANSI C63.4	Complies

Note 1 : Test results reported in this document relate only to the items tested

Note 2 : The required tests demonstrated compliance as per client declaration of test configuration, monitoring methodology and associated pass/fail criteria

Note 3 : Test results apply only to the item(s) tested

*** Modifications required for compliance**

No modifications were implemented by KTL.

All results in this report pertain to the un-modified sample provided to KTL.

3. TEST RESULTS

3.1 Antenna Requirements

3.1.1 Requirement

EUT must meet the antenna requirement of FCC Rule 15.203

- EUT uses a permanently attached antenna which is considered sufficient to comply with the provisions of this rule.
- EUT uses a unique antenna jack or electrical connector which is considered sufficient to comply with the provisions of this rule.

3.1.2 Attestation

The EUT use permanently attached antennas.

3.2 Digital Modulation Techniques

3.2.1 Requirement

All transmissions must use only digital modulation techniques.

3.2.2 Attestation

The tested equipment is based on DECT technology described in the ETSI EN 300 175, the only difference is that the channel allocation is modified to operate in the 1920-1930 MHz band.

3.3 Emission Bandwidth

3.3.1 FCC rule - FCC 15.323(a)

(a) Operation shall be contained within the 1920-1930 MHz band. The emission bandwidth shall be less than 2.5 MHz. The power level shall be as specified in § 15.319(c), but in no event shall the emission bandwidth be less than 50 kHz.

3.3.2 Test Procedure - ANSI C63.17 sub-clause 6.1.3.

3.3.3 Test Results

Channel	Result (MHz)	Limit (MHz)	Verdict
1	1.482	2.5	Complies
2	1.483	2.5	Complies
3	1.479	2.5	Complies

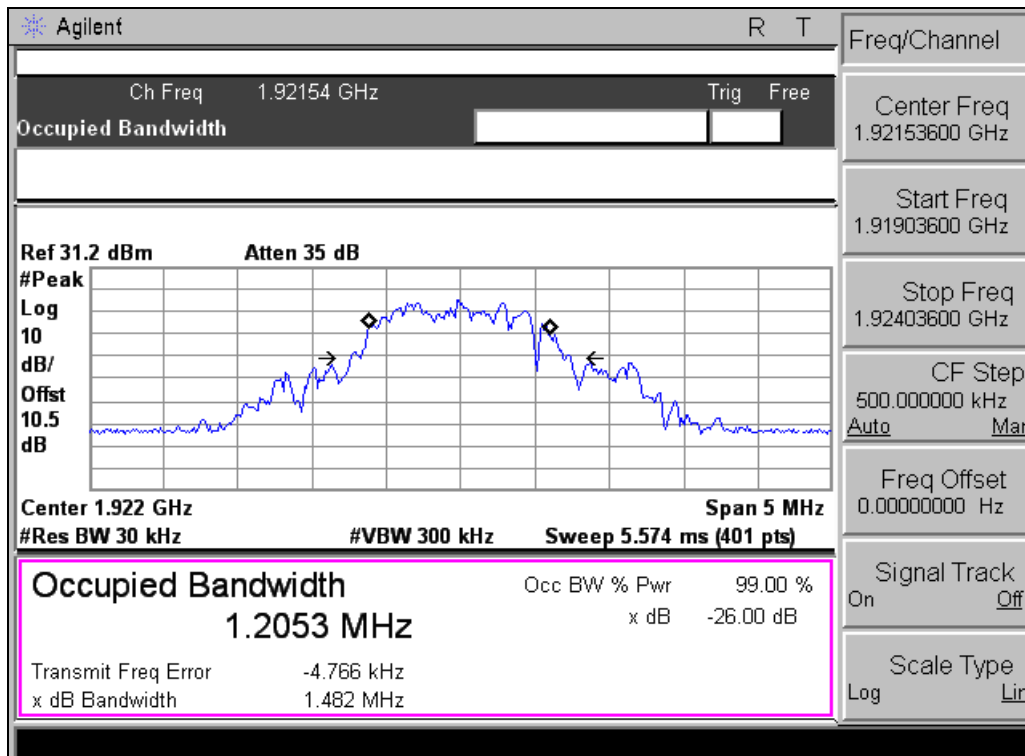

- Emission Bandwidth of Ch 1 -

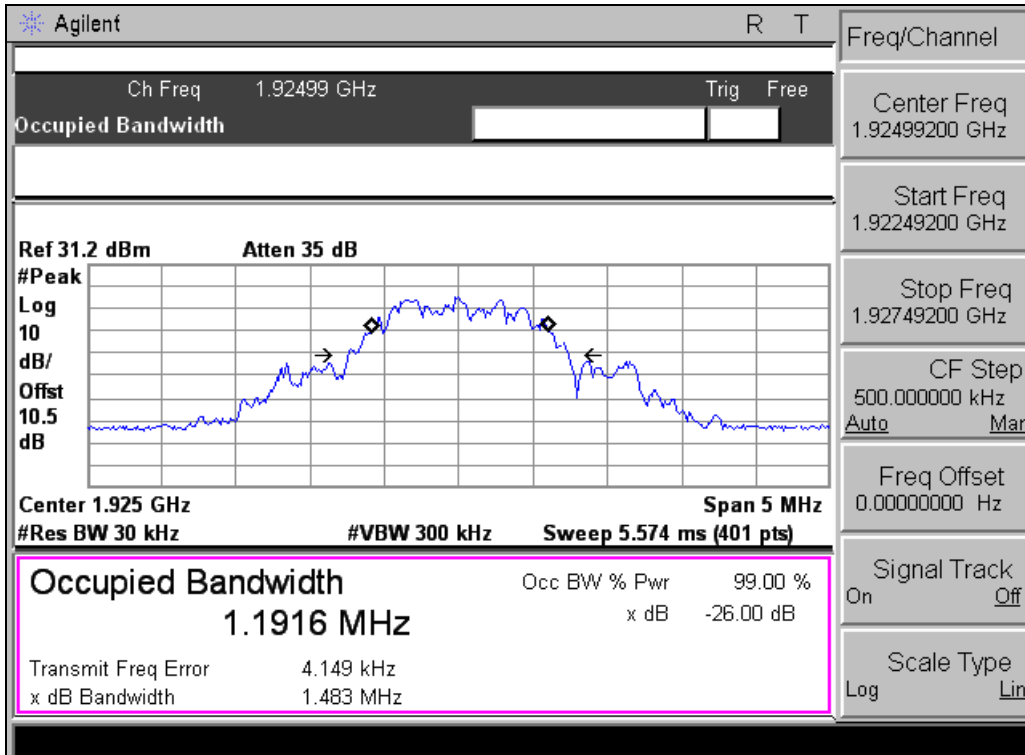

- Emission Bandwidth of Ch 3 -

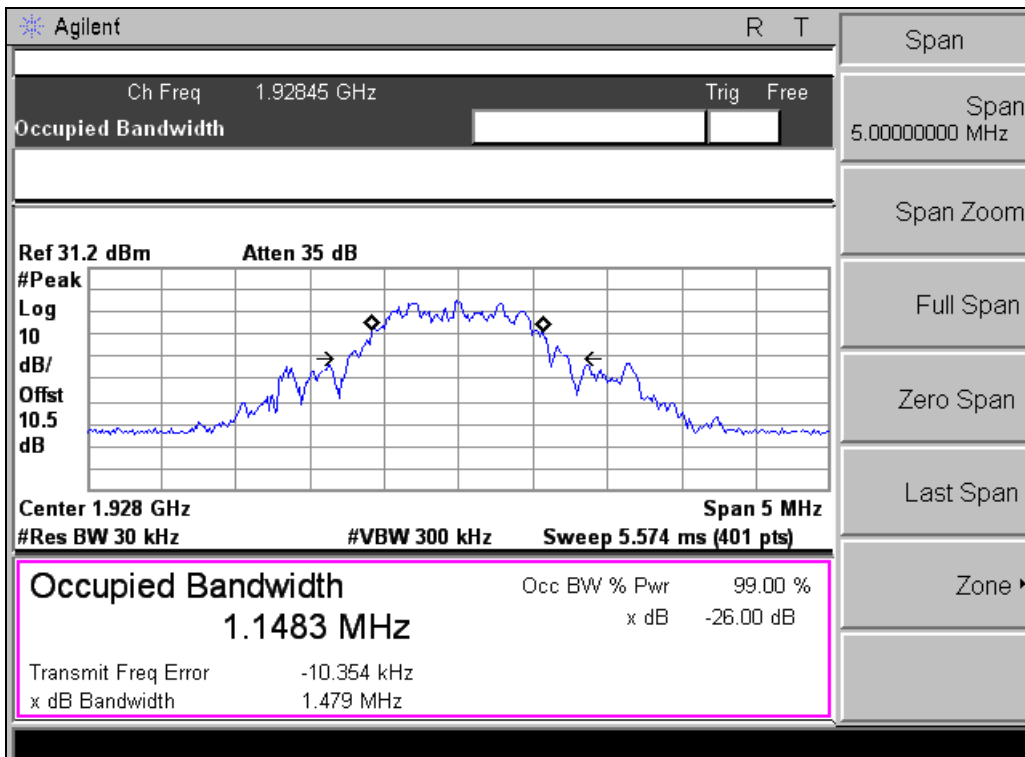

- Emission Bandwidth of Ch 5 -

3.4 Power adjustment for antenna gain

3.4.1 Test limit - FCC 15.319(e)

(e) The peak transmit power shall be reduced by the amount in decibels that the maximum directional gain of the antenna exceeds 3 dBi.

3.4.2 Test results

The maximum antenna gain is 2.5 dBi.

3.5 Radiated Out of Band Emission

3.5.1 Test procedure – FCC Part 15.209

3.5.2 Test result

Not tested.

This test is not required if the Out-of-Band Emissions is tested conducted and is Pass.

3.6 Peak transmit power

3.6.1 Test limit - FCC 15.319(c)

(c) Peak transmit power shall not exceed 100 microwatts multiplied by the square root of the emission bandwidth in hertz. Peak transmit power must be measured over any interval of continuous transmission using instrumentation calibrated in terms of an rms-equivalent voltage. The measurement results shall be properly adjusted for any instrument limitations, such as detector response times, limited resolution bandwidth capability when compared to the emission bandwidth, sensitivity, etc., so as to obtain a true peak measurement for the emission in question over the full bandwidth of the channel.

Calculation of Peak transmit power Limit:

The antenna gain = 2.50 dBi

The measured emission bandwidth = 1.483 MHz

Limit : $5 \log B(\text{bandwidth in Hz}) - 10 \text{ dBm} = 20.86 \text{ dBm}$

The Maximum allowed peak transmit power is 20.86 dBm

3.6.2 Test procedure - ANSI C63.17 sub-clause 6.1.2.

3.6.3 Test results

Channel	Result (dBm)	Limit (dBm)	Verdict
1	20.59	20.86	Complies
3	20.59	20.86	Complies
5	20.58	20.86	Complies

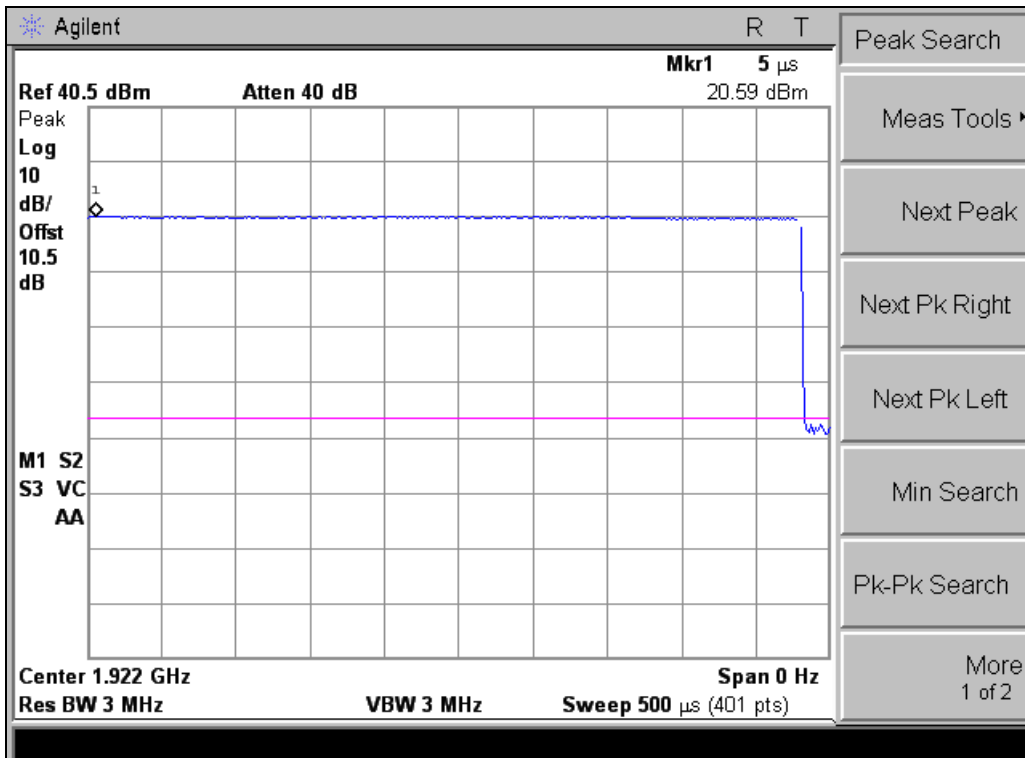

- Peak transmit power of Ch 1 -

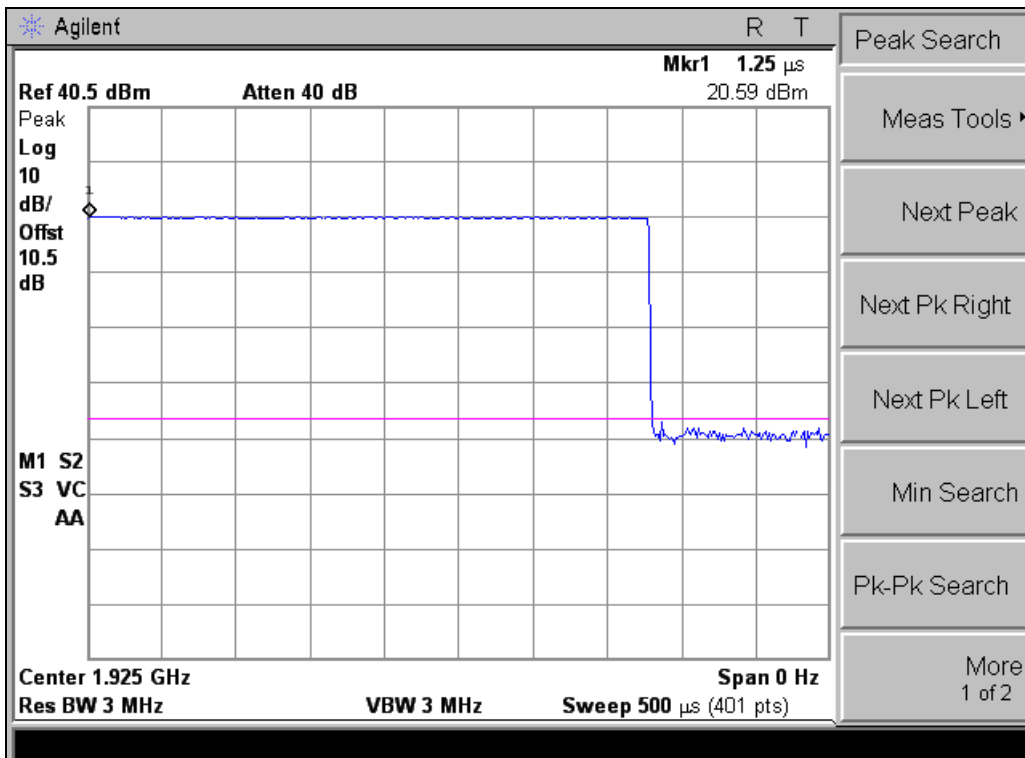

- Peak transmit power of Ch 3 -

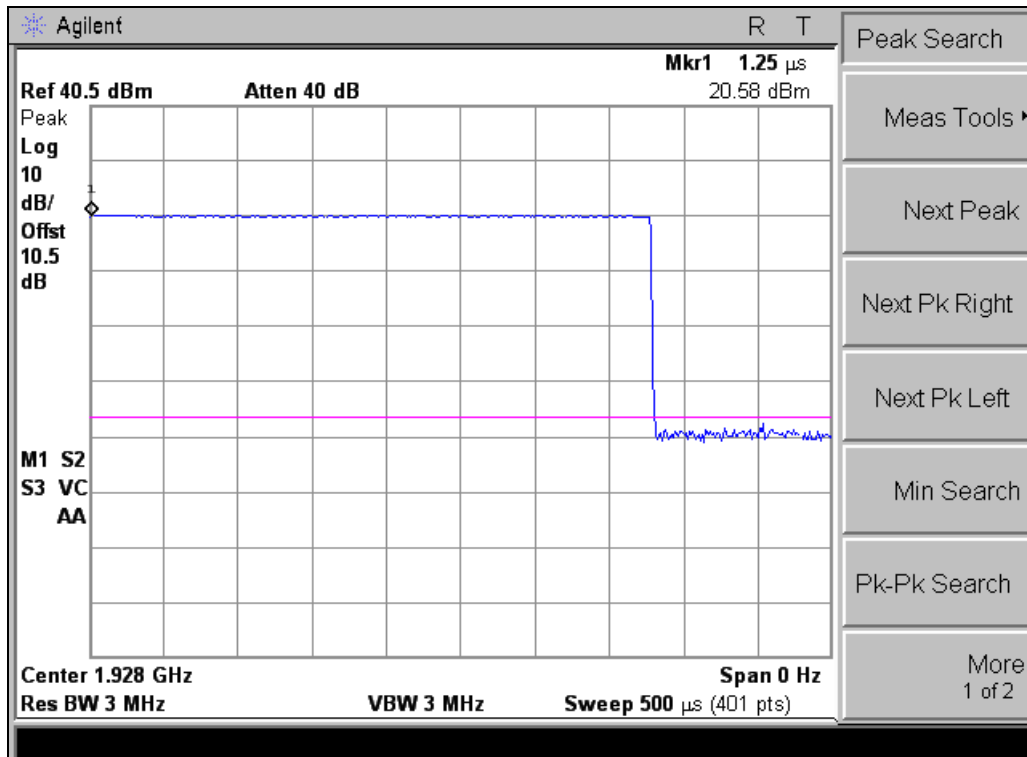

- Peak transmit power of Ch 5 -

3.7 Power spectral density

3.7.1 Test limit - FCC 15.319(c)

(d) Power spectral density shall not exceed 3 milliwatts in any 3 kHz bandwidth as measured with a spectrum analyzer having a resolution bandwidth of 3 kHz.

3.7.2 Test procedure - ANSI C63.17 sub-clause 6.1.5.

3.7.3 Test results

Channel	Result (mW)	Limit (mW)	Verdict
1	1.88	3	Complies
3	2.14	3	Complies
5	2.30	3	Complies

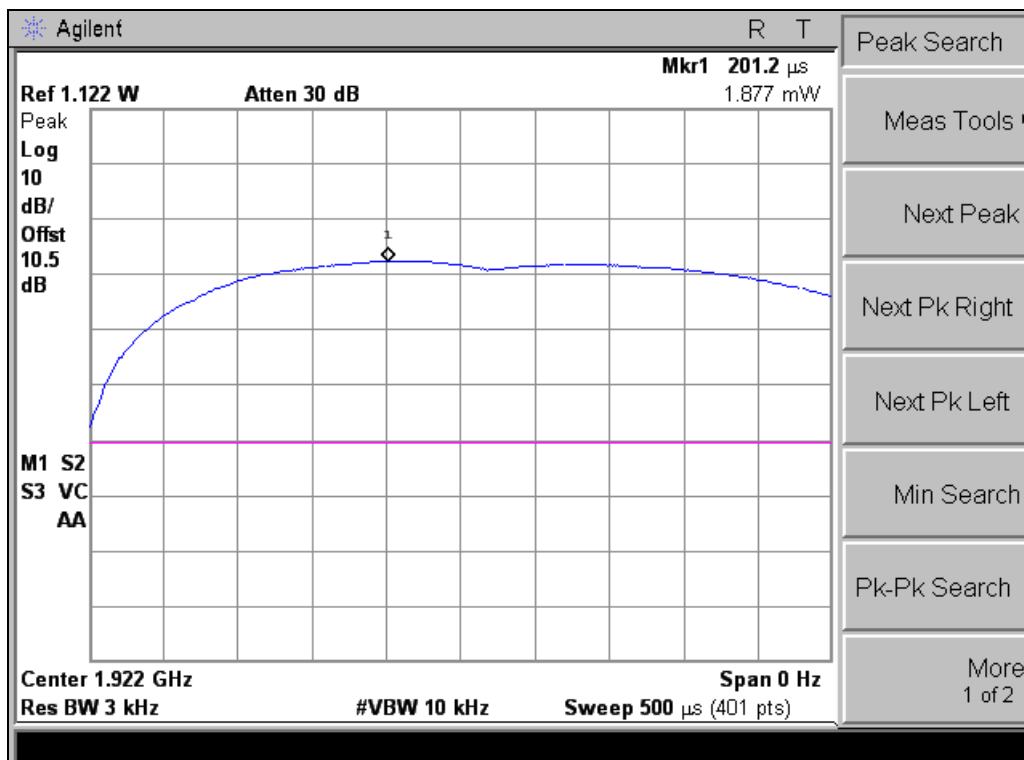

– Power spectral density of Ch 1 –

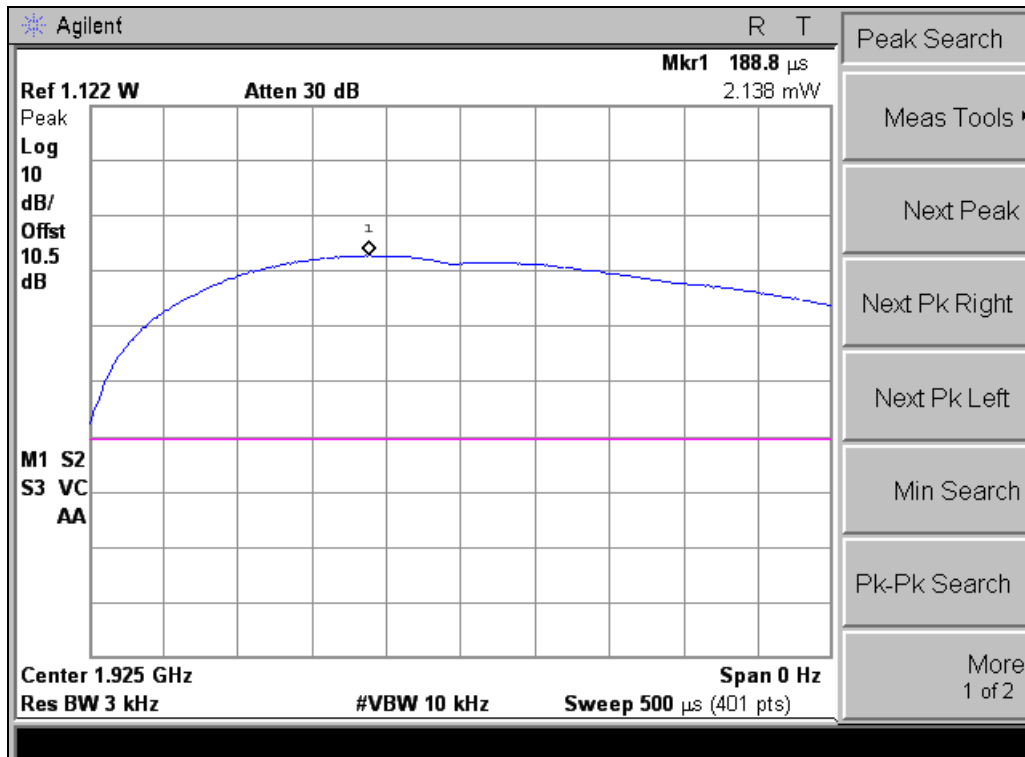

– Power spectral density of Ch 3 –

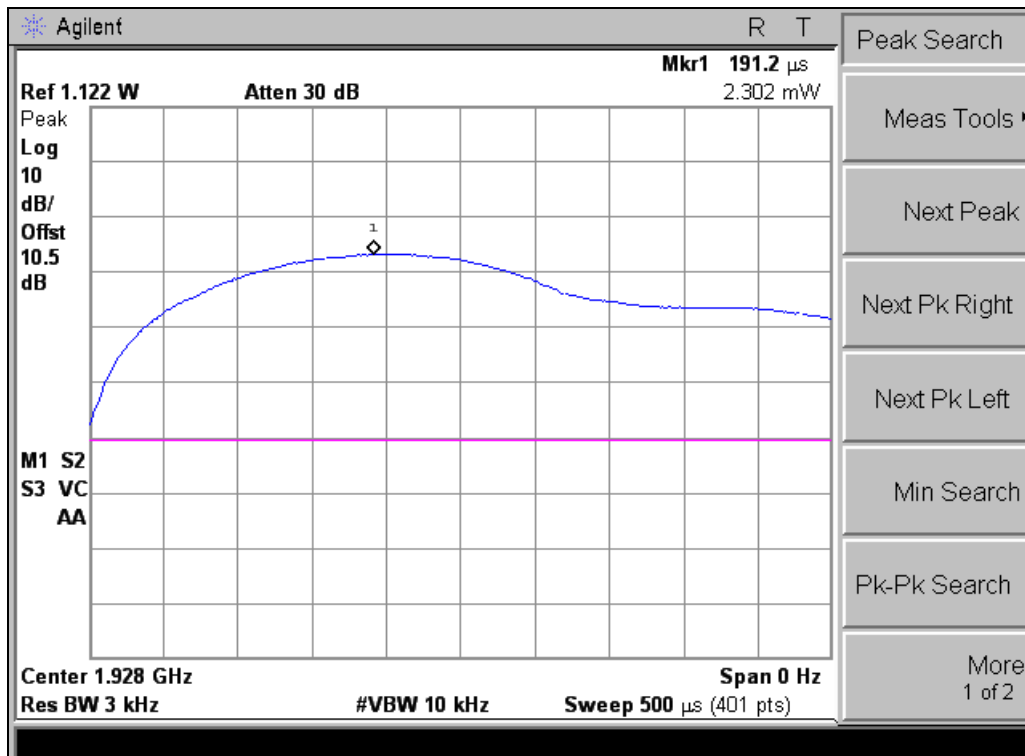

– Power spectral density of Ch 5 –

3.8 Automatically Discontinued Transmission

3.8.1 Test limit - FCC 15.319(f)

(f) The device shall automatically discontinue transmission in case of either absence of information to transmit or operational failure. These provisions are not intended to preclude transmission of control and signaling information or use of repetitive codes used by certain digital technologies to complete frame or burst intervals.

3.8.2 Test procedure

The following tests simulate the reaction of the EUT in case of either absence of information to transmit or operational failure after a connection with the companion devices is established.

	Test	EUT Reaction	Verdict
1	Power removed from the EUT	A/B/C	Pass/Fail
2	EUT Switch Off	A/B/C	Pass/Fail
3	Hook-On by companion device	A/B/C	Pass/Fail
4	Hook-On by EUT	A/B/C	Pass/Fail
5	Power Removed from Companion Device	A/B/C	Pass/Fail
6	Companion Device Switch Off	A/B/C	Pass/Fail

A – Connection breakdown, Cease of all transmissions

B – Connection breakdown, EUT transmits control and signaling information

C – Connection breakdown, Companion Device transmits control and signaling information

NA – Not applicable

3.8.3 Test results

	Test	EUT Reaction	Verdict
1	Power removed from the EUT	C	Pass
2	EUT Switch Off	C	Pass
3	Hook-On by companion device	NA	Pass
4	Hook-On by EUT	NA	Pass
5	Power Removed from Companion Device	A	Pass
6	Companion Device Switch Off	NA	Pass

3.9 In-band emissions

3.9.1 Test limit - FCC 15.323(d)(2)

(d) Emissions outside the sub-band shall be attenuated below a reference power of 112 milliwatts as follows: 30 dB between the sub-band and 1.25 MHz above or below the sub-band; 50 dB between 1.25 and 2.5 MHz above or below the sub-band; and 60 dB at 2.5 MHz or greater above or below the subband. Emissions inside the sub-band must comply with the following emission mask: In the bands between 1B and 2B measured from the center of the emission bandwidth the total power emitted by the device shall be at least 30 dB below the transmit power permitted for that device; in the bands between 2B and 3B measured from the center of the emission bandwidth the total power emitted by an intentional radiator shall be at least 50 dB below the transmit power permitted for that radiator; in the bands between 3B and the sub-band edge the total power emitted by an intentional radiator in the measurement bandwidth shall be at least 60 dB below the transmit power permitted for that radiator. "B" is defined as the emission bandwidth of the device in hertz. Compliance with the emission limits is based on the use of measurement instrumentation employing peak detector function with an instrument resolution bandwidth approximately equal to 1.0 percent of the emission bandwidth of the device under measurement.

3.9.2 Test procedure - ANSI C63.17 sub-clause 6.1.6.1.

3.9.3 Test results

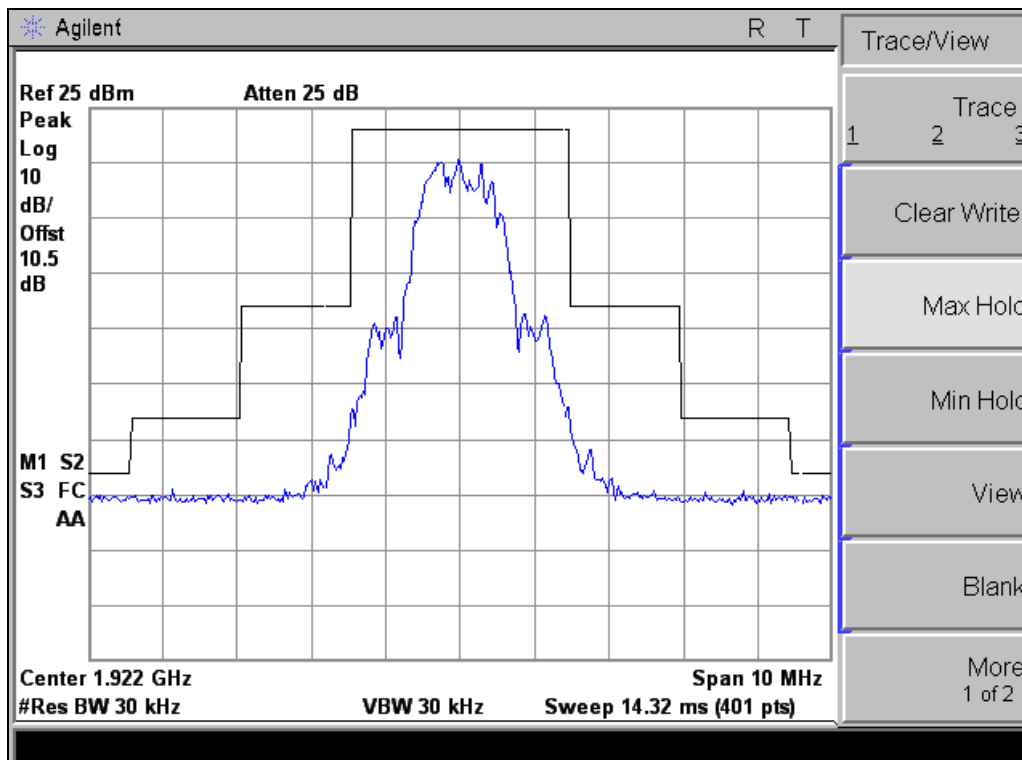

– In-band emission of Ch 1 –

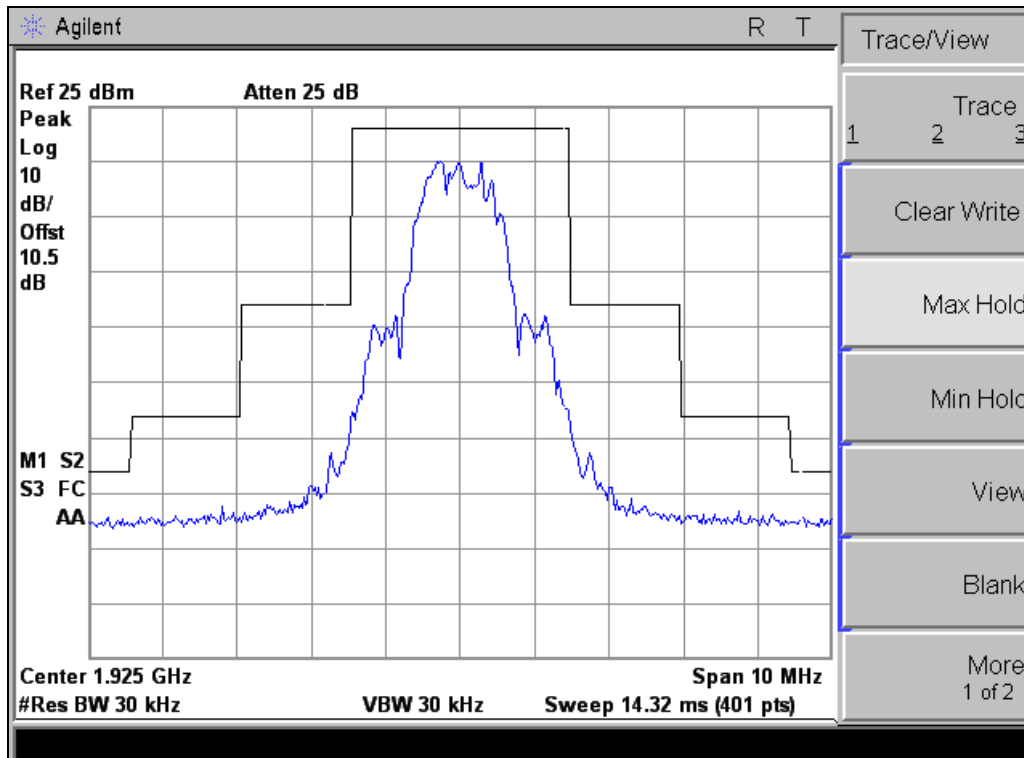

- In-band emission of Ch 3 -

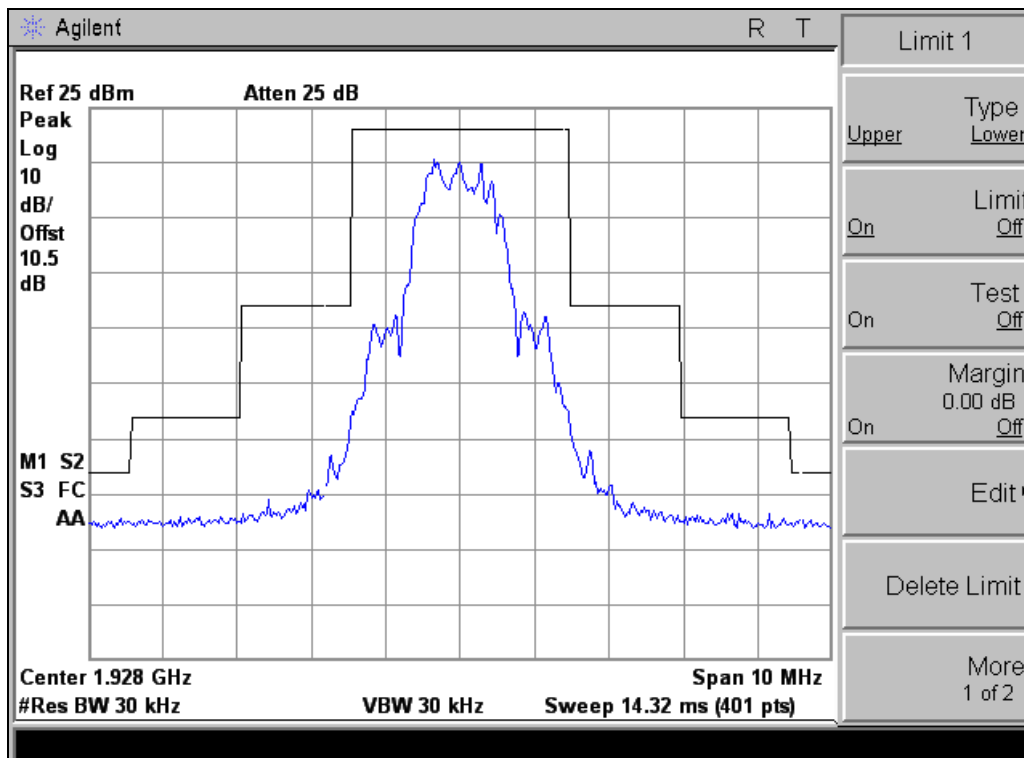

- In-band emission of Ch 5 -

3.10 Out-of-band emissions

3.10.1 Test limit - FCC 15.323(d)(2)

(d) Emissions outside the sub-band shall be attenuated below a reference power of 112 milliwatts as follows: 30 dB between the sub-band and 1.25 MHz above or below the sub-band; 50 dB between 1.25 and 2.5 MHz above or below the sub-band; and 60 dB at 2.5 MHz or greater above or below the subband. Emissions inside the sub-band must comply with the following emission mask: In the bands between 1B and 2B measured from the center of the emission bandwidth the total power emitted by the device shall be at least 30 dB below the transmit power permitted for that device; in the bands between 2B and 3B measured from the center of the emission bandwidth the total power emitted by an intentional radiator shall be at least 50 dB below the transmit power permitted for that radiator; in the bands between 3B and the sub-band edge the total power emitted by an intentional radiator in the measurement bandwidth shall be at least 60 dB below the transmit power permitted for that radiator. "B" is defined as the emission bandwidth of the device in hertz. Compliance with the emission limits is based on the use of measurement instrumentation employing peak detector function with an instrument resolution bandwidth approximately equal to 1.0 percent of the emission bandwidth of the device under measurement.

3.10.2 Test procedure - ANSI C63.17 sub-clause 6.1.6.2.

3.10.3 Test results

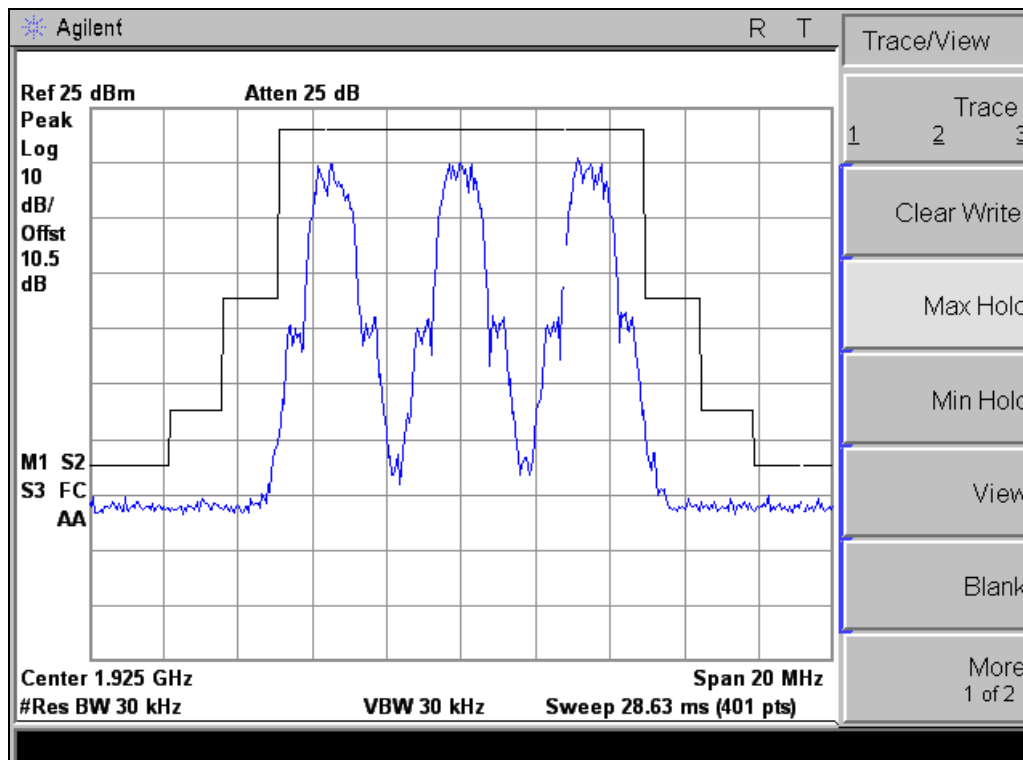

– Out-of-band emission –

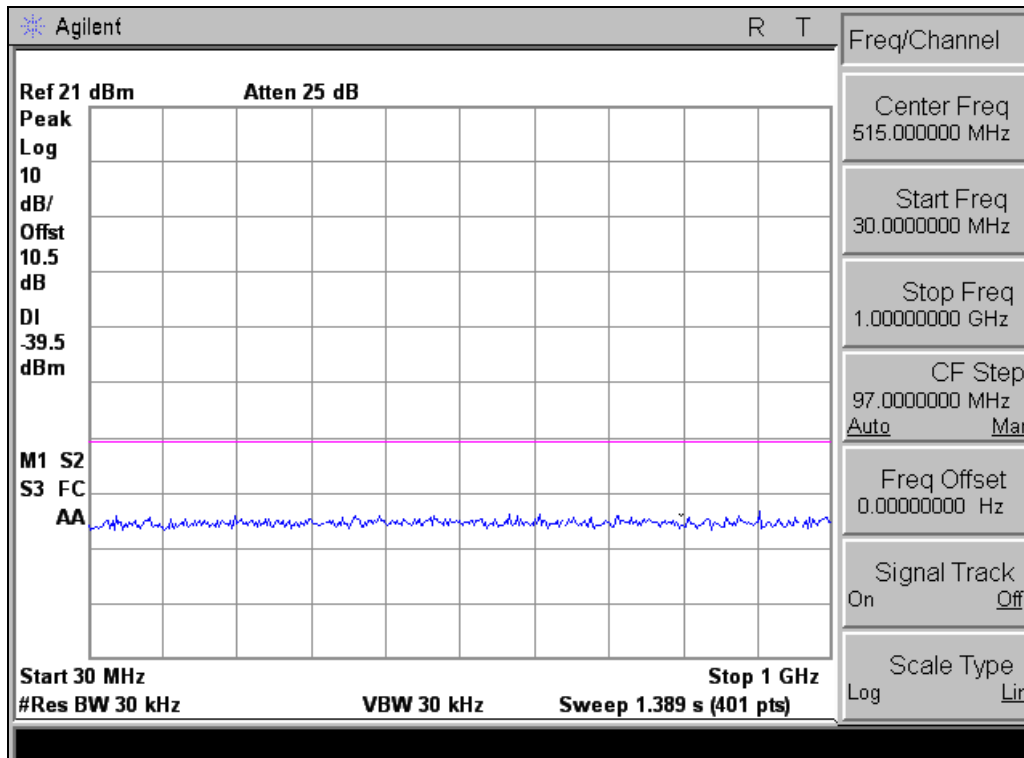

- Out-of-band emission of ch1 -

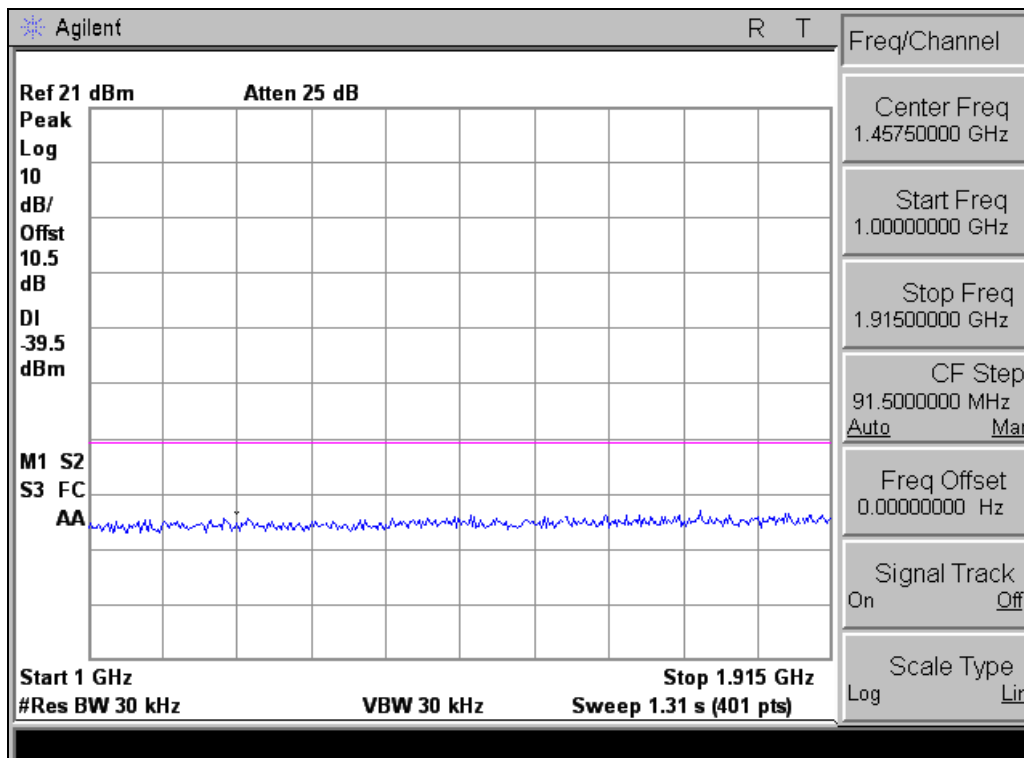

- Out-of-band emission of ch1 -

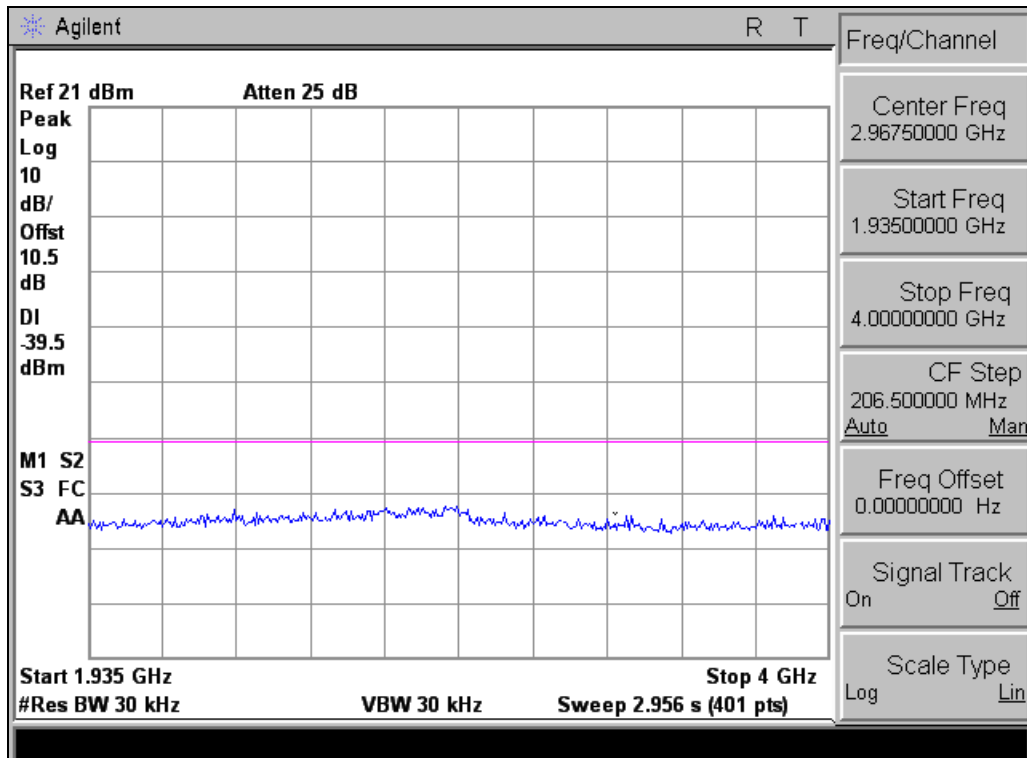

- Out-of-band emission of ch1 -

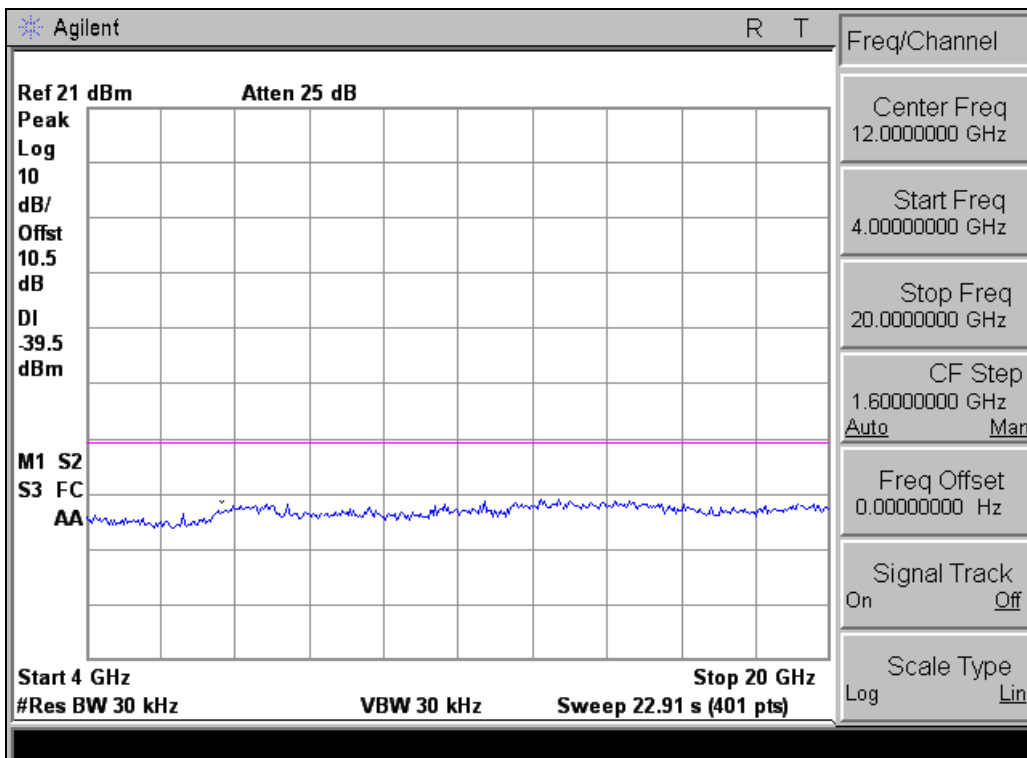

- Out-of-band emission of ch1 -

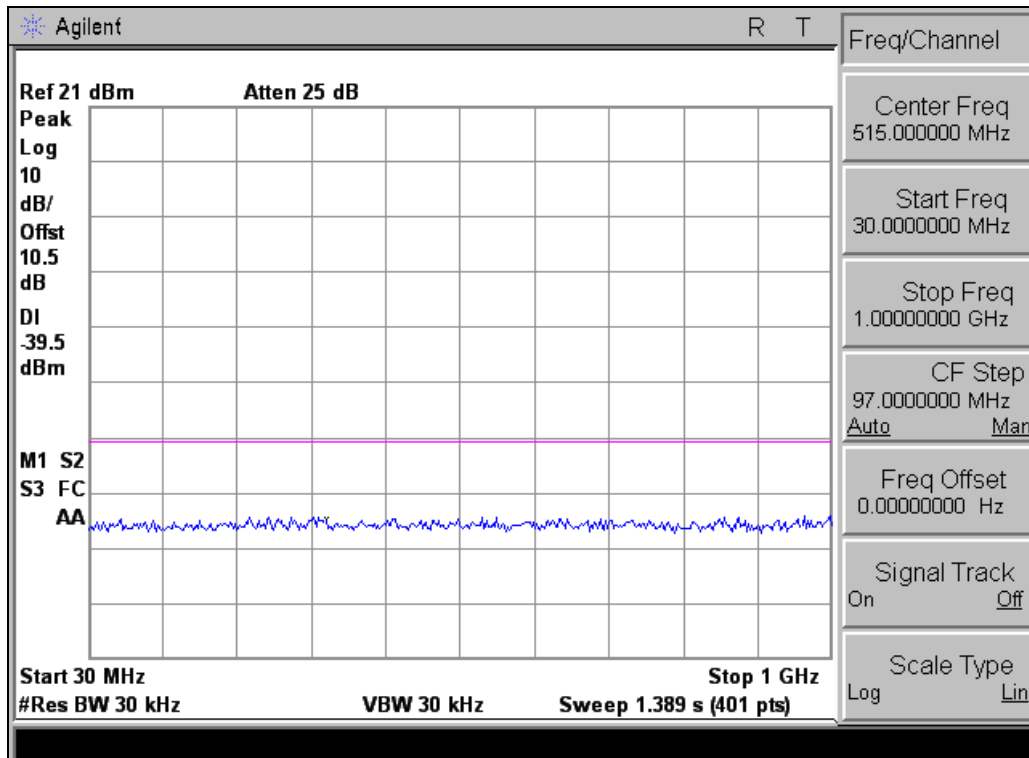

- Out-of-band emission of ch3 -

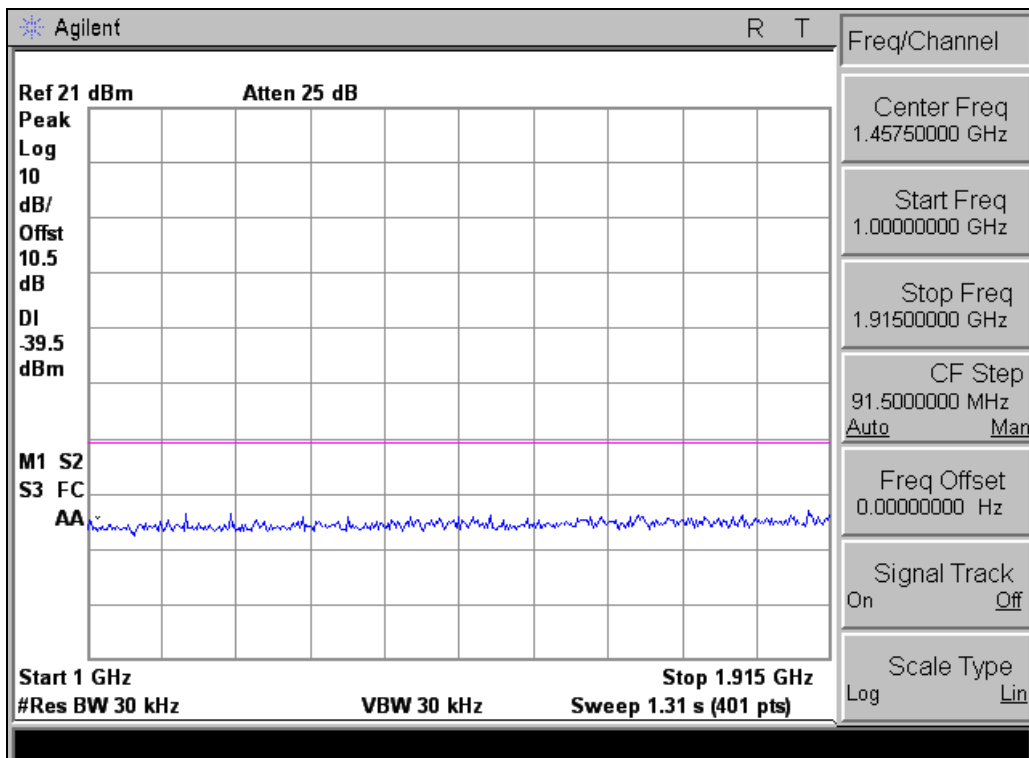

- Out-of-band emission of ch3 -

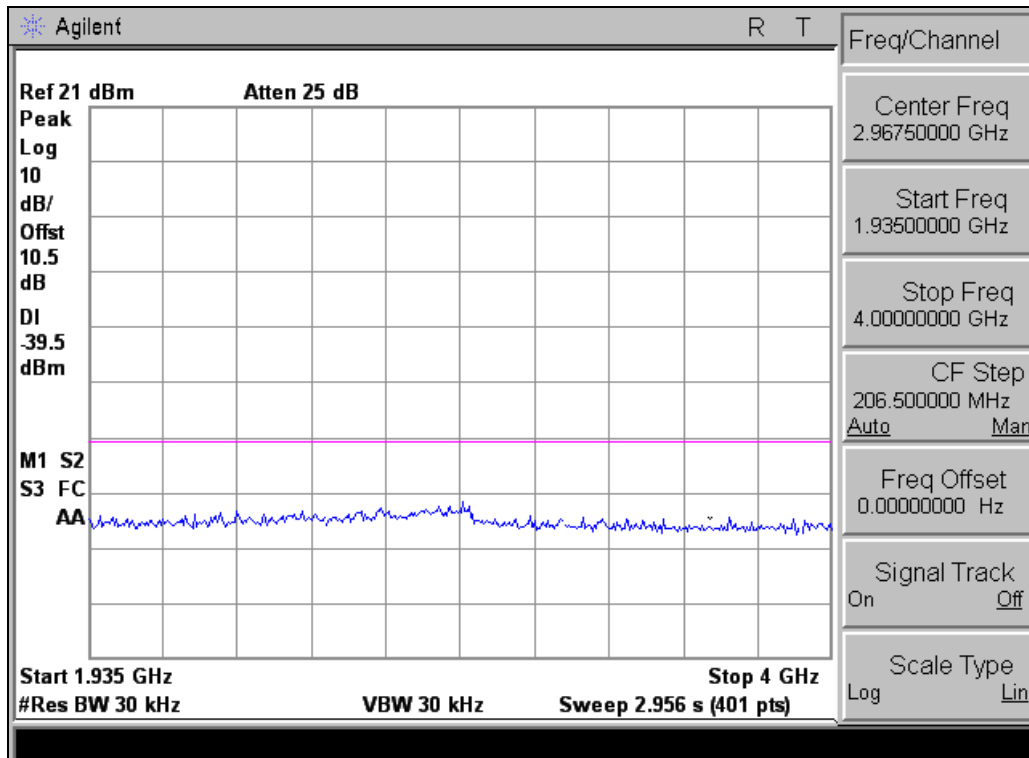

- Out-of-band emission of ch3 -

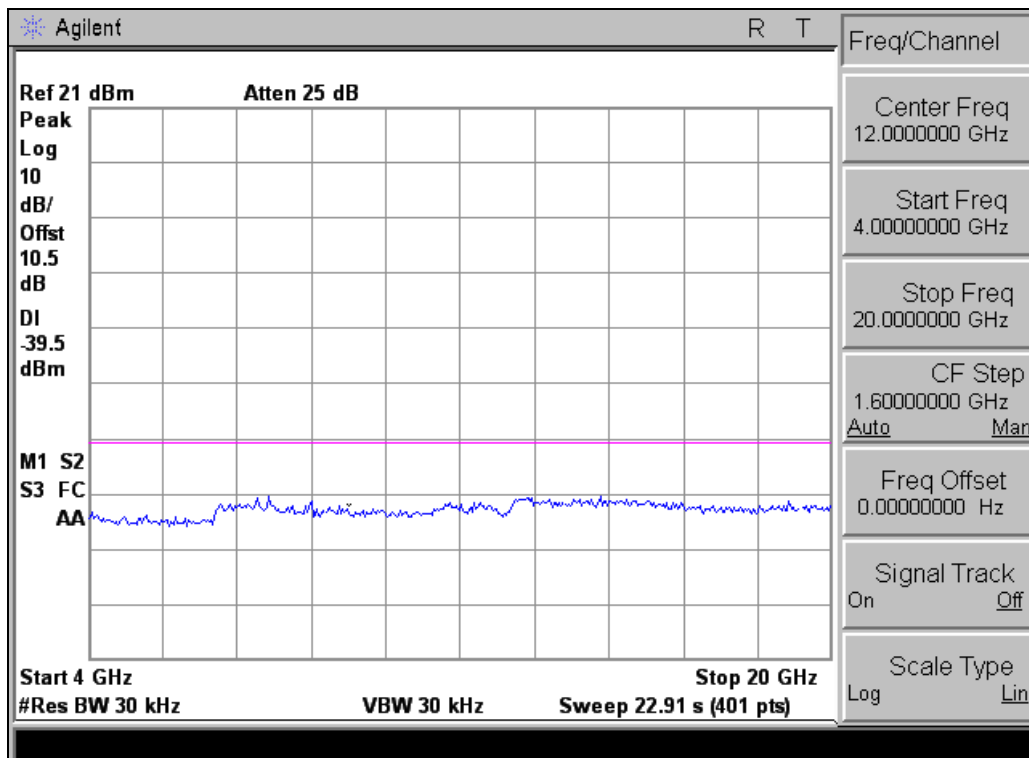

- Out-of-band emission of ch3 -

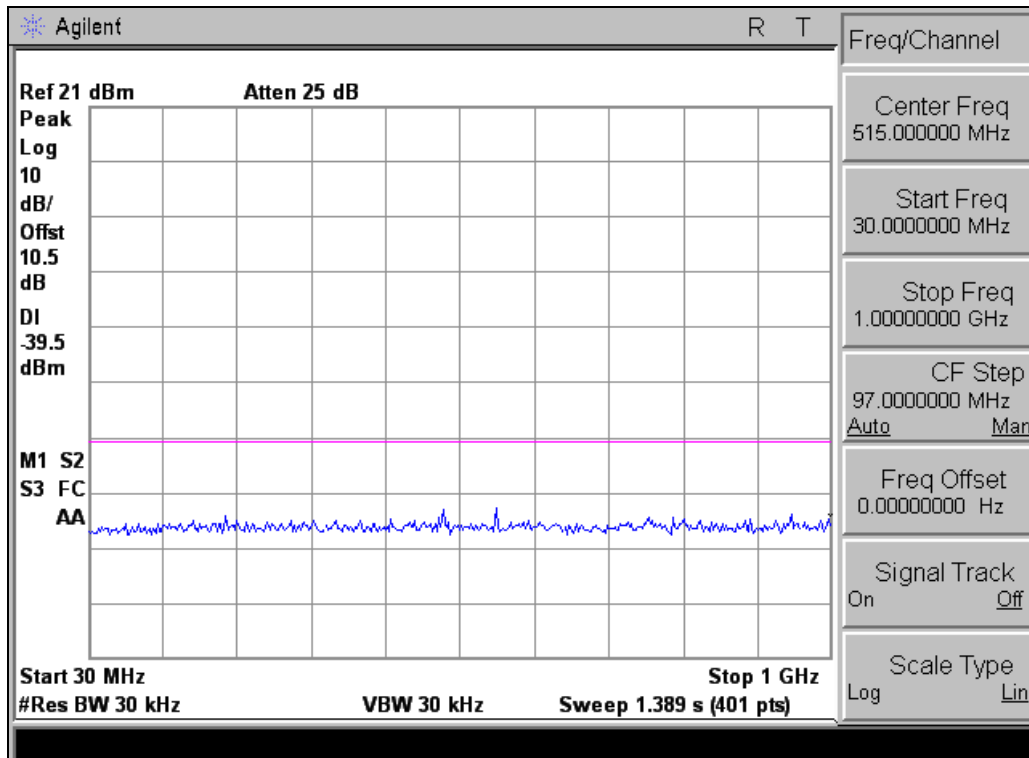

- Out-of-band emission of ch5 -

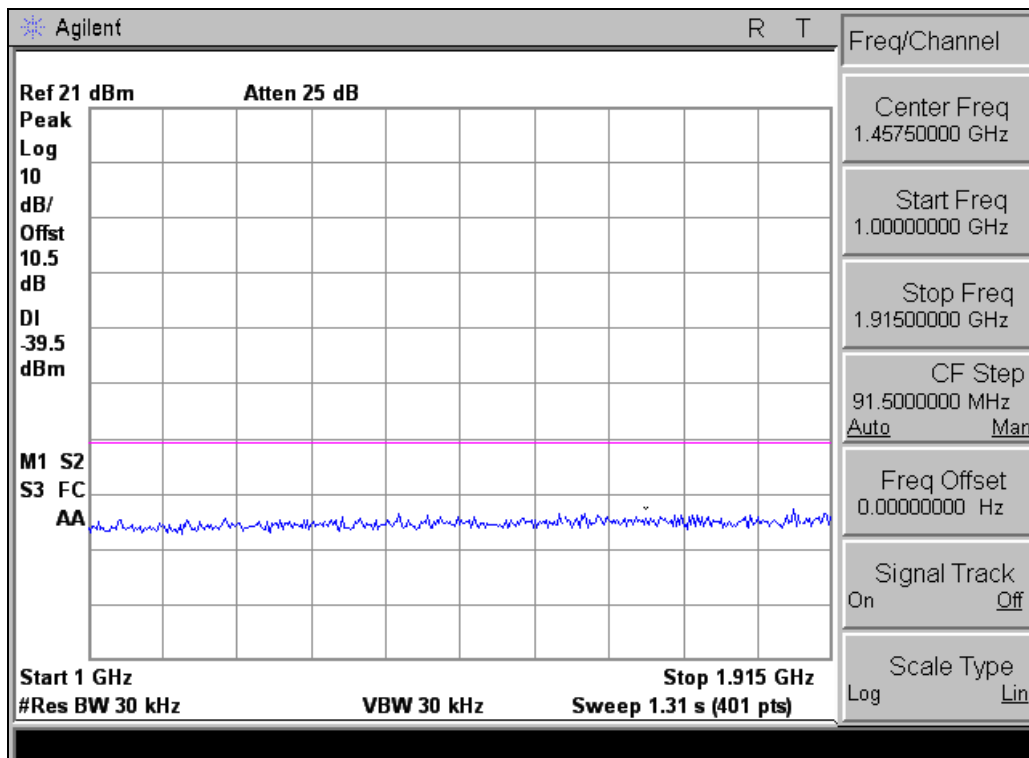

- Out-of-band emission of ch5 -

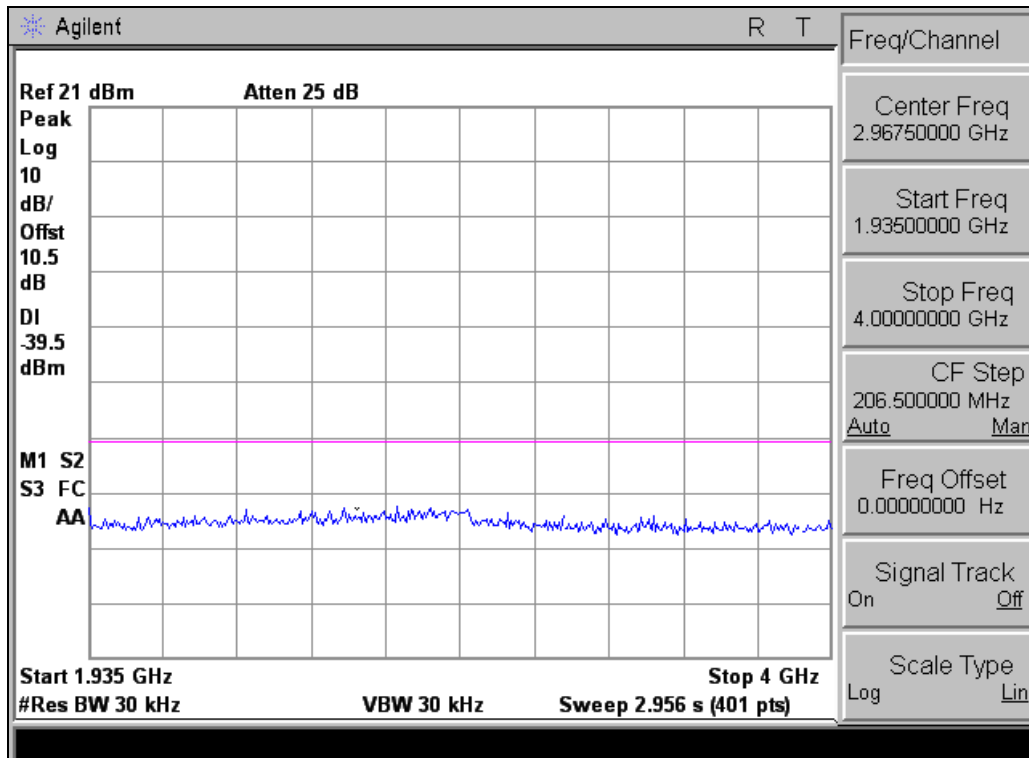

- Out-of-band emission of ch5 -

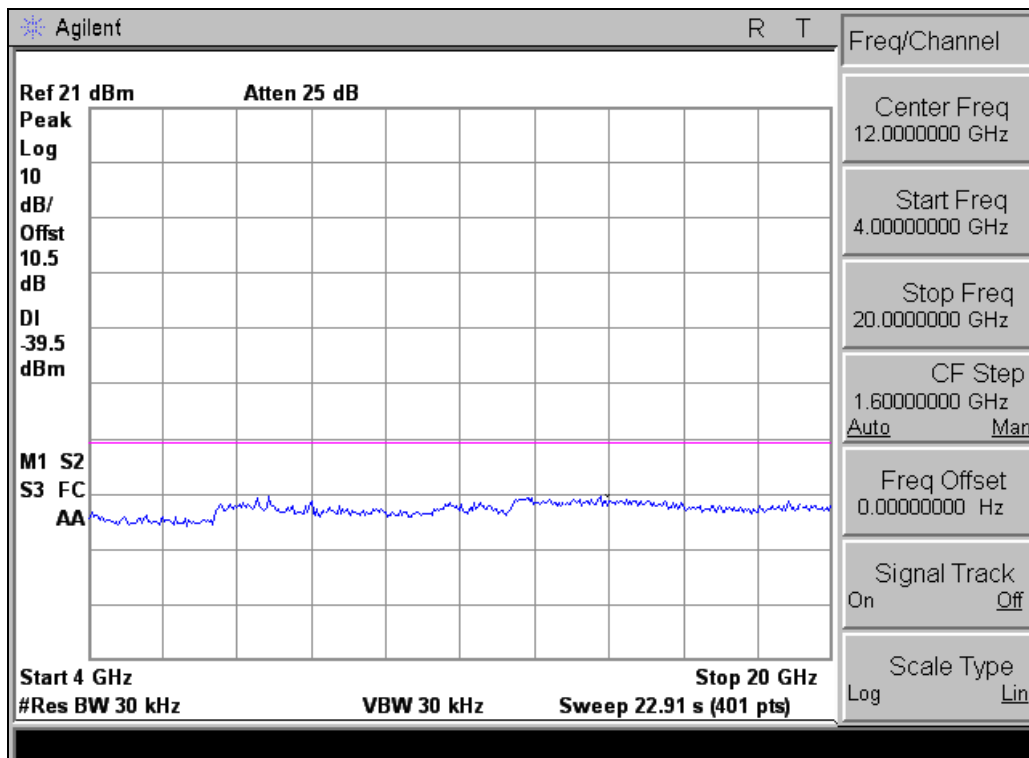

- Out-of-band emission of ch5 -

3.11 Carrier frequency stability

3.11.1 Test limit - FCC 15.323(f)

(f) The frequency stability of the carrier frequency of the intentional radiator shall be maintained within ± 10 ppm over 1 hour or the interval between channel access monitoring, whichever is shorter. The frequency stability shall be maintained over a temperature variation of -20° to $+50^{\circ}$ degrees C at normal supply voltage, and over a variation in the primary supply voltage of 85 percent to 115 percent of the rated supply voltage at a temperature of 20° C. For equipment that is capable only of operating from a battery, the frequency stability tests shall be performed using a new battery without any further requirement to vary supply voltage.

3.11.2 Test procedure - ANSI C63.17 sub-clause 6.2.1

3.11.3 Test results

I . Carrier Frequency Stability over time

Supply Voltage	Temperature (°C)	Peak to Peak Diff (kHz)	Max Dev.(ppm)	Limit (ppm)	Verdict
V _{nom}	+23	+2.00	+1.04	± 10	Complies

II . Carrier Frequency Stability over Power Supply Voltage

Supply Voltage	Temperature (°C)	Measured Frequency Offset Over an hour (ppm)	Limit (ppm)	Verdict
85 %	+23	-	± 10	N/A
115%	+23	-	± 10	N/A

*GDC-600BE is connected to IPLDK-60 system via WDIB4. DC 30V is supplied from Key Telephone System.

III. Carrier Frequency Stability over Temperature

Supply Voltage	Temperature (°C)	Measured Frequency Offset Over an hour (ppm)	Limit (ppm)	Verdict
Nominal	-20	+4.46	± 10	Complies
Nominal	+50	+2.80	± 10	Complies

3.12 Frame repetition stability

3.12.1 Test limit - FCC 15.323(e)

(e) The frame period (a set of consecutive time slots in which the position of each time slot can be identified by reference to a synchronizing source) of an intentional radiator operating in these subbands shall be 20 milliseconds/X where X is a positive whole number. Each device that implements time division for the purposes of maintaining a duplex connection on a given frequency carrier shall maintain a frame repetition rate with a frequency stability of at least 50 parts per millions (ppm). Each device which further divides access in time in order to support multiple communication links on a given frequency carrier shall maintain a frame repetition rate with a frequency stability of at least 10 ppm. The jitter (time-related, abrupt, spurious variations in the duration of the frame interval) introduced at the two ends of such a communication link shall not exceed 25 microseconds for any two consecutive transmissions. Transmissions shall be continuous in every time and spectrum window during the frame period defined for the device.

Limit :

Frame Repetition Stability (ppm)	±10 ppm (TDMA)
----------------------------------	----------------

3.12.2 Test procedure - ANSI C63.17 sub-clause 6.2.2.

3.12.3 Test results

Maximum Frame Repetition Stability (ppm)	Limit (ppm)	Verdict
+2.36	10	Complies

3.13 Frame Period and Jitter

3.13.1 Test limit - FCC 15.323(e)

(e) The frame period (a set of consecutive time slots in which the position of each time slot can be identified by reference to a synchronizing source) of an intentional radiator operating in these subbands shall be 20 milliseconds/X where X is a positive whole number. Each device that implements time division for the purposes of maintaining a duplex connection on a given frequency carrier shall maintain a frame repetition rate with a frequency stability of at least 50 parts per millions (ppm). Each device which further divides access in time in order to support multiple communication links on a given frequency carrier shall maintain a frame repetition rate with a frequency stability of at least 10 ppm. The jitter (time-related, abrupt, spurious variations in the duration of the frame interval) introduced at the two ends of such a communication link shall not exceed 25 microseconds for any two consecutive transmissions. Transmissions shall be continuous in every time and spectrum window during the frame period defined for the device.

3.13.2 Test procedure - ANSI C63.17 sub-clause 6.2.3.

3.13.3 Test results

Measured Maximum Jitter (μ s)	Lmiit (μ s)	Verdict
+0.06	25	Complies

3.14 Monitoring time

3.14.1 Test limit - FCC 15.323(c)

- (c) Devices must incorporate a mechanism for monitoring the time and spectrum windows that its transmission is intended to occupy. The following criteria must be met:
- (1) Immediately prior to initiating transmission, devices must monitor the combined time and spectrum windows in which they intend to transmit for a period of at least 10 milliseconds for systems designed to use a 10 millisecond or shorter frame period or at least 20 milliseconds for systems designed to use a 20 millisecond frame period.

3.14.2 Test procedure - ANSI C63.17 sub-clause 7.3.4.

3.14.3 Test results

Measured monitoring time (ms)	Lmiit (ms)	Verdict
390	greater than 10 ms	Complies

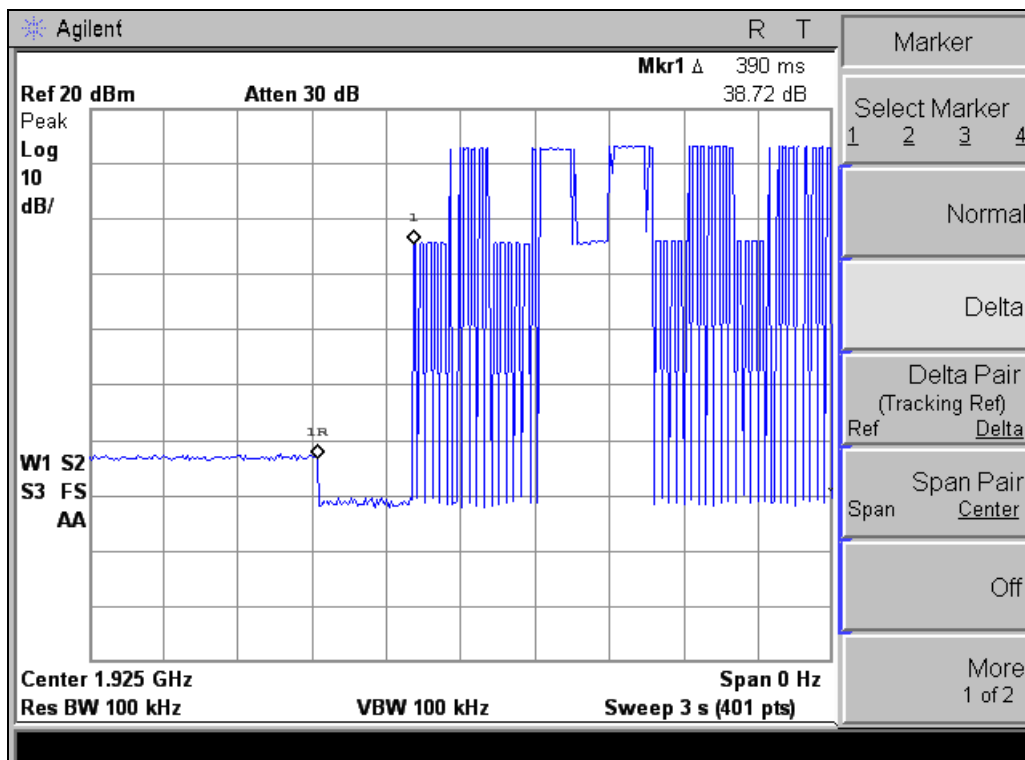

– Monitoring time –

3.15 Monitoring threshold

3.15.1 Test limit - FCC 15.323(c)(2)(9)

- (c) Devices must incorporate a mechanism for monitoring the time and spectrum windows that its transmission is intended to occupy. The following criteria must be met:
 - (2) The monitoring threshold must not be more than 30 dB above the thermal noise power for a bandwidth equivalent to the emission bandwidth of the device.
 - (9) Devices that have a power output lower than the maximum permitted under the rules may increase their monitoring detection threshold by one decibel for each one decibel that the transmitter power is below the maximum permitted.

3.15.2 Test procedure - ANSI C63.17 sub-clause 7.3.1.

Calculation of Monitoring Threshold Limit:

Lower monitoring threshold : $T_L \leq (-174 + 10\log B + M_L + P_{MAX} - P_{EUT})$ dBm

Upper monitoring threshold : $T_U \leq (-174 + 10\log B + M_U + P_{MAX} - P_{EUT})$ dBm

Where, B = Measured Emission Bandwidth : 1.483×10^6 Hz

M = 30 dB for Lower Monitoring Threshold / 50 dB for Upper Monitoring Threshold

$P_{MAX} = 5\log_{10} B - 10$ dBm = 20.86 dBm

P_{EUT} = Measured Peak Transmit Power : 20.59 dBm

Calculated lower Monitoring Threshold (dBm)	-82.01
Calculated upper Monitoring Threshold (dBm)	-62.01

3.15.3 Test results

The Upper Threshold is applicable for systems with more than 40 duplex system access channels and that implements the Least Interfered Channel Procedure (LIC).

Lower Monitoring Threshold (dBm)	--	N/A
Upper Monitoring Threshold (dBm)	-76.10	Pass

3.16 Maximum transmit time

3.16.1 Test limit - FCC 15.323(c)(3)

- (c) Devices must incorporate a mechanism for monitoring the time and spectrum windows that its transmission is intended to occupy. The following criteria must be met:
- (3) If no signal above the threshold level is detected, transmission may commence and continue with the same emission bandwidth in the monitored time and spectrum windows without further monitoring. However, occupation of the same combined time and spectrum windows by a device or group of cooperating devices continuously over a period of time longer than 8 hours is not permitted without repeating the access criteria.

3.16.2 Test procedure - ANSI C63.17 sub-clause 8.2.2.

3.16.3 Test results

Measured Maximum Transmission duration (sec)	Limit (sec)	Verdict
1,117	28,800	Complies

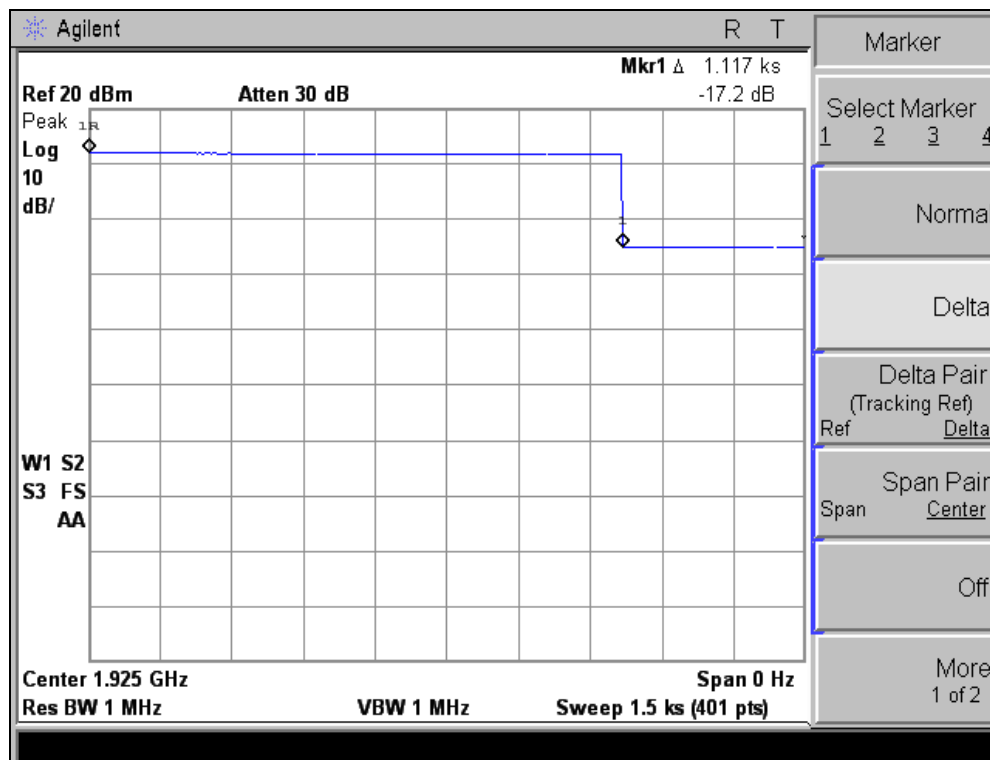

– Maximum transmit time –

3.17 System acknowledgement

3.17.1 Test limit - FCC 15.323(c)(4)

- (c) Devices must incorporate a mechanism for monitoring the time and spectrum windows that its transmission is intended to occupy. The following criteria must be met:
- (4) Once access to specific combined time and spectrum windows is obtained an acknowledgement from a system participant must be received by the initiating transmitter within one second or transmission must cease. Periodic acknowledgements must be received at least every 30 seconds or transmission must cease. Channels used exclusively for control and signalling information may transmit continuously for 30 seconds without receiving an acknowledgement, at which time the access criteria must be repeated.

3.17.2 Test procedure - ANSI C63.17 sub-clause 8.1.1 & 8.2.1

3.17.3 Test results

Test	Result (s)	Limit (s)	Verdict
Initial transmission without acknowledgements	N/A	N/A	Only for initiating device
Transmission time after loss of acknowledgements	2.7	30	Complies

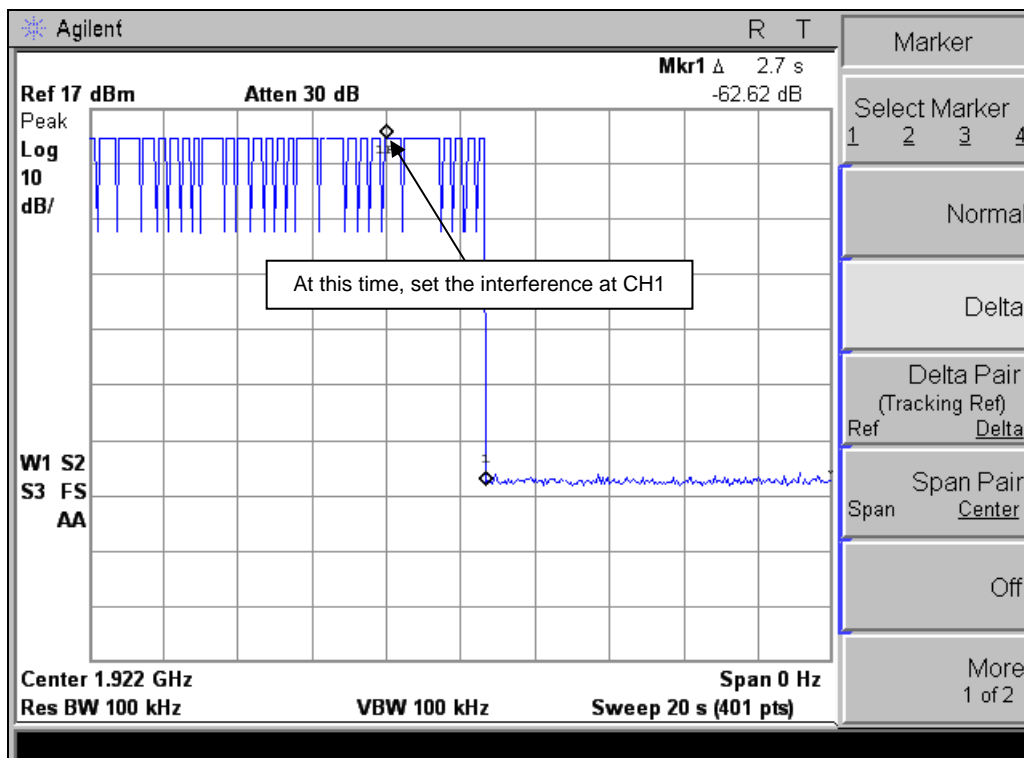

– Transmission time after loss of acknowledgements –

3.18 Least Interfered Channel & Channel confirmation

3.18.1 Test limit - FCC 15.323(c)(5)

- (c) Devices must incorporate a mechanism for monitoring the time and spectrum windows that its transmission is intended to occupy. The following criteria must be met:
- (5) If access to spectrum is not available as determined by the above, and a minimum of 40 duplex system access channels are defined for the system, the time and spectrum windows with the lowest power level below a monitoring threshold of 50 dB above the thermal noise power determined for the emission bandwidth may be accessed.

3.18.2 Test procedure - ANSI C63.17 sub-clause 7.3.3

Calculated Lower monitoring threshold : -82.01 dBm
Calculated Upper monitoring threshold : -62.01 dBm

The upper threshold is applicable for systems with more than 40 duplex system access channels and that implements the Least Interfered Channel Procedure (LIC).

3.18.3 Test results

Test	Results	Verdict
Apply interference on CH1 at level T_L+U_m+7 dB Apply interference on CH5 at level T_L+U_m dB	Transmission always on CH5	Complies
Apply interference on CH1 at level T_L+U_m dB Apply interference on CH5 at level T_L+U_m+7 dB	Transmission always on CH1	Complies
Apply interference on CH1 at level T_L+U_m+1 dB Apply interference on CH5 at level T_L+U_m-6 dB	Transmission always on CH5	Complies
Apply interference on CH1 at level T_L+U_m-6 dB Apply interference on CH5 at level T_L+U_m+1 dB	Transmission always on CH1	Complies

3.19 Random waiting

3.19.1 Test limit - FCC 15.323(c)(6)

- (c) Devices must incorporate a mechanism for monitoring the time and spectrum windows that its transmission is intended to occupy. The following criteria must be met:
- (6) If the selected combined time and spectrum windows are unavailable, the device may either monitor and select different windows or seek to use the same windows after waiting an amount of time, randomly chosen from a uniform random distribution between 10 and 150 milliseconds, commencing when the channel becomes available.

3.19.2 Test procedure - ANSI C63.17 sub-clause 8.1.3

3.19.3 Attestation

The option 15.323(c)(6) is not implemented by this product.

3.20 Monitoring Bandwidth

3.20.1 Test limit - FCC 15.323(c)(7)

- (c) Devices must incorporate a mechanism for monitoring the time and spectrum windows that its transmission is intended to occupy. The following criteria must be met:
- (7) The monitoring system bandwidth must be equal to or greater than the emission bandwidth of the intended transmission and have a maximum reaction time less than $50 \times \text{SQRT}(1.25/\text{emission bandwidth in MHz})$ microseconds for signals at the applicable threshold level but shall not be required to be less than 50 microseconds.

3.20.2 Test procedure - ANSI C63.17 sub-clause 7.4.2 – more detailed test

3.20.3 Test results

Test frequency	Test level (above T_U+U_M)	Result	Verdict
-6 dB points	-70.10 dBm	No transmission	Complies
-12 dB points	-64.10 dBm	No transmission	Complies

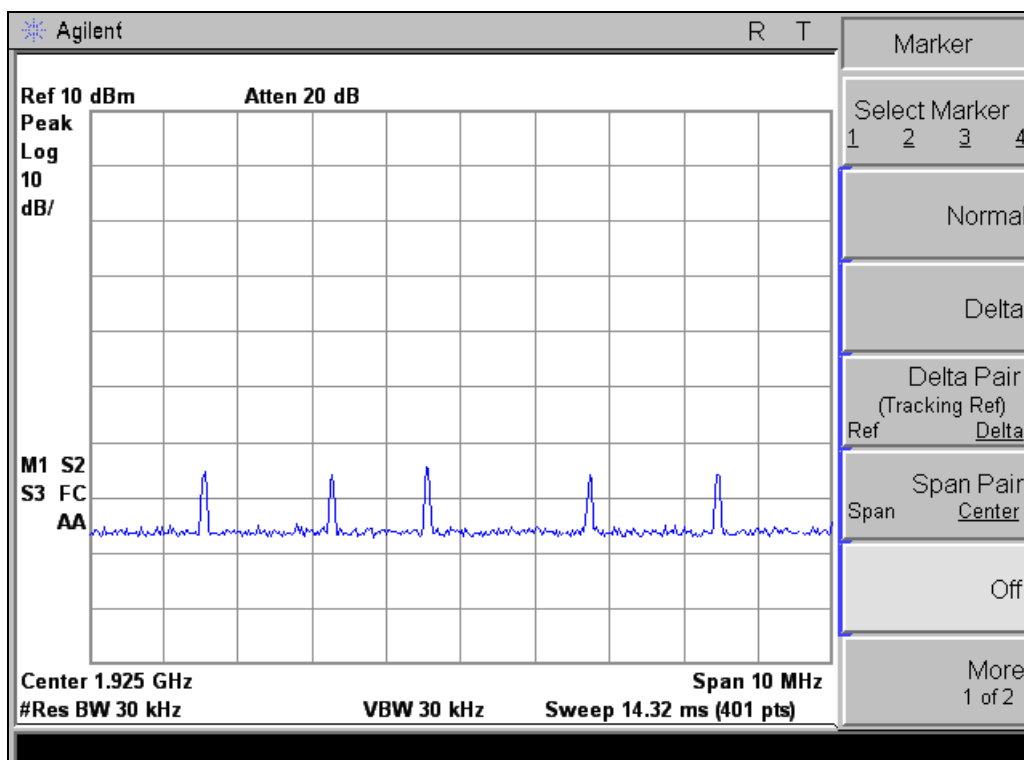

– Interference level on -6 dB lower point –

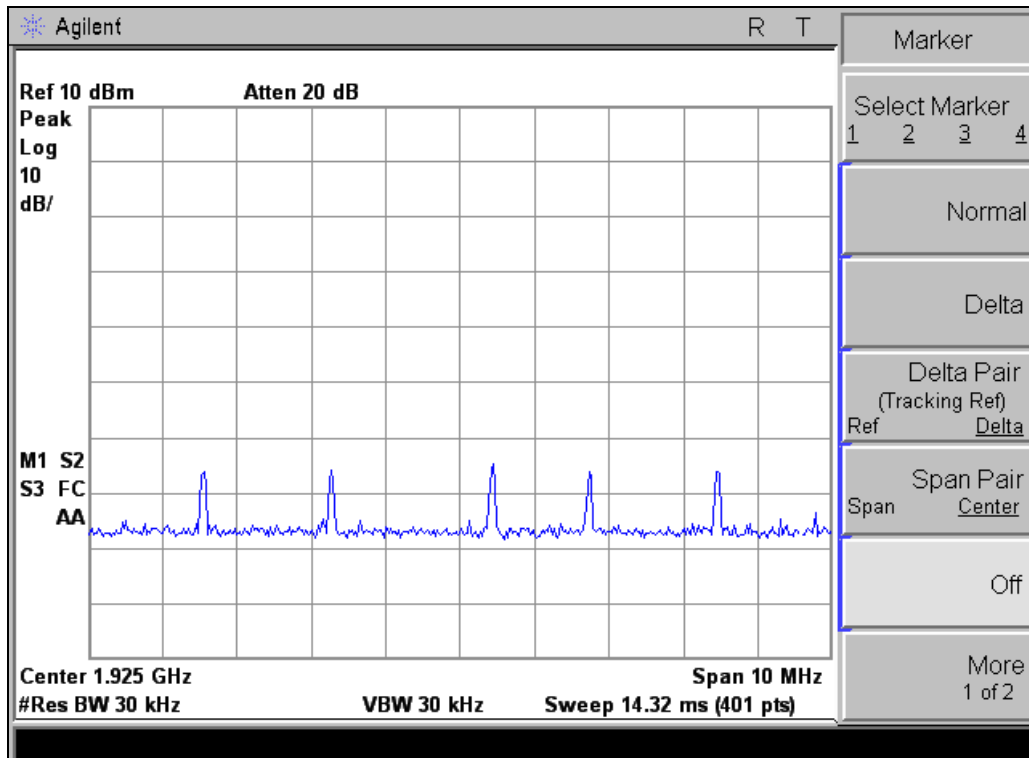

– Interference level on +6 dB higher point –

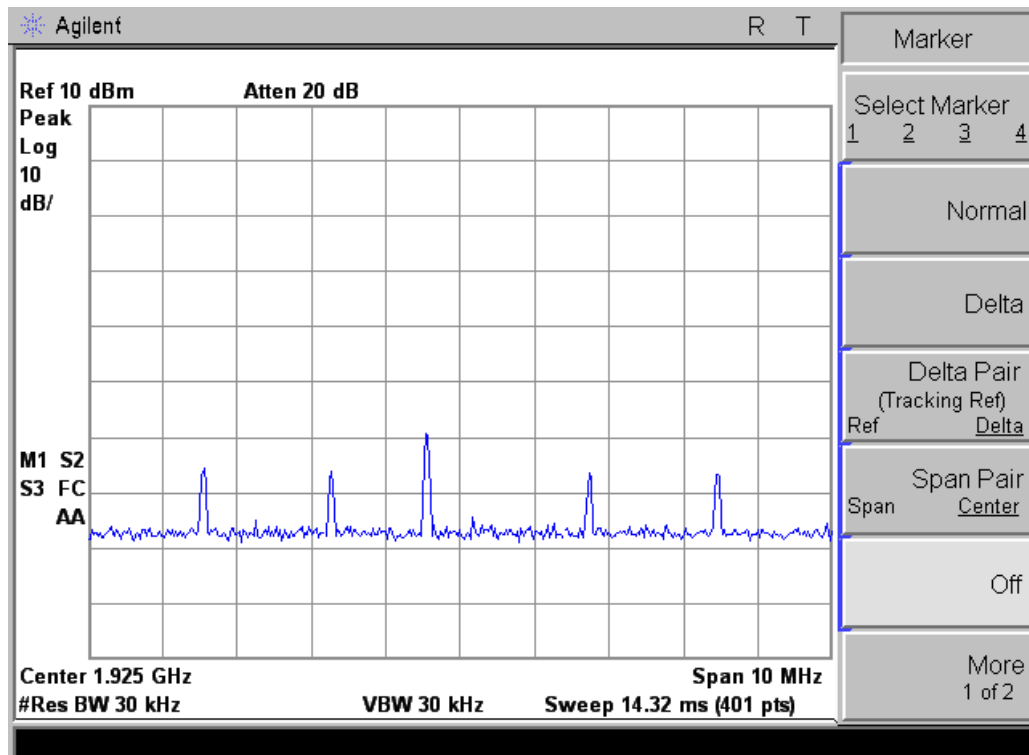

– Interference level on -12 dB lower point –

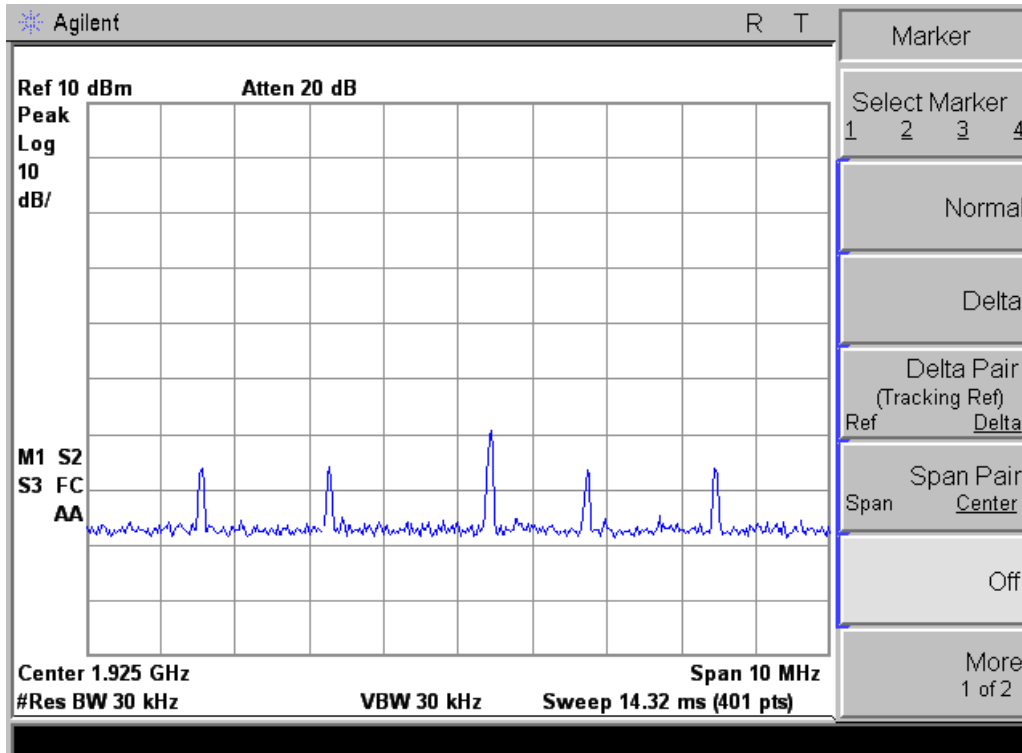

- Interference level on +12 dB higher point -

3.21 Maximum reaction time

3.21.1 Test limit - FCC 15.323(c)(7)

- (c) Devices must incorporate a mechanism for monitoring the time and spectrum windows that its transmission is intended to occupy. The following criteria must be met:
- (7) If a signal is detected that is 6 dB or more above the applicable threshold level, the maximum reaction time shall be $35 \times \text{SQRT}(1.25/\text{emission bandwidth in MHz})$ microseconds but shall not be required to be less than 35 microseconds.

3.21.2 Test procedure - ANSI C63.17 sub-clause 7.5.

3.21.3 Test results

Pulse Width	Results	Verdict
35 us	No transmission	Complies
50 us	No transmission	Complies

* Since Emission bandwidth is greater than 1.25 MHz the test was performed with pulse lengths 35 & 50 us.

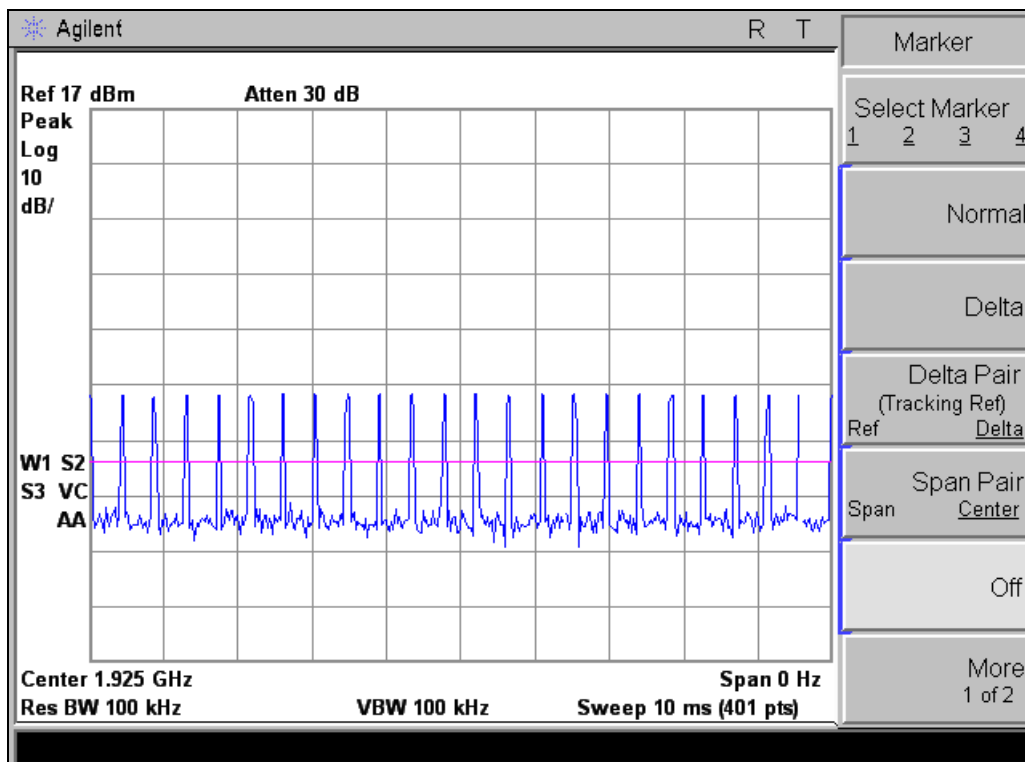

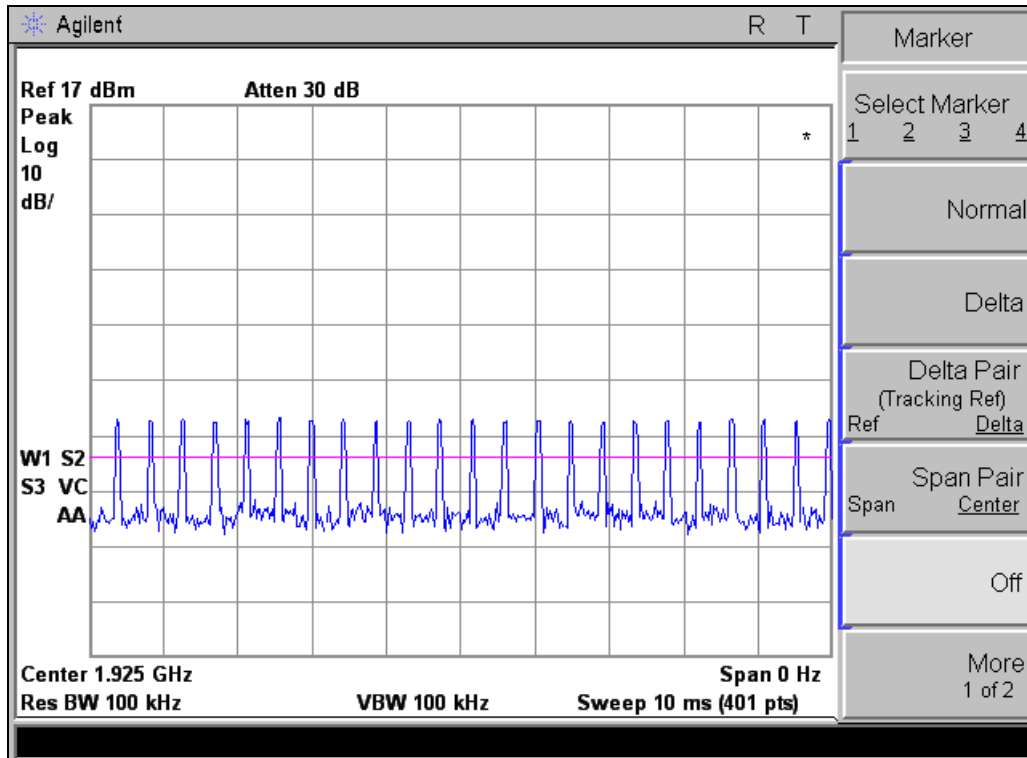

– 50 μ s pulses –

3.22 Monitoring antenna

3.22.1 Test limit - FCC 15.323(c)(8)

- (c) Devices must incorporate a mechanism for monitoring the time and spectrum windows that its transmission is intended to occupy. The following criteria must be met:
- (8) The monitoring system shall use the same antenna used for transmission, or an antenna that yields equivalent reception at that location.

3.22.2 Test procedure - ANSI C63.17 sub-clause 4

3.22.3 Attestation

EUT uses the same antenna used for transmission and monitoring that is in compliance meet above provision.

3.23 Duplex Connections

3.23.1 Test limit - FCC 15.323(c)(10)

- (c) Devices must incorporate a mechanism for monitoring the time and spectrum windows that its transmission is intended to occupy. The following criteria must be met:
- (10) An initiating device may attempt to establish a duplex connection by monitoring both its intended transmit and receive time and spectrum windows. If both the intended transmit and receive time and spectrum windows meet the access criteria, then the initiating device can initiate a transmission in the intended transmit time and spectrum window. If the power detected by the responding device can be decoded as a duplex connection signal from the initiating device, then the responding device may immediately begin transmitting on the receive time and spectrum window monitored by the initiating device.

3.23.2 Test procedure - ANSI C63.17 sub-clause 8.3.2

3.23.3 Attestation

The EUT never initiates a communication link.

3.24 Alternative Monitoring Interval for Co-located Device

3.24.1 Test limit - FCC 15.323(c)(11)

- (c) Devices must incorporate a mechanism for monitoring the time and spectrum windows that its transmission is intended to occupy. The following criteria must be met:
- (11) An initiating device that is prevented from monitoring during its intended transmit window due to monitoring system blocking from the transmissions of a co-located (within one meter) transmitter of the same system, may monitor the portions of the time and spectrum windows in which they intend to receive over a period of at least 10 milliseconds. The monitored time and spectrum window must total at least 50 percent of the 10 millisecond frame interval and the monitored spectrum must be within 1.25 MHz of the center frequency of channel(s) already occupied by that device or collocated co-operating devices. If the access criteria is met for the intended receive time and spectrum window under the above conditions, then transmission in the intended transmit window by the initiating device may commence.

3.24.2 Test procedure - ANSI C63.17 sub-clause 8.4.

3.24.3 Attestation

The EUT never initiates a communication link.

4. Self Declaration

Applicant Name	LG-Ericsson Co.,Ltd.		
Address	533, Hogye-1dong, Dongan-gu, Anyang-si, Gyeonggi-do, 431-749, Korea		
Contact person	James Kang		
E-mail address	korjunma@lgericsson.com		
Phone No.	+82 31 450 4803	Fax No. :	+82 31 450 4745
Manufacture Name	LN Srithai Comm Co.,Ltd.		
Address	71/12 Moo 5 Bangna Trad Rd. KM 52 ThakarmBanpakong Chachoengsao 24130, Thailand		

Model name	LWS-BS	
FCC ID	TUILWS-BS	
		Remarks
Does a system built with the EUT that implement the provisions Of 47CFR 15.323(C)(5) enabling the use of the upper threshold For deferral?	<input checked="" type="checkbox"/> Yes <input type="checkbox"/> No	
According to 47CFR 15.323(C)(5).4, does your model not use Bandwidth in further cooperation with other devices at any Range?	<input checked="" type="checkbox"/> Yes <input type="checkbox"/> No	
Does a system built using the EUT that operate under the Provisions of 47CFR 15.323(c)(6) incorporating provisions for Waiting for a channel to go clear?	<input type="checkbox"/> Yes <input checked="" type="checkbox"/> No	
According to 47CFR15.323(C)(8), does EUT use the same Antennas for transmission and reception as for monitoring?	<input checked="" type="checkbox"/> Yes <input type="checkbox"/> No	
Does a system built with the EUT that operate under the Provisions of 47CFR 15.323(C)(10) to test for deferral only in Conjunction with a companion device?	<input type="checkbox"/> Yes <input checked="" type="checkbox"/> No	
Does a system built with the EUT that operate under the Provisions of 47CFR 15.323(C)(11) enabling the access criteria Check on the receive channel while in the presence of Collocated interferers?	<input type="checkbox"/> Yes <input checked="" type="checkbox"/> No	
According to 47CFR15.323(C)(12), does EUT not work in a Mode with denies fair access to spectrum for other devices.	<input checked="" type="checkbox"/> Yes <input type="checkbox"/> No	

Signed by : Kang Sang Jin (James Kang)
Date: September 14, 2011

signature:

James KANG.

5. TEST SET UP

5.1 Frequency & Timing Measurement

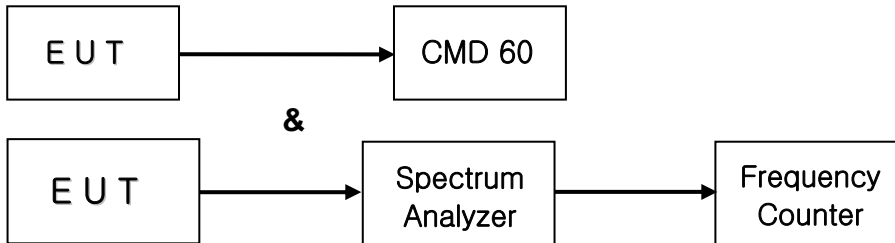

5.2 Monitoring Tests

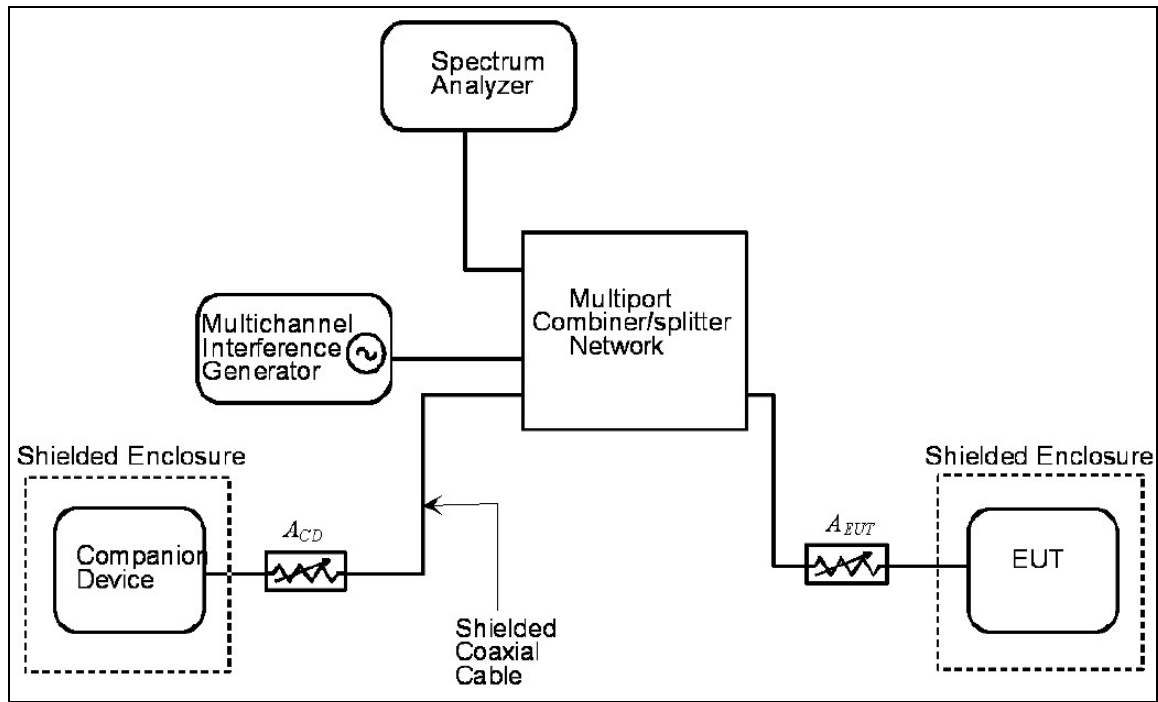

6. TEST EQUIPMENT

No.	Equipment	Manufacturer	Model	S/N
1	Spectrum Analyzer	Agilent	E4407B	US41443316
2	Synthesized Sweeper	HP	83620A	3250A01653
3	Digital RF Signal Generator	Agilent	E4438C	US41460859
4	Signal Generator	R&S	SMIQ O3	DE22348
5	Spectrum Analyzer	Agilent	E4407B	US41443316
6	PSA Series Spectrum Analyzer	Agilent	E4448A	US44300484
7	DC Power Supply	Agilent	E4356A	MY41000296
8	DC Power Supply	Agilent	E3645A	MY40000851
9	Oscilloscope	Tektronix	TDS3052B	B010173
10	Directional Coupler	Agilent	87300C	MY44300126
11	Directional Coupler	Agilent	773D	MY28390213
12	VHF Attenuator	HP	355D	2522A45959
13	Coaxial Attenuator	TenuLine	8340-200	1087
14	Coaxial Attenuator	TenuLine	8080	7676
15	Power Divider	HP	11636A	6047
16	Power Splitter	HP	11667A	21063
17	Frequency Counter	Anritsu	MF2412B	2108A07645
18	Synthesizer/Level Generator	HP	3336C	2903A02111
19	Temp/Humidity Chamber	Korea Power Machine	HI-5050	HI200420

No.	Equipment	Manufacturer	Model	S/N
20	Function/Arbitrary Waveform Generator	Agilent	33250A	MY40015646
21	EMI Receiver	R&S	ESCS30	100206
22	EMI Receiver	R&S	ESPI	100043
23	Pre-Amplifier	HP	8347A	2834A00543
24	Pre-Amplifier	HP	8449B	3008A00302
25	Log-Periodic Antenna	ETS-Lindgren	3148	5051
26	Tuned Dipole Antenna	Schwarzbeck	VHA 9103	--
27	Biconi-Log Antenna	ETS-Lindgren	3142B	00023784
28	Double Ridge Wave Guide	ETS-Lindgren	3115	6913