



TEST REPORT

Test Report No. : UL-RPT-RP10012646JD07C V2.0

Manufacturer : Bang & Olufsen
Model No. : AW-AU397
FCC ID : TTUAW-AU397
IC Certification No. : 3775B-AWAU397
Technology : WLAN
Test Standard(s) : FCC Part 15.407(h)(2) &
Industry Canada RSS-210 A9.3

1. This test report shall not be reproduced in full or partial, without the written approval of UL VS LTD.
2. The results in this report apply only to the sample(s) tested.
3. The sample tested is in compliance with the above standard(s).
4. The test results in this report are traceable to the national or international standards.
5. Version 2.0 supersedes all previous versions.

Date of Issue: 09 February 2015

Checked by:

Ian Watch
Senior Engineer, Radio Laboratory

Issued by :

pp

John Newell
Quality Manager,
UL VS LTD



This laboratory is accredited by UKAS.
The tests reported herein have been
performed in accordance with its terms
of accreditation.

UL VS LTD

Pavilion A, Ashwood Park, Ashwood Way, Basingstoke, Hampshire, RG23 8BG, UK
Telephone: +44 (0)1256 312000
Facsimile: +44 (0)1256 312001

This page has been left intentionally blank.

Table of Contents

1. Customer Information.....	4
2. Summary of Testing.....	5
2.1. General Information	5
Licence-exempt Radio Apparatus (All Frequency Bands): Category I Equipment	5
2.2. Summary of Test Results	5
2.3. Methods and Procedures	5
2.4. Deviations from the Test Specification	5
3. Equipment Under Test (EUT)	6
3.1. Identification of Equipment Under Test (EUT)	6
3.2. Description of EUT	6
3.3. Modifications Incorporated in the EUT	6
3.4. Additional Information Related to Testing	6
3.5. Support Equipment	7
4. Operation and Monitoring of the EUT during Testing	8
4.1. Operating Modes	8
4.2. Configuration and Peripherals	8
5. Measurements, Examinations and Derived Results	12
5.1. General Comments	12
5.2. Test Results	13
5.2.1. Channel Closing Transmission Time and Channel Move Time	13
5.2.2. Non-Occupancy Period	17
6. Measurement Uncertainty	19
7. Report Revision History	20
Appendix 1. Test Setup photos.....	21
Appendix 2. Radar Calibration	22
Appendix 3. Aeroflex Test Platform Approval email.....	24
Appendix 4. System Noise Floor Reference Plots	25

1. Customer Information





Company Name:	Bang & Olufsen a/s
Address:	Peter Bangs Vej 15 7600 Struer Denmark

2. Summary of Testing

2.1. General Information

Specification Reference:	FCC 47CFR15.407
Specification Title:	Code of Federal Regulations Volume 47 (Telecommunications): Part 15 Subpart E (Unlicensed National Information Infrastructure Devices) - Section 15.407
Specification Reference:	Industry Canada RSS-210
Specification Title:	Licence-exempt Radio Apparatus (All Frequency Bands): Category I Equipment
Site Registration:	FCC: 209735; Industry Canada: 3245B-2
Location of Testing:	UL VS LTD, Unit 3 Horizon, Wade Road, Kingsland Business Park, Basingstoke, Hampshire, RG24 8AH, United Kingdom
Test Date:	24 April 2014

2.2. Summary of Test Results

FCC Reference (47CFR)	Industry Canada Reference	Measurement	Result
Part 15.407(h)(2)(iii)	RSS-210 A9.3(b)	Channel Closing Transmission Time and Channel Move Time	
Part 15.407(h)(2)(iv)	RSS-210 A9.3(b)	Non-occupancy Period	
Key to Results			
 = Complied  = Did not comply			

Note(s):

1. The Manufacturer confirms that information regarding the parameters of the radar waveforms is not available to the end user.
2. Clause 8.3(18) of FCC 06-96 states tests are to be performed on the narrowest channel bandwidth (worst case). All tests were therefore performed at the 20 MHz bandwidth.

2.3. Methods and Procedures

Reference:	FCC 06-96
Title:	Compliance Measurement Procedures for Unlicensed-National Information Infrastructure Devices Operating in the 5250-5350 MHz and 5470-5725 MHz Bands Incorporating Dynamic Frequency Selection

2.4. Deviations from the Test Specification

For the measurements contained within this test report, there were no deviations from, additions to, or exclusions from the test specification identified above.

3. Equipment Under Test (EUT)

3.1. Identification of Equipment Under Test (EUT)

Brand Name:	Bang & Olufsen
MAC Address:	240A646DE213
Hardware Version:	5-PP001942 1213 V05
Software Version:	USB8797-14.69.11.p179-M3X14348-GPL-(FP69)
FCC ID:	TTUAW-AU397
Industry Canada Certification Number:	3775B-AWAU397

3.2. Description of EUT

The equipment under test (EUT) was an IEEE 802.11 a/b/g/n 2x2 MIMO WLAN and *Bluetooth®* module.

The EUT supports DFS as a Client without Radar Detection.

3.3. Modifications Incorporated in the EUT

No modifications were applied to the EUT during testing.

3.4. Additional Information Related to Testing

Technology Tested:	Unlicensed National Information Infrastructure Devices (U-NII)	
Type of Unit:	Transceiver	
Modulation:	BPSK, QPSK, 16QAM & 64QAM	
Data Rates:	IEEE 802.11a	6, 9, 12, 18, 24, 36, 48 & 54 Mbps
	IEEE 802.11n HT20	MCS0 to MCS15 (2 spatial streams)
	IEEE 802.11n HT40	MCS0 to MCS15 (2 spatial streams)
Power Supply Requirement(s):	Nominal	5.0 VDC via 120 VAC 60 Hz adaptor
Transmit / Receive Frequency Range:	5250 to 5350 MHz & 5470 to 5725 MHz	
Transmit / Receive Channels Tested at 20 MHz Bandwidth setting:	Channel ID	Channel Frequency (MHz)
	104	5520
	108	5540

3.5. Support Equipment

The following support equipment was used to exercise the EUT during testing:

Description:	Cisco Aironet IOS Access Point (DFS Master)
Brand Name:	Cisco
Model Name or Number:	AIR-AP1252AG-A-K9
Serial Number:	FGL1547Z00U
FCC ID:	LDK102061
Industry Canada Certification Number:	2461B-102061

Description:	Laptop Computer
Brand Name:	Dell
Model Name or Number:	Lattitude D610
Serial Number:	GN20Q1J

Description:	Test Laptop
Brand Name:	Lenovo
Model Name or Number:	X61
Serial Number:	7674W81

4. Operation and Monitoring of the EUT during Testing

4.1. Operating Modes

The EUT was tested in the following operating modes, unless otherwise stated:

- Operating on the channel selected by the Master device in either UNII Band 2a or UNII Band 2c.
- The Master device was set to 17 dBm / 50 mW.
- The Master device was set to 802.11n / MCS7.
- The Master device set the channel bandwidth to either 20 MHz or 40 MHz. Only 20 MHz bandwidth testing was performed as this was worst-case as determined in FCC 06-96 clause 8.3(18).
- The DFS detection threshold of -61 dBm was used at the Master device antenna port.

FCC 06-96 Table 3: DFS Detection Thresholds for Master Devices and Client Devices With Radar Detection

Maximum Transmit Power	Value (See Notes 1 and 2)
≥ 200 milliwatt	-64 dBm
< 200 milliwatt	-62 dBm
Note 1: This is the level at the input of the receiver assuming a 0 dBi receive antenna. Note 2: Throughout these test procedures an additional 1 dB has been added to the amplitude of the test transmission waveforms to account for variations in measurement equipment. This will ensure that the test signal is at or above the detection threshold level to trigger a DFS response.	

4.2. Configuration and Peripherals

The EUT was tested in the following configuration(s):

- The EUT is a DFS Client without Radar Detection capability. It was tested in combination with a FCC/IC approved Cisco DFS enabled router being used as the Master. Due to the full compliance of the Master, radar pulse types 1 and 5 were injected to test the Client channel move behaviour.
- All measurements were made using a conducted link. The EUT has one external antenna port fitted for test purposes. System losses for the interconnecting hardware were measured and taken into consideration.
- For the required channel loading, the full motion, 30 frames per second test MPEG video file from <http://ntiacsd.ntia.doc.gov/dfs/> was streamed from an HTTP server on a test laptop, via the DFS Master device, to the EUT (Client). The remote file was located from within the web browser then decoded using VLC video playback software which was installed on the EUT.
- The Radar test platform used was the Aeroflex DFS Radar 110105 Simulator and Analyser which has been verified and accepted by Andrew Leimer of the FCC/NTIA on the 23rd of September 2011. Refer to Appendix 3 of this Test Report for the original confirmation email.
- Plots and data were captured using a Rohde and Schwarz FSV 30 Test Receiver in spectrum analyser mode. The number of data points was increased to maximum and the trace data exported so it could be analysed in more detail than available on the built-in display.
- The Channel Move Time was the time taken from the end of the radar waveform to the time the Client ceased transmissions. The Channel Closing Transmission Time was calculated to the nearest sample from any additional pulses occurring >200 ms after the end of the radar.

Setup diagram for test of DFS Client without Radar Detection.

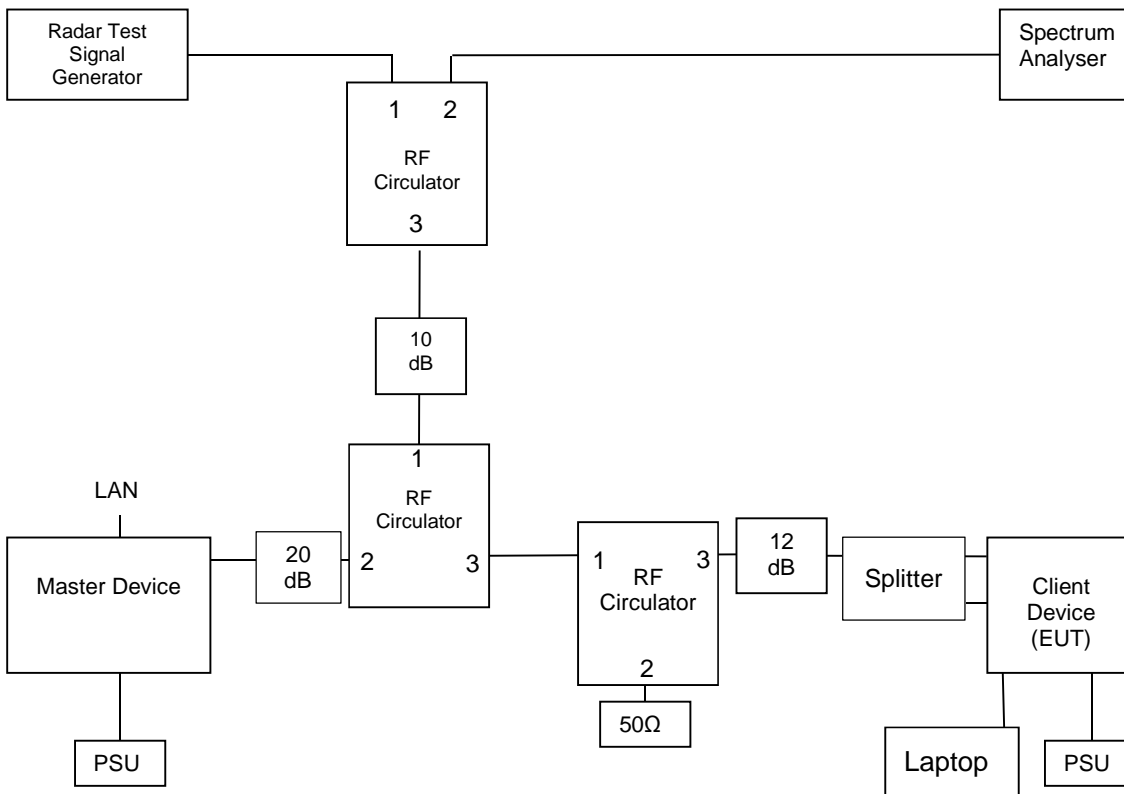

Rationale

The setup shown above ensures the waveforms indicated on the spectrum analyser are in order of magnitude. The circulators have approximately 18 dB attenuation in the reverse direction. The lower left-hand circulator directs the radar towards the master, ensuring there is not an overly large radar pulse into the client (EUT) even though there is less attenuation between the client and the radar generator. The radar signal should be approximately 31 dB smaller at each client antenna port than at the master. The lower right-hand circulator is to give the same path loss between master and client in both directions.

The Radar signal is most predominant on the spectrum analyser, coming straight through a circulator. The client is 2nd largest, being attenuated by the 12 dB, 10 dB and 18 dB from the top circulator. The smallest signal is the master, being attenuated by 30 dB from the two attenuators and approximately 36 dB from the two circulators.

Applicability of DFS requirements prior to use of a channel

Requirement	Operational Mode		
	Master	Client (without radar detection)	Client (with radar detection)
Non-Occupancy Period	Yes	Not required	Yes
DFS Detection Threshold	Yes	Not required	Yes
Channel Availability Check Time	Yes	Not required	Not required
Uniform Spreading	Yes	Not required	Not required

Applicability of DFS requirements during normal operation

Requirement	Operational Mode		
	Master	Client (without DFS)	Client (with DFS)
DFS Detection Threshold	Yes	Not required	Yes
Channel Closing Transmission Time	Yes	Yes	Yes
Channel Move Time	Yes	Yes	Yes

Interference Threshold values, Master or Client incorporating In-Service Monitoring

Maximum Transmit Power	Value (see note)
≥ 200 milliwatt	-64 dBm
< 200 milliwatt	-62 dBm

Note 1: This is the level at the input of the receiver assuming a 0 dBi receive antenna Note 2: Throughout these test procedures an additional 1dB has been added to the amplitude of the test transmission waveforms to account for variations in measurement equipment. This will ensure that the test signal is at or above the detection threshold level to trigger a DFS response.

DFS Response requirement values

Parameter	Value
Non-occupancy period	30 minutes
Channel Availability Check Time	60 seconds
Channel Move Time	10 seconds
Channel Closing Transmission Time	200 milliseconds + approx. 60 milliseconds over remaining 10 second period

The instant that the Channel Move Time and the Channel Closing Transmission Time begins is as follows: For the Short pulse radar Test Signals this instant is the end of the Burst. For the Frequency Hopping radar Test Signal, this instant is the end of the last radar burst generated. For the Long Pulse radar Test Signal this instant is the end of the 12 second period defining the radar transmission. The Channel Closing Transmission Time is comprised of 200 milliseconds starting at the beginning of the Channel Move Time plus any additional intermittent control signals required to facilitate channel changes (an aggregate of approximately 60 milliseconds) during the remainder of the 10 second period. The aggregate duration of control signals will not count quiet periods in between transmissions.

Short Pulse Radar Test Waveforms

Radar Type	Pulse Width (Microseconds)	PRI (Microseconds)	Pulses	Minimum Percentage of Successful Detection	Minimum Trials
1	1	1428	18	60%	30
2	1-5	150-230	23-29	60%	30
3	6-10	200-500	16-18	60%	30
4	11-20	200-500	12-16	60%	30
Aggregate (Radar Types 1-4)			80%	120	

Long Pulse Radar Test Signal

Radar Waveform	Bursts	Pulses per Burst	Pulse Width (µsec)	Chirp Width (MHz)	PRI (µsec)	Minimum Percentage of Successful Detection	Minimum Trials
5	8-20	1-3	50-100	5-20	1000-2000	80%	30

Frequency Hopping Radar Test Signal

Radar Waveform	Pulse Width (µsec)	PRI (µsec)	Burst Length (ms)	Pulses per Hop	Hopping Rate (kHz)	Minimum Percentage of Successful Detection	Minimum Trials
6	1	333	300	9	.333	70%	30

5. Measurements, Examinations and Derived Results

5.1. General Comments

Measurement uncertainties are evaluated in accordance with current best practice. Our reported expanded uncertainties are based on standard uncertainties, which are multiplied by an appropriate coverage factor to provide a statistical confidence level of approximately 95%. Please refer to *Section 6 Measurement Uncertainty* for details.

In accordance with UKAS requirements all the measurement equipment is on a calibration schedule. All equipment was within the calibration period on the date of testing.

5.2. Test Results

5.2.1. Channel Closing Transmission Time and Channel Move Time

Test Summary:

Test Engineer:	Philip Harrison	Test Date:	24 April 2014
Test Sample MAC Address:	240A646DE213		

FCC Reference:	Part 15.407(h)(2)(iii)
Industry Canada Reference:	RSS-210 A9.3(b)(iii) & A9.3(b)(iv)
Test Method Used:	FCC 06-96 Section 7.8.3

Environmental Conditions:

Temperature (°C):	23
Relative Humidity (%):	46

Note(s):

1. The channel move time is the time taken from the end of the radar burst to the ceasing of transmissions of the EUT.
2. The Total Aggregate Channel Closing Transmission Time shown in the table below was measured from 200 ms after the end of the radar burst and compared to the 60 ms limit.
3. The smaller transmissions seen in the plot that are less than -48 dBm, come from the Master device and not from the Client, these transmissions can be ignored for the below results.

Results: 20 MHz / 5250 – 5350 MHz band

Radar #	Channel Frequency (MHz)	Channel Move Time (ms)	Total Aggregate Channel Closing Time after first 200 ms (ms)	Limit (ms)	Margin (ms)	Status
1	5520	69.75	-	10000	9930.25	Complied
1	5520	-	0	60	60	Complied

Radar burst type 1 was detected and channel move occurred.

Channel Closing Transmission Time and Channel Move Time (continued)

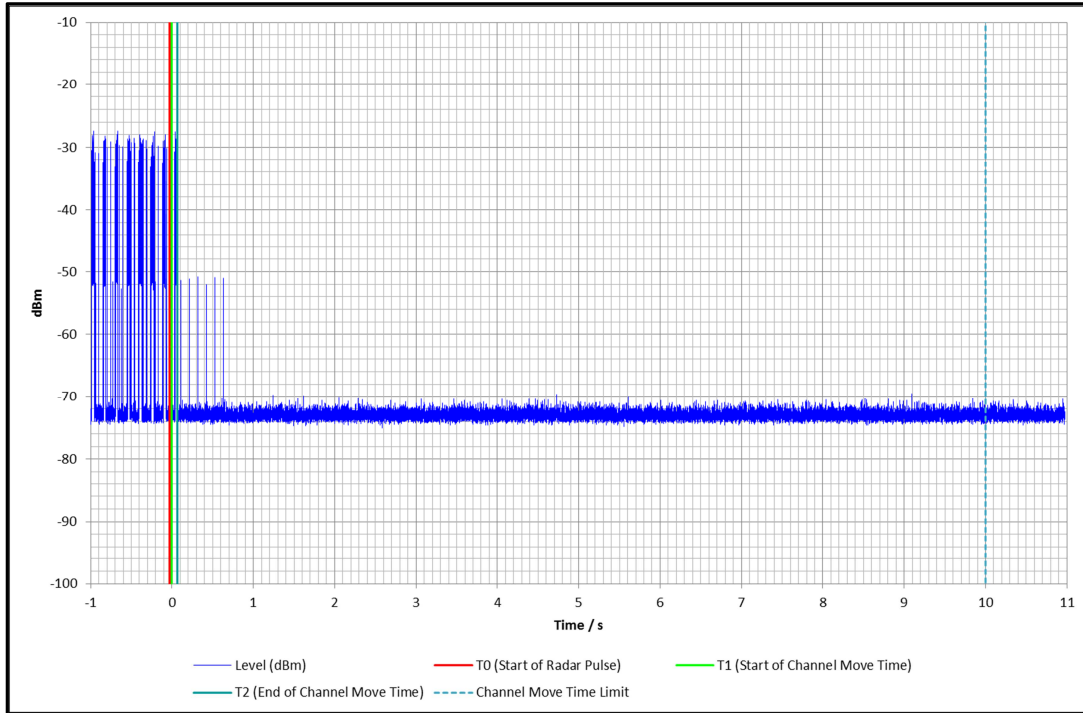

Channel Move Time 5520 MHz – Short Radar (Type 1) - Full 10 seconds

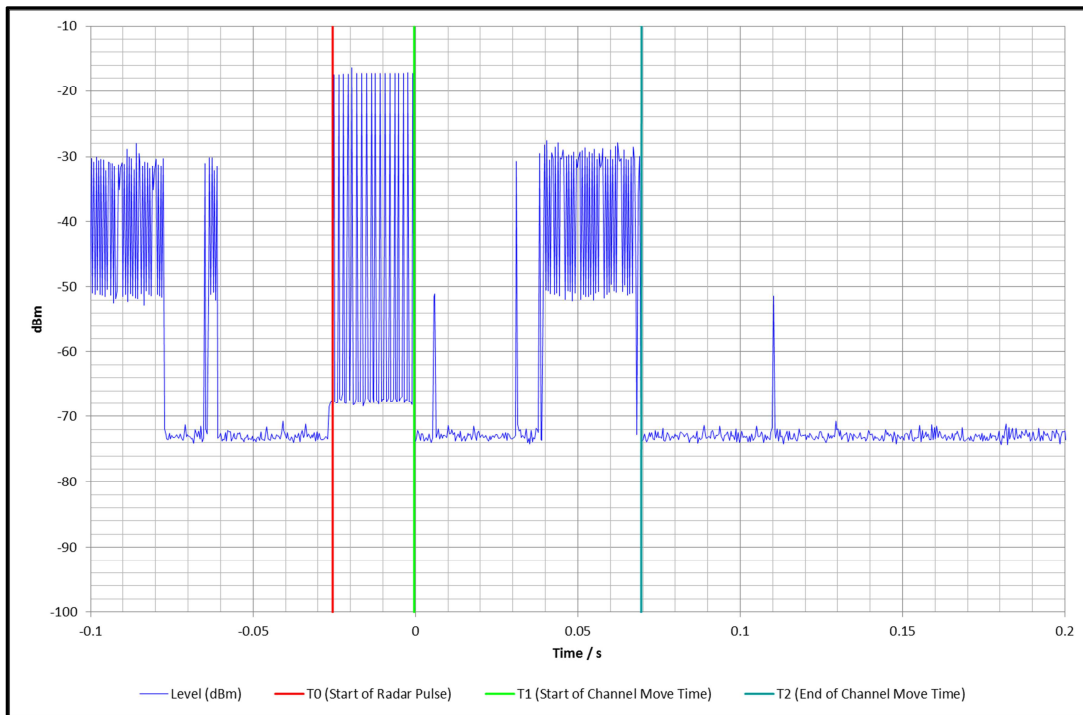

Channel Move Time 5520 MHz – Short Radar (Type 1) – First 200 ms

Channel Closing Transmission Time and Channel Move Time (continued)

Channel Move Time and Channel Closing Transmission Time are not calculated from the long radar type. The type 5 shutdown plot is included for reporting purposes only. Radar burst type 5 was detected and channel move occurred.

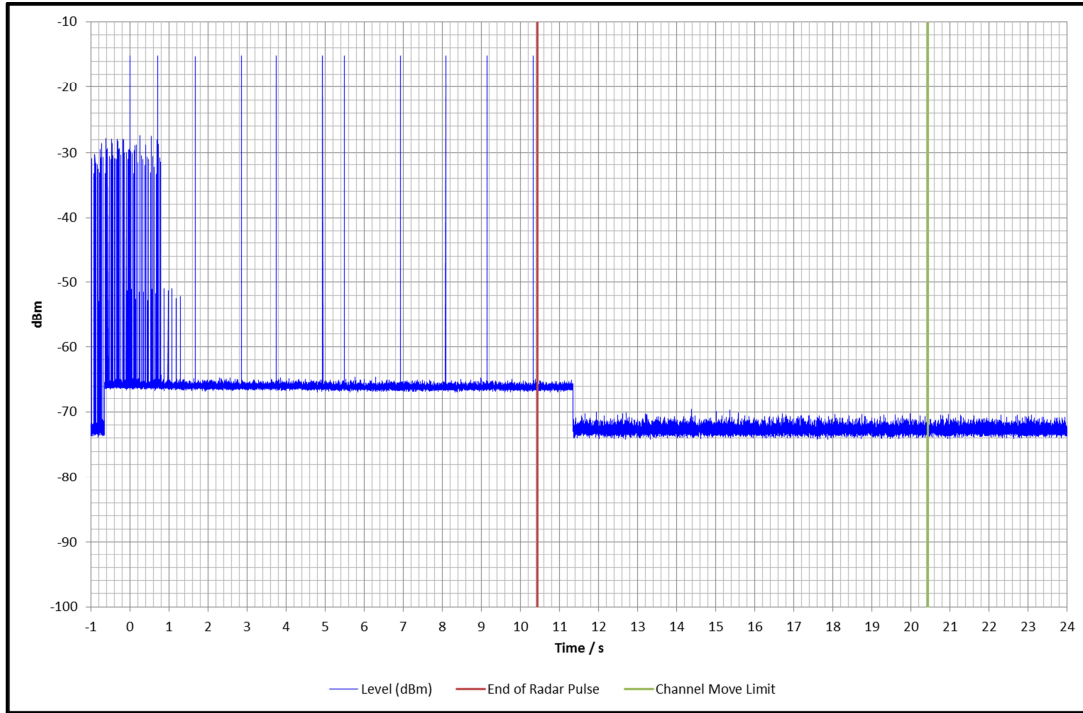

Channel Move Time 5320 MHz – Long Radar (Type 5)

Type 5 Radar Parameters

Burst Segment	Number of Pulses	Pulse Width (usec)	Chirp Width (MHz)	Pulse 1-to-2 Spacing (usec)	Pulse 2-to-3 Spacing (usec)	Starting Location Within Interval (usec)
1	3	60	5	1959	1238	588896
2	1	65	9	-	-	500703
3	1	54	9	-	-	998014
4	2	77	6	1170	-	260798
5	1	69	6	-	-	760290
6	2	72	9	1149	-	872408
7	2	90	15	1256	-	286570
8	3	53	17	1689	1834	1070125
9	3	99	17	1871	1882	596338

Channel Closing Transmission Time and Channel Move Time (continued)**Test Equipment Used:**

RFI No.	Instrument	Manufacturer	Type No.	Serial No.	Date Calibration Due	Cal. Interval (Months)
M1631	DFS Test System	Aeroflex	PXI 3000	300110/291	11 Jun 2015	24
L1028	Spectrum Analyser	Rohde & Schwarz	FSV30	100233	23 May 2014	12
A2141	10 dB Attenuator	AtlanTecRF	AN18-10	090918-04	Calibrated Before Use	-
A030	Step Attenuator	Narda	445-69	01544	Calibrated Before Use	-
A090	Step Attenuator	Narda	743-80	01057	Calibrated Before Use	-
A2179	Coaxial Circulator 4-18GHz	AtlanTecRF	ACC-20130-SF-SF-SF	120409230	Calibrated Before Use	-
A2180	Coaxial Circulator 4-18GHz	AtlanTecRF	ACC-20130-SF-SF-SF	120409231	Calibrated Before Use	-
A2181	Coaxial Circulator 4-18GHz	AtlanTecRF	ACC-20130-SF-SF-SF	120409232	Calibrated Before Use	-
A2121	Splitter	Mini-Circuits	ZN2PD-63-S+	S UU12701203	Calibrated Before Use	-

5.2.2. Non-Occupancy Period

Test Summary:

Test Engineer:	Philip Harrison	Test Date:	24 April 2014
Test Sample MAC Address:	240A646DE213		

FCC Reference:	Part 15.407(h)(iv)
Industry Canada Reference:	RSS-210 A9.3(b)(v)
Test Method Used:	FCC 06-96 Section 7.8.3

Environmental Conditions:

Temperature (°C):	23
Relative Humidity (%):	47

Results: 20 MHz

Radar burst type 1 detected and channel was vacated for >30 minutes.

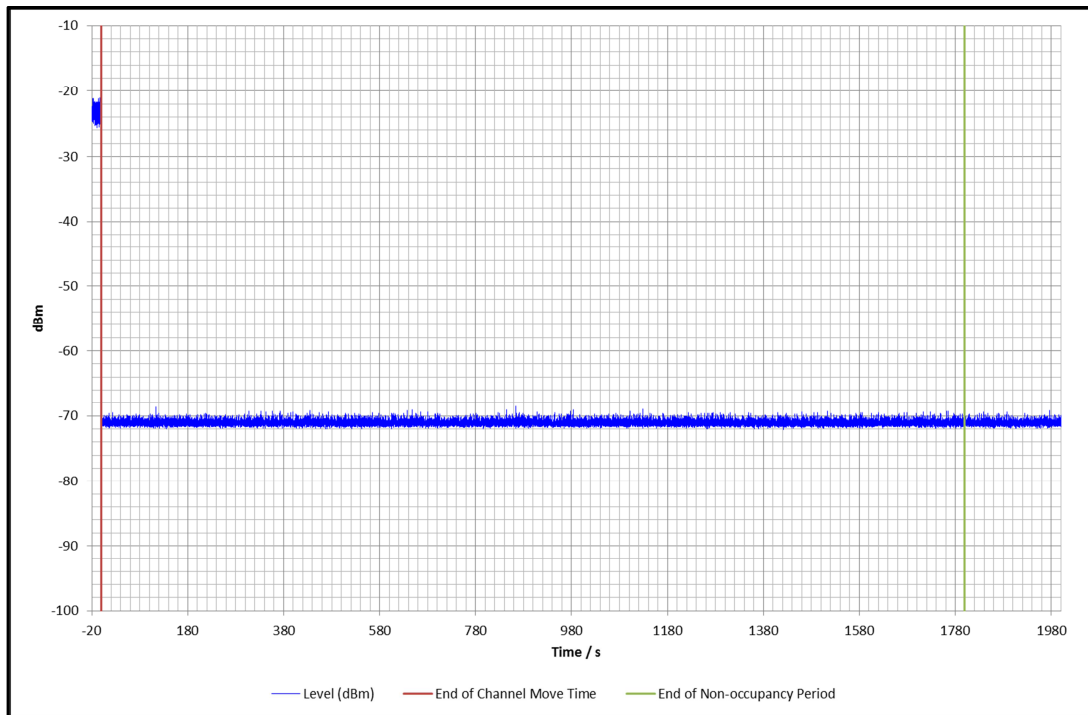

Non-occupancy Period – 5540 MHz

Non-Occupancy Period (continued)**Test Equipment Used:**

RFI No.	Instrument	Manufacturer	Type No.	Serial No.	Date Calibration Due	Cal. Interval (Months)
M1631	DFS Test System	Aeroflex	PXI 3000	300110/291	11 Jun 2015	24
L1028	Spectrum Analyser	Rohde & Schwarz	FSV30	100233	23 May 2014	12
A2141	10 dB Attenuator	AtlanTecRF	AN18-10	090918-04	Calibrated Before Use	-
A030	Step Attenuator	Narda	445-69	01544	Calibrated Before Use	-
A090	Step Attenuator	Narda	743-80	01057	Calibrated Before Use	-
A2179	Coaxial Circulator 4-18GHz	AtlanTecRF	ACC-20130-SF-SF-SF	120409230	Calibrated Before Use	-
A2180	Coaxial Circulator 4-18GHz	AtlanTecRF	ACC-20130-SF-SF-SF	120409231	Calibrated Before Use	-
A2181	Coaxial Circulator 4-18GHz	AtlanTecRF	ACC-20130-SF-SF-SF	120409232	Calibrated Before Use	-
A2121	Splitter	Mini-Circuits	ZN2PD-63-S+	S U12701203	Calibrated Before Use	-

6. Measurement Uncertainty

No measurement or test can ever be perfect and the imperfections give rise to error of measurement in the results. Consequently the result of a measurement is only an approximation to the value of the measurand (the specific quantity subject to measurement) and is only complete when accompanied by a statement of the uncertainty of the approximation.

The expression of uncertainty of a measurement result allows realistic comparison of results with reference values and limits given in specifications and standards.

The uncertainty of the result may need to be taken into account when interpreting the measurement results.

The reported expanded uncertainties below are based on a standard uncertainty multiplied by an appropriate coverage factor such that a confidence level of approximately 95% is maintained. For the purposes of this document "approximately" is interpreted as meaning "effectively" or "for most practical purposes".

Measurement Type	Range	Confidence Level (%)	Calculated Uncertainty
DFS Radar Amplitude	5.15 GHz to 5.825 GHz	95%	±2.17 dB
Channel Shutdown Timing	5.15 GHz to 5.825 GHz	95%	±0.45 ms
Non-Occupancy Timing	5.15 GHz to 5.825 GHz	95%	±79.25 ms

The methods used to calculate the above uncertainties are in line with those recommended within the various measurement specifications. Where measurement specifications do not include guidelines for the evaluation of measurement uncertainty the published guidance of the appropriate accreditation body is followed.

7. Report Revision History

Version Number	Revision Details		
	Page No(s)	Clause	Details
1.0	-	-	Initial Version
2.0	1, 5, 13 & 17	-	Added additional references to Industry Canada RSS-210 as requested by the TCB.

Appendix 1. Test Setup photos

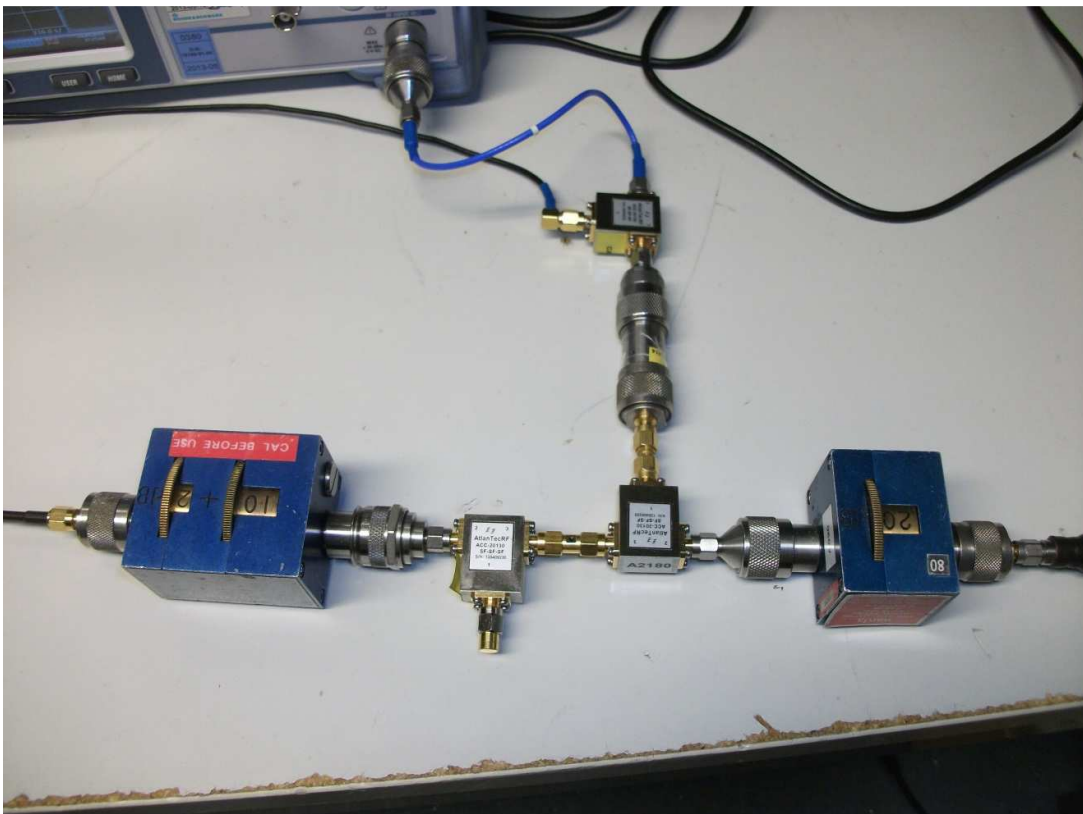
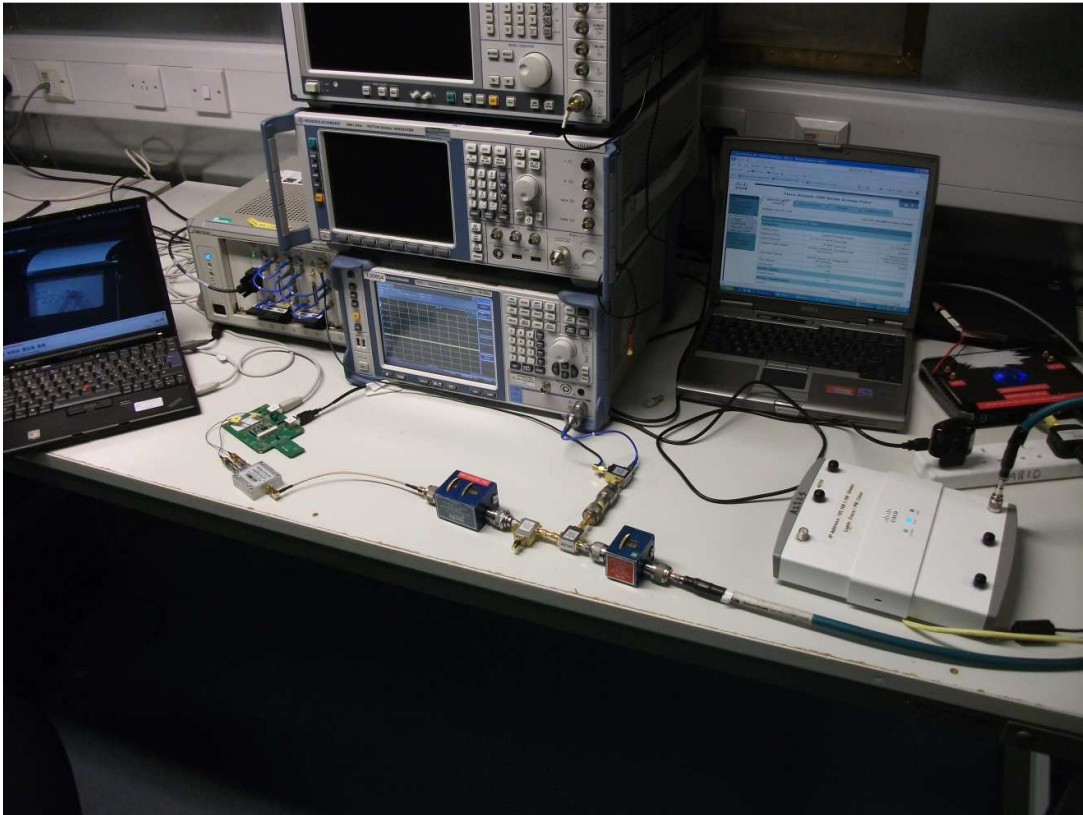

Appendix 2. Radar Calibration

Radar calibration procedure.

The system was configured as shown in section 4.2, but with the spectrum analyser port terminated into a 50Ω load, and a spectrum analyser connected to the master port. The radar was then replayed by the Aeroflex DFS test system, the waveform captured, and the amplitude adjusted until correct.

The accuracy of the radars pulses themselves and the software which creates them, has already been approved by the FCC and NTIA. See Appendix 4 for details.

Below are plots of the radar bursts at the DFS master port of the attenuation network. The Aeroflex signal generator was set to -62 dBm output.

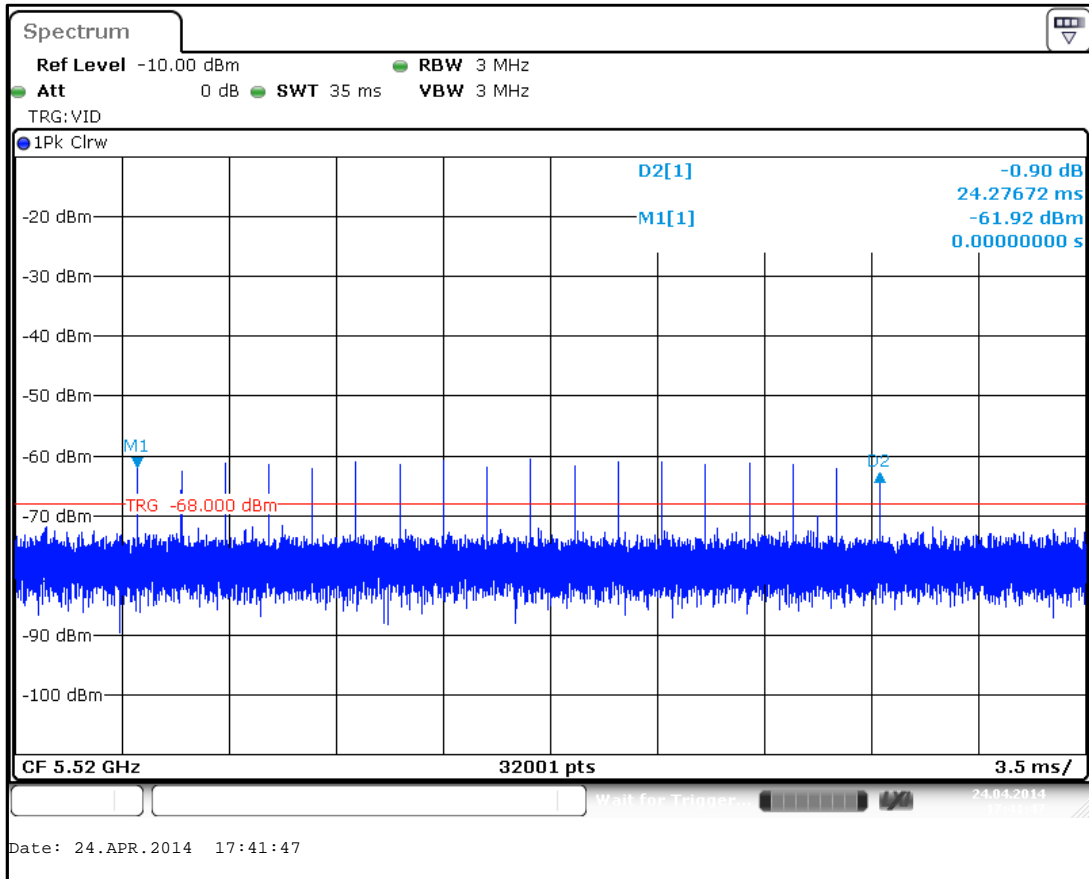

Type 1 (Short) Radar

Radar calibration procedure (continued)

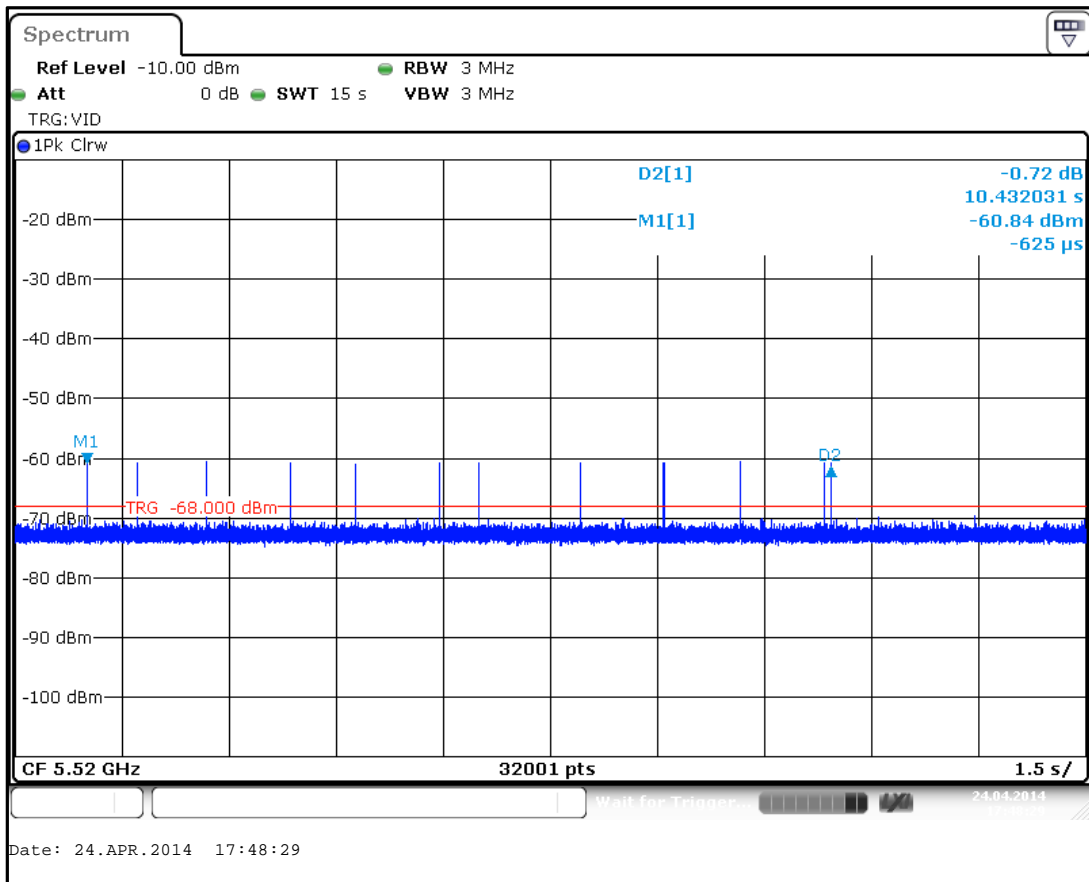

Type 5 (Long) Radar

Appendix 3. Aeroflex Test Platform Approval email

From: Andrew Leimer [<mailto:Andrew.Leimer@fcc.gov>]
Sent: Friday, September 23, 2011 4:24 PM
To: Chisham, Steve
Cc: Carey, Tim; Hack, Barry; Rashmi Doshi; Joe Dichoso
Subject: RE: Certification for Aeroflex DFS solution

Hello Steve,

The Aeroflex "DXI based DFS test solution" system used for DFS alternative radar signal generation has been approved by the FCC and NTIA.

This approval permits the system to be used by labs in the testing of DFS devices for equipment authorization Certification. It is recommended that applicants that use your system for testing include a statement in the Test Report or a Letter Exhibit stating that the system has FCC and NTIA approval. This E-mail is your record of this approval.
Note that the appropriate term for your system is Approved as the term Certification is reserved for devices gaining equipment authorization through the FCC or a TCB.

Regards,

Andy Leimer

FCC/OET/EACB

Appendix 4. System Noise Floor Reference Plots

As required by Section 8.3.18(iii) of FCC 06-96, the following plot shows the reference noise floor of the system used during measurement.

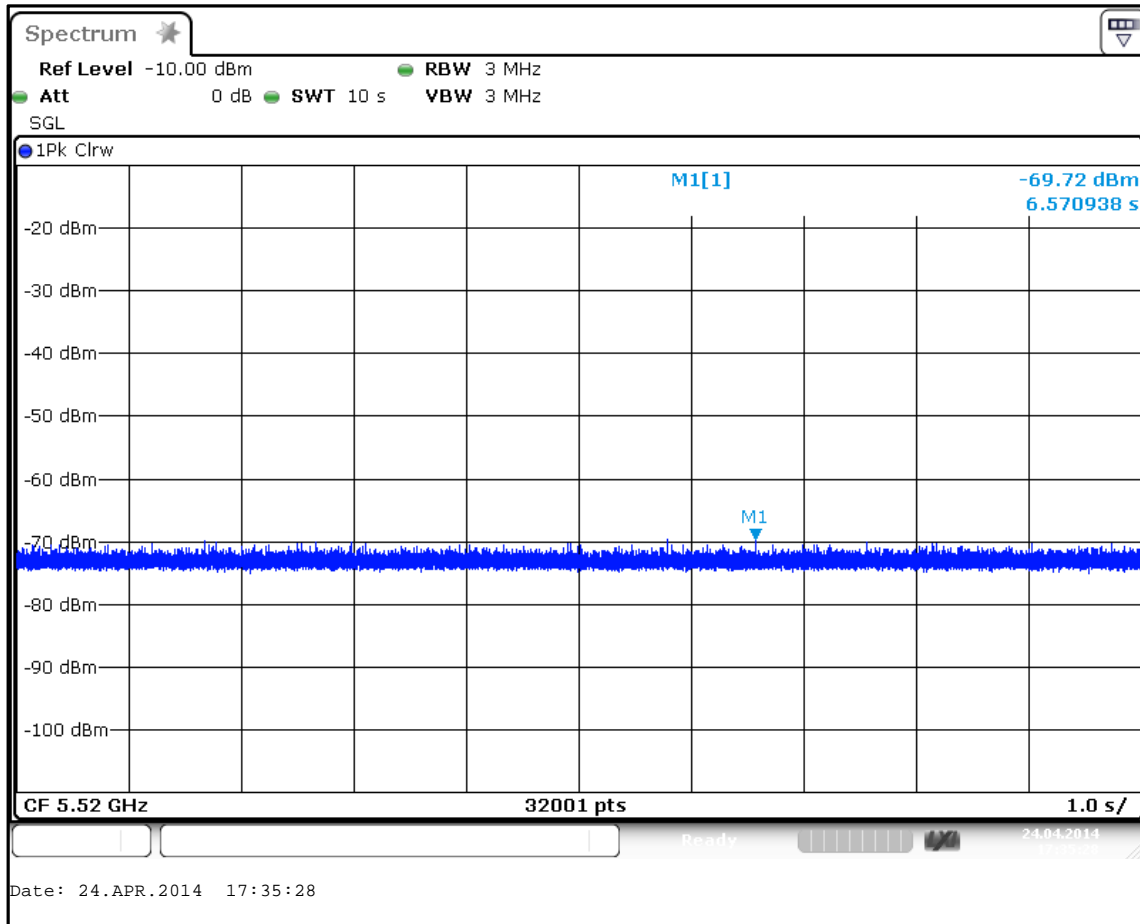

Noise Floor of Spectrum Analyser

---END OF REPORT---