



MET Laboratories, Inc. *Safety Certification - EMI - Telecom Environmental Simulation*

914 WEST PATAPSCO AVENUE • BALTIMORE, MARYLAND 21230 • PHONE (410) 354-3300 • FAX (410) 354-3313

33439 WESTERN AVENUE • UNION CITY, CALIFORNIA 94587 • PHONE (510) 489-6300 • FAX (510) 489-6372

3162 BELICK STREET • SANTA CLARA, CALIFORNIA 95054 • PHONE (408) 748-3585 • FAX (510) 489-6372

13501 MCCALLEN PASS • AUSTIN, TEXAS 78753 • PHONE (512) 287-2500 • FAX (512) 287-2513

March 10, 2016

Exalt Wireless - San Jose
1350 E Arapaho Rd.
Richardson, TX 75081

Dear Nader Vasseghi,

Enclosed is the EMC Wireless test report for compliance testing of the Exalt Wireless - San Jose, ExtendAir G2 24GHz (rc24020) as tested to the requirements of Title 47 of the CFR, Ch. 1 (10-1-06 ed.), FCC Part 15 Subpart C, RSS-210, Issue 8, December 2010 for Intentional Radiators.

Thank you for using the services of MET Laboratories, Inc. If you have any questions regarding these results or if MET can be of further service to you, please feel free to contact me.

Sincerely yours,
MET LABORATORIES, INC.

Jennifer Warnell
Documentation Department

Reference: (\Exalt Wireless - San Jose\EMCS87365-FCC249 Rev. 3)

Certificates and reports shall not be reproduced except in full, without the written permission of MET Laboratories, Inc.

Electromagnetic Compatibility Criteria Test Report

for the

**Exalt Wireless - San Jose
ExtendAir G2 24GHz (rc24020)**

Verified under
the FCC Certification Rules
contained in
Title 47 of the CFR, Part 15.249 Subpart C
&
RSS-210, Issue 8, December 2010
for Intentional Radiators

MET Report: EMCS87365-FCC249 Rev. 3

March 10, 2016

Prepared For:

**Exalt Wireless - San Jose
1350 E Arapaho Rd.
Richardson, TX 75081**

Prepared By:
MET Laboratories, Inc.
914 W. Patapsco Ave.
Baltimore, MD 21230

**Electromagnetic Compatibility Criteria
Test Report**

for the

**Exalt Wireless - San Jose
ExtendAir G2 24GHz (rc24020)**

Tested Under
the FCC Certification Rules
contained in
Title 47 of the CFR, Part 15.249 Subpart C
&
RSS-210, Issue 8, December 2010
for Intentional Radiators



Kaushani Dasgupta, Project Engineer
Electromagnetic Compatibility Lab



Jennifer Warnell
Documentation Department

Engineering Statement: The measurements shown in this report were made in accordance with the procedures indicated, and the emissions from this equipment were found to be within the limits applicable. I assume full responsibility for the accuracy and completeness of these measurements, and for the qualifications of all persons taking them. It is further stated that upon the basis of the measurements made, the equipment tested is capable of operation in accordance with the requirements of the FCC Rules Part 15.249 and Industry Canada standard RSS-210, Issue 8, December 2010 under normal use and maintenance.



Asad Bajwa, Director
Electromagnetic Compatibility Lab



Report Status Sheet

Revision	Report Date	Reason for Revision
∅	February 26, 2016	Initial Issue.
1	March 1, 2016	Engineer corrections.
2	March 8, 2016	Editorial corrections.
3	March 10, 2016	Editorial corrections.

Table of Contents

I.	Executive Summary	1
	A. Purpose of Test	2
	B. Executive Summary	2
II.	Equipment Configuration	3
	A. Overview	4
	B. References	4
	C. Test Site	5
	D. Description of Test Sample.....	5
	E. Equipment Configuration	6
	F. Support Equipment	6
	G. Ports and Cabling Information.....	6
	H. Mode of Operation.....	7
	I. Modifications.....	7
	a) Modifications to EUT.....	7
	b) Modifications to Test Standard.....	7
	J. Disposition of EUT.....	7
III.	Electromagnetic Compatibility Criteria for Intentional Radiators.....	8
	§ 15.203 Antenna Requirement	9
	§ 15.207(a) Conducted Emissions Limits.....	10
	§ 15.249(b)(1) Radiated Fundament and Harmonics.....	14
	§ 15.247(i) Maximum Permissible Exposure	24
	§ 15.249(b)(2) Frequency Tolerance	25
	§ 15.249(b)(3) Antenna Performance	28
	§ 15.249(a)(d) Spurious Emissions	37
	§2.1049 & RSS-GEN (6.6) 99% Occupied Bandwidth.....	111
	§RSS-210 Power to Antenna	126
IV.	Test Equipment	134
V.	Certification & User’s Manual Information.....	136
	A. Certification Information	137
	B. Label and User’s Manual Information	141
VI.	ICES-003 Procedural & Labeling Requirements.....	143

List of Tables

Table 1. Executive Summary of EMC Part 15.249 Compliance Testing	2
Table 2. EUT Specifications	4
Table 3. References	4
Table 4. Equipment Configuration	6
Table 5. Support Equipment.....	6
Table 6. Ports and Cabling Information	6
Table 7. Conducted Limits for Intentional Radiators from FCC Part 15 § 15.207(a)	10
Table 8. Conducted Emissions, 15.207(a), Phase Line, Test Results	11
Table 9. Conducted Emissions, 15.207(a), Neutral Line, Test Results	12
Table 10. Field Strength of Fundamental, 5 MHz	14
Table 11. Field Strength of Fundamental, 10 MHz	14
Table 12. Field Strength of Fundamental, 20 MHz	15
Table 13. Field Strength of Fundamental, 25 MHz	15
Table 14. Field Strength of Fundamental, 30MHz	15
Table 15. Field Strength of Fundamental, 40MHz	15
Table 16. Field Strength of Fundamental, 50MHz	16
Table 17. Frequency Tolerance, Low Band	25
Table 18. Frequency Tolerance, Mid Band	26
Table 19. Frequency Tolerance, High Band	26
Table 20. Test Equipment	135

List of Photographs

Photograph 1. Conducted Emissions, 15.207(a), Test Setup	13
Photograph 2. Frequency Tolerance, Test Setup	27
Photograph 3. Frequency Tolerance, Inside the Thermal Chamber with the Unit	27
Photograph 4. Radiated Spurious Emissions, Test Setup, Below 30 MHz - 1 GHz	109
Photograph 5. Radiated Spurious Emissions, Test Setup, Above 1 GHz - 18 GHz	109
Photograph 6. Radiated Spurious Emissions, Test Setup, Above 18-40GHz.....	110
Photograph 7. Radiated Spurious Emissions, Test Setup, Above 40 GHz	110

List of Plots

Plot 1. Conducted Emissions, 15.207(a), Phase Line	11
Plot 2. Conducted Emissions, 15.207(a), Neutral Line	12
Plot 3. Radiated Field Strength of Fundamental, 5 MHz, Low Channel	17
Plot 4. Radiated Field Strength of Fundamental, 5 MHz, Mid Channel	17
Plot 5. Radiated Field Strength of Fundamental, 5 MHz, High Channel	17
Plot 6. Radiated Field Strength of Fundamental, 10 MHz, Low Channel	18
Plot 7. Radiated Field Strength of Fundamental, 10 MHz, Mid Channel	18
Plot 8. Radiated Field Strength of Fundamental, 10 MHz, High Channel	18
Plot 9. Radiated Field Strength of Fundamental, 20 MHz, Low Channel	19
Plot 10. Radiated Field Strength of Fundamental, 20 MHz, Mid Channel	19
Plot 11. Radiated Field Strength of Fundamental, 20 MHz, High Channel	19
Plot 12. Radiated Field Strength of Fundamental, 25 MHz, Low Channel	20
Plot 13. Radiated Field Strength of Fundamental, 25 MHz, Mid Channel	20
Plot 14. Radiated Field Strength of Fundamental, 25 MHz, High Channel	20
Plot 15. Radiated Field Strength of Fundamental, 30 MHz, Low Channel	21
Plot 16. Radiated Field Strength of Fundamental, 30 MHz, Mid Channel	21
Plot 17. Radiated Field Strength of Fundamental, 30 MHz, High Channel	21

Plot 18. Radiated Field Strength of Fundamental, 40 MHz, Low Channel	22
Plot 19. Radiated Field Strength of Fundamental, 40 MHz, Mid Channel.....	22
Plot 20. Radiated Field Strength of Fundamental, 40 MHz, High Channel	22
Plot 21. Radiated Field Strength of Fundamental, 50 MHz, Low Channel	23
Plot 22. Radiated Field Strength of Fundamental, 50 MHz, Mid Channel.....	23
Plot 23. Radiated Field Strength of Fundamental, 50 MHz, High Channel	23
Plot 24. Radiated Spurious Emissions, 5 MHz, Low Channel, 30 MHz – 1 GHz.....	38
Plot 25. Radiated Spurious Emissions, 5 MHz, Low Channel, 1 GHz – 18 GHz, Average.....	38
Plot 26. Radiated Spurious Emissions, 5 MHz, Low Channel, 1 GHz – 18 GHz, Peak.....	38
Plot 27. Radiated Spurious Emissions, 5 MHz, Low Channel, 18 GHz – 40 GHz, Average.....	39
Plot 28. Radiated Spurious Emissions, 5 MHz, Low Channel, 18 GHz – 40 GHz, Peak.....	39
Plot 29. Radiated Spurious Emissions, 5 MHz, Low Channel, 40 GHz – 50 GHz	39
Plot 30. Radiated Spurious Emissions, 5 MHz, Low Channel, 50 GHz – 75 GHz	40
Plot 31. Radiated Spurious Emissions, 5 MHz, Low Channel, 75 GHz – 100 GHz	40
Plot 32. Radiated Spurious Emissions, 5 MHz, Mid Channel, 30 MHz – 1 GHz	40
Plot 33. Radiated Spurious Emissions, 5 MHz, Mid Channel, 1 GHz – 18 GHz, Peak	41
Plot 34. Radiated Spurious Emissions, 5 MHz, Mid Channel, 1 GHz – 18 GHz, Average.....	41
Plot 35. Radiated Spurious Emissions, 5 MHz, Mid Channel, 18 GHz – 40 GHz, Average.....	41
Plot 36. Radiated Spurious Emissions, 5 MHz, Mid Channel, 18 GHz – 40 GHz, Peak	42
Plot 37. Radiated Spurious Emissions, 5 MHz, Mid Channel, 40 GHz – 50 GHz.....	42
Plot 38. Radiated Spurious Emissions, 5 MHz, Mid Channel, 50 GHz – 75 GHz.....	42
Plot 39. Radiated Spurious Emissions, 5 MHz, Mid Channel, 75 GHz – 100 GHz.....	43
Plot 40. Radiated Spurious Emissions, 5 MHz, High Channel, 30 MHz – 1 GHz.....	43
Plot 41. Radiated Spurious Emissions, 5 MHz, High Channel, 1 GHz – 18 GHz, Average	43
Plot 42. Radiated Spurious Emissions, 5 MHz, High Channel, 1 GHz – 18 GHz, Peak.....	44
Plot 43. Radiated Spurious Emissions, 5 MHz, High Channel, 18 GHz – 40 GHz, Average	44
Plot 44. Radiated Spurious Emissions, 5 MHz, High Channel, 18 GHz – 40 GHz, Peak.....	44
Plot 45. Radiated Spurious Emissions, 5 MHz, High Channel, 40 GHz – 50 GHz.....	45
Plot 46. Radiated Spurious Emissions, 5 MHz, High Channel, 50 GHz – 75 GHz.....	45
Plot 47. Radiated Spurious Emissions, 5 MHz, High Channel, 75 GHz – 100 GHz.....	45
Plot 48. Radiated Spurious Emissions, 10 MHz, Low Channel, 30 MHz – 1 GHz.....	46
Plot 49. Radiated Spurious Emissions, 10 MHz, Low Channel, 1 GHz – 18 GHz, Average.....	46
Plot 50. Radiated Spurious Emissions, 10 MHz, Low Channel, 1 GHz – 18 GHz, Peak.....	46
Plot 51. Radiated Spurious Emissions, 10 MHz, Low Channel, 18 GHz - 40 GHz, Peak	47
Plot 52. Radiated Spurious Emissions, 10 MHz, Low Channel, 18-40 GHz, Average.....	47
Plot 53. Radiated Spurious Emissions, 10 MHz, Low Channel, 40 GHz – 50 GHz	47
Plot 54. Radiated Spurious Emissions, 10 MHz, Low Channel, 50 GHz – 75 GHz	48
Plot 55. Radiated Spurious Emissions, 10 MHz, Low Channel, 75 GHz – 100 GHz	48
Plot 56. Radiated Spurious Emissions, 10 MHz, Mid Channel, 30 MHz – 1 GHz	48
Plot 57. Radiated Spurious Emissions, 10 MHz, Mid Channel, 1 GHz – 18 GHz, Peak	49
Plot 58. Radiated Spurious Emissions, 10 MHz, Mid Channel, 1 GHz – 18 GHz, Average.....	49
Plot 59. Radiated Spurious Emissions, 10 MHz, Mid Channel, 18 GHz - 40 GHz, Peak	49
Plot 60. Radiated Spurious Emissions, 10 MHz, Mid Channel, 18 GHz - 40 GHz, Average	50
Plot 61. Radiated Spurious Emissions, 10 MHz, Mid Channel, 40 GHz – 50 GHz	50
Plot 62. Radiated Spurious Emissions, 10 MHz, Mid Channel, 50 GHz – 75 GHz.....	50
Plot 63. Radiated Spurious Emissions, 10 MHz, Mid Channel, 75 GHz – 100 GHz.....	51
Plot 64. Radiated Spurious Emissions, 10 MHz, High Channel, 30 MHz – 1 GHz	51
Plot 65. Radiated Spurious Emissions, 10 MHz, High Channel, 1 GHz – 18 GHz, Average	51
Plot 66. Radiated Spurious Emissions, 10 MHz, High Channel, 1 GHz – 18 GHz, Peak.....	52
Plot 67. Radiated Spurious Emissions, 10 MHz, High Channel, 18 GHz - 40 GHz, Peak.....	52
Plot 68. Radiated Spurious Emissions, 10 MHz, High Channel, 18 GHz - 40 GHz, Average.....	52
Plot 69. Radiated Spurious Emissions, 10 MHz, High Channel, 40 GHz – 50 GHz.....	53
Plot 70. Radiated Spurious Emissions, 10 MHz, High Channel, 50 GHz – 75 GHz.....	53
Plot 71. Radiated Spurious Emissions, 10 MHz, High Channel, 75 GHz – 100 GHz.....	53

Plot 72. Radiated Spurious Emissions, 20 MHz, Low Channel, 30 MHz – 1 GHz.....	54
Plot 73. Radiated Spurious Emissions, 20 MHz, Low Channel, 1 GHz – 18 GHz, Average.....	54
Plot 74. Radiated Spurious Emissions, 20 MHz, Low Channel, 1 GHz – 18 GHz, Peak.....	54
Plot 75. Radiated Spurious Emissions, 20 MHz, Low Channel, 18 GHz - 40 GHz, Peak.....	55
Plot 76. Radiated Spurious Emissions, 20 MHz, Low Channel, 18 GHz - 40 GHz, Average.....	55
Plot 77. Radiated Spurious Emissions, 20 MHz, Low Channel, 40 GHz – 50 GHz.....	55
Plot 78. Radiated Spurious Emissions, 20 MHz, Low Channel, 50 GHz – 75 GHz.....	56
Plot 79. Radiated Spurious Emissions, 20 MHz, Low Channel, 75 GHz – 100 GHz.....	56
Plot 80. Radiated Spurious Emissions, 20 MHz, Mid Channel, 30 MHz – 1 GHz.....	56
Plot 81. Radiated Spurious Emissions, 20 MHz, Mid Channel, 1 GHz – 18 GHz, Peak.....	57
Plot 82. Radiated Spurious Emissions, 20 MHz, Mid Channel, 1 GHz – 18 GHz, Average.....	57
Plot 83. Radiated Spurious Emissions, 20 MHz, Mid Channel, 18 GHz - 40 GHz.....	57
Plot 84. Radiated Spurious Emissions, 20 MHz, Mid Channel, 18 GHz - 40 GHz, Average.....	58
Plot 85. Radiated Spurious Emissions, 20 MHz, Mid Channel, 40 GHz – 50 GHz.....	58
Plot 86. Radiated Spurious Emissions, 20 MHz, Mid Channel, 50 GHz – 75 GHz.....	58
Plot 87. Radiated Spurious Emissions, 20 MHz, Mid Channel, 75 GHz – 100 GHz.....	59
Plot 88. Radiated Spurious Emissions, 20 MHz, High Channel, 30 MHz – 1 GHz.....	59
Plot 89. Radiated Spurious Emissions, 20 MHz, High Channel, 1 GHz – 18 GHz, Average.....	59
Plot 90. Radiated Spurious Emissions, 20 MHz, High Channel, 1 GHz – 18 GHz, Peak.....	60
Plot 91. Radiated Spurious Emissions, 20 MHz, High Channel, 18 GHz - 40 GHz, Peak.....	60
Plot 92. Radiated Spurious Emissions, 20 MHz, High Channel, 18 GHz - 40 GHz, Average.....	60
Plot 93. Radiated Spurious Emissions, 20 MHz, High Channel, 40 GHz – 50 GHz.....	61
Plot 94. Radiated Spurious Emissions, 20 MHz, High Channel, 50 GHz – 75 GHz.....	61
Plot 95. Radiated Spurious Emissions, 20 MHz, High Channel, 75 GHz – 100 GHz.....	61
Plot 96. Radiated Spurious Emissions, 25 MHz, Low Channel, 30 MHz – 1 GHz.....	62
Plot 97. Radiated Spurious Emissions, 25 MHz, Low Channel, 1 GHz – 18 GHz, Average.....	62
Plot 98. Radiated Spurious Emissions, 25 MHz, Low Channel, 1 GHz – 18 GHz, Peak.....	62
Plot 99. Radiated Spurious Emissions, 25 MHz, Low Channel, 18 GHz - 40 GHz, Peak.....	63
Plot 100. Radiated Spurious Emissions, 25 MHz, Low Channel, 18 GHz - 40 GHz, Average.....	63
Plot 101. Radiated Spurious Emissions, 25 MHz, Low Channel, 40 GHz – 50 GHz.....	63
Plot 102. Radiated Spurious Emissions, 25 MHz, Low Channel, 50 GHz – 75 GHz.....	64
Plot 103. Radiated Spurious Emissions, 25 MHz, Low Channel, 75 GHz – 100 GHz.....	64
Plot 104. Radiated Spurious Emissions, 25 MHz, Mid Channel, 30 MHz – 1 GHz.....	64
Plot 105. Radiated Spurious Emissions, 25 MHz, Mid Channel, 1 GHz – 18 GHz, Peak.....	65
Plot 106. Radiated Spurious Emissions, 25 MHz, Mid Channel, 1 GHz – 18 GHz, Average.....	65
Plot 107. Radiated Spurious Emissions, 25 MHz, Mid Channel, 18 GHz - 40 GHz, Peak.....	65
Plot 108. Radiated Spurious Emissions, 25 MHz, Mid Channel, 18 GHz - 40 GHz, Average.....	66
Plot 109. Radiated Spurious Emissions, 25 MHz, Mid Channel, 40 GHz – 50 GHz.....	66
Plot 110. Radiated Spurious Emissions, 25 MHz, Mid Channel, 50 GHz – 75 GHz.....	66
Plot 111. Radiated Spurious Emissions, 25 MHz, Mid Channel, 75 GHz – 100 GHz.....	67
Plot 112. Radiated Spurious Emissions, 25 MHz, High Channel, 30 MHz – 1 GHz.....	67
Plot 113. Radiated Spurious Emissions, 25 MHz, High Channel, 1 GHz – 18 GHz, Average.....	67
Plot 114. Radiated Spurious Emissions, 25 MHz, High Channel, 1 GHz – 18 GHz, Peak.....	68
Plot 115. Radiated Spurious Emissions, 25 MHz, High Channel, 18 GHz - 40 GHz, Peak.....	68
Plot 116. Radiated Spurious Emissions, 25 MHz, High Channel, 18 GHz - 40 GHz, Average.....	68
Plot 117. Radiated Spurious Emissions, 25 MHz, High Channel, 40 GHz – 50 GHz.....	69
Plot 118. Radiated Spurious Emissions, 25 MHz, High Channel, 50 GHz – 75 GHz.....	69
Plot 119. Radiated Spurious Emissions, 25 MHz, High Channel, 75 GHz – 100 GHz.....	69
Plot 120. Radiated Spurious Emissions, 30 MHz, Low Channel, 30 MHz – 1 GHz.....	70
Plot 121. Radiated Spurious Emissions, 30 MHz, Low Channel, 1 GHz – 18 GHz, Average.....	70
Plot 122. Radiated Spurious Emissions, 30 MHz, Low Channel, 1 GHz – 18 GHz, Peak.....	70
Plot 123. Radiated Spurious Emissions, 30 MHz, Low Channel, 18 GHz - 40 GHz, Peak.....	71
Plot 124. Radiated Spurious Emissions, 30 MHz, Low Channel, 18 GHz - 40 GHz, Average.....	71
Plot 125. Radiated Spurious Emissions, 30 MHz, Low Channel, 40 GHz – 50 GHz.....	71

Plot 126. Radiated Spurious Emissions, 30 MHz, Low Channel, 50 GHz – 75 GHz	72
Plot 127. Radiated Spurious Emissions, 30 MHz, Low Channel, 75 GHz – 100 GHz	72
Plot 128. Radiated Spurious Emissions, 30 MHz, Mid Channel, 30 MHz – 1 GHz	72
Plot 129. Radiated Spurious Emissions, 30 MHz, Mid Channel, 1 GHz – 18 GHz, Peak	73
Plot 130. Radiated Spurious Emissions, 30 MHz, Mid Channel, 1 GHz – 18 GHz, Peak	73
Plot 131. Radiated Spurious Emissions, 30 MHz, Mid Channel, 1 GHz – 18 GHz, Average.....	73
Plot 132. Radiated Spurious Emissions, 30 MHz, Mid Channel, 18 GHz - 40 GHz, Peak	74
Plot 133. Radiated Spurious Emissions, 30 MHz, Mid Channel, 18 GHz - 40 GHz, Average	74
Plot 134. Radiated Spurious Emissions, 30 MHz, Mid Channel, 40 GHz – 50 GHz.....	74
Plot 135. Radiated Spurious Emissions, 30 MHz, Mid Channel, 50 GHz – 75 GHz.....	75
Plot 136. Radiated Spurious Emissions, 30 MHz, Mid Channel, 75 GHz – 100 GHz.....	75
Plot 137. Radiated Spurious Emissions, 30 MHz, High Channel, 30 MHz – 1 GHz.....	75
Plot 138. Radiated Spurious Emissions, 30 MHz, High Channel, 1 GHz – 18 GHz, Average	76
Plot 139. Radiated Spurious Emissions, 30 MHz, High Channel, 1 GHz – 18 GHz, Peak	76
Plot 140. Radiated Spurious Emissions, 30 MHz, High Channel, 18 GHz - 40 GHz, Peak.....	76
Plot 141. Radiated Spurious Emissions, 30 MHz, High Channel, 18 GHz - 40 GHz, Average	77
Plot 142. Radiated Spurious Emissions, 30 MHz, High Channel, 40 GHz – 50 GHz.....	77
Plot 143. Radiated Spurious Emissions, 30 MHz, High Channel, 50 GHz – 75 GHz.....	77
Plot 144. Radiated Spurious Emissions, 30 MHz, High Channel, 75 GHz – 100 GHz.....	78
Plot 145. Radiated Spurious Emissions, 40 MHz, Low Channel, 30 MHz – 1 GHz.....	79
Plot 146. Radiated Spurious Emissions, 40 MHz, Low Channel, 1 GHz – 18 GHz, Average	79
Plot 147. Radiated Spurious Emissions, 40 MHz, Low Channel, 1 GHz – 18 GHz, Peak.....	79
Plot 148. Radiated Spurious Emissions, 40 MHz, Low Channel, 18 GHz - 40 GHz, Peak	80
Plot 149. Radiated Spurious Emissions, 40 MHz, Low Channel, 18 GHz - 40 GHz, Average.....	80
Plot 150. Radiated Spurious Emissions, 40 MHz, Low Channel, 40 GHz – 50 GHz	80
Plot 151. Radiated Spurious Emissions, 40 MHz, Low Channel, 50 GHz – 75 GHz	81
Plot 152. Radiated Spurious Emissions, 40 MHz, Low Channel, 75 GHz – 100 GHz	81
Plot 153. Radiated Spurious Emissions, 40 MHz, Mid Channel, 30 MHz – 1 GHz	81
Plot 154. Radiated Spurious Emissions, 40 MHz, Mid Channel, 1 GHz – 18 GHz, Peak	82
Plot 155. Radiated Spurious Emissions, 40 MHz, Mid Channel, 1 GHz – 18 GHz, Average.....	82
Plot 156. Radiated Spurious Emissions, 40 MHz, Mid Channel, 18 GHz – 40 GHz, Peak	82
Plot 157. Radiated Spurious Emissions, 40 MHz, Mid Channel, 18 GHz – 40 GHz, Average.....	83
Plot 158. Radiated Spurious Emissions, 40 MHz, Mid Channel, 40 GHz – 50 GHz.....	83
Plot 159. Radiated Spurious Emissions, 40 MHz, Mid Channel, 50 GHz – 75 GHz.....	83
Plot 160. Radiated Spurious Emissions, 40 MHz, Mid Channel, 75 GHz – 100 GHz.....	84
Plot 161. Radiated Spurious Emissions, 40 MHz, High Channel, 30 MHz – 1 GHz.....	84
Plot 162. Radiated Spurious Emissions, 40 MHz, High Channel, 1 GHz – 18 GHz, Average	84
Plot 163. Radiated Spurious Emissions, 40 MHz, High Channel, 1 GHz – 18 GHz, Peak	85
Plot 164. Radiated Spurious Emissions, 40 MHz, Low Channel, 18 GHz - 40 GHz, Peak	85
Plot 165. Radiated Spurious Emissions, 40 MHz, High Channel, 18 GHz - 40 GHz, Average	85
Plot 166. Radiated Spurious Emissions, 40 MHz, High Channel, 40 GHz – 50 GHz.....	86
Plot 167. Radiated Spurious Emissions, 40 MHz, High Channel, 50 GHz – 75 GHz.....	86
Plot 168. Radiated Spurious Emissions, 40 MHz, High Channel, 75 GHz – 100 GHz.....	86
Plot 169. Radiated Spurious Emissions, 50 MHz, Low Channel, 30 MHz – 1 GHz.....	87
Plot 170. Radiated Spurious Emissions, 50 MHz, Low Channel, 1 GHz – 18 GHz, Average	87
Plot 171. Radiated Spurious Emissions, 50 MHz, Low Channel, 1 GHz – 18 GHz, Peak.....	87
Plot 172. Radiated Spurious Emissions, 50 MHz, Low Channel, 18 GHz - 40 GHz, Peak	88
Plot 173. Radiated Spurious Emissions, 50 MHz, Low Channel, 18 GHz - 40 GHz, Average.....	88
Plot 174. Radiated Spurious Emissions, 50 MHz, Low Channel, 40 GHz – 50 GHz	88
Plot 175. Radiated Spurious Emissions, 50 MHz, Low Channel, 50 GHz – 75 GHz	89
Plot 176. Radiated Spurious Emissions, 50 MHz, Low Channel, 75 GHz – 100 GHz	89
Plot 177. Radiated Spurious Emissions, 50 MHz, Mid Channel, 30 MHz – 1 GHz	89
Plot 178. Radiated Spurious Emissions, 50 MHz, Mid Channel, 1 GHz - 18 GHz, Peak.....	90
Plot 179. Radiated Spurious Emissions, 50 MHz, Mid Channel, 1 GHz - 18 GHz, Average	90

Plot 180. Radiated Spurious Emissions, 50 MHz, Mid Channel, 18 GHz - 40 GHz, Peak	90
Plot 181. Radiated Spurious Emissions, 50 MHz, Mid Channel, 18 GHz - 40 GHz, Average.....	91
Plot 182. Radiated Spurious Emissions, 50 MHz, Mid Channel, 40 GHz - 50 GHz	91
Plot 183. Radiated Spurious Emissions, 50 MHz, Mid Channel, 50 GHz - 75 GHz	91
Plot 184. Radiated Spurious Emissions, 50 MHz, Mid Channel, 75 GHz - 100 GHz	92
Plot 185. Radiated Spurious Emissions, 50 MHz, High Channel, 30 MHz - 1 GHz	92
Plot 186. Radiated Spurious Emissions, 50 MHz, High Channel, 1 GHz - 18 GHz, Average	92
Plot 187. Radiated Spurious Emissions, 50 MHz, High Channel, 1 GHz - 18 GHz, Peak	93
Plot 188. Radiated Spurious Emissions, 50 MHz, High Channel, 18 GHz - 40 GHz, Peak	93
Plot 189. Radiated Spurious Emissions, 50 MHz, High Channel, 18 GHz - 40 GHz, Average	93
Plot 190. Radiated Spurious Emissions, 50 MHz, High Channel, 40 GHz - 50 GHz	94
Plot 191. Radiated Spurious Emissions, 50 MHz, High Channel, 50 GHz - 75 GHz	94
Plot 192. Radiated Spurious Emissions, 50 MHz, High Channel, 75 GHz - 100 GHz	94
Plot 193. Radiated Band Edge, 5 MHz, Low Channel, Average.....	95
Plot 194. Radiated Band Edge, 5 MHz, Low Channel, Peak	95
Plot 195. Radiated Band Edge, 5 MHz, High Channel, Average	95
Plot 196. Radiated Band Edge, 5 MHz, High Channel, Peak	96
Plot 197. Radiated Band Edge, 10 MHz, Low Channel, Average.....	97
Plot 198. Radiated Band Edge, 10 MHz, Low Channel, Peak	97
Plot 199. Radiated Band Edge, 10 MHz, High Channel, Average	97
Plot 200. Radiated Band Edge, 10 MHz, High Channel, Peak	98
Plot 201. Radiated Band Edge, 20 MHz, Low Channel, Average.....	99
Plot 202. Radiated Band Edge, 20 MHz, Low Channel, Peak	99
Plot 203. Radiated Band Edge, 20 MHz, High Channel, Average	99
Plot 204. Radiated Band Edge, 20 MHz, High Channel, Peak	100
Plot 205. Radiated Band Edge, 25 MHz, Low Channel, Average.....	101
Plot 206. Radiated Band Edge, 25 MHz, Low Channel, Peak	101
Plot 207. Radiated Band Edge, 25 MHz, High Channel, Average	101
Plot 208. Radiated Band Edge, 25 MHz, High Channel, Peak	102
Plot 209. Radiated Band Edge, 30 MHz, Low Channel, Average.....	103
Plot 210. Radiated Band Edge, 30 MHz, Low Channel, Peak	103
Plot 211. Radiated Band Edge, 30 MHz, High Channel, Average	103
Plot 212. Radiated Band Edge, 30 MHz, High Channel, Peak	104
Plot 213. Radiated Band Edge, 40 MHz, Low Channel, Average.....	105
Plot 214. Radiated Band Edge, 40 MHz, Low Channel, Peak	105
Plot 215. Radiated Band Edge, 40 MHz, High Channel, Average	105
Plot 216. Radiated Band Edge, 40 MHz, High Channel, Peak	106
Plot 217. Radiated Band Edge, 50 MHz, Low Channel, Average.....	107
Plot 218. Radiated Band Edge, 50 MHz, Low Channel, Peak	107
Plot 219. Radiated Band Edge, 50 MHz, High Channel, Average	107
Plot 220. Radiated Band Edge, 50 MHz, High Channel, Peak	108
Plot 221. Occupied Bandwidth, Low Channel, 5 MHz	112
Plot 222. Occupied Bandwidth, Mid Channel, 5 MHz	112
Plot 223. Occupied Bandwidth, High Channel, 5 MHz	112
Plot 224. Occupied Bandwidth, Low Channel, 10 MHz	113
Plot 225. Occupied Bandwidth, Mid Channel, 10 MHz	113
Plot 226. Occupied Bandwidth, High Channel, 10 MHz	113
Plot 227. Occupied Bandwidth, Low Channel, 20 MHz	114
Plot 228. Occupied Bandwidth, Mid Channel, 20 MHz	114
Plot 229. Occupied Bandwidth, High Channel, 20 MHz	114
Plot 230. Occupied Bandwidth, Low Channel, 25 MHz	115
Plot 231. Occupied Bandwidth, Mid Channel, 25 MHz	115
Plot 232. Occupied Bandwidth, High Channel, 25 MHz	115
Plot 233. Occupied Bandwidth, Low Channel, 30 MHz	116

Plot 234. Occupied Bandwidth, Mid Channel, 30 MHz.....	116
Plot 235. Occupied Bandwidth, High Channel, 30 MHz	116
Plot 236. Occupied Bandwidth, Low Channel, 40 MHz	117
Plot 237. Occupied Bandwidth, Mid Channel, 40 MHz.....	117
Plot 238. Occupied Bandwidth, High Channel, 40 MHz	117
Plot 239. Occupied Bandwidth, Low Channel, 50 MHz	118
Plot 240. Occupied Bandwidth, Mid Channel, 50 MHz.....	118
Plot 241. Occupied Bandwidth, High Channel, 50 MHz	118
Plot 242. 99% Occupied Bandwidth, Low Channel, 5 MHz.....	119
Plot 243. 99% Occupied Bandwidth, Mid Channel, 5 MHz.....	119
Plot 244. 99% Occupied Bandwidth, High Channel, 5 MHz	119
Plot 245. 99% Occupied Bandwidth, Low Channel, 10 MHz.....	120
Plot 246. 99% Occupied Bandwidth, Mid Channel, 10 MHz.....	120
Plot 247. 99% Occupied Bandwidth, High Channel, 10 MHz	120
Plot 248. 99% Occupied Bandwidth, Low Channel, 20 MHz.....	121
Plot 249. 99% Occupied Bandwidth, Mid Channel, 20 MHz.....	121
Plot 250. 99% Occupied Bandwidth, High Channel, 20 MHz	121
Plot 251. 99% Occupied Bandwidth, Low Channel, 25 MHz.....	122
Plot 252. 99% Occupied Bandwidth, Mid Channel, 25 MHz.....	122
Plot 253. 99% Occupied Bandwidth, High Channel, 25 MHz	122
Plot 254. 99% Occupied Bandwidth, Low Channel, 30 MHz.....	123
Plot 255. 99% Occupied Bandwidth, Mid Channel, 30 MHz.....	123
Plot 256. 99% Occupied Bandwidth, High Channel, 30 MHz	123
Plot 257. 99% Occupied Bandwidth, Low Channel, 40 MHz.....	124
Plot 258. 99% Occupied Bandwidth, Mid Channel, 40 MHz.....	124
Plot 259. 99% Occupied Bandwidth, High Channel, 40 MHz	124
Plot 260. 99% Occupied Bandwidth, Low Channel, 50 MHz.....	125
Plot 261. 99% Occupied Bandwidth, Mid Channel, 50 MHz.....	125
Plot 262. 99% Occupied Bandwidth, High Channel, 50 MHz	125
Plot 263. Measured Power, Low Channel, 5 MHz	127
Plot 264. Measured Power, Mid Channel, 5 MHz.....	127
Plot 265. Measured Power, High Channel, 5 MHz	127
Plot 266. Measured Power, Low Channel, 10 MHz.....	128
Plot 267. Measured Power, Mid Channel, 10 MHz.....	128
Plot 268. Measured Power, High Channel, 10 MHz	128
Plot 269. Measured Power, Low Channel, 20 MHz	129
Plot 270. Measured Power, Mid Channel, 20 MHz.....	129
Plot 271. Measured Power, High Channel, 20 MHz	129
Plot 272. Measured Power, Low Channel, 25 MHz	130
Plot 273. Measured Power, Mid Channel, 25 MHz.....	130
Plot 274. Measured Power, High Channel, 25 MHz	130
Plot 275. Measured Power, Low Channel, 30 MHz	131
Plot 276. Measured Power, Mid Channel, 30 MHz.....	131
Plot 277. Measured Power, High Channel, 30 MHz	131
Plot 278. Measured Power, Low Channel, 40 MHz	132
Plot 279. Measured Power, Mid Channel, 40 MHz.....	132
Plot 280. Measured Power, High Channel, 40 MHz	132
Plot 281. Measured Power, Low Channel, 50 MHz	133
Plot 282. Measured Power, Mid Channel, 50 MHz.....	133
Plot 283. Measured Power, High Channel, 50 MHz	133

List of Terms and Abbreviations

AC	Alternating Current
ACF	Antenna Correction Factor
Cal	Calibration
<i>d</i>	Measurement Distance
dB	Decibels
dB μ A	Decibels above one microamp
dB μ V	Decibels above one microvolt
dB μ A/m	Decibels above one microamp per meter
dB μ V/m	Decibels above one microvolt per meter
DC	Direct Current
E	Electric Field
DSL	Digital Subscriber Line
ESD	Electrostatic Discharge
EUT	Equipment Under Test
<i>f</i>	Frequency
FCC	Federal Communications Commission
GRP	Ground Reference Plane
H	Magnetic Field
HCP	Horizontal Coupling Plane
Hz	Hertz
IEC	International Electrotechnical Commission
kHz	Kilohertz
kPa	Kilopascal
kV	Kilovolt
LISN	Line Impedance Stabilization Network
MHz	Megahertz
μ H	Microhenry
μ F	Microfarad
μ s	Microseconds
PRF	Pulse Repetition Frequency
RF	Radio Frequency
RMS	Root-Mean-Square
TWT	Traveling Wave Tube
V/m	Volts per meter
VCP	Vertical Coupling Plane

I. Executive Summary

A. Purpose of Test

An EMC evaluation was performed to determine compliance of the Exalt Wireless – San Jose ExtendAir G2 24GHz (rc24020), with the requirements of Part 15, §15.249. All references are to the most current version of Title 47 of the Code of Federal Regulations in effect. In accordance with §2.1033, the following data is presented in support of the Certification of the ExtendAir G2 24GHz (rc24020). Exalt Wireless – San Jose should retain a copy of this document which should be kept on file for at least two years after the manufacturing of the ExtendAir G2 24GHz (rc24020), has been **permanently** discontinued.

B. Executive Summary

The following tests were conducted on a sample of the equipment for the purpose of demonstrating compliance with Part 15, §15.249, in accordance with Exalt Wireless – San Jose, purchase order number 109107. All tests were conducted using measurement procedure ANSI C63.4-2014.

FCC Reference	Canada Reference	Description	Results
§15.203	--	Antenna Requirement	Compliant
§15.207	RSS GEN §8.8	AC Power Line Conducted Emissions	Compliant
§15.249 (b)(1)	RSS-210 A12	Field Strength of Fundamental	Compliant
§15.249 (b)(2)	RSS-210 A12	Frequency Tolerance	Compliant
§15.249 (b)(3)	RSS-210 A12	Antenna Performance	Compliant
§15.249(a)(d), §15.209	RSS-Gen §7.2.5 and RSS-210 A2.0	Spurious Emissions	Compliant
§15.247(i)	RSS-102	Maximum Permissible Exposure	Compliant

Table 1. Executive Summary of EMC Part 15.249 Compliance Testing

II. Equipment Configuration

A. Overview

MET Laboratories, Inc. was contracted by Exalt Wireless – San Jose to perform testing on the ExtendAir G2 24GHz (rc24020), under Exalt Wireless – San Jose’ purchase order number 109107.

This document describes the test setups, test methods, required test equipment, and the test limit criteria used to perform compliance testing of the Exalt Wireless – San Jose, ExtendAir G2 24GHz (rc24020).

The results obtained relate only to the item(s) tested.

Model(s) Tested:	ExtendAir G2 24GHz (rc24020)	
EUT Specifications:	Primary Power to Module: 48 VDC	
	FCC ID: TTM-124P05P IC: 6254A-124P05P	
	Equipment Code:	DXX
	Highest Fundamental Field Strength:	128 dBuV/m
	EUT Frequency Ranges:	24,000 – 24,250 MHz
Analysis:	The results obtained relate only to the item(s) tested.	
Environmental Test Conditions:	Temperature (15-35° C)	
	Relative Humidity (30-60%)	
	Barometric Pressure (860-1060 mbar)	
Evaluated by:	Kaushani Dasgupta	
Report Date(s):	March 10, 2016	

Table 2. EUT Specifications

Note: Device only supports channels one at a time. Here we are using three channels for the testing .

B. References

CFR 47, Part 15, Subpart C	Federal Communication Commission, Code of Federal Regulations, Title 47, Part 15: General Rules and Regulations, Allocation, Assignment, and Use of Radio Frequencies
RSS-210, Issue 8, December 2010	Low-power Licence-exempt Radiocommunications Devices (All Frequency Bands): Category I Equipment
RSS-102, Issue 5, March 2015	Radio Frequency (RF) Exposure Compliance of Radiocommunication Apparatus (All Frequency Bands)
ANSI C63.4:2014	Methods and Measurements of Radio-Noise Emissions from Low-Voltage Electrical And Electronic Equipment in the Range of 9 kHz to 40 GHz
ISO/IEC 17025:2005	General Requirements for the Competence of Testing and Calibration Laboratories
ANSI C63.10-2013	American National Standard for Testing Unlicensed Wireless Devices

Table 3. References

C. Test Site

All testing was performed at MET Laboratories, Inc., 3162 Belick St., Santa Clara, CA 95054. All equipment used in making physical determinations is accurate and bears recent traceability to the National Institute of Standards and Technology.

Radiated Emissions measurements were performed in a semi-anechoic chamber (equivalent to an Open Area Test Site). In accordance with §2.948(a)(3), a complete site description is contained at MET Laboratories.

D. Description of Test Sample

The all-outdoor ExtendAir G2 24GHz system is a high performance, point-to-point Gigabit Ethernet radio built for use in 24GHz un-licensed bands. Designed to deliver guaranteed full-duplex Ethernet throughput of up to 370 Mbps for short-haul and medium-range applications, the ExtendAir G2 24GHz all-outdoor radio is rugged, zero footprint systems requiring no cabinet space. Exalt’s ExtendAir G2 yields a cost-effective, yet feature-rich radio solution for service provider and enterprise applications where high reliability transmission is critical.

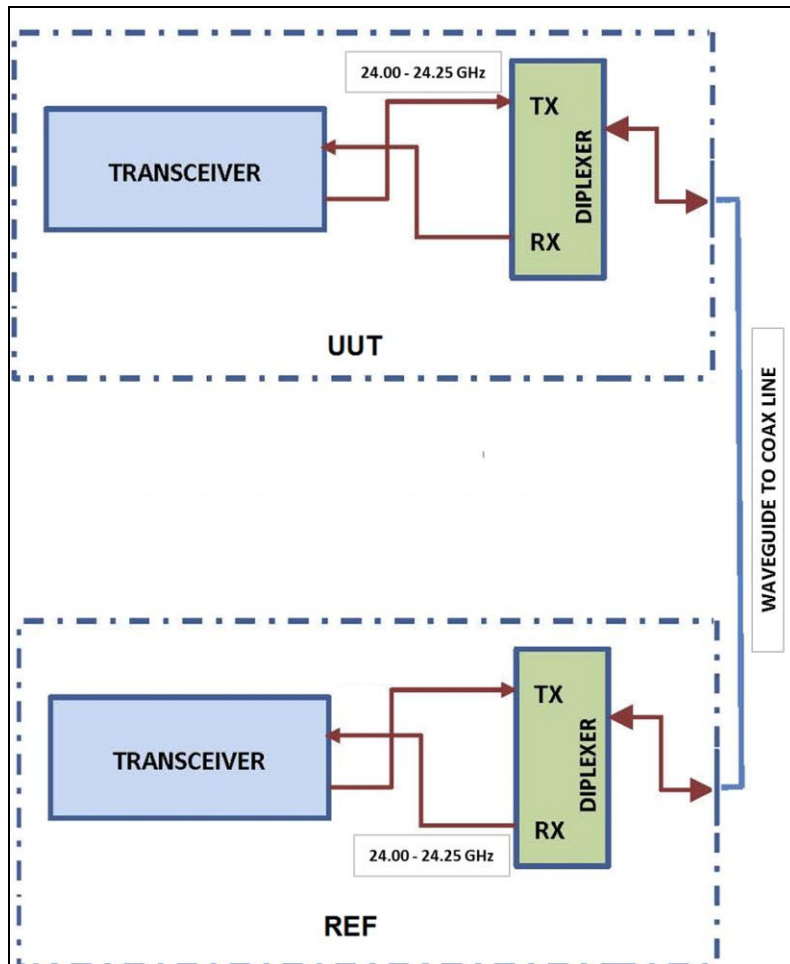

Figure 1. Block Diagram of EUT Configuration 1

E. Equipment Configuration

Ref. ID	Name / Description	Model Number
DUT	ExtendAir G2 24GHz	rc24020
PoE	GIGE PoE INJECTOR	201348-005
Power Supply	MEPOS POWER SUPPLY	SPU131-112
CAT 5 CABLE	RG-485 CAT5 CABLE	COMM/PoE
CAT 5 CABLE	RG-485 CAT5 CABLE	COMM. TERMINATED

Table 4. Equipment Configuration

F. Support Equipment

Ref. ID	Name / Description	Manufacturer	Model Number
REFERENCE	ExtendAir G2 24GHz	Exalt Wireless	rc24020
INTERFERER	ExtendAir G2 24GHz	Exalt Wireless	rc24020
PoE	GIGE PoE INJECTOR	Exalt Wireless	201348-005
POWER SUPPLY	MEPOS POWER SUPPLY	--	SPU131-112

Table 5. Support Equipment

G. Ports and Cabling Information

Ref. ID	Port name on EUT	Cable Description or reason for no cable	Qty.	Length as tested (m)	Shielded? (Y/N)	Termination Box ID & Port Name
1	POWER / ETH 1	CAT5 CABLE	1	2	Y	PoE DATA+POWER
2	EXP (EXPANSION)	CAT5 TERMINATED 100OHMS	2	3	Y	N.A.
3	N.A.	CAT5 NOT PROVIDED	0	ANY	N	1000BaseT DATA

Table 6. Ports and Cabling Information

H. Mode of Operation

There are multiple bandwidths of operation. 3.5/5/7/10/14/20/25/28/30/40/50/56MHz wide and 6 modes of operation with modulations of QPSK, 16QAM, 32QAM, 64QAM, 128QAM AND 256QAM.

Both BW and Modulation can be configured using the user interface (GUI) for the allowed combination.

Note: Out of all the modes stated above, since the customer wanted us to use the highest and lowest data rate that's why we used QPSK and QAM data rate. And that's how high it went for the above given bandwidths.

I. Modifications

a) Modifications to EUT

No modifications were made to the EUT.

b) Modifications to Test Standard

No modifications were made to the test standard.

J. Disposition of EUT

The test sample including all support equipment submitted to the Electro-Magnetic Compatibility Lab for testing was returned to Exalt Wireless - San Jose upon completion of testing.

III. Electromagnetic Compatibility Criteria for Intentional Radiators

Electromagnetic Compatibility Criteria for Intentional Radiators

§ 15.203 Antenna Requirement

Test Requirement: § 15.203: An intentional radiator shall be designed to ensure that no antenna other than that furnished by the responsible party shall be used with the device. The use of a permanently attached antenna or of an antenna that uses a unique coupling to the intentional radiator shall be considered sufficient to comply with the provisions of this section. The manufacturer may design the unit so that a broken antenna can be replaced by the user, but the use of a standard antenna jack or electrical connector is prohibited.

The structure and application of the EUT were analyzed to determine compliance with Section 15.203 of the Rules. Section 15.203 states that the subject device must meet at least one of the following criteria:

- a.) Antenna must be permanently attached to the unit.
- b.) Antenna must use a unique type of connector to attach to the EUT.
- c.) Unit must be professionally installed. Installer shall be responsible for verifying that the correct antenna is employed with the unit.

Test Results: The EUT as tested is compliant with the criteria of §15.203. In general requirements of the part 15 devices, by inspection of the device it can be declared that the unit is compatible with one of the requirement of Section 15.203. And the unit is professionally installed and the installer did verify that the correct antenna is employed with the unit.

Test Engineer(s): Kaushani Dasgupta

Test Date(s): 10/09/15

Electromagnetic Compatibility Criteria for Intentional Radiators

§ 15.207(a) Conducted Emissions Limits

Test Requirement(s): § 15.207 (a): For an intentional radiator that is designed to be connected to the public utility (AC) power line, the radio frequency voltage that is conducted back onto the AC power line on any frequency or frequencies, within the band 150 kHz to 30MHz, shall not exceed the limits in the following table, as measured using a 50 μ H/50 Σ line impedance stabilization network (LISN). Compliance with the provisions of this paragraph shall be based on the measurement of the radio frequency voltage between each power line and ground at the power terminal. The lower limit applies at the boundary between the frequency ranges.

Frequency range (MHz)	§ 15.207(a), Conducted Limit (dB μ V)	
	Quasi-Peak	Average
* 0.15- 0.45	66 - 56	56 - 46
0.45 - 0.5	56	46
0.5 - 30	60	50

Table 7. Conducted Limits for Intentional Radiators from FCC Part 15 § 15.207(a)

Test Procedure: The EUT was placed on a 0.8 m-high wooden table inside a screen room. The EUT was situated such that the back of the EUT was 0.4 m from one wall of the vertical ground plane, and the remaining sides of the EUT were no closer than 0.8 m from any other conductive surface. The EUT was powered from a 50 Ω /50 μ H Line Impedance Stabilization Network (LISN). The EMC receiver scanned the frequency range from 150 kHz to 30 MHz. Conducted Emissions measurements were made in accordance with *ANSI C63.4-2014 "Methods and Measurements of Radio-Noise Emissions from Low-Voltage Electrical and Electronic Equipment in the Range of 9kHz to 40 GHz"*. The measurements were performed over the frequency range of 0.15 MHz to 30 MHz using a 50 Ω /50 μ H LISN as the input transducer to an EMC/field intensity meter. For the purpose of this testing, the transmitter was turned on. Scans were performed with the transmitter on.

Test Results: The EUT was compliant with this requirement.

Test Engineer(s): Kaushani Dasgupta

Test Date(s): 09/30/15

15.207(a) Conducted Emissions Test Results

Line	Freq. (MHz)	QP Amplitude	QP Limit	Delta	Pass	Average Amplitude	Average Limit	Delta	Pass
Line1	3.013	52.16	73	-20.84	Pass	36.45	60	-23.55	Pass
Line1	3.082	51.38	73	-21.62	Pass	35.58	60	-24.42	Pass
Line1	11.348	53.64	73	-19.36	Pass	50.82	60	-9.18	Pass
Line1	11.972	47.5	73	-25.5	Pass	41.5	60	-18.5	Pass
Line1	12.321	57.31	73	-15.69	Pass	55.87	60	-4.13	Pass
Line1	12.710	55.4	73	-17.6	Pass	53.14	60	-6.86	Pass

Table 8. Conducted Emissions, 15.207(a), Phase Line, Test Results

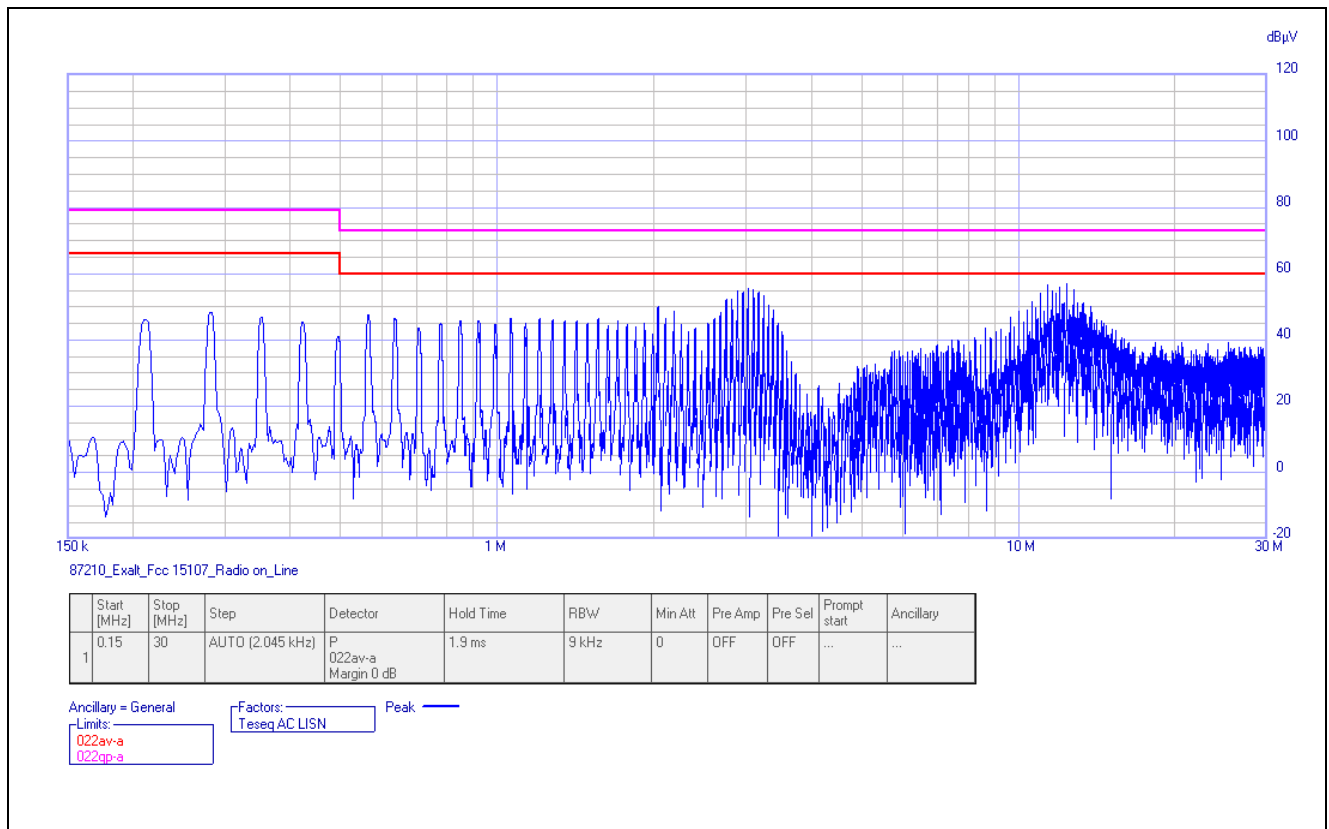

Plot 1. Conducted Emissions, 15.207(a), Phase Line

15.207(a) Conducted Emissions Test Results

Line	Freq. (MHz)	QP Amplitude	QP Limit	Delta	Pass	Average Amplitude	Average Limit	Delta	Pass
Neutral	11.041	40.49	73	-32.51	Pass	34.49	60	-25.51	Pass
Neutral	11.348	50.62	73	-22.38	Pass	47.54	60	-12.46	Pass
Neutral	11.8065	43.77	73	-29.23	Pass	37.82	60	-22.18	Pass
Neutral	12.319	54.23	73	-18.77	Pass	52.72	60	-7.28	Pass
Neutral	12.714	53.88	73	-19.12	Pass	51.99	60	-8.01	Pass
Neutral	12.908	51.63	73	-21.37	Pass	48.81	60	-11.19	Pass

Table 9. Conducted Emissions, 15.207(a), Neutral Line, Test Results

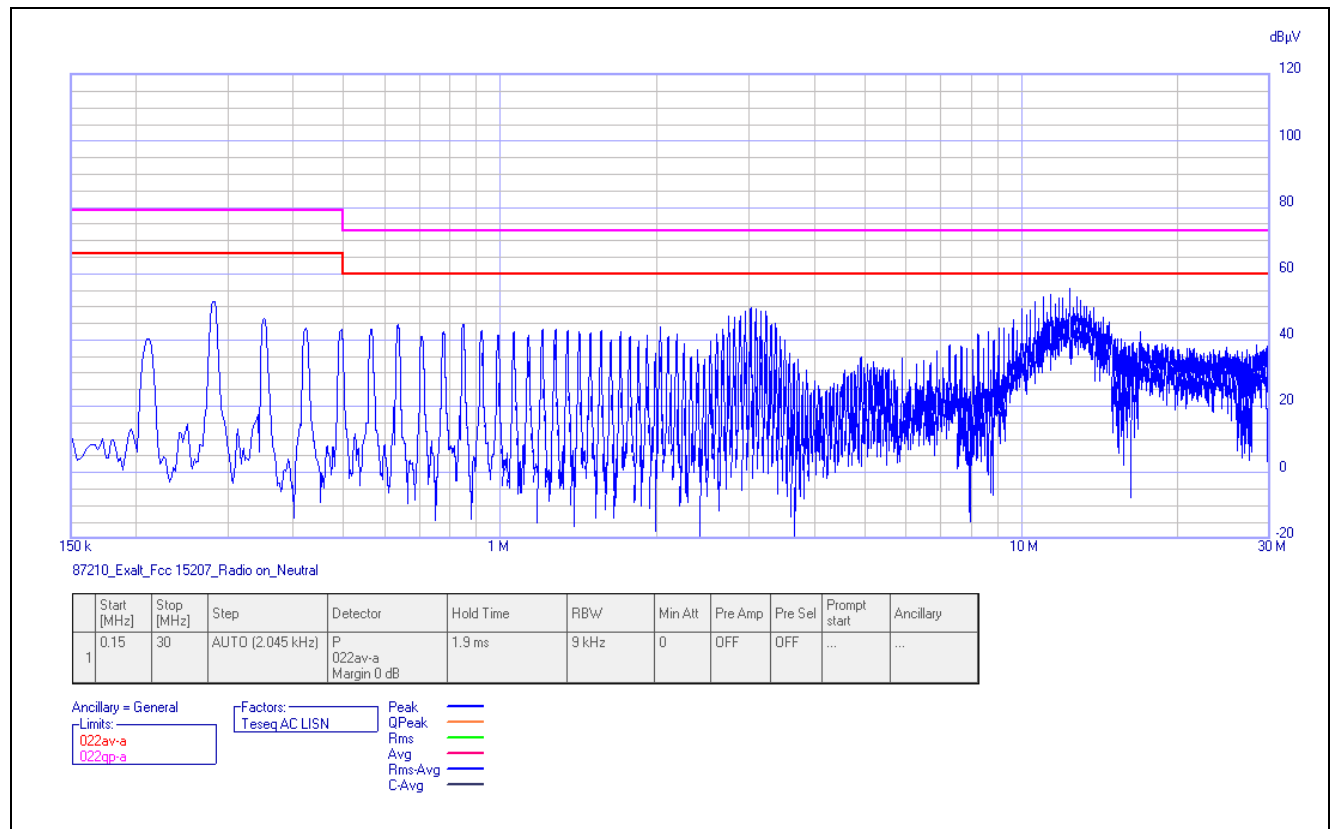

Plot 2. Conducted Emissions, 15.207(a), Neutral Line

15.207(a) Conducted Emissions Test Setup Photo

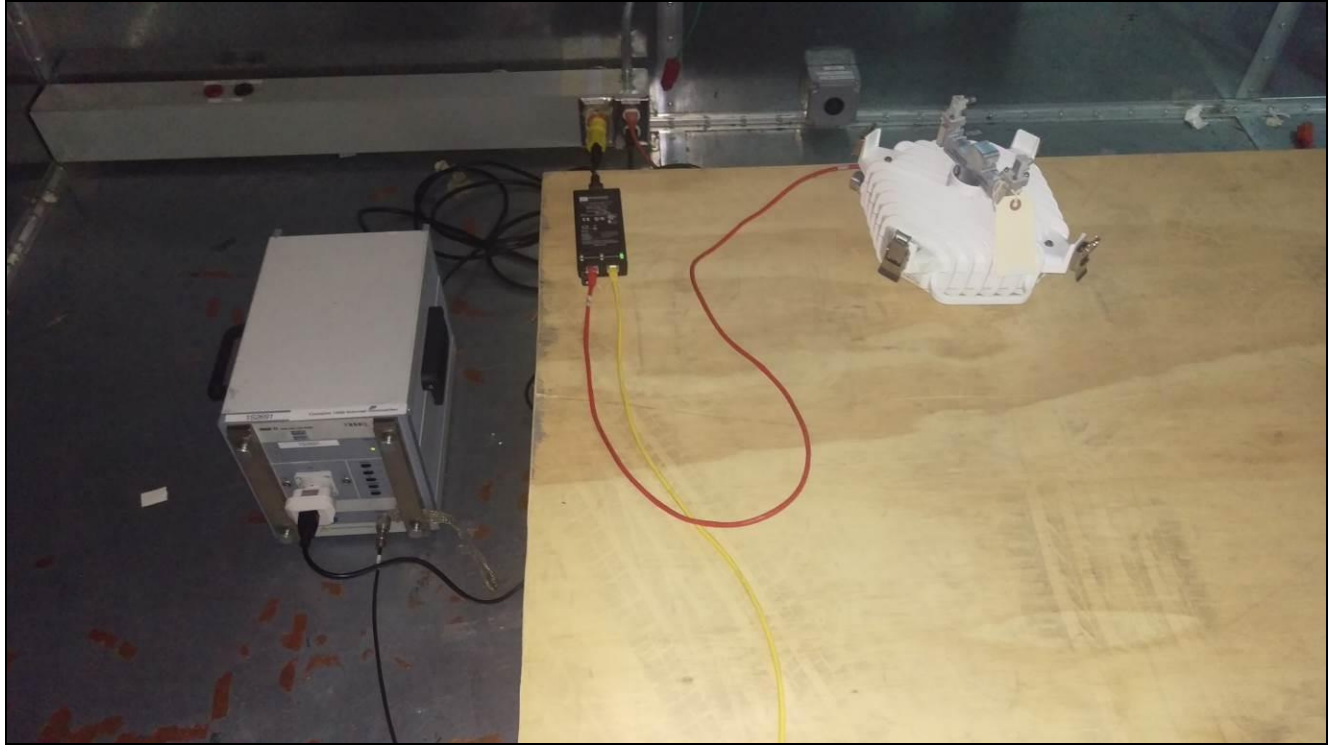

Photograph 1. Conducted Emissions, 15.207(a), Test Setup

Electromagnetic Compatibility Criteria for Intentional Radiators

§15.249(b)(1) Radiated Field Strength of Fundamental

Test Requirements: § 15.249(b)(1): Fixed, point-to-point operation as referred to in this paragraph shall be limited to systems employing a fixed transmitter transmitting to a fixed remote location. Point-to-multipoint systems, omnidirectional applications, and multiple co-located intentional radiators transmitting the same information are not allowed. Fixed, point-to-point operation is permitted in the 24.05–24.25 GHz band subject to the following conditions:

The field strength of emissions in this band shall not exceed 2500 millivolts/meter.

Test Procedure: Measurements were performed with the EUT rotated 360 degrees and varying the adjustable antenna mast with 1 m to 4 m height to determine worst case orientation for maximum emissions. The antenna was placed 3m away from the EUT. The EUT was rotated about all three orthogonal axis. Therefore the field strength limit is based on a 3m distance.

Test Results: The EUT is compliant with the requirements of § 15.249(b)(1).

Test Engineer(s): Ajaz Khan

Test Date(s): 11/09/15

Bandwidth/Modulation	Carrier Channel	Frequency (MHz)	Measured Peak Field Strength (dBuV/m)	Margin (dB)
5Mhz/128QAM	Low	24075	127.04	-0.96
	Mid	24175	126.88	-1.12
	High	24225	127.32	-0.68

Table 10. Field Strength of Fundamental, 5 MHz

Note: Field Strength of Fundamental Limit = 2500 mV/m = 2,500,000 uV/m
 $= 20 \log (2,500,000)$
 Field Strength of Fundamental Limit = 128 dBuV/m

Bandwidth/Modulation	Carrier Channel	Frequency (MHz)	Measured Peak Field Strength (dBuV/m)	Margin (dB)
10MHz/256QAM	Low	24075	126.13	-1.87
	Mid	24175	126.09	-1.91
	High	24225	126.48	-1.52

Table 11. Field Strength of Fundamental, 10 MHz

Note: Field Strength of Fundamental Limit = 2500 mV/m = 2,500,000 uV/m
 $= 20 \log (2,500,000)$
 Field Strength of Fundamental Limit = 128 dBuV/m

Bandwidth/ Modulation	Carrier Channel	Frequency (MHz)	Measured Peak Field Strength (dBuV/m)	Margin (dB)
20MHz/256QAM	Low	24075	127.68	-0.32
	Mid	24175	127.15	-0.85
	High	24225	127.37	-0.63

Table 12. Field Strength of Fundamental, 20 MHz

Note: Field Strength of Fundamental Limit = 2500 mV/m = 2,500,000 uV/m
= 20 log (2,500,000)
Field Strength of Fundamental Limit = 128 dBuV/m

Bandwidth/ Modulation	Carrier Channel	Frequency (MHz)	Measured Peak Field Strength (dBuV/m)	Margin (dB)
25MHz/256QAM	Low	24075	126.79	-1.21
	Mid	24175	127.75	-0.25
	High	24225	127.7	-0.3

Table 13. Field Strength of Fundamental, 25 MHz

Note: Field Strength of Fundamental Limit = 2500 mV/m = 2,500,000 uV/m
= 20 log (2,500,000)
Field Strength of Fundamental Limit = 128 dBuV/m

Bandwidth/ Modulation	Carrier Channel	Frequency (MHz)	Measured Peak Field Strength (dBuV/m)	Margin (dB)
30MHz/256QAM	Low	24075	127.63	-0.37
	Mid	24175	127.67	-0.33
	High	24225	127.75	-0.25

Table 14. Field Strength of Fundamental, 30MHz

Note: Field Strength of Fundamental Limit = 2500 mV/m = 2,500,000 uV/m
= 20 log (2,500,000)
Field Strength of Fundamental Limit = 128 dBuV/m

Bandwidth/ Modulation	Carrier Channel	Frequency (MHz)	Measured Peak Field Strength (dBuV/m)	Margin (dB)
40MHz/256QAM	Low	24075	126.28	-1.72
	Mid	24175	126.8	-1.2
	High	24225	127.74	-0.26

Table 15. Field Strength of Fundamental, 40MHz

Note: Field Strength of Fundamental Limit = 2500 mV/m = 2,500,000 uV/m
= 20 log (2,500,000)
Field Strength of Fundamental Limit = 128 dBuV/m

Bandwidth/ Modulation	Carrier Channel	Frequency (MHz)	Measured Peak Field Strength (dBuV/m)	Margin (dB)
50MHz/256QAM	Low	24075	126.21	-1.79
	Mid	24175	125.5	-2.5
	High	24225	127.94	-0.06

Table 16. Field Strength of Fundamental, 50MHz

Note: Field Strength of Fundamental Limit = 2500 mV/m = 2,500,000 uV/m
 = 20 log (2,500,000)
 Field Strength of Fundamental Limit = 128 dBuV/m

Note: Due to the higher field strength limit for this device, a MPE section with an RF Exposure Evaluation is also calculated to make sure the public is not exposed to radio frequency energy levels.

Field Strength of Fundamental, 5 MHz

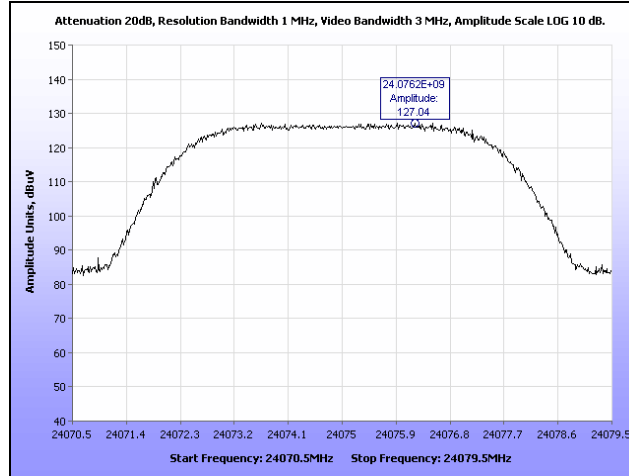

Plot 3. Radiated Field Strength of Fundamental, 5 MHz, Low Channel

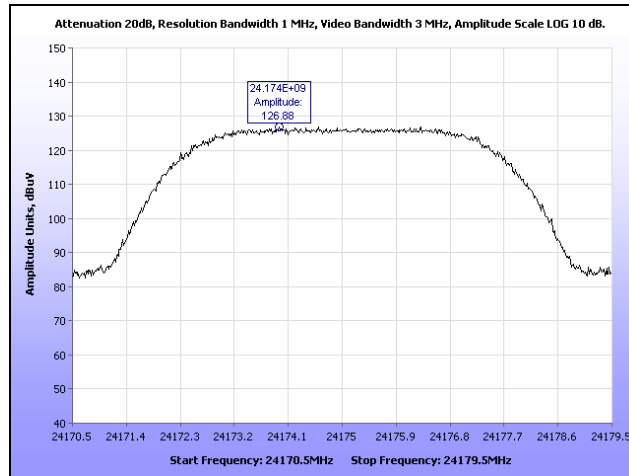

Plot 4. Radiated Field Strength of Fundamental, 5 MHz, Mid Channel

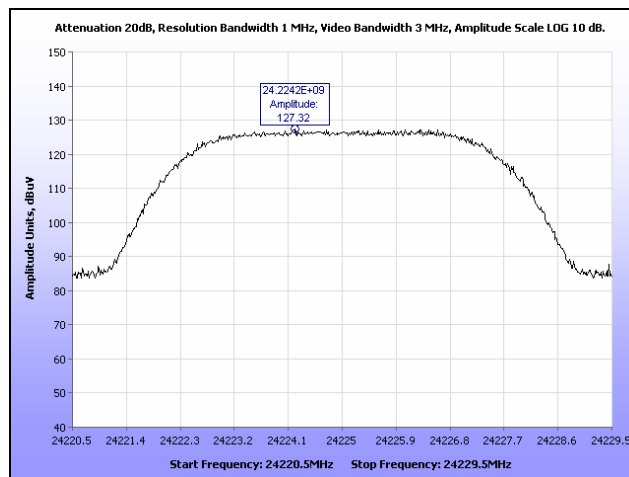

Plot 5. Radiated Field Strength of Fundamental, 5 MHz, High Channel

Field Strength of Fundamental, 10 MHz

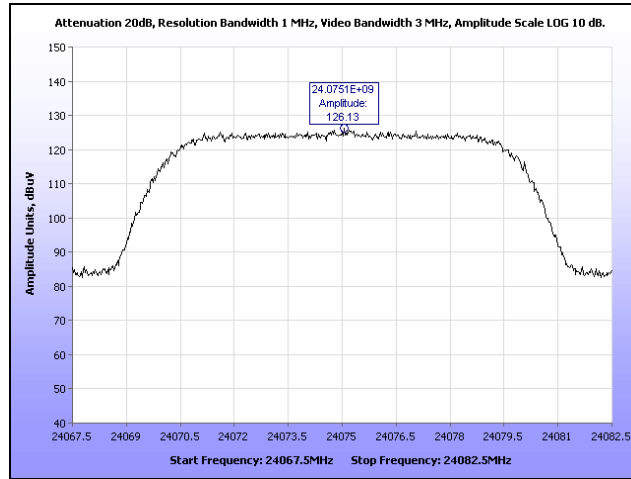

Plot 6. Radiated Field Strength of Fundamental, 10 MHz, Low Channel

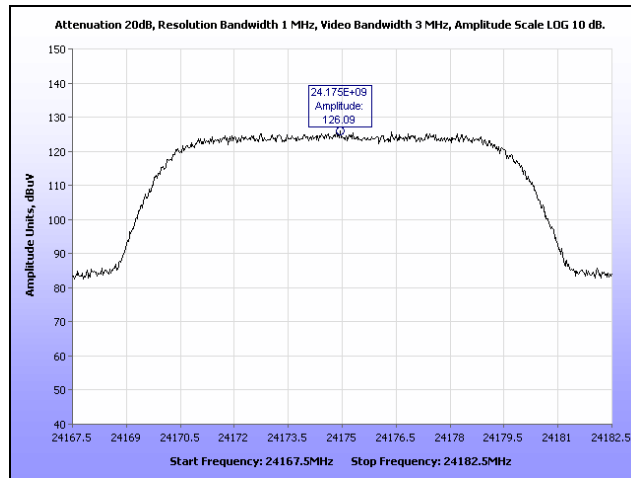

Plot 7. Radiated Field Strength of Fundamental, 10 MHz, Mid Channel

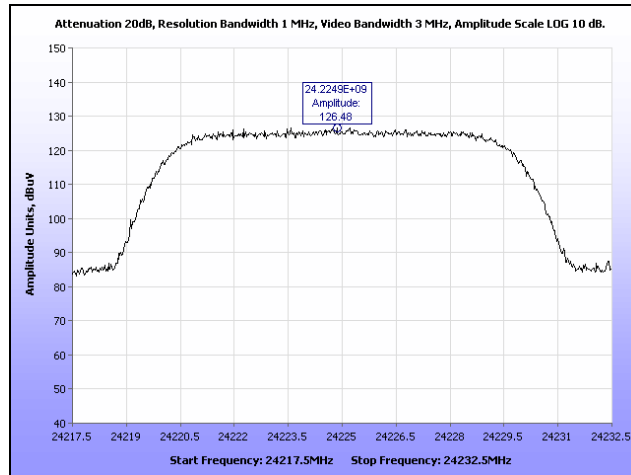

Plot 8. Radiated Field Strength of Fundamental, 10 MHz, High Channel

Field Strength of Fundamental, 20 MHz

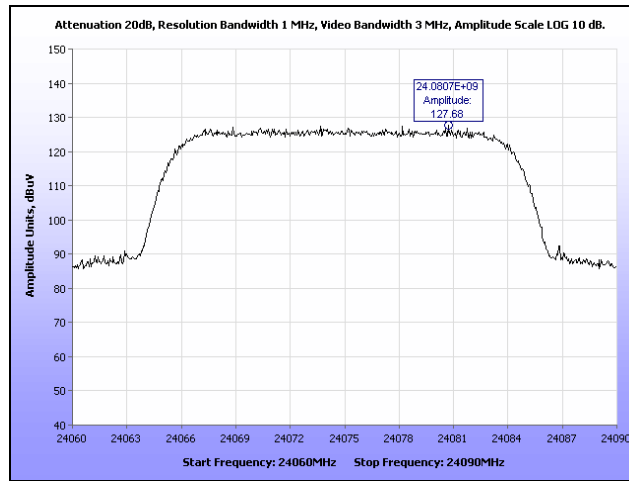

Plot 9. Radiated Field Strength of Fundamental, 20 MHz, Low Channel

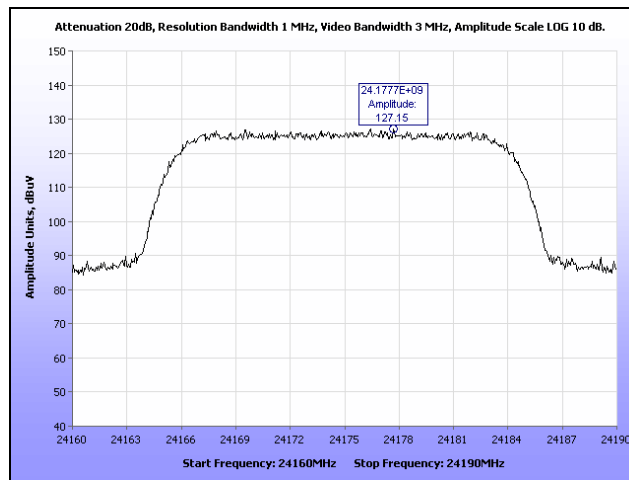

Plot 10. Radiated Field Strength of Fundamental, 20 MHz, Mid Channel

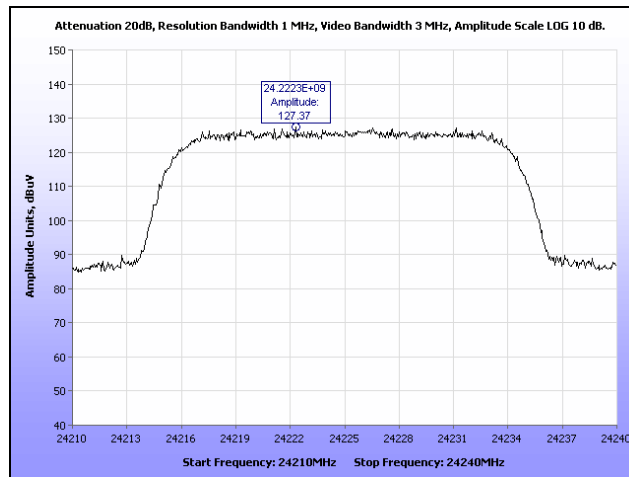

Plot 11. Radiated Field Strength of Fundamental, 20 MHz, High Channel

Field Strength of Fundamental, 25 MHz

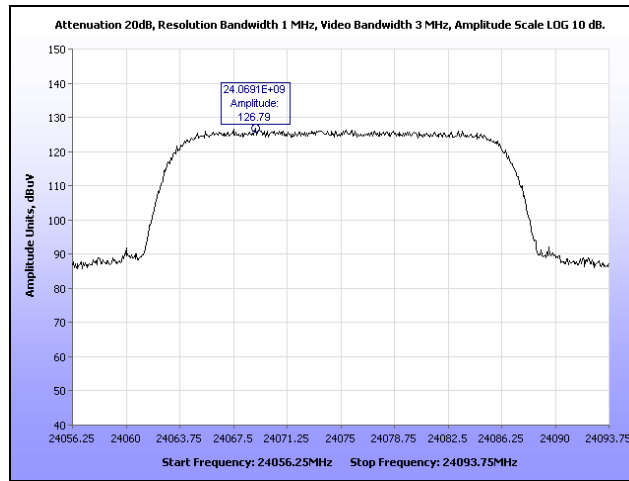

Plot 12. Radiated Field Strength of Fundamental, 25 MHz, Low Channel

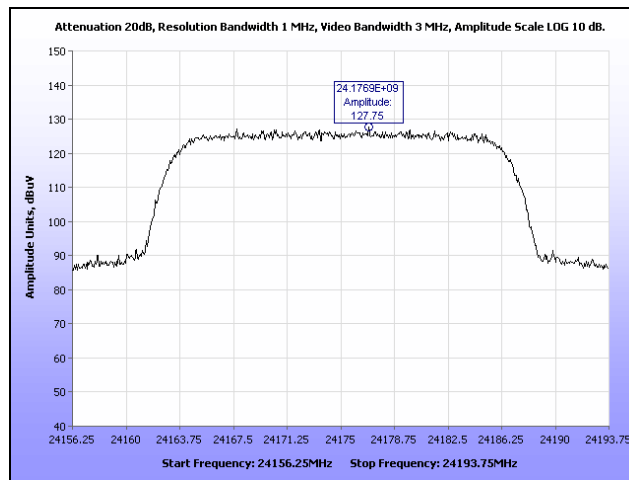

Plot 13. Radiated Field Strength of Fundamental, 25 MHz, Mid Channel

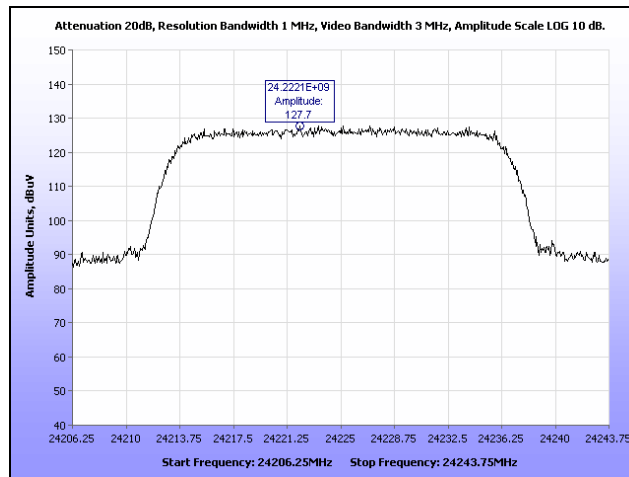

Plot 14. Radiated Field Strength of Fundamental, 25 MHz, High Channel

Field Strength of Fundamental, 30 MHz

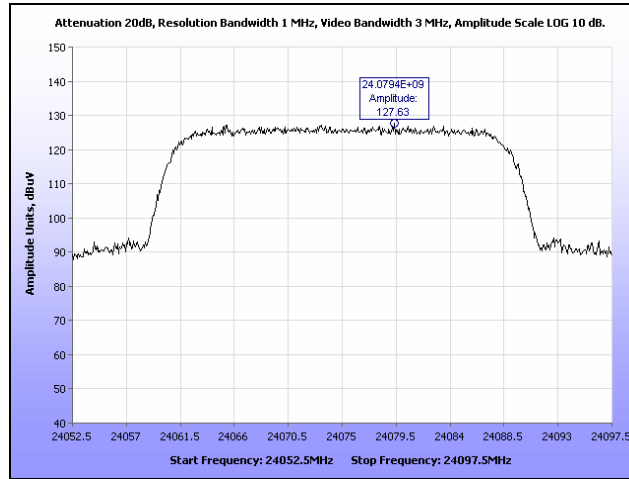

Plot 15. Radiated Field Strength of Fundamental, 30 MHz, Low Channel

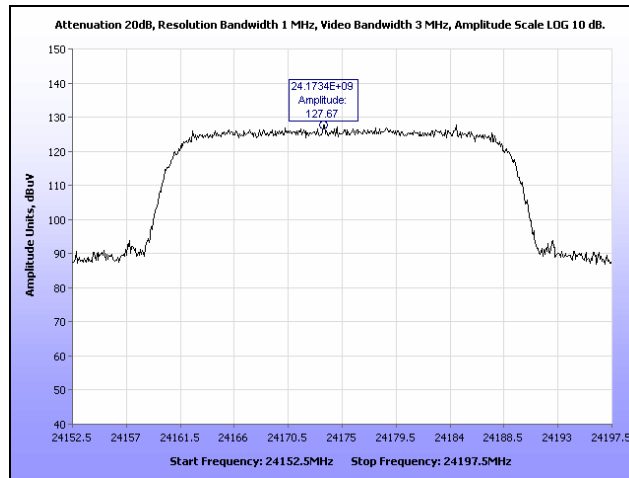

Plot 16. Radiated Field Strength of Fundamental, 30 MHz, Mid Channel

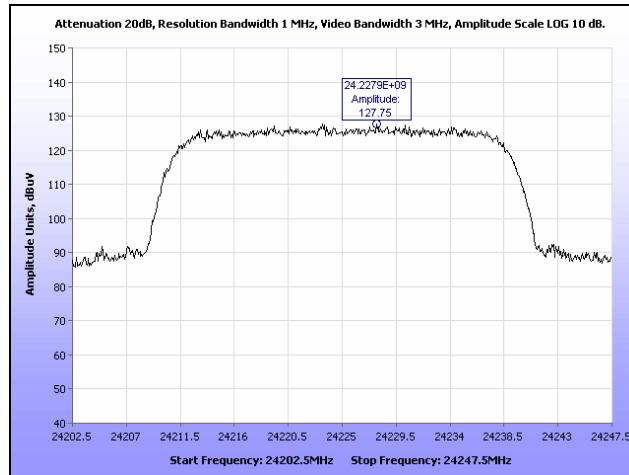

Plot 17. Radiated Field Strength of Fundamental, 30 MHz, High Channel

Field Strength of Fundamental, 40 MHz

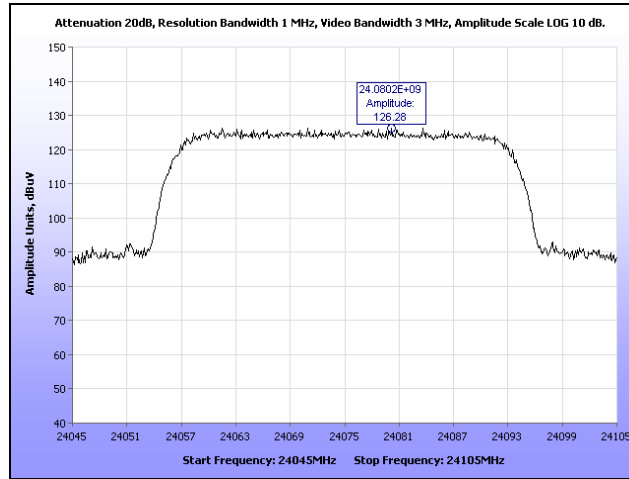

Plot 18. Radiated Field Strength of Fundamental, 40 MHz, Low Channel

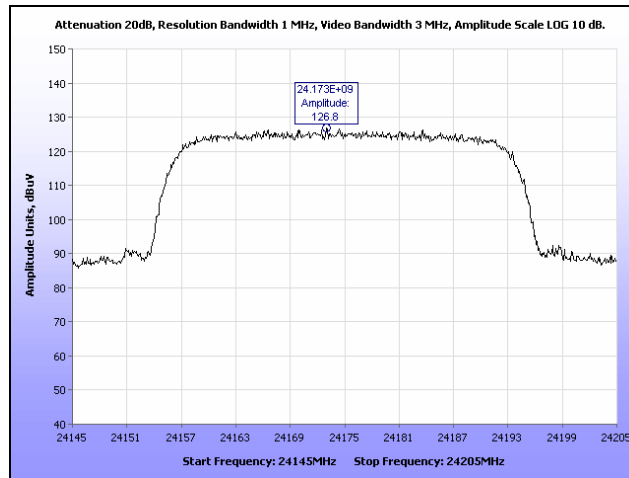

Plot 19. Radiated Field Strength of Fundamental, 40 MHz, Mid Channel

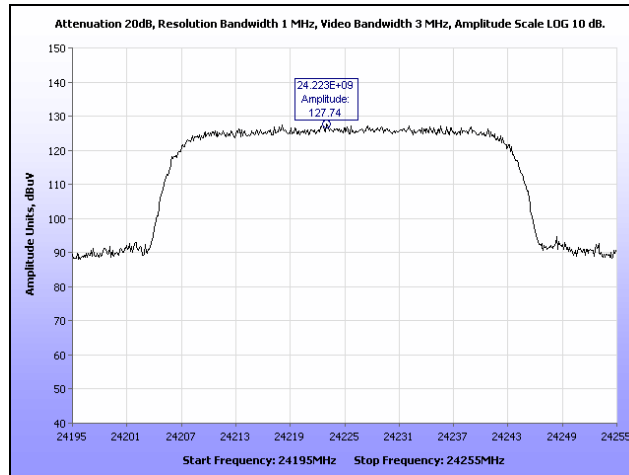

Plot 20. Radiated Field Strength of Fundamental, 40 MHz, High Channel

Field Strength of Fundamental, 50 MHz

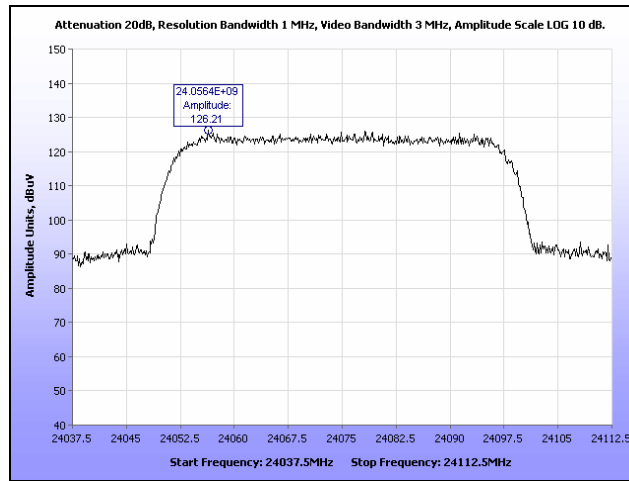

Plot 21. Radiated Field Strength of Fundamental, 50 MHz, Low Channel

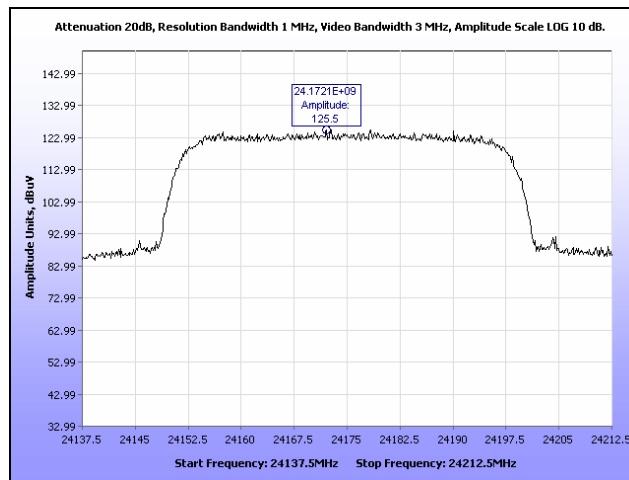

Plot 22. Radiated Field Strength of Fundamental, 50 MHz, Mid Channel

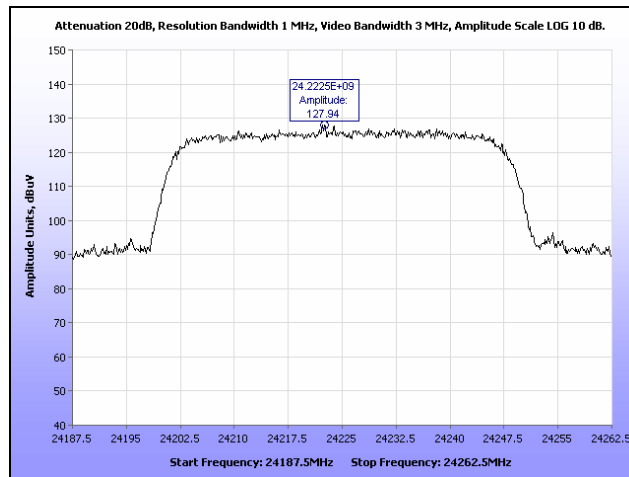

Plot 23. Radiated Field Strength of Fundamental, 50 MHz, High Channel

Maximum Permissible Exposure

RF Exposure Requirements: §1.1307(b)(1) and §1.1307(b)(2): Systems operating under the provisions of this section shall be operated in a manner that ensures that the public is not exposed to radio frequency energy levels in excess of the Commission’s guidelines.

RF Radiation Exposure Limit: §1.1310: As specified in this section, the Maximum Permissible Exposure (MPE) Limit shall be used to evaluate the environmental impact of human exposure to radiofrequency (RF) radiation as specified in Sec. 1.1307(b), except in the case of portable devices which shall be evaluated according to the provisions of Sec. 2.1093 of this chapter.

MPE Limit: **Limit for Uncontrolled exposure: 1 mW/cm² or 10 W/m²**

$$S = PG / 4\pi R^2 \quad \text{or} \quad R = \sqrt{PG / 4\pi S}$$

where, S = Power Density (mW/cm²)
 P = Power Input to antenna (mW)
 G = Antenna Gain (numeric value)
 R = Distance (cm)

Test Results:

The highest field strength calculated in the above section is : 127.94 dBuV/m
 Therefore,

$$\begin{aligned} \text{EIRP} &= \text{Field strength} + 20 \log(d/1) - 104.77 \\ &= 127.94 + 20 \log(3/1) - 104.77 \\ &= 32.712 \text{ dBm} \\ &= 1.8672 \text{ watt or } 1867.2 \text{ mW} \end{aligned}$$

Since EIRP = Conducted power (P) * Antenna Gain (G)
 PG = 1867.2 mW

Now according to the formula given above to calculate the MPE,

$$S = PG / 4\pi R^2,$$

Where,

$$PG = 1867.2 \text{ mW}, R = 20 \text{ cm}$$

$$\begin{aligned} &= 1867.2 / 4 * 3.14 * 20^2 \\ &= \mathbf{0.371 \text{ mW/cm}^2} \end{aligned}$$

Therefore , the MPE is less than the exposure limit (1mW/cm²) .

The safe distance where Power Density is less than the MPE Limit listed above was found to be 20 cm.

Electromagnetic Compatibility Criteria for Intentional Radiators

§15.249(b)(2) Frequency Tolerance

Test Requirements: § 15.249(b)(2): The frequency tolerance of the carrier signal shall be maintained within ±0.001% of the operating frequency over a temperature variation of -20 degrees to +50 degrees C at normal supply voltage, and for a variation in the primary supply voltage from 85% to 115% of the rated supply voltage at a temperature of 20 degrees C. For battery operated equipment, the equipment tests shall be performed using a new battery.

Test Procedure: The EUT was placed in the Environmental Chamber and support equipment are outside the chamber on a table. A CW signal was injected into the EUT at the appropriate RF level. The frequency counter option on the Spectrum Analyzer was used to measure frequency deviations. The frequency drift was investigated for every 10° C increment until the unit is stabilized then recorded the reading in tabular format with the temperature range of -20° to +50° C.

Voltage supplied to EUT is 120 VAC reference temperature was done at 20° C. The voltage was varied by ± 15 % of nominal.

Test Results: The EUT is compliant with the requirements of § 15.249(b)(2).

Test Engineer(s): Kaushani Dasgupta

Test Date(s): 09/30/15

Note: As per the Standard: Frequency tolerance of the carrier signal shall be maintained and should lie within ±0.001% of the operating frequency.

Therefore limit for maximum allowable drift would be = $0.001 * 24075 / 100 = 0.24075$ MHz

Operating Low Frequency Channel = 24075.000 MHz

Low channel (24.075 GHz)						
Reference Frequency :120V @ 20C	Volta ge	Temperat ure	Frequency tolerance measured	Drift (Ref Freq- Freq measured)= Delta MHz	Max allowable Drift Limit (MHz)	Comment
24075.0000 MHz	138	50	24074.96625	-0.03375	0.24075	Compliant
	120	50	24075.055	0.055	0.24075	Compliant
	102	50	24074.99625	-0.00375	0.24075	Compliant
	138	20	24075.02625	0.02625	0.24075	Compliant
	120	20	24075.0525	0.0525	0.24075	Complaint
	102	20	24075.08375	0.08375	0.24075	Compliant
	138	-20	24075.0625	0.0625	0.24075	Compliant
	120	-20	24075.03625	0.03625	0.24075	Compliant
	102	-20	24075.07375	0.07375	0.24075	Compliant

Table 17. Frequency Tolerance, Low Band

Limit for maximum allowable drift would be = $0.001 * 24175 / 100 = 0.24175$ MHz
Operating Mid Frequency Channel = 24175.000 MHz

Mid channel (24.175 GHz)						
Reference Frequency :120V @ 20C	Voltage	Temperature	Frequency Tolerance Measured	Drift (Ref Freq- Measured Freq)= Delta (MHz)	Max allowable Drift Limit (MHz)	Comment
24175.0000 MHz	138	50	24175.02875	0.02875	0.24175	Compliant
	120	50	24175.015	0.015	0.24175	Compliant
	102	50	24175.00375	0.00375	0.24175	Compliant
	138	20	24175.05375	0.05375	0.24175	Compliant
	120	20	24174.95375	-0.04625	0.24175	Complaint
	102	20	24174.945	-0.055	0.24175	Compliant
	138	-20	24175.055	0.055	0.24175	Compliant
	120	-20	24175.04875	0.04875	0.24175	Compliant
	102	-20	24175.06125	0.06125	0.24175	Compliant

Table 18. Frequency Tolerance, Mid Band

Limit for maximum allowable drift would be = $0.001 * 24225 / 100 = 0.24225$ MHz
Operating High Frequency Channel = 24225.000 MHz

High channel (24.225 GHz)						
Reference Frequency :120V @ 20C	Voltage	Temperature	Frequency Tolerance Measured	Drift (Ref Freq- Measured Freq)= Delta (MHz)	Max allowable Drift Limit (MHz)	Comment
24225.0000 MHz	138	50	24224.9975	-0.0025	0.24225	Compliant
	120	50	24224.9825	-0.0175	0.24225	Compliant
	102	50	24224.97	-0.03	0.24225	Compliant
	138	20	24225.04875	0.04875	0.24225	Compliant
	120	20	24225.04	0.04	0.24225	Complaint
	102	20	24225.035	0.035	0.24225	Compliant
	138	-20	24225.0925	0.0925	0.24225	Compliant
	120	-20	24225.08375	0.08375	0.24225	Compliant
	102	-20	24225.07625	0.07625	0.24225	Compliant

Table 19. Frequency Tolerance, High Band



Photograph 2. Frequency Tolerance, Test Setup

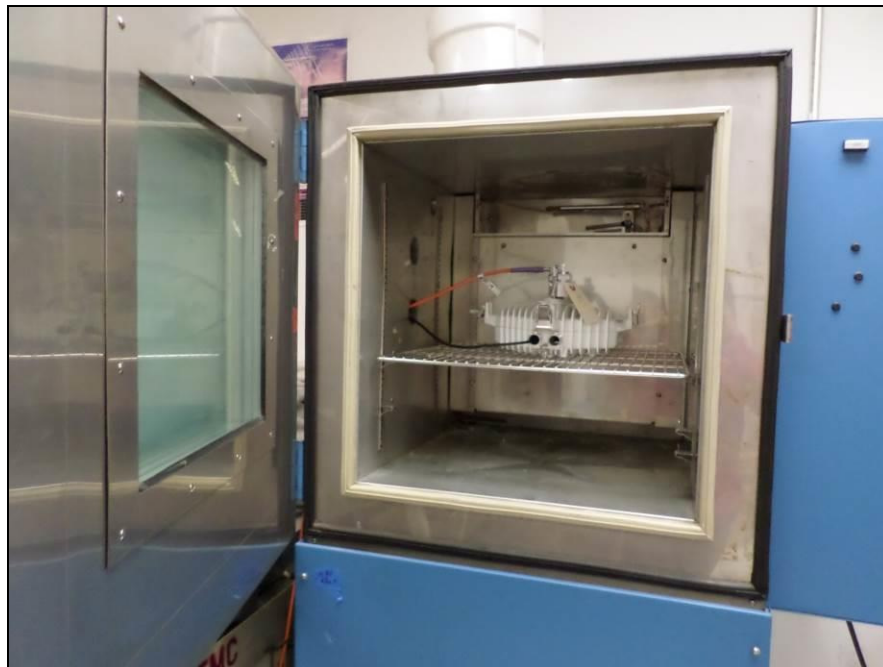

Photograph 3. Frequency Tolerance, Inside the Thermal Chamber with the Unit

Electromagnetic Compatibility Criteria for Intentional Radiators

§15.249(b)(3) Antenna Performance

Antenna used for testing: 0.6 mm(2ft dish) Ultra high performance low profile antenna with antenna gain 41dBi .

Test Requirements: § 15.249(b)(3): Antenna gain must be at least 33 dBi. Alternatively, the main lobe beamwidth must not exceed 3.5 degrees. The beamwidth limit shall apply to both the azimuth and elevation planes. At antenna gains over 33 dBi or beamwidths narrower than 3.5 degrees, power must be reduced to ensure that the field strength does not exceed 2500 millivolts/meter.

Test Results: The EUT is compliant with the requirements of § 15.249(b)(3). Since the gain of the antenna is way higher than 33dBi. The Antenna gains (dBi) of this device are: 36/41. Therefore it does comply with the requirement of the gain being at least 33dBi.

Test Engineer(s): Kaushani Dasgupta

Test Date(s): 10/19/15

||

||

0.3m (1ft) Ultra high Performance Low Profile antenna Specification

General Specifications



Diameter, nominal, m (ft)	0.3 (1)
Antenna Interface	ExtremeAir Integrated
Antenna Color	Light gray
Radome Color	Light gray
Radome Material Description	Anti-ultraviolet ABS material
Packing	Carton
RoHS 2002/95/EC	Compliant

Electrical Specifications

Antenna Type	WTC03-240DAR-QOETB
Frequency Band (GHz)	24.05~24.25
Interface	Integrated 0.334
Gain (dBi) , Low	36.3
Gain (dBi) , Mid	36.4
Gain (dBi) , High	36.5
3 dB BW (°)	2.5
VSWR	1.30
F/B Ratio (dB)	62
XPD (dB)	30
ETSI Standard	R4, C3

Microwave Antenna Specifications



Mechanical Specifications

Wind Velocity Operational, km/h	200
Wind Velocity Survival Rating, km/h	250
Coarse Azimuth, Degree	360
Fine Azimuth Adjustment, Degree	±15
Coarse Elevation, Degree	±10
Fine Elevation Adjustment, Degree	±15
Mounting Pipe Diameter, mm	φ51 ~ φ114
Feeder Watertightness	Watertight
Operation Pressurization, KPa	50
Operation Temperature, °C	-45 ~ +60
Storage Temperature, °C	-55 ~ +70
Ice Load, mm	25
Strengthening Rod	NA
Adjustable Rod	NA
Net Weight, kg	6±1
Gross Weight, Packed Antenna, kg	8±2
Packing Length, mm	500
Packing Width, mm	450
Packing Height, mm	320
Packing Volume, m ³	0.073

Microwave Antenna Specifications



Outline Dimensions

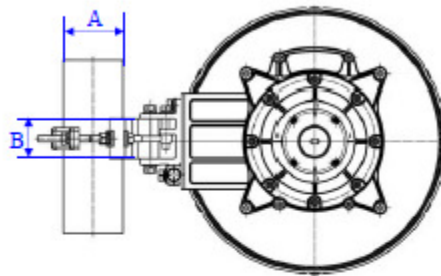

Antenna Dimensions, mm	
A	φ90 (φ51 ~ φ114)
B	60
C	φ402
D	226
E	200

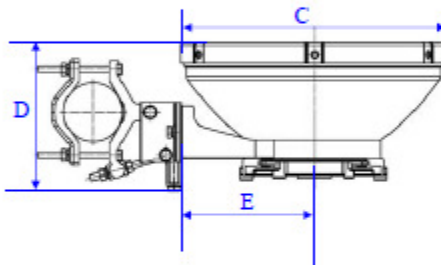

Microwave Antenna Specifications

Wind Forces

The axial, side and twisting moment forces stated are maximum loads applied to the tower by the antenna at a survival wind speed of 250 km/h (70m/s). They are, in every case, the result of wind from the most critical direction for each parameter. The individual maximums may not occur simultaneously. All forces are referenced to the antenna mounting pipe.

Axial Force (F_A Max.), N	470
Side Force (F_S Max.), N	230
Twisting Moment (M_T Max.), N-m	180
Angle α for M_T Max, Degree	-10

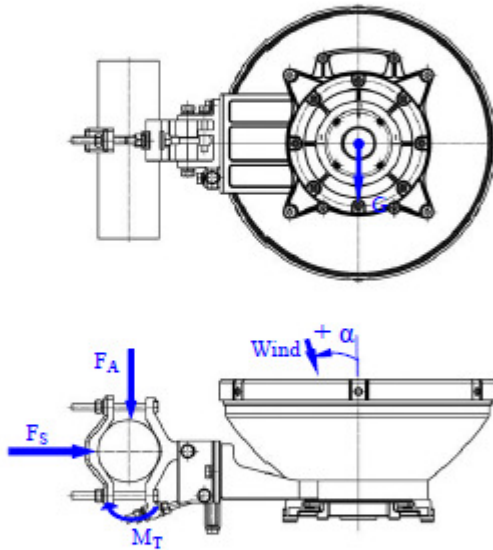

Microwave Antenna Specifications 

0.6m (2ft) Ultra high Performance Low Profile antenna Specification

General Specifications



Diameter, nominal, m (ft)	0.6 (2)
Antenna Interface	ExtremeAir Integrated
Antenna Color	Light gray
Radome Color	Light gray
Radome Material Description	Anti-ultraviolet ABS material
Packing	Carton
RoHS 2002/95/EC	Compliant

Electrical Specifications

Antenna Type	WTC06-240DAR- QOETB
Frequency Band (GHz)	24.05~24.25
Interface Integrated	0.334
Gain (dBi) , Low	40.9
Gain (dBi) , Mid	41.0
Gain (dBi) , High	41.1
3 dB BW (°)	1.4
VSWR	1.30
F/B Ratio (dB)	66
XPD (dB)	30
ETSI Standard	R4, C3

Microwave Antenna Specifications



Mechanical Specifications

Wind Velocity Operational, km/h	180
Wind Velocity Survival Rating, km/h	250
Coarse Azimuth, Degree	360
Fine Azimuth Adjustment, Degree	±15
Coarse Elevation, Degree	±10
Fine Elevation Adjustment, Degree	±15
Mounting Pipe Diameter, mm	φ51 ~ φ114
Feeder Watertightness	Watertight
Operation Pressurization, KPa	50
Operation Temperature, °C	-45 ~ +60
StOZTge Temperature, °C	-55 ~ +70
Ice Load, mm	25
Strengthening Rod	NA
Adjustable Rod	NA
Net Weight, kg	11±1
Gross Weight, Packed Antenna, kg	18±2
Packing Length, mm	750
Packing Width, mm	750
Packing Height, mm	440
Packing Volume, m ³	0.248

||
||
Microwave Antenna Specifications



Outline Dimensions

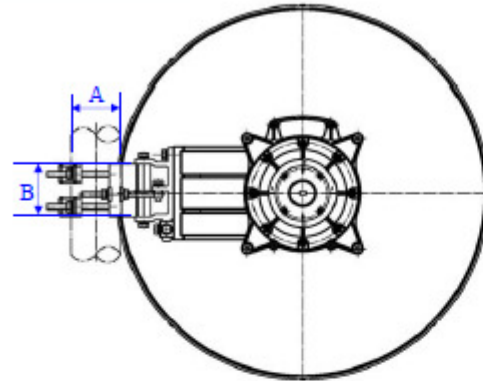

Antenna Dimensions, mm	
A	φ90(51 ~ φ114)
B	154
C	φ876
D	393
E	235

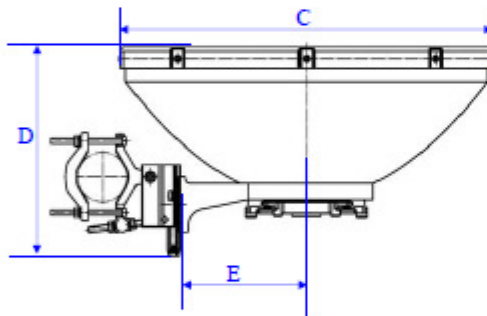

Microwave Antenna Specifications



Wind Forces

The axial, side and twisting moment forces stated are maximum loads applied to the tower by the antenna at a survival wind speed of 250 km/h (70m/s). They are, in every case, the result of wind from the most critical direction for each parameter. The individual maximums may not occur simultaneously. All forces are referenced to the antenna mounting pipe.

Axial Force (F_A Max.), N	1370
Side Force (F_S Max.), N	670
Twisting Moment (M_T Max.), N·m	530
Angle α for M_T Max, Degree	-10

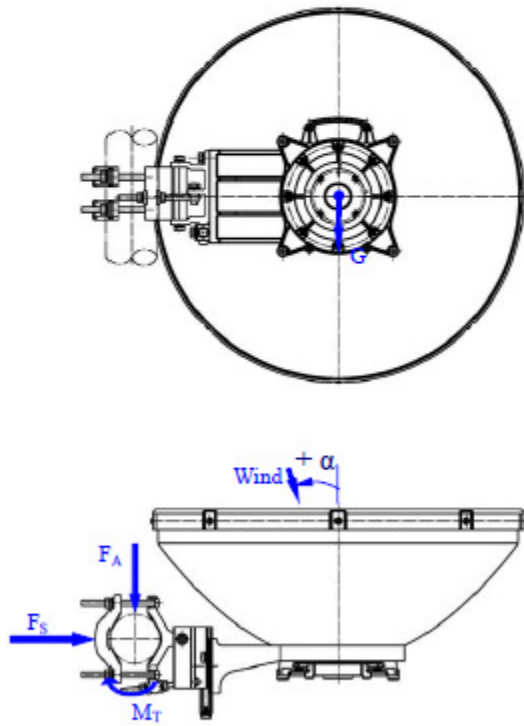

Electromagnetic Compatibility Criteria for Intentional Radiators

§ 15.249(a)(d) Spurious Emissions

- Test Requirements:** Harmonics originating from devices that operate in the 24.0-24.25 GHz band shall meet the 2500 microvolts/meter limit (i.e.68 dB μ V/m) with an average detector. In addition, emissions radiated outside of the specified frequency bands, except for harmonics, shall be attenuated by at least 50 dB below the level of the fundamental or to the general radiated emission limits in §15.209, whichever is the lesser attenuation.
- Test Procedure:** Measurements were performed with the EUT rotated 360 degrees and varying the adjustable antenna mast with 1 m to 4 m height to determine worst case orientation for maximum emissions. Emissions below 1 GHz were performed with the antenna placed 3m away from EUT. For above 1 GHz, the measuring antenna was placed 1m away. Measurements were performed from 30MHz to100GHz.
- Note:** For spurious emission measurements between 18GHz and 40GHz- two plots were demonstrated- one with added measurement correction factor and other without adding correction to final measurement. Since over all emission profile from both of these plots look identical, the only difference is the noise floor .In order to show that the reason for the emission plot to be above the limit is because of the noise floor and not coming from the unit.Hence ,we recorded the plots twice. Plot 1with the correction factors ON and the Plot 2 with the factors OFF. This shows that the difference in the plots is due to the noise floor and not the noise from the unit.
- Above 40 GHz, only peak measurements under average limit is being taken, since the worst case scenario is considered above 40 GHz.
- Test Results:** The EUT is compliant with the harmonics and Spurious Emissions Requirements of §15.249(a)(d).
- Test Engineer(s):** Kaushani Dasgupta
- Test Date(s):** 11/09/15

Radiated Spurious Emissions, 5 MHz

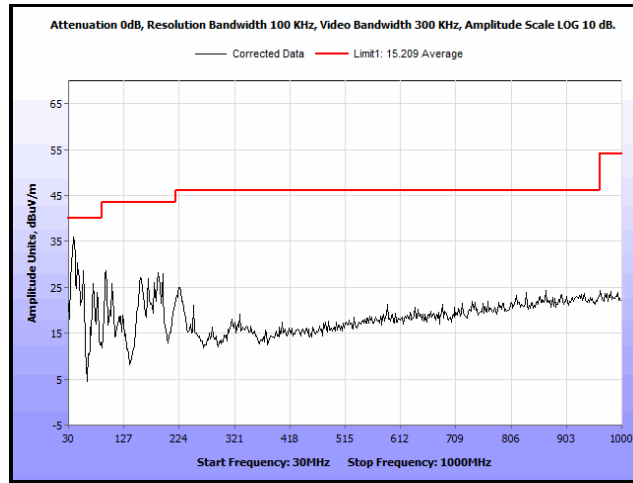

Plot 24. Radiated Spurious Emissions, 5 MHz, Low Channel, 30 MHz – 1 GHz

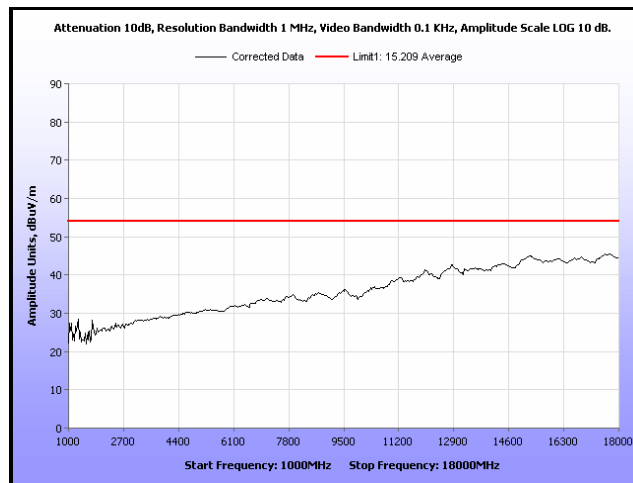

Plot 25. Radiated Spurious Emissions, 5 MHz, Low Channel, 1 GHz – 18 GHz, Average

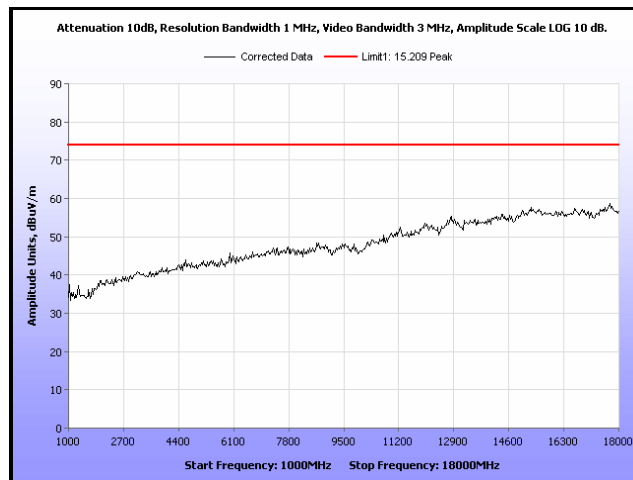

Plot 26. Radiated Spurious Emissions, 5 MHz, Low Channel, 1 GHz – 18 GHz, Peak

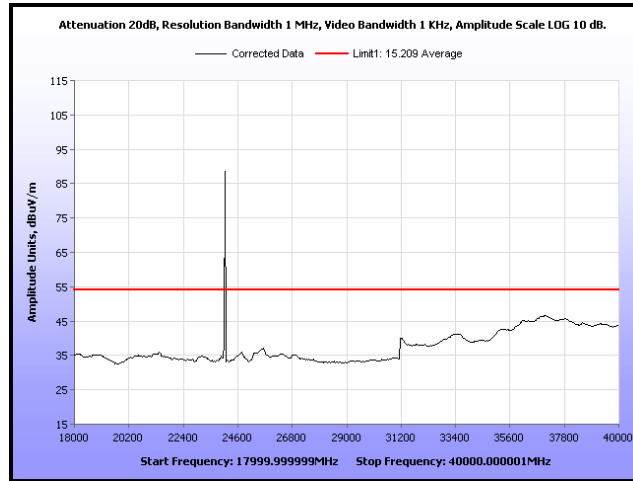

Plot 27. Radiated Spurious Emissions, 5 MHz, Low Channel, 18 GHz – 40 GHz, Average

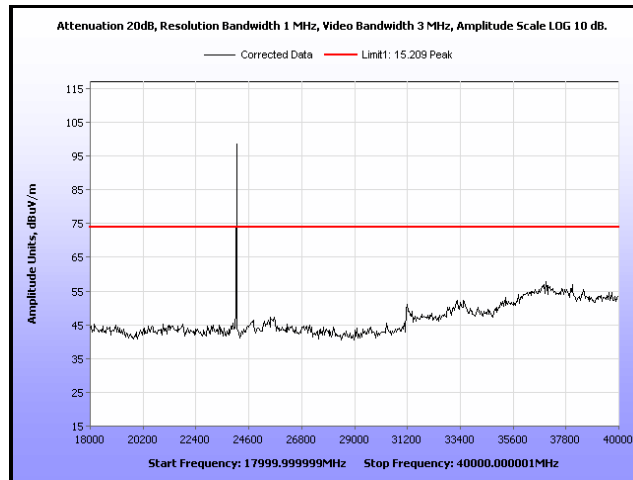

Plot 28. Radiated Spurious Emissions, 5 MHz, Low Channel, 18 GHz – 40 GHz, Peak

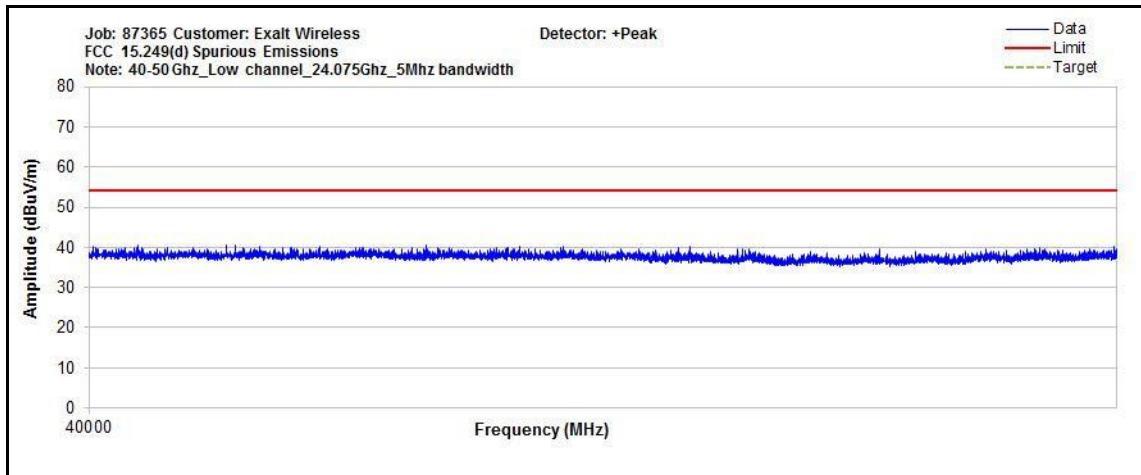

Plot 29. Radiated Spurious Emissions, 5 MHz, Low Channel, 40 GHz – 50 GHz

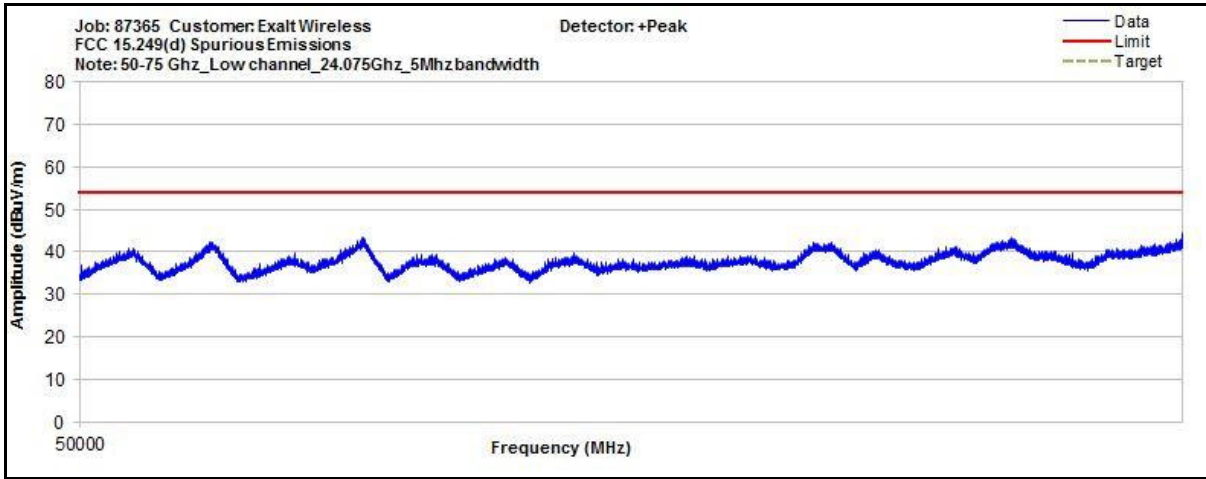

Plot 30. Radiated Spurious Emissions, 5 MHz, Low Channel, 50 GHz – 75 GHz

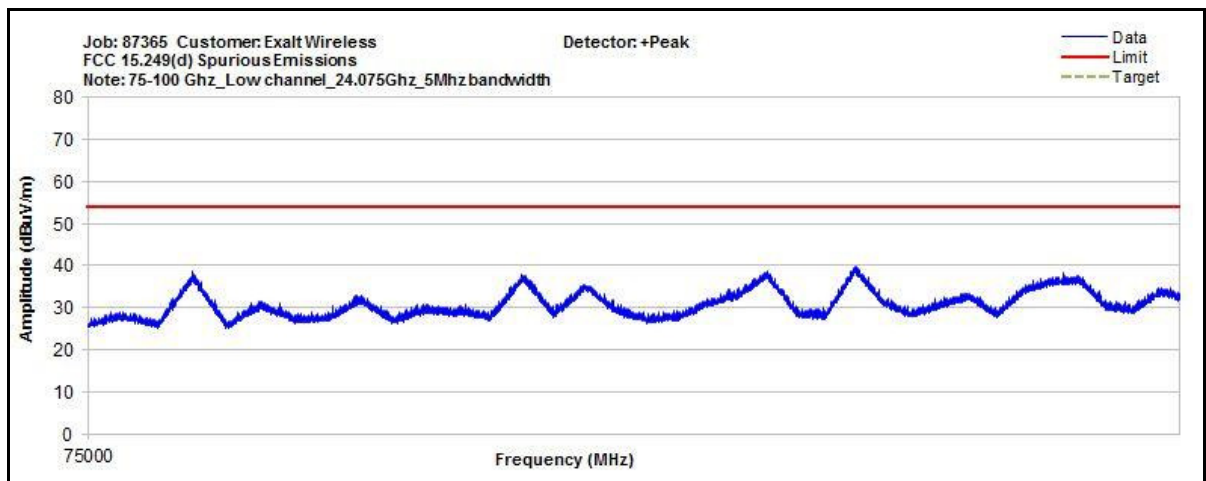

Plot 31. Radiated Spurious Emissions, 5 MHz, Low Channel, 75 GHz – 100 GHz

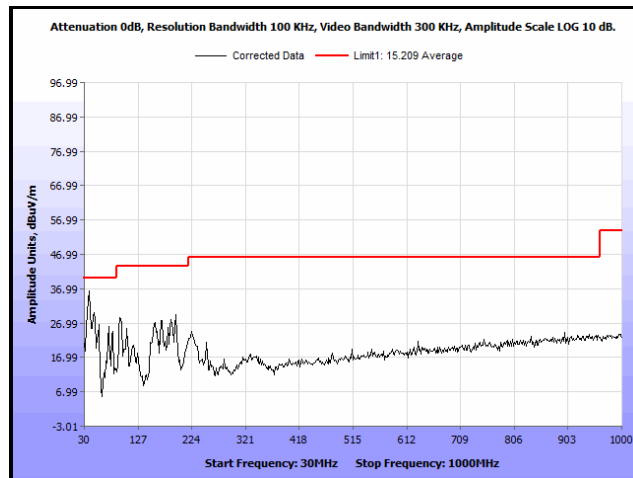

Plot 32. Radiated Spurious Emissions, 5 MHz, Mid Channel, 30 MHz – 1 GHz

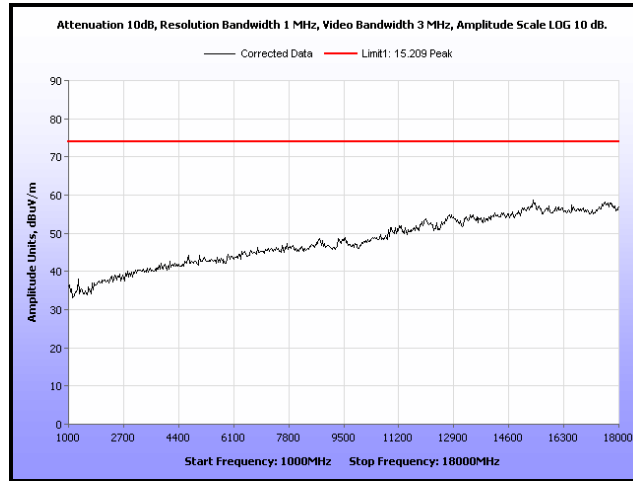

Plot 33. Radiated Spurious Emissions, 5 MHz, Mid Channel, 1 GHz – 18 GHz, Peak

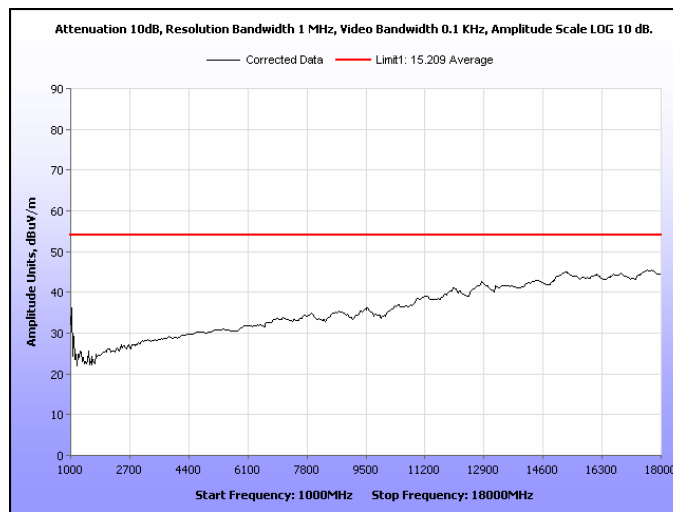

Plot 34. Radiated Spurious Emissions, 5 MHz, Mid Channel, 1 GHz – 18 GHz, Average

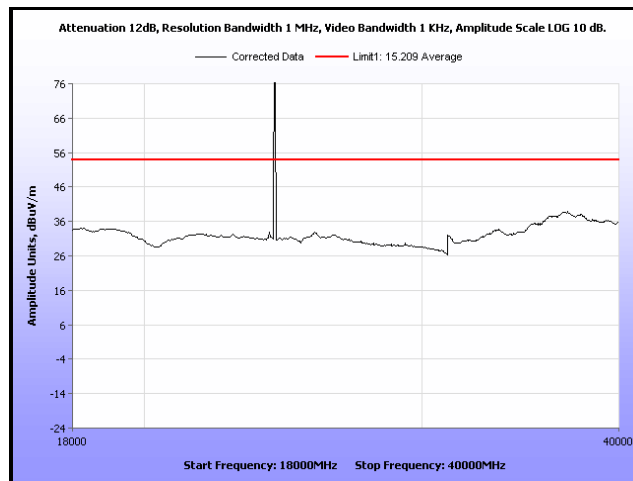

Plot 35. Radiated Spurious Emissions, 5 MHz, Mid Channel, 18 GHz – 40 GHz, Average

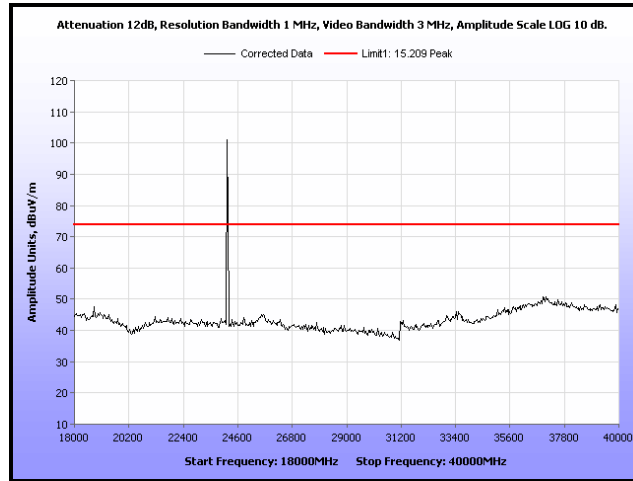

Plot 36. Radiated Spurious Emissions, 5 MHz, Mid Channel, 18 GHz – 40 GHz, Peak

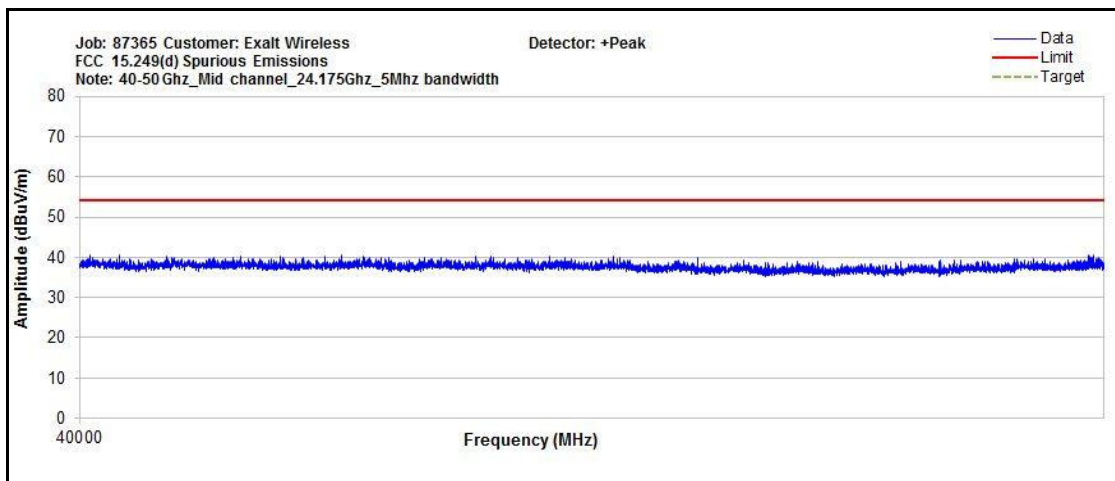

Plot 37. Radiated Spurious Emissions, 5 MHz, Mid Channel, 40 GHz – 50 GHz

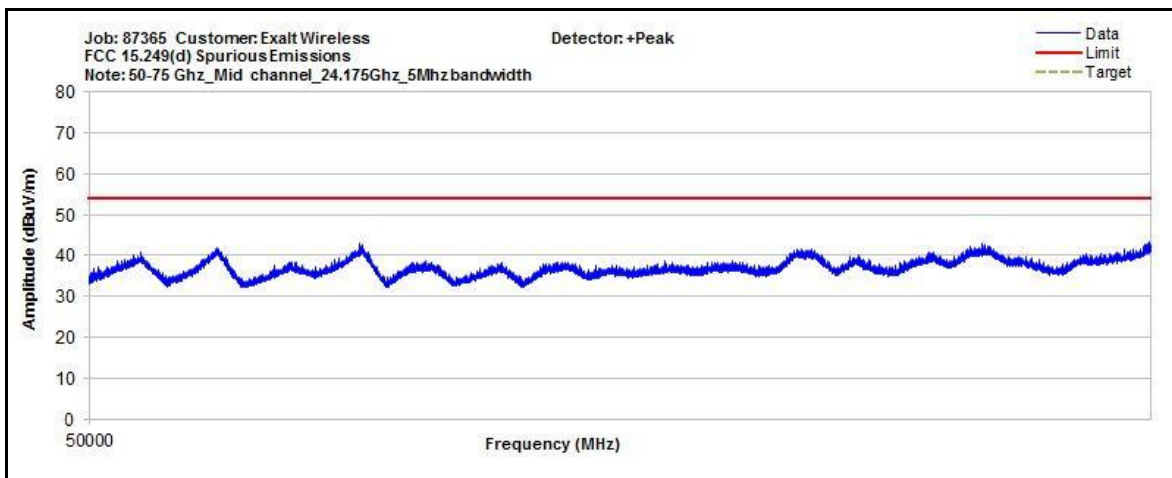

Plot 38. Radiated Spurious Emissions, 5 MHz, Mid Channel, 50 GHz – 75 GHz

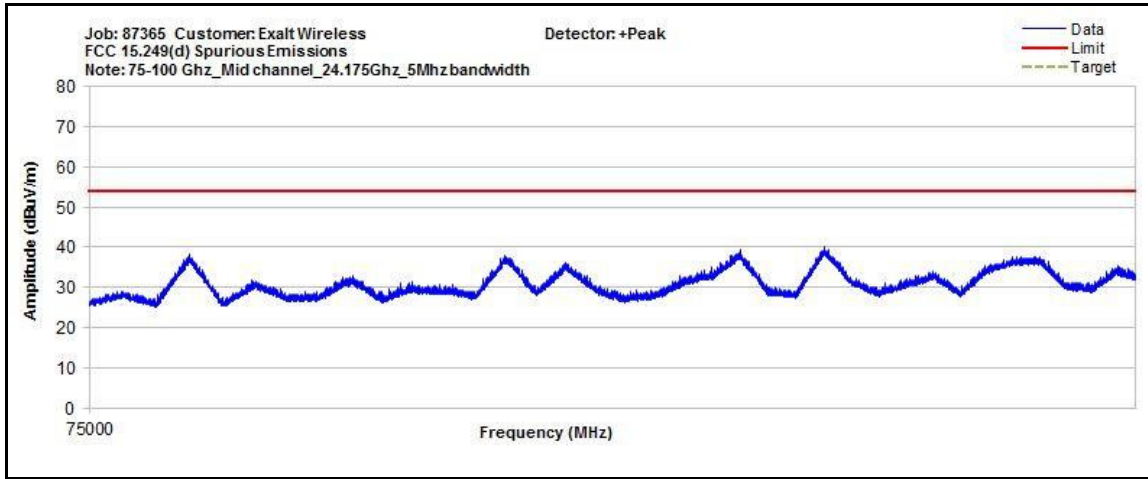

Plot 39. Radiated Spurious Emissions, 5 MHz, Mid Channel, 75 GHz – 100 GHz

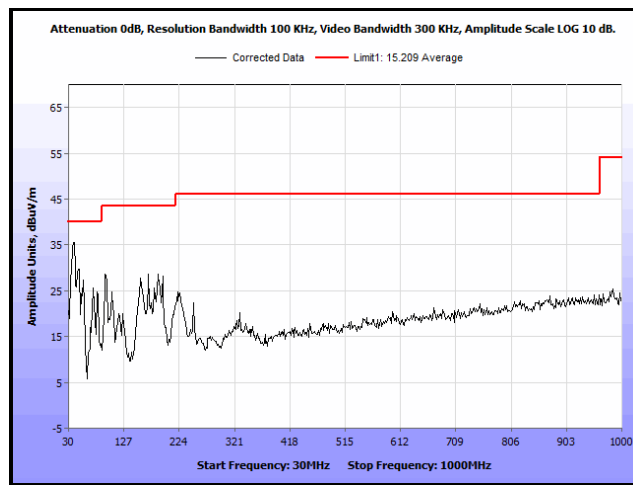

Plot 40. Radiated Spurious Emissions, 5 MHz, High Channel, 30 MHz – 1 GHz

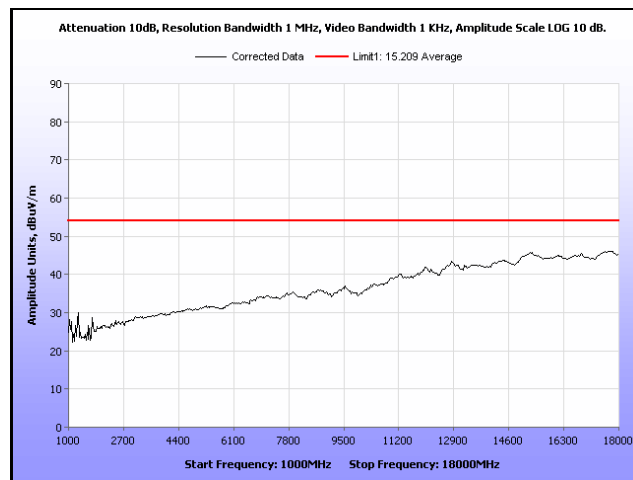

Plot 41. Radiated Spurious Emissions, 5 MHz, High Channel, 1 GHz – 18 GHz, Average

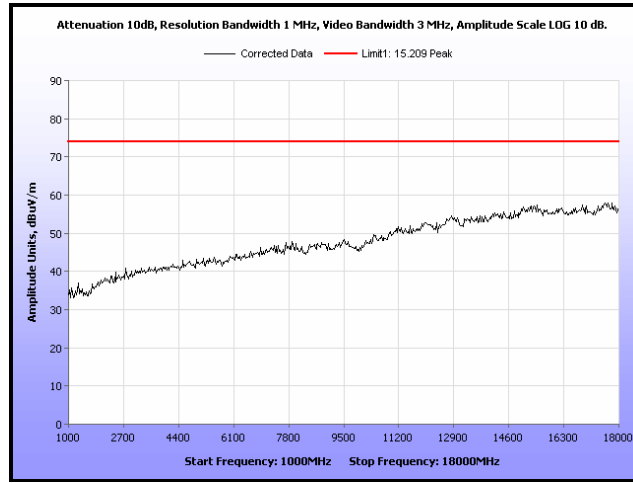

Plot 42. Radiated Spurious Emissions, 5 MHz, High Channel, 1 GHz – 18 GHz, Peak

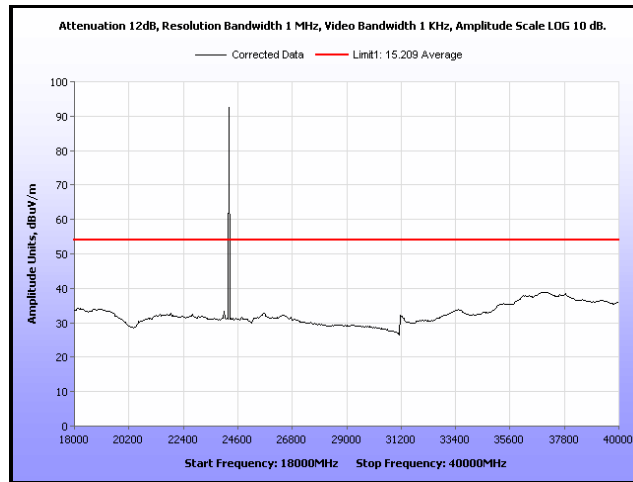

Plot 43. Radiated Spurious Emissions, 5 MHz, High Channel, 18 GHz – 40 GHz, Average

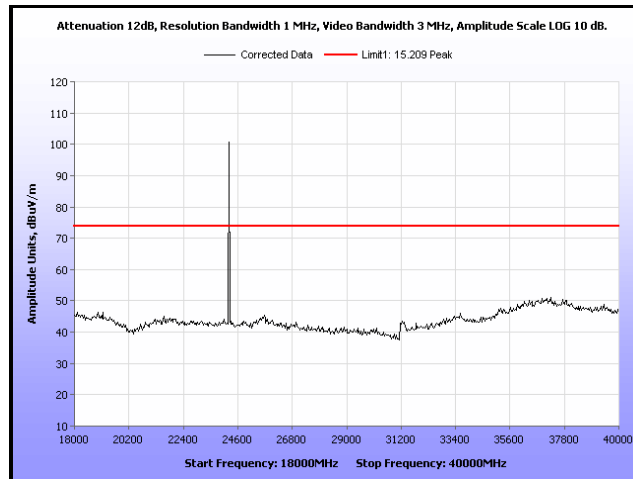

Plot 44. Radiated Spurious Emissions, 5 MHz, High Channel, 18 GHz – 40 GHz, Peak

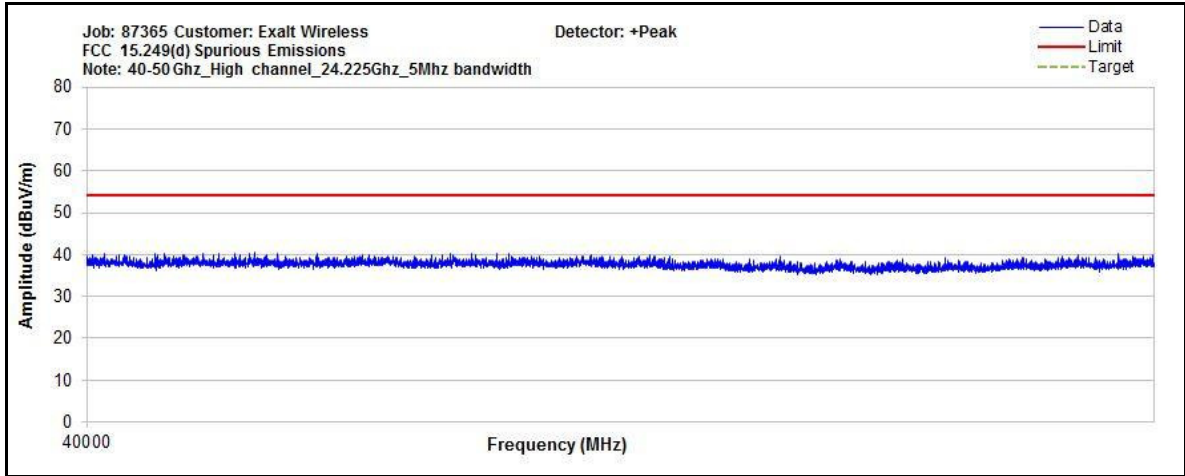

Plot 45. Radiated Spurious Emissions, 5 MHz, High Channel, 40 GHz – 50 GHz

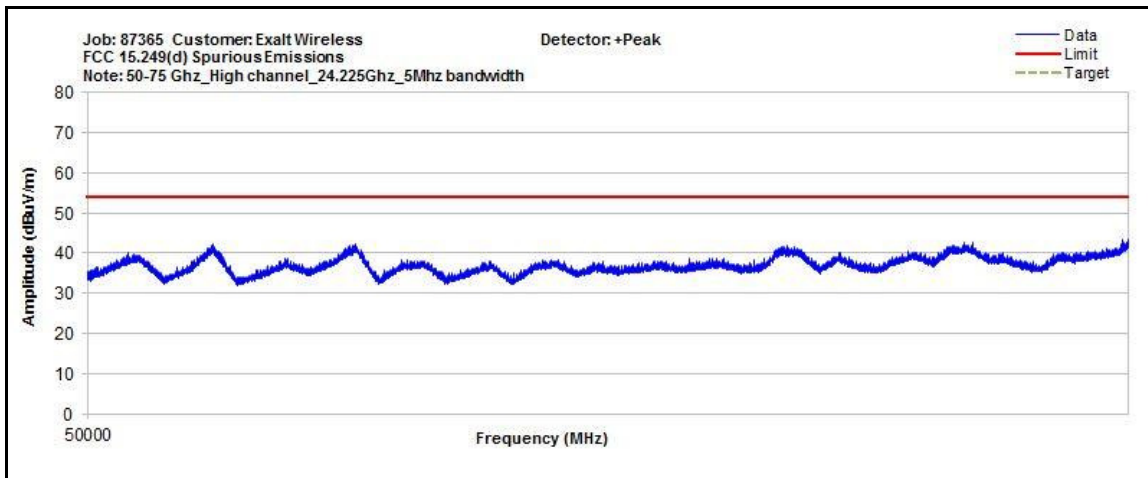

Plot 46. Radiated Spurious Emissions, 5 MHz, High Channel, 50 GHz – 75 GHz

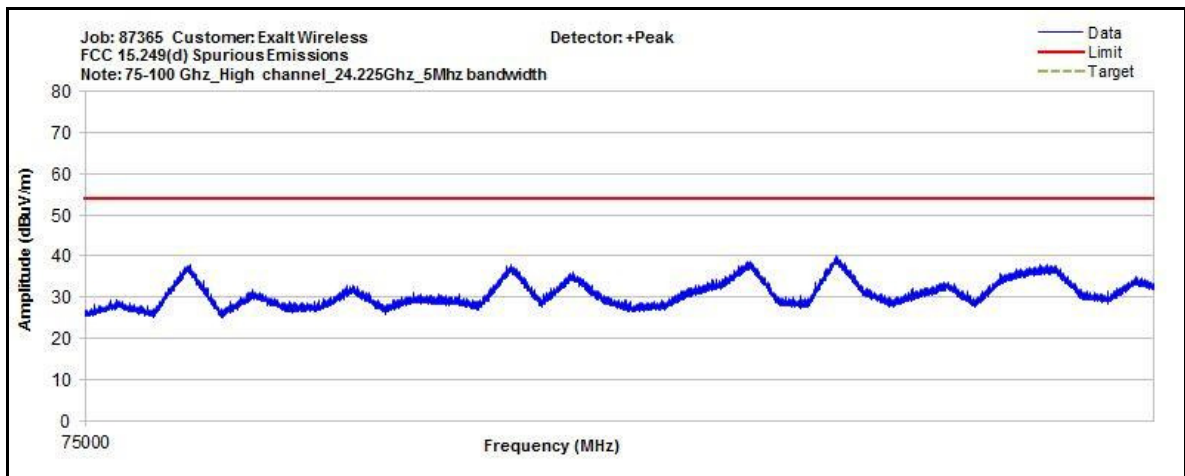

Plot 47. Radiated Spurious Emissions, 5 MHz, High Channel, 75 GHz – 100 GHz

Radiated Spurious Emissions, 10 MHz

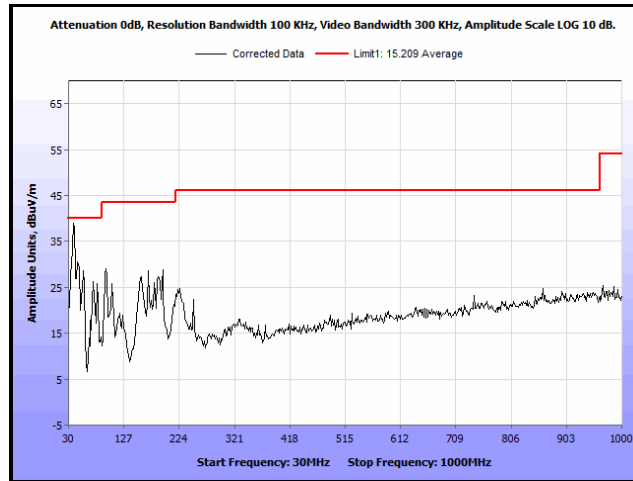

Plot 48. Radiated Spurious Emissions, 10 MHz, Low Channel, 30 MHz – 1 GHz

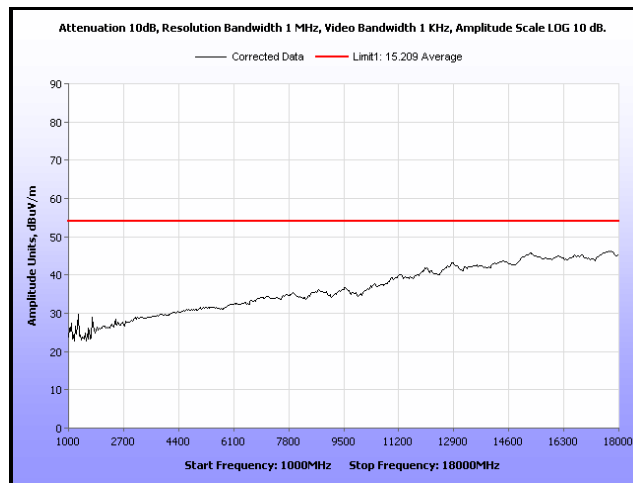

Plot 49. Radiated Spurious Emissions, 10 MHz, Low Channel, 1 GHz – 18 GHz, Average

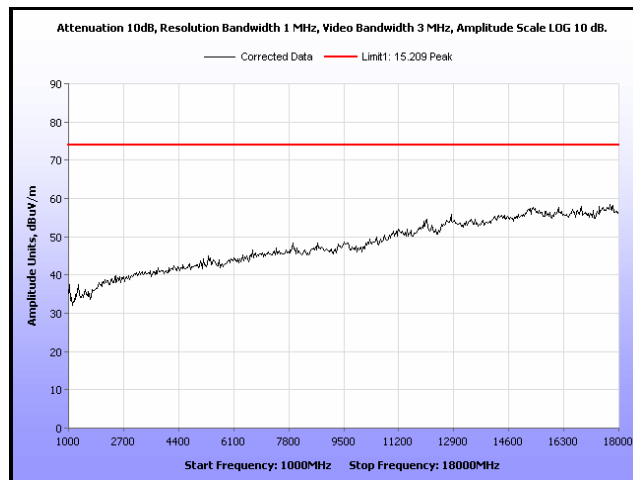

Plot 50. Radiated Spurious Emissions, 10 MHz, Low Channel, 1 GHz – 18 GHz, Peak

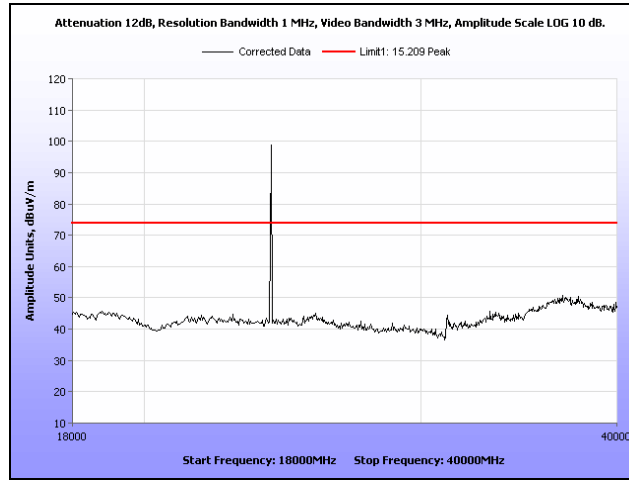

Plot 51. Radiated Spurious Emissions, 10 MHz, Low Channel, 18 GHz - 40 GHz, Peak

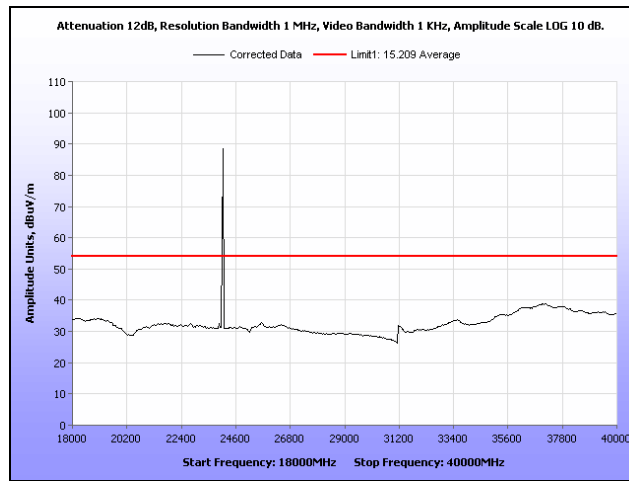

Plot 52. Radiated Spurious Emissions, 10 MHz, Low Channel, 18-40 GHz, Average

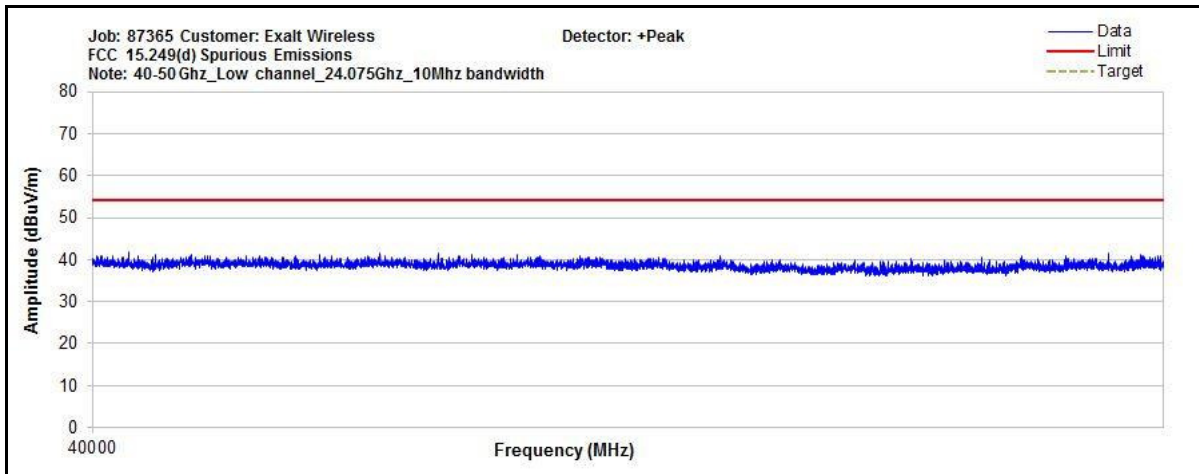

Plot 53. Radiated Spurious Emissions, 10 MHz, Low Channel, 40 GHz - 50 GHz

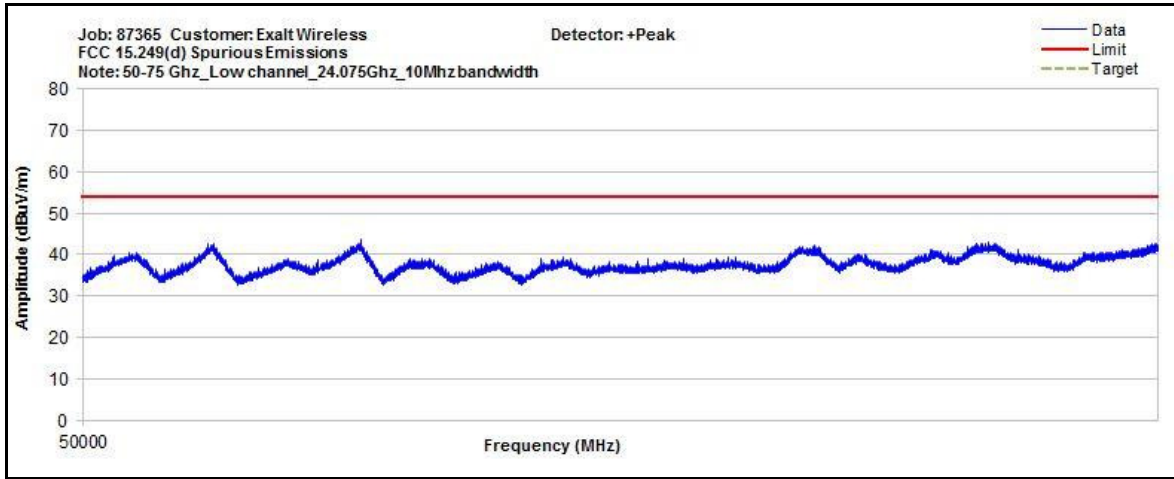

Plot 54. Radiated Spurious Emissions, 10 MHz, Low Channel, 50 GHz – 75 GHz

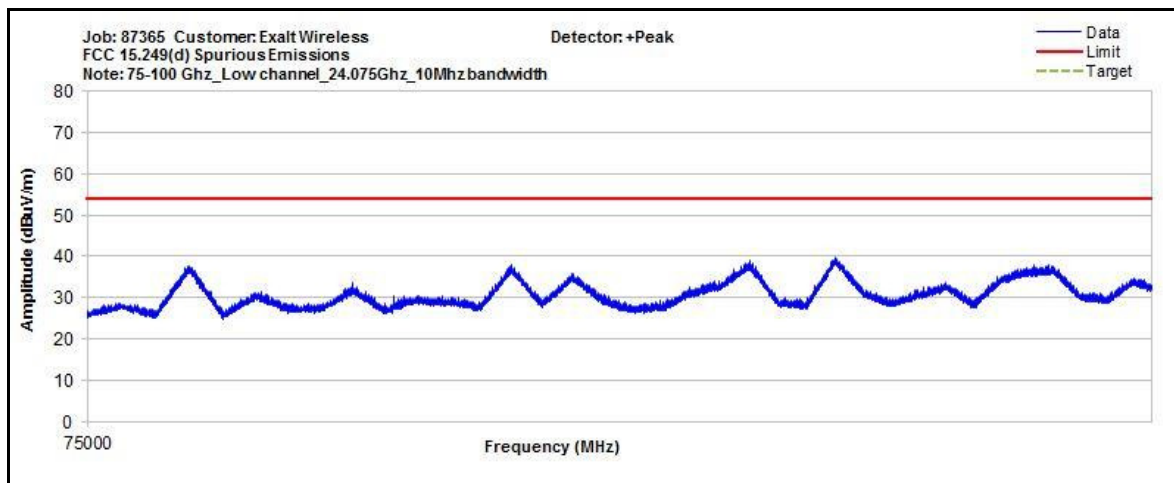

Plot 55. Radiated Spurious Emissions, 10 MHz, Low Channel, 75 GHz – 100 GHz

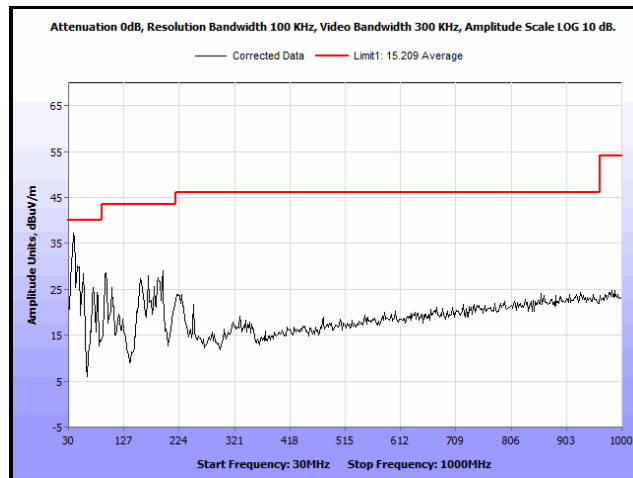

Plot 56. Radiated Spurious Emissions, 10 MHz, Mid Channel, 30 MHz – 1 GHz

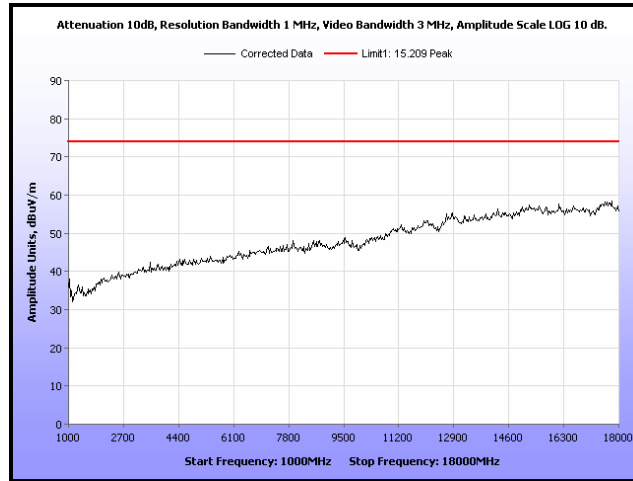

Plot 57. Radiated Spurious Emissions, 10 MHz, Mid Channel, 1 GHz – 18 GHz, Peak

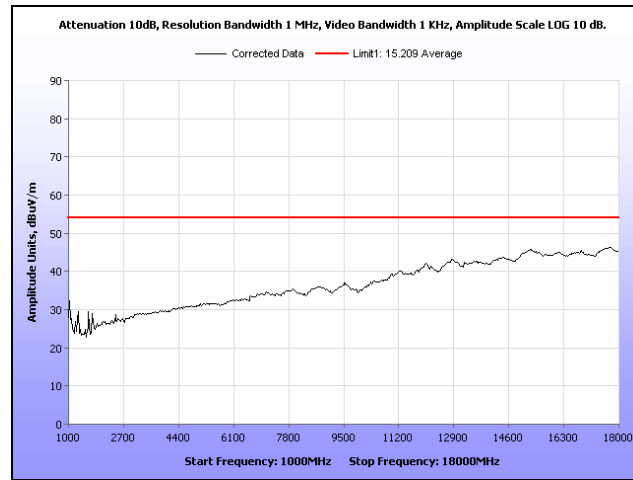

Plot 58. Radiated Spurious Emissions, 10 MHz, Mid Channel, 1 GHz – 18 GHz, Average

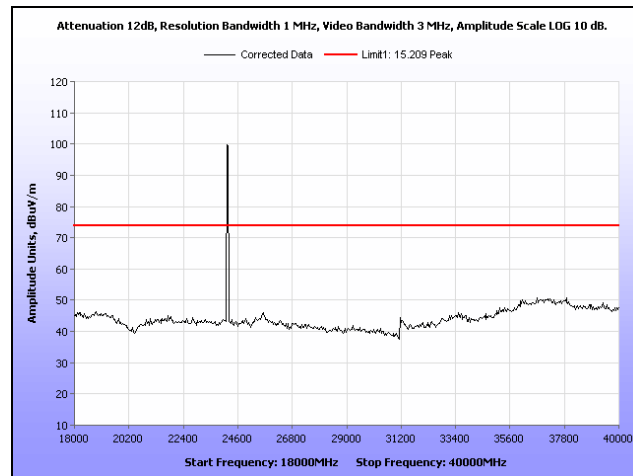

Plot 59. Radiated Spurious Emissions, 10 MHz, Mid Channel, 18 GHz - 40 GHz, Peak

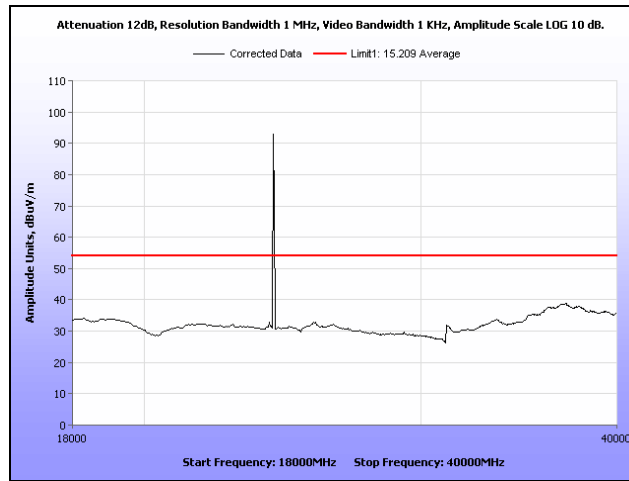

Plot 60. Radiated Spurious Emissions, 10 MHz, Mid Channel, 18 GHz - 40 GHz, Average

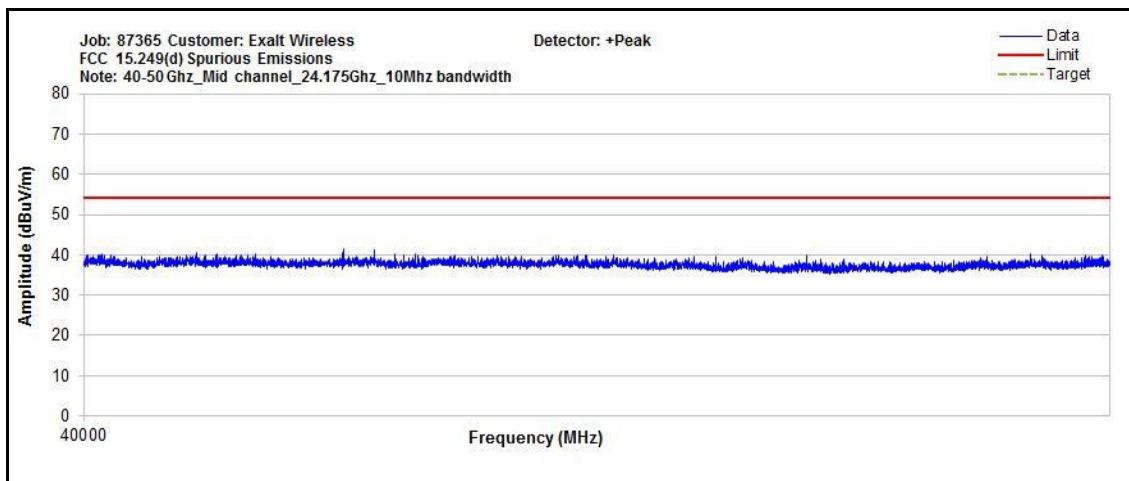

Plot 61. Radiated Spurious Emissions, 10 MHz, Mid Channel, 40 GHz - 50 GHz

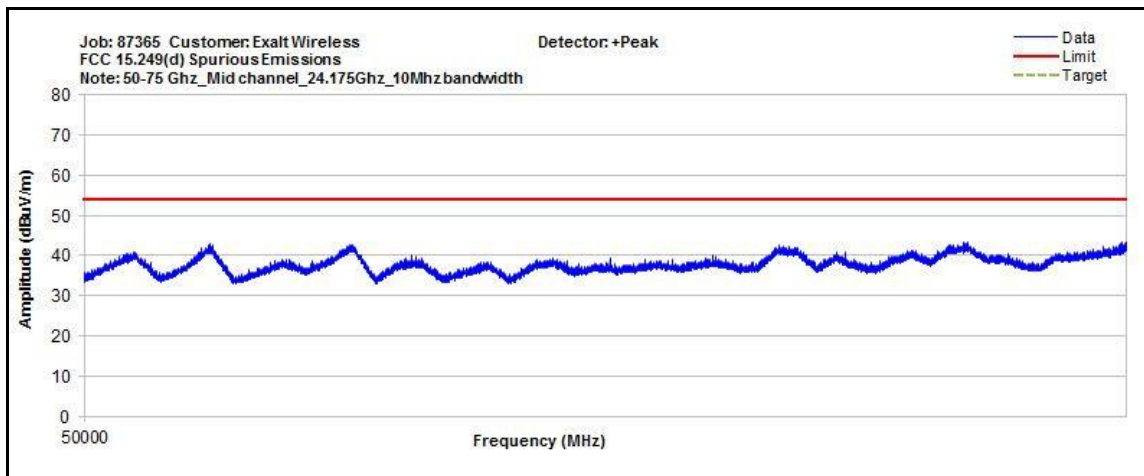

Plot 62. Radiated Spurious Emissions, 10 MHz, Mid Channel, 50 GHz - 75 GHz

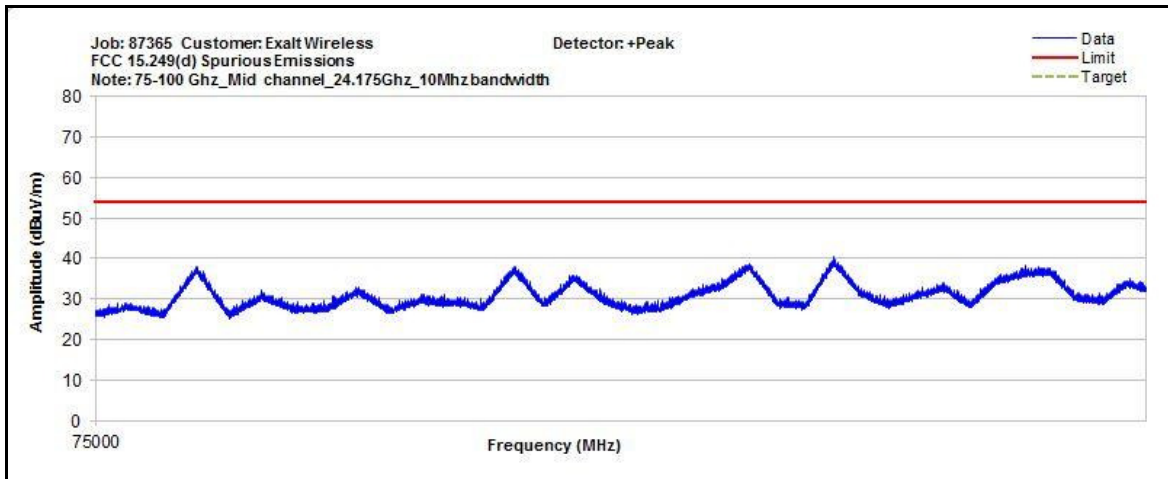

Plot 63. Radiated Spurious Emissions, 10 MHz, Mid Channel, 75 GHz – 100 GHz

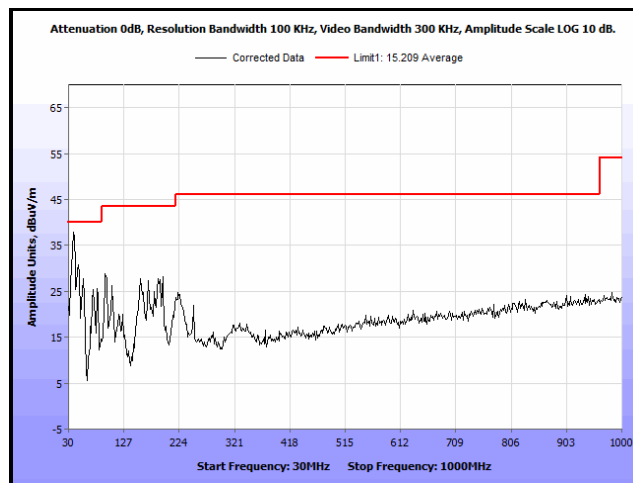

Plot 64. Radiated Spurious Emissions, 10 MHz, High Channel, 30 MHz – 1 GHz

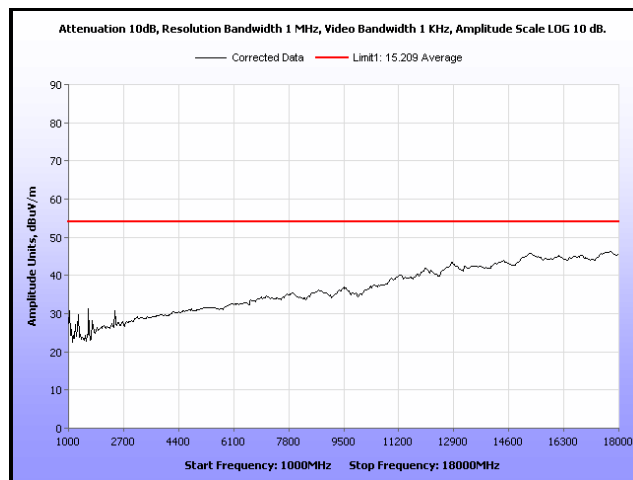

Plot 65. Radiated Spurious Emissions, 10 MHz, High Channel, 1 GHz – 18 GHz, Average

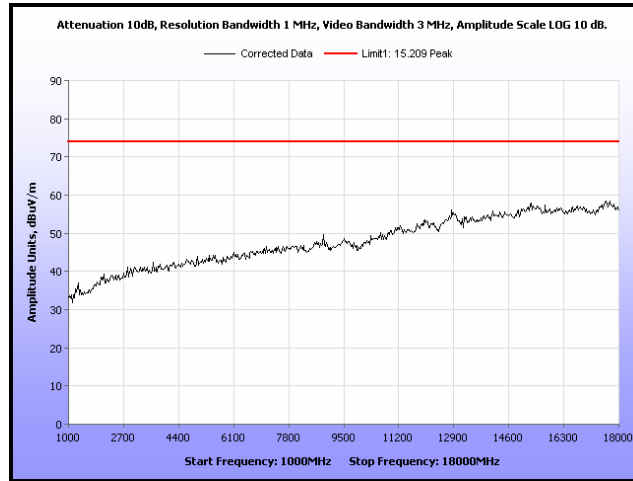

Plot 66. Radiated Spurious Emissions, 10 MHz, High Channel, 1 GHz – 18 GHz, Peak

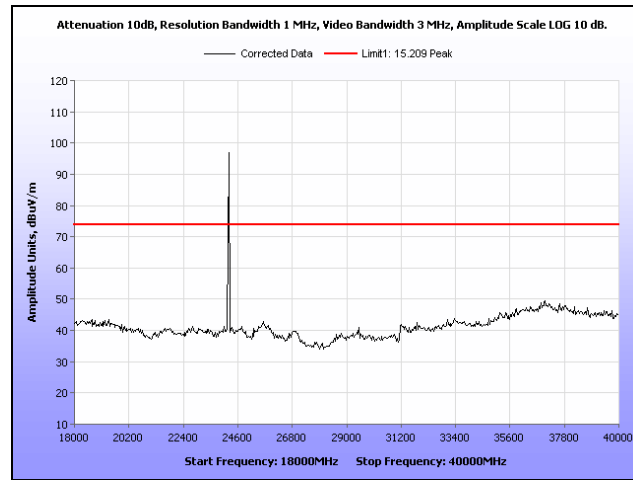

Plot 67. Radiated Spurious Emissions, 10 MHz, High Channel, 18 GHz - 40 GHz, Peak

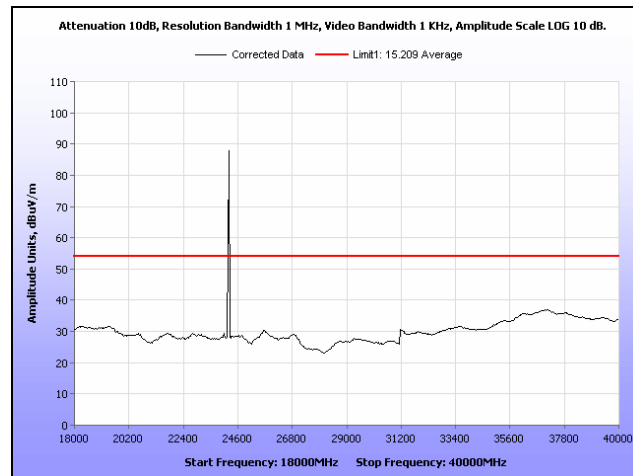

Plot 68. Radiated Spurious Emissions, 10 MHz, High Channel, 18 GHz - 40 GHz, Average

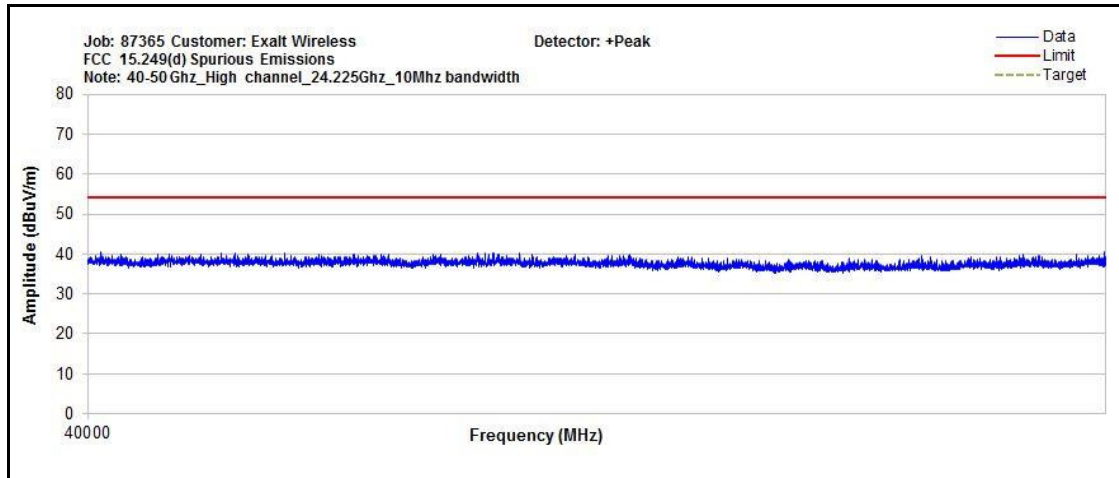

Plot 69. Radiated Spurious Emissions, 10 MHz, High Channel, 40 GHz – 50 GHz

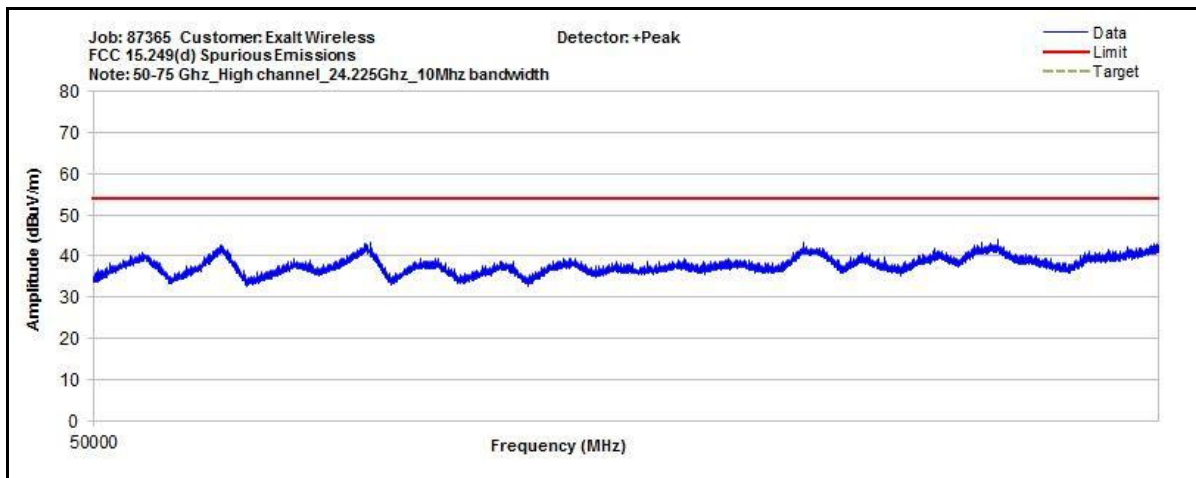

Plot 70. Radiated Spurious Emissions, 10 MHz, High Channel, 50 GHz – 75 GHz

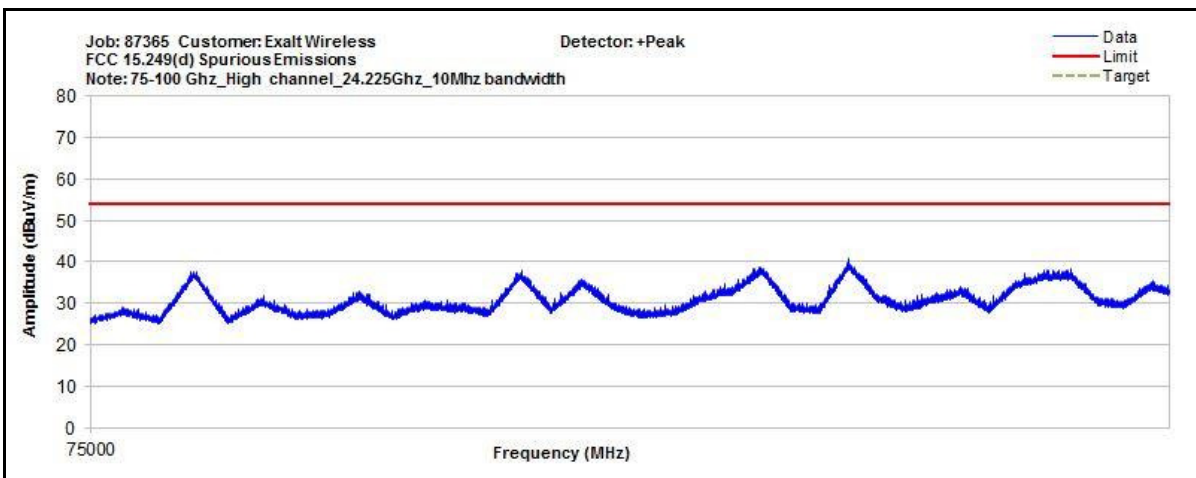

Plot 71. Radiated Spurious Emissions, 10 MHz, High Channel, 75 GHz – 100 GHz

Radiated Spurious Emissions, 20 MHz

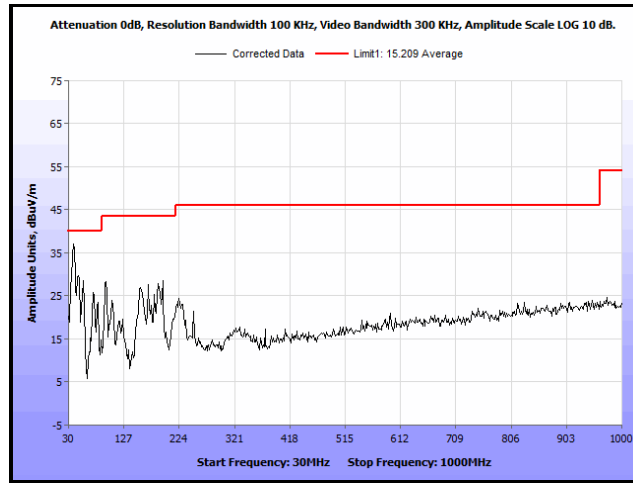

Plot 72. Radiated Spurious Emissions, 20 MHz, Low Channel, 30 MHz – 1 GHz

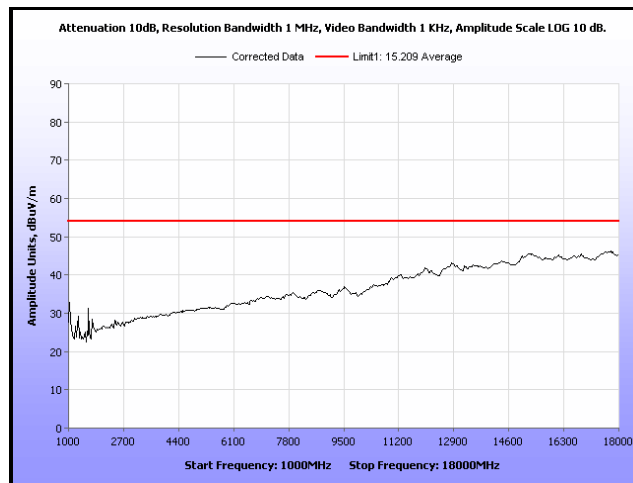

Plot 73. Radiated Spurious Emissions, 20 MHz, Low Channel, 1 GHz – 18 GHz, Average

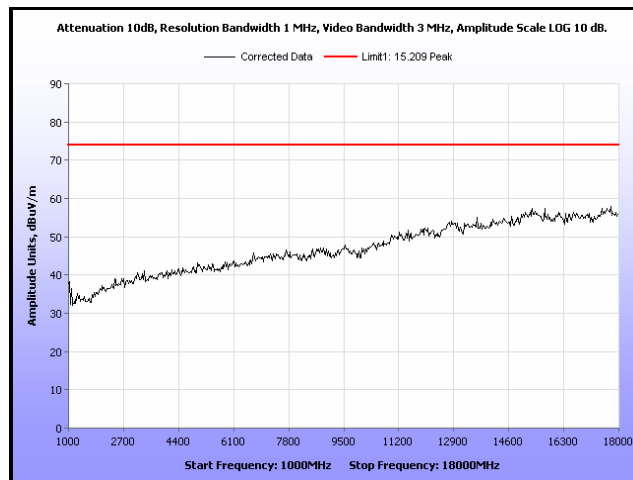

Plot 74. Radiated Spurious Emissions, 20 MHz, Low Channel, 1 GHz – 18 GHz, Peak

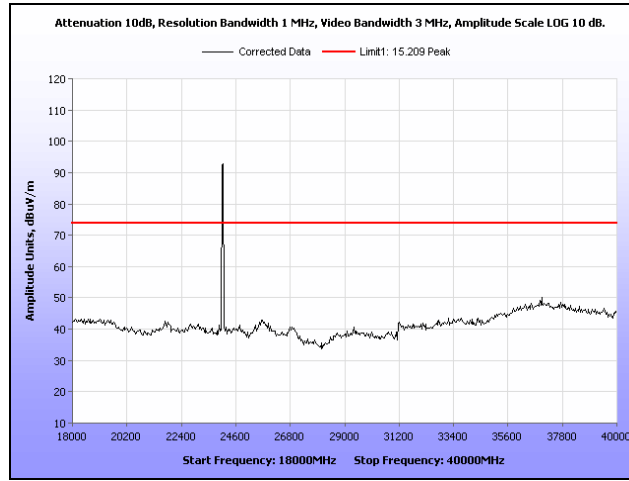

Plot 75. Radiated Spurious Emissions, 20 MHz, Low Channel, 18 GHz - 40 GHz, Peak

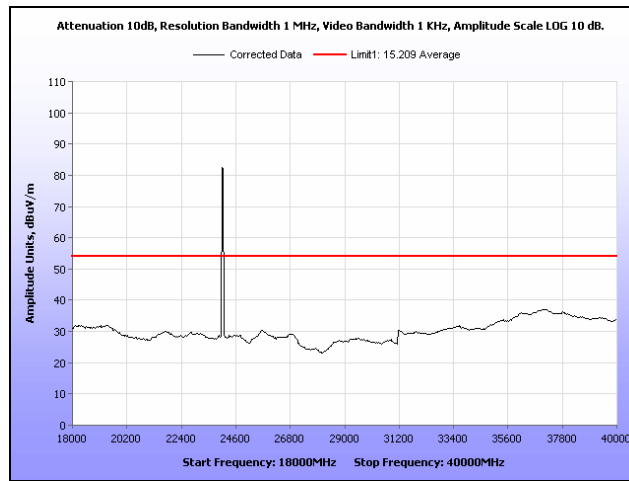

Plot 76. Radiated Spurious Emissions, 20 MHz, Low Channel, 18 GHz - 40 GHz, Average

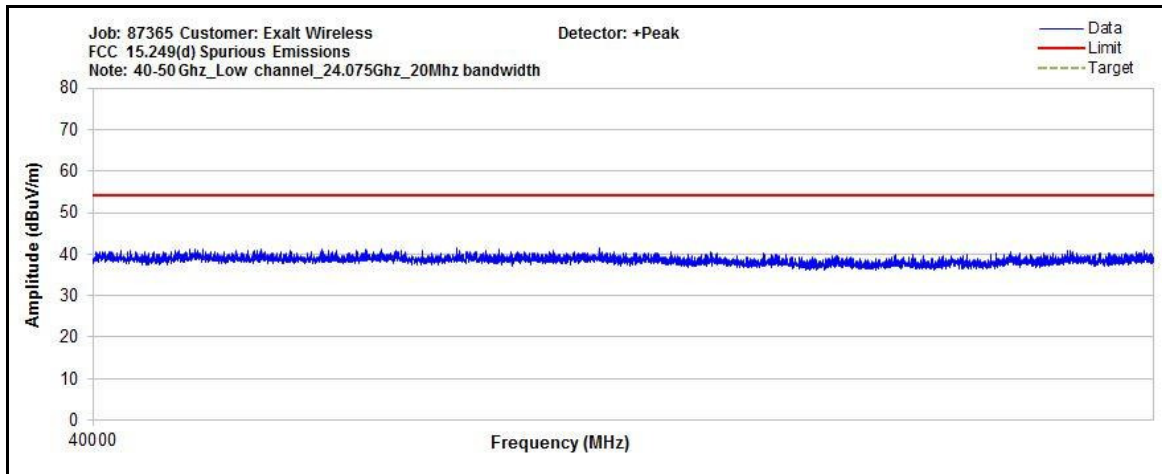

Plot 77. Radiated Spurious Emissions, 20 MHz, Low Channel, 40 GHz - 50 GHz

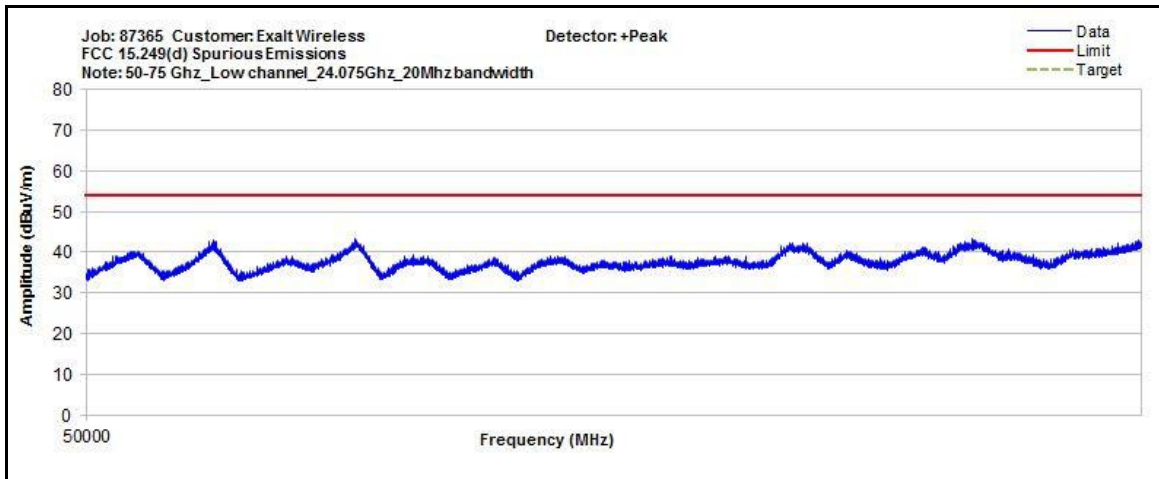

Plot 78. Radiated Spurious Emissions, 20 MHz, Low Channel, 50 GHz – 75 GHz

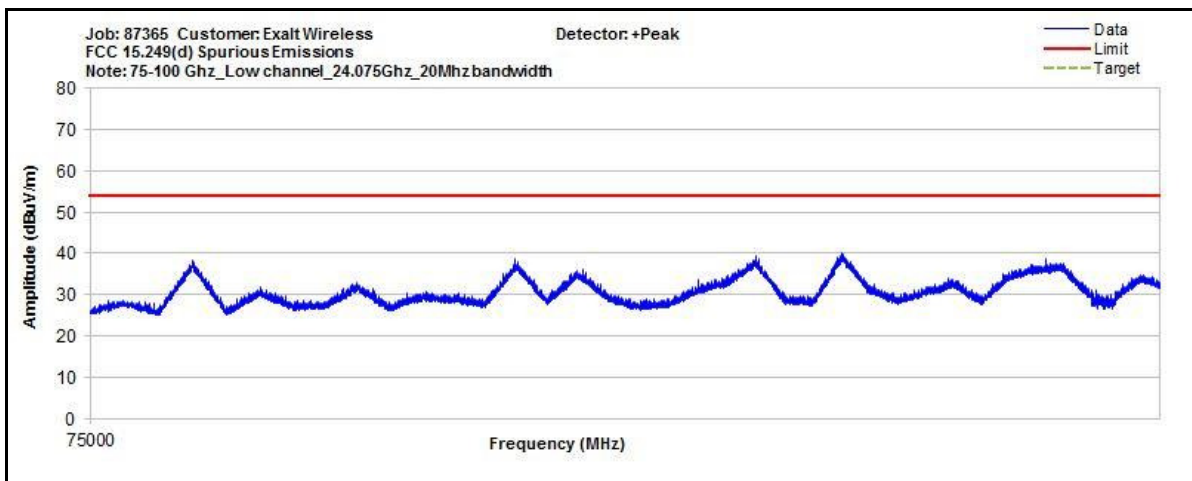

Plot 79. Radiated Spurious Emissions, 20 MHz, Low Channel, 75 GHz – 100 GHz

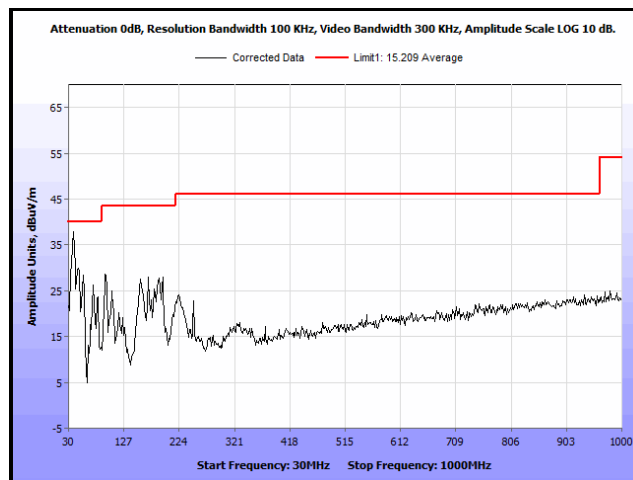

Plot 80. Radiated Spurious Emissions, 20 MHz, Mid Channel, 30 MHz – 1 GHz

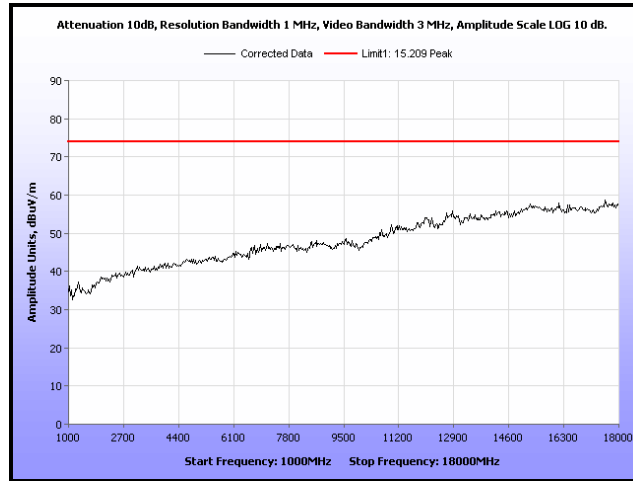

Plot 81. Radiated Spurious Emissions, 20 MHz, Mid Channel, 1 GHz – 18 GHz, Peak

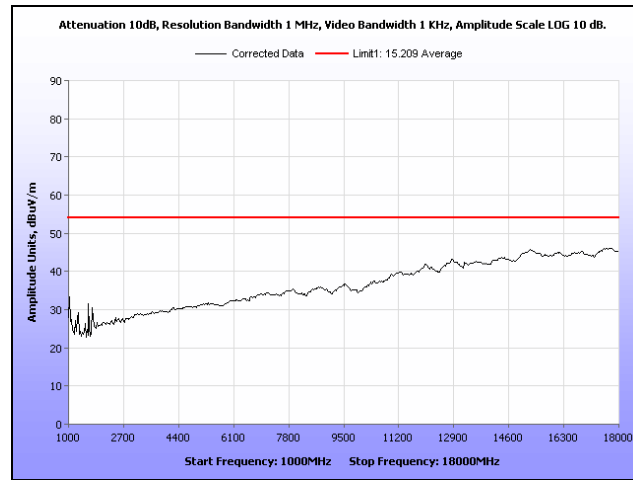

Plot 82. Radiated Spurious Emissions, 20 MHz, Mid Channel, 1 GHz – 18 GHz, Average

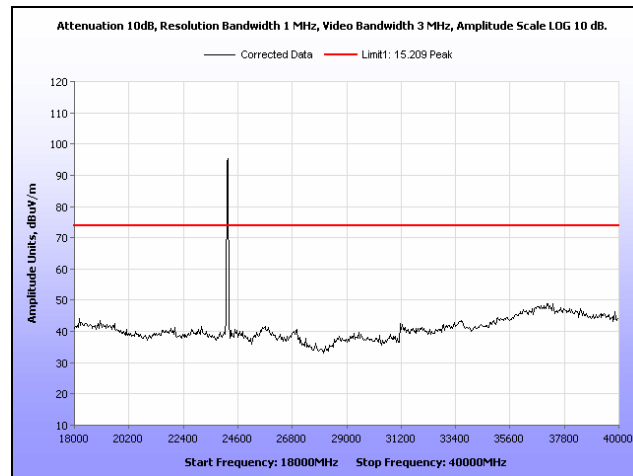

Plot 83. Radiated Spurious Emissions, 20 MHz, Mid Channel, 18 GHz - 40 GHz

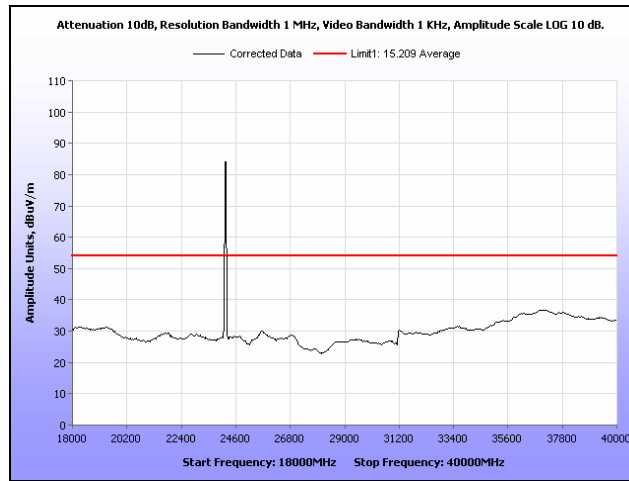

Plot 84. Radiated Spurious Emissions, 20 MHz, Mid Channel, 18 GHz - 40 GHz, Average

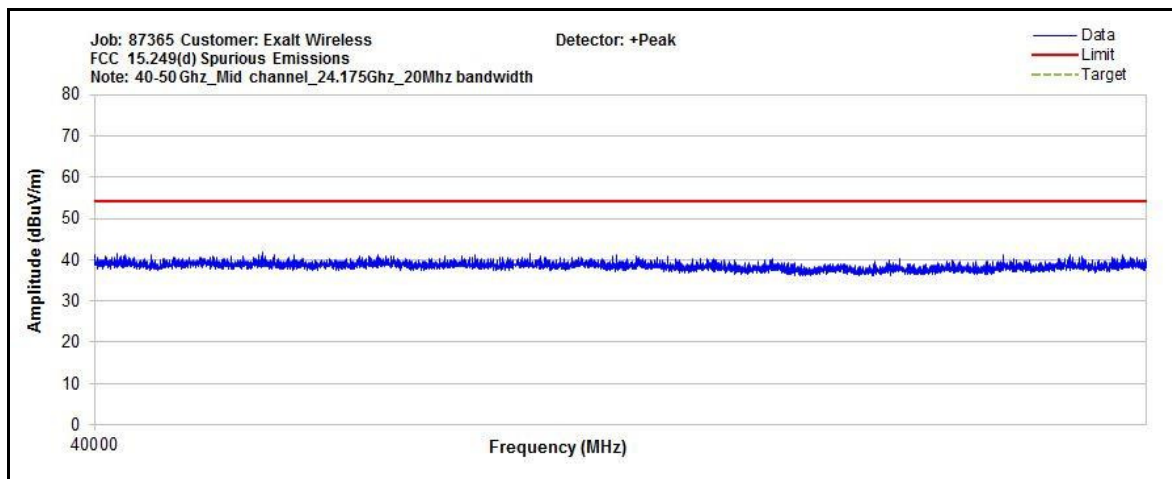

Plot 85. Radiated Spurious Emissions, 20 MHz, Mid Channel, 40 GHz - 50 GHz

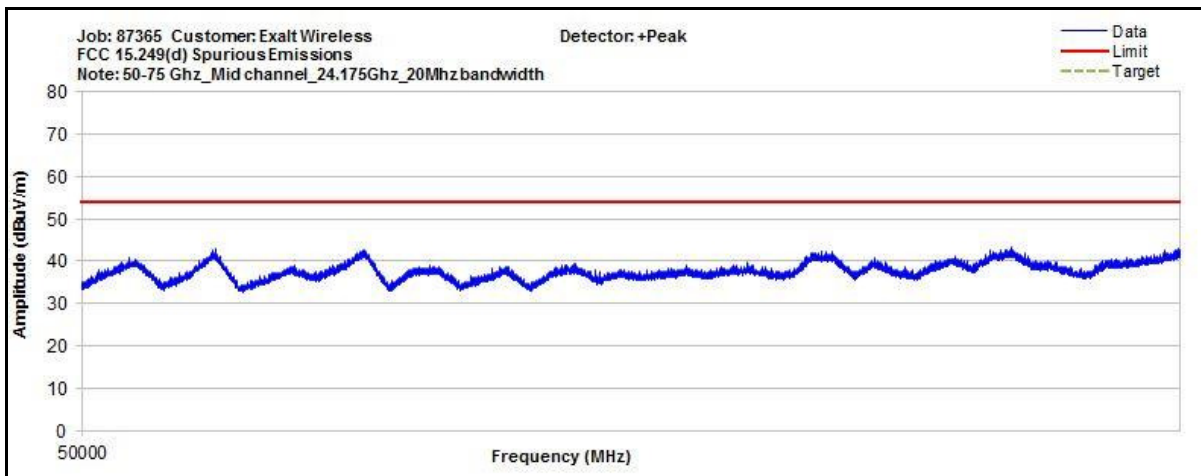

Plot 86. Radiated Spurious Emissions, 20 MHz, Mid Channel, 50 GHz - 75 GHz

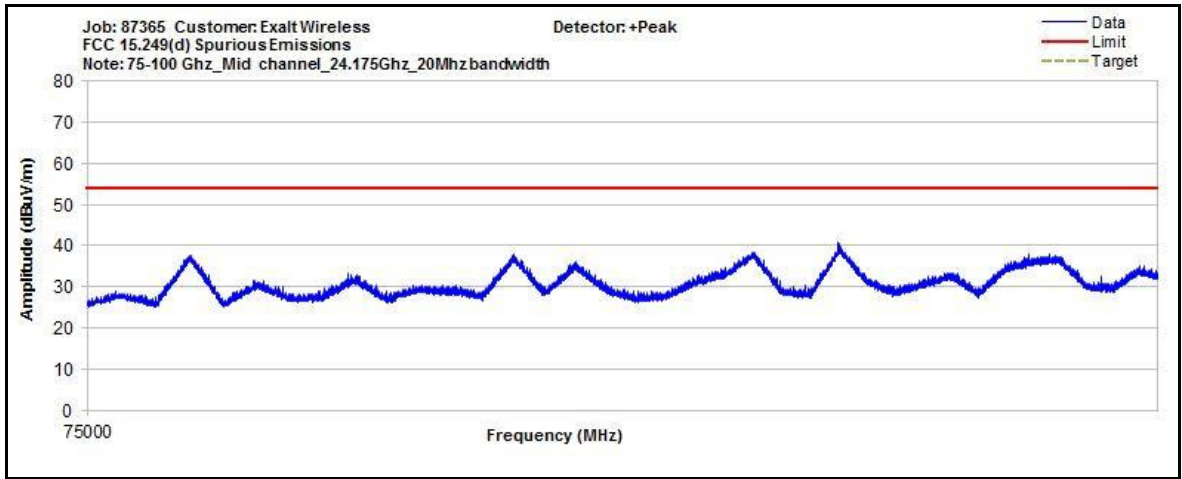

Plot 87. Radiated Spurious Emissions, 20 MHz, Mid Channel, 75 GHz – 100 GHz

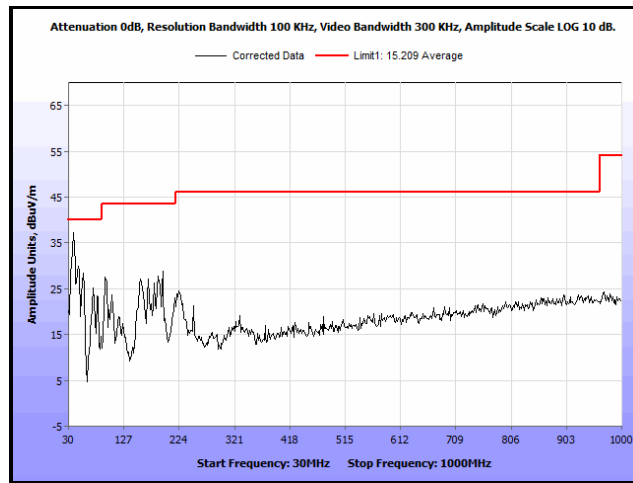

Plot 88. Radiated Spurious Emissions, 20 MHz, High Channel, 30 MHz – 1 GHz

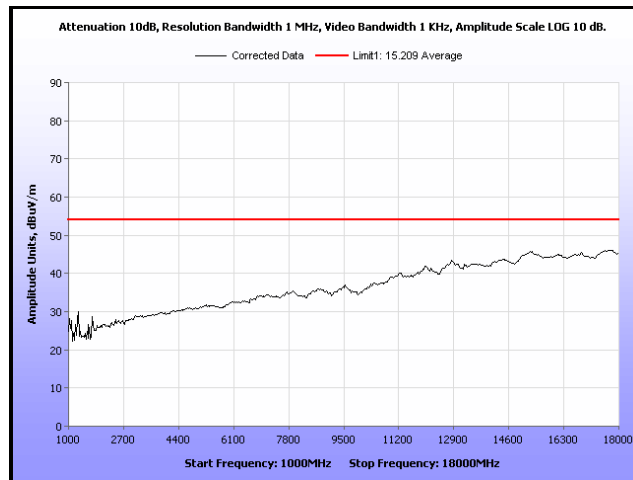

Plot 89. Radiated Spurious Emissions, 20 MHz, High Channel, 1 GHz – 18 GHz, Average

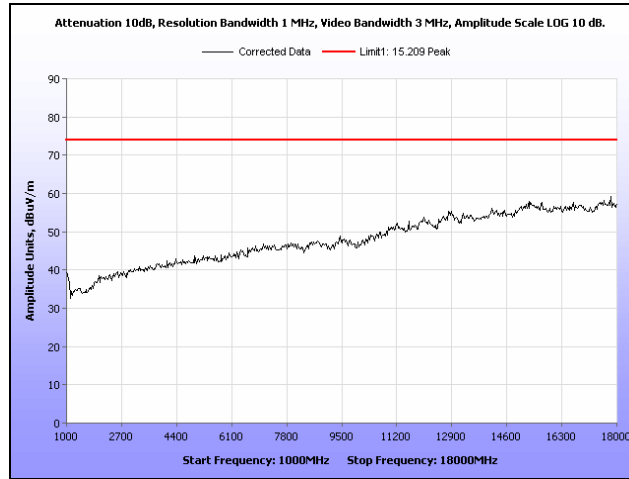

Plot 90. Radiated Spurious Emissions, 20 MHz, High Channel, 1 GHz – 18 GHz, Peak

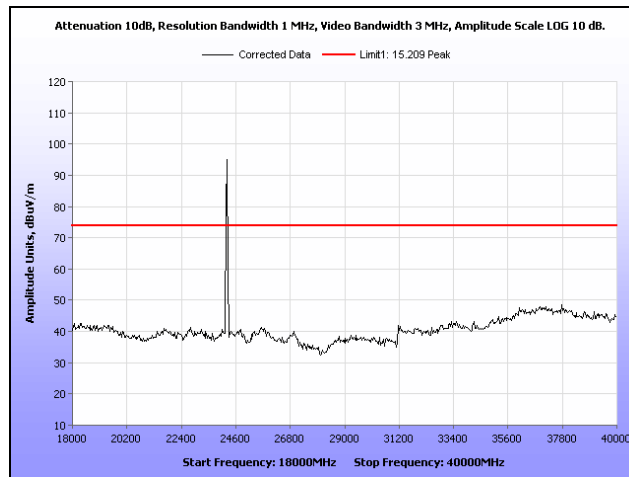

Plot 91. Radiated Spurious Emissions, 20 MHz, High Channel, 18 GHz - 40 GHz, Peak

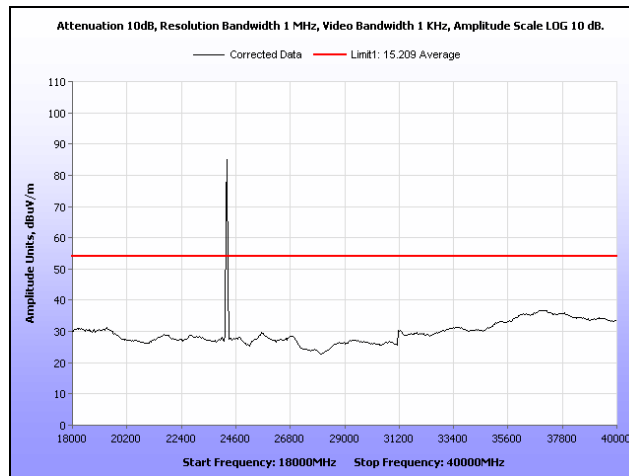

Plot 92. Radiated Spurious Emissions, 20 MHz, High Channel, 18 GHz - 40 GHz, Average

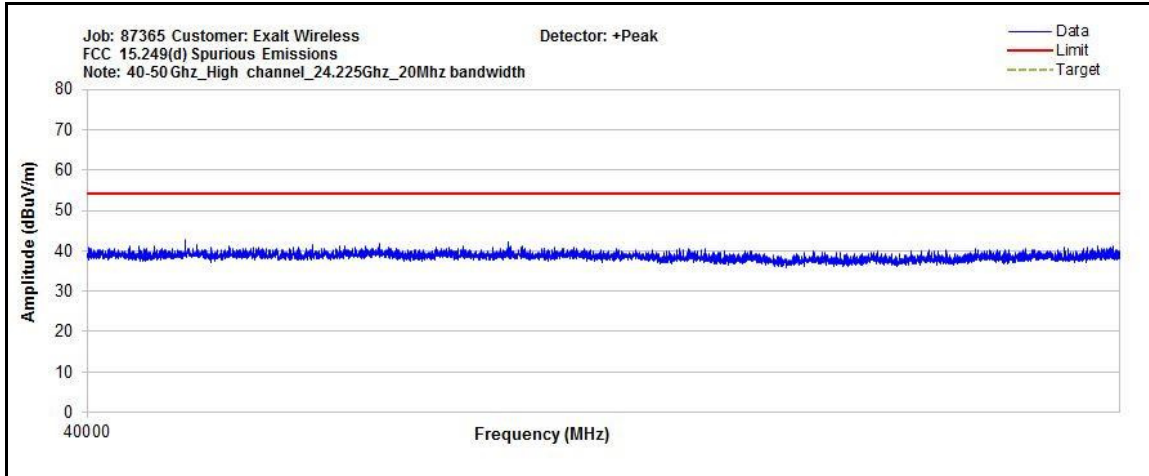

Plot 93. Radiated Spurious Emissions, 20 MHz, High Channel, 40 GHz – 50 GHz

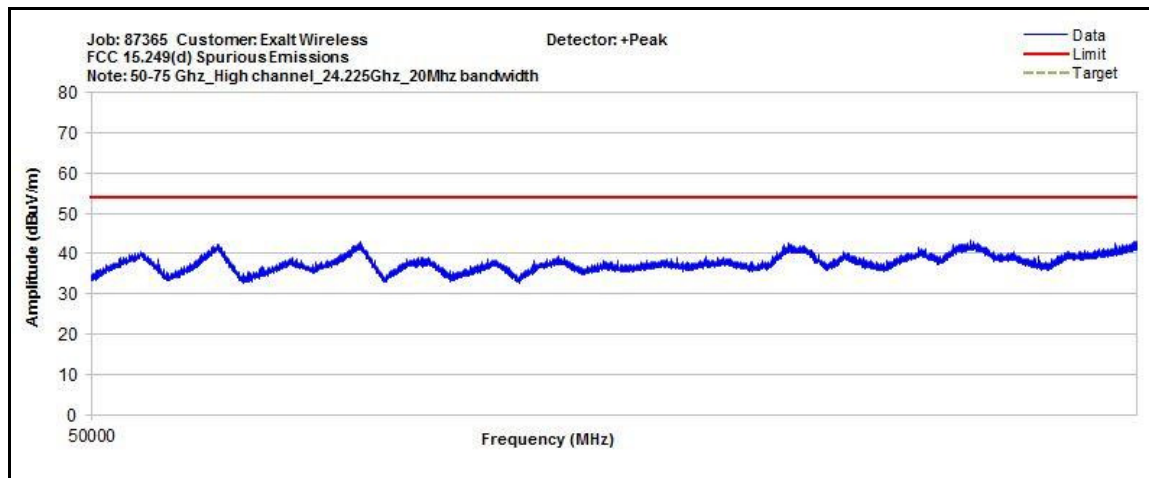

Plot 94. Radiated Spurious Emissions, 20 MHz, High Channel, 50 GHz – 75 GHz

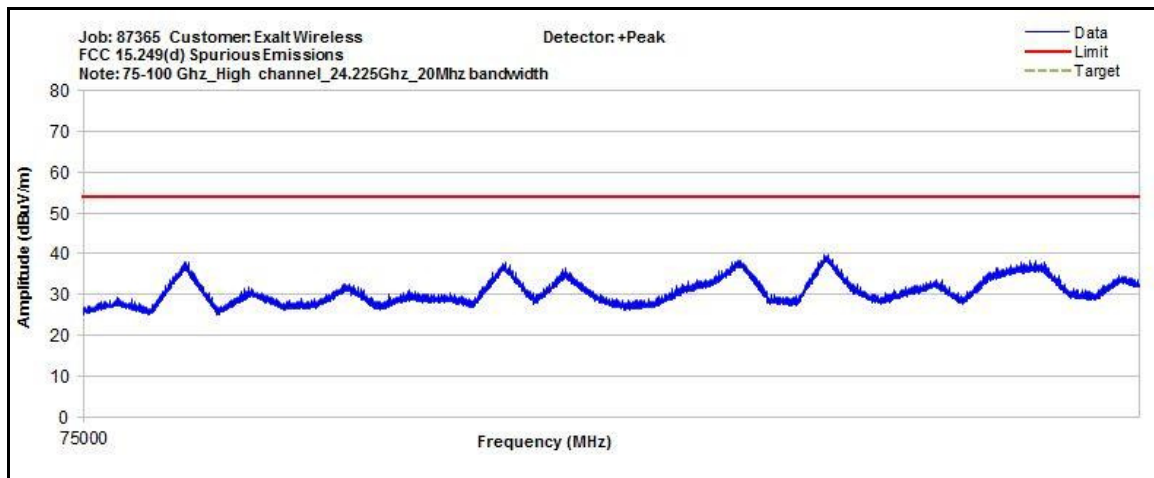

Plot 95. Radiated Spurious Emissions, 20 MHz, High Channel, 75 GHz – 100 GHz

Radiated Spurious Emissions, 25 MHz

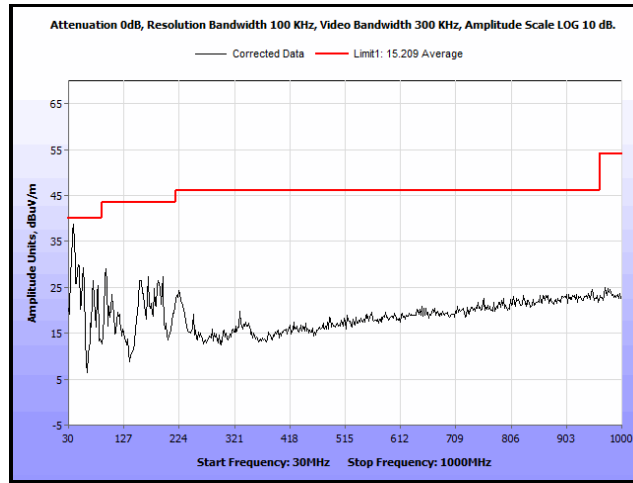

Plot 96. Radiated Spurious Emissions, 25 MHz, Low Channel, 30 MHz – 1 GHz

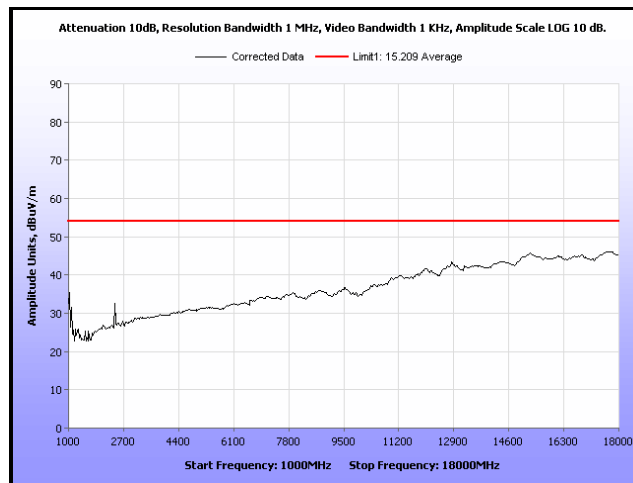

Plot 97. Radiated Spurious Emissions, 25 MHz, Low Channel, 1 GHz – 18 GHz, Average

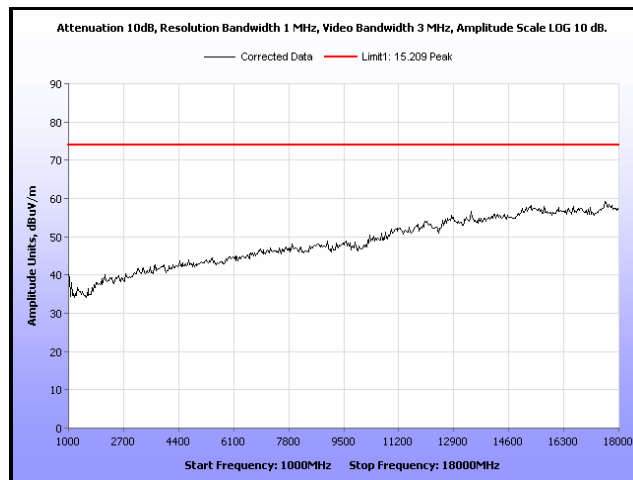

Plot 98. Radiated Spurious Emissions, 25 MHz, Low Channel, 1 GHz – 18 GHz, Peak

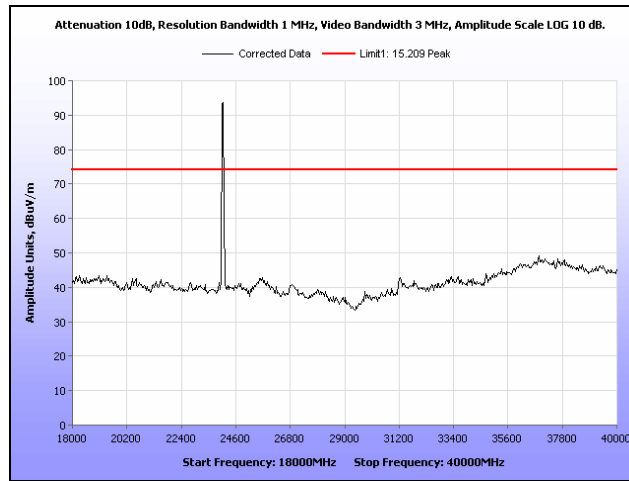

Plot 99. Radiated Spurious Emissions, 25 MHz, Low Channel, 18 GHz - 40 GHz, Peak

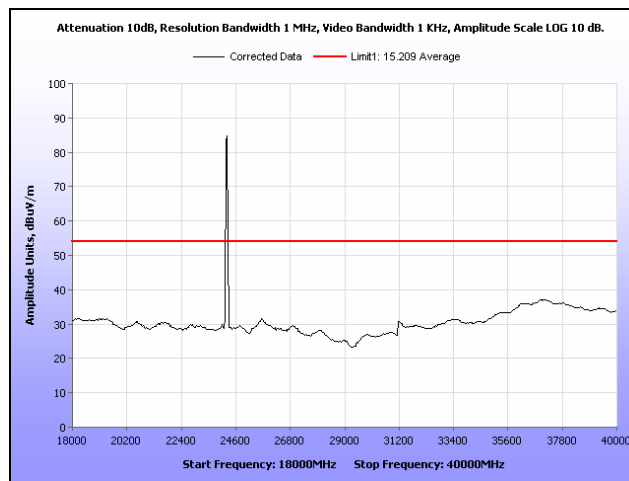

Plot 100. Radiated Spurious Emissions, 25 MHz, Low Channel, 18 GHz - 40 GHz, Average

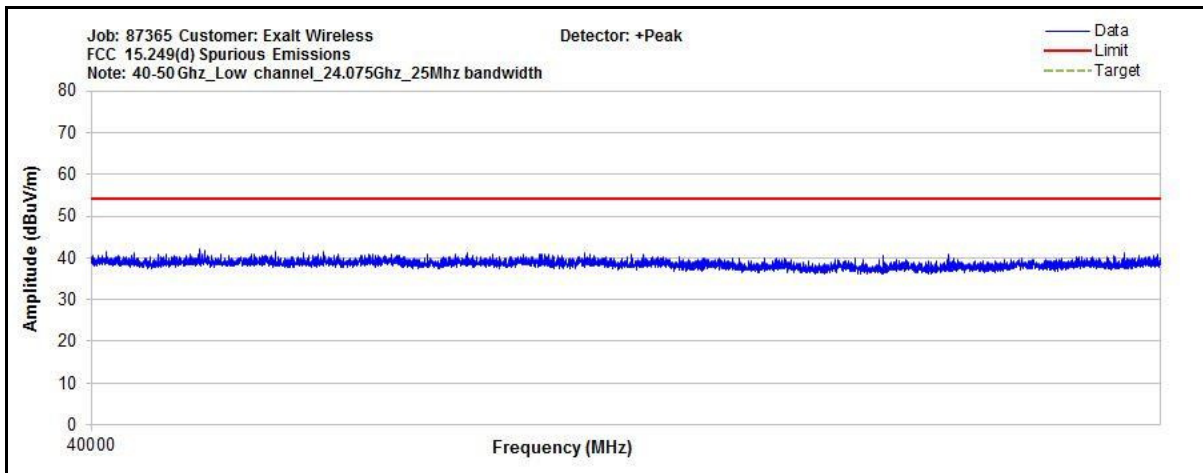

Plot 101. Radiated Spurious Emissions, 25 MHz, Low Channel, 40 GHz - 50 GHz

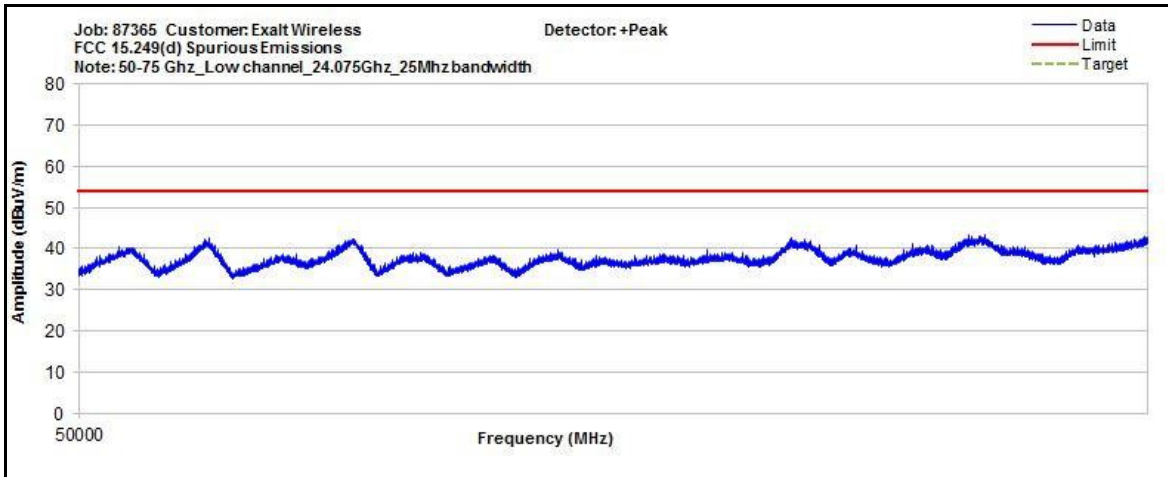

Plot 102. Radiated Spurious Emissions, 25 MHz, Low Channel, 50 GHz – 75 GHz

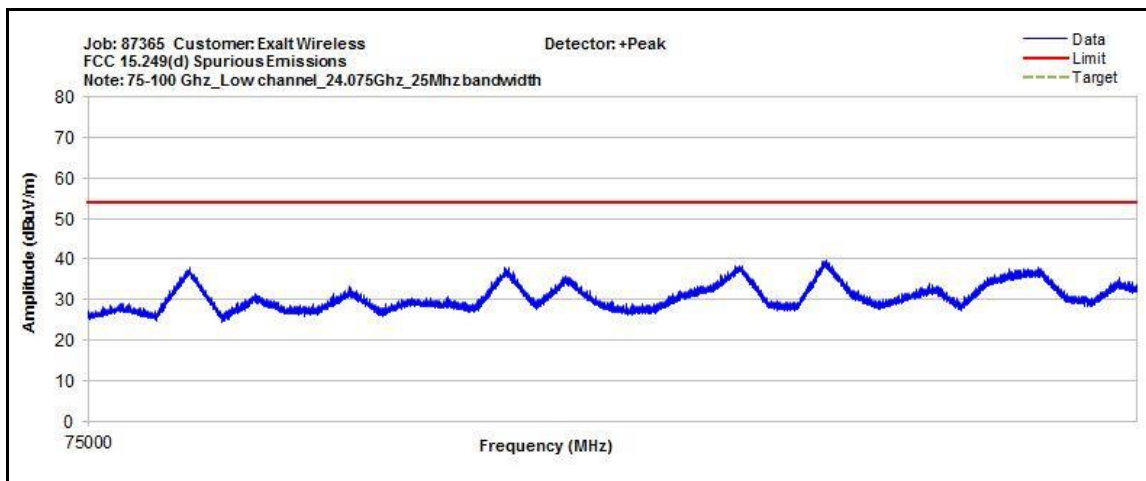

Plot 103. Radiated Spurious Emissions, 25 MHz, Low Channel, 75 GHz – 100 GHz

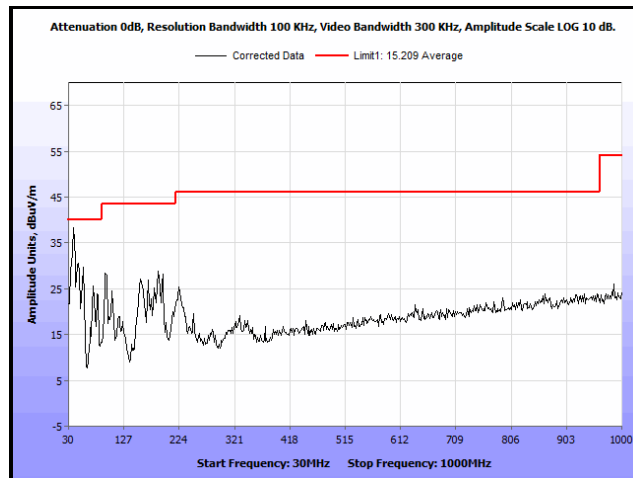

Plot 104. Radiated Spurious Emissions, 25 MHz, Mid Channel, 30 MHz – 1 GHz

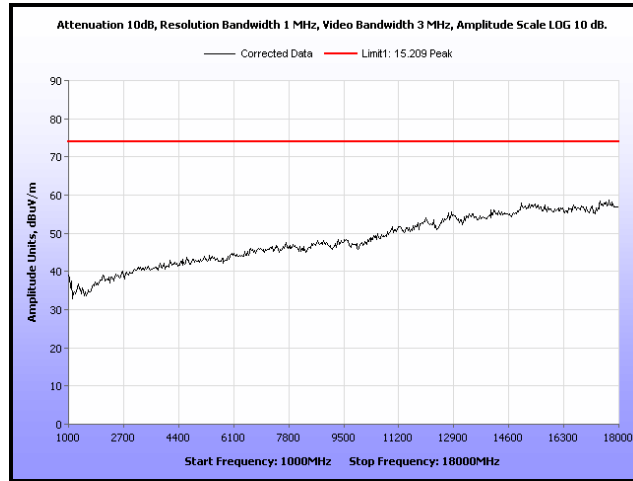

Plot 105. Radiated Spurious Emissions, 25 MHz, Mid Channel, 1 GHz – 18 GHz, Peak

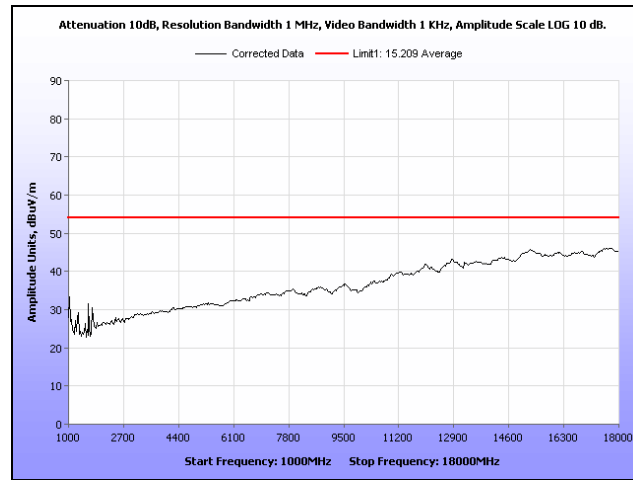

Plot 106. Radiated Spurious Emissions, 25 MHz, Mid Channel, 1 GHz – 18 GHz, Average

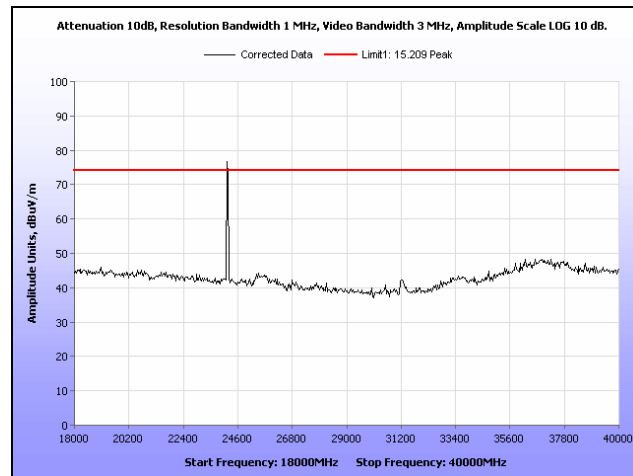

Plot 107. Radiated Spurious Emissions, 25 MHz, Mid Channel, 18 GHz - 40 GHz, Peak

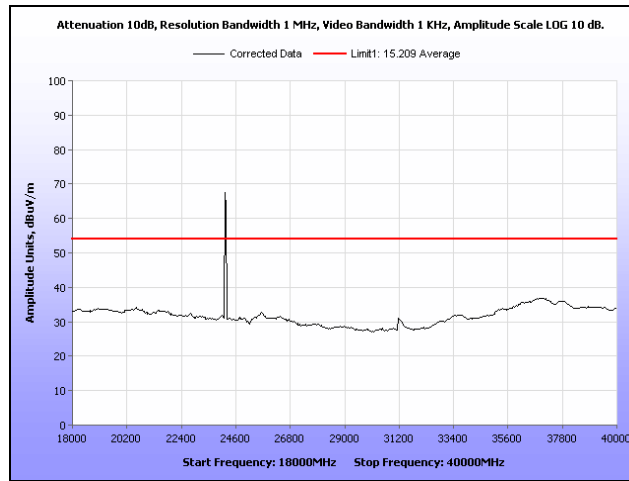

Plot 108. Radiated Spurious Emissions, 25 MHz, Mid Channel, 18 GHz - 40 GHz, Average

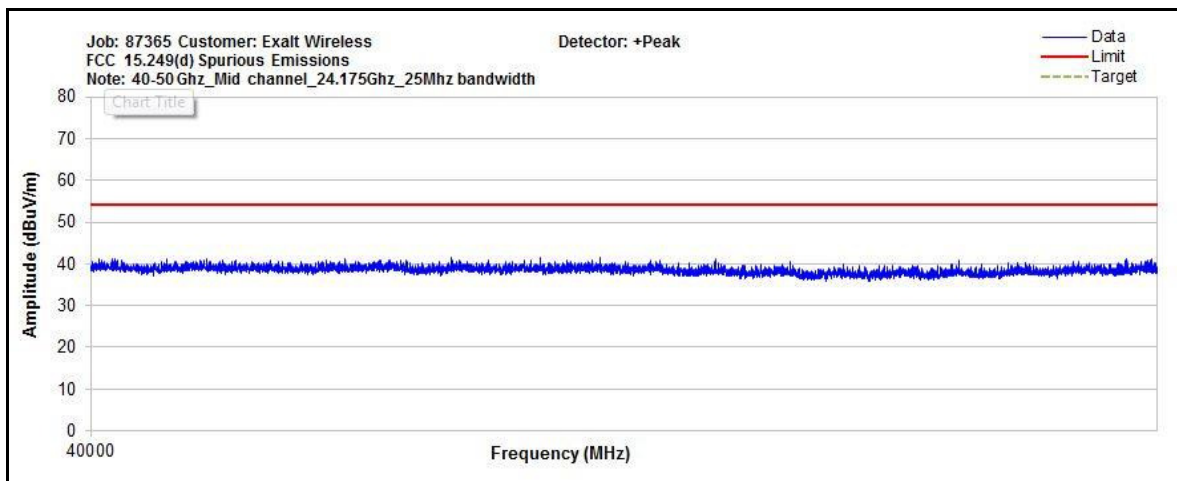

Plot 109. Radiated Spurious Emissions, 25 MHz, Mid Channel, 40 GHz - 50 GHz

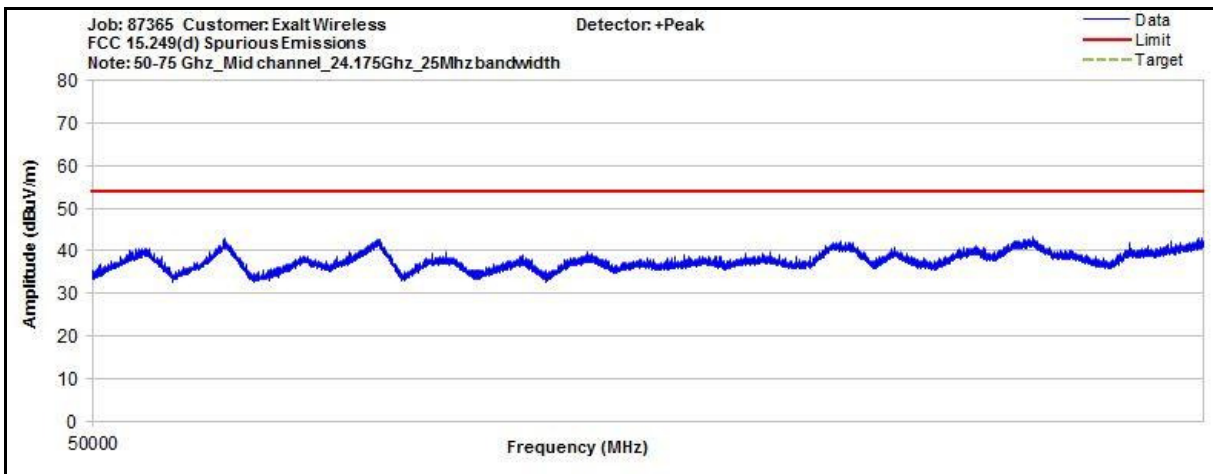

Plot 110. Radiated Spurious Emissions, 25 MHz, Mid Channel, 50 GHz - 75 GHz

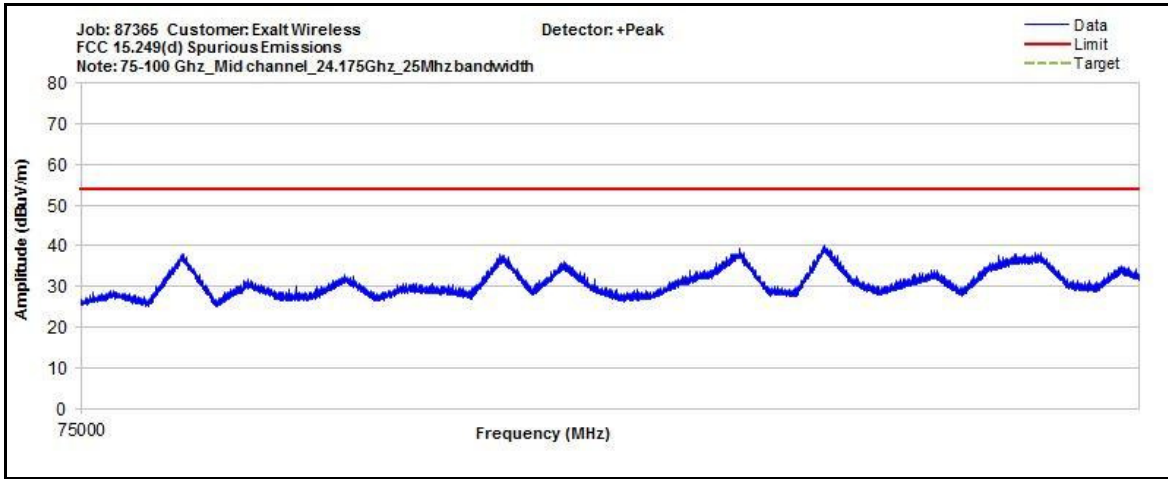

Plot 111. Radiated Spurious Emissions, 25 MHz, Mid Channel, 75 GHz – 100 GHz

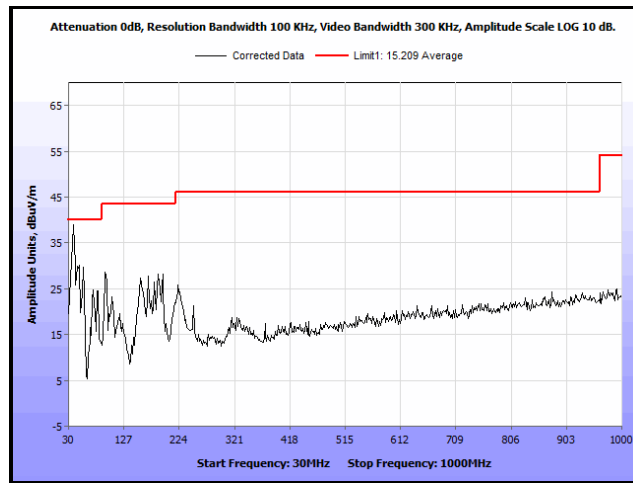

Plot 112. Radiated Spurious Emissions, 25 MHz, High Channel, 30 MHz – 1 GHz

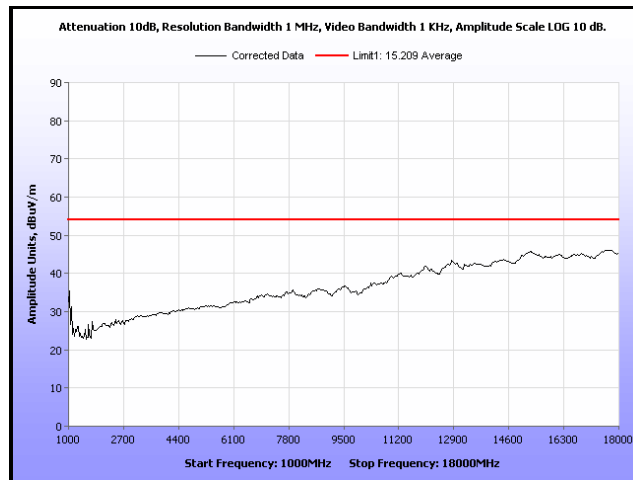

Plot 113. Radiated Spurious Emissions, 25 MHz, High Channel, 1 GHz – 18 GHz, Average

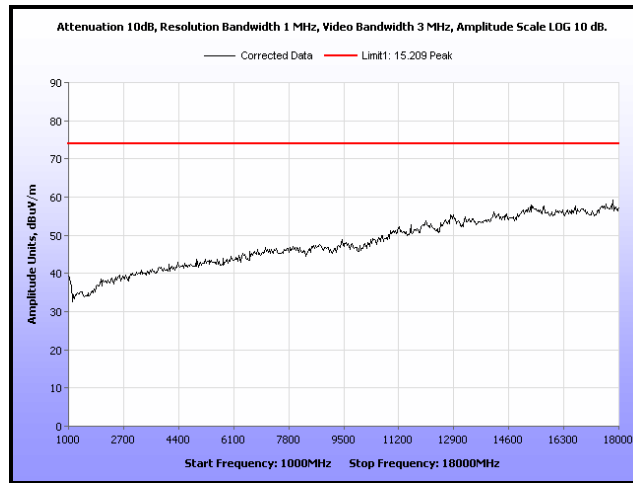

Plot 114. Radiated Spurious Emissions, 25 MHz, High Channel, 1 GHz – 18 GHz, Peak

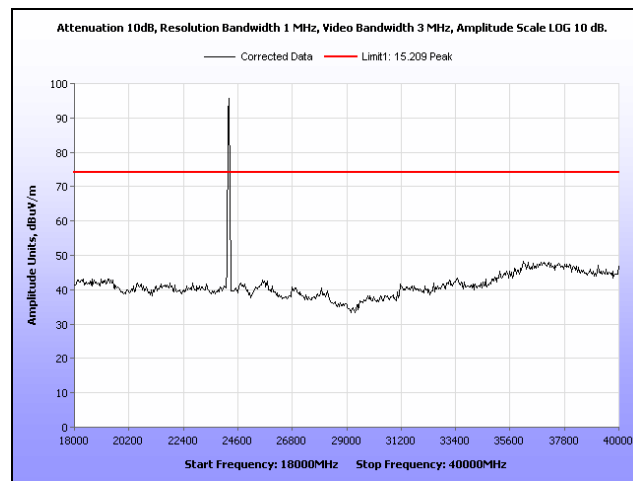

Plot 115. Radiated Spurious Emissions, 25 MHz, High Channel, 18 GHz - 40 GHz, Peak

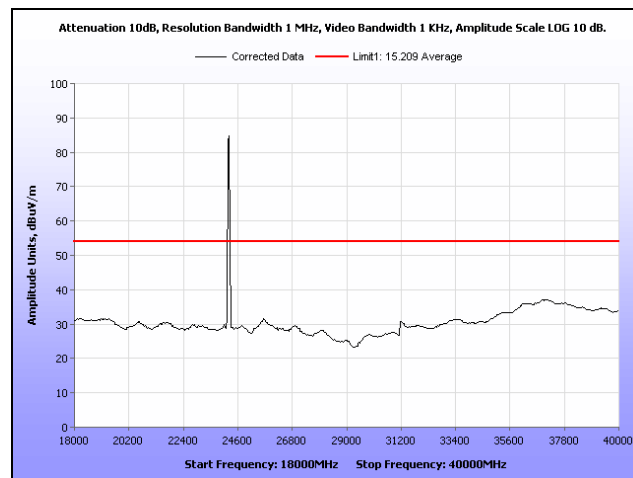

Plot 116. Radiated Spurious Emissions, 25 MHz, High Channel, 18 GHz - 40 GHz, Average

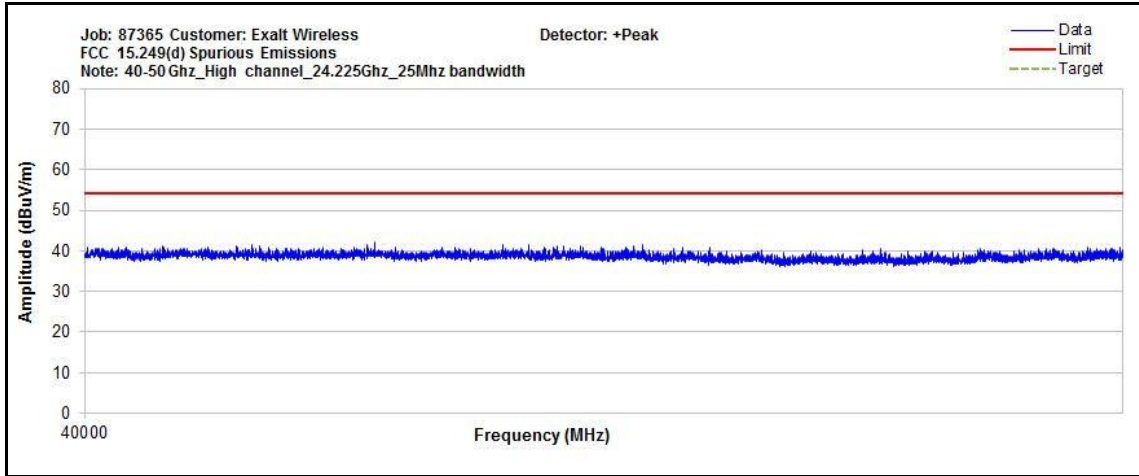

Plot 117. Radiated Spurious Emissions, 25 MHz, High Channel, 40 GHz – 50 GHz

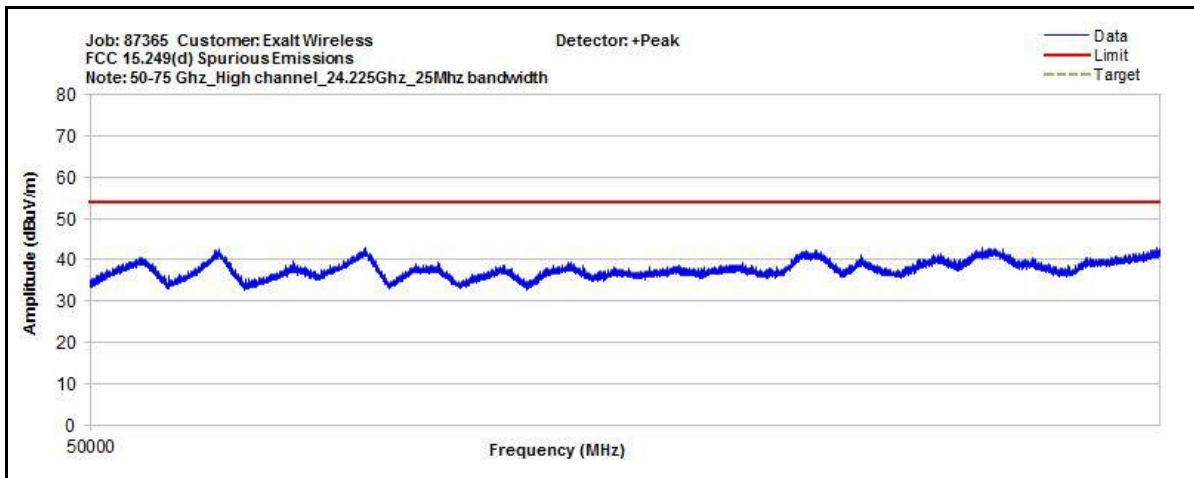

Plot 118. Radiated Spurious Emissions, 25 MHz, High Channel, 50 GHz – 75 GHz

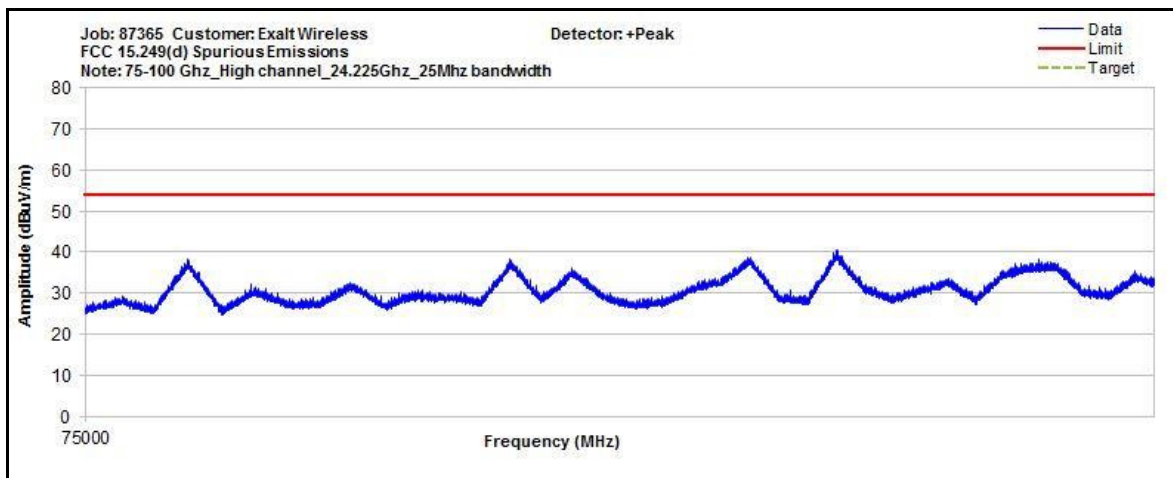

Plot 119. Radiated Spurious Emissions, 25 MHz, High Channel, 75 GHz – 100 GHz

Radiated Spurious Emissions, 30 MHz

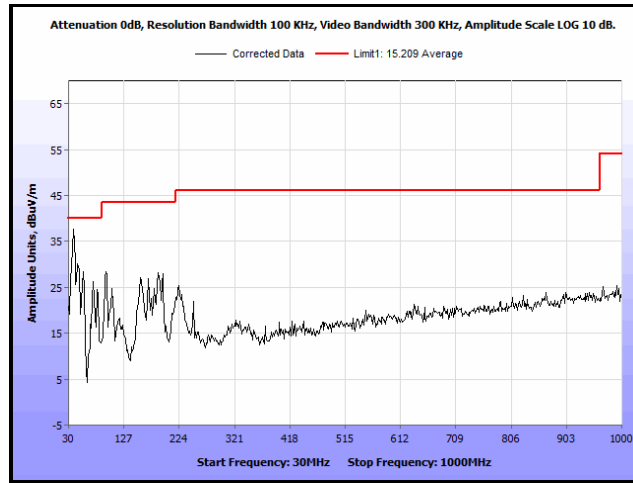

Plot 120. Radiated Spurious Emissions, 30 MHz, Low Channel, 30 MHz – 1 GHz

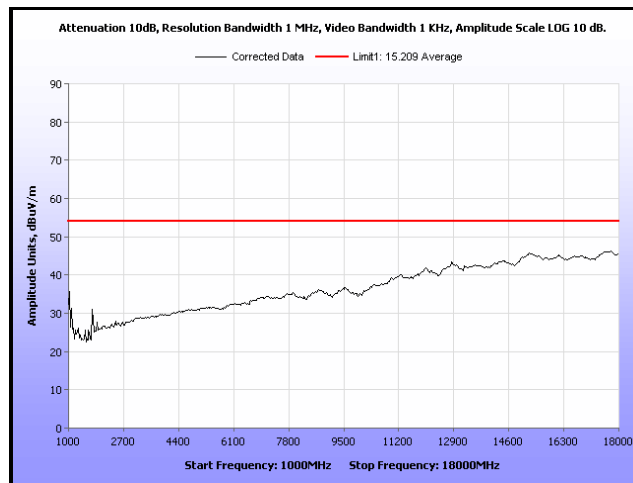

Plot 121. Radiated Spurious Emissions, 30 MHz, Low Channel, 1 GHz – 18 GHz, Average

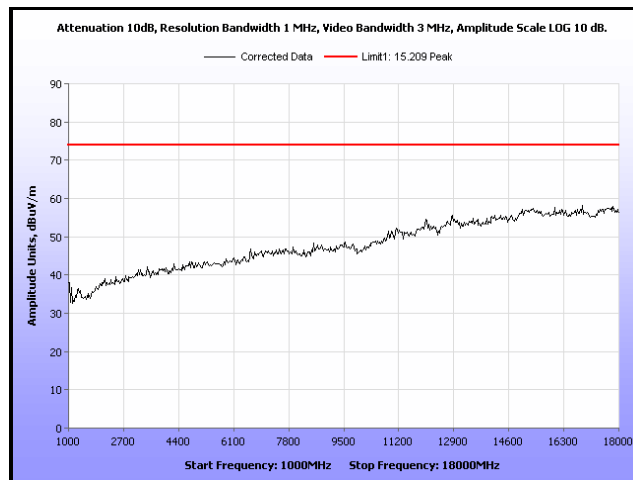

Plot 122. Radiated Spurious Emissions, 30 MHz, Low Channel, 1 GHz – 18 GHz, Peak

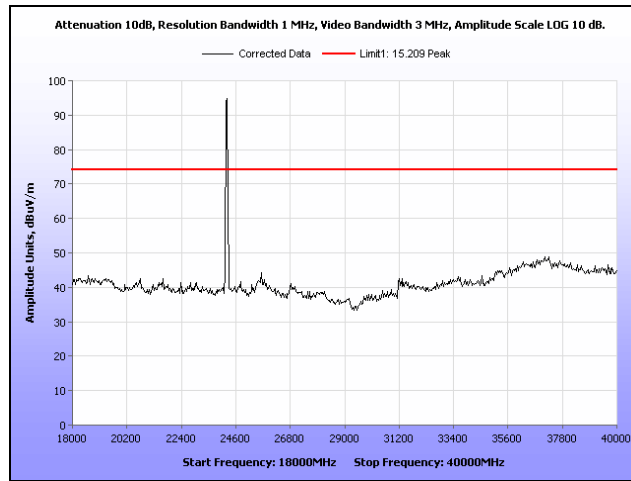

Plot 123. Radiated Spurious Emissions, 30 MHz, Low Channel, 18 GHz - 40 GHz, Peak

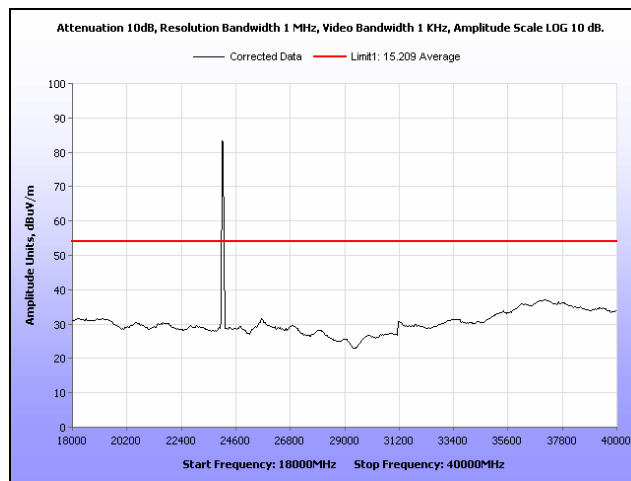

Plot 124. Radiated Spurious Emissions, 30 MHz, Low Channel, 18 GHz - 40 GHz, Average

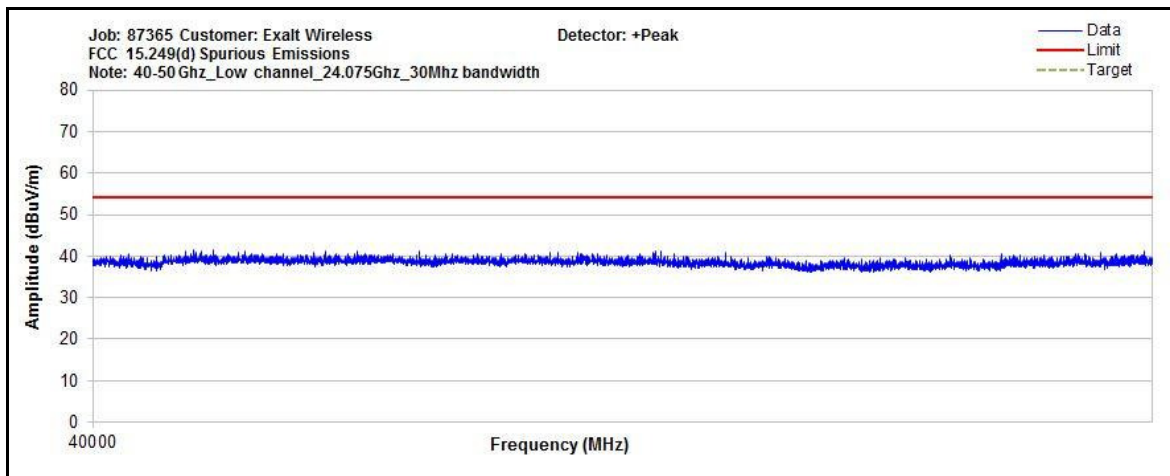

Plot 125. Radiated Spurious Emissions, 30 MHz, Low Channel, 40 GHz - 50 GHz

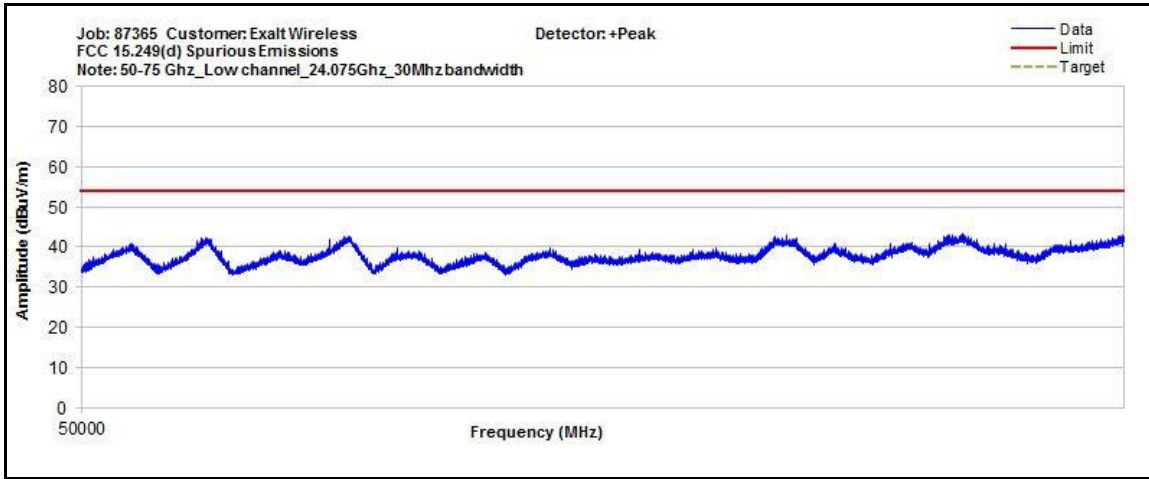

Plot 126. Radiated Spurious Emissions, 30 MHz, Low Channel, 50 GHz – 75 GHz

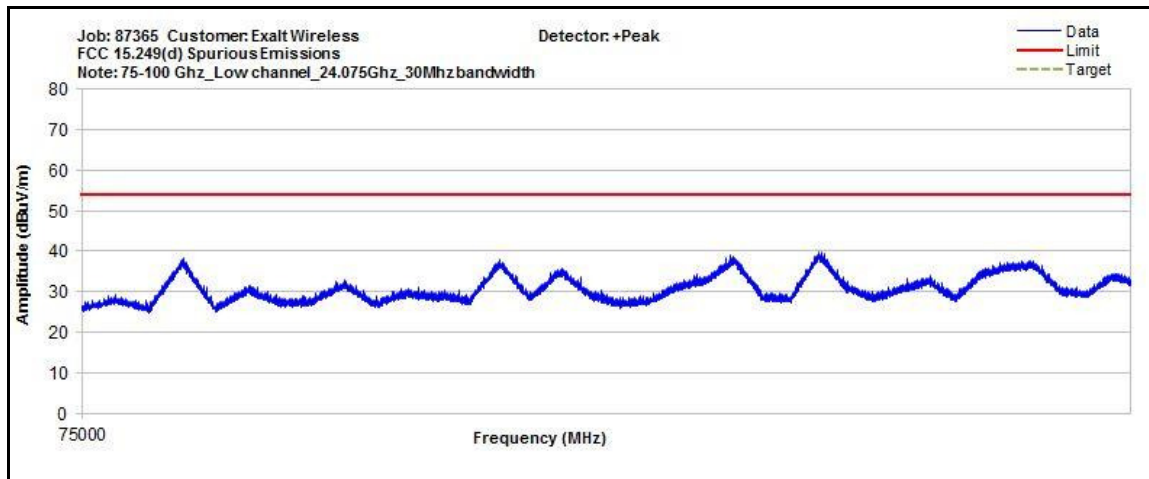

Plot 127. Radiated Spurious Emissions, 30 MHz, Low Channel, 75 GHz – 100 GHz

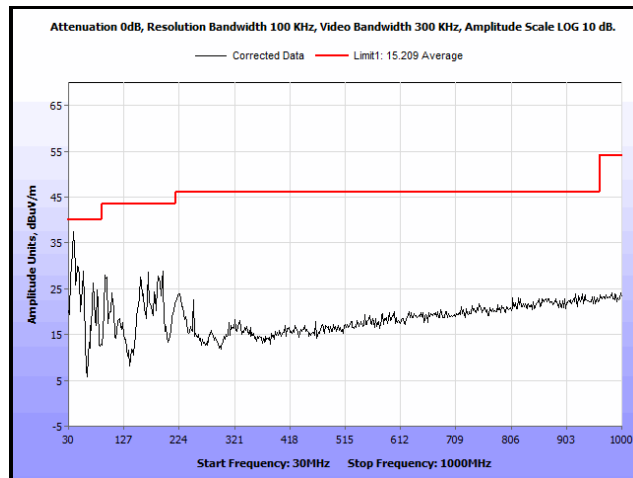

Plot 128. Radiated Spurious Emissions, 30 MHz, Mid Channel, 30 MHz – 1 GHz

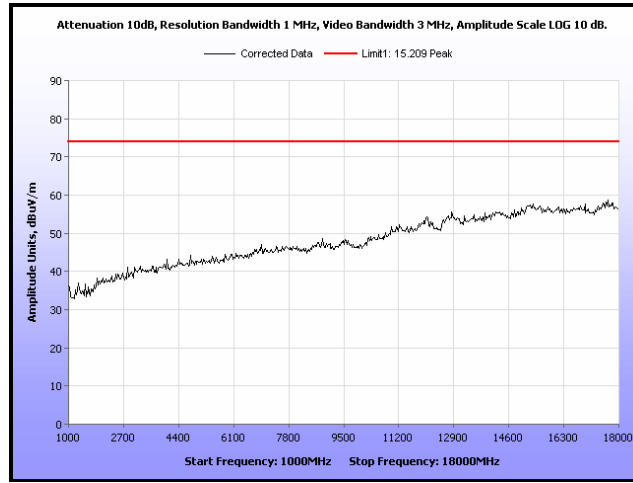

Plot 129. Radiated Spurious Emissions, 30 MHz, Mid Channel, 1 GHz – 18 GHz, Peak

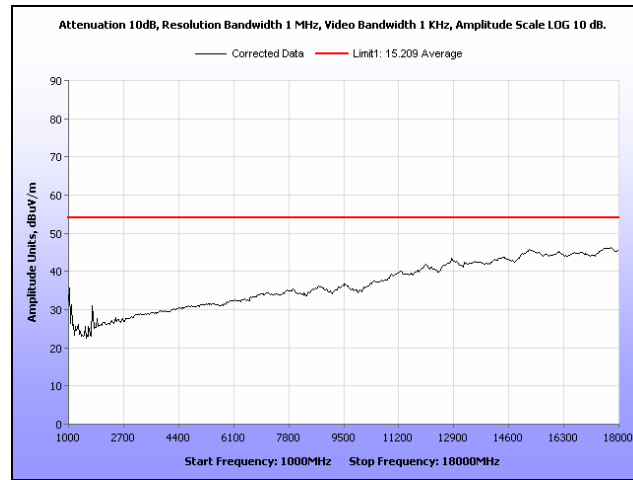

Plot 130. Radiated Spurious Emissions, 30 MHz, Mid Channel, 1 GHz – 18 GHz, Peak

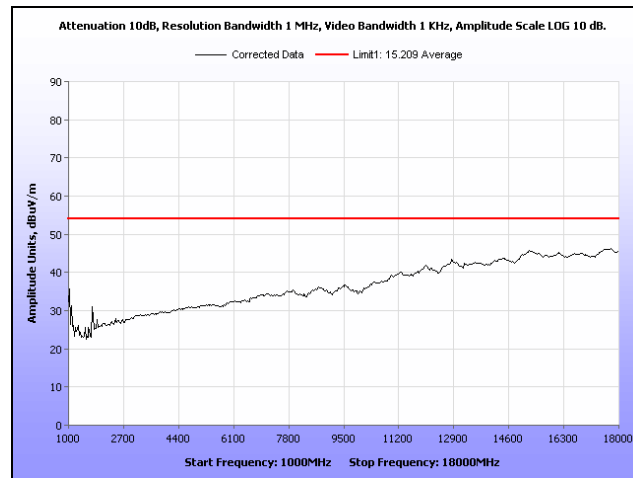

Plot 131. Radiated Spurious Emissions, 30 MHz, Mid Channel, 1 GHz – 18 GHz, Average

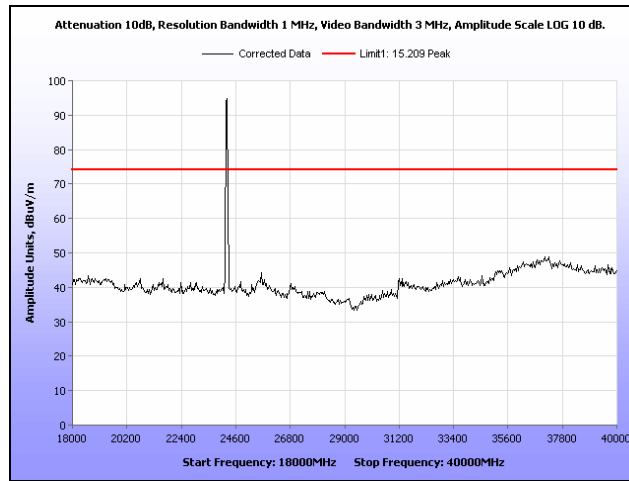

Plot 132. Radiated Spurious Emissions, 30 MHz, Mid Channel, 18 GHz - 40 GHz, Peak

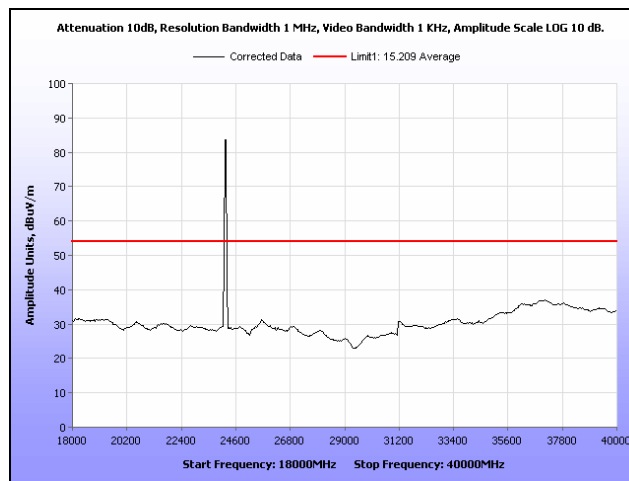

Plot 133. Radiated Spurious Emissions, 30 MHz, Mid Channel, 18 GHz - 40 GHz, Average

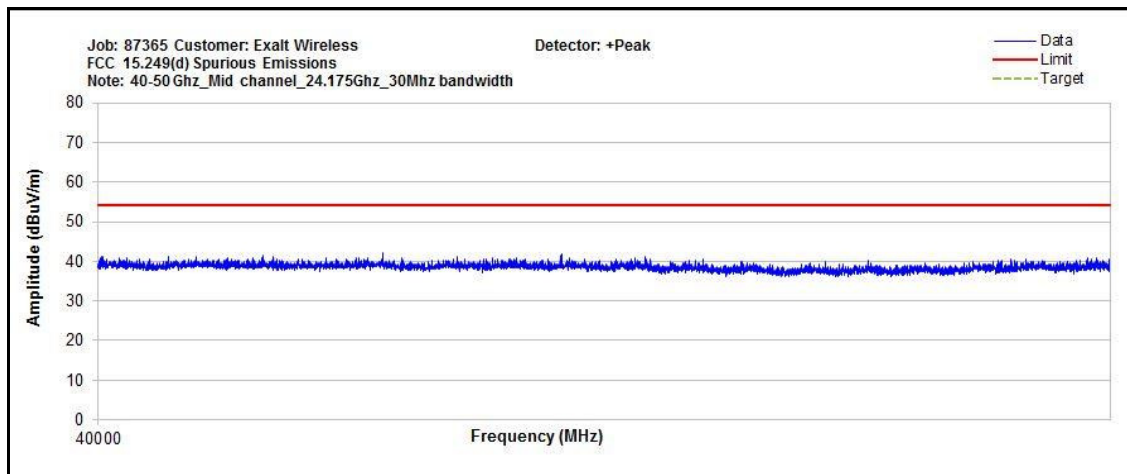

Plot 134. Radiated Spurious Emissions, 30 MHz, Mid Channel, 40 GHz - 50 GHz

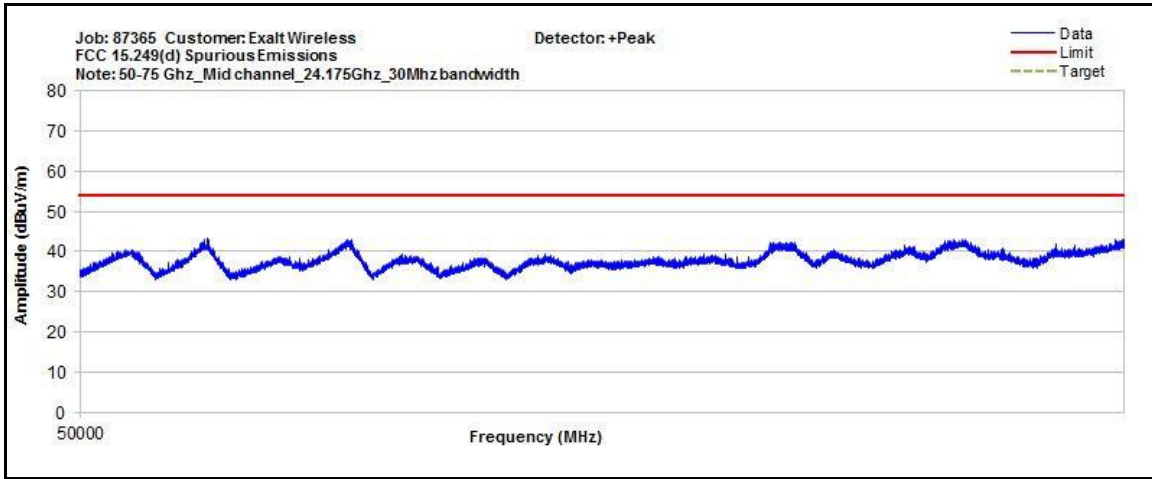

Plot 135. Radiated Spurious Emissions, 30 MHz, Mid Channel, 50 GHz – 75 GHz

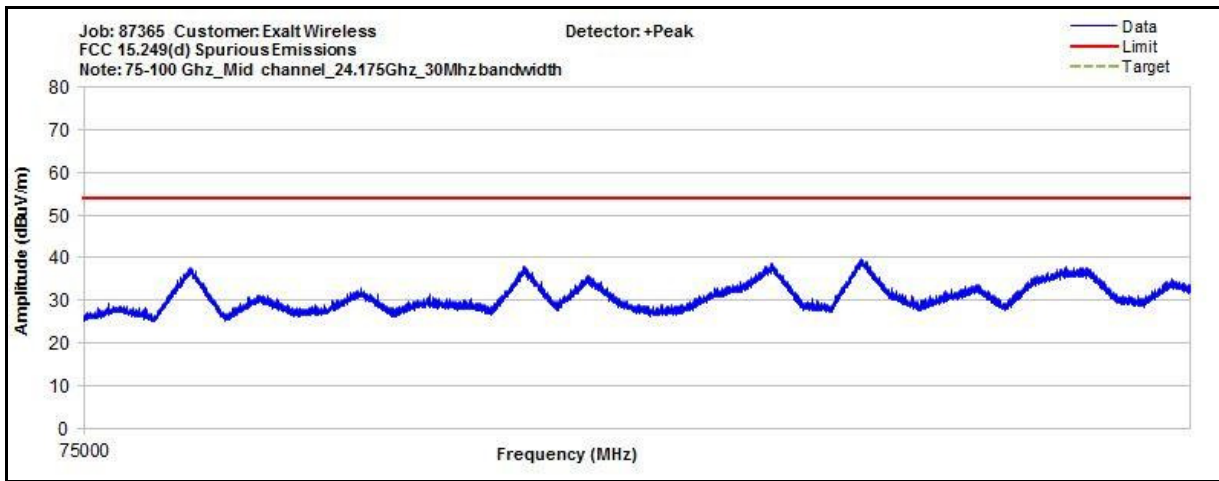

Plot 136. Radiated Spurious Emissions, 30 MHz, Mid Channel, 75 GHz – 100 GHz

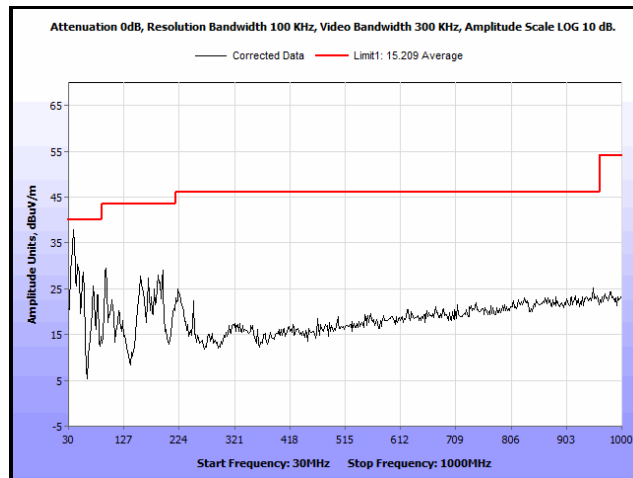

Plot 137. Radiated Spurious Emissions, 30 MHz, High Channel, 30 MHz – 1 GHz

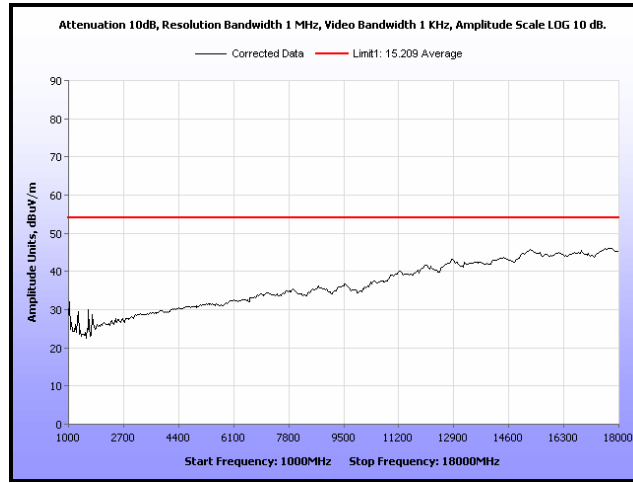

Plot 138. Radiated Spurious Emissions, 30 MHz, High Channel, 1 GHz – 18 GHz, Average

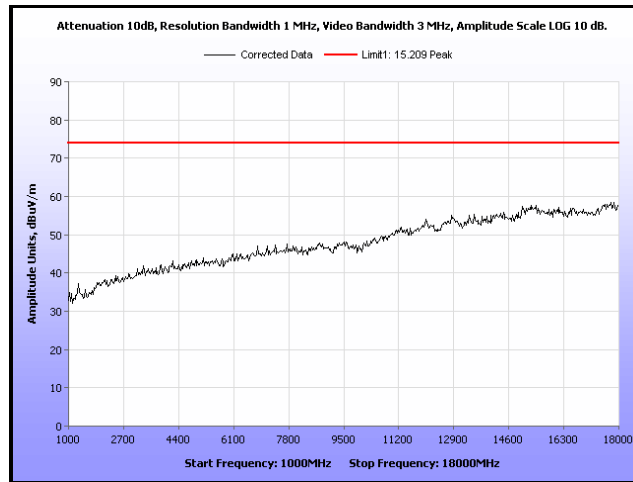

Plot 139. Radiated Spurious Emissions, 30 MHz, High Channel, 1 GHz – 18 GHz, Peak

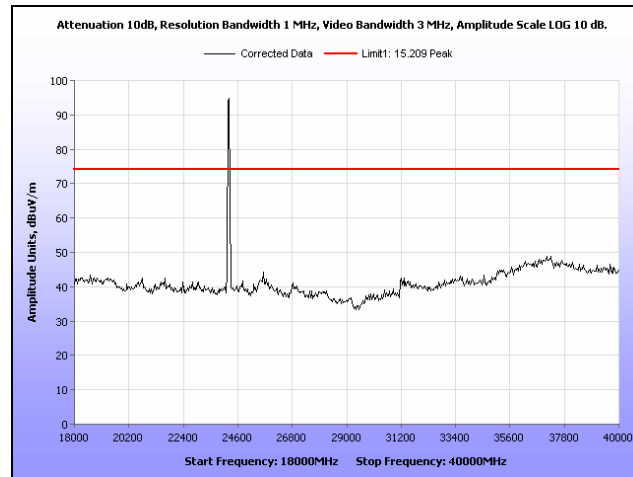

Plot 140. Radiated Spurious Emissions, 30 MHz, High Channel, 18 GHz - 40 GHz, Peak

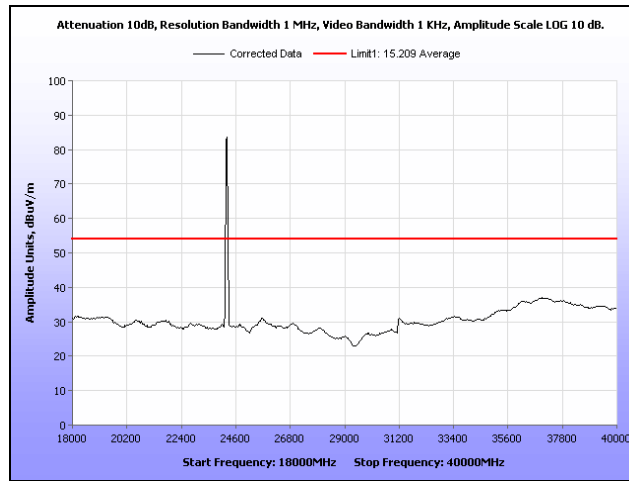

Plot 141. Radiated Spurious Emissions, 30 MHz, High Channel, 18 GHz - 40 GHz, Average

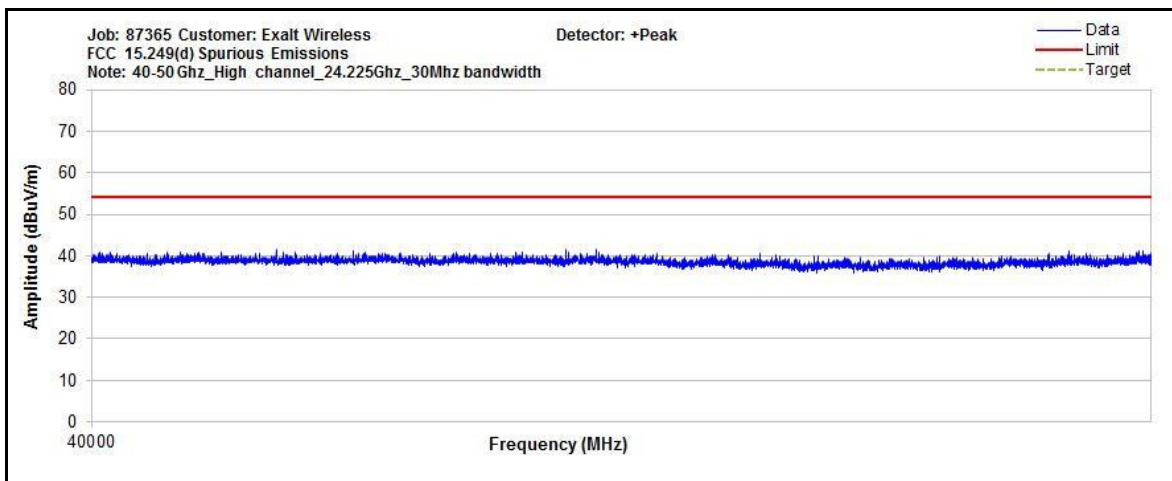

Plot 142. Radiated Spurious Emissions, 30 MHz, High Channel, 40 GHz - 50 GHz

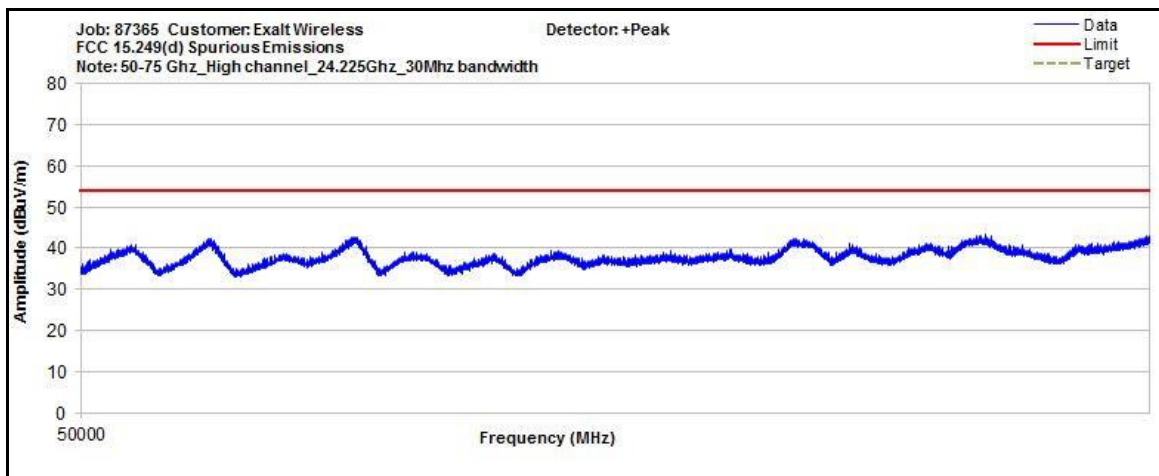

Plot 143. Radiated Spurious Emissions, 30 MHz, High Channel, 50 GHz - 75 GHz

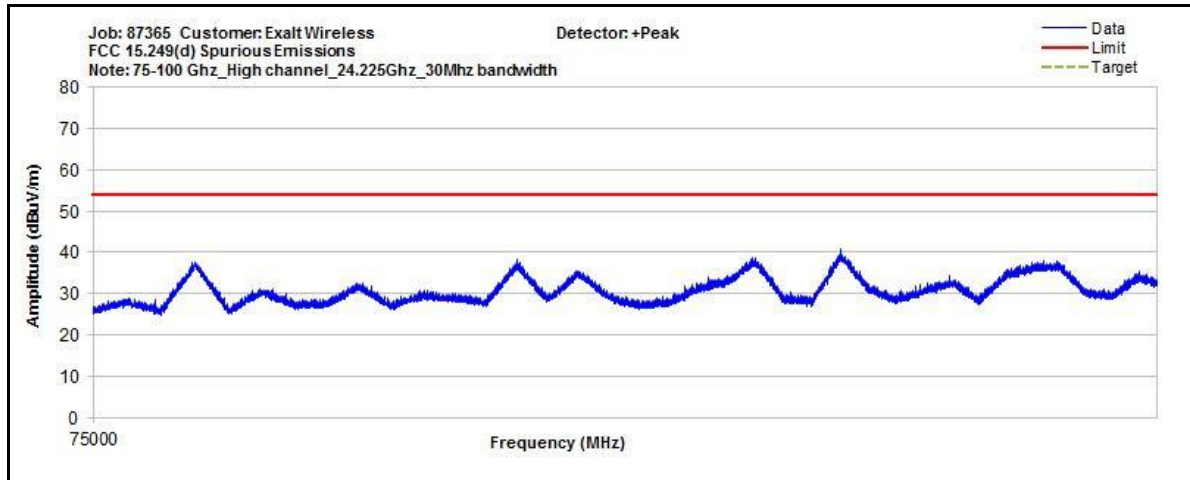

Plot 144. Radiated Spurious Emissions, 30 MHz, High Channel, 75 GHz – 100 GHz

Radiated Spurious Emissions, 40 MHz

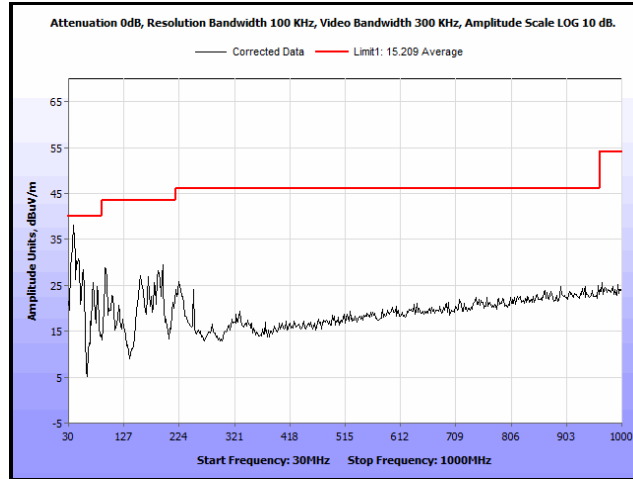

Plot 145. Radiated Spurious Emissions, 40 MHz, Low Channel, 30 MHz – 1 GHz

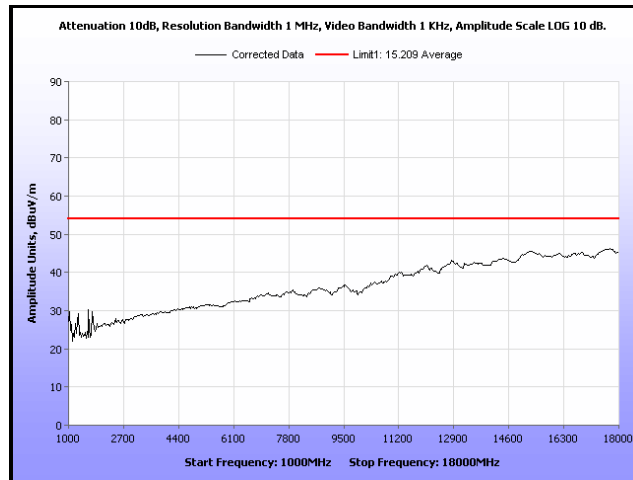

Plot 146. Radiated Spurious Emissions, 40 MHz, Low Channel, 1 GHz – 18 GHz, Average

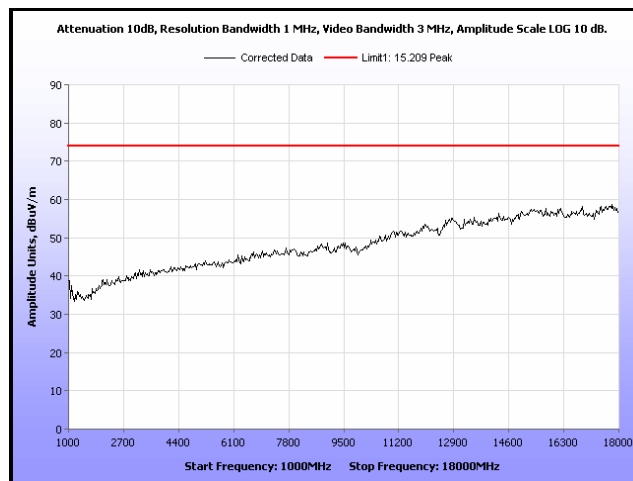

Plot 147. Radiated Spurious Emissions, 40 MHz, Low Channel, 1 GHz – 18 GHz, Peak

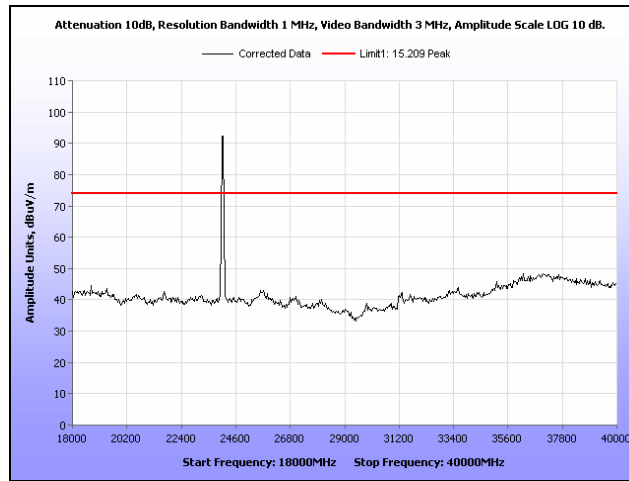

Plot 148. Radiated Spurious Emissions, 40 MHz, Low Channel, 18 GHz - 40 GHz, Peak

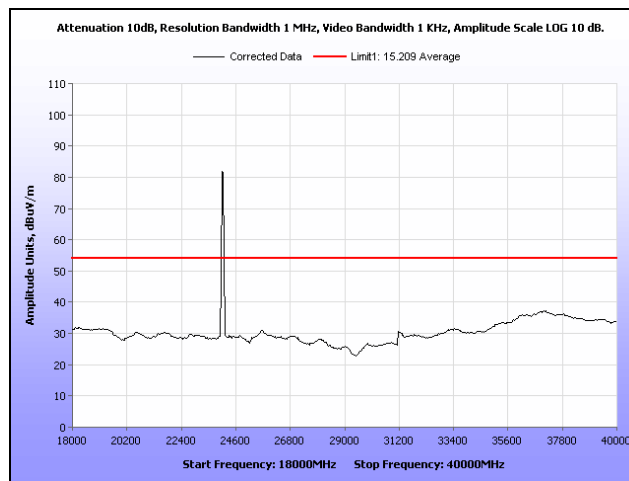

Plot 149. Radiated Spurious Emissions, 40 MHz, Low Channel, 18 GHz - 40 GHz, Average

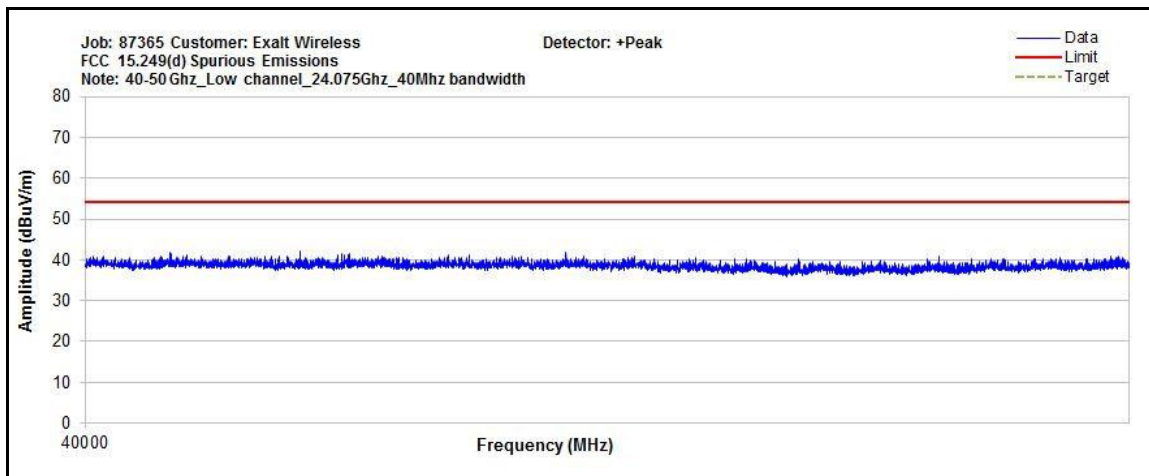

Plot 150. Radiated Spurious Emissions, 40 MHz, Low Channel, 40 GHz - 50 GHz

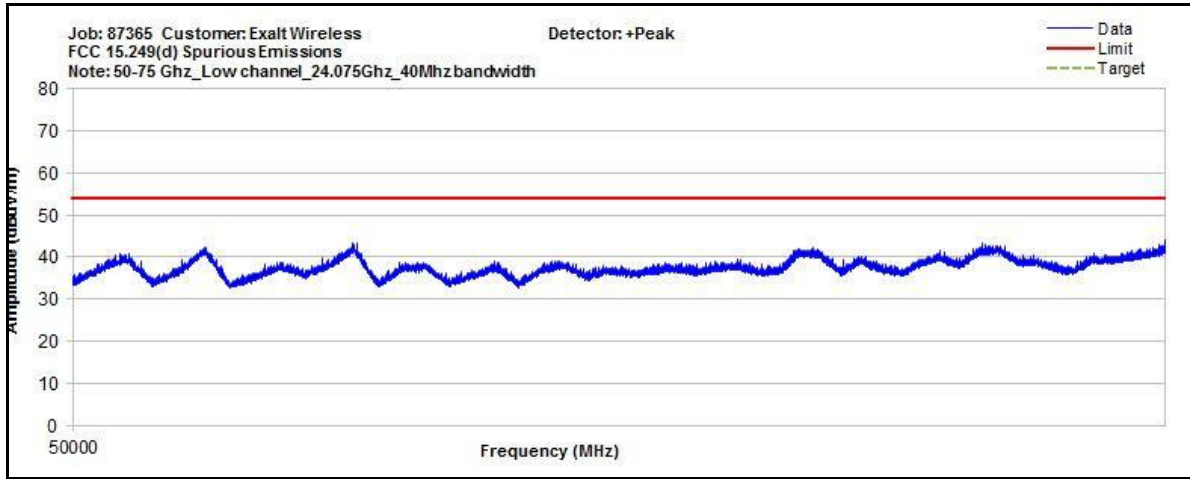

Plot 151. Radiated Spurious Emissions, 40 MHz, Low Channel, 50 GHz – 75 GHz

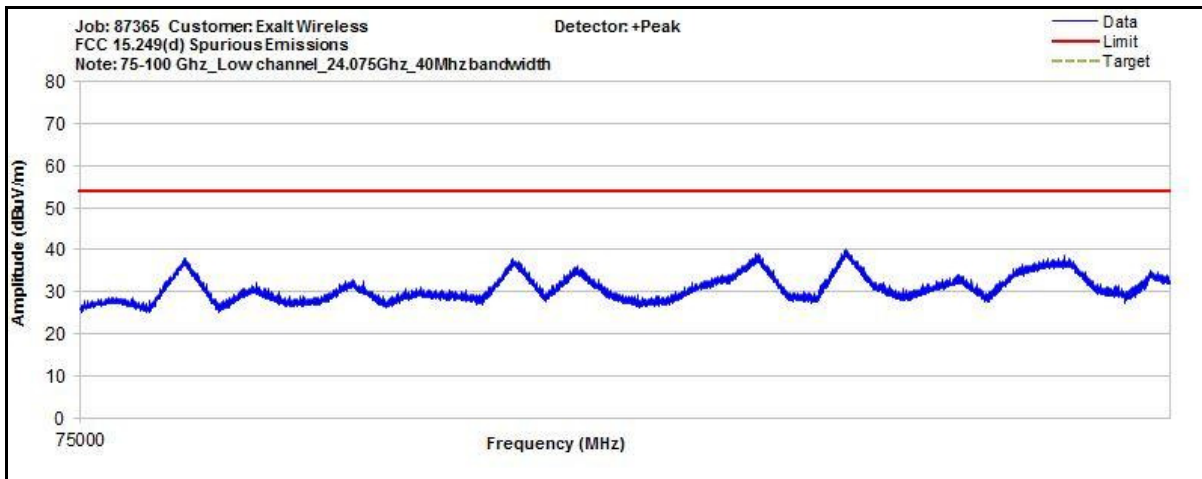

Plot 152. Radiated Spurious Emissions, 40 MHz, Low Channel, 75 GHz – 100 GHz

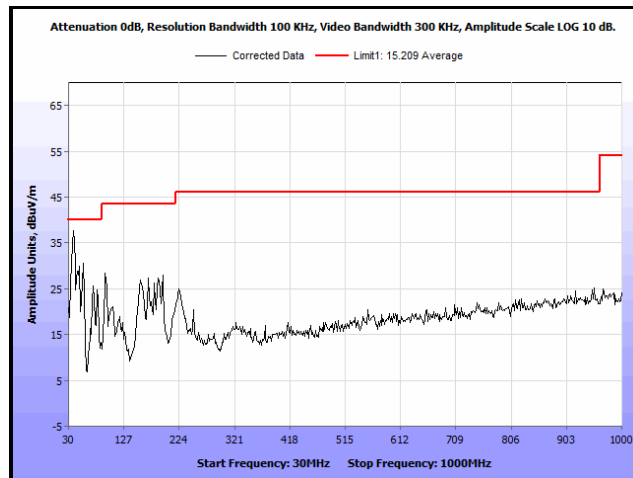

Plot 153. Radiated Spurious Emissions, 40 MHz, Mid Channel, 30 MHz – 1 GHz

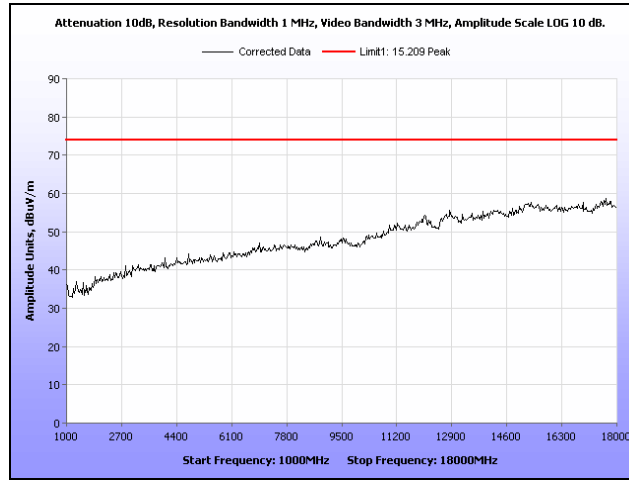

Plot 154. Radiated Spurious Emissions, 40 MHz, Mid Channel, 1 GHz – 18 GHz, Peak

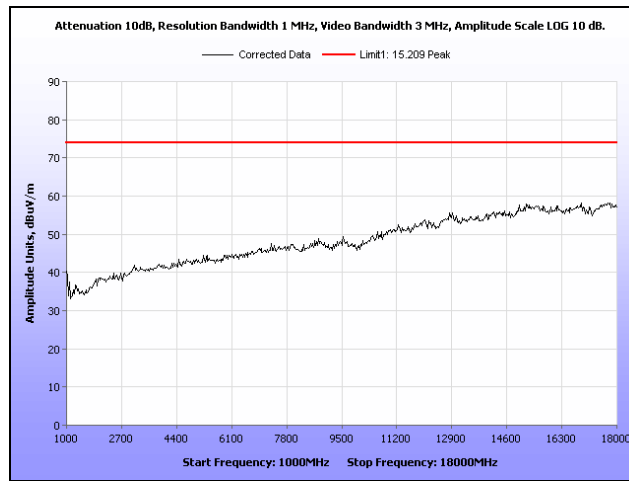

Plot 155. Radiated Spurious Emissions, 40 MHz, Mid Channel, 1 GHz – 18 GHz, Average

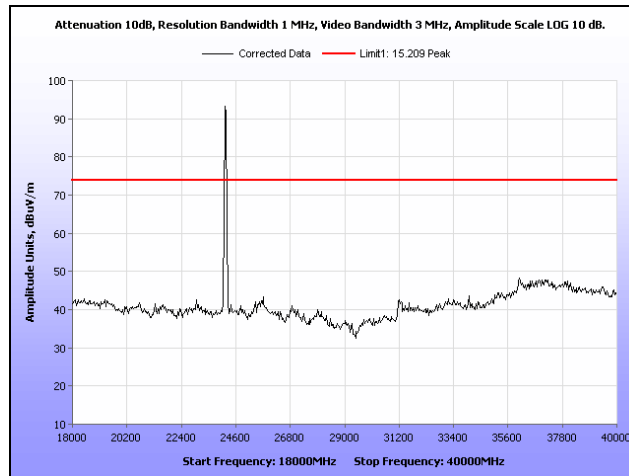

Plot 156. Radiated Spurious Emissions, 40 MHz, Mid Channel, 18 GHz – 40 GHz, Peak

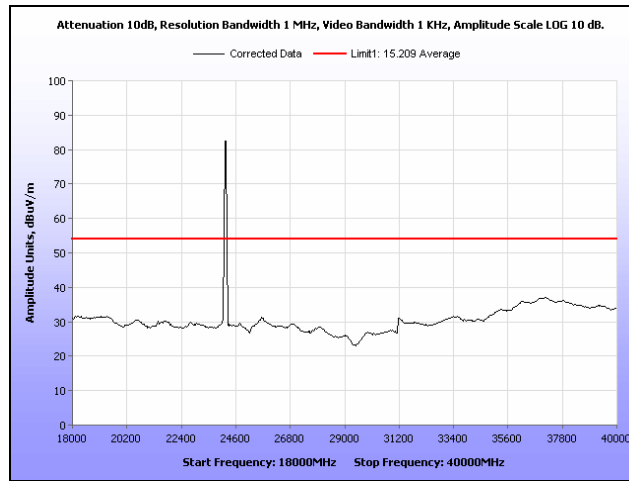

Plot 157. Radiated Spurious Emissions, 40 MHz, Mid Channel, 18 GHz – 40 GHz, Average

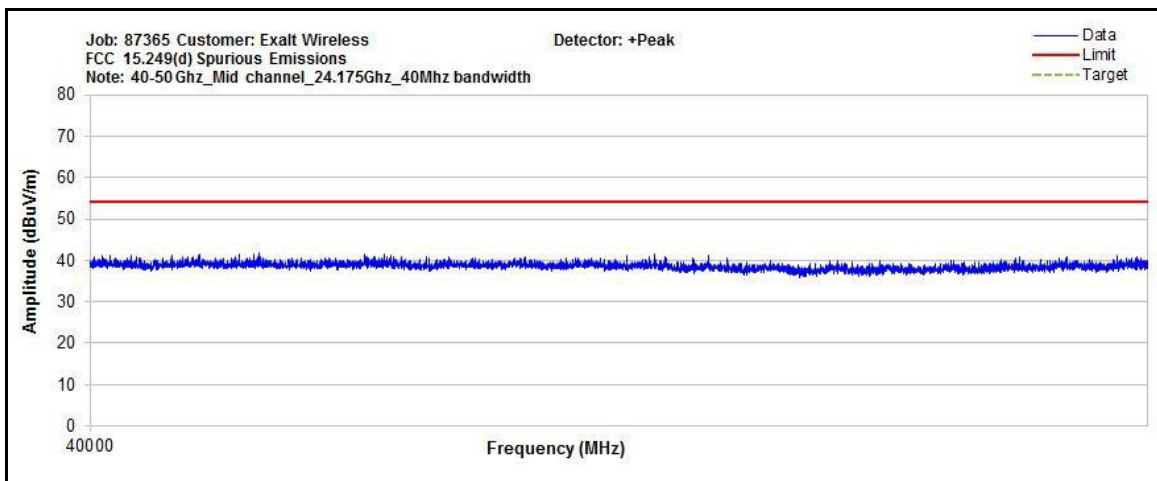

Plot 158. Radiated Spurious Emissions, 40 MHz, Mid Channel, 40 GHz – 50 GHz

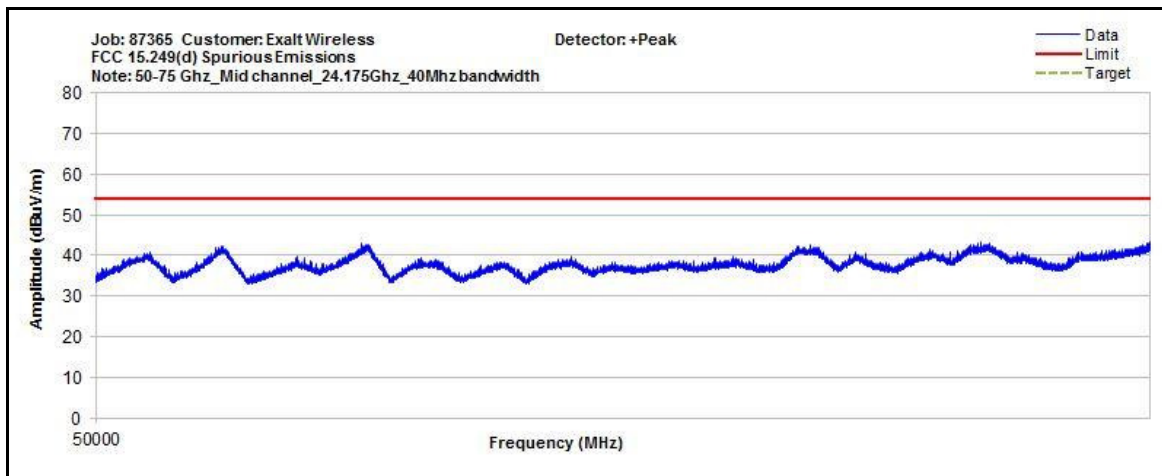

Plot 159. Radiated Spurious Emissions, 40 MHz, Mid Channel, 50 GHz – 75 GHz

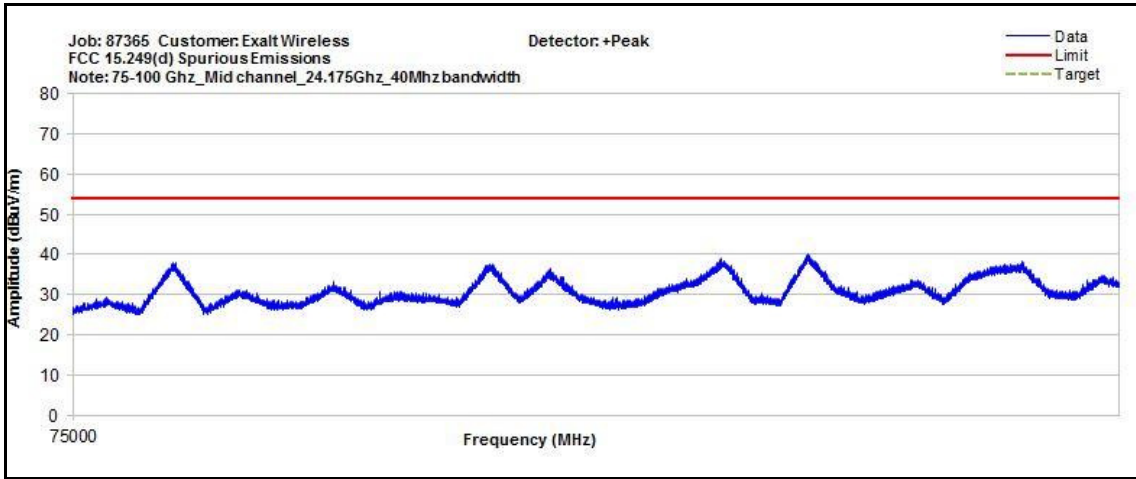

Plot 160. Radiated Spurious Emissions, 40 MHz, Mid Channel, 75 GHz – 100 GHz

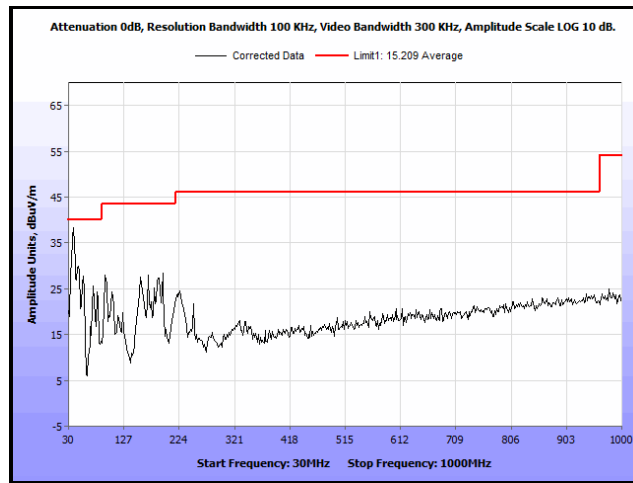

Plot 161. Radiated Spurious Emissions, 40 MHz, High Channel, 30 MHz – 1 GHz

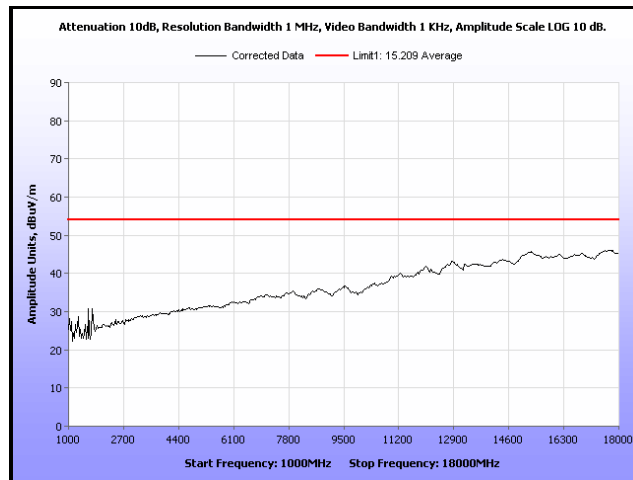

Plot 162. Radiated Spurious Emissions, 40 MHz, High Channel, 1 GHz – 18 GHz, Average

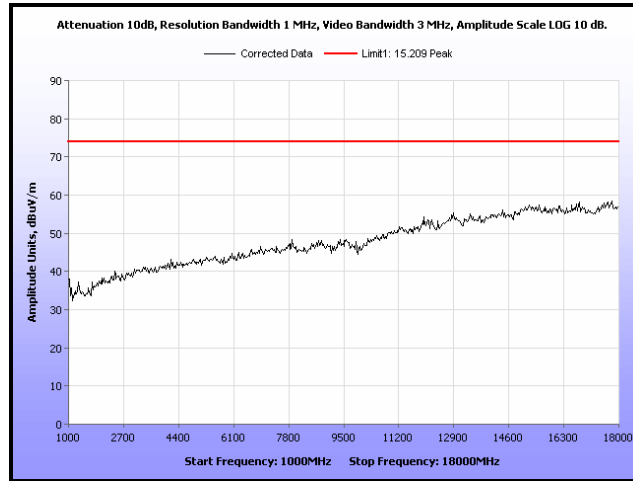

Plot 163. Radiated Spurious Emissions, 40 MHz, High Channel, 1 GHz – 18 GHz, Peak

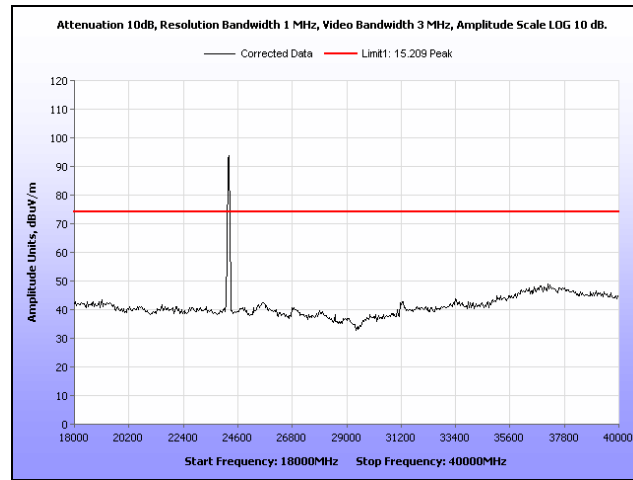

Plot 164. Radiated Spurious Emissions, 40 MHz, Low Channel, 18 GHz - 40 GHz, Peak

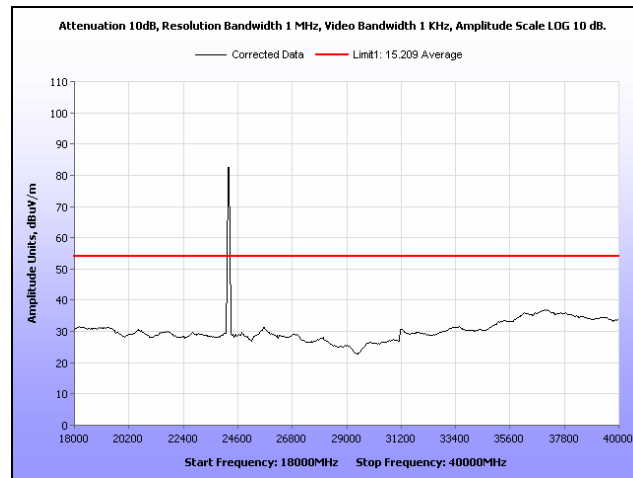

Plot 165. Radiated Spurious Emissions, 40 MHz, High Channel, 18 GHz - 40 GHz, Average

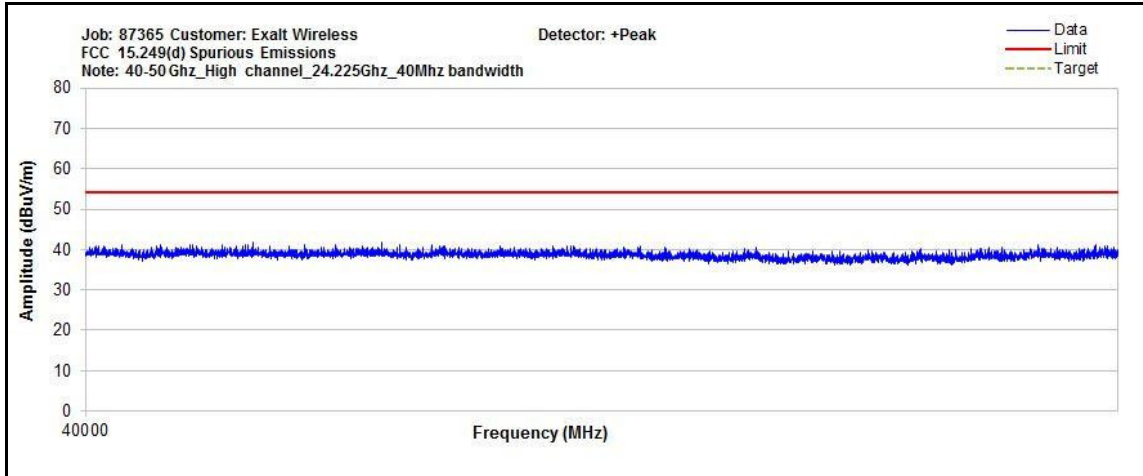

Plot 166. Radiated Spurious Emissions, 40 MHz, High Channel, 40 GHz – 50 GHz

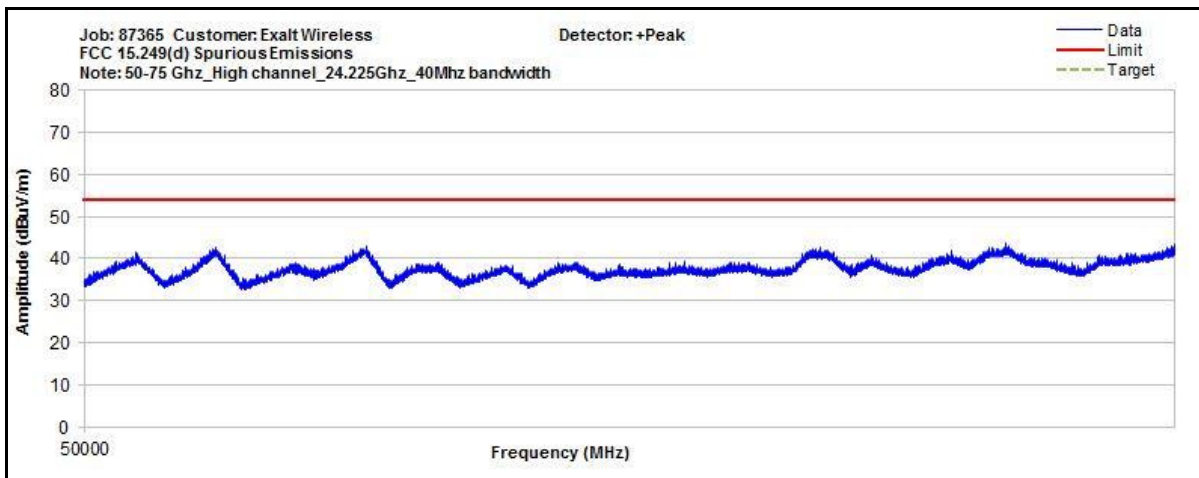

Plot 167. Radiated Spurious Emissions, 40 MHz, High Channel, 50 GHz – 75 GHz

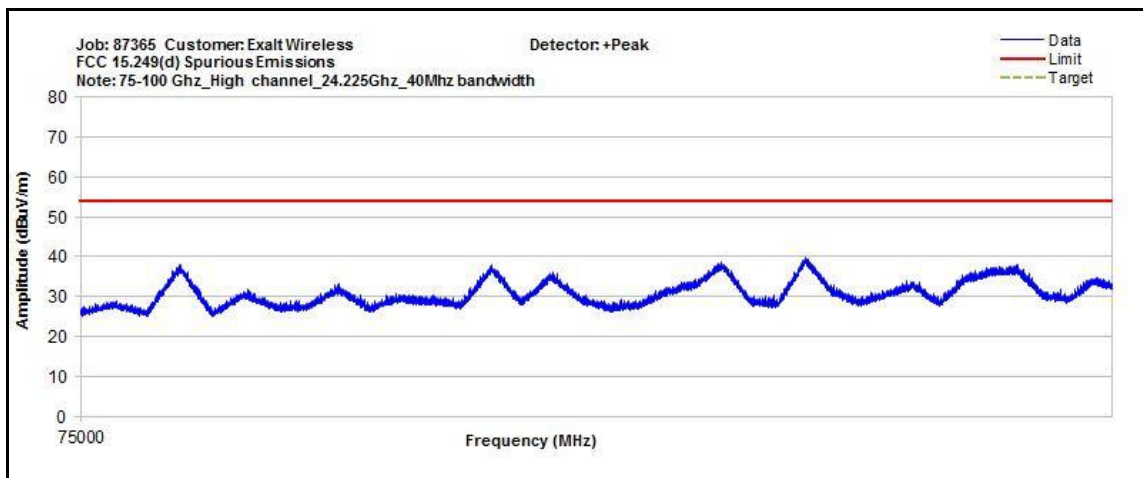

Plot 168. Radiated Spurious Emissions, 40 MHz, High Channel, 75 GHz – 100 GHz

Radiated Spurious Emissions, 50 MHz

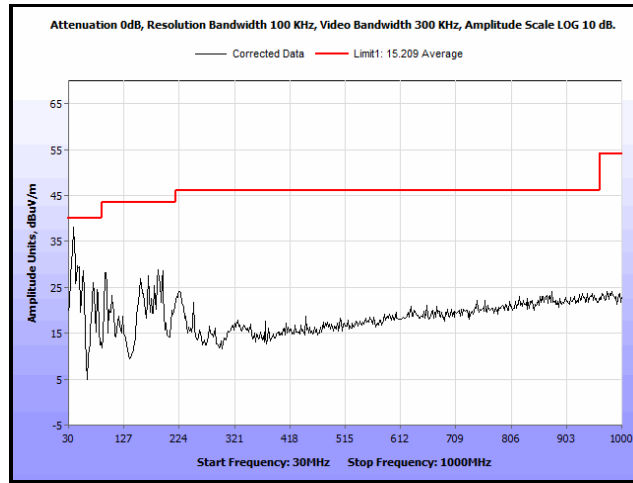

Plot 169. Radiated Spurious Emissions, 50 MHz, Low Channel, 30 MHz – 1 GHz

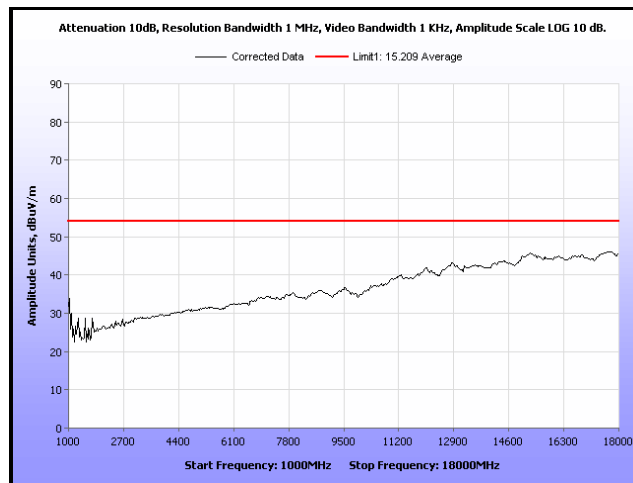

Plot 170. Radiated Spurious Emissions, 50 MHz, Low Channel, 1 GHz – 18 GHz, Average

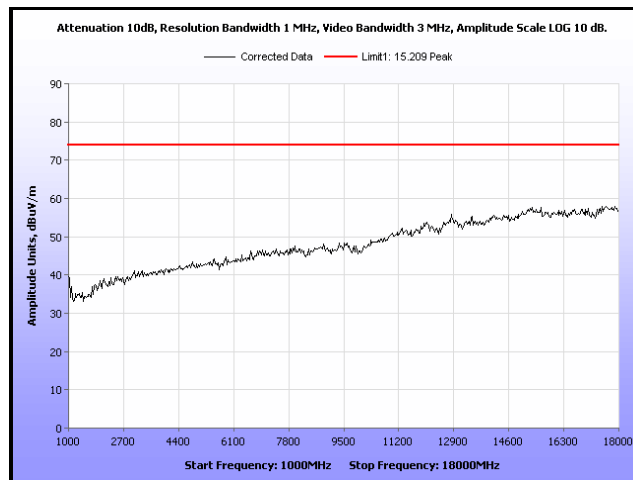

Plot 171. Radiated Spurious Emissions, 50 MHz, Low Channel, 1 GHz – 18 GHz, Peak

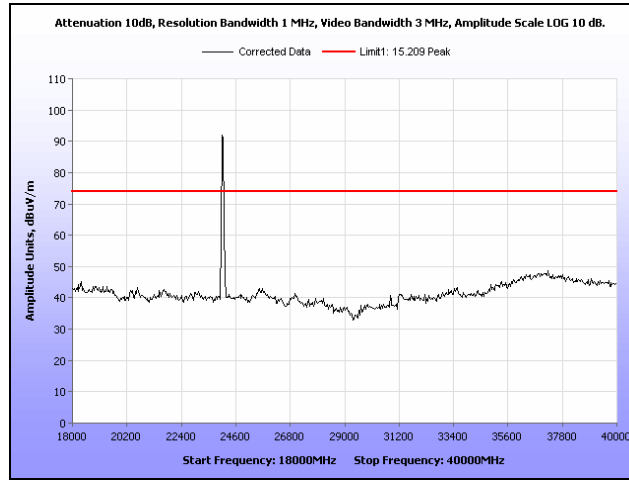

Plot 172. Radiated Spurious Emissions, 50 MHz, Low Channel, 18 GHz - 40 GHz, Peak

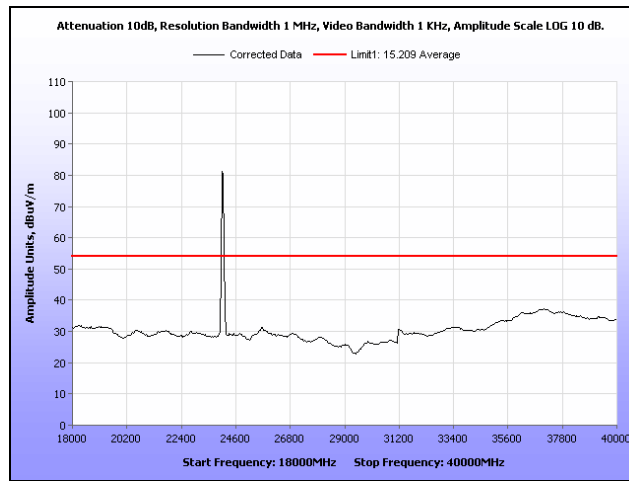

Plot 173. Radiated Spurious Emissions, 50 MHz, Low Channel, 18 GHz - 40 GHz, Average

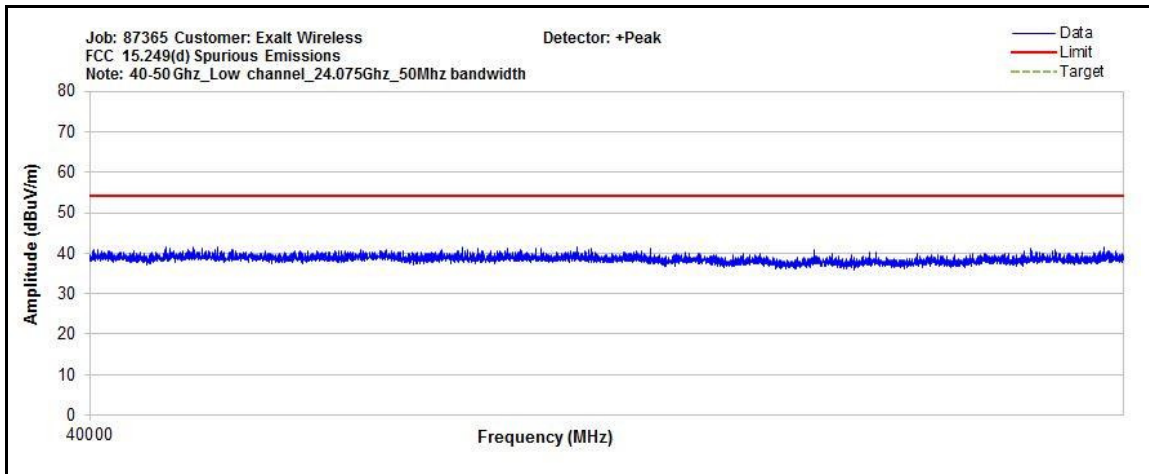

Plot 174. Radiated Spurious Emissions, 50 MHz, Low Channel, 40 GHz - 50 GHz

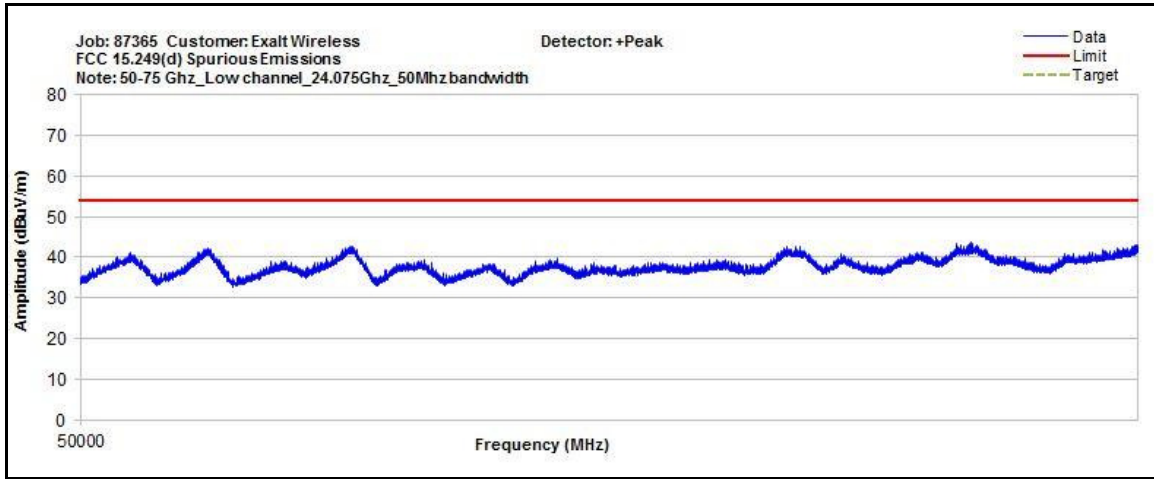

Plot 175. Radiated Spurious Emissions, 50 MHz, Low Channel, 50 GHz – 75 GHz

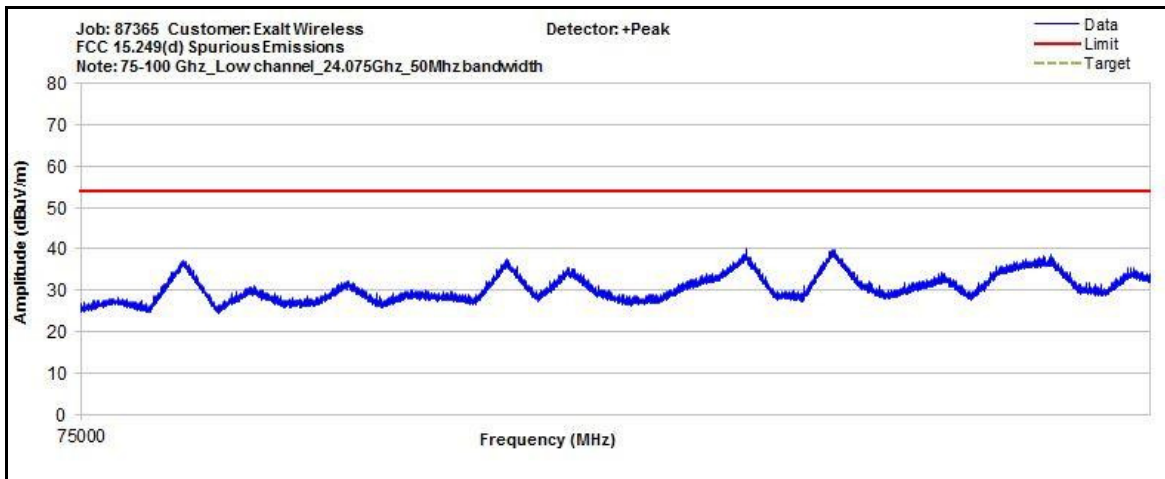

Plot 176. Radiated Spurious Emissions, 50 MHz, Low Channel, 75 GHz – 100 GHz

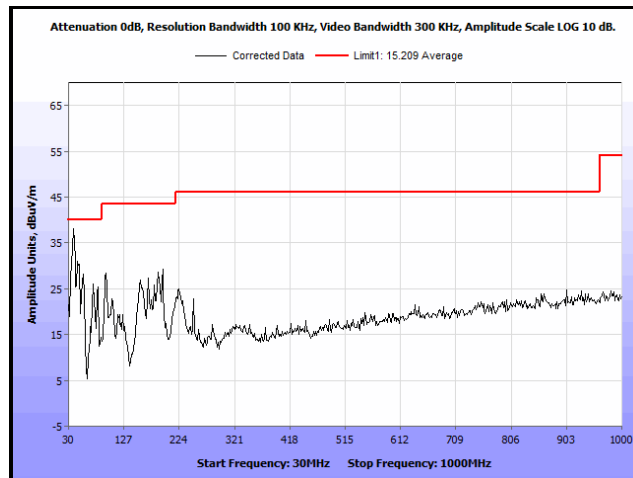

Plot 177. Radiated Spurious Emissions, 50 MHz, Mid Channel, 30 MHz – 1 GHz

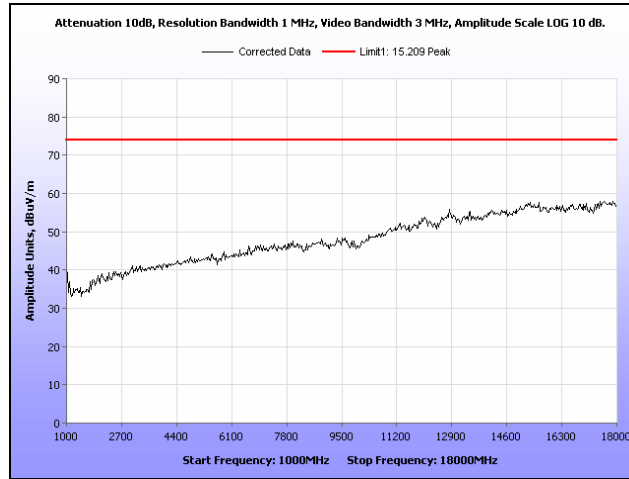

Plot 178. Radiated Spurious Emissions, 50 MHz, Mid Channel, 1 GHz - 18 GHz, Peak

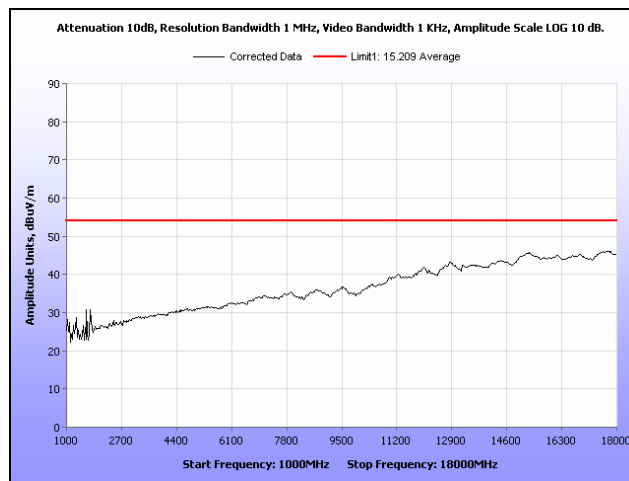

Plot 179. Radiated Spurious Emissions, 50 MHz, Mid Channel, 1 GHz - 18 GHz, Average

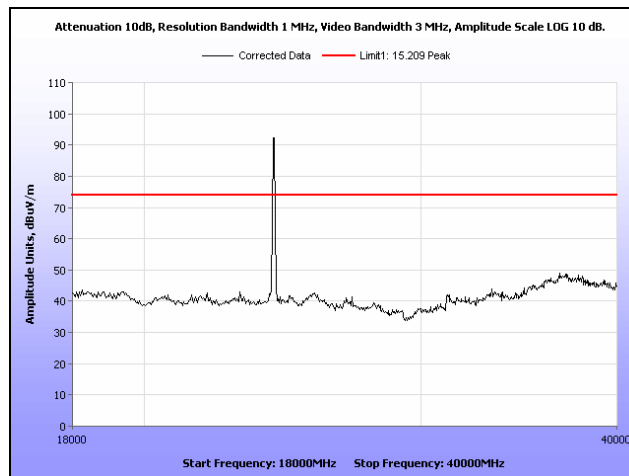

Plot 180. Radiated Spurious Emissions, 50 MHz, Mid Channel, 18 GHz - 40 GHz, Peak

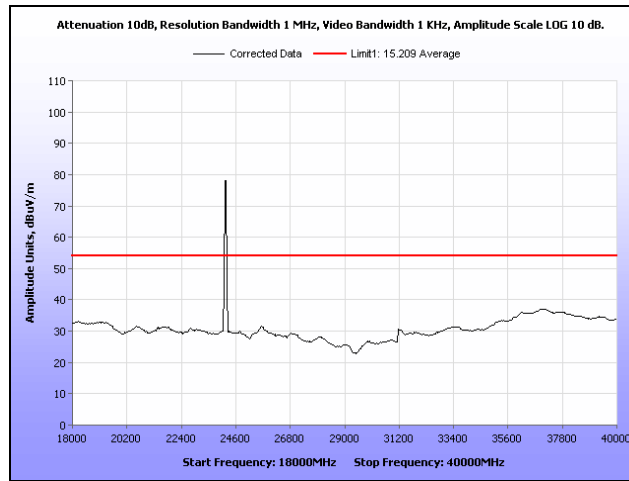

Plot 181. Radiated Spurious Emissions, 50 MHz, Mid Channel, 18 GHz –40 GHz, Average

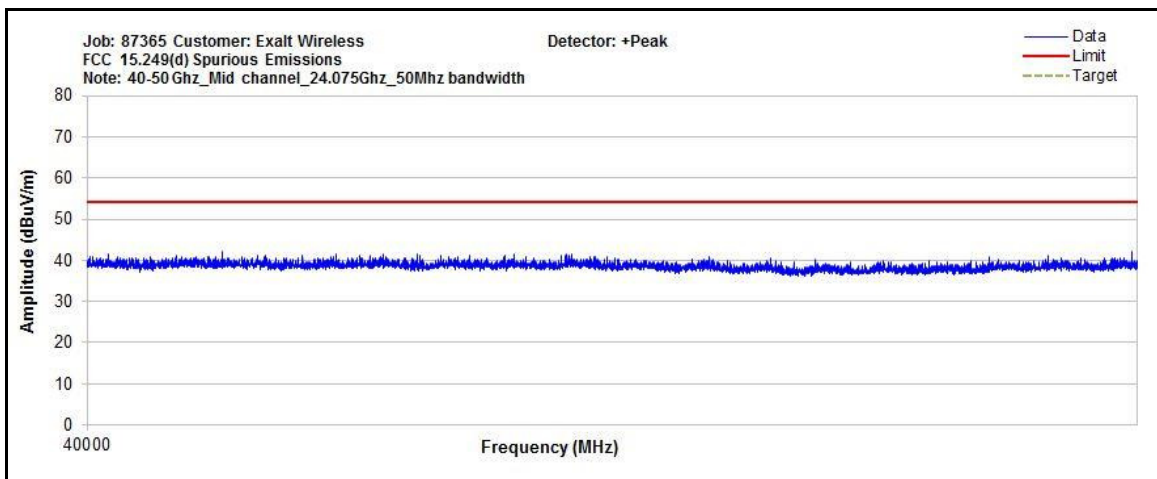

Plot 182. Radiated Spurious Emissions, 50 MHz, Mid Channel, 40 GHz – 50 GHz

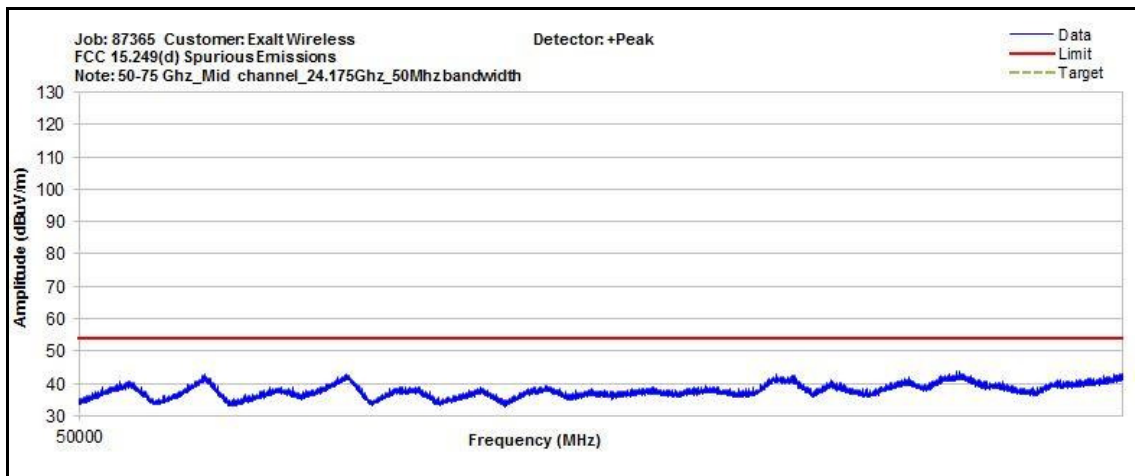

Plot 183. Radiated Spurious Emissions, 50 MHz, Mid Channel, 50 GHz – 75 GHz

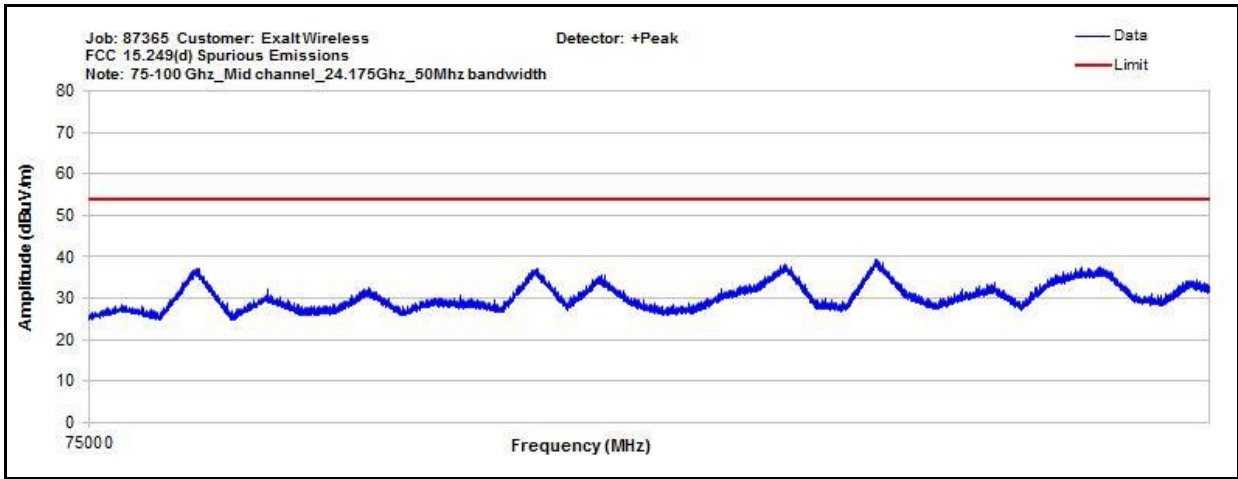

Plot 184. Radiated Spurious Emissions, 50 MHz, Mid Channel, 75 GHz – 100 GHz

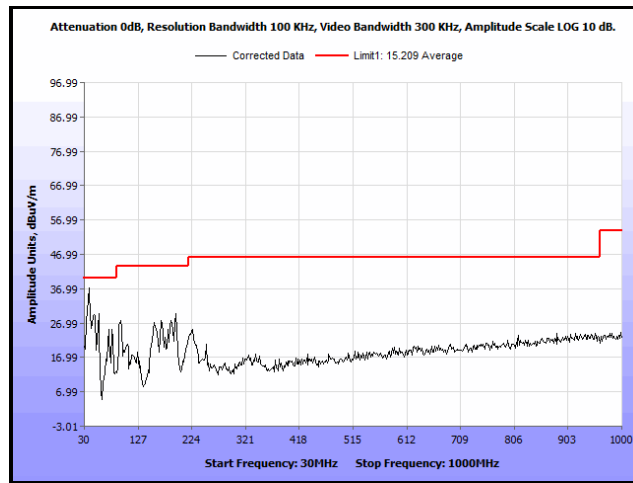

Plot 185. Radiated Spurious Emissions, 50 MHz, High Channel, 30 MHz – 1 GHz

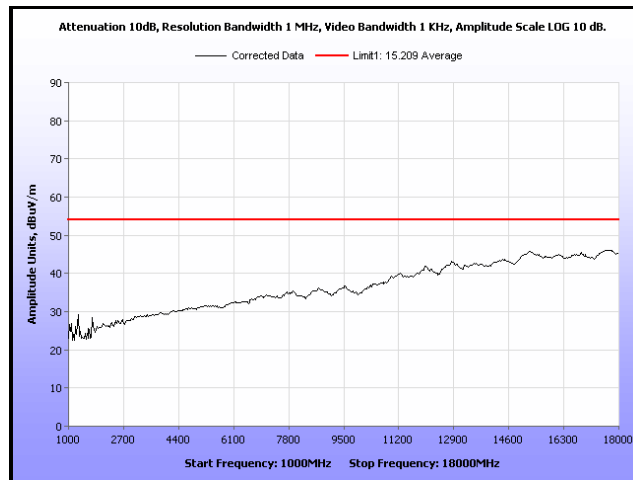

Plot 186. Radiated Spurious Emissions, 50 MHz, High Channel, 1 GHz – 18 GHz, Average

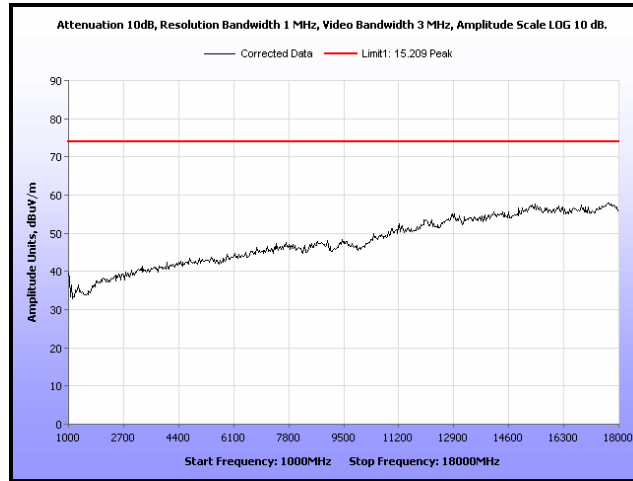

Plot 187. Radiated Spurious Emissions, 50 MHz, High Channel, 1 GHz – 18 GHz, Peak

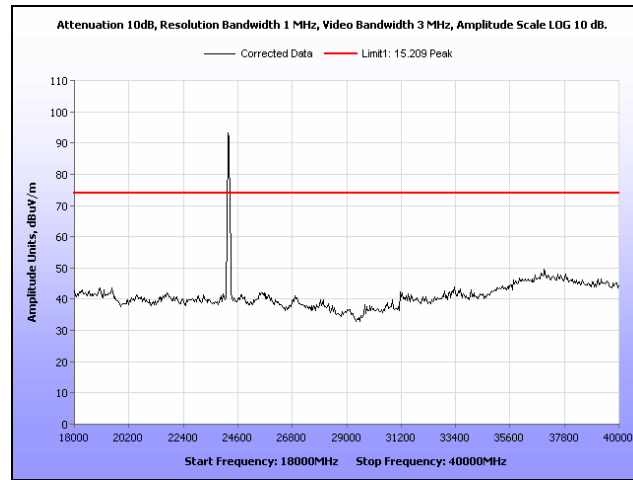

Plot 188. Radiated Spurious Emissions, 50 MHz, High Channel, 18 GHz - 40 GHz, Peak

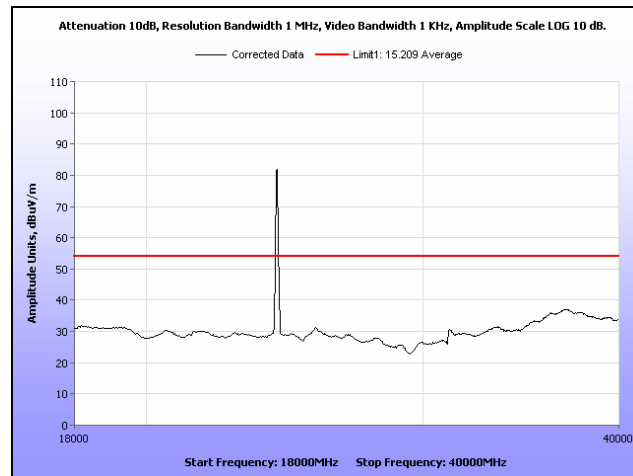

Plot 189. Radiated Spurious Emissions, 50 MHz, High Channel, 18 GHz - 40 GHz, Average

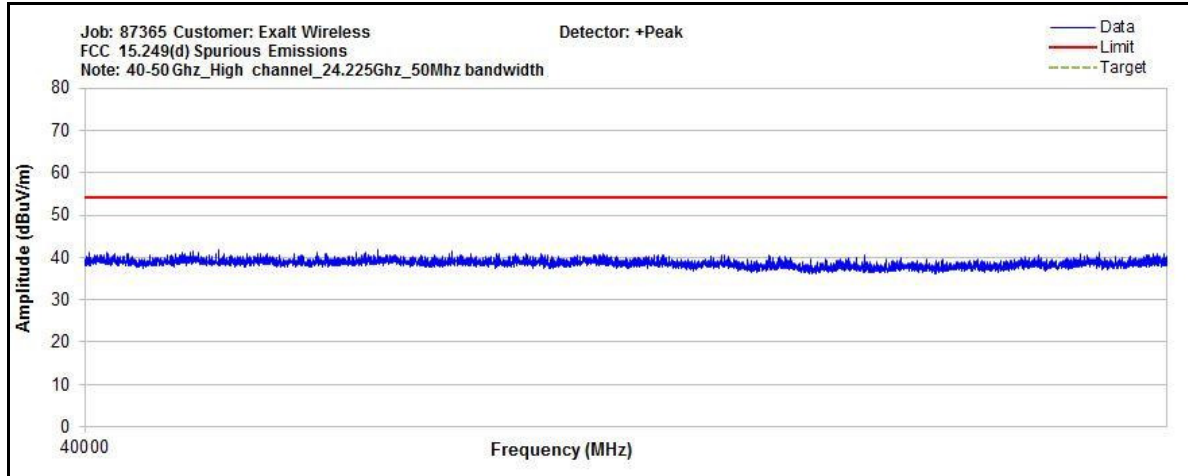

Plot 190. Radiated Spurious Emissions, 50 MHz, High Channel, 40 GHz – 50 GHz

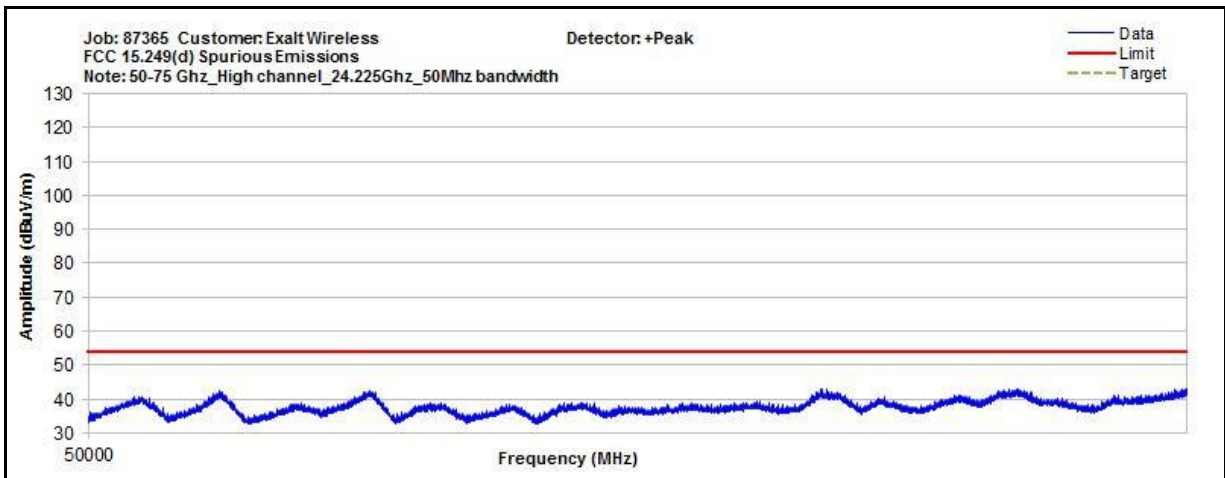

Plot 191. Radiated Spurious Emissions, 50 MHz, High Channel, 50 GHz – 75 GHz

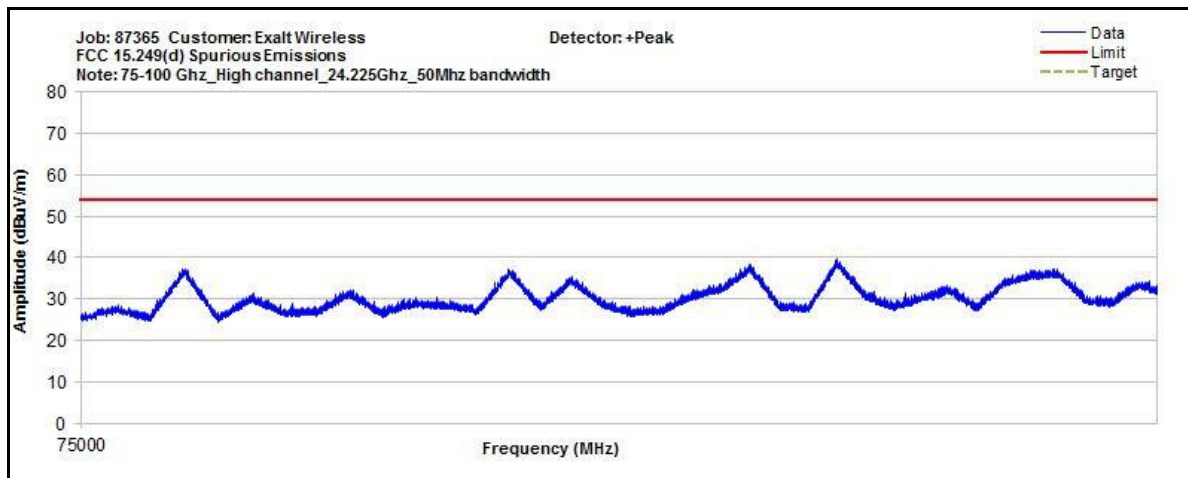

Plot 192. Radiated Spurious Emissions, 50 MHz, High Channel, 75 GHz – 100 GHz

Band Edge, 5 MHz

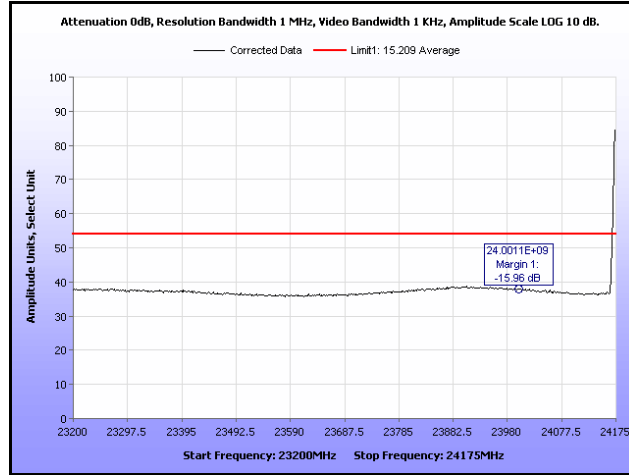

Plot 193. Radiated Band Edge, 5 MHz, Low Channel, Average

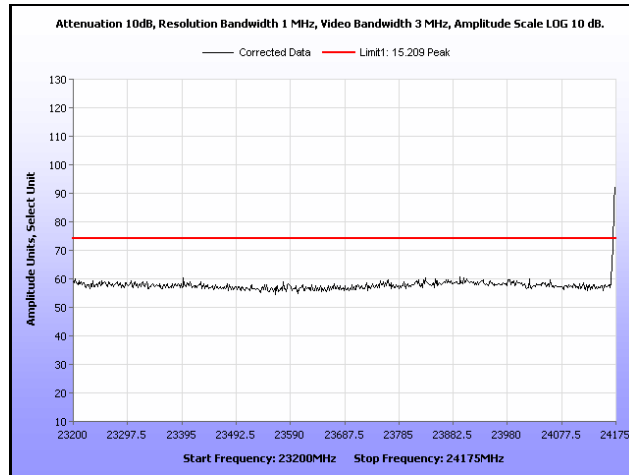

Plot 194. Radiated Band Edge, 5 MHz, Low Channel, Peak

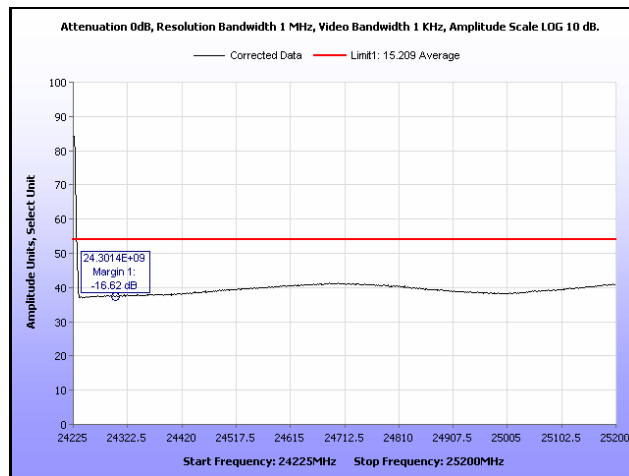

Plot 195. Radiated Band Edge, 5 MHz, High Channel, Average

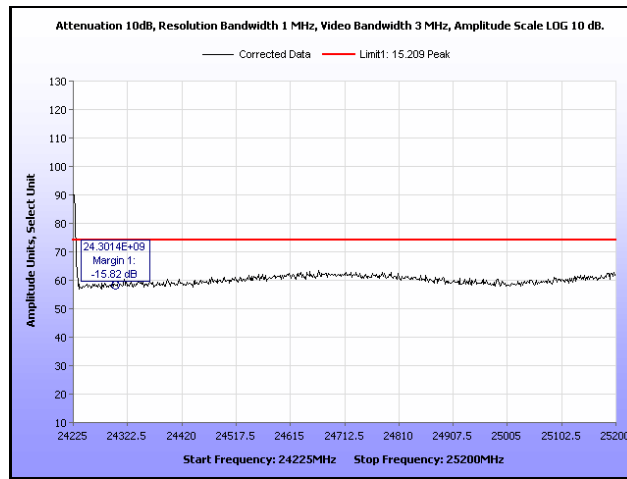

Plot 196. Radiated Band Edge, 5 MHz, High Channel, Peak

Band Edge, 10 MHz

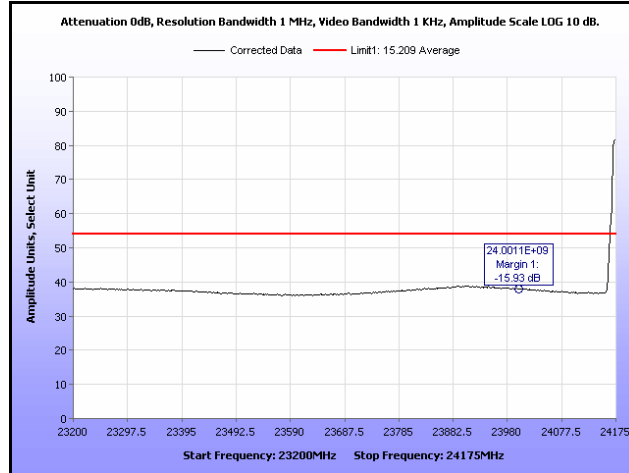

Plot 197. Radiated Band Edge, 10 MHz, Low Channel, Average

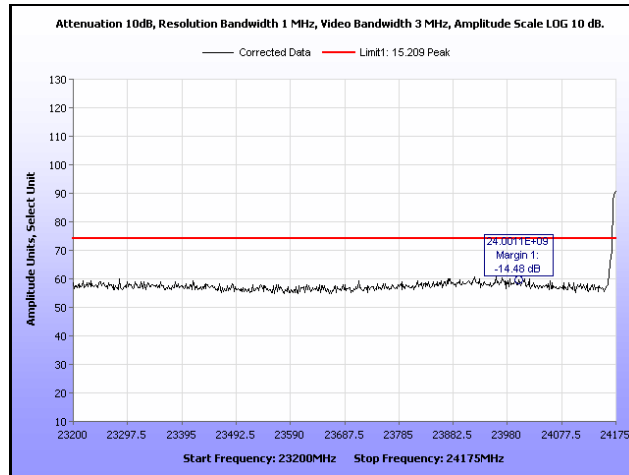

Plot 198. Radiated Band Edge, 10 MHz, Low Channel, Peak

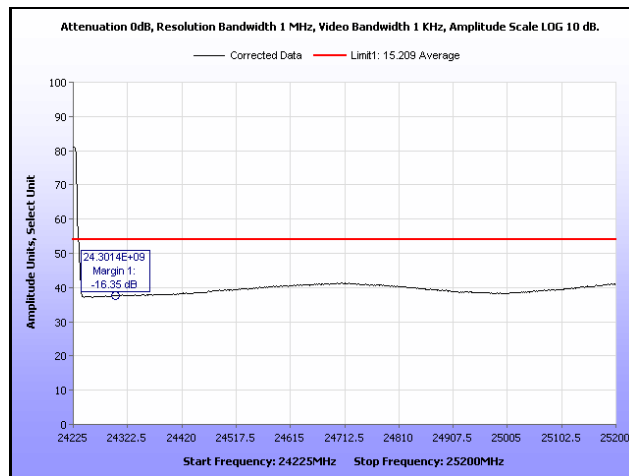

Plot 199. Radiated Band Edge, 10 MHz, High Channel, Average

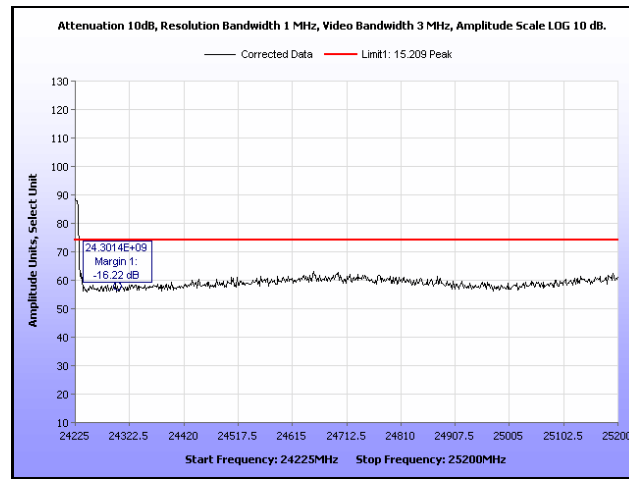

Plot 200. Radiated Band Edge, 10 MHz, High Channel, Peak

Band Edge, 20 MHz

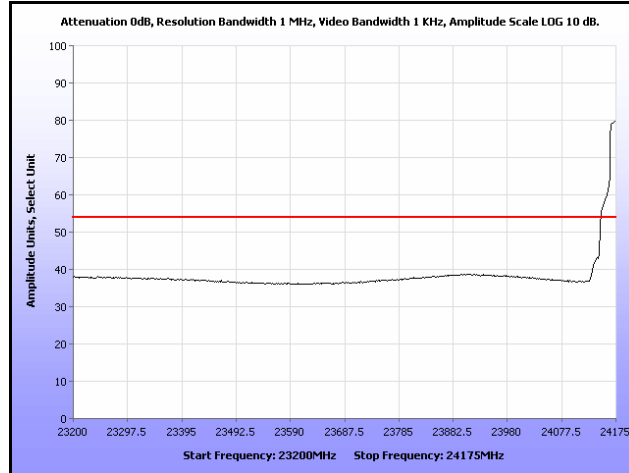

Plot 201. Radiated Band Edge, 20 MHz, Low Channel, Average

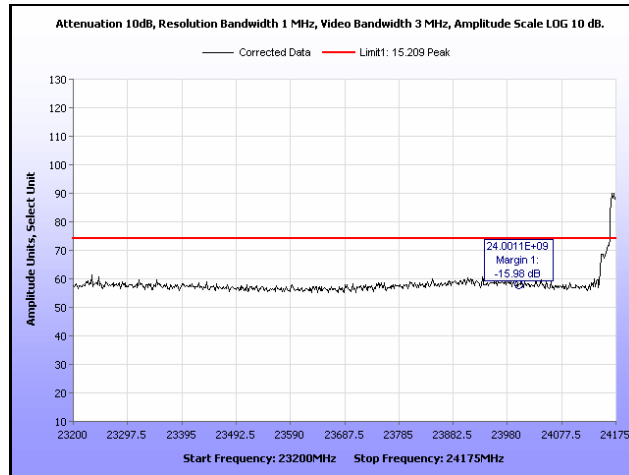

Plot 202. Radiated Band Edge, 20 MHz, Low Channel, Peak

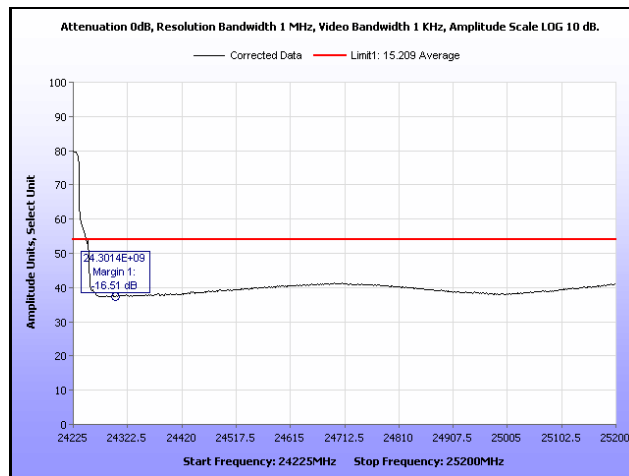

Plot 203. Radiated Band Edge, 20 MHz, High Channel, Average

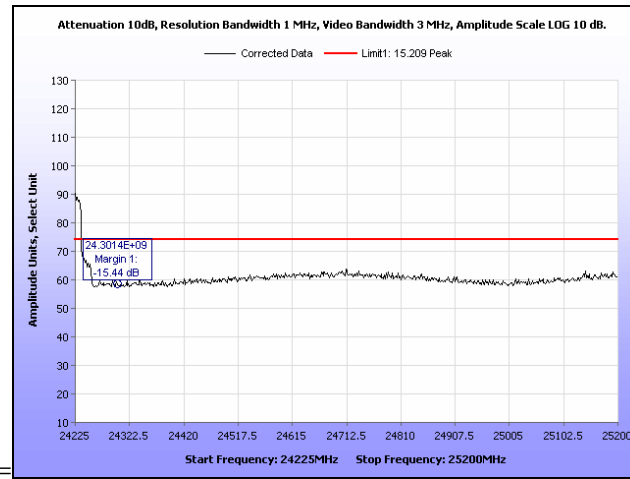

Plot 204. Radiated Band Edge, 20 MHz, High Channel, Peak

Band Edge, 25 MHz

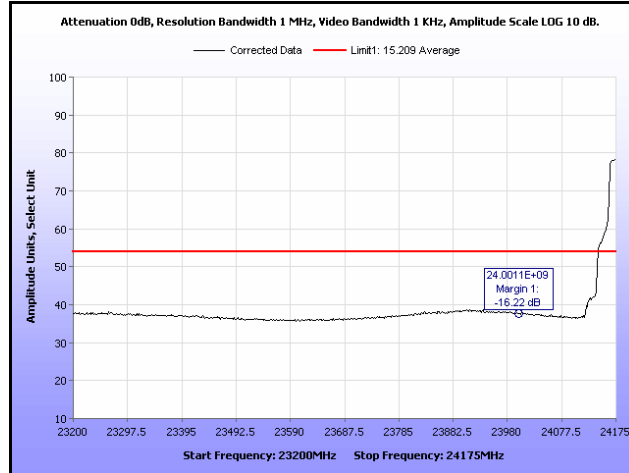

Plot 205. Radiated Band Edge, 25 MHz, Low Channel, Average

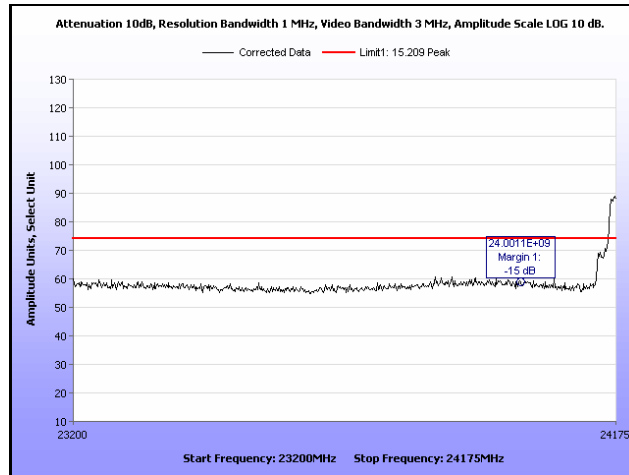

Plot 206. Radiated Band Edge, 25 MHz, Low Channel, Peak

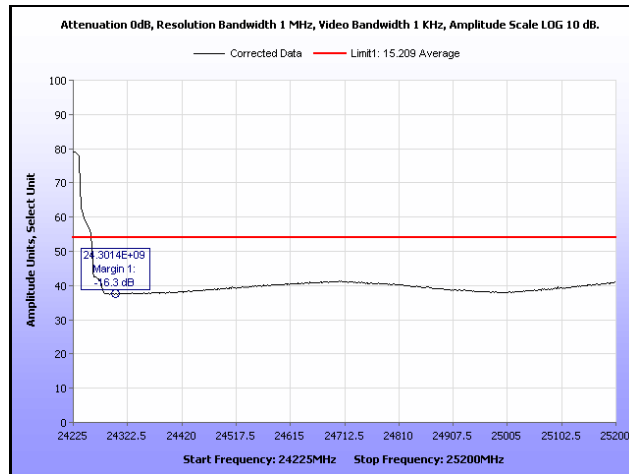

Plot 207. Radiated Band Edge, 25 MHz, High Channel, Average

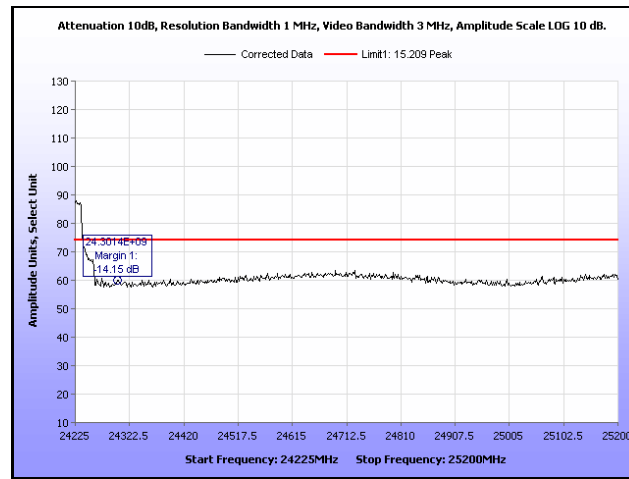

Plot 208. Radiated Band Edge, 25 MHz, High Channel, Peak

Band Edge, 30 MHz

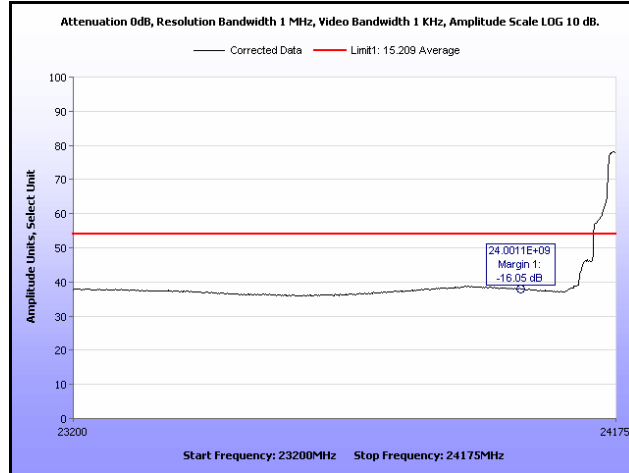

Plot 209. Radiated Band Edge, 30 MHz, Low Channel, Average

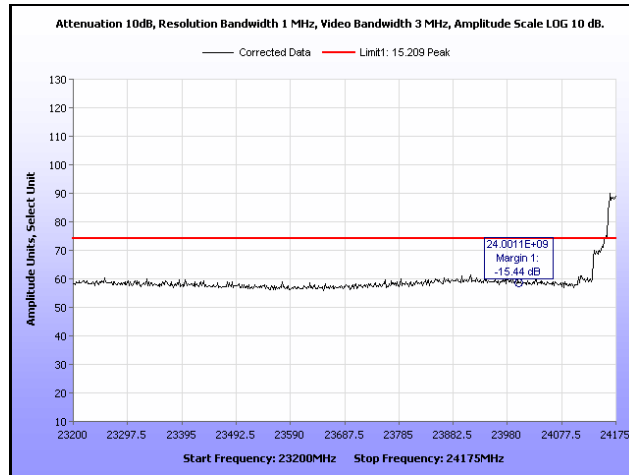

Plot 210. Radiated Band Edge, 30 MHz, Low Channel, Peak

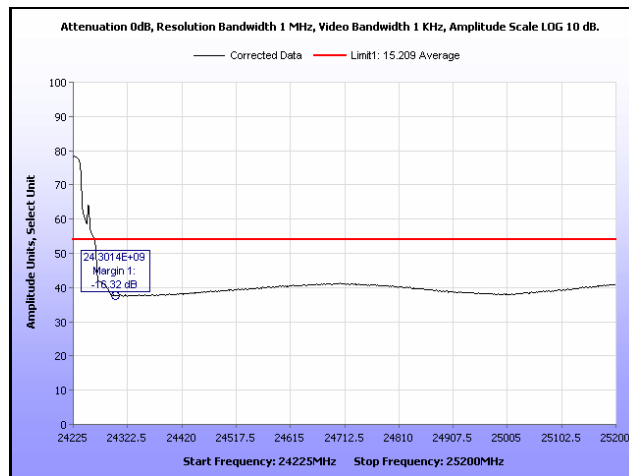

Plot 211. Radiated Band Edge, 30 MHz, High Channel, Average

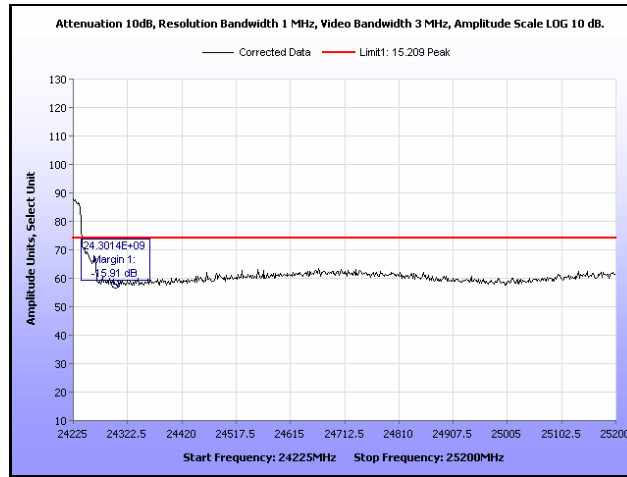

Plot 212. Radiated Band Edge, 30 MHz, High Channel, Peak

Band Edge, 40 MHz

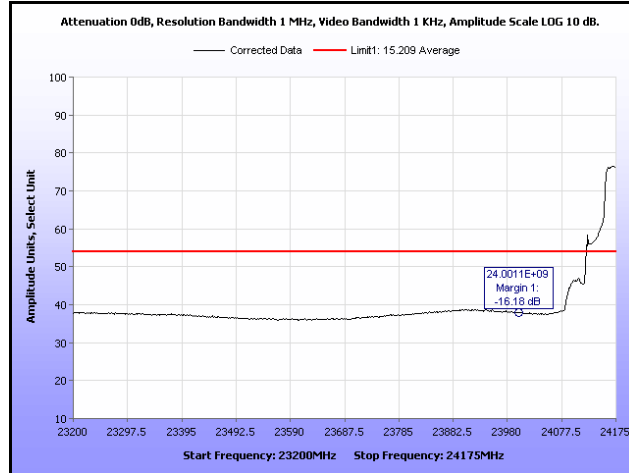

Plot 213. Radiated Band Edge, 40 MHz, Low Channel, Average

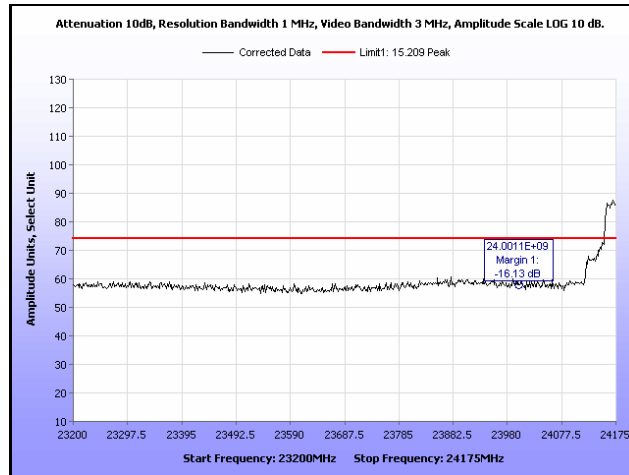

Plot 214. Radiated Band Edge, 40 MHz, Low Channel, Peak

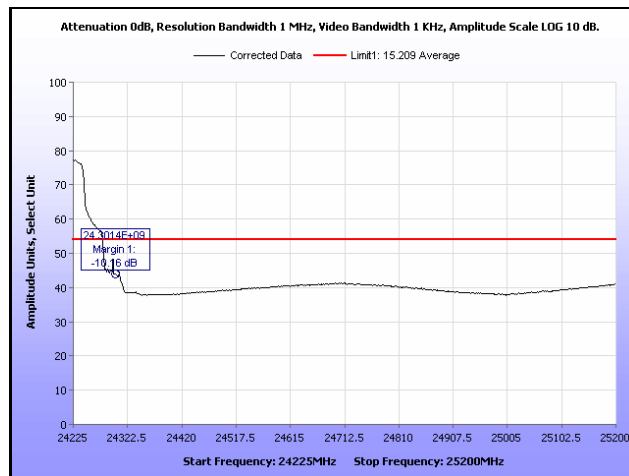

Plot 215. Radiated Band Edge, 40 MHz, High Channel, Average

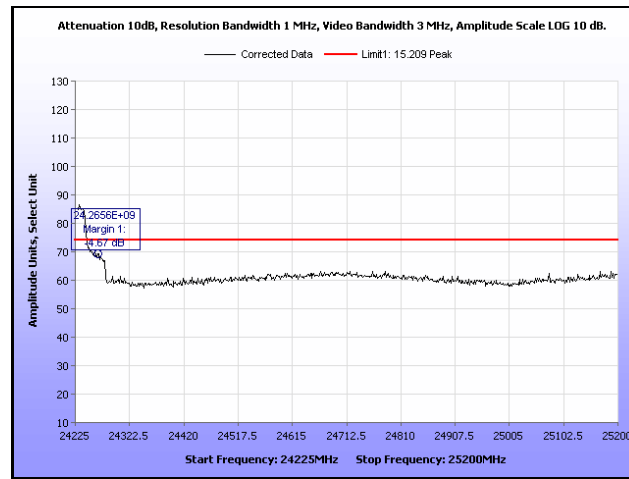

Plot 216. Radiated Band Edge, 40 MHz, High Channel, Peak

Band Edge, 50 MHz

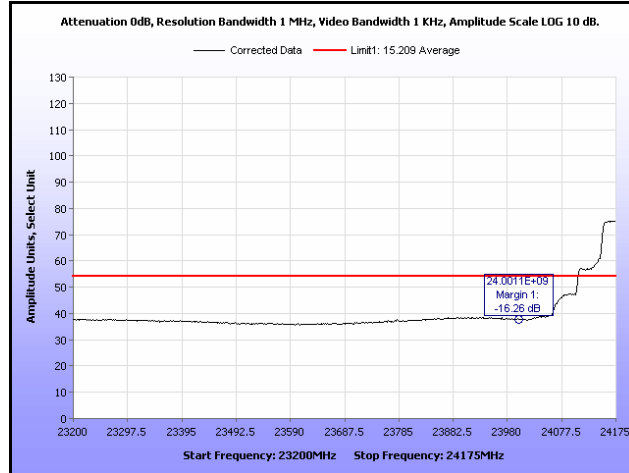

Plot 217. Radiated Band Edge, 50 MHz, Low Channel, Average

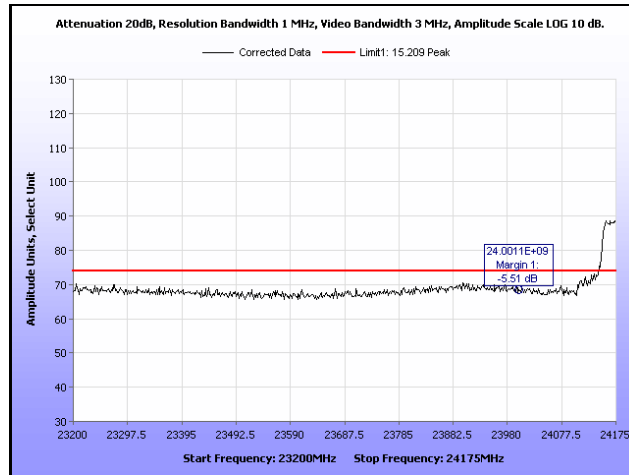

Plot 218. Radiated Band Edge, 50 MHz, Low Channel, Peak

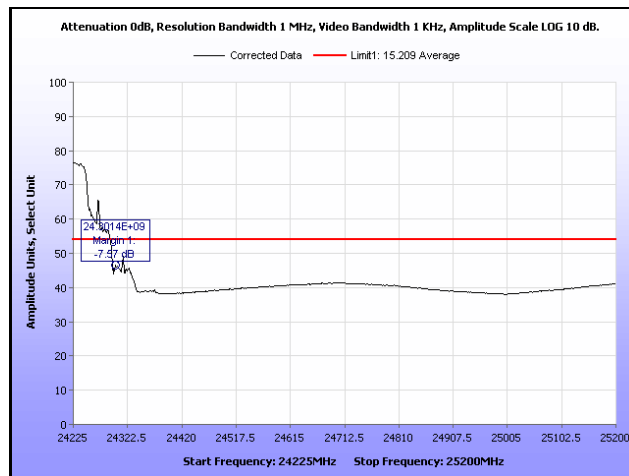

Plot 219. Radiated Band Edge, 50 MHz, High Channel, Average

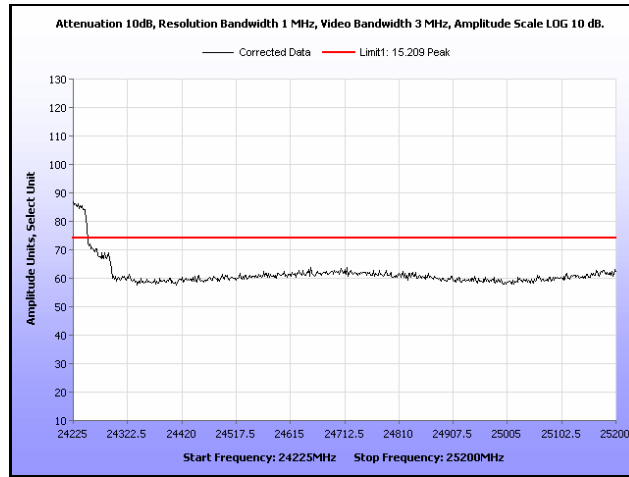

Plot 220. Radiated Band Edge, 50 MHz, High Channel, Peak

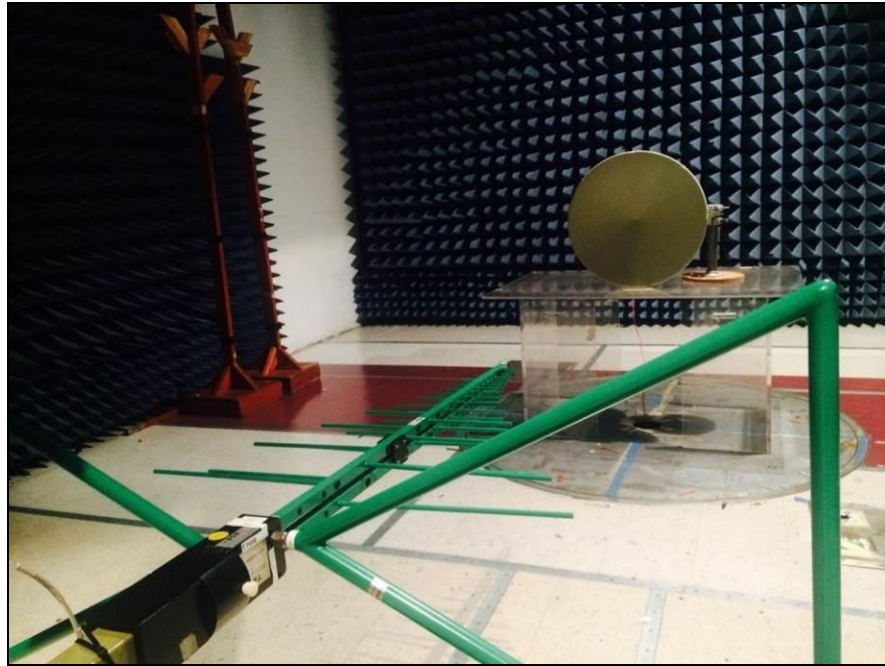

Photograph 4. Radiated Spurious Emissions, Test Setup, Below 30 MHz - 1 GHz

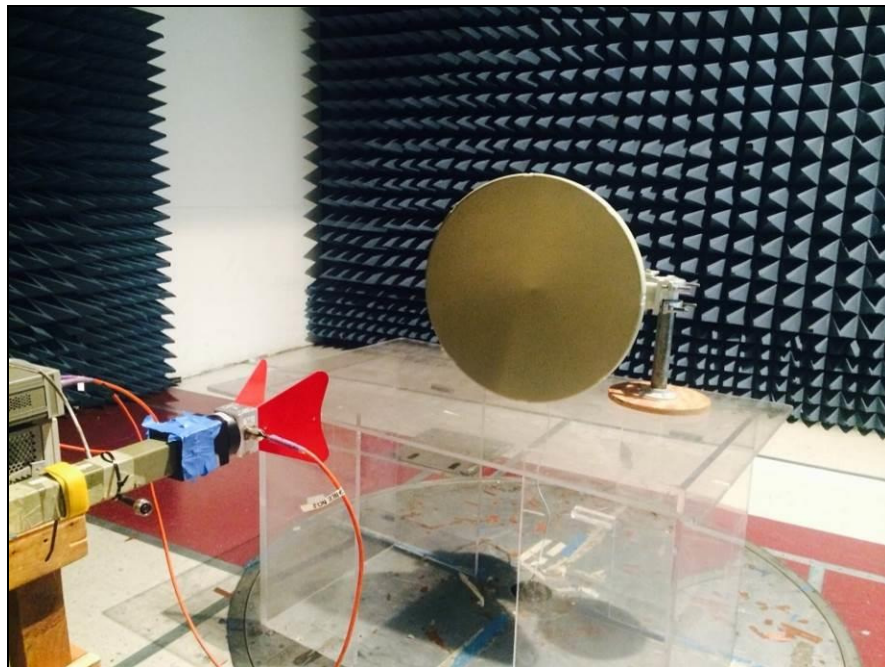

Photograph 5. Radiated Spurious Emissions, Test Setup, Above 1 GHz - 18 GHz



Photograph 6. Radiated Spurious Emissions, Test Setup, Above 18-40GHz

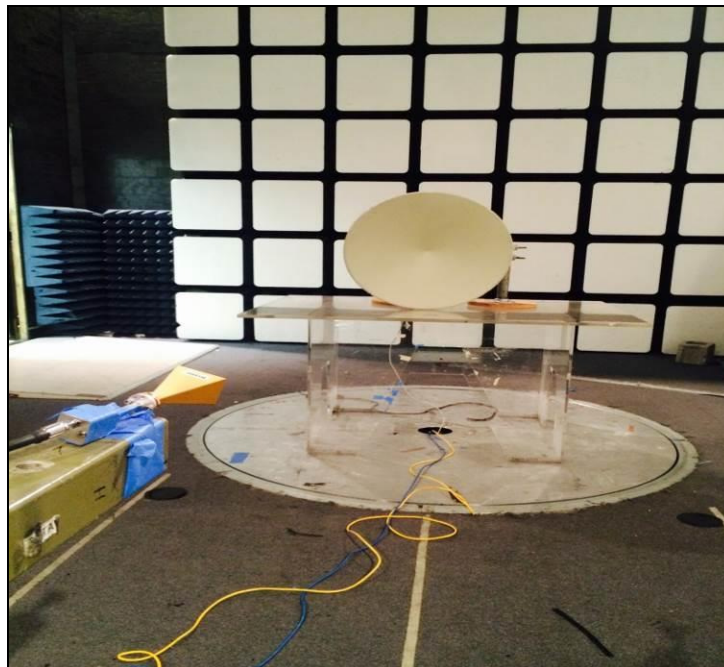

Photograph 7. Radiated Spurious Emissions, Test Setup, Above 40 GHz

Electromagnetic Compatibility Criteria for Intentional Radiators

§2.1049 & RSS-GEN (6.6) 99% Occupied Bandwidth

Test Requirements: **§2.1049:** The occupied bandwidth, that is the frequency bandwidth such that, below its lower and above its upper frequency limits, the mean powers radiated are each equal to 0.5 percent of the total mean power radiated by a given emission shall be measured

RSS-GEN (6.6): The emission bandwidth (\times dB) is defined as the frequency range between two points, one above and one below the carrier frequency, at which the spectral density of the emission is attenuated \times dB below the maximum in-band spectral density of the modulated signal. Spectral density (power per unit bandwidth) is to be measured with a detector of resolution bandwidth in the range of 1% to 5% of the anticipated emission bandwidth, and a video bandwidth at least $3\times$ the resolution bandwidth.

When the occupied bandwidth limit is not stated in the applicable RSS or reference measurement method, the transmitted signal bandwidth shall be reported as the 99% emission bandwidth, as calculated or measured.

- The transmitter shall be operated at its maximum carrier power measured under normal test conditions.
- The span of the analyzer shall be set to capture all products of the modulation process, including the emission skirts.
- The resolution bandwidth (RBW) shall be in the range of 1% to 5% of the occupied bandwidth (OBW) and video bandwidth (VBW) shall be approximately $3\times$ RBW.

Note: Video averaging is not permitted.

A peak, or peak hold, may be used in place of the sampling detector as this may produce a wider bandwidth than the actual bandwidth (worst-case measurement). Use of a peak hold may be necessary to determine the occupied bandwidth if the device is not transmitting continuously.

The trace data points are recovered and are directly summed in linear power level terms. The recovered amplitude data points, beginning at the lowest frequency, are placed in a running sum until 0.5% of the total is reached and that frequency recorded. The process is repeated for the highest frequency data points (starting at the highest frequency, at the right side of the span, and going down in frequency). This frequency is then recorded.

The difference between the two recorded frequencies is the 99% occupied bandwidth.

Test Procedure: The transmitter was on and transmitting at the highest output power. The bandwidth of the fundamental frequency was measured with the spectrum analyzer using a RBW approximately 1% of the total emission bandwidth, $VBW > RBW$. The 99% Bandwidth was measured and recorded. The measurements were performed on the low, mid and high channels.

Test Results The EUT was compliant with RSS-GEN (6.6).

The 99% Bandwidth was determined from the plots on the following pages.

Test Engineer(s): Kaushani Dasgupta

Test Date(s): 02/24/16

Occupied Bandwidth Test Results, 5 MHz

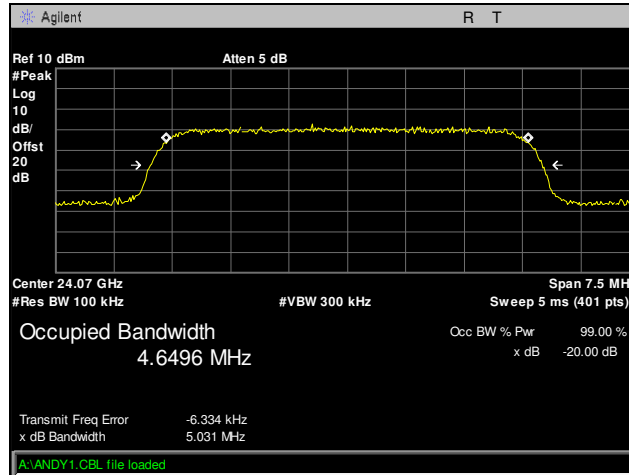

Plot 221. Occupied Bandwidth, Low Channel, 5 MHz

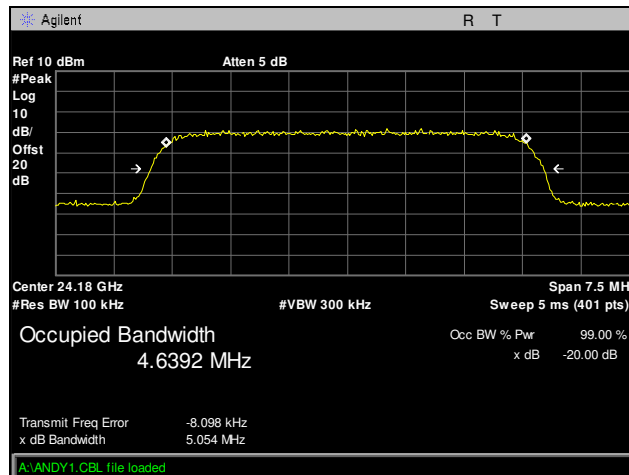

Plot 222. Occupied Bandwidth, Mid Channel, 5 MHz

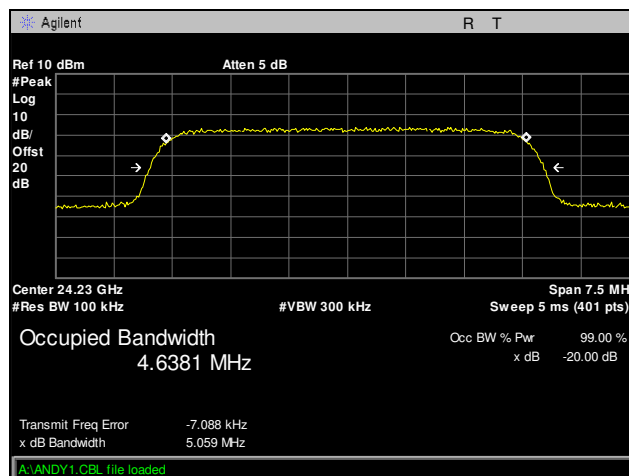

Plot 223. Occupied Bandwidth, High Channel, 5 MHz

Occupied Bandwidth Test Results, 10 MHz

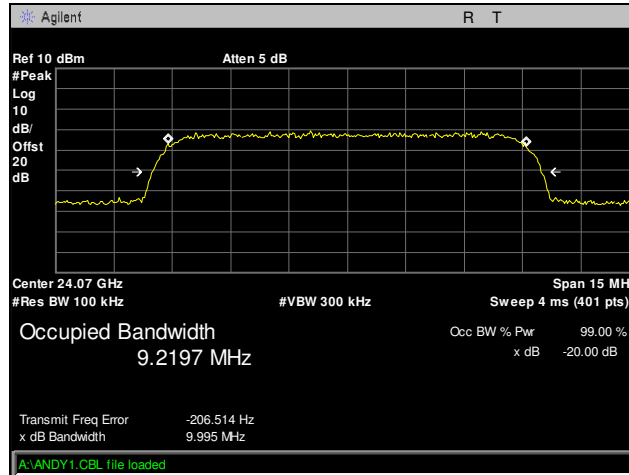

Plot 224. Occupied Bandwidth, Low Channel, 10 MHz

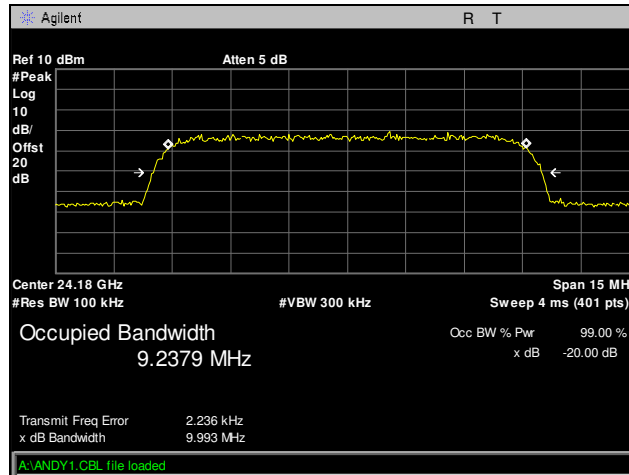

Plot 225. Occupied Bandwidth, Mid Channel, 10 MHz

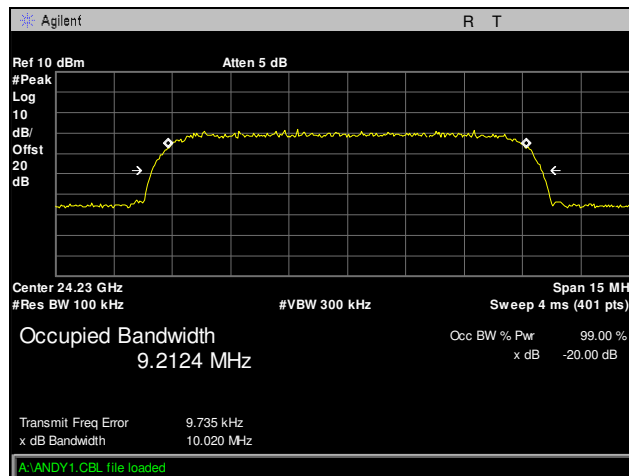

Plot 226. Occupied Bandwidth, High Channel, 10 MHz

Occupied Bandwidth Test Results, 20 MHz

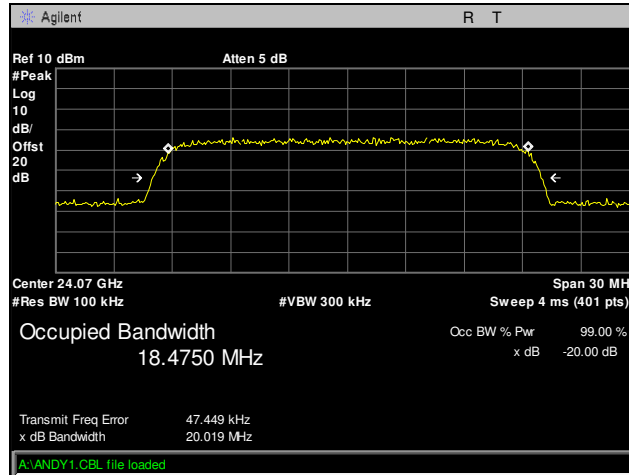

Plot 227. Occupied Bandwidth, Low Channel, 20 MHz

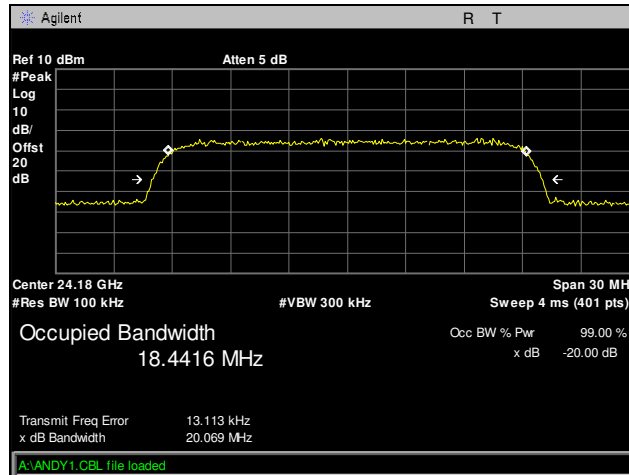

Plot 228. Occupied Bandwidth, Mid Channel, 20 MHz

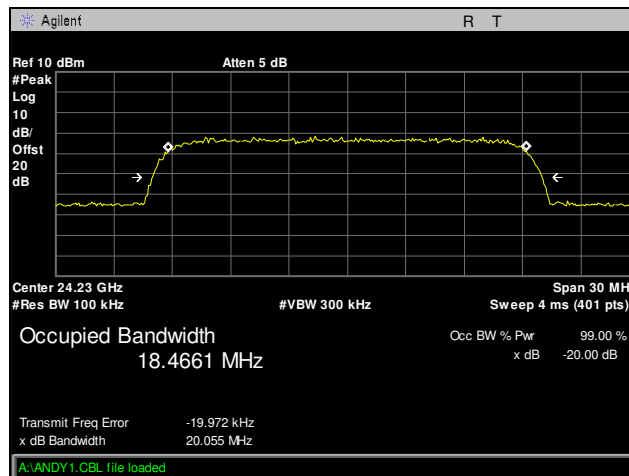

Plot 229. Occupied Bandwidth, High Channel, 20 MHz

Occupied Bandwidth Test Results, 25 MHz

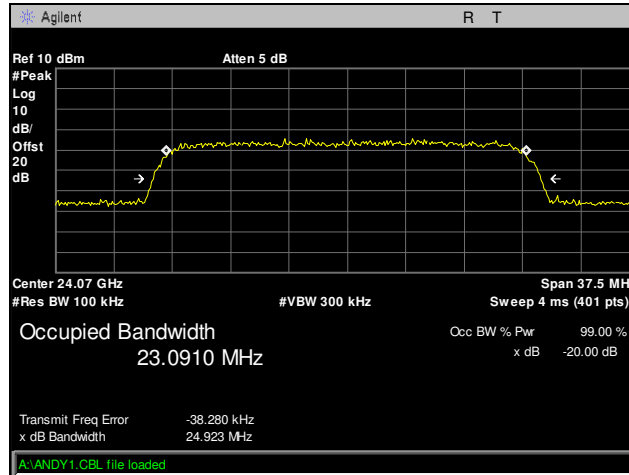

Plot 230. Occupied Bandwidth, Low Channel, 25 MHz

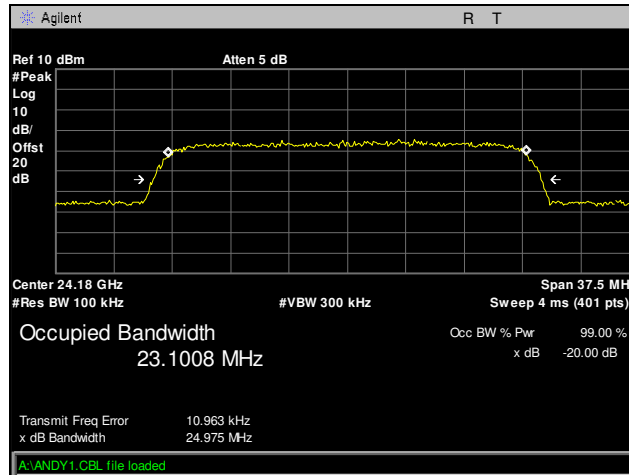

Plot 231. Occupied Bandwidth, Mid Channel, 25 MHz

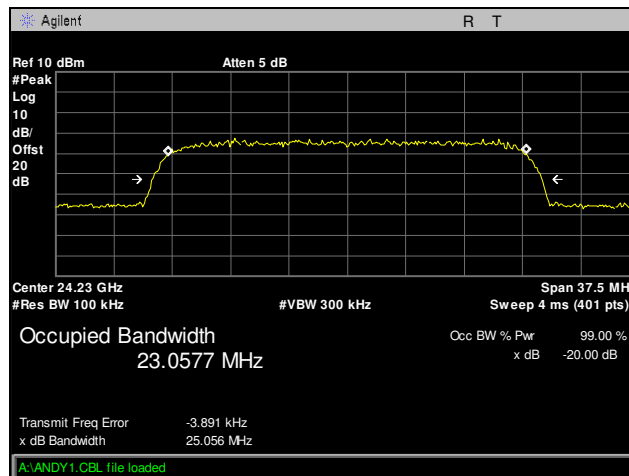

Plot 232. Occupied Bandwidth, High Channel, 25 MHz

Occupied Bandwidth Test Results, 30 MHz

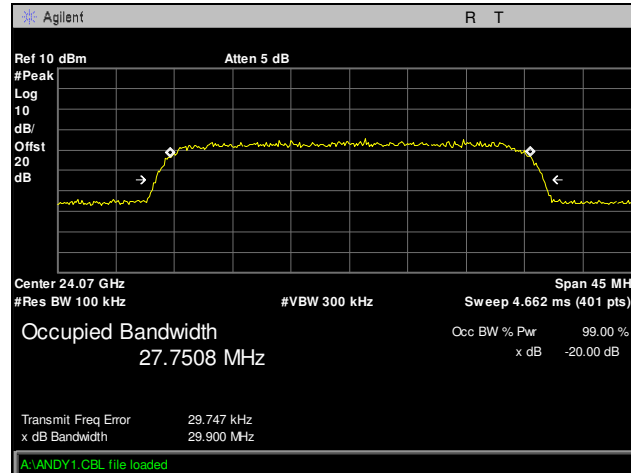

Plot 233. Occupied Bandwidth, Low Channel, 30 MHz

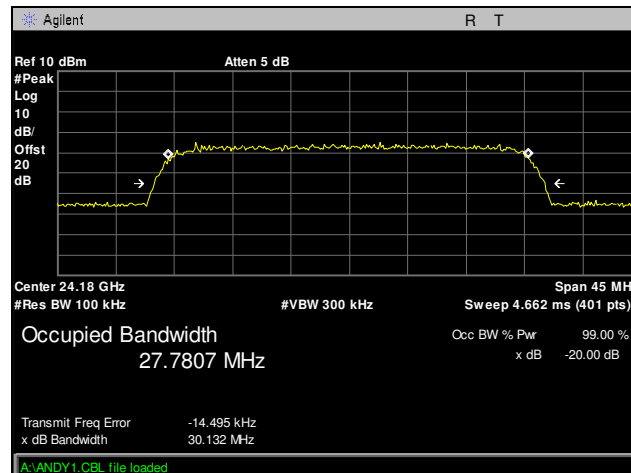

Plot 234. Occupied Bandwidth, Mid Channel, 30 MHz

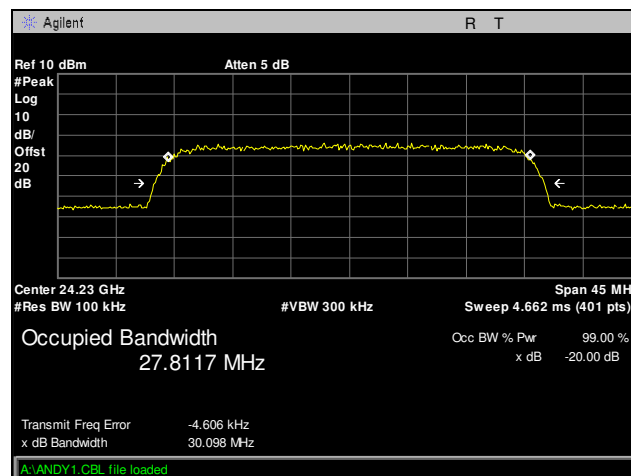

Plot 235. Occupied Bandwidth, High Channel, 30 MHz

Occupied Bandwidth Test Results, 40 MHz

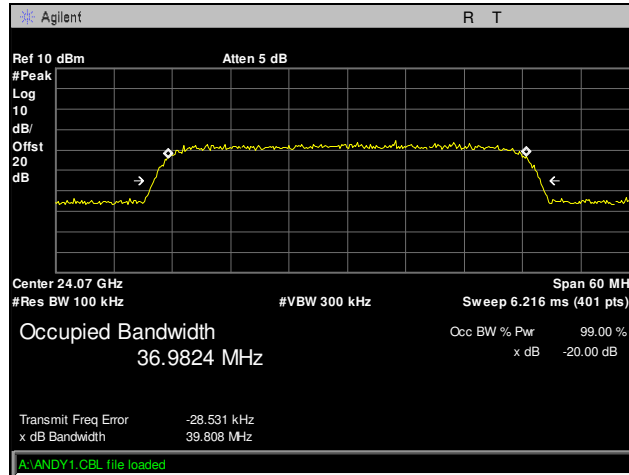

Plot 236. Occupied Bandwidth, Low Channel, 40 MHz

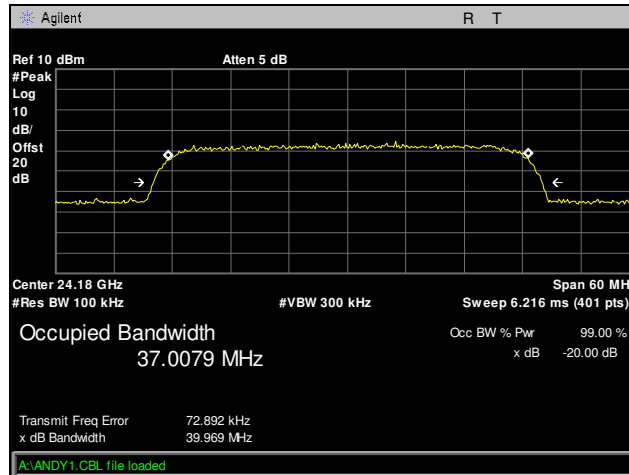

Plot 237. Occupied Bandwidth, Mid Channel, 40 MHz

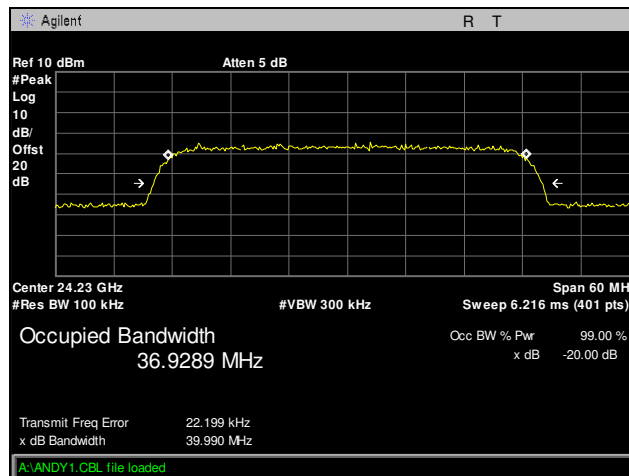

Plot 238. Occupied Bandwidth, High Channel, 40 MHz

Occupied Bandwidth Test Results, 50 MHz

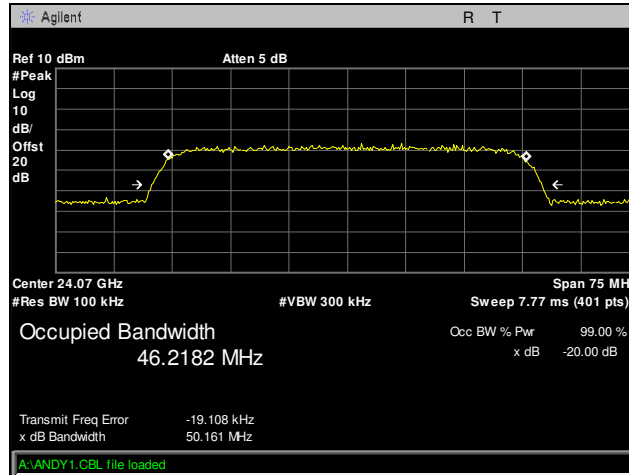

Plot 239. Occupied Bandwidth, Low Channel, 50 MHz

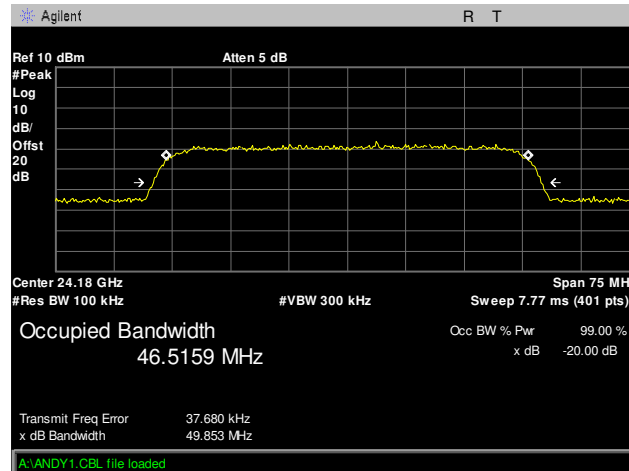

Plot 240. Occupied Bandwidth, Mid Channel, 50 MHz

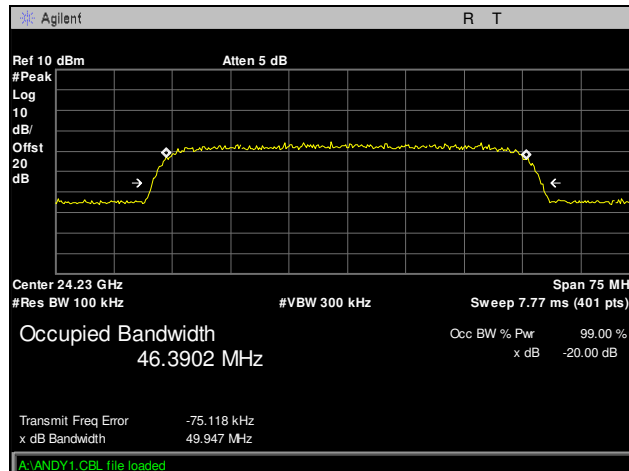

Plot 241. Occupied Bandwidth, High Channel, 50 MHz

99% Occupied Bandwidth Test Results, 5 MHz

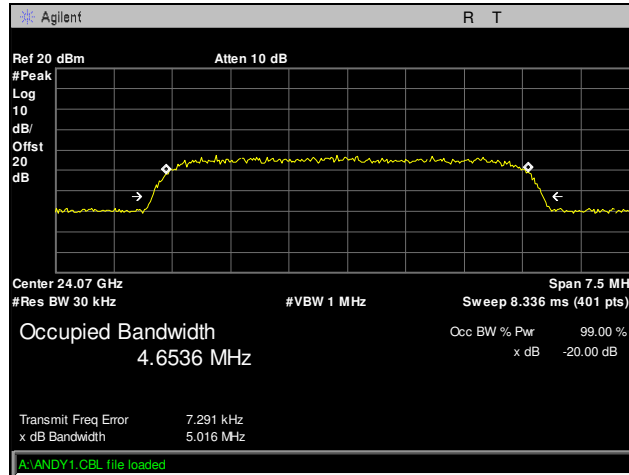

Plot 242. 99% Occupied Bandwidth, Low Channel, 5 MHz

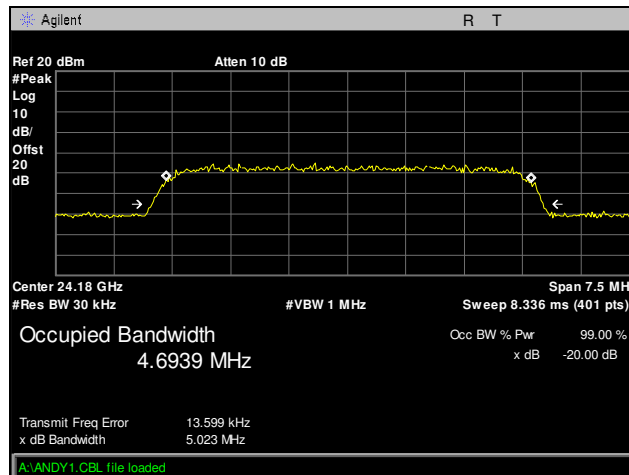

Plot 243. 99% Occupied Bandwidth, Mid Channel, 5 MHz

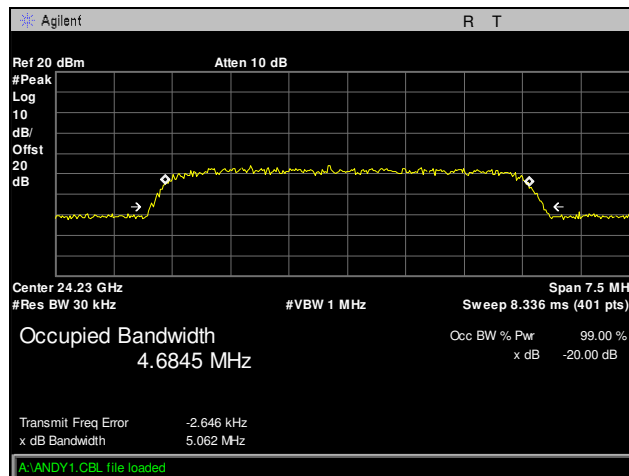

Plot 244. 99% Occupied Bandwidth, High Channel, 5 MHz

99% Occupied Bandwidth Test Results, 10 MHz

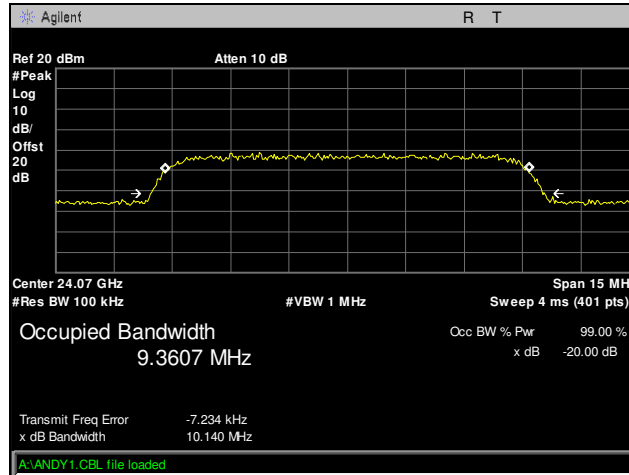

Plot 245. 99% Occupied Bandwidth, Low Channel, 10 MHz

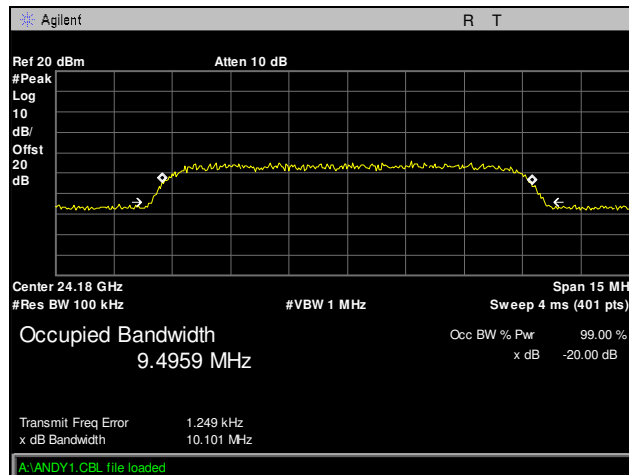

Plot 246. 99% Occupied Bandwidth, Mid Channel, 10 MHz

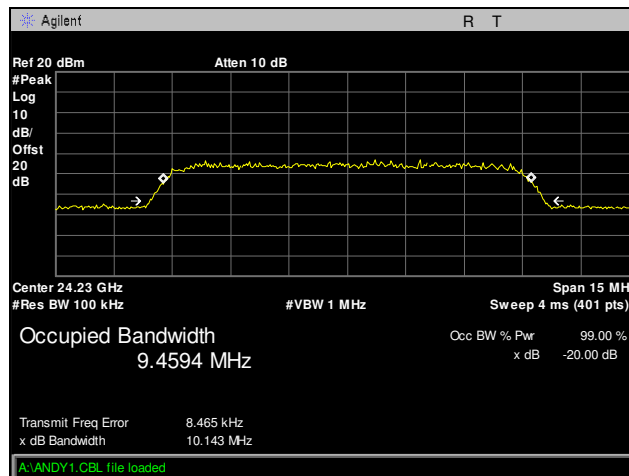

Plot 247. 99% Occupied Bandwidth, High Channel, 10 MHz

99% Occupied Bandwidth Test Results, 20 MHz

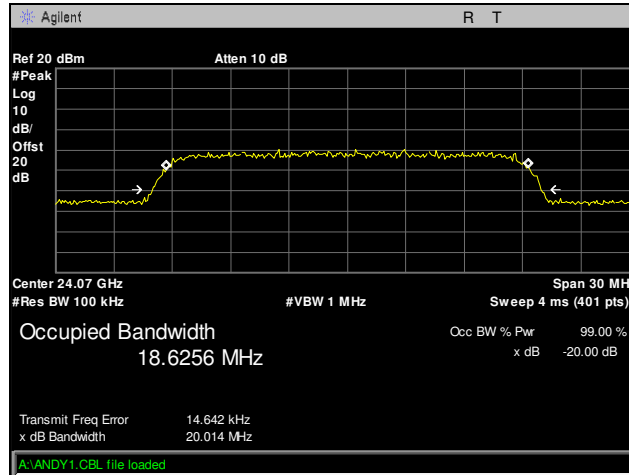

Plot 248. 99% Occupied Bandwidth, Low Channel, 20 MHz

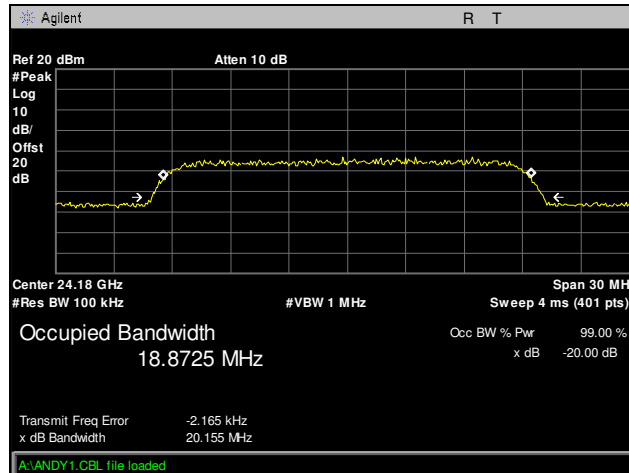

Plot 249. 99% Occupied Bandwidth, Mid Channel, 20 MHz

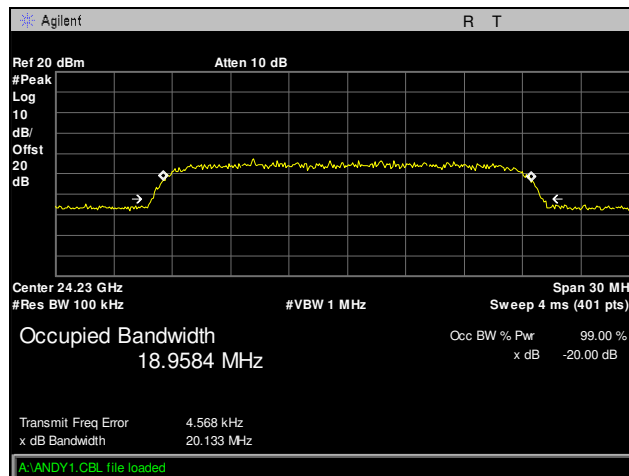

Plot 250. 99% Occupied Bandwidth, High Channel, 20 MHz

99% Occupied Bandwidth Test Results, 25 MHz

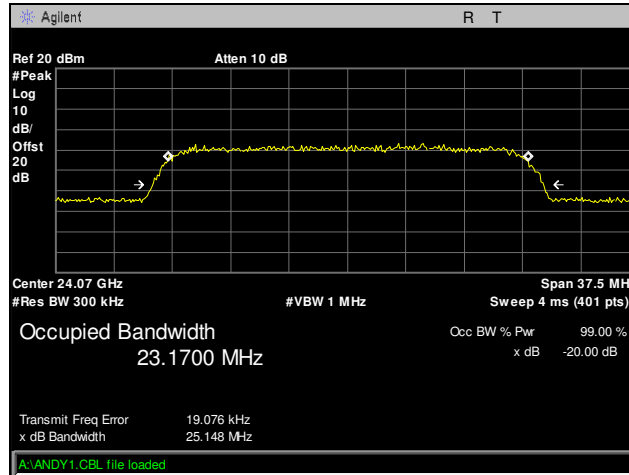

Plot 251. 99% Occupied Bandwidth, Low Channel, 25 MHz

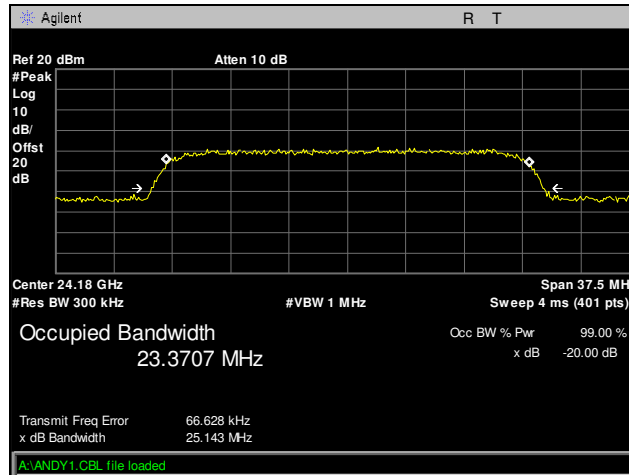

Plot 252. 99% Occupied Bandwidth, Mid Channel, 25 MHz

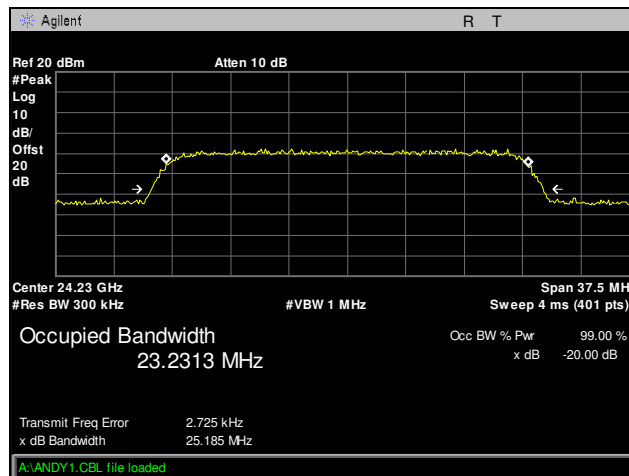

Plot 253. 99% Occupied Bandwidth, High Channel, 25 MHz

99% Occupied Bandwidth Test Results, 30 MHz

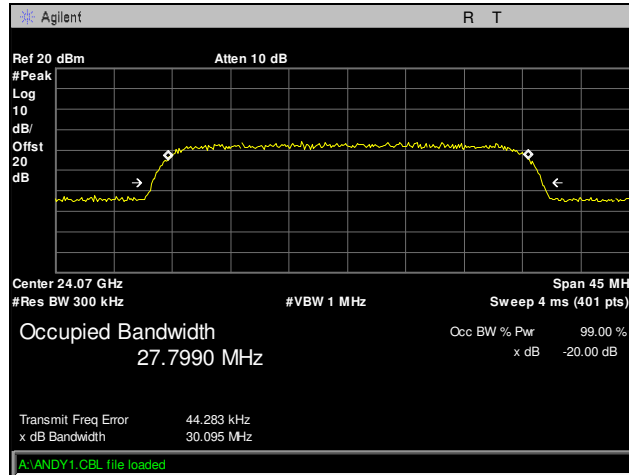

Plot 254. 99% Occupied Bandwidth, Low Channel, 30 MHz

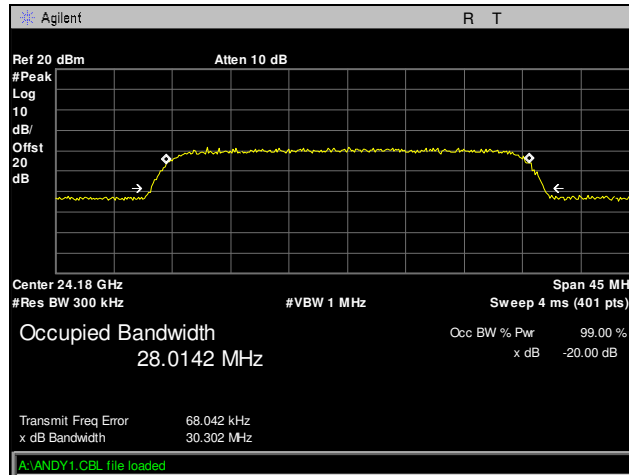

Plot 255. 99% Occupied Bandwidth, Mid Channel, 30 MHz

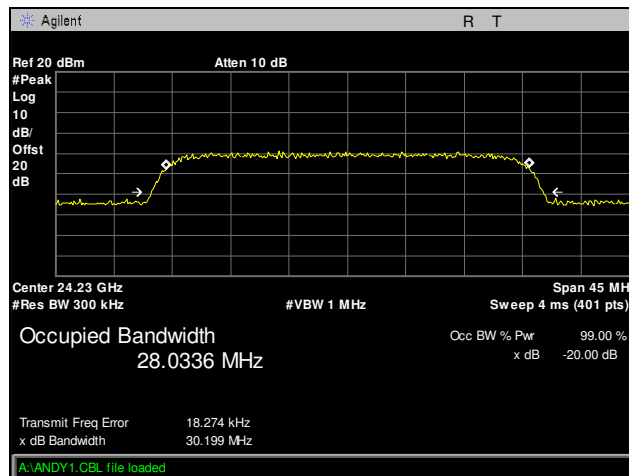

Plot 256. 99% Occupied Bandwidth, High Channel, 30 MHz

99% Occupied Bandwidth Test Results, 40 MHz

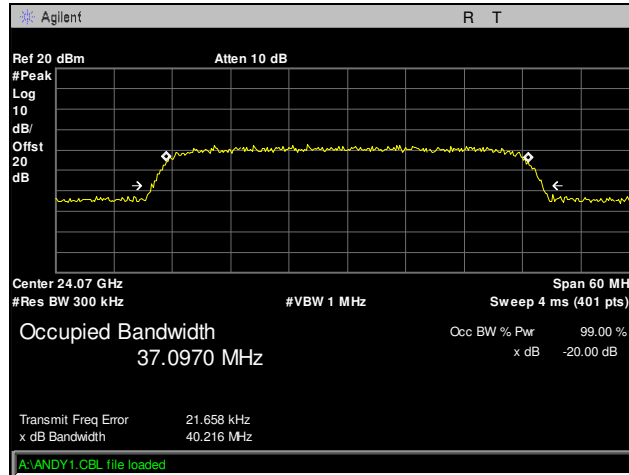

Plot 257. 99% Occupied Bandwidth, Low Channel, 40 MHz

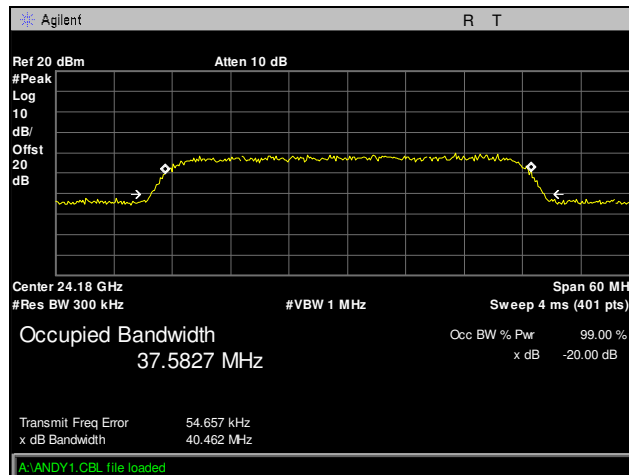

Plot 258. 99% Occupied Bandwidth, Mid Channel, 40 MHz

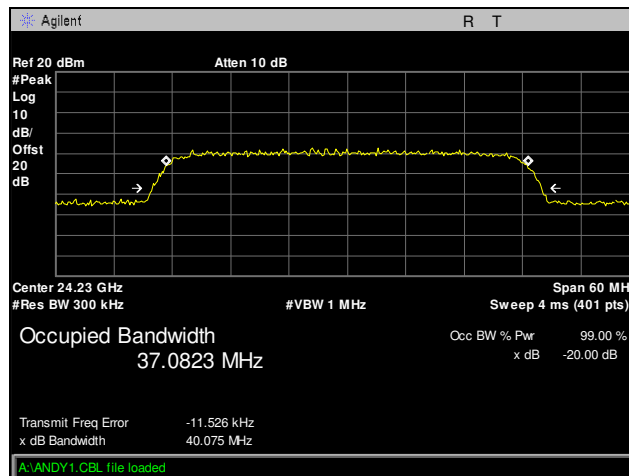

Plot 259. 99% Occupied Bandwidth, High Channel, 40 MHz

99% Occupied Bandwidth Test Results, 50 MHz

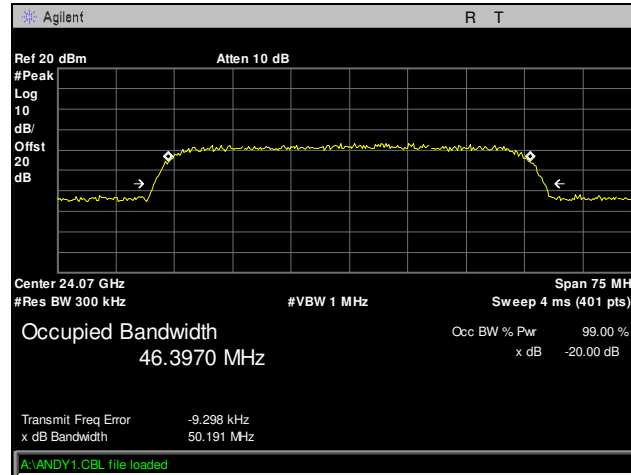

Plot 260. 99% Occupied Bandwidth, Low Channel, 50 MHz

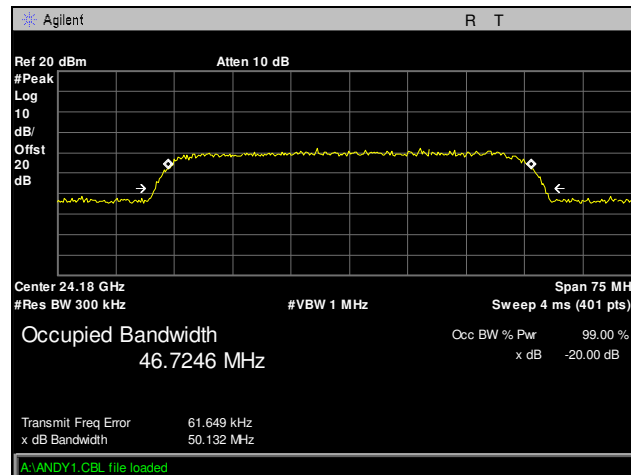

Plot 261. 99% Occupied Bandwidth, Mid Channel, 50 MHz

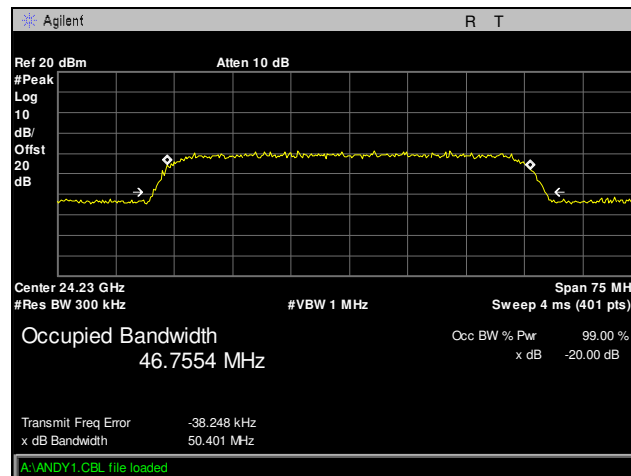

Plot 262. 99% Occupied Bandwidth, High Channel, 50 MHz

Electromagnetic Compatibility Criteria for Intentional Radiators

§RSS-210 A12 Power to Antenna

Test Requirements: Fixed, point-to-point operation is permitted in the band 24.05–24.25 GHz under the following condition:

The power delivered to the antenna shall not exceed 1 mW.

Test Procedure: The transmitter was connected to a calibrated spectrum analyzer. The EUT was measured at the low, mid and high channels at the maximum power level for all the given bandwidths.

Test Results The EUT was compliant with this section.

Test Engineer(s): Kaushani Dasgupta

Test Date(s): 02/22/16

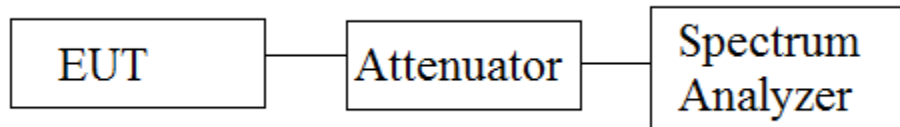
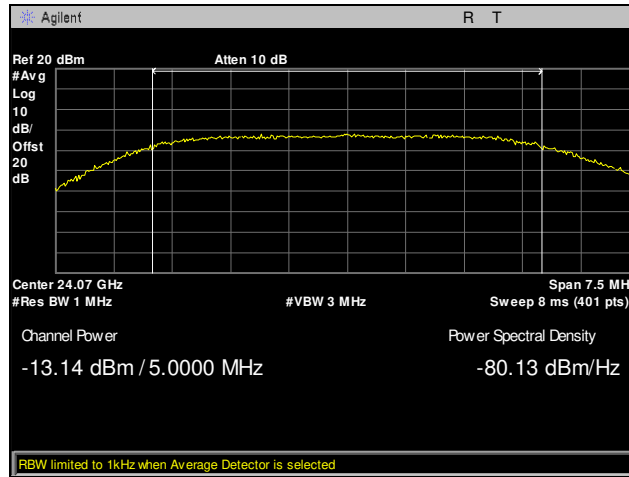
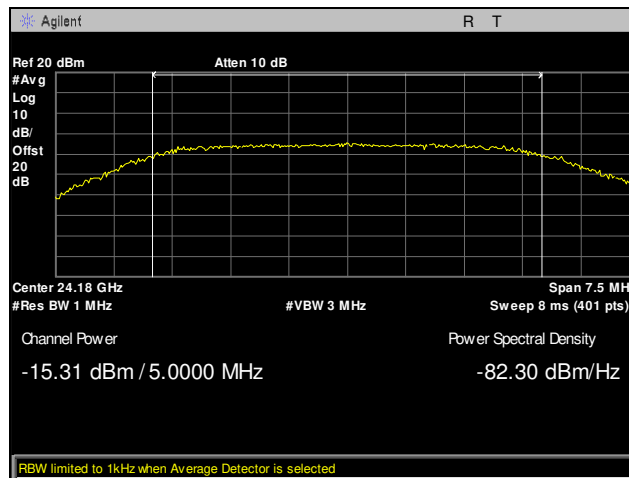

Figure 2. Power to Antenna Test Setup

Measured Power Test Results, 5 MHz



Plot 263. Measured Power, Low Channel, 5 MHz



Plot 264. Measured Power, Mid Channel, 5 MHz

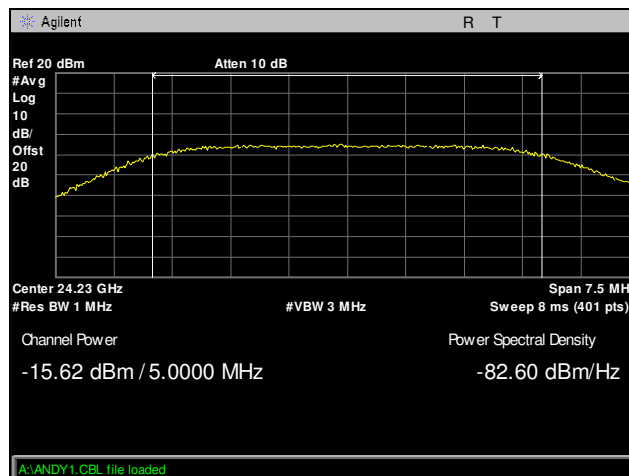

Plot 265. Measured Power, High Channel, 5 MHz

Measured Power Test Results, 10 MHz

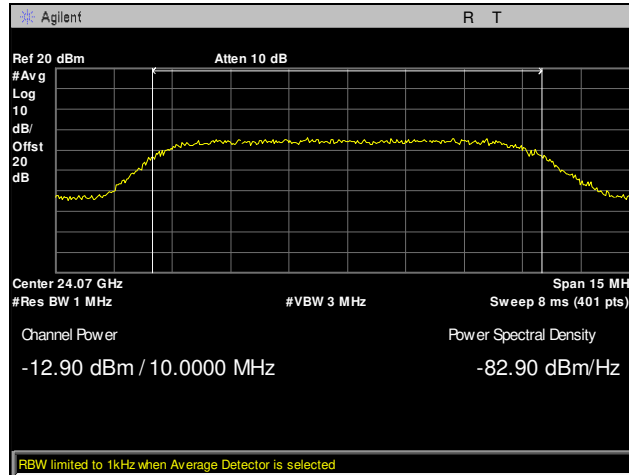

Plot 266. Measured Power, Low Channel, 10 MHz

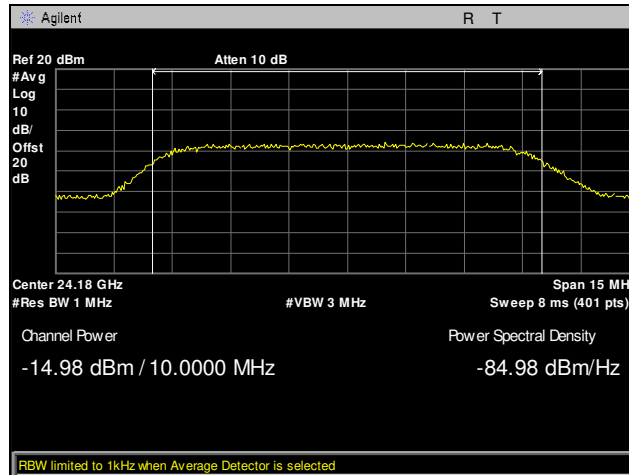

Plot 267. Measured Power, Mid Channel, 10 MHz

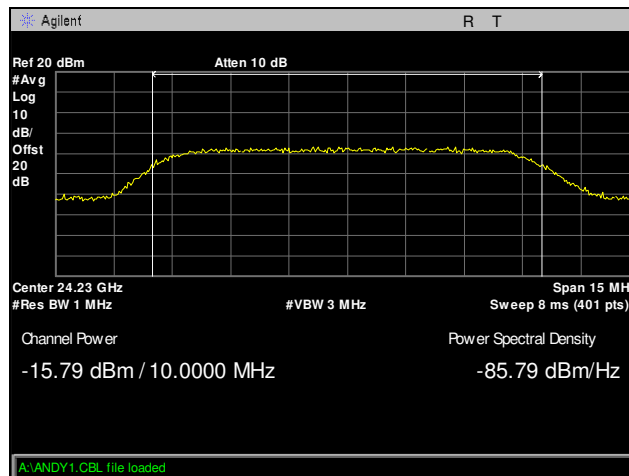

Plot 268. Measured Power, High Channel, 10 MHz

Measured Power Test Results, 20 MHz

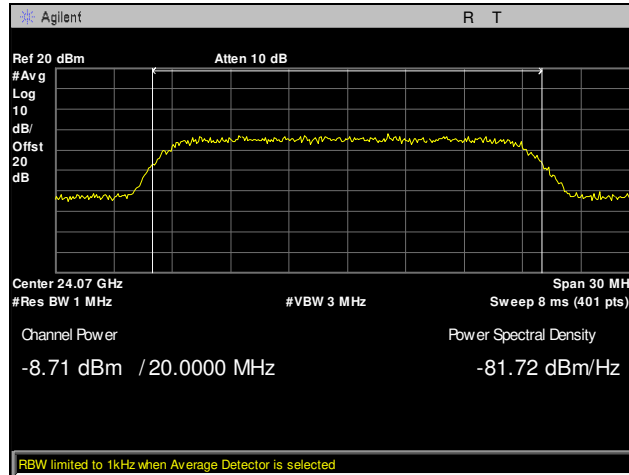

Plot 269. Measured Power, Low Channel, 20 MHz

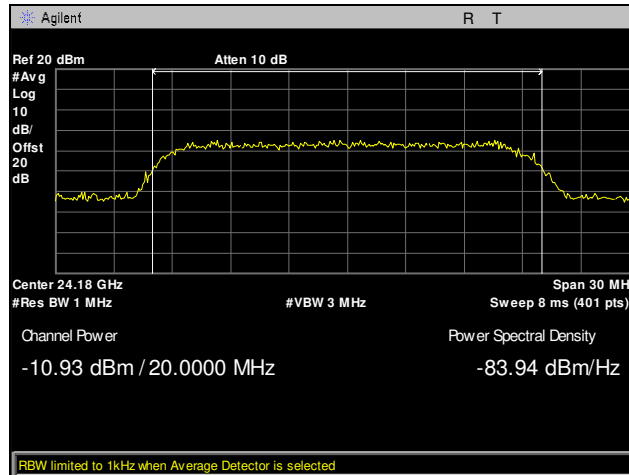

Plot 270. Measured Power, Mid Channel, 20 MHz

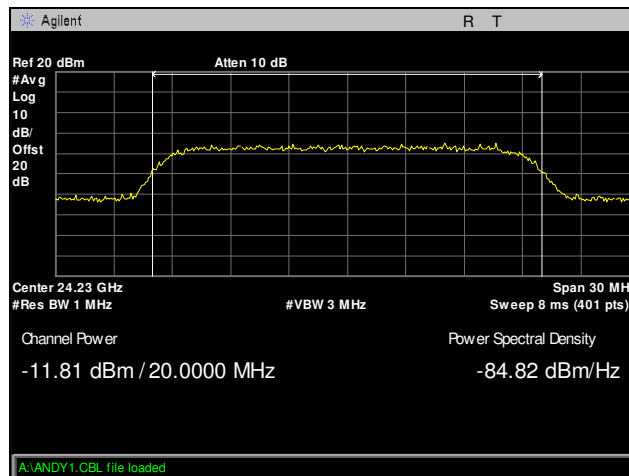

Plot 271. Measured Power, High Channel, 20 MHz

Measured Power Test Results, 25 MHz

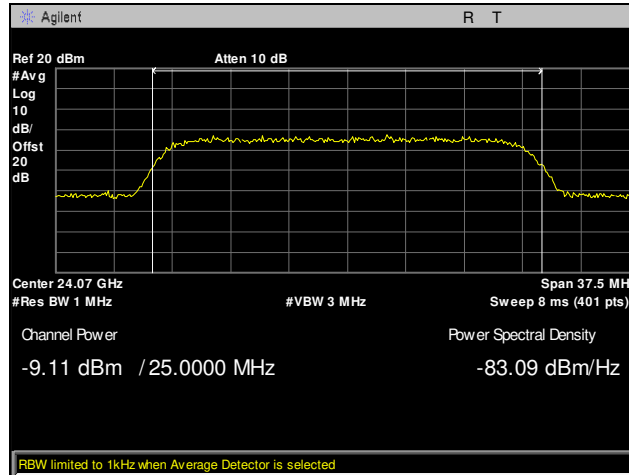

Plot 272. Measured Power, Low Channel, 25 MHz

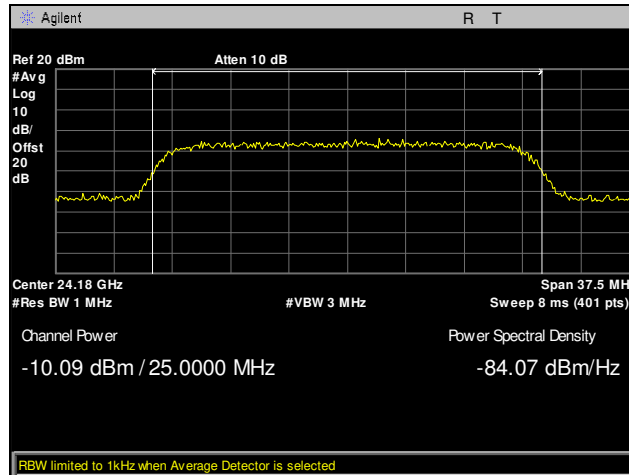

Plot 273. Measured Power, Mid Channel, 25 MHz

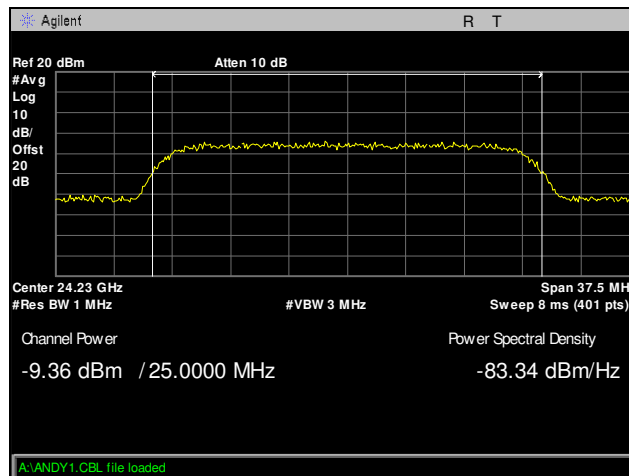

Plot 274. Measured Power, High Channel, 25 MHz

Measured Power Test Results, 30 MHz

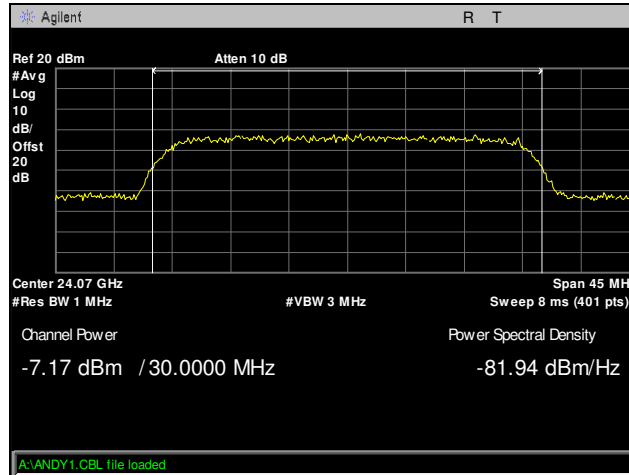

Plot 275. Measured Power, Low Channel, 30 MHz

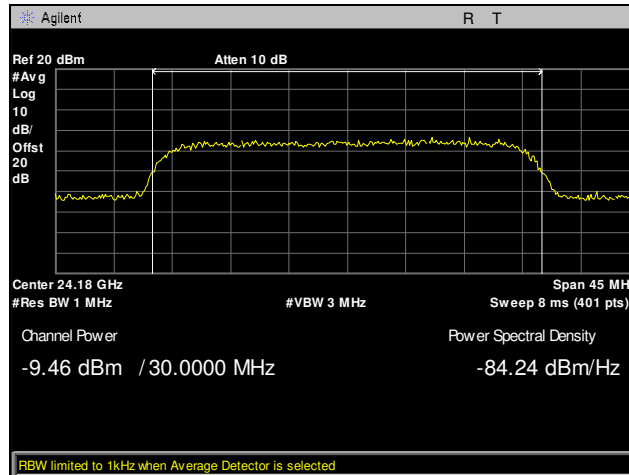

Plot 276. Measured Power, Mid Channel, 30 MHz

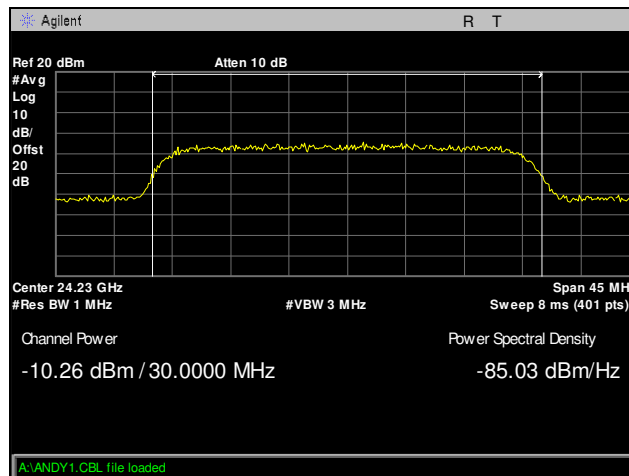

Plot 277. Measured Power, High Channel, 30 MHz

Measured Power Test Results, 40 MHz

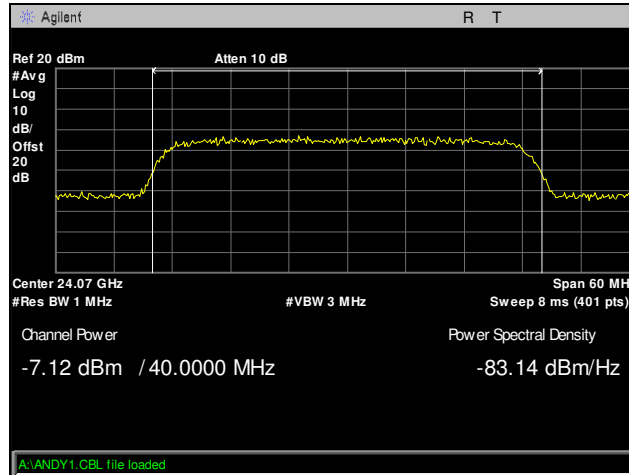

Plot 278. Measured Power, Low Channel, 40 MHz

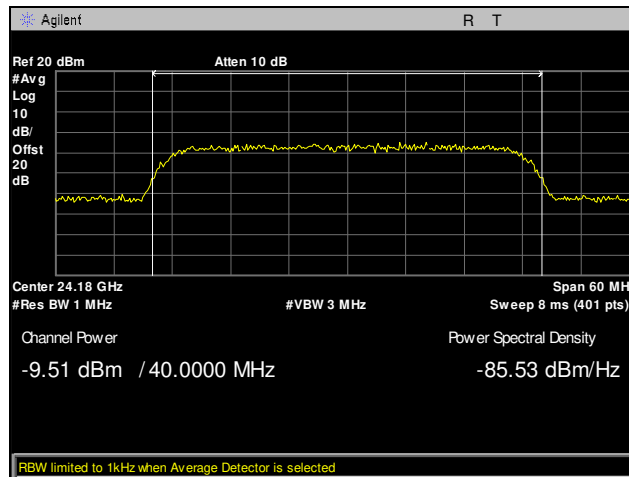

Plot 279. Measured Power, Mid Channel, 40 MHz

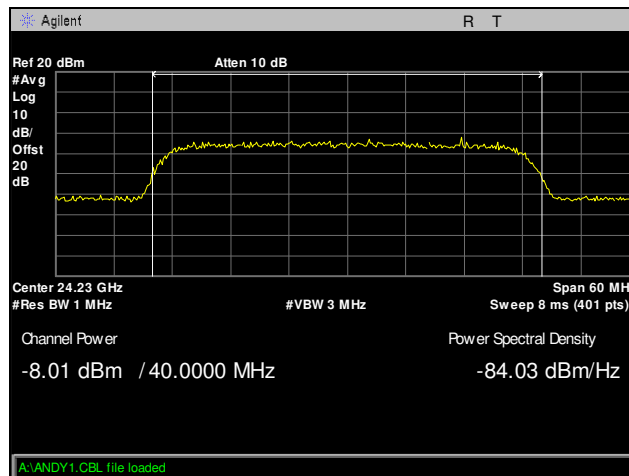

Plot 280. Measured Power, High Channel, 40 MHz

Measured Power Test Results, 50 MHz

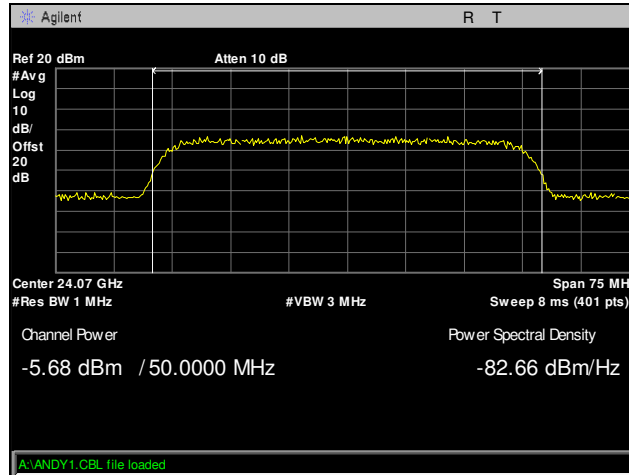

Plot 281. Measured Power, Low Channel, 50 MHz

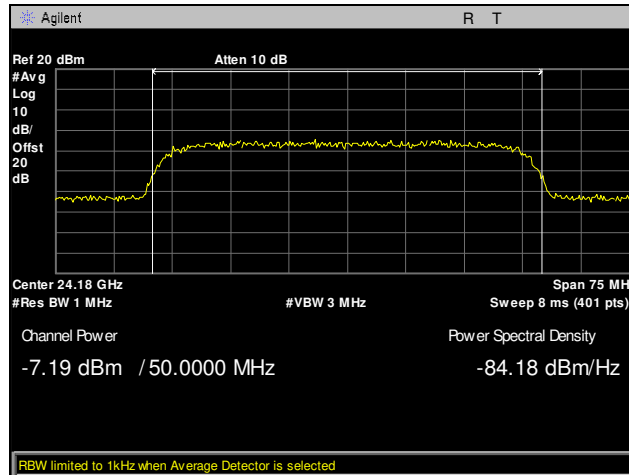

Plot 282. Measured Power, Mid Channel, 50 MHz

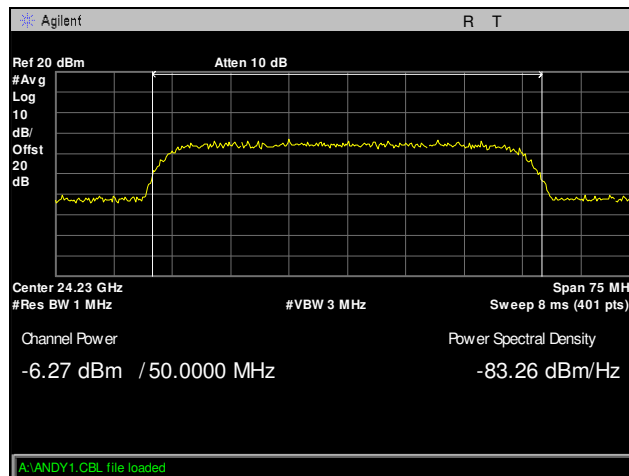

Plot 283. Measured Power, High Channel, 50 MHz

IV. Test Equipment

Test Equipment

Calibrated test equipment utilized during testing was maintained in a current state of calibration per the requirements of ISO/IEC 17025:2005.

MET Asset #	Equipment	Manufacturer	Model	Last Cal Date	Cal Due Date
1S2486	5 METER CHAMBER CONTROL ROOM	PANASHIELD	5 METER CONTROL ROOM	NOT REQUIRED	
1S3928	EMI TESTER RECEIVER	ROHDE & SCHWARZ	ESR26	10/14/2015	10/14/2016
1S2229	TEMPERATURE CHAMBER	TENNY ENGINEERING	T63C	5/4/2015	11/4/2016
1S3835	PSA SPECTRUM ANALYZER	AGILENT TECHNOLOGIES	E4448A	11/20/2015	11/20/2017
1S3787	PRE-AMPLIFIER	MITEQ	JS44-18004000-35-8P	SEE NOTE	
1S2607	SPECTRUM ANALYZER ESA-E	AGILENT/HEWLETT PACKARD	E4407B	9/11/2014	3/11/2016
1S2405	PRE-AMPLIFIER	HEWLETT PACKARD	8447D	SEE NOTE	
1S3826	DRG HORN ANTENNA	ETS-LINDGREN	3117	4/22/2015	4/22/2017
1S2121	PRE-AMPLIFIER	HEWLETT PACKARD	8449B	SEE NOTE	
1S2698	DOUBLE RIDGE GUIDE HORN ANTENNA	A.H. SYSTEMS, INC.	SAS-574	4/14/2015	10/14/2016
1S3797	PRE-AMPLIFIER	MITEQ	JS44-18004000-35-8P	SEE NOTE	
1T4853	WR-15 HARMONIC MIXER WITH HORN ANTENNA	OML, INC.	M15HWA	SEE NOTE	
1T4854	WR-10 HARMONIC MIXER WITH HORN ANTENNA	OML, INC.	M10HWA	SEE NOTE	
1S3898	VOLTAGE REGULATOR	VOLTEQ	TDGC2-5KVA	SEE NOTE	
1S2501	EMI TEST RECEIVER 20HZ-40GHZ	ROHDE & SCHWARZ	ESU40	10/27/2015	10/27/2016
1S2583	SPECTRUM ANALYZER	AGILENT/HEWLETT PACKARD	E4447A	1/19/2015	1/19/2016
1S2600	BILOG ANTENNA	TESEQ	CBL6112D	10/5/2015	10/5/2016
1S2488	SCREEN ROOM	UNIVERSAL	CUSTOM MADE	NOT REQUIRED	
1S2678	LISN, DUAL-LINE V-NETWORK	TESEQ	NNB 51	2/3/2015	2/3/2016
1U0304	EMI RECEIVER	NARDA	PMM 9010	7/31/2015	7/31/2016
1S2399	TURNTABLE CONTROLLER	SUNOL SCIENCE	SC99V	NOT REQUIRED	
1S2405	PRE-AMPLIFIER	HEWLETT PACKARD	8447D	SEE NOTE	

Table 20. Test Equipment

Note: Functionally tested equipment is verified using calibrated instrumentation at the time of testing.



V. Certification & User's Manual Information



Certification & User's Manual Information

A. Certification Information

The following is extracted from Title 47 of the Code of Federal Regulations, Part 2, Subpart I — Marketing of Radio frequency devices:

§ 2.801 Radio-frequency device defined.

As used in this part, a radio-frequency device is any device which in its operation is capable of Emitting radio-frequency energy by radiation, conduction, or other means. Radio- frequency devices include, but are not limited to:

- (a) The various types of radio communication transmitting devices described throughout this chapter.
- (b) *The incidental, unintentional and intentional radiators defined in Part 15 of this chapter.*
- (c) The industrial, scientific, and medical equipment described in Part 18 of this chapter.
- (d) Any part or component thereof which in use emits radio-frequency energy by radiation, conduction, or other means.

§ 2.803 Marketing of radio frequency devices prior to equipment authorization.

- (a) Except as provided elsewhere in this chapter, no person shall sell or lease, or offer for sale or lease (including advertising for sale or lease), or import, ship or distribute for the purpose of selling or leasing or offering for sale or lease, any radio frequency device unless:
 - (1) In the case of a device subject to certification, such device has been authorized by the Commission in accordance with the rules in this chapter and is properly identified and labeled as required by §2.925 and other relevant sections in this chapter; or
 - (2) In the case of a device that is not required to have a grant of equipment authorization issued by the Commission, but which must comply with the specified technical standards prior to use, such device also complies with all applicable administrative (including verification of the equipment or authorization under a Declaration of Conformity, where required), technical, labeling and identification requirements specified in this chapter.
- (d) Notwithstanding the provisions of paragraph (a) of this section, the offer for sale solely to business, commercial, industrial, scientific or medical users (but not an offer for sale to other parties or to end users located in a residential environment) of a radio frequency device that is in the conceptual, developmental, design or pre-production stage is permitted prior to equipment authorization or, for devices not subject to the equipment authorization requirements, prior to a determination of compliance with the applicable technical requirements *provided* that the prospective buyer is advised in writing at the time of the offer for sale that the equipment is subject to the FCC rules and that the equipment will comply with the appropriate rules before delivery to the buyer or to centers of distribution.



- (e)(1) Notwithstanding the provisions of paragraph (a) of this section, prior to equipment authorization or determination of compliance with the applicable technical requirements any radio frequency device may be operated, but not marketed, for the following purposes and under the following conditions:
- (i) *Compliance testing;*
 - (ii) Demonstrations at a trade show provided the notice contained in paragraph (c) of this section is displayed in a conspicuous location on, or immediately adjacent to, the device;
 - (iii) Demonstrations at an exhibition conducted at a business, commercial, industrial, scientific or medical location, but excluding locations in a residential environment, provided the notice contained in paragraphs (c) or (d) of this section, as appropriate, is displayed in a conspicuous location on, or immediately adjacent to, the device;
 - (iv) Evaluation of product performance and determination of customer acceptability, provided such operation takes place at the manufacturer's facilities during developmental, design or pre-production states; or
 - (v) Evaluation of product performance and determination of customer acceptability where customer acceptability of a radio frequency device cannot be determined at the manufacturer's facilities because of size or unique capability of the device, provided the device is operated at a business, commercial, industrial, scientific or medical user's site, but not at a residential site, during the development, design or pre-production stages.
- (e)(2) For the purpose of paragraphs (e)(1)(iv) and (e)(1)(v) of this section, the term *manufacturer's facilities* includes the facilities of the party responsible for compliance with the regulations and the manufacturer's premises, as well as the facilities of other entities working under the authorization of the responsible party in connection with the development and manufacture, but not the marketing, of the equipment.
- (f) For radio frequency devices subject to verification and sold solely to business, commercial, industrial, scientific and medical users (excluding products sold to other parties or for operation in a residential environment), parties responsible for verification of the devices shall have the option of ensuring compliance with the applicable technical specifications of this chapter at each end user's location after installation, provided that the purchase or lease agreement includes a proviso that such a determination of compliance be made and is the responsibility of the party responsible for verification of the equipment.



Certification & User's Manual Information

The following is extracted from Title 47 of the Code of Federal Regulations, Part 2, Subpart J — Equipment Authorization Procedures:

§ 2.901 Basis and Purpose

- (a) In order to carry out its responsibilities under the Communications Act and the various treaties and international regulations, and in order to promote efficient use of the radio spectrum, the Commission has developed technical standards for radio frequency equipment and parts or components thereof. The technical standards applicable to individual types of equipment are found in that part of the rules governing the service wherein the equipment is to be operated.¹ *In addition to the technical standards provided, the rules governing the service may require that such equipment be verified by the manufacturer or importer, be authorized under a Declaration of Conformity, or receive an equipment authorization from the Commission by one of the following procedures: certification or registration.*
- (b) The following sections describe the verification procedure, the procedure for a Declaration of Conformity, and the procedures to be followed in obtaining certification from the Commission and the conditions attendant to such a grant.

§ 2.907 Certification.

- (a) Certification is an equipment authorization issued by the Commission, based on representation and test data submitted by the applicant.
- (b) Certification attaches to all units subsequently marketed by the grantee which are identical (see Section 2.908) to the sample tested except for permissive changes or other variations authorized by the Commission pursuant to Section 2.1043.

¹ In this case, the equipment is subject to the rules of Part 15. More specifically, the equipment falls under Subpart B (of Part 15), which deals with unintentional radiators.



Certification & User's Manual Information

§ 2.948 Description of measurement facilities.

- (a) Each party making measurements of equipment that is subject to an equipment authorization under Part 15 or Part 18 of this chapter, regardless of whether the measurements are filed with the Commission or kept on file by the party responsible for compliance of equipment marketed within the U.S. or its possessions, shall compile a description of the measurement facilities employed.
 - (1) If the measured equipment is subject to the verification procedure, the description of the measurement facilities shall be retained by the party responsible for verification of the equipment.
 - (i) *If the equipment is verified through measurements performed by an independent laboratory, it is acceptable for the party responsible for verification of the equipment to rely upon the description of the measurement facilities retained by or placed on file with the Commission by that laboratory. In this situation, the party responsible for the verification of the equipment is not required to retain a duplicate copy of the description of the measurement facilities.*
 - (ii) If the equipment is verified based on measurements performed at the installation site of the equipment, no specific site calibration data is required. It is acceptable to retain the description of the measurement facilities at the site at which the measurements were performed.
 - (2) If the equipment is to be authorized by the Commission under the certification procedure, the description of the measurement facilities shall be filed with the Commission's Laboratory in Columbia, Maryland. The data describing the measurement facilities need only be filed once but must be updated as changes are made to the measurement facilities or as otherwise described in this section. At least every three years, the organization responsible for filing the data with the Commission shall certify that the data on file is current.



Certification & User's Manual Information

Label and User's Manual Information

The following is extracted from Title 47 of the Code of Federal Regulations, Part 15, Subpart A — General:

§ 15.19 Labeling requirements.

(a) *In addition to the requirements in Part 2 of this chapter, a device subject to certification or verification shall be labeled as follows:*

- (1) Receivers associated with the operation of a licensed radio service, e.g., FM broadcast under Part 73 of this chapter, land mobile operation under Part 90, etc., shall bear the following statement in a conspicuous location on the device:

This device complies with Part 15 of the FCC Rules. Operation is subject to the condition that this device does not cause harmful interference.

- (2) A stand-alone cable input selector switch, shall bear the following statement in a conspicuous location on the device:

This device is verified to comply with Part 15 of the FCC Rules for use with cable television service.

- (3) All other devices shall bear the following statement in a conspicuous location on the device:

This device complies with Part 15 of the FCC Rules. Operation is subject to the following two conditions: (1) This device may not cause harmful interference, and (2) this device must accept any interference received, including interference that may cause undesired operation.

- (4) Where a device is constructed in two or more sections connected by wires and marketed together, the statement specified under paragraph (a) of this section is required to be affixed only to the main control unit.

- (5) When the device is so small or for such use that it is not practicable to place the statement specified under paragraph (a) of this section on it, the information required by this paragraph shall be placed in a prominent location in the instruction manual or pamphlet supplied to the user or, alternatively, shall be placed on the container in which the device is marketed. However, the FCC identifier or the unique identifier, as appropriate, must be displayed on the device.

§ 15.21 Information to user.

The users manual or instruction manual for an intentional or unintentional radiator shall caution the user that changes or modifications not expressly approved by the party responsible for compliance could void the user's authority to operate the equipment.



Verification & User's Manual Information

The following is extracted from Title 47 of the Code of Federal Regulations, Part 15, Subpart B — Unintentional Radiators:

§ 15.105 Information to the user.

- (a) For a Class A digital device or peripheral, the instructions furnished the user shall include the following or similar statement, placed in a prominent location in the text of the manual:

Note: This equipment has been tested and found to comply with the limits for a Class A digital device, pursuant to Part 15 of the FCC Rules. These limits are designed to provide reasonable protection against harmful interference when the equipment is operated in a commercial environment. This equipment generates, uses, and can radiate radio frequency energy and, if not installed and used in accordance with the instruction manual, may cause harmful interference to radio communications. Operation of this equipment in a residential area is likely to cause harmful interference in which case the user will be required to correct the interference at own expense.

- (b) For a Class B digital device or peripheral, the instructions furnished the user shall include the following or similar statement, placed in a prominent location in the text of the manual:

Note: This equipment has been tested and found to comply with the limits for a Class B digital device, pursuant to Part 15 of the FCC Rules. These limits are designed to provide reasonable protection against harmful interference when the equipment is operated in a residential environment. This equipment generates, uses, and can radiate radio frequency energy and, if not installed and used in accordance with the instruction manual, may cause harmful interference to radio communications. However, there is no guarantee that interference will not occur in a particular installation. If this equipment does cause harmful interference to radio or television reception, which can be determined by turning the equipment off and on, the user is encouraged to try to correct the interference by one or more of the following measures:

- Reorient or relocate the receiving antenna.
- Increase the separation between the equipment and receiver.
- Connect the equipment into an outlet on a circuit different from that to which the receiver is connected.
- Consult the dealer or an experienced radio/TV technician for help.



ICES-003 Procedural & Labeling Requirements

From the Industry Canada Electromagnetic Compatibility Advisory Bulletin entitled, "Implementation and Interpretation of the Interference-Causing Equipment Standard for Digital Apparatus, ICES-003" (EMCAB-3, Issue 2, July 1995):

"At present, CISPR 22: 2002 and ICES technical requirements are essentially equivalent. Therefore, if you have CISPR 22: 2002 approval by meeting CISPR Publication 22, the only additional requirements are: to attach a note to the report of the test results for compliance, indicating that these results are deemed satisfactory evidence of compliance with ICES-003 of the Canadian Interference-Causing Equipment Regulations; to maintain these records on file for the requisite five year period; and to provide the device with a notice of compliance in accordance with ICES-003."

Procedural Requirements:

According to Industry Canada's Interference Causing Equipment Standard for Digital Apparatus ICES-003 Issue 4, February 2004:

- Section 6.1: A record of the measurements and results, showing the date that the measurements were completed, shall be retained by the manufacturer or importer for a period of at least five years from the date shown in the record and made available for examination on the request of the Minister.
- Section 6.2: A written notice indicating compliance must accompany each unit of digital apparatus to the end user. The notice shall be in the form of a label that is affixed to the apparatus. Where because of insufficient space or other constraints it is not feasible to affix a label to the apparatus, the notice may be in the form of a statement in the user's manual.

Labeling Requirements:

The suggested text for the notice, in English and in French, is provided below, from the Annex of ICES-003:

This Class [²] digital apparatus complies with Canadian ICES-003.

Cet appareil numérique de la classe [¹] est conforme à la norme NMB-003 du Canada.

² Insert either A or B but not both as appropriate for the equipment requirements.

End of Report