

# **ExtendAir<sup>®</sup> eMI MO<sup>™</sup> and ExpandAir<sup>®</sup> Series Digital Microwave Radios Installation and Management Guide**



**Models:**  
**r5050 & rc5050 Series**  
**r5600H-17 & rc5600H-N**  
**r5661S-17**  
**r5600S-23 & r5600S-N**

## Legal Notice

The information contained herein is the property of Exalt Wireless, Inc. (“Exalt”) and is supplied without liability for errors or omissions. No part of this document may be reproduced, in any form, except as authorized by contract or other written permission from the owner.

Any brand names and product names included in this manual are trademarks, registered trademarks, or trade names of their respective holders.

The contents of this document are current as of the date of publication. Exalt reserves the right to change the contents without prior notice.

The publication of information in this document does not imply freedom from patent or other rights of Exalt or others.

© 2013 Exalt Wireless Inc. All rights reserved.

The Exalt logo, ExtremeAir, and ExploreAir are registered trademarks of Exalt Wireless, Inc.

## Open-Source License Information

Per the terms of your Exalt Limited Hardware Warranty, Software License, and RMA Procedures Agreement with Exalt Wireless, Inc. and/or its subsidiaries, certain Third Party Software may be provided with and as part of the Exalt products provided to you, and any such Third Party Software files provided are governed by the terms of their separate Third Party Licenses, which licenses give you at least the license rights licensed to you in the Exalt End User Agreement and may give you additional license rights as to the Third Party Software, but only with respect to the particular Third Party Software to which the Third Party License applies.

The Exalt Products may include or be bundled with some or all of the following third party software. Copies of the copyright notices and license agreements for any or all of these may be requested by contacting Exalt support at email: [support@exaltcom.com](mailto:support@exaltcom.com).

Open Source Code	License Agreement	Website
Embedded Linux - OS U-Boot	Boot Code. Both licensed under GPL Version 3	<a href="http://www.gnu.org">www.gnu.org</a> <a href="http://www.sourceforge.net">www.sourceforge.net</a>
Busy Box	Linux Commands. Licensed under GPL Version 2	<a href="http://www.gnu.org">www.gnu.org</a> and <a href="http://www.busybox.net">www.busybox.net</a>
Scew	Expat Wrapper. Licensed under LGPL Version 3	<a href="http://www.gnu.org">www.gnu.org</a>
OpenSSL	SSL Web Access. Licensed under dual license	<a href="http://www.openssl.org">www.openssl.org</a>
Net-SNMP	SNMP Agent. Licensed under NetSNMP (see <a href="#">Copyright Notices</a> )	
Dropbear	SSH 2 Server; Expat - XML Parser; BarelyFitz – Java Script Tabifier; and Flotr – Java Script Plotting Library. All four are licensed under MIT License	<a href="http://www.opensource.org/licenses/mit-license.php">www.opensource.org/licenses/mit-license.php</a>
GoAhead Webserver	Licensed under GoAhead License Agreement	<a href="http://www.goahead.com">www.goahead.com</a>

## Table of Contents

Legal Notice .....	ii
Open-Source License Information .....	ii
List of Figures .....	vi
List of Tables .....	vii
About this Document .....	viii
Revision History .....	viii
Icons .....	viii
Introduction .....	1
Related Documentation and Software .....	1
The ExtendAir eMIMO and ExpandAir Series Digital Microwave Radios .....	1
Basic Features .....	3
ExpandAir Hub and Subscriber Models .....	4
Pre-installation Tasks .....	5
Link Engineering and Site Planning .....	5
Familiarization with the ExtendAir eMIMO and ExpandAir Series Radios .....	5
Initial Configuration and Back-to-Back Bench Test .....	7
Time Division Duplex (TDD) Factors .....	8
Link Orientation .....	9
System Installation and Initiation Process .....	11
Record Keeping .....	12
Installation .....	13
Mechanical Configuration and Mounting .....	13
Radio Ports and Indicators .....	14
Power .....	15
Ethernet Lightning/Surge Protection .....	16
Antenna/Transmission System .....	16
Transmission Line from Antenna to Radio .....	17
Antenna Alignment .....	19
Configuration and Management .....	21
Quick Start .....	23
Navigating the GUI .....	24
Radio Information Page .....	26
Administration Settings Page .....	27
NTP and Time Zone Page .....	29
SNMP Configuration Page .....	30
SNMP Trap Configuration Page .....	31
File Management Page .....	32
System Configuration Page .....	34
Ethernet Page .....	38
Access Control List Page .....	42
VLAN Configuration Page .....	44
Antenna Alignment Settings Page .....	47
Radio Default Page .....	48
Performance Page .....	49
Ethernet Negotiation State Page .....	51
Subscriber Page—Hub models only .....	52

Metrics – Link Statistics and Radio Interface Statistics Page	53
DFS Page	56
Event Log Page	58
Spectrum Analyzer Page	59
Reboot Page	63
Shutdown Page	64
Manual Page	65
Specifications–ExtendAir Models	66
Physical Specifications	66
System Specifications, 4.9GHz Band	68
System Specifications, 5.3GHz Band	69
System Specifications, 5.4GHz Band	70
System Specifications, 5.8GHz Band	71
Interfaces	72
Specifications–ExpandAir Models	73
Physical Specifications	73
System Specifications, 4.9GHz Band	75
System Specifications, 5.3GHz Band	76
System Specifications, 5.4GHz Band	77
System Specifications, 5.8GHz Band	78
Interfaces	79
Interface Connections	80
Sync Connector	80
Power/ETH1 Connector	81
Antennas	82
Troubleshooting	88
General Practices	88
Typical Indications of Issues	89
Improper RF Cable Termination	90
Multipath Propagation	90
RF Interference	90
Path Obstruction	91
Misaligned Antenna	91
Faulty Antenna (connectorized antenna rc-models only)	91
Improper Grounding	91
Insufficient Link Margin	92
Moisture in the Transmission System	92
Back-to-back Bench Testing	93
Basic Test	93
Specification Performance Verification	94
General Compliance and Safety	95
Dynamic Frequency Selection	96
Safety Notices	98
Regulatory Notices	99
United States Compliance	99
Canada Compliance	100
Europe and ITU Country Compliance	101

Regulatory Compliance ..... 102

EIRP Limits for the United States and Canada ..... 104

    EIRP for the USA and Canada ..... 104

EIRP Limits for Australia ..... 106

EIRP Limits for the European Union and ITU Countries ..... 107

    50xx Series EIRP ..... 107

Declaration of Conformity to the R&TTE Directive

1999/5/EC ..... 110

    EU WEEE ..... 110

    EU RoHS ..... 111

Copyright Notices ..... 112

END USER AGREEMENT ..... 116

Index ..... 121

## List of Figures

Figure 1	Exalt ExtendAir eMIMO and ExpandAir Series Radios	1
Figure 2	Cabling and mounting	3
Figure 3	Radio installation tasks	11
Figure 4	Pole-mount examples—r model at left; rc model at right	13
Figure 5	ExtendAir eMIMO and ExpandAir Series connectors	14
Figure 6	Initiating the browser connection	22
Figure 7	Browser Login screen	22
Figure 8	Radio Information page	23
Figure 9	Exalt GUI window description	24
Figure 10	Radio Information page – ExtendAir model (-W rest-of-world model)	26
Figure 11	Administration Settings page—ExtendAir model	27
Figure 12	NTP and Time Zone page	29
Figure 13	SNMP Configuration page	30
Figure 14	SNMP Trap Configuration page	31
Figure 15	File Management page—ExtendAir model	32
Figure 16	File Transfer link page	33
Figure 17	System Configuration page—ExtendAir eMIMO model	34
Figure 18	Ethernet page	38
Figure 19	ExpandAir In-band Management Configuration	39
Figure 20	Band management example	40
Figure 21	ExpandAir Out-of-band Management Configuration	41
Figure 22	Access Control List page—ExtendAir Hub model	42
Figure 23	Access Control List—ExpandAir Sub model	43
Figure 24	VLAN Configuration page	44
Figure 25	Antenna Alignment Settings page—ExtendAir model	47
Figure 26	Radio Default page	48
Figure 27	Performance page—ExtendAir Term-RadioB/Sub model	49
Figure 28	Radio Collocation pane—RadioB/Sub	50
Figure 29	Radio Collocation pane—RadioA/Hub	50
Figure 30	Ethernet Negotiation State page	51
Figure 31	Subscribers page—ExpandAir Hub models only	52
Figure 32	Metrics page—ExtendAir RadioA/Hub model	53
Figure 33	DFS page—ExpandAir model	56
Figure 34	Event Log page	58
Figure 35	Spectrum Analyzer page	59
Figure 36	Spectrum Analyzer example	61
Figure 37	Reboot page—ExpandAir model	63
Figure 38	Shutdown page—ExpandAir model	64
Figure 39	Sync In/Sync Out connector	80
Figure 40	Power/ETH1 connector	81
Figure 41	Basic back-to-back bench test configuration	93

## List of Tables

Table 1	Factory default settings .....	9
Table 2	Connectors .....	14
Table 3	LED indicators–TBD .....	15
Table 4	Recommended transmission line .....	18
Table 5	Default login information .....	22
Table 6	Dual-polarity Antennas .....	82
Table 7	Single-polarity Antennas .....	85
Table 8	Product Approvals (Exalt) .....	102
Table 9	EU and ITU Country Specific EIRP Levels .....	109

## About this Document

This manual provides a complete description of the ExtendAir eMIMO and ExpandAir Series Digital Microwave Radios and related software. This manual provides planners, engineers, installers, system administrators, and technicians general and specific information related to the planning, installation, operation, management, and maintenance of these devices.

## Revision History

Date	Feature Support
2013-06-20	Initial release.
2013-08-30	DFS bands and QoS disable features release.
2013-11-15	DFS release for North America version; metrics page improvements.
2013-12-23	Added new Shutdown button and buzzer features.
2014-02-21	Added ExpandAir models.
2014-05-16	First unified ExtendAir and ExpandAir eMIMO release. Sync and TDMA features added to ExtendAir; SNMP, NTP, and Event Log features added to all models.
2014-08-22	Added Out-of-Band Management, VLAN, and Spectrum Analyzer features.
2016-05-26	Updated to include current contact information and information on FCC Class II Permissive Changes.

## Icons

The following icons denote specific types of information:



**Note:** This symbol means take note. Notes contain helpful suggestions or references to materials not contained in the manual.



**Warning!** This warning symbol means there is a risk of electric shock. This situation that could cause bodily injury. Before working on any equipment, be aware of the hazards involved with electrical circuitry and be familiar with standard practices for preventing accidents.



**Caution!** This symbol means be careful. There is a risk of doing something that might result in equipment damage or loss of data. This is a general warning, caution, or risk of danger.



## Introduction

Exalt Wireless, Inc. thanks you for your purchase. Our goal is to build the highest quality, highest reliability digital microwave radio products. This commitment to quality and reliability extends to our employees and partners alike. We appreciate any comments on how we can improve our products, as well as your sales and Customer Care experience.

Customer Care Hotline (USA):	(408) 740-3622
Toll-Free Customer Care Hotline (USA):	(844) EXALT-01 (392-5801)
Website:	www.exaltcom.com
Sales e-mail:	sales@exaltcom.com
Customer Care e-mail:	support@exaltcom.com
Mailing Address:	Exalt Wireless, Inc. 530 Division Street Campbell, CA 95129 USA

## Related Documentation and Software

This manual makes reference to other documentation and software files that may be necessary. To access all documents and software mentioned in this manual visit:

<http://login.exaltcom.com/>

You must have a user account to view all downloads. Follow the online instructions to create a user account and request access.

## The ExtendAir eMIMO and ExpandAir Series Digital Microwave Radios

The Exalt ExtendAir eMIMO and ExpandAir Series Digital Microwave Radios are the most advanced quad-band radios operating in the 4.9, 5.3, 5.4, and 5.8 GHz bands. The ExtendAir eMIMO and ExpandAir Series radios connect digital data from one location to another, obviating the need for copper or fiber connectivity, or enhancing existing connectivity by providing a redundancy solution, a primary solution, and/or additional capacity. Figure 1 shows the ExtendAir eMIMO and ExpandAir Series digital microwave radios.



Figure 1 Exalt ExtendAir eMIMO and ExpandAir Series Radios

The following ExtendAir eMIMO and ExpandAir Series radios (-A North American models; -E ETSI/ITU models; -W rest-of-world models) are covered in this manual:

- r5050 and rc5050
  - configured with 100 Mbps aggregate over-the-air capacity (1PoE port plus two Ethernet ports)
  - with license key upgrade for 250 Mbps aggregate over-the-air capacity
- r5600H-17, rc5600H-N, r5661S-17, r5600S-23, and r5600S-N (-17 models have a built-in software-selectable 17/9dBi gain antenna [20° or 60° 3dB Beamwidth]; -23 models have a built-in 23dBi gain antenna [10° 3dB Beamwidth])
  - configured with 100 Mbps aggregate over-the-air capacity (1PoE port plus two Ethernet ports)
  - with license key upgrade for 250 Mbps aggregate over-the-air capacity

The ExtendAir eMIMO and ExpandAir Series radios allow operations in a near line-of-sight (nLOS) and non-line-of-sight (NLOS) conditions. Provide proper path clearance to achieve a high-performance, reliable connection. Perform professional path engineering and site planning *before* installing this equipment.

The primary focus of this document is the installation and management of the digital microwave radio, and assumes that path engineering and site planning has already been performed.

ExtendAir eMIMO and ExpandAir Series radios utilize radio frequencies in the 4.90 to 4.94 GHz range. In most countries, this frequency band is allocated exclusively for Public Safety usage and specific restrictions for applications may apply. Licensing or registration may be required. Consult your country regulations to determine any restrictions that may apply and any process that must be followed to implement links in this band.

ExtendAir eMIMO and ExpandAir Series radios utilize radio frequencies in the 5.250 to 5.875 GHz range. In most countries these frequency bands are considered as ‘license-exempt’ or ‘unlicensed.’ This means that virtually any user may use these frequencies freely, without paying for access, or any type of prenotification, post-notification or registration. As a result of this designation, users may also move or change these systems at any time, with significant flexibility to the location, orientation and configuration of the system. However, due also to this designation, there may be uncontrolled interference from other similar devices that occupy this spectrum. In these cases, it is up to engineering and maintenance personnel to design the system with existing and future interference sources in mind, recognizing that there is a chance that the interference conditions could be very dynamic, and outages may occur on the system as a result, and that, in some very rare cases, the system may cause interference into another system and may be required to be disengaged or modified/re-oriented to eliminate the interference.

If the spectrum in your country is designated as ‘license-exempt’ or similar, this does not infer that the installer may configure the system in any manner at any location. In most cases, there are regulations, or device-based conditions that limit the use of the device, such as maximum gain antenna, antenna types and maximum output power, as well as, in some cases, application limits, limited geography of use, and other unique regulations. The link design engineer and/or professional installer must determine these limitations and engineer/install the system within the confines of all local regulations. Also, it is required to examine any regulations that may apply to peripheral equipment, installation and cabling of the system that may be regulated for human safety, electrical code, air-traffic control, and other safety-related categories.

In certain countries, the spectrum for this product is NOT considered to be license-exempt. In these cases, there may be additional regulatory requirements concerning the location, frequency, power, orientation, configuration, and other aspects of the system, including, in some cases, a need for link

registration, coordination, and fees that may apply to the system usage. Please consult your local regulatory organization(s) to determine usage requirements.

In almost all cases, either for license-exempt or other designation, the product itself must be authorized for use in your country. Either Exalt or Exalt's agent must have applied for certification or authorization to allow the sale and deployment of the system within the country. It is also possible that only certain versions or configurations of the device are allowed within a particular country. Please contact Exalt or your authorized Exalt representative for information pertaining to your country.



**Note: It is the (professional) installer's responsibility to ensure that the radio system is implemented in a legal fashion. Exalt is not liable for any unsafe or illegal installations.**

## Basic Features

ExtendAir eMIMO and ExpandAir Series Digital Microwave radios are intended for all-outdoor mounting and powered by a separately-purchased power injector. In some cases, the radio can be mounted indoors or in an enclosure. Depending on the configuration purchased, the associated antenna is either integrated as part of the unit or connected separately.

For the external antenna models, the unit is typically mounted very close to the external antenna to minimize RF cabling and associated losses. Alternatively, the unit can be mounted at an easily accessible location with longer RF cabling to the antenna. Proper lightning or surge suppression devices and associated grounding are required for all connections.

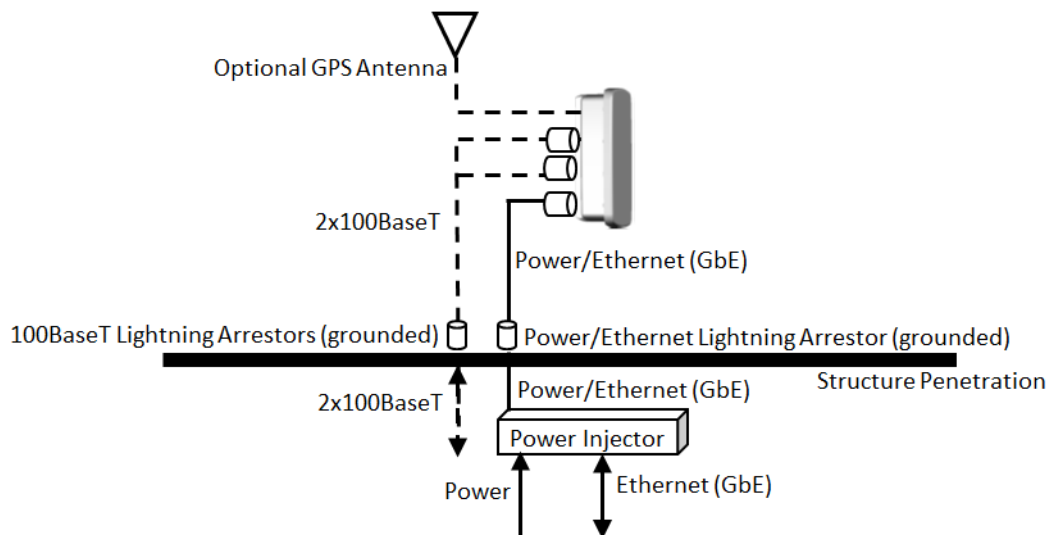

Figure 2 Cabling and mounting

For highest performance and reliability, it is advised to minimize the length of RF cable and associated transmission system losses between the antenna and the radio's antenna port.

The ExtendAir eMIMO and ExpandAir Series radios provide connections for a combination of the following data communication interfaces:

- One 10/100/1000BaseT (PoE) port and two 10/100BaseT ports

ExtendAir eMIMO and ExpandAir Series radios are powered by a combined Power/Ethernet cable, and associated power injector. The power injector provides 48VDC to the unit. The power injector and/or external power supply are sold separately.

The ExtendAir eMIMO and ExpandAir Series radios provide the following primary features and benefits:

- Longer range with smaller antennas. Exalt provides the highest system gain advantage with higher transmit power while sustaining higher throughput levels when competitors must lower modulation levels to maintain the link.
- Space-Time Block Code (STBC) support: The space-time block code used in ExtendAir eMIMO and ExpandAir Series radios is based on an Alamouti sequence and uses two antennas to transmit a single data stream. This allows transmit diversity and power distribution, which reduces linearity requirements and improves the link budget by 3dB.
- Encryption for extreme wireless security
- Easy-to-use management and configuration
- Flexible utilized channel bandwidth selection for interference avoidance and frequency coordination
- Flexible center frequency tuning for interference avoidance and frequency coordination
- Flexible capacity to meet current connection requirements and future growth needs
- Carrier-class reliability and performance
- High density collocation using ExaltSync™

### ***ExpandAir Hub and Subscriber Models***

The ExpandAir Series Digital Microwave Radio is a high performance sub-6 GHz wireless Point-to-Multipoint (PMP) platform utilizing 2x2 MIMO and Orthogonal Frequency Division Multiplexing (OFDM) technologies. With the ability to support up to sixteen Subscriber units per Hub unit, all-outdoor ExpandAir PMP solutions provide high throughput at extended ranges while OFDM allows for operation in Line of Sight (LOS), near Line of Sight (nLOS), and Non-Line of Sight (NLOS) environments.

## Pre-installation Tasks

This section describes the steps necessary to prepare a site for the installation of the Exalt Digital Microwave Radio.

### ***Link Engineering and Site Planning***

Design all terrestrial wireless links prior to purchase and installation. Generally, professional wireless engineering personnel are engaged to determine the viability and requirements for a well-engineered link to meet the users' needs for performance and reliability.

Exalt recommends using a link budget calculator and/or path planning tool to aid in the pre-planning and engineering required to determine following attributes:

- Antenna type gain at each end of the link
- Antenna mounting height/location for proper path clearance
- Antenna polarization orientation
- RF cabling type, length, connectors, route, and mounting
- Antenna system grounding
- Lightning arrestor type(s), location(s), and grounding
- Radio mounting location and mechanisms
- Radio grounding
- Radio transmitter output power setting
- Anticipated received signal level (RSL) at each end
- Anticipated fade margin and availability performance at each end
- Radio settings
- Anticipated throughput performance

With respect to radio path and site planning, these radios are generally identical to other microwave terrestrial wireless systems. Engineering of these systems requires specific knowledge about the radios, including:

- RF specifications (transmitter output power, receiver threshold, occupied channel bandwidth, and carrier-to-interference)
- Regulatory limitations on transmitter output power setting and antenna type/gain
- Noise/interference profile for the intended location

### ***Familiarization with the ExtendAir eMIMO and ExpandAir Series Radios***

The ExtendAir eMIMO and ExpandAir Series radios utilize time division duplex (TDD) radio transmission. This means that the transmitted signal in both directions uses the same center frequency and transmits in one direction for a period of time, and then in the opposite direction for another period of time. This total period of time is referred to as the *frame length* or *TDD frame length*, and is further discussed in [Time Division Duplex \(TDD\) Factors](#).

For ExtendAir eMIMO Point-to-Point (PTP) terminals, the two radio terminals are identical hardware, except for the Endpoint Identifier option in software. When the radios are in their default state, both radios are configured as Radio B. **One end of the link must be configured as Radio A before the two ends of the radio system can communicate.**

It can be considered that Radio A is the primary radio in the link. Radio A provides the Radio A clock and control to Radio B. For most applications, it is not important how the radio link is oriented, only that one end is configured for Radio A and the other for Radio B. For some applications (such as, multi-radio hub sites or repeaters), the orientation of the radio systems may be more critical. See [Link Orientation](#) for details.

For ExpandAir Point-to-Multipoint (PMP), the Hub is equivalent to Radio A. Subscribers, or Subs, are equivalent to Radio B. ExtendAir eMIMO PTP terminals can be configured as Radio B and be installed as Subs in an ExpandAir network. That is, two ends of an existing PTP link can be re-purposed as two Subs in a PMP network by adding an ExpandAir Hub.

Exalt recommends using the Exalt GUI for radio configuration. This interface requires a computer with an Ethernet port and web browser software, such as Microsoft Internet Explorer 5.0 or above. See [Configuration and Management](#) for details on how to connect to and use the browser-based GUI interface.

For ExtendAir eMIMO, two terminals are required to create a link. For ExpandAir, a single Hub radio and at least one Sub or ExtendAir eMIMO terminal configured as a Sub (Radio B) are required to create a link. Generally, ExpandAir networks have more than one Subscriber.

## Shipping Box Contents

Each radio box contains the following items:

- Radio terminal (ExtendAir eMIMO radios are configured as Radio B)
- Mounting kit (for pole mounting)
- Accessory kit
  - Grounding screw/washers
  - Weather-sealing tape (required for RF connectors on the rc models)
- Registration card
- Quick-start guide

The power solution for ExtendAir eMIMO and ExpandAir Series is sold separately. Any 802.3af compliant power-over-Ethernet solution may be used. 802.3at compatibility is also provided.

Inspect the outer packaging and the contents of the boxes upon receipt. If you suspect any shipping damage or issues with the contents, contact Exalt Customer Care.



**Note: Register your system as soon as possible.**

---

Outdoor-rated and shielded CAT5e or CAT6 cable, such as Belden 1300A, with RJ-45 connectors is recommended for the Ethernet connections. For Ethernet connections, a maximum length of 100 meters applies to the total length of the cabling between the radio terminal and the first network-aware connection (such as a switch or router).

## ***Initial Configuration and Back-to-Back Bench Test***

Every Exalt digital microwave radio goes through extensive quality testing and performance evaluation over the full operating temperature range prior to shipment. However, before installation, it is strongly advised to perform several tests and tasks that are much more difficult to perform once the radio link endpoints are distant from one another. A back-to-back bench test and pre-configuration will provide confidence that the radio link is operational and properly configured *prior* to installation, so that if troubleshooting is necessary, the radio hardware and configuration settings are eliminated from the troubleshooting process. Verify the following in the back-to-back testing:

- Confirm that the radio system is generally operational
  - Radios power-up with planned power and wiring solutions
  - Radio firmware version matches on each terminal (and is ideally the latest version)
  - Upgrade license key entry successful
  - RF link connects in both directions
  - Traffic passes across the link



---

**Note:** Some countries require Dynamic Frequency Selection (DFS) for certain frequency bands, which delays the transmitter turn-on time during the initial Channel Availability Check period of 1 minute. In accordance with these regulations, these radios boot up, and then wait 1 minute before linking. Changes to system parameters may cause additional Channel Availability Checks (CACs), causing an additional 1 minute wait-time to link after changes are made.

---

- Configure connected equipment and cabling
- Test Ethernet (CAT5e or CAT6) cabling
- Configure IP settings for configuration and management
- Configure passwords and security modes
- Become familiar with the configuration and management interfaces through the Exalt GUI interface
- Configure radio parameters
- Set transmitter output power to engineered or allowed level (see [RF Output Power Setting](#))
- Set operating center frequency
- Set link distance and occupied channel bandwidth
- Make detailed radio performance measurements
  - Measure transmitter output power
  - Measure receiver threshold performance
  - Confirm unfaded error-free performance

Some of these tasks may not be possible or practical within a bench test environment due to the nature of the remote connectivity of peripheral equipment. However, it is good practice to perform as much as possible in this environment to minimize field/installation time and troubleshooting efforts.

Detailed performance measurements are usually not required for pre-installation, but can be easily performed at this stage and may be helpful for later troubleshooting efforts or for internal records.

During troubleshooting, there may often be a point at which a back-to-back bench test should be performed to verify many or all of the above items, and in the case of a suspected faulty device, to help confirm the fault and determine which end of the system is at fault and in need of repair or replacement.



**Note:** See [Back-to-back Bench Testing](#) for detailed instructions.

---

## RF Output Power Setting

The maximum RF output power is bounded by one of the following criteria:

- Maximum RF output power setting capability of the radio device
- Maximum RF output power allowed/authorized by the local government regulations and for this specific device
- Maximum effective isotropic radiated power (EIRP) of the transmission system allowed/authorized by the local government regulations and for this specific device
- Desired RSL to not exceed the maximum RSL allowed by the device
- Desired RSL to minimize/eliminate interference into neighboring systems



**Note:** In many cases the radio must be pre-configured for no greater than the legal maximum output power before connecting to the antenna and transmission system. Instructions for adjusting the output power can also be found at the rear of this guide in the EIRP section for your region.

---

## Time Division Duplex (TDD) Factors

The ExtendAir eMIMO and ExpandAir Series radios are very dynamic, allowing the installer to optimize and control the performance of the radio system for the intended application. The following parameters must be carefully determined during the link engineering phase:

- Link distance
- Bandwidth
- Mode (modulation)
- TDMA or CSMA operation
- TDD Frame Size (if TDMA is selected)

The setting of the above parameters determines the following performance factors:

- Ethernet throughput
- System latency (delay)

The following generalizations can be made with regards to these factors:

- The shorter the link distance, the lower the latency, the higher the throughput
- The higher the bandwidth, the higher the capacity
- The higher the mode, the higher the capacity
- TDMA has predictable latency relative to the TDD Frame Size setting



## **Link Orientation**

Link *orientation* refers to the Radio A and Radio B (Hub and Sub for ExpandAir) placement in your network. For every link, one end of the radio link must be configured as Radio A/Hub, while the other end is configured as Radio B/Sub.

## **Radio Configuration**

Use the Exalt GUI to configure the radio terminals for Radio A/Hub and Radio B/Sub orientation. Since many other parameters also need to be set, and the Exalt GUI is needed for these configurations, this is the best way to completely configure the radio terminals.

Except for ExpandAir Hubs, radios arrive from manufacture in default configuration, orientated as Radio B/Sub and configured as shown in Table 1.

*Table 1 Factory default settings*

<b>Parameter</b>	<b>ExtendAir eMIMO and ExpandAir Series Radio Settings</b>
Radio (RF) State	Disabled
Endpoint Identifier	Radio B/Sub—except for ExpandAir Hubs
Band/Frequency <sup>a</sup>	<ul style="list-style-type: none"> <li>• -A models: 5.8GHz ISM/5.745GHz</li> <li>• -E and -W models: 5.4GHz UNII-DFS/5.500GHz</li> </ul>
Bandwidth	<ul style="list-style-type: none"> <li>• -A models: 5MHz</li> <li>• -E and -W models: 20MHz</li> </ul>
Transmit Power Limit	Disabled/25 dBm
Link Distance	12.4 mi/20 km
Link Security Key	000000000000
Administration Password	password
User Password	password
IP Address	10.0.0.1
IP Mask	255.255.255.0
IP Gateway	10.0.0.10
Access List Filtering	Disabled
Encryption	Open (no security applied)

a. If band is supported by the regulatory model; otherwise a different frequency may be the default setting.



**Note:** In many cases, the system design will not be identical to the factory default configuration, and in some cases, these differences prohibit the installation of the radio. If at all possible, obtain a computer and configure the radio terminals using the browser-based GUI. See [Configuration and Management](#) for details.

## Reset to Default Settings

If the IP address or password is lost or forgotten or a VLAN issue exists where access to the radio cannot be made, reset the radio to critical factory defaults.

To reset the radio to factory settings:

- 1 Remove the waterproof connector/gland/spacer assembly from the Sync In/Out port of the radio.  
Keep all pieces of this connector safe and secure (rubber gland, beveled washer, nut, spacer plug).  
If the Sync port was in use, remove the connected sync cable.
- 2 Place the reset tool (an RJ-45 wired with pins 3 and 5 connected to each other and no other pins connected) into the Sync In/Out port of the radio.
- 3 If already communicating to the radio GUI, navigate to the Shutdown page and click the **Shutdown** button  
Wait for 30 seconds before going on to the next step.
- 4 Power cycle the radio using one of the following methods:
  - a. Remove power at the PoE injector source
  - b. Disconnect from the PoE injector or disconnect at the ETH1/PoE port
- 5 Reconnect or reapply power.



**IMPORTANT!** Ensure that proper and constant power is applied for the remainder of this process.

Wait at least 20 seconds or until three short beeps occur. On any wait longer than 20 seconds, at approximately every 10 seconds thereafter, two short beeps sound.

- 6 Remove the reset tool from the Sync In/Out port.  
Wait approximately 45 to 90 seconds or until one long beep occurs.
- 7 Replace the waterproof connector/gland/spacer assembly in the Sync In/Out port or reconnect sync cable and tighten the connector assembly.  
Wait approximately 2 minutes from the time step 5 was completed.

The following changes are made to the radio:

- IP address = 10.0.0.1
- IP Mask = 255.255.255.0
- Admin and User passwords = password
- All factory settings are configured

The radio should be accessible using the above default access configurations and can be reprogrammed as necessary.

## System Installation and Initiation Process

The tasks required for radio installation and initiation are outlined in the following figure.

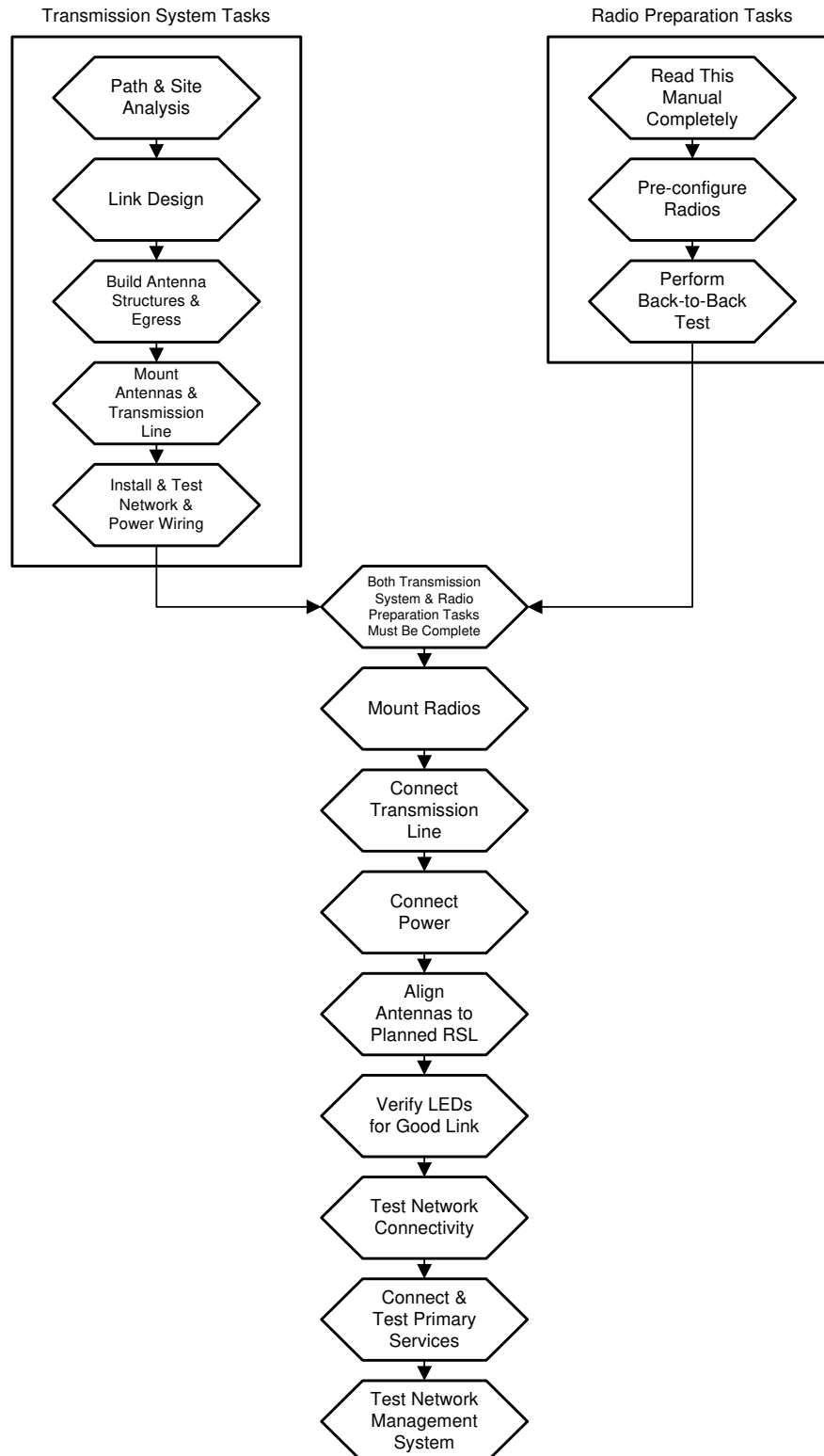

Figure 3 Radio installation tasks

## ***Record Keeping***

After installation, record the following items for ongoing maintenance and future troubleshooting. Keep a record for each end of the radio link and store a copy of these records at the radio location, at the opposite end radio location, and a central record storage location.

- GPS coordinates for antenna locations at each site
- Antenna heights above ground level (AGL), as mounted
- Antenna model numbers, serial numbers, and specifications
- Antenna polarization as mounted
- Length/type of primary transmission lines at each site
- Model number and serial number of RF lightning arrestors
- Length/type of secondary transmission line(s)
- Transmitter output power setting as installed at each site
- RSL as measured after antenna alignment at each site
- Designed RSL per original design at each site
- RSL reading with far-end power off (from each end)
- Spectrum analyzer plot with far end off at each site
- Voltage standing wave ratio (VSWR)/return loss at radio's antenna connector at each site
- Radio's network management IP address at each site
- Radio's network management gateway address at each site
- Radio's operating frequency, bandwidth setting, and mode of operation
- Optionally purchased extended warranty and/or emergency service contract details

In addition, certain information may be desired for central record-keeping only:

- Link security codes and log in passwords (stored in a secure place)
- Photographs of complete installation
- End-user sign-off/acceptance documentation (if any)
- Photo of product identification label (part number, serial number, MAC address information)
- Electronic copy of radio's configuration file
- Electronic copy of radio's installed software

## Installation

This section presents all tasks required to install the Exalt Digital Microwave Radio.

### ***Mechanical Configuration and Mounting***

The ExtendAir eMIMO and ExpandAir Series radios are environmentally sealed units intended for deployment outdoors. The device must be deployed within an ambient temperature range as specified, and with non-restrictive airflow around the chassis. The rc models can also be mounted in an enclosure or indoors. The same airflow and temperature conditions apply. All integrated antenna models can be mounted behind a window if window losses are considered in the link budget calculation.



**Note:** Unless rated for outdoor use by the manufacturer, the power injector and power supply must be placed indoors or in an enclosure.

Provide proper clearance for all cables and connectors attached to the device.

Note that for the rc models, the RF cable connector may require significant clearance for the bend radius of the coaxial cable assembly. All RF connectors, cables, and adapters must be rated for operation within the radio's frequency range. RF connector losses must be accounted for within the link engineering design and output power settings.

### **Mounting the System**

Use the mounting system supplied with each terminal for pole mounting (Figure 4). The pole mounting kit for r-model radios accommodates a pole 1.5–3"/3.8–7.7cm in diameter; rc-model radios accommodate a pole 2–6"/5.1–15.2cm in diameter. Install the mounting system first, and then affix the radio to the mount. The radio can also be affixed to the mount, and the entire assembly (including radio) mounted.

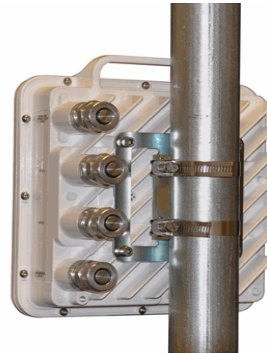

Figure 4 Pole-mount examples—r model at left; rc model at right

For rc models, the mounting solution is a very simple single bracket, using pole-mounting band clamps accommodating 2–6"/5.1–15.2cm pole diameters.

For integrated antenna models, it is critical to mount the entire device at the predetermined location for proper path clearance to the link end. Ensure that there is adequate space around the mounting system and the radio to allow for antenna alignment for both azimuth and elevation adjustments.



**Note:** Mount the rc models as close as possible to the antenna to minimize the length and associated losses of RF cabling.

## Radio Ports and Indicators

This section provides a brief overview of the connectors, controls, and indicators on the device. Details about each item are in other sections of this document. Figure 5 shows the connectors on the ExtendAir eMIMO and ExpandAir Series radios.

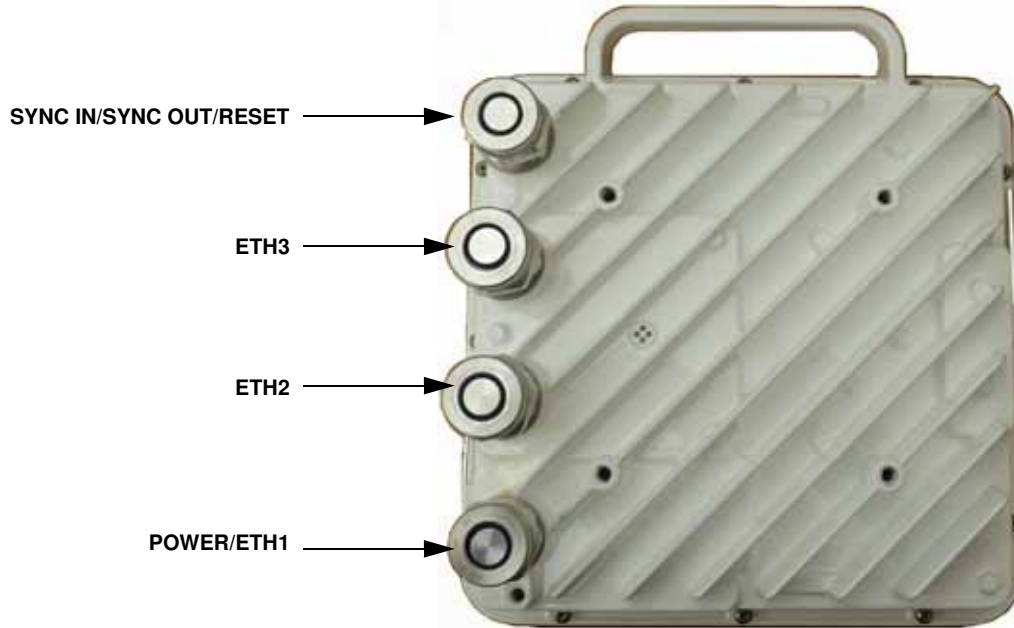

Figure 5 ExtendAir eMIMO and ExpandAir Series connectors

### Connector Overview

Table 2 provides details of the connectors. Detailed pin structures for each connector are in [Interface Connections](#).

Table 2 Connectors

Connector	Description
Sync In/Sync Out/Reset	<ul style="list-style-type: none"> <li>• Sync In for TDD Synchronization (from the second radio or through the ExaltSync Collocation Kit).</li> <li>• Sync Out for TDD Synchronization (to a second radio or through the ExaltSync Collocation Kit to multiple radios).</li> <li>• Connect the reset tool to this port to reset the radio to factory configuration settings (see <a href="#">Reset to Default Settings</a>).</li> </ul>
ETH2 and ETH3	10/100BaseT connections for data to traverse the link and/or management.
PoE/ETH1	Connected cables traverse to the power injector (Data+Power side), and provide the following functions: <ul style="list-style-type: none"> <li>• Primary ports for user Ethernet data (10BaseT, 100BaseT, or 1000BaseT) to traverse link and/or management</li> <li>• DC power from power injector</li> </ul>
⬇️ (Ground)	Threaded (M5) receptacle.



**Note:** Retain all weatherproofing spacers for unused connectors. Ensure that all connections are hand-tight for proper weatherproofing.

## LED Indicators

Table 3 provides details of the LED indicators on the ExtendAir eMIMO and ExpandAir Series radios. Note that there are two LEDs, labeled top and bottom, associated with each connector.

Table 3 LED indicators–TBD

Location	Type	Function
Sync/Reset Top	Green LED	Reserved for future use
Sync/Reset Bottom	Green LED	Unused
ETH2 or ETH3 Top	Green LED	Unused
ETH2 or ETH3 Bottom	Green LED	Unused
PoE/ETH1 Bottom	Green LED	Solid when proper power is applied.
PoE/ETH1 Top	Green LED	Solid when Ethernet link is established. Blinking when Ethernet traffic is present.

## Power

The radio requires a 802.3af or 802.3at compliant PoE power source within specifications.



**Note:** Read this section completely before applying power.

## Terminating the RF Connectors (rc models)

Before applying power, the RF connectors must be properly terminated into a 50-Ohm load. If this is not performed, the radio may be damaged by simply applying power. Also, there are human safety factors to consider regarding potentially harmful RF radiation.

The following lists a few simple ways to achieve proper termination:

- Connect 50-Ohm coaxial termination devices to the RF ports of the radio. The terminations must be rated to 1W (or more). Example(s) include:
  - Broadwave Technologies P/N 552-200-002, or similar
- Connect the complete transmission system. That is, the RF cabling including the antenna. The cabled antenna provides a proper termination for the RF output.
- Connect a fixed (or a series of fixed) 50-Ohm attenuator(s) to the RF connectors, either directly or at the end of RF transmission lines. The attenuators must be at least 30dB as specified at the operating frequency and rated for a minimum of 1W input power. Examples include:
  - Broadwave Technologies P/N 352-103-xxx
  - Bird 2-A-MFN-xx
  - JFW Industries 50FP-xxx-H6-N

When installing outdoors, cover any unused connector with the connector cap and apply the weather-seal tape. Both cap and tape are included in the accessory kit.

## **Ethernet Lightning/Surge Protection**

To provide for human safety and for the safety of connected network equipment, it is highly recommended to place a weatherproof lightning suppression device at the egress point where the CAT5e or CAT6 cable(s) enter the building, shelter, or cabinet.

To protect the radio equipment, install a weatherproof lightning suppression device near the radio for all connected CAT5e or CAT6 cables. Any Ethernet surge protection device used for the PoE port must be rated for 802.3af use, and for 1000BaseT operation. For the ETH2 and ETH3 connections, any 100BaseT rated surge protection device can be used.

Use a short CAT5e or CAT6 cable for the connection between the radio and the first arrestor. Use bulk outdoor-rated CAT5e or CAT6 cable for the longer run between arrestors, and indoor- or outdoor-rated cable with a standard CAT5e or CAT6 termination for the connection from the egress arrestor and power injector.



**Note:** Use only outdoor-rated UV-resistant CAT5e or CAT6 cable. The cable that connects directly to the radio must have an outer diameter between 0.25"/6.35 mm and 0.31"/7.87mm. Belden 1300A is recommended. Securely hand-tighten all connectors on the ODU to ensure a weatherproof seal.

---

## **Antenna/Transmission System**

This section provides guidance to mounting and connecting the RF transmission system, which consists of the antenna, RF cabling, and RF lightning arrestors. Consult the manufacturer's instructions for proper mounting, grounding, and wiring of these devices, and for definitive direction. These manufacturer's instructions supersede any information in this section. See [Table 7](#) and [Table 6](#) for lists of supported antennas.

### **Initial Antenna Mounting**

The antenna must be an exact model recommended by the path and site planning engineer(s). Mount the antenna at the proper height, mast/mounting location and polarization orientation as determined by the path and site planning engineer(s). The model type, location, and orientation of the antenna is critical with respect to achieving proper path clearance, as well as to mitigate external or self-interference from nearby or collocated systems operating in or near the same frequency band.



**Warning!** Mount the antenna in a restricted area and in a manner preventing long-term human exposure to the transmitted RF energy. To comply with FCC and Industry Canada regulations, the minimum safe distance from the antenna for continuous human exposure is 10'/3m.

---

The antenna structure must be secure and safe with respect to the mounting of the antenna, transmission system weight, radio housing, and the combined weight of any personnel that may climb or attach to the structure.

The combined weight of items and forces on the structure must be carefully considered in the design and construction of the structure. This must include the weight bearing on the structure in the highest wind conditions possible in the region, and with respect to all objects affixed to the structure.



If additional objects are affixed to the structure in the future, it may be important to evaluate both the mechanical impact of these planned additions (with respect to wind and weight loading), as well as the potential impact to RF interference and frequency coordination (if additional radio equipment is anticipated). This is especially important if future equipment is likely to operate within the same frequency band.

Once the antenna is mounted, cabled, and aligned, your goal is to never require modification. This prior planning is important in the path and site planning stages and in construction of the antenna structure.

Follow the antenna manufacturer's instructions for mechanical mounting of the antenna. Ensure that there is enough room around the antenna for alignment activities (moving the antenna in vertical and horizontal arcs), and for the RF transmission line to connect to the antenna connector unobstructed and within the specified bend radius requirements of the transmission line.

At this point, the antenna mounts should be fully secure to the structure, the feed of the antenna securely mounted to the antenna (if the feed is a separate assembly), and the azimuth and elevation adjustments not completely tightened in preparation of the antenna alignment activity. It is a good practice to connect the transmission line to the antenna connector as early in the process as possible, to reduce the opportunity for debris or moisture to enter either the antenna connector or the transmission line connector. Use a connector cover or other temporary measures to ensure that the connector is kept clear. Take extra care if the antenna is installed during inclement weather to ensure that no moisture gets inside the antenna connector at any time.

Now the antenna can be aimed in the general direction required for the link. Use a compass, a reference bearing, binoculars or any other similar device to point the antenna in the direction (generally) of the far end radio, and then slightly tighten the azimuth and elevation adjustments so that the antenna maintains its general position and is safe to be left without additional securing. Refer to the Exalt white paper, *Antenna Alignment*, for more information on antenna alignment techniques.

## ***Transmission Line from Antenna to Radio***

Most installations use a very short length of coaxial transmission line for the connection between the antenna and the radio device. Coaxial transmission line can either have a solid or braided shield. Solid-shield cables are more resistant to external signal coupling and interference, but are generally stiffer than braided cables. Consult the path or site engineer(s) to ensure that the proper materials are chosen for the installation and that all factors were considered.

Generally, the larger the diameter of the transmission line, the lower the loss. So for longer runs of transmission line, larger diameter cables are highly advised. However, at every frequency, there is a maximum diameter cable that supports the operating frequency. Verify the specifications. This is determined in the path and site planning process.

Table 4 lists representative samples of transmission line types recommended for the Exalt Digital Microwave Radio.

Table 4 Recommended transmission line

Manufacturer	Type	Description	Loss at 4.9GHz	Loss at 5.3GHz	Loss at 5.8GHz
Andrew	LDF4-50	1/2-inch solid shield	5.6dB/100'	5.7dB/100'	6.0dB/100'
Andrew	LDF4.5-50	5/8-inch solid shield	N/A	4.4dB/100'	4.7dB/100'
Times	LMR-600	1/2-inch braided shield	6.8dB/100'	6.9dB/100'	7.3dB/100'
Times	LMR-900	5/8-inch braided shield	N/A	4.6dB/100'	4.9dB/100'
RFS	LCF12-50J	1/2-inch solid shield	5.5dB/100'	5.6dB/100'	5.9dB/100'
RFS	LCF12-58J	5/8-inch solid shield	N/A	4.5dB/100'	4.8dB/100'

It is critical that the transmission line and antenna be capable of supporting the same type of connector, or easily adapted. It can be important to minimize the number of connectors and adapters, and it is ideal that they match directly without adaptation. In most cases, transmission line allows for N-type male connectors and antennas have N-type female connectors.

If possible, connect the primary transmission line directly to the antenna. It is desired to have the fewest possible pieces of transmission line in the system, to minimize losses and points of failure from connectors. The antenna can typically accommodate a direct connection if planned in advance. Use a 90° adapter for the connection to the antenna, if necessary, but confirm that all connectors and transmission lines are properly specified for the operating frequency with minimum loss, proper impedance (50 Ohm) and proper VSWR characteristics.

Transmission line connector termination is a critical element of the installation. Many ‘factory built’ RF transmission lines do not provide the proper characteristics for proper transmission, despite their published specifications, often due to the fully or semi-automated process of factory termination, which may not have considered the frequency of your system. When buying pre-terminated transmission line, it is strongly advised to obtain the documentation of test measurements on the connected transmission line showing that the loss characteristics and VSWR are within the specified limits specifically at your operating frequency. In addition to factory-built transmission line, self-terminated transmission line can suffer the same issues.



**Caution:** Always follow the manufacturer’s termination process EXACTLY, and only use the manufacturer’s authorized tools and connectors for a given transmission line type.

The manufacturers of transmission line typically offer instruction and certification for transmission line termination, and may also provide videos illustrating the process. There is no amount of extra care, education, precision, and effort that can be overstated for this process.

There is often a need for a small excess of transmission line near the antenna to accommodate both the need for extra slack as the antenna is loosened and moved for the alignment process, and to accommodate a drip loop for the transmission line and the initial transmission line securing hardware and grounding near the antenna. In addition, the transmission line is typically very stiff, and can provide undue pulling force on the antenna or radio connector. Take care to align the cable with the connector so that it does not provide any torque or strain on the connector.

Consult your transmission line manufacturer for the proper transportation, hoisting, securing, and grounding process. Always be very mindful of the entire length of transmission line to ensure that the transmission line is never twisted, kinked, or over-bent beyond the specified bend radius. Once a

transmission line is over-bent or kinked, it will likely never recover its specified characteristics, even after straightening, and will often be completely unusable.

The opposite end of this primary transmission line typically terminates at the radio connector. If using a long transmission line (in excess of 3'/1m), an RF lightning arrestor is recommended to protect the radio equipment.

As soon as practical, weatherproof the connected ends of the transmission line to the antenna and lightning arrestor and radio. This process should be delayed as long as possible to ensure that all systems are working properly before applying the weatherproofing. Once weatherproofing is applied, it may have to be removed for testing or installation modification. With this in mind, if the installation is occurring during inclement weather, take extra care at all times to ensure that no moisture enters any connector at any time. If moisture is suspected to have compromised the antenna or transmission line, it may render those devices useless without any means for remedy except for full replacement.

Cap and weatherproof the second antenna connector on the radio if using a single-polarity antenna.

## **Indoor Mounting**

On rare occasions the antenna can be mounted indoors behind a window. In these cases, there would not be a need for drip loops or an RF lightning arrestor. Use a very short transmission line connected directly between the antenna and the radio mounted nearby. The weatherproofing process can also be omitted.

## **RF Lightning Arrestor**

RF lightning arrestors provide a direct path to ground for lightning strikes that may couple to or directly hit the outdoor transmission system or antenna structure. The RF lightning arrestor prevents any associated voltage and current from entering the radio equipment, other equipment, or humans.

The following lightning arrestors are examples of proper devices for Exalt Digital Microwave Radios:

- Polyphaser AL-LSXM
- Citel PRC5800

Mount and ground the RF lightning arrestor in accordance to the manufacturer's recommendations. Place it as close as possible to the radio equipment. Minimize the distance to the radio to lessen the opportunity for lightning to couple to or strike the unprotected section of transmission line (if any). Consult a qualified electrician or installer in all cases of grounding and lightning arrestor implementation.

## **Antenna Alignment**

Antennas must be installed at both ends of the planned link to commence precision alignment. Refer to the Exalt white paper, *Antenna Alignment*. Antennas are typically aligned using the radio hardware for precise alignment. However, there are many very useful tools available to aid in this process, inclusive of devices specifically designed for the purpose of aligning antennas. Some examples are:

- XL Microwave Path Align-R
- Teletronics 17-402

Use of these devices may be extremely advantageous as compared to using the radio, because they employ many unique facilities to aid in this process. Using these tools also makes it possible to align the antennas before the radio equipment is delivered. However, many installers successfully use the radios as the means for antenna alignment.

Antennas must be installed at both ends of the planned link to commence precision alignment. Refer to the Exalt white paper, Antenna Alignment. Antennas are typically aligned using the internal alignment buzzer and the RSL value reported on the radio GUI.

- 1 Configure one side of the link as Radio A/Hub and the other side as Radio B/Sub, with the desired link frequency and Bandwidth setting at both ends, and the maximum transmit power allowed.
- 2 Enable Radio A/Hub with the Radio (RF) State parameter enabled on the [System Configuration Page](#).
- 3 Enable Radio B/Sub and enter the RF MAC Address of Radio A/Hub on the [Antenna Alignment Settings Page](#) of the GUI.

The RF MAC Address of each radio is located on the [Radio Information Page](#).

- 4 Coarse align antennas at both ends using compass bearings and/or a local landmark on the path.

For ExpandAir Hubs, align in accordance to the coverage area azimuth and elevation plan based on the original engineering design. Use a distant landmark for azimuth alignment. Use the elevation markers on the mounting bracket for the integrated radio, or the mounting system for the remote antenna. For remote antenna elevation alignment, use a level or inclinometer to properly set elevation.

- 5 Click Start Alignment on Radio B/Sub.

The alignment buzzer sounds. When the alignment buzzer is enabled, the radio enclosure emits a sound. The beeps get more rapid as better levels of RSL are achieved. Align the antennas until the fastest beeps are accomplished. The beep interval is once per 3 seconds if the far-end RF MAC Address is not found. Once the far-end is acquired, the beep interval starts at one beep per second and once the far-end is acquired, becomes a more rapid beep from  $-95$  to  $-53$  dBm. Above  $-53$  dBm, the beep is continuous.

- 6 Adjust the azimuth and elevation of the Radio B/Sub antenna until it aligned and has the best possible RSL.

RSL (RSSI) is reported on the Antenna Alignment page, to the right of the RF MAC Address entry.

- 7 Lightly tighten the antenna adjustment mechanics.

- 8 After Radio B/Sub is aligned as best as possible, for ExtendAir eMIMO, enable alignment on the Radio A side, enable Access List Filtering and enter the far-end RF MAC Address.

For ExpandAir models, check the Alignment RSL on the Hub for record-keeping and any minor adjustments needed for proper coverage. The Hub antenna may need to be realigned when Subs are added to the network. Subs will not need to be realigned unless significant changes are made to the elevation angle of the Hub. Subs further toward the edge of coverage (range or azimuth) may require realignment to maximize performance.

- 9 Repeat this procedure to align Radio A/Hub.

Alignment should be optimized at both ends, one side at a time, back and forth, until the target RSL is achieved, as indicated on the [Performance Page](#).

- 10 After the designed RSL is achieved, mechanically secure the antenna for azimuth and elevation alignment.

Carefully monitor the RSL level while tightening the mechanics, and ensure that the antenna remains in alignment.

- 11 Disable Antenna Alignment on both ends of the link once alignment is completed.

## Configuration and Management

The Exalt GUI is the primary user interface for configuring and troubleshooting the radio and radio system. A computer or hand-held device with a conventional HTML browser and Ethernet port is required. Microsoft Internet Explorer is the preferred browser. Firefox, Chrome and Safari are also supported.

### Prepare to Connect

Except for ExpandAir Hub radios, new radios are preconfigured as Radio B/Sub, and have the same IP address. The initial priority is to configure one radio to Radio A and assign different IP addresses, unique to each radio. There are two ways to change the IP address:

- 1 Reset the radio to the critical default factory settings.



**IMPORTANT!** If a reboot is prompted during the radio reset, ensure that proper and constant power is applied during the entire reboot process.

- 2 Connect to the GUI using the default IP address (10.0.0.1), and change the IP address through the GUI interface.



**Note:** To connect to the radio's Ethernet port and use the GUI interface, the accessing computer must match the radio's IP address subnet. It is therefore necessary to change the computer's IP address to match the subnet of the radio (such as, a computer IP address of 10.0.0.10 if trying to connect to a radio set to the factory default IP address of 10.0.0.1).

To configure a radio as Radio A, connect to the GUI and change the configuration, as discussed in this section.

### Make Connections

It is recommended that one radio at a time be configured, on a bench, before taking the radios to the field for installation:

- For models with RF connectors, terminate the RF connectors with a 50-Ohm termination or a fixed attenuator of at least 30dB (see [Power](#)).



**Note:** Do not initially connect the radios in a back-to-back configuration. If the radios are set to their factory default settings, both radios are configured as Radio B/Sub and cannot communicate. Both radios also have the same IP address, which causes IP address conflicts

Once connected to the radio using Ethernet, log in to the Exalt GUI.

### Log In

Use the following steps to log in to the Exalt GUI.

- 1 Open a browser window.

Microsoft Internet Explorer is the recommended browser. Firefox, Chrome, and Safari are also supported. If there are issues with your browser, please report it to Exalt Customer Care. You may be required to use a different browser to immediately overcome issues.

- 2 Type the IP address of the radio in the address bar.

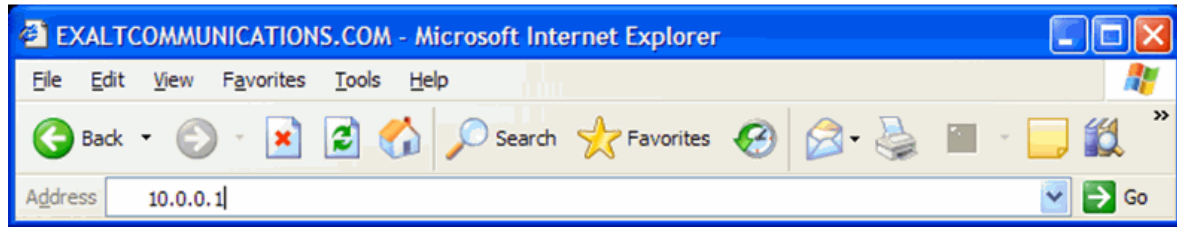

Figure 6 Initiating the browser connection

The following window displays after pressing the Enter key or clicking the Go button in the browser window.



Figure 7 Browser Login screen

## Login Privileges

There are two levels of login privileges:

- Administrator (admin) – assigned complete permissions to view, edit, and configure
- User (user) – assigned limited, view-only permissions with no edit or configuration rights

The default login names and passwords are as follows:

Table 5 Default login information

Privilege level	User name	Default password
Administrator	admin	password
User	user	password

Administrator login credentials are required for configuration purposes. Type the user name and passwords for Administrator level and click OK. The following screen displays.

The screenshot shows the 'Radio Information' page in the Exalt web interface. The page title is 'ExtendAirMimo'. The navigation menu on the left includes: Radio Information (selected), Administration, Configuration, Monitor, Terms of Use, Reboot, Manual, and Logout. The 'Radio Information' table contains the following data:

Model Name	ExtendAir rc5050
Model Number	E50N831-W
Serial Number	PE23132407
Hardware ID	ccea5d2568728862
Product Type	PTP Terminal
Interface Type	1x10/100/1000BaseT + 2x10/100BaseT
Boot Version	0.0.1
Firmware Version	1.0.3 (Fri Nov 1 19:03:55 CDT 2013 )
Supported RF bands	Dependent upon country selection, see System Configuration page
Antenna Type	External
ETH1 MAC Address	00:17:09:00:91:90
ETH2/3 MAC Address	00:17:09:00:91:91
RF MAC Address	02:17:09:00:91:90
Support E-mail	<a href="mailto:support@exaltcom.com">support@exaltcom.com</a>
Support Phone Number	Direct Dial: +1 408-688-0202 USA Toll-Free: +1 877-EXALT-01 (877-392-5801)

Below the table, there is a disclaimer: 'Use of this product is subject to the terms of use and conditions of applicable end user and third party software license agreements accepted by or on behalf of the end-user.' with links to [EULA](#) and [Third party license agreement](#).

Figure 8 Radio Information page

## Quick Start

To establish a link on the bench, apply the following basic configurations to the radio terminal. Use the steps in the *Quick Start Guide* included with the radio. A summary of the items that need to be configured are:

- Radio IP address for each end.
  - Each end must have a different IP address and cannot match the accessing computer's IP address or any address assigned if radios are part of a larger network.
  - It may be required to change the IP address of the accessing computer after changing the IP address of the radio so that the IP subnet matches.
  - The radio IP address is listed on the [Administration Settings Page](#).

One radio must be configured as Radio A (or Hub) and the other as Radio B (or Sub). Radio RF State must be enabled. All configuration settings on the [System Configuration Page](#) must match.

If all other parameters are still configured at their factory default settings, the radios can now be connected back-to-back to verify that the link is communicating and perform any other desired tests. See [Back-to-back Bench Testing](#) for test information.



**Note:** Click the **Save** button to save changes on any page. Also on all pages until saved, changed fields display with an orange background.

Most configuration parameter settings are intuitive. The following link parameters must match at both ends for the link to communicate:

- Encryption Key ([Administration Settings Page](#))
- Bandwidth ([System Configuration Page](#))
- Frequency (System Configuration Page)
- Link Security Key (Administration Settings Page)

In addition:

- Enter the Peer (RF) MAC Addresses for all Radio B/Sub radios on the Radio A/Hub [Access Control List Page](#) or disable Access List Filtering.
- Both radios must have the Radio (RF) State parameter enabled (System Configuration Page)
- The Link Distance setting must be equal to or greater than the actual link distance (System Configuration Page)



**Note:** Changing any of these parameters may cause a temporary loss of link.

## Navigating the GUI

The GUI provides the primary interface for all configuration and management. In the navigation pane, click the page link to access that page. There are three sections of the main GUI window:

- Link name and status
- Navigation pane
- Main window

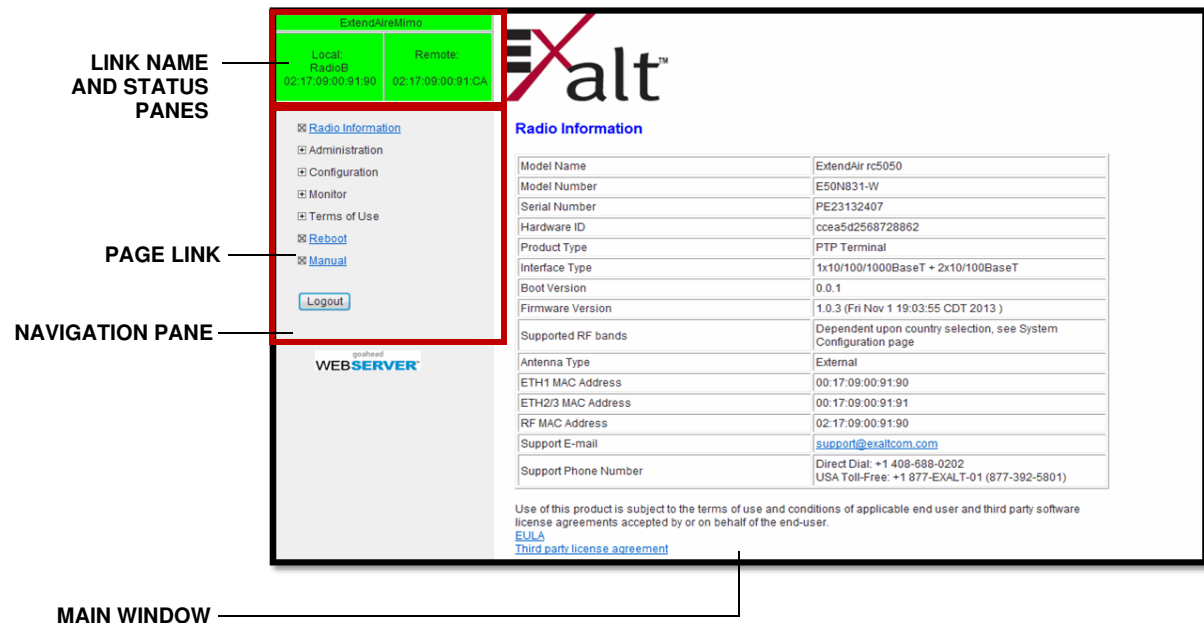

Figure 9 Exalt GUI window description

The link name and status panes in the upper-left indicate link state:

- Link Up: Both panes are green.



- Link Down: The top pane and the Local radio (at left) pane are red, and Remote (right) pane is gray.
- Pane is in the Yellow link state: RSL is lower than Alarm Threshold or PER Threshold exceeded.
- The upper pane displays the link name of the radio you are logged in to as configured on the [Administration Settings Page](#).
- The Local pane (left) displays the local radio name and its IP address as configured on the Administration Settings page.
- For ExtendAir eMIMO models and Subscribers of ExpandAir networks, the Remote pane (right) displays the MAC address of the far-end radio (when connected).
- For ExpandAir Hub radios, the Remote pane (right) displays how many Subscribers are connected and the color of this pane follows this convention:
  - Green: All subscribers selected for monitoring are connected. See [Access Control List Page](#) to enable monitoring.
  - Red: One or more monitored Subscribers are not connected.

## Radio Information Page

This page provides general information about the local radio terminal. This information is helpful for troubleshooting and for record keeping.

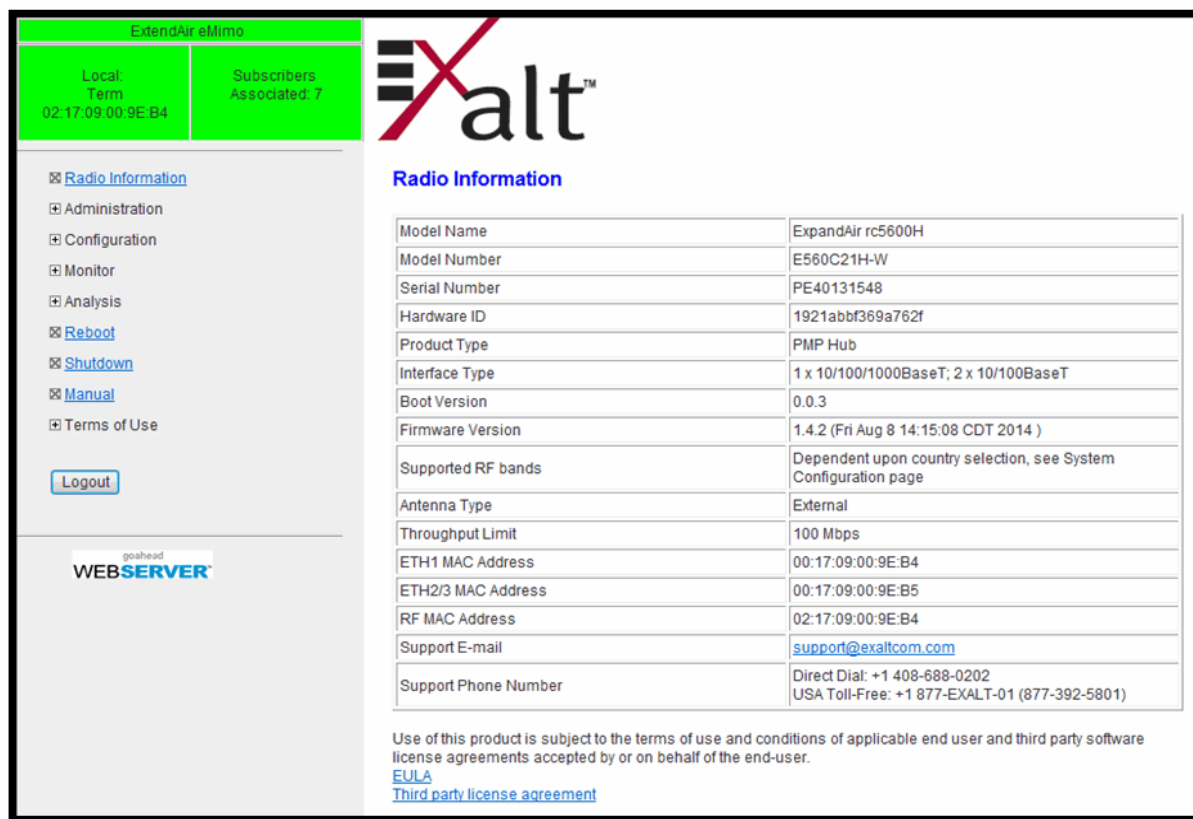

The screenshot shows the 'Radio Information' page for an Exalt device. The top header includes 'ExtendAir eMimo', 'Local Term: 02:17:09:00:9E:B4', and 'Subscribers Associated: 7'. The Exalt logo is prominently displayed. A sidebar on the left contains navigation links: Radio Information (selected), Administration, Configuration, Monitor, Analysis, Reboot, Shutdown, Manual, and Terms of Use, along with a Logout button. The main content area features a table with the following data:

Model Name	ExpandAir rc5600H
Model Number	E560C21H-W
Serial Number	PE40131548
Hardware ID	1921abbf369a762f
Product Type	PMP Hub
Interface Type	1 x 10/100/1000BaseT; 2 x 10/100BaseT
Boot Version	0.0.3
Firmware Version	1.4.2 (Fri Aug 8 14:15:08 CDT 2014 )
Supported RF bands	Dependent upon country selection, see System Configuration page
Antenna Type	External
Throughput Limit	100 Mbps
ETH1 MAC Address	00:17:09:00:9E:B4
ETH2/3 MAC Address	00:17:09:00:9E:B5
RF MAC Address	02:17:09:00:9E:B4
Support E-mail	<a href="mailto:support@exaltcom.com">support@exaltcom.com</a>
Support Phone Number	Direct Dial: +1 408-688-0202 USA Toll-Free: +1 877-EXALT-01 (877-392-5801)

Below the table, there is a disclaimer: 'Use of this product is subject to the terms of use and conditions of applicable end user and third party software license agreements accepted by or on behalf of the end-user.' with links to [EULA](#) and [Third party license agreement](#).

Figure 10 Radio Information page – ExtendAir model (-W rest-of-world model)

For Customer Support and return material authorization (RMA) activity, the Model Number, Part Number and Serial Number are required. Hardware ID number is required by Customer Support only if there are issues with license key entries.

The Licensed Features field indicates the features installed based on the License Key entered on the [Administration Settings Page](#).

The Firmware Version field lists the currently installed version in the Active bank of the File Transfer Page.



**Note:** It is strongly advised to update to the latest release of firmware, which is available for download from [www.exaltcom.com](http://www.exaltcom.com).

## Administration Settings Page

This page allows contains general parameters for the radio system.

	Current Value	New Value
Date (mm/dd/yyyy)	08/18/2014	
Time (hh:mm:ss 24h)	15:39:54	
Radio Name	Term	<input type="text" value="Term"/>
Link Name	ExtendAir eMimo	<input type="text" value="ExtendAir eMimo"/>
Security Key	DQV1	<input type="text" value="DQV1"/>
Admin Password	*****	Enter Admin Password Twice: <input type="text"/> <input type="text"/>
User Password	*****	Enter User Password Twice: <input type="text"/> <input type="text"/>
IP Address	192.168.1.81	<input type="text" value="192.168.1.81"/>
IP Mask	255.255.254.0	<input type="text" value="255.255.254.0"/>
Default Gateway	192.168.1.1	<input type="text" value="192.168.1.1"/>
License Key	35FGkdSi-DsPpezke-rnH3s2FS	<input type="text" value="35FGkdSi"/> - <input type="text" value="DsPpezke"/> - <input type="text" value="rnH3s2FS"/>
Encryption	Encryption ExtendAireMimoVLAN	Encryption <input type="text" value=""/> Encryption Key (8 to 64 digits): <input type="text" value="ExtendAireMimoVLAN"/>

Figure 11 Administration Settings page—ExtendAir model

The Current Value column lists entries actual settings. Desired changes are entered in the New Value column. After all desired changes are entered, click the **Update** button to accept and enable changes.

Most entries on this page are self-explanatory. The following lists unique or important parameters.



**IMPORTANT!** If a reboot is prompted during a configuration reset, ensure that proper and constant power is applied during the entire reboot process.

- The Date and Time fields are not adjustable. This display is based on NTP settings.
- Security Key must match at the endpoints of any link (Hub and all Subs for a point-to-multipoint network).
- Reset the admin and user passwords. These passwords should not match. If the admin password remains at the factory default setting, it provides an opportunity for random reassignment by a network-connected user.
  - The new password must be entered twice. If the passwords do not match and the Update button clicked, the password is not changed and remains set to the previous password.
- Enter the license key provided by Exalt to access extended features. Click Update to accept the changes and enable the new features. License keys are issued by radio serial number, so ensure that the license key used was issued for this particular radio. Changing the license key will cause the radio to reboot.

- Encryption: Not applicable when Open is selected. AES is the available authentication protocol, which provides additional data security for the wireless link. This feature requires that both radios have a valid AES encryption key, simply insert a matching string on both terminals and enable the Encryption option.

## NTP and Time Zone Page

This page allows you to configure the radio to receive date and time information from a Network Time Protocol (NTP) server.

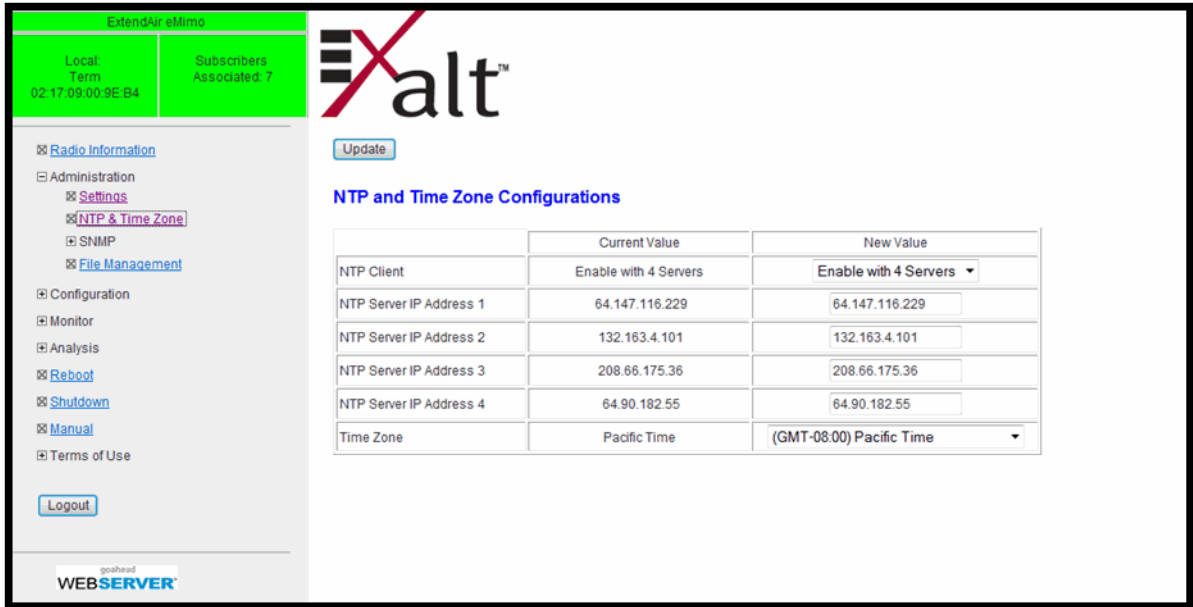

The screenshot shows the 'NTP and Time Zone Configurations' page in the Exalt web interface. The page has a green header with 'ExtendAir eMIMO' and 'Local Term 02:17:00:00:9E:B4'. A sidebar on the left contains navigation links: Administration (Settings, NTP & Time Zone, SNMP, File Management), Configuration, Monitor, Analysis, Reboot, Shutdown, Manual, and Terms of Use. A 'Logout' button is at the bottom of the sidebar. The main content area features an 'Update' button and a table for configuration.

	Current Value	New Value
NTP Client	Enable with 4 Servers	Enable with 4 Servers ▾
NTP Server IP Address 1	64.147.116.229	<input type="text" value="64.147.116.229"/>
NTP Server IP Address 2	132.163.4.101	<input type="text" value="132.163.4.101"/>
NTP Server IP Address 3	208.66.175.36	<input type="text" value="208.66.175.36"/>
NTP Server IP Address 4	64.90.182.55	<input type="text" value="64.90.182.55"/>
Time Zone	Pacific Time	(GMT-08:00) Pacific Time ▾

Figure 12 NTP and Time Zone page

- Enter up to four NTP server IP addresses. The radio must have a network path to the server(s) to obtain NTP information.
- Select the time zone of the system.



**Note:** These radios do not have an internal clock. It is recommended that you configure NTP so that the Event Log and other diagnostic tools display accurate time and date information.

## SNMP Configuration Page

This page allows configuration of Simple Network Management Protocol (SNMP) support. SNMP v1, SNMPv2c, and SNMPv3 are supported. Note that when using SNMPv3, authentication is performed using SHA1, and privacy/encryption is performed using DES56.

	Current Value	New Value
SNMPv1/SNMPv2c	Disable	Disable ▾
SNMPv3	Disable	Disable ▾
SNMPv1/SNMPv2c Read Only Community	public	public
SNMPv1/SNMPv2c Read Write Community	private	private
SNMPv3 Read Only User Name	user	user
SNMPv3 Read Write User Name	admin	admin
SNMPv3 Read Only Password	*****	Enter Password Twice: _____ _____
SNMPv3 Read Write Password	*****	Enter Password Twice: _____ _____
System Contact	support@exaltcom.com	support@exaltcom.com
System Name	Radio B	Radio B
System Location	Radio B	Radio B

Figure 13 SNMP Configuration page

- Enable the SNMP types used by your network administration (if any).



**Note:** SNMPv3 is the only secure SNMP protocol. SNMPv3 is recommended over SNMPv1 or SNMPv2c. When using SNMPv3, authentication is performed using SHA1; privacy and encryption is performed using DES56.

- Enter all required passwords or community strings for the SNMP service(s).
- Add System Contact information and the radio information for retrieval by the SNMP management system.

## SNMP Trap Configuration Page

Support is available for SNMP traps when SNMP is enabled.

The screenshot displays the Exalt web interface for SNMP Trap Configuration. The top navigation bar shows 'ExtendAir eMimo' with 'Local Term: 02 17 09 00 9E B4' and 'Subscribers Associated: 7'. The Exalt logo is prominently displayed. The left sidebar contains a menu with categories like Radio Information, Administration (Settings, NTP & Time Zone, SNMP), Configuration, Monitor, Analysis, Reboot, Shutdown, Manual, and Terms of Use. A 'Logout' button is at the bottom of the sidebar. The main content area features an 'Update' button and three configuration sections:

- SNMP Trap Configuration:** A table with columns 'Current Value' and 'New Value'. All three rows (SNMPv1 Traps, SNMPv2c Traps, and SNMPv3 Traps) show 'Disable' in both columns.
- Traps Destination Configuration:** A table with columns for 'Trap Destination IP Address #1-4'. The first row has '192.168.11.89' in the first column and a text input field with '192.168.11.89' in the second. The other three rows have empty text input fields.
- Traps:** A table listing various trap types and their status. All are currently set to 'Disable'.

	Current Value	New Value
SNMPv1 Traps	Disable	Disable ▾
SNMPv2c Traps	Disable	Disable ▾
SNMPv3 Traps	Disable	Disable ▾

Trap Destination IP Address #		
Trap Destination IP Address #1	192.168.11.89	<input type="text" value="192.168.11.89"/>
Trap Destination IP Address #2		<input type="text"/>
Trap Destination IP Address #3		<input type="text"/>
Trap Destination IP Address #4		<input type="text"/>

Trap Type	Current Value	New Value
Authentication Trap	Disable	Disable ▾
System Restart Trap (Cold Start Trap)	Disable	Disable ▾
Local Link Status Trap	Disable	Disable ▾
Local RSL Status Trap	Disable	Disable ▾
Local Packet Error Rate Trap	Disable	Disable ▾
Subscriber Status Trap	Disable	Disable ▾
External SYNC Loss Trap	Disable	Disable ▾
DFS Detection and Channel Change Trap	Disable	Disable ▾
Spectrum Analyzer Trap	Disable	Disable ▾
Spectrum Analyzer RF Mute Trap	Disable	Disable ▾

Figure 14 SNMP Trap Configuration page

- Configure up to four SNMP trap destination addresses.

Use any or all of available traps so that the network manager is automatically warned of alarms and perform in-depth polling to determine status or use the GUI to examine radios in the alarm state. Enable Spectrum Analyzer traps to notify you when a spectrum analysis scan starts and ends, and when RF Mute is enabled for the Spectrum Analyzer.

## File Management Page

This page displays the firmware version, and allows the administrator to upload and download files to and from the radio.



Figure 15 File Management page—ExtendAir model

The previous, current, and factory versions of firmware display, and controls to change the current version to match either the previous or factory version are provided. Both ends of any link must match the current version for proper operation. Always modify the far-end first, and then the near-end. For Point-to-Multipoint, modify all subscribers before to upgrading the hub.



**Note:** Link outages may occur until firmware versions match.

Several files are available for download from the radio, as shown. Follow the instructions on the File Transfer Link page (Figure 16) to download the selected file type.

License key and radio firmware files can be uploaded. When uploading radio firmware files, the file is automatically loaded as the new Current version, and the previous version is moved to the Previous Version memory slot. Press **Revert to previous** to change the current version to the previous version. Press **Revert to factory** to change from the current version to the original factory version. Follow these steps to upload a file:

- 1 Select the radio button for the type of file to upload (radio firmware or license key).
- 2 Browse to the file location, and select the file.
- 3 Click the **Upload to Radio** button.

For file downloads, a second page/link appears.



**Note:** Do not change the name of any download file. Never change radio firmware file names.



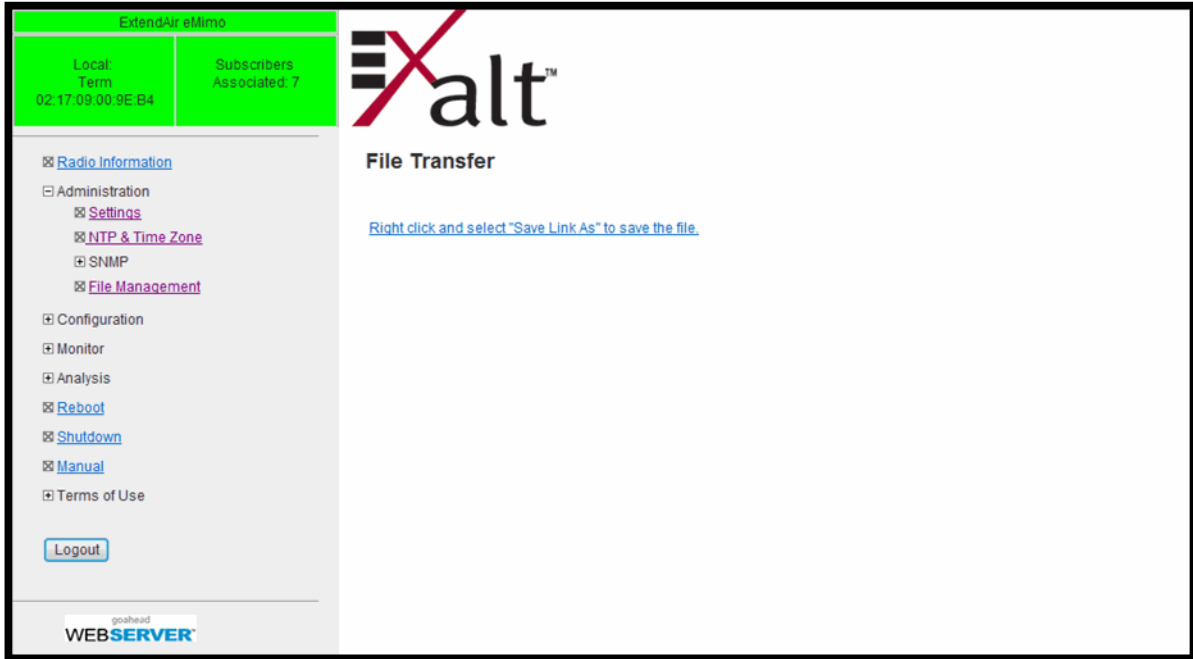

Figure 16 File Transfer link page

## System Configuration Page

This page contains several critical system parameters.

	Current Value	New Value
Radio (RF) State	Enable	Enable
Endpoint Identifier	Term-RadioA	Term-RadioA
Band	5.4	5.4
Bandwidth	40 MHz	40 MHz
RF Frequency (GHz)	5.510	5.510
QoS	Disable	Disable
Antenna Type	External	
Effective Antenna Gain	9 dBi	9 dBi
Transmit Power Limit	Disable 25 dBm	Disable Power Limit 25 dBm
Link Distance	20 km / 12.4 miles	20 km / 12.4 miles
Access Protocol	TDMA	TDMA
Radio Collocation	No Sync Source	No Sync Source
TDD Frame Size (ms)	5 ms	5
TX/RX Throughput Ratio (%)	50:50	50:50
RSL Threshold	Alarm Threshold: -95 dBm Normal Threshold: -94 dBm	Alarm Threshold: -95 dBm Normal Threshold: -94 dBm
PER High Threshold	1E-1	1E-1

Figure 17 System Configuration page—ExtendAir eMIMO model

Most entries on this page are self-explanatory. The following lists unique or important parameters.

- Disable the Radio (RF) State parameter to stop transmitting to the far-end radio.
- Set the Endpoint Identifier parameter to either Radio A/Hub or Radio B/Sub. One end of the link must be Radio A/Hub and the other end must be Radio B/Sub. For ExpandAir, there can be up to 16 subscribers per Hub.

	Current Value	New Value
Radio (RF) State	Enable	Enable
Endpoint Identifier	Hub	Hub
Country Code	PS, UNITED STATES (PUBLIC SAFETY)	PS, UNITED STATES (PUBLIC SAFETY)
Band	4.9	5.4
Bandwidth	20 MHz	20 MHz

Compatibility details:



- ExpandAir Hubs can be configured as any type of terminal (Hub, Sub, or PTP terminal endpoint A or B).
- ExtendAir eMIMO terminals can be configured as Subs (by configuring Radio B) in an ExpandAir network.
- ExpandAir Subs can only be configured as Subs and cannot be used in PTP configuration ExtendAir eMIMO networks.

- (-W models only) Set the Country Code parameter to the country where the radio is deployed.

The screenshot shows a 'System Configuration' window with a table of parameters. The 'Country Code' parameter is selected, and a dropdown menu is open, displaying a list of country codes. The current value is 'AT, AUSTRIA' and the new value is also 'AT, AUSTRIA'. The dropdown menu lists the following country codes: AT, AUSTRIA; AZ, AZERBAIJAN; BS, BAHAMAS; BY, BELARUS; BE, BELGIUM; BZ, BELIZE; BM, BERMUDA; BA, BOSNIA AND HERZEGOVINA; BR, BRAZIL; BG, BULGARIA; KH, CAMBODIA; CA, CANADA; CA, CANADA2; CN, CHINA; CO, COLOMBIA; HR, CROATIA; CY, CYPRUS; CZ, CZECH REPUBLIC; DK, DENMARK; DO, DOMINICAN REPUBLIC; EG, EGYPT; EE, ESTONIA; FI, FINLAND; FR, FRANCE; GE, GEORGIA; DE, GERMANY; GR, GREECE; GL, GREENLAND; GD, GRENADA; HT, HAITI.

	Current Value	New Value
Radio (RF) State	Enable	Enable ▾
Endpoint Identifier	Radio B	Radio B ▾
Country Code	AT, AUSTRIA	AT, AUSTRIA ▾
Band	5.8	AT, AUSTRIA
Bandwidth	20 MHz	AZ, AZERBAIJAN
RF Frequency (GHz)	5.805	BS, BAHAMAS
QoS	Disable	BY, BELARUS
Antenna Type	External	BE, BELGIUM
Effective Antenna Gain	23 dBi	BZ, BELIZE
Transmit Power Limit	Disable 25 dBm	BM, BERMUDA
Link Distance	1.6 km / 1 mile	BA, BOSNIA AND HERZEGOVINA

- Select the desired frequency Band. The available bands are related to the selected country code (-W models only).



**Note:** 4.9GHz band operation is restricted in most countries to Government or Public Safety use, and is only available on -A models. Consult with local regulatory restrictions prior to operating in this band.

- Select the RF Frequency to match at both ends. If desired, instead of selecting a specific frequency, you can select AUTO to scan the selected band to identify the frequency with the least noise or interference. Some bands also require Dynamic Frequency Selection (DFS). DFS is automatically enabled for these bands and is selectable for all other bands. Radio B/Sub radios always search for Radio A/Hub radios.



**Note:** With AUTO selected, the link scans and a new frequency may be selected every time the link is re-established due to certain configuration changes or reboot.

- QoS select to enable Quality of Service on the radio. QoS is a network prioritizing feature that ensures high-priority traffic transfers during peak capacity demands. The priority hierarchy is adhered to when capacity demand is higher than the link can provide; highest priority traffic is allowed to transfer, while lowest priority traffic may be dropped. This parameter must match at both ends of the link. QoS complies with 802.1p and IPv4 ToS/Diffserv.
- Select the Bandwidth parameter as determined in the design/engineering stage. This parameter must match at both ends of the link.



**Note:** *Changing the System Configuration parameters will temporarily interrupt traffic.* Adjust the far-end radio first, and then the near-end radio. Changing Bandwidth changes the radio's threshold. A narrower bandwidth has better threshold performance and improved interference immunity, therefore if changing to a wider bandwidth, there is an opportunity that the link may be lost and unrecoverable through GUI control. Check the available fade margin to determine if the impact to threshold and increased bandwidth is acceptable to maintain the link and the desired performance. If the link is lost due to increasing the Bandwidth parameter, travel to the radio location(s) may be required to reset the value.

If DFS is enabled or enforced by the country configuration, the interruption will be a minimum of one minute to accommodate Channel Availability Check (CAC).

- Set the Effective Antenna Gain parameter to match the installed transmission system gain (that is, the gain of the antenna minus all losses between the radio and the antenna).
- Set the Transmit Power Limit parameter to the designed level (dBm). The professional installer sets this value or dictates the value of this setting to the system administrator following the system design and local regulations. In many cases, this value must be set to a proper value to comply with legal restrictions. Improper values can result in liability to the user and/or installer.
  - Do not adjust the Radio Transmit Power Limit parameter to a value higher than is legally allowed.



**Note:** **The link may be lost and unrecoverable** through GUI control. If the link is lost due to reduction of Radio Transmit Power, travel to the radio location(s) may be required to reset the value.

- Set the Link Distance parameter to optimize radio performance for the maximum link distance. Shorter distances provide better reaction times for error packet retransmissions, which allows better throughput (given the same RSL level).



**Note:** Do not select a range less than the actual link distance. This will cause failure and collisions on transmission between the radios. The distance setting is not required for Radio B/Sub implementations.



**Note:** Link Distance options are tied to other settings (such as TDD Frame Size). Only settings based on the combination of other settings are available.

- For Radio A/Hub, set the Access Protocol parameter to CSMA or TDMA. Select TDMA to provide predictable, but not best-effort, throughput and latency.

When TDMA is selected, the Radio Collocation, TDD Frame Size, and Tx/Rx Throughput Ratio options are available and must be configured.

- For Radio A/Hub, use Radio Collocation when there is more than one ExpandAir Hub or ExtendAir eMIMO Radio A terminal at the same location operating in the same frequency band, or if an ExpandAir Hub is collocated with an ExtendAir radio in the same frequency band. Collocation Sync ensures that local radios transmit and receive simultaneously to eliminate local interference from local transmitters into local receivers. The available options define the clocking source for collocated Hubs in TDMA mode. All radios in a collocation set have the same TDD Frame Size and same Throughput Ratio.

The following options are available when the Radio Collocation option is selected:

- No Sync Source allows the Hub or PTP link to run on its own clock. Select this option where TDMA is desired for Subscriber capacity allocation and/or latency control and there is only one Hub radio or PTP link and no collocation, or when collocated radios are operating with significant frequency separation and/or physical separation where separation eliminates the possibility of near-field interference of local transmit signals into local receive cycles.
- Use the Sync Recipient option to allow either a Hub or the Radio A end of a PTP link to synchronize to another Hub or the Radio A end of a PTP link, other Exalt radio sync output, or when it is the last radio in a collocation set.
- Use the Sync Recipient+Relay option when the radio is part of a collocation set and connected to an Exalt 4-port collocation kit, but is NOT the first or last radio in that collocation set. The relay function carries the clock source through to the next radio in the collocation set.
- Use the Sync Source option when the radio is the source of synchronization for another Exalt radio sync input, including when it is the first radio in a collocation set.
- For Radio A/Hub, set the TDD Frame Size when TDMA is selected to control Hub-to-Sub connection latency or PTP radio latency, which impacts capacity. The options are 2, 4, or 5 milliseconds. The higher the TDD Frame Size, the higher the connection capacity, but the longer the latency. All synchronized collocated radios must have the same TDD Frame Size setting.
- For Radio A/Hub, set the Tx/Rx Throughput Ratio when TDMA is selected to control the ratio of throughput from outbound (transmit) traffic (Hub-to-Sub or Radio A to Radio B) versus inbound (receive) traffic (Sub-to-Hub).

A common setting is a 50/50 ratio for equivalent Outbound-to-Inbound traffic, but can be set to 65/35 or 80/20 in either direction.

- 80/20 settings are only available with a TDD Frame Size of 5ms.
- 65/35 settings are supported with all TDD Frame Size settings.
- There are bandwidth setting restrictions for certain combinations where narrow a bandwidth setting (such as 5MHz) is not allowed.
- RSL Threshold applies to all radio implementations, except Hubs. This field sets the level at which an RSL Threshold Alarm (Trap) occurs (if the incoming signal level falls below this value) and the level to clear the alarm (Trap) with the Normal setting. For Hubs, the RSL Threshold alarm points are managed on the [Access Control List Page](#).
- PER (Packet Error Rate) High Threshold allows you to set specific network operational requirements. The selected value applies to the PER alarm (Trap).

## Ethernet Page

There are two sections to this page. The first is for Ethernet Administration State. In this section, the administrator can selectively enable or disable the ETH2 and/or ETH3 ports of the radio. ETH1/PoE is always enabled and should be used for primary radio traffic and management if only one port is enabled.

The screenshot shows the Exalt web interface. At the top, there is a green header with 'ExtendAir eMIMO' and 'Local Term 02:17:09:00:9E:B4'. Below this, there is a navigation menu on the left with options like 'Radio Information', 'Administration', 'Configuration', 'System', 'Interface', 'Ethernet', 'Access Control List', 'Advanced', 'Monitor', 'Analysis', 'Reboot', 'Shutdown', 'Manual', and 'Terms of Use'. The main content area is titled 'Ethernet Admin State' and contains two tables. The first table, 'Ethernet Admin State', has columns for 'Port', 'Current Value', and 'New Value'. The second table, 'Ethernet Port Configuration', has columns for 'Port', 'Current Value', and 'New Value'. The 'New Value' column in the second table has dropdown menus for 'Out-of-Band', 'Mgmt', and 'Traffic'.

Port	Current Value	New Value
ETH2	Enable	Enable
ETH3	Enable	Enable

	Current Value	New Value
Mgmt	Inband	Out-of-Band
ETH1	Traffic+Mgmt	Mgmt
ETH2/ETH3	Traffic+Mgmt	Traffic

Figure 18 Ethernet page

The lower portion of this page allows you to configure port allocations for in-band or out-of-band management. The default setting is in-band management (management and traffic is carried over the air and available from all enabled Ethernet connectors on either end of the link) or out-of-band (management traffic is not carried over the air and only available from the connectors designated for management, and traffic is independently carried on port(s) designated for traffic). ETH1 is the PoE port and is a Gigabit Ethernet port. ETH2 and ETH3 are 100BaseT ports and do not support PoE.



**Note:** For out-of-band management configurations, due to the difference between Gigabit Ethernet and 100BaseT support on the interfaces, most users will configure the ETH1/PoE port as the traffic port and ETH2/ETH3 port(s) as management ports.

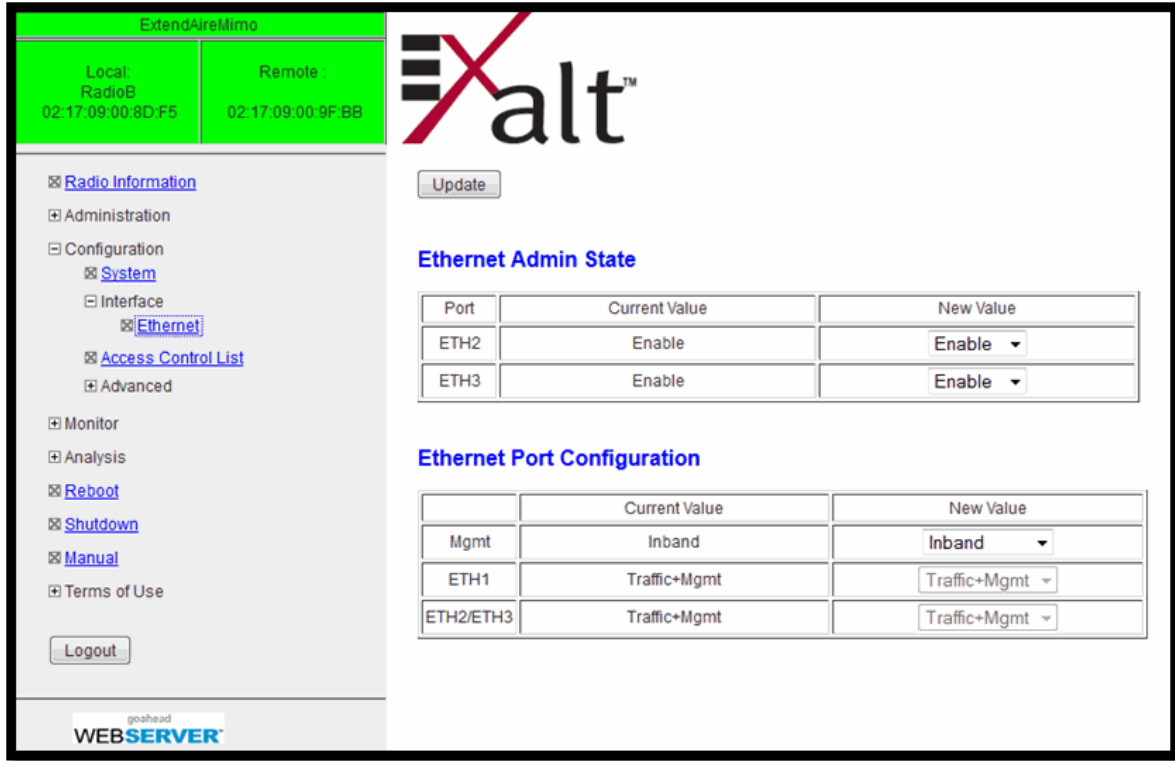

Figure 19 ExpandAir In-band Management Configuration

The link can be configured in *mixed mode*, where one side of the link has in-band management and the other side uses out-of-band management. Figure 20 shows supported band management configurations.

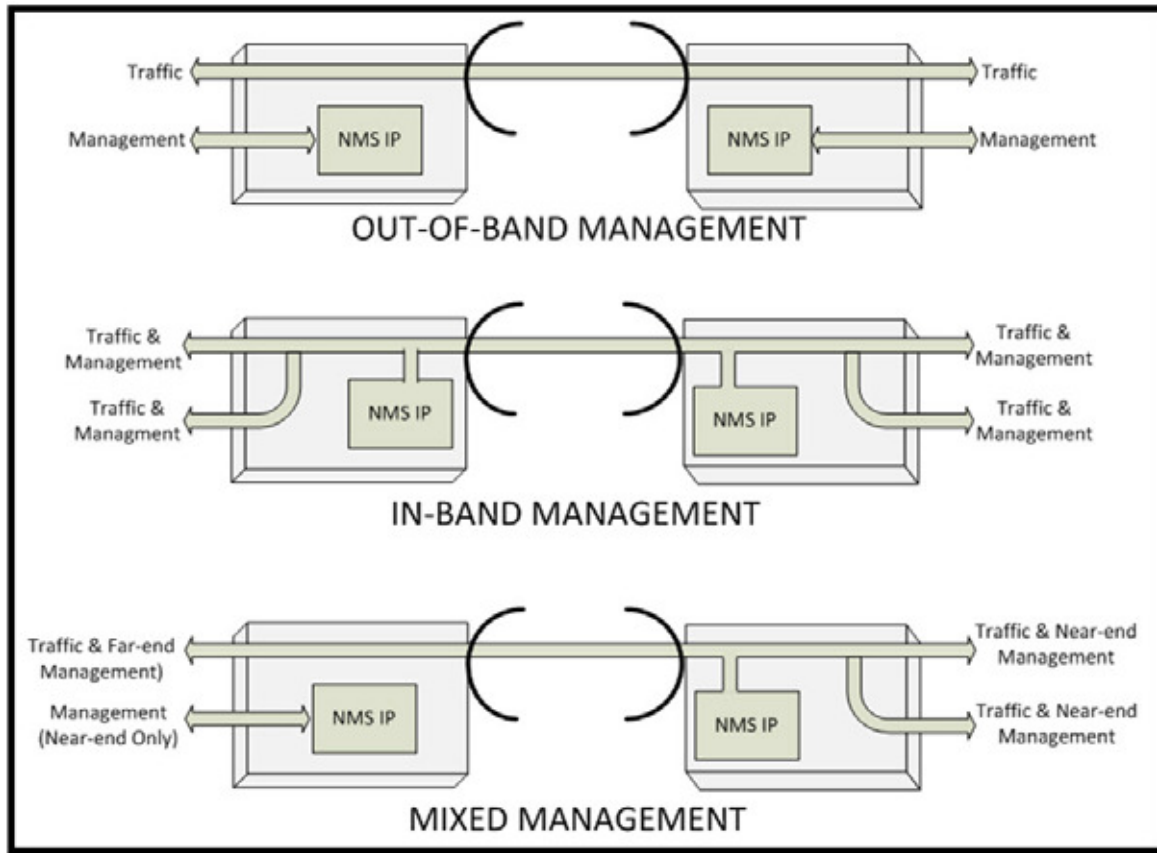

Figure 20 Band management example

The management function of each port can be assigned as:

- In-Band Management (Figure 19) – All ports can pass traffic over the link and also have access to management of the radio. Management traffic is carried over the link. In Figure 19, all interfaces are set to their default values of Traffic+Mgmt.



The screenshot shows the Exalt web interface for an ExpandAir radio. The top header includes the Exalt logo and the text 'ExtendAir eMIMO'. Below the logo, there are two green boxes: 'Local: RadioB 02:17:09:00:8D:F5' and 'Remote: 02:17:09:00:9F:BB'. A navigation menu on the left lists various sections like Radio Information, Administration, Configuration, System, Interface, Ethernet, Access Control List, Advanced, Monitor, Analysis, Reboot, Shutdown, Manual, and Terms of Use. The main content area is titled 'Ethernet Admin State' and contains an 'Update' button and a table with columns 'Port', 'Current Value', and 'New Value'. Below this is the 'Ethernet Port Configuration' section with another table with columns 'Port', 'Current Value', and 'New Value'. The 'New Value' columns in both tables have dropdown menus.

Port	Current Value	New Value
ETH2	Enable	Enable
ETH3	Enable	Enable

Port	Current Value	New Value
Mgmt	Inband	Out-of-Band
ETH1	Traffic+Mgmt	Mgmt
ETH2/ETH3	Traffic+Mgmt	Traffic

Figure 21 ExpandAir Out-of-band Management Configuration

- Out-of-band Management – Each port can be set to either Traffic or Management. All ports set to traffic are connected together and pass traffic over the link, and all ports set to management are connected together, but separated from the traffic and do not go over the link. Management is not available over the wireless link in this configuration (unless externally switched or routed to a Traffic port).



**Note:** The radio requires that a minimum of one interface have access to management (by setting to Mgmt or Traffic+Mgmt).

## Access Control List Page

This page allows you to associate either or both ends of the radio link based on the MAC address of the far-end partner. For ExpandAir Hubs, this allows user-assigned names applied to each subscriber, and setting of the RSL Alarm and Normal Threshold for each subscriber, similar to this functionality on the [System Configuration Page](#) for Sub or Term A/B configurations. For Hub configurations, you can assign each subscriber for Monitoring or No Monitoring. This determines the overall far-end alarm status of the Hub.

The screenshot shows the Xalt web interface for the 'Access Control List' page. The top header displays 'ExtendAir eMIMO' and 'Local Term 02:17:09:00:9E:B4'. The left sidebar contains a navigation menu with options like 'Radio Information', 'Administration', 'Configuration', 'System', 'Interface', 'Ethernet', 'Access Control List', 'Advanced', 'Monitor', 'Analysis', 'Reboot', 'Shutdown', 'Manual', and 'Terms of Use'. The main content area features the Xalt logo, an 'Update' button, and the title 'Access Control List'. Below this is a section for 'Access List Filtering' with a 'Disable' dropdown. The central part of the page is a table with the following data:

Subscriber Name	Remote RF MAC Address	RSL Alarm Threshold	RSL Normal Threshold	Monitor
75-A-Sub	02:17:09:00:18:41	-95 dBm	-94 dBm	<input checked="" type="checkbox"/>
78-W-Sub	02:17:09:00:9F:E9	-95 dBm	-94 dBm	<input checked="" type="checkbox"/>
77-A-Term	02:17:09:00:91:E3	-95 dBm	-94 dBm	<input checked="" type="checkbox"/>
79-A-Sub	02:17:09:00:9E:C2	-95 dBm	-94 dBm	<input checked="" type="checkbox"/>
83-A-Sub	02:17:09:00:9E:4C	-95 dBm	-94 dBm	<input checked="" type="checkbox"/>
74-W-Term	02:17:09:00:91:CA	-95 dBm	-94 dBm	<input checked="" type="checkbox"/>
72-A-Term	02:17:09:00:8D:D3	-95 dBm	-94 dBm	<input checked="" type="checkbox"/>
		-95 dBm	-94 dBm	<input type="checkbox"/>
		-95 dBm	-94 dBm	<input type="checkbox"/>
		-95 dBm	-94 dBm	<input type="checkbox"/>
		-95 dBm	-94 dBm	<input type="checkbox"/>
		-95 dBm	-94 dBm	<input type="checkbox"/>
		-95 dBm	-94 dBm	<input type="checkbox"/>
		-95 dBm	-94 dBm	<input type="checkbox"/>
		-95 dBm	-94 dBm	<input type="checkbox"/>
		-95 dBm	-94 dBm	<input type="checkbox"/>
		-95 dBm	-94 dBm	<input type="checkbox"/>
		-95 dBm	-94 dBm	<input type="checkbox"/>

Figure 22 Access Control List page—ExtendAir Hub model

If Access List Filtering is enabled, the Hub (Term-RadioA) only associates with Subscribers that match the configured MAC addresses. The Terminal A configuration only provides one line for the remote RF MAC Address entry for Terminal B. The threshold settings for Radio A are on the [System Configuration Page](#).



Figure 23 Access Control List–ExpandAir Sub model



**Note:** For Subs (Term-RadioB), the Access List Filtering enable/disable option is not available; it is recommended that you enter the far-end RF MAC address in this field.

## VLAN Configuration Page

VLAN is disabled as the default setting for Exalt radios. Exalt radios still pass VLAN and non-VLAN traffic across the link, but do not examine the VLAN traffic or act upon it. When VLAN is disabled, management access to the radio is untagged. Enable VLAN using the Exalt GUI for expanded VLAN support.

The screenshot displays the Exalt GUI's VLAN Configuration page. The top navigation bar includes 'ExtendAir eMIMO', 'Local Term 02:17:09:00:9E:B4', and 'Subscribers Associated 7'. The left sidebar contains a menu with options like 'Radio Information', 'Administration', 'Configuration', 'System', 'Interface', 'Access Control List', 'Advanced', 'VLAN', 'Alignment', 'Radio default', 'Monitor', 'Analysis', 'Reboot', 'Shutdown', 'Manual', and 'Terms of Use'. The main content area is titled '802.1Q VLAN Configuration' and features an 'Update' button. A table shows the current state of VLAN configuration, with a dropdown menu open for the 'New Value' column, showing 'Disable', 'Enable', and 'Enable (MGMT ONLY)'. Below this is the 'VLAN Membership' table, which lists VLAN groups and their current values. The 'Port Ingress/Egress Configuration' section contains two tables for 'ETH1' and 'ETH2/ETH3', each with 'Ingress' and 'Egress' settings. The '802.1Q Ingress Retag Options (Reciprocated on Egress)' table is at the bottom, with an 'Add' button.

Figure 24 VLAN Configuration page



**Note:** All VLAN tagging is in reference to 802.1q VLAN ID and only the outer tag.

There are two primary VLAN settings: Management-Only and VLAN Ingress Filtering.

- **Management-Only VLAN** support for access to the radio's management interface on a designated VLAN ID. All other traffic is transparent. For this configuration, select Enable (MGMT ONLY) and enter the desired VLAN ID to manage the VLAN Membership table (on the row labeled Mgmt). Click Update to save changes. When enabled, untagged management access is lost to the radio and management is only available on the management VLAN ID (VID), and only on ports that are designated for management on the [Ethernet Page](#). All other entries in the VLAN

Membership table are ignored. The values in the Port Ingress/Egress Configuration table remain configurable.

- **VLAN Ingress Filtering:** Enabling VLAN allows the administrator to create lists of VLANs that are allowed to pass on each interface and a VLAN ID for management access to the radio. Up to 32 VLAN IDs can be listed for ETH1, and an additional 32 VLAN IDs are allowed for ETH2/ETH3 combination. Separate VLAN IDs using commas (for example, 100,250,1045,10); you can also use ranges (for example, 1-5,8,250).

If either interface entry table is left blank, then the default VLAN set in this table can ingress the interface. If either list is populated with one or more IDs, the default VLAN entry is ignored.

The VLAN ID used for management does not need to be entered into the Membership entry for ETH1 or ETH2/3.

Radio VLAN capabilities are extended to include tagged and untagged packet handling, along with Retag (Swap) capabilities.

The screenshot shows a configuration window titled "Port Ingress/Egress Configuration". It contains two main sections: one for ETH1 and one for ETH2/ETH3. Each section has a table with columns for "Current Value" and "New Value".

Interface	Current Value	New Value
ETH1	Ingress: Allow Untagged VID:	Allow Untagged (dropdown) [ ]
	Egress: Allow Untagged VID: Retag Tagged:Disable Retag VID:100	Allow Untagged (dropdown) [ ] <input type="checkbox"/> Retag Tagged 100
ETH2/ETH3	Ingress: Allow Untagged VID:	Allow Untagged (dropdown) [ ]
	Egress: Allow Untagged VID: Retag Tagged:Disable Retag VID:1004	Allow Untagged (dropdown) [ ] <input type="checkbox"/> Retag Tagged 1004

- **Untagged Packet Handling on Ingress:** When VLAN is enabled for ETH1 and ETH2/3 independently, the administrator can choose how to handle untagged packets that arrive at the radio input that are to be transmitted to the far-end (Ingress packets). These packets can be passed (Allow Untagged), dropped (Drop Untagged), or tagged (Tag Untagged). If tagged, enter the desired tag value at the right of the selection. This can be a different value for ETH1 as compared to ETH2/3, and also does not have to match the default. This tag does not impact the management VLAN ID (if there is one). If management VLAN is untagged, it is forced to set the Ingress and Egress options to Allow Untagged.
- **Egress Packet Handling:** This is for packets coming from the far-end and exiting the radio (Egress packets). You can allow untagged packets to exit the radio or drop untagged packets; tag untagged packets with the specified tag or untag all tagged packets. Ensure that you carefully coordinate this setting with the Ingress setting on the opposite end. For example, if you opt to drop untagged traffic on Ingress for the far-end radio, it does not matter if you select to drop, pass, or tag untagged packets; there will be no untagged packets. If you want to drop untagged packets, do this at the Ingress so that they do not take up link capacity only to be dropped on the other end. If a management VLAN ID is defined, it is not untagged when Tag Untagged is selected.

ETH1	Current Value	New Value
Ingress	Allow Untagged VID:	Allow Untagged
Egress	Allow Untagged VID: Retag Tagged:Disable Retag VID:100	<div style="border: 1px solid black; padding: 2px;">                     Allow Untagged                      Allow Untagged                      Drop Untagged                      Tag Untagged                      Untag Tagged                 </div>
ETH2/ETH3	Current Value	New Value
Ingress	Allow Untagged VID:	Allow Untagged
Egress	Allow Untagged VID: Retag Tagged:Disable Retag VID:1004	Allow Untagged <input type="checkbox"/> Retag Tagged 1004

- **Retag Tagged packets on Egress:** This ensures that all tagged packets arriving from the far-end are unified in a new tag with a specified value.
  - If a management VLAN ID is defined, it is not retagged.
  - If management VLAN is untagged and configured for in-band management, you must select Allow Untagged for both Ingress and Egress.
  - Any VLAN tagged user traffic is dropped if that VLAN ID is not included in the VLAN Membership configuration for the Egress port.
- **802.1Q Retag Ingress Options:** Enter the VLAN ID to replace on ingress, and provide input to the new VLAN ID.

## Antenna Alignment Settings Page

This page aids with antenna alignment.

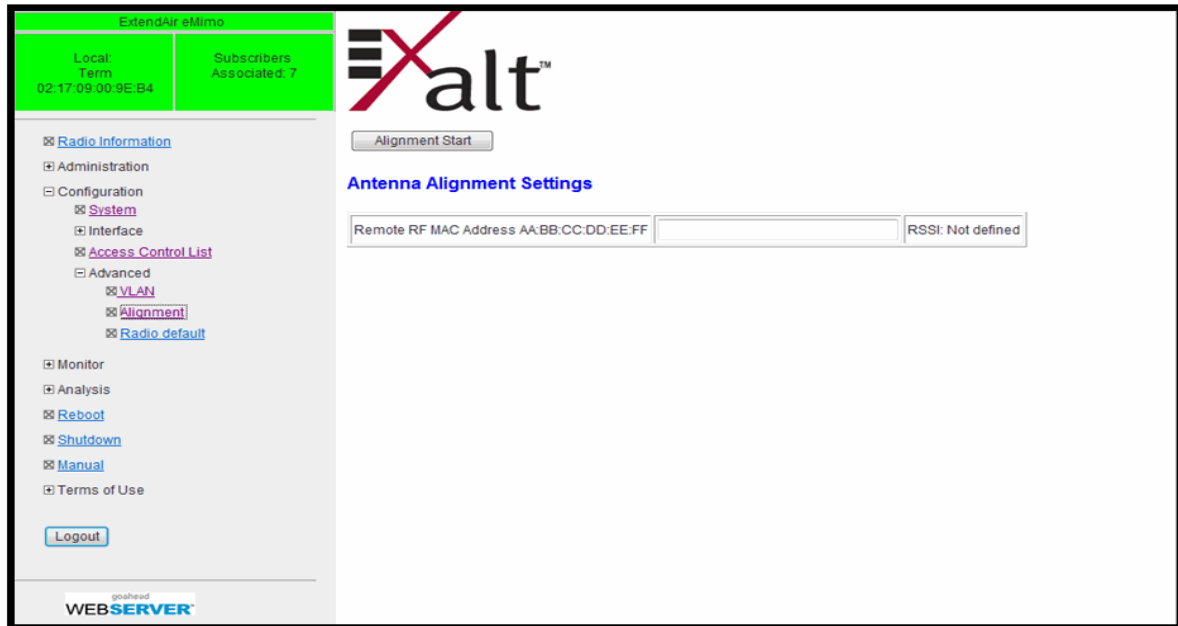

Figure 25 Antenna Alignment Settings page—ExtendAir model

Input the RF MAC address of the peer radio, which can be found on the [Radio Information Page](#). This is mandatory for Radio B/Sub and optional for Radio A/Hub. Click Alignment Start to initiate alignment. Audio beeps indicate the received signal level. The RSSI displays when signal level is present. Click Alignment Stop when you are satisfied with antenna alignment.

The beep period is approximately once every 3 seconds when the radio link is not acquired. Once the link is acquired, the period shortens to 1 beep per second. The beep period gets shorter until it is nearly constant as RSL increases. The precise RSL is available within the GUI shown on this page and on the [Performance Page](#).

Disable antenna alignment at both ends of the link once alignment is complete. Traffic can pass across the link while alignment is enabled (if the link is acquired), allowing you to manage the far-end radio from the near-end. However, when the alignment feature is enabled radio throughput is significantly diminished.

## Radio Default Page

Click the radio default button to reset the radio configuration parameters to the factory default settings.



**Note:** This brings the link down.

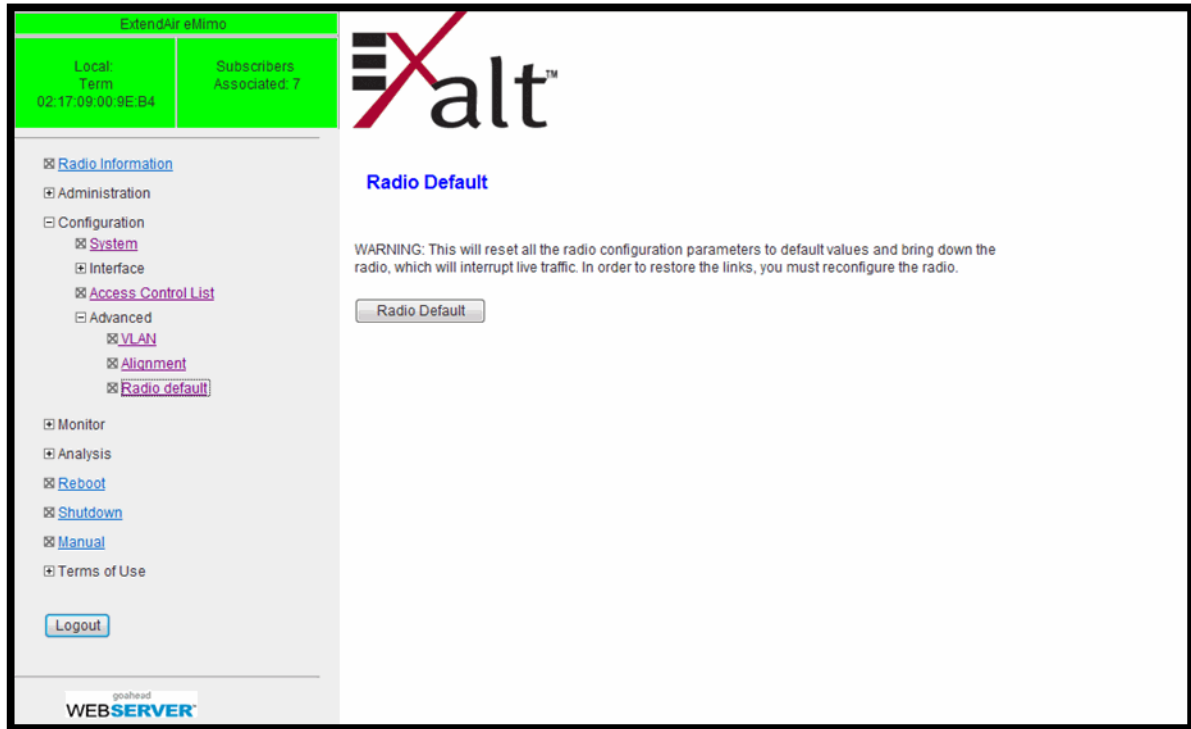

Figure 26 Radio Default page



## Performance Page

This page provides statistical information about the performance of the system in relation to the integrity of the user data and the RF link. This page is convenient for reviewing radio configuration and general performance.

The screenshot displays the 'Performance' page of the Exalt web interface. The interface includes a navigation menu on the left with options like 'Radio Information', 'Administration', 'Configuration', 'Monitor', 'Analysis', 'Reboot', 'Shutdown', 'Manual', and 'Terms of Use'. The 'Performance' section is active, showing two tables: 'Performance' and 'Radio Collocation'. The 'Performance' table lists various radio parameters, and the 'Radio Collocation' table shows link details.

Performance	
Radio (RF) State	Enabled
Endpoint Identifier	Term-RadioB
Radio Freq	5.310 GHz
Bandwidth	40 MHz
Transmit Power	20 dBm
Link Quality	94/94
Noise Level	-87 dBm
Far End Radio MAC	02:17:09:00:9F:BB
RSL	-45 dBm

  

Radio Collocation	
Access Protocol	TDMA
TDD Frame Size (ms)	5
TX/RX Throughput Ratio (%)	50:50
Link Distance	20 Km/12.4 miles

Figure 27 Performance page—ExtendAir Term-RadioB/Sub model

- The Radio (RF) State field indicates the current setting for Radio (RF) state, as set on the System Configuration screen.
- The Endpoint Identifier field indicates which mode the radio is in: Radio A/Hub or Radio B/Sub.
- The Radio Freq field is the frequency setting made on the System Configuration page or the present tuned center frequency if in AUTO mode or if the radio is a Radio B/Sub.
- The Transmit Power field lists the current transmit output.
- The Link Quality field is an index, where 94 is the best link quality and the first number represents the measured value of this index. A low number may indicate issues with high noise, low RSL, or other issues causing poor or errored reception.
- The Noise Level field displays the noise interference (dBm) detected in the link at the current frequency and bandwidth setting.
- The Far End Radio MAC entry lists the RF MAC address of far-end radio connected to this radio when the link is connected.
- The Received Signal Level (RSL) field indicates the present received level in dBm. This is helpful to compare to the installed value to see if signal level is changing from original implementation.

## Radio Collocation Fields

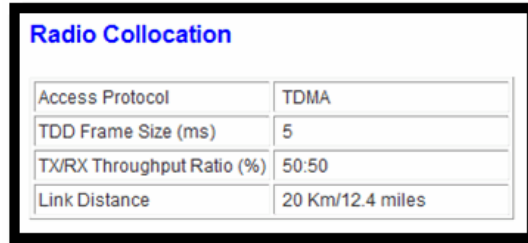

The screenshot shows a window titled "Radio Collocation" with a table of settings. The table has two columns: the left column lists the settings and the right column shows their values.

Radio Collocation	
Access Protocol	TDMA
TDD Frame Size (ms)	5
TX/RX Throughput Ratio (%)	50:50
Link Distance	20 Km/12.4 miles

Figure 28 Radio Collocation pane–RadioB/Sub

For a RadioB/Sub, the settings information related to the access protocol settings display (Figure 28).

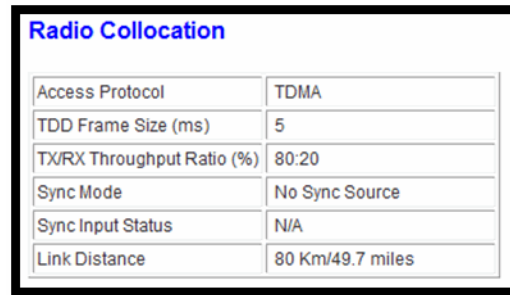

The screenshot shows a window titled "Radio Collocation" with a table of settings. The table has two columns: the left column lists the settings and the right column shows their values.

Radio Collocation	
Access Protocol	TDMA
TDD Frame Size (ms)	5
TX/RX Throughput Ratio (%)	80:20
Sync Mode	No Sync Source
Sync Input Status	N/A
Link Distance	80 Km/49.7 miles

Figure 29 Radio Collocation pane–RadioA/Hub

For a RadioA/Hub (Figure 29), the access protocol settings display, along with the collocation status, as applicable.

## Ethernet Negotiation State Page

This page displays the current connectivity and negotiation state for the three Ethernet ports. This is helpful for troubleshooting (such as detection of a bad connector/crimp or cable).

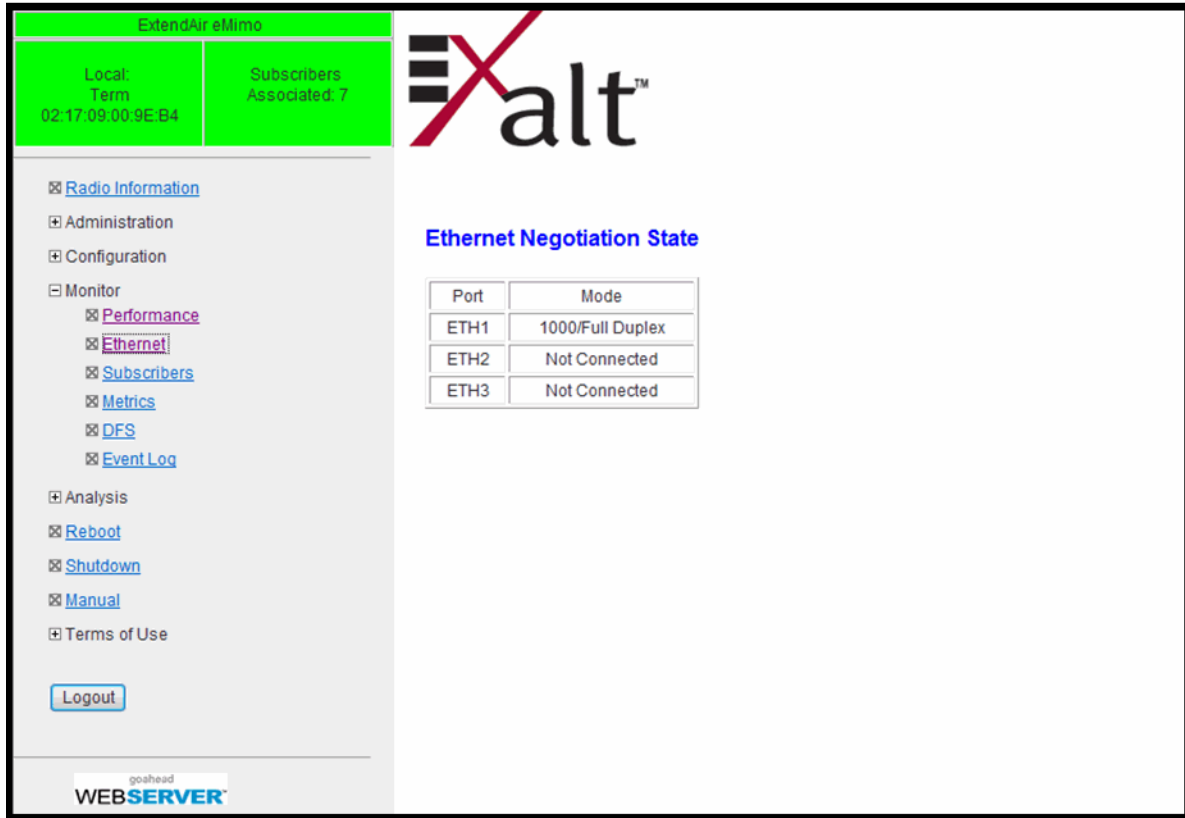

The screenshot shows the Exalt web interface. At the top, there is a green header with 'ExtendAir eMimo' and a status bar showing 'Local Term: 02:17:09:00:9E:B4' and 'Subscribers Associated: 7'. The Exalt logo is prominently displayed. A navigation menu on the left includes options like Radio Information, Administration, Configuration, Monitor (with sub-options like Performance, Ethernet, Subscribers, Metrics, DFS, Event Log), Analysis, Reboot, Shutdown, Manual, and Terms of Use. A 'Logout' button is also present. The main content area is titled 'Ethernet Negotiation State' and contains a table with the following data:

Port	Mode
ETH1	1000/Full Duplex
ETH2	Not Connected
ETH3	Not Connected

Figure 30 Ethernet Negotiation State page

Ensure that ETH1 negotiates at 1000BaseT/Full Duplex; ETH 2 and ETH 3 if in use, negotiate at 100BaseT/Full Duplex.

## Subscriber Page—Hub models only

For ExpandAir radios configured as Hub, this page lists Subscriber information and allows you to add Subscribers (16 maximum).

The screenshot shows the Exalt web interface for a Hub model. The top navigation bar includes 'ExtendAirMimo', 'Local: HUB 70 Real 02:17:09:00:9E:48', and 'Subscribers Associated: 16'. The Exalt logo is prominently displayed. A left-hand navigation menu contains various system management options. The main area is titled 'Subscribers' and contains a table with the following data:

Subscriber Name	Far End RF MAC	RSL
77-A-Sub	02:17:09:00:91:E3	-56 dBm
79-A-Hub-as-Sub	02:17:09:00:8D:F3	-60 dBm
Sub #12	02:17:09:00:8D:D3	-59 dBm
82-Real-W-Sub	02:17:09:00:9E:67	-59 dBm
Sub #13	02:17:09:00:8D:F5	-59 dBm
75-W-Hub-s	02:17:09:00:18:41	-49 dBm
74-W-Sub	02:17:09:00:91:CA	-56 dBm
73-A-old-hub-now-sub	02:17:09:00:91:90	-55 dBm
80-A-Sub	02:17:09:00:8D:CB	-59 dBm
81-A-Sub	02:17:09:00:8D:FD	-60 dBm
76-A-Term	02:17:09:00:91:EA	-56 dBm
83-Real-A-Sub	02:17:09:00:9E:4C	-57 dBm
Sub #14	02:17:09:00:8D:C3	-54 dBm
Sub #15	02:17:09:00:8D:CD	-59 dBm
add	02:17:09:00:8A:57	-59 dBm
78-W-Sub	02:17:09:00:8A:54	-59 dBm

Figure 31 Subscribers page—ExpandAir Hub models only

As new subscribers associate with the Hub, their RF MAC addresses display on this page. This is only if Subscribers have the proper Link Security setting and other System parameters match as required to allow association. Click the Add button to apply a human-readable name to the Subscriber to better track Subs in your network. Up to 16 Subs can associate with a Hub.

## Metrics – Link Statistics and Radio Interface Statistics Page

The Metrics page lists link and radio interface statistics.

The screenshot displays the Exalt web interface for the Metrics page. It features a navigation sidebar on the left with options like Radio Information, Administration, Configuration, Monitor, Performance, Ethernet, Subscribers, Metrics, DFS, Event Log, Analysis, Reboot, Shutdown, Manual, and Terms of Use. The main content area is divided into several sections:

- Link Statistics:** A table comparing ETH1 Link, ETH2/ETH3 Link, and Radio Link across various metrics like RX/TX packets, errors, dropped packets, and bytes.
- Radio Interface Statistics:** A table showing Header Collisions Detected (60s/Cumulative), Packet Collisions Detected (60s/Cumulative), and Keep Alive Sent.
- Radio Interface Counters:** A table showing Packets sent/received on interface, Retry Count of Pkts sent on interface, Error Count of Pkts sent on interface, Retry Rate, and Packet Error Rate.
- Subscriber Selection:** A dropdown menu for selecting a subscriber, with a list of available subscribers and their aliases.
- Modulation/Rate Counters:** Two tables showing modulation and rate counters for different subscribers, with columns for 1x1 and 2x2 configurations.

Figure 32 Metrics page—ExtendAir RadioA/Hub model

The link statistics listed are:

- Rx packets: The number of data packets received into the interface mentioned in the column
- Rx packets errors: The number of data packet errors into the interface mentioned in the column
- Rx packets dropped: The number of data packets dropped into the interface mentioned in the column
- Rx bytes: The number of data bytes received into the interface mentioned in the column
- Tx packets: The number of data packets transmitted out of the interface mentioned in the column
- Tx packets errors: The number of transmit data packet errors out of the interface mentioned in the column
- Tx packets dropped: The number of transmit data packets dropped out of the interface mentioned in the column
- Tx bytes: The number of data bytes transmitted out of the interface mentioned in the column

The radio interface statistics are radio packets, not equivalent to Ethernet packets, as follows:

- Header Collisions Detected (total over the last 60 seconds)
- Packet Collisions Detected (total over the last 60 seconds)
- Keep Alive Sent/Received

The radio interface counters count radio packets, not equivalent to Ethernet packets, as follows:

- Packets sent on radio interface (out of radio)
- Packets received on radio interface (into the radio)
- Retry count of packets sent on the radio interface
- Error count of packets sent on the radio interface
- Retry Rate
- Packet Error Rate

Modulation/Rate counters indicate the modulation level, counting packets based on the modulation and MIMO state (1x1 or 2x2). 2x2 MIMO results in higher capacity than 1x1 MIMO and higher modulation (for example, 64QAM versus BPSK) results in higher capacity. An unfaded, unobstructed link operating with sufficient signal-to-noise ratio runs at 64QAM 2x2 MIMO, which is the highest capacity. View the counters for each state to evaluate the health of the link and determine the settings where most of the traffic is passing.

Packets sent on interface	1064984
Packets received on interface	983105
Retry Count of Pkts sent on interface	26073
Error Count of Pkts sent on interface	15
Retry Rate	0.000E+00
Packet Error Rate	0.000E+00

Subscriber:	02:17:09:00:91:CA [74-W-T]
Alias:	02:17:09:00:91:E3 [77-A-Term]
	02:17:09:00:18:41 [75-A-Sub]
Packets sent of	02:17:09:00:9E:C2 [79-A-Sub]
Packets receive	02:17:09:00:8D:D3 [72-A-Term]
Retry Count of r	02:17:09:00:91:CA [74-W-Term]
Error Count of F	02:17:09:00:9E:4C [83-A-Sub]
	02:17:09:00:9F:E9 [78-W-Sub]
Retry Rate	0.000E+00
Packet Error Rate	0.000E+00

- (ExpandAir Hub) Subscriber counters in both counter tables can be viewed, one at a time, by selecting them from this drop-down menu in the lower portion of the Radio Interface Counters section.

The Clear Counters button restarts the bottom two tables at zero. It does not clear the statistics tables.

## DFS Page

DFS status displays on this page. DFS is automatically enabled for any band where required based on regulation. For bands where DFS is not required, it can still be selected. For DFS to operate properly, set the antenna gain figure to match the installed transmission system gain (that is, the gain of the antenna minus all losses between the radio and the antenna).

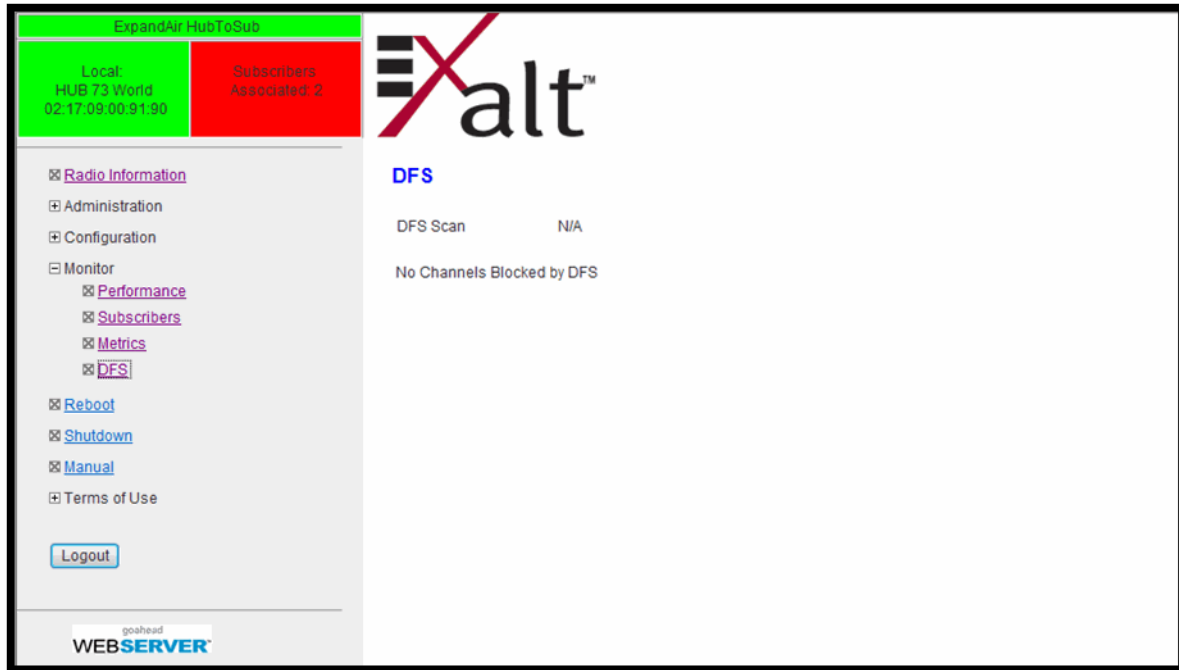

Figure 33 DFS page—ExpandAir model

When DFS is enabled, the radio temporarily stops transmitting for at least 60 seconds to ensure that no radar interference is present. This is called Channel Availability Check (CAC). Once CAC passes, the radio resumes normal operation.

If at any time during CAC or regular operation a qualifying radar signature is detected, the radio shuts down communications on that channel for a minimum of 30 minutes. The radio then moves to an available channel, and the restores the link after the CAC period (that is, 60 seconds if no radar signature is detected on the channel). This is the Non-Occupancy Period (NOP). Transmission only resumes after the NOP completes and then only after a successful CAC.

As shown below, ExpandAir models configured as Hubs display all frequencies not allowed due to DFS, and list them in accordance to the different subscribers based on their RF MAC addresses, and by the time remaining until that frequency can be tried again. PTP radios (eMIMO) display only one list of frequencies from either end. This difference is because the frequencies found may be blocked by specific subscribers.



**DFS**

DFS Scan                      COMPLETED

DFS Blocking Source	Frequency (GHz)	Time left (mm:ss)
01:01:01:01:01:01	5.31	26:30
01:01:01:01:01:02	5.29	27:10
02:17:09:00:91:D3 (Sub #1)	5.56	29:40
AA:AA:AA:AA:AA:AA (Hub)	5.563	29:43

## Event Log Page

The event log tracks configuration changes and alarm state changes up to the last 1000 entries. You can download the log as a .csv file from the [File Management Page](#).

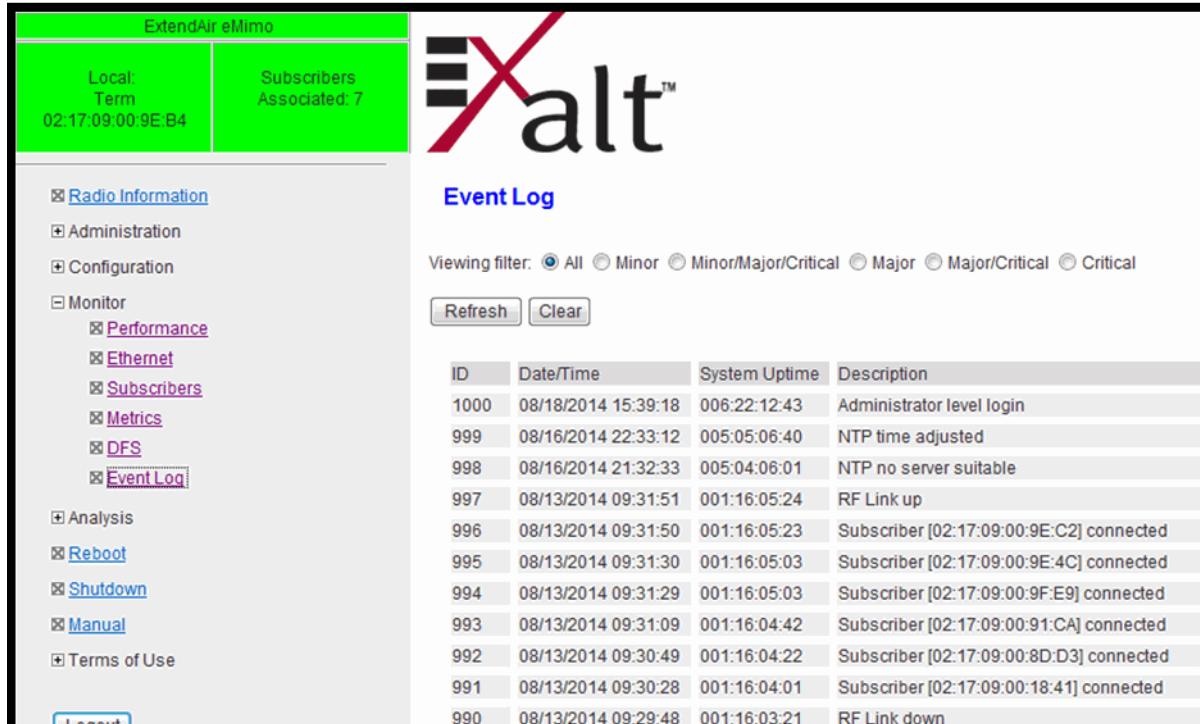

The screenshot shows the Exalt Event Log page. The top navigation bar includes 'ExtendAir eMIMO', 'Local Term: 02:17:09:00:9E:B4', and 'Subscribers Associated: 7'. The Exalt logo is prominently displayed. The left sidebar contains a menu with various system management options. The main area is titled 'Event Log' and features a viewing filter set to 'All' with radio buttons for 'Minor', 'Minor/Major/Critical', 'Major', 'Major/Critical', and 'Critical'. There are 'Refresh' and 'Clear' buttons. Below this is a table of event logs.

ID	Date/Time	System Uptime	Description
1000	08/18/2014 15:39:18	006:22:12:43	Administrator level login
999	08/16/2014 22:33:12	005:05:06:40	NTP time adjusted
998	08/16/2014 21:32:33	005:04:06:01	NTP no server suitable
997	08/13/2014 09:31:51	001:16:05:24	RF Link up
996	08/13/2014 09:31:50	001:16:05:23	Subscriber [02:17:09:00:9E:C2] connected
995	08/13/2014 09:31:30	001:16:05:03	Subscriber [02:17:09:00:9E:4C] connected
994	08/13/2014 09:31:29	001:16:05:03	Subscriber [02:17:09:00:9F:E9] connected
993	08/13/2014 09:31:09	001:16:04:42	Subscriber [02:17:09:00:91:CA] connected
992	08/13/2014 09:30:49	001:16:04:22	Subscriber [02:17:09:00:8D:D3] connected
991	08/13/2014 09:30:28	001:16:04:01	Subscriber [02:17:09:00:18:41] connected
990	08/13/2014 09:29:48	001:16:03:21	RF Link down

Figure 34 Event Log page

Apply filters to ascertain alarm severity levels. If an NTP server is configured, the date and timestamp that display in the Event Log is retrieved from the NTP server. If NTP is not configured, the radio tracks elapsed time.



Enable NTP for accurate troubleshooting using the Event Log (see [NTP and Time Zone Page](#)).

## Spectrum Analyzer Page

The spectrum analyzer feature provides a useful pre-planning and troubleshooting tool. Perform a spectrum analysis after deployment and just before commissioning to maintain a record of the spectrum at the time of deployment.



**Note:** The radio link is out of service during scans. Click the Cancel button to stop the spectrum analysis at any time. The link restores shortly after the analysis stops.

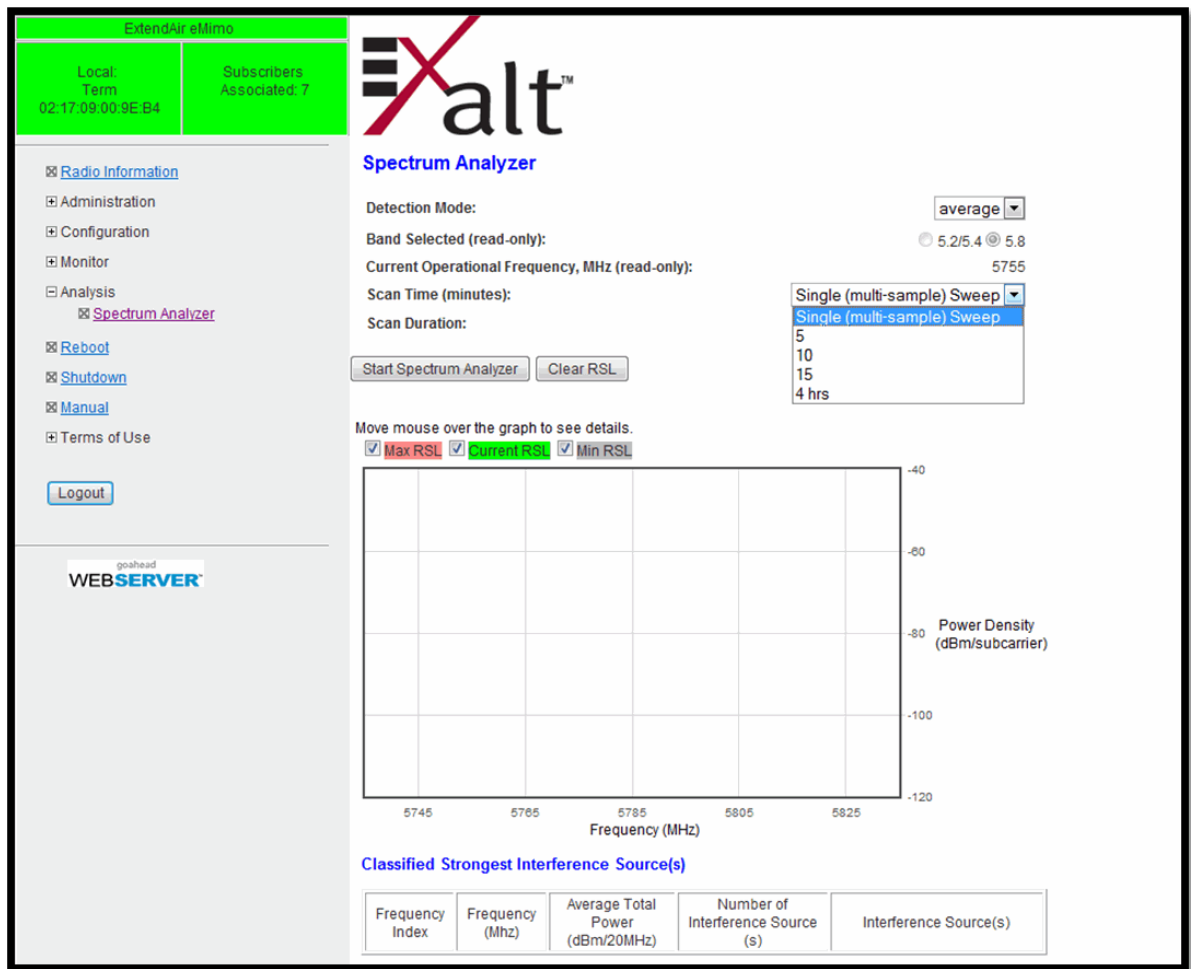

Figure 35 Spectrum Analyzer page

Perform a spectrum analysis to evaluate interfering signals coming into the antenna interface from the end of the link that is being analyzed. The spectrum analyzer uses tune-and-dwell across the active band that is active, using a 20MHz tuning channel. The active band is determined by the current frequency band setting selected on the [System Configuration Page](#), or can be determined on the [Performance Page](#). The selected band and the current frequency also display on this page.



**Note:** The frequency does not display properly when the radio is set to AUTO frequency.

You can set the spectrum analyzer for either Average or Peak detection:

- Average measures the average power spectral density (dBm/subcarrier or dBm/RBW).

- Peak measures the peak power during the scan duration of each channel. The sampling rate is ~140Hz.

Before you change the detection mode, click the Clear RSL button so that results from previous scans using an alternate detection scheme are not combined with the newly selected detection scheme.

- Scan Time is the total amount of time for the scan. This measurement quickly tunes, dwells and measures across the band. In most cases, a scan results in multiple visits to each frequency. It is recommended to scan for as long as possible so that all interference sources that may be intermittent and/or moving in frequency are caught by the analysis. The actual scan time can exceed the selected scan time by as much as 2 minutes. This is to meet minimum dwell time and computational requirements.

---

**Note:** If you after select a 4-hour scan time, a false warning displays that the link will not come back up. Ignore this warning.



Also, if you visit another page while a scan is running, when you return the values shown are at the default and not at your last-specified setting.

---

As the scan moves from step to step, the last-step graph displays. Historical scans are saved until you select Clear RSL is selected or power is lost or any reboot. The Scan Duration indicates the current amount of time the present scan has taken or the total time of the last scan that completed.

The display shows red, green, or gray markings to show High, Current (Last), or Low readings, respectively. These values are based on the measurements of all scans performed since the last Clear RSL or reboot/power cycle.

If only one scan has run, all markings are usually green as they are the last and most current measurement. On successive scans, green indicates the latest scan, and red and gray indicate high and low values of all completed scans. If the values have not changed, the colors may lie on top of each other. The noise floor line indicates the noise level measured at the current frequency channel (shown in the Operational Frequency field). You can opt to do a single-sweep scan if there is not enough time to perform a multi-sweep scan. Results are less accurate if there are any intermittent interference sources.

Figure 36 shows an example scan result.

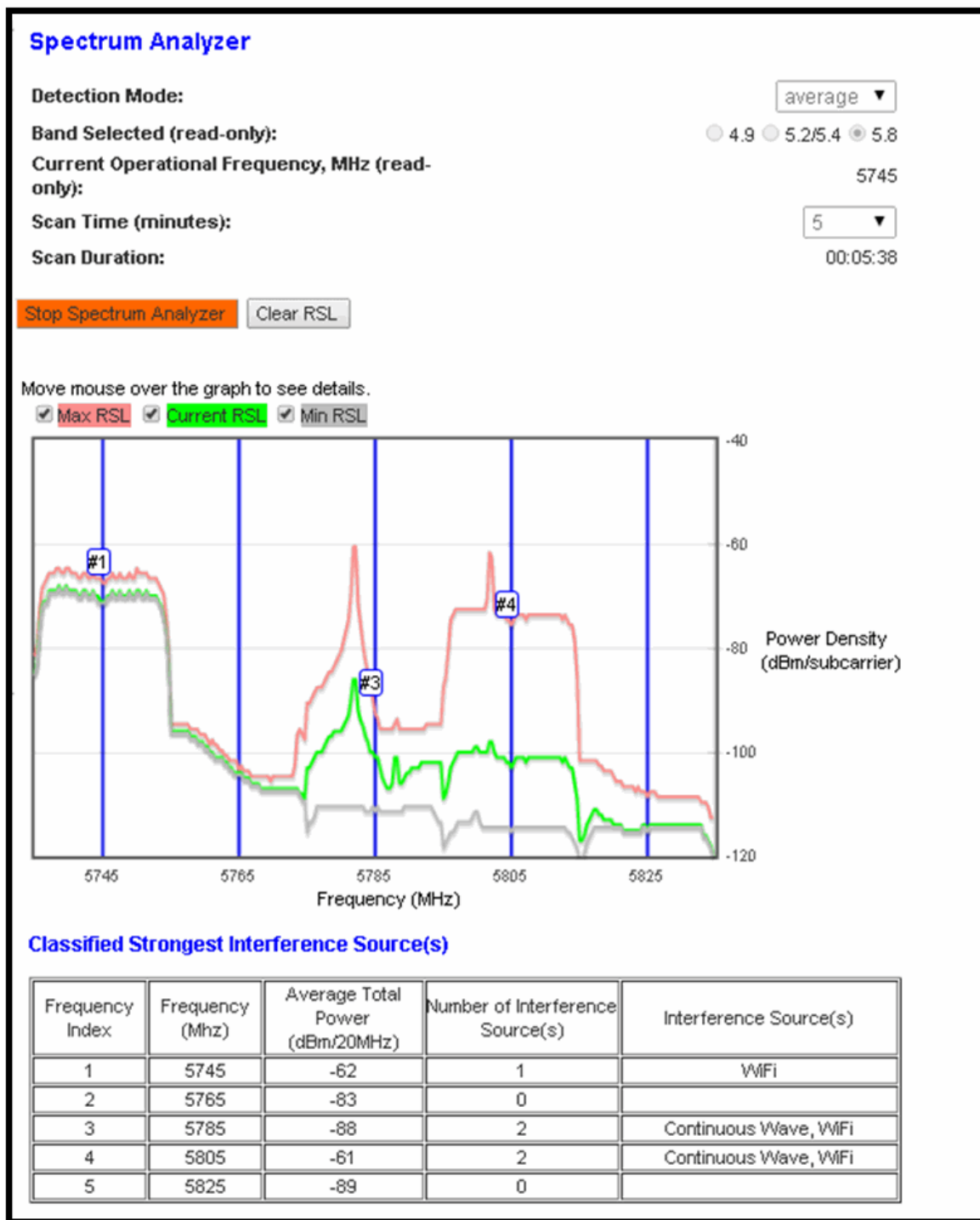

Figure 36 Spectrum Analyzer example

The Classified Strongest Interference Source(s) table at the bottom is helpful to identify the total power measured every 20MHz steps across the band and further evaluate interference potential and compare to the link RSL. If the type of signal can be identified, this is also provided. Common classifications are:

- CW (continuous wave)

- WiFi (pulsed emission)
- FHSS (frequency hopping spread spectrum).

Pointers are available when you roll your cursor over the chart. The values at the cursor position list on the chart. This allows more precise measurement than comparing the X and Y axis.

For Hubs, if the radio is linked to any Subs, the far-end transmitters of those Subs is turned OFF during the scan; however, when initiating a scan on the Sub radio or on terminals configured as Radio B in an ExpandAir network, the far-end transmitter of the Hub is ON during scans. If you want to turn off the Hub transmitter, disable RF on the [System Configuration Page](#) for the Hub during the scan. Ensure that you enable RF after the scan completes to restore communication.

## Reboot Page



**IMPORTANT!** Ensure that proper and constant power is applied during the entire reboot process.

Click the Reboot button on this page to start a radio reboot. The function may never be required, but can be used in emergencies. All configurations that require a reboot automatically reboot on administrator confirmation.

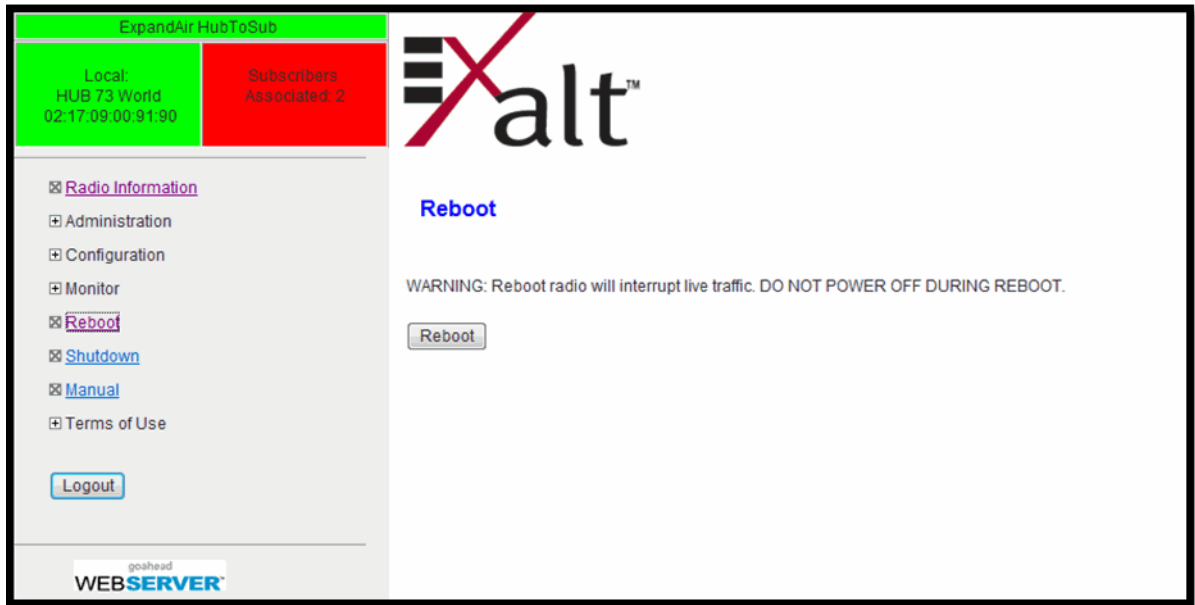

Figure 37 Reboot page–ExpandAir model

## Shutdown Page

Click the Shutdown button on this page to start a radio power down. It is important that you press the Shutdown button before removing power from the radio. This preserves current radio memory against any issues during power cycling. When the button is pressed, the ‘wait for 30 seconds before removing power’ message displays.

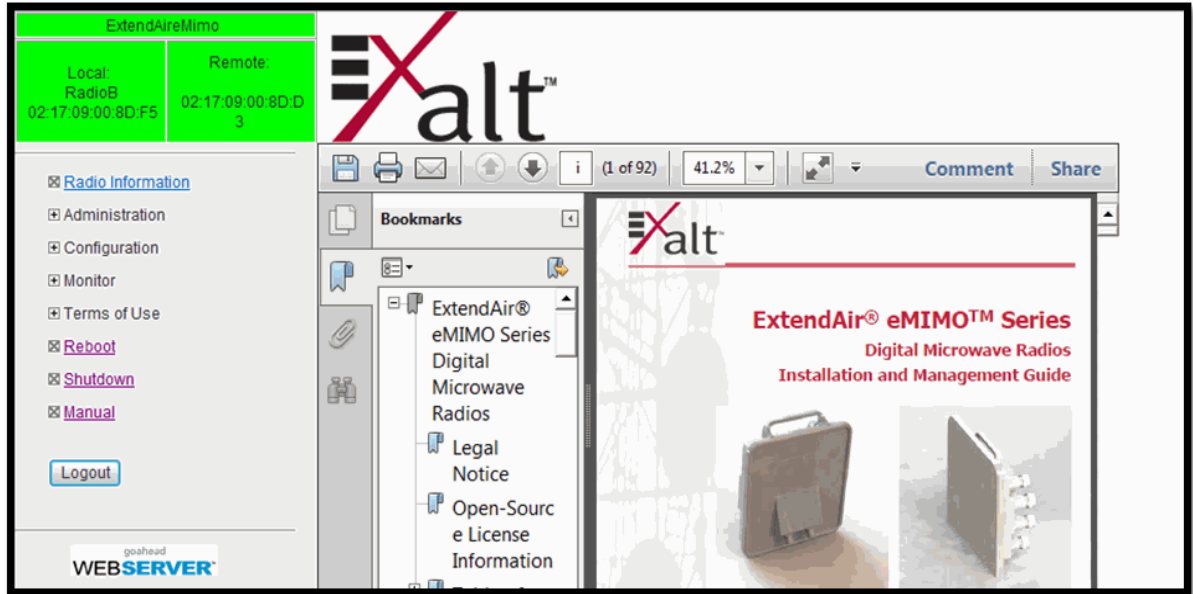

Figure 38 Shutdown page—ExpandAir model



## Manual Page

The manual (this document or the version that matches the installed firmware) is available within the GUI. Adobe Acrobat Reader 5.5 or higher is required (go to [www.adobe.com](http://www.adobe.com) to download Acrobat Reader). Click the Manual link to display the manual within the browser window. Once the manual displays, click the save button on the PDF toolbar to download the manual locally.



Manual page

## Specifications—ExtendAir Models

This section presents specifications for the ExtendAir series of Digital Microwave Radios.

### Physical Specifications

#### Integrated Antenna Models

Physical Configuration	Outdoor unit (ODU)
Dimensions (H x W x D)	12" x 12" x 4.5" / 30cm x 30cm x 12cm
	r5661S-17 models only: 7.5" x 7.5" x 3.0" / 19cm x 19cm x 13cm
Weight	7 lbs / 3.18 kg
	r5661S-17 models only: 3 lbs / 1.4 kg
Operating Temperature	-40 to +149°F / -40 to +65°C
Altitude	15,000' / 4.6 km
Humidity	100% condensing
Environmental	IP-67

#### Connectorized Antenna Mode (rc models)

Physical Configuration	Outdoor unit (ODU)
Dimensions (H x W x D)	9.3" x 9.3" x 5.25" / 24cm x 24cm x 13cm
Weight	6 lbs / 2.72 kg
Operating Temperature	-40 to +149°F / -40 to +65°C;
Altitude	15,000' / 4.6 km
Humidity	100% condensing
Environmental	IP-67

### **Common System Specifications**

Power Control Step Size                    1.0dB  
 Maximum RSL                                    0dBm no damage  
     BPSK, QPSK, 16QAM: -25dBm error-free  
     64QAM: -30dBm error-free

Receiver Threshold (BER=10<sup>-6</sup>)

<b>dBm</b>	<b>BPSK</b>	<b>QPSK</b>	<b>16QAM</b>	<b>64QAM</b>
5MHz	-96	-93	-88	-80
10MHz	-93	-90	-85	-77
20MHz	-90	-87	-82	-74
40MHz	-87	-84	-79	-71

Maximum 2x2 MIMO Aggregate  
 Over-the-Air Capacity (at max coding  
 rate, Mbps Max system Layer 1/Max  
 Ethernet Layer 2)<sup>a</sup>

<b>Mbps</b>	<b>BPSK</b>	<b>QPSK</b>	<b>16QAM</b>	<b>64QAM</b>
5MHz	4/3	10/8	20/16	33/26
10MHz	7/5	20/16	39/31	65/52
20MHz	13/10	39/31	78/62	130/104
40MHz	27/22	81/65	162/130	270/216

Maximum Range                                120 km  
 Link Latency                                    <3 ms typical  
 Link Security                                    96-bit Security Code, over-the-air 128-bit AES  
     encryption

- a. Bi-directional Ethernet throughput with 1518 byte packets including overhead @ 1.6 km distance. Actual user throughput will vary depending on modulation, channel bandwidth, packet size and distance.

## System Specifications, 4.9GHz Band

Frequency Band	4940–4990MHz
Output Power (at full power) all channels	+21.5dBm
Output Power (at minimum power)	0dBm
Selectable Channel Bandwidths	5MHz, 10MHz, and 20MHz
Non-overlapping Channels <sup>a</sup>	

5MHz	10MHz	20MHz
10	9	2

- a. Not all frequencies/channels are available in all regions.

## System Specifications, 5.3GHz Band

Frequency Band 5250–5350MHz

Output Power with STBC<sup>a</sup> (at full power)

5MHz: +21.5dBm

10MHz +21.5dBm

20MHz +21.5dBm

40MHz +23.5dBm

Output Power (at minimum power) 0dBm

Selectable Channel Bandwidths 5MHz, 10MHz, 20MHz, and 40MHz

Non-overlapping Channels<sup>b</sup>

5MHz	10MHz	20MHz	40MHz
13	7	4	2

- a. Space-Time-Block Coding allows transmission out of both antennas simultaneously, even for single stream. Allows double the power for single-stream rates.
- b. Not all frequencies/channels are available in all regions.

## System Specifications, 5.4GHz Band

Frequency Band 5470–5725MHz

Output Power with STBC<sup>a</sup> (at full power)

5MHz: +21.5dBm  
10MHz +21.5dBm  
20MHz +21.5dBm  
40MHz +23.5dBm

Output Power (at minimum power) 0dBm

Selectable Channel Bandwidths 5MHz, 10MHz, 20MHz, and 40MHz

Non-overlapping Channels<sup>b</sup>

5MHz	10MHz	20MHz	40MHz
41	21	12	5

- a. Space-Time-Block Coding allows transmission out of both antennas simultaneously, even for single stream. Allows double the power for single-stream rates.
- b. Not all frequencies/channels are available in all regions.

## System Specifications, 5.8GHz Band

Frequency Band	5725–5875MHz
Output Power (at full power) all channels	+28dBm STBC <sup>a</sup>
Output Power (at minimum power)	–4dBm
Selectable Channel Bandwidths	5MHz, 10MHz, 20MHz, and 40MHz
Non-overlapping Channels <sup>b</sup>	

5MHz	10MHz	20MHz	40MHz
17	14	7	3

- a. Space-Time-Block Coding allows transmission out of both antennas simultaneously, even for single stream. Allows double the power for single-stream rates.
- b. Not all frequencies/channels are available in all regions.

## **Interfaces**

### **RF**

Connector	N-type female (2, rc-model only)
Impedance	50 Ohms
Antenna	23dBi gain (r-model only)

### **Ethernet**

Connectors	3x RJ48C/RJ-45, female
Interface Speed	1x 10/100/1000/BaseT with PoE 2x 10/100BaseT
r5661S-17 models only:	1x 10/100/1000BaseT PoE
Duplex	Auto-negotiate to Half or Full
Compliance	802.3

### **Sync-In Sync-Out**

Connector	RJ-45, female
-----------	---------------

### **Power — DC Power Injector (sold separately)**

Input Voltage	48VDC (802.3af compliant, 802.3at compatible)
Consumption	<13 W



## Specifications—ExpandAir Models

This section presents specifications for the ExpandAir series of Digital Microwave Radios.

### Physical Specifications

#### Integrated Antenna Models

Physical Configuration	Outdoor unit (ODU)
Dimensions (H x W x D)	Int 23 dBi Ant: 12" x 12" x 4.5" / 30cm x 30cm x 12cm Int 9/17 dBi (hub) or 17dBi (sub) Ant: 9.5" x 9.5" x 5.5" / 24 x 24 x 14 cm Connectorized: 9.3" x 9.3" x 5.25" / 24 x 24 x 13 cm
Weight	Int 23 dBi Ant: 6 lbs / 2.8 kg Int 9/17 dBi (hub) or 17dBi (sub) Ant: 6.5 lbs / 3.0 kg Connectorized: 5 lbs / 2.3 kg
Operating Temperature	-40 to +149°F / -40 to +65°C
Altitude	15,000'/4.6 km
Humidity	100% condensing
Environmental	IP-67

#### Common System Specifications

Power Control Step Size	0 dBm (1.0dB)
Maximum RSL	0dBm no damage BPSK: -25dBm error-free 64QAM: -30dBm error-free

Receiver Threshold (BER=10<sup>-6</sup>)

dBm	BPSK	QPSK	16QAM	64QAM
5MHz	-96	-93	-88	-80
10MHz	-93	-90	-85	-77
20MHz	-90	-87	-82	-74
40MHz	-87	-84	-79	-71

Maximum 2x2 MIMO Aggregate Over-the-Air Capacity (at max coding rate, Mbps Max system Layer 1/Max Ethernet Layer 2)<sup>a</sup>

Mbps	BPSK	QPSK	16QAM	64QAM
5MHz	4/3	10/8	20/16	33/26
10MHz	7/5	20/16	39/31	65/52
20MHz	13/10	39/31	78/62	130/104
40MHz	27/22	81/65	162/130	270/216

Maximum Range	120 km
Link Latency	<5 ms typical
Link Security	96-bit Security Code, over-the-air 128-bit AES encryption

- a. Bi-directional Ethernet throughput with 1518 byte packets including overhead @ 1.6 km distance. Actual user throughput will vary depending on modulation, channel bandwidth, packet size and distance.

## System Specifications, 4.9GHz Band

Frequency Band	4940–4990MHz
Output Power with STBC <sup>a</sup> (at full power)	+21.5dBm
Output Power (at minimum power)	0dBm (1.0dB)
Selectable Channel Bandwidths	5MHz, 10MHz, and 20MHz
Non-overlapping Channels <sup>b</sup>	

5MHz	10MHz	20MHz
10	9	2

- a. Space-Time-Block Coding allows transmission out of both antennas simultaneously, even for single stream. Allows double the power for single-stream rates.
- b. Not all frequencies/channels are available in all regions.

## System Specifications, 5.3GHz Band

Frequency Band 5250–5350MHz

Output Power with STBC<sup>a</sup> (at full power)

5MHz: +21.5dBm

10MHz +21.5dBm

20MHz +21.5dBm

40MHz +23.5dBm

Output Power (at minimum power) 0dBm (1.0dB)

Selectable Channel Bandwidths 5MHz, 10MHz, 20MHz, and 40MHz

Non-overlapping Channels<sup>b</sup>

5MHz	10MHz	20MHz	40MHz
13	7	4	2

- a. Space-Time-Block Coding allows transmission out of both antennas simultaneously, even for single stream. Allows double the power for single-stream rates.
- b. Not all frequencies/channels are available in all regions.

## System Specifications, 5.4GHz Band

Frequency Band	5470–5725MHz
Output Power with STBC <sup>a</sup> (at full power)	
5MHz:	+21.5dBm
10MHz	+21.5dBm
20MHz	+21.5dBm
40MHz	+23.5dBm
Output Power (at minimum power)	0dBm (1.0dB)
Selectable Channel Bandwidths	5MHz, 10MHz, 20MHz, and 40MHz
Non-overlapping Channels <sup>b</sup>	

5MHz	10MHz	20MHz	40MHz
41	21	12	5

- a. Space-Time-Block Coding allows transmission out of both antennas simultaneously, even for single stream. Allows double the power for single-stream rates.
- b. Not all frequencies/channels are available in all regions.

## System Specifications, 5.8GHz Band

Frequency Band	5725–5875MHz
Output Power (at full power) all channels	+28dBm STBC <sup>a</sup>
Output Power (at minimum power)	–4dBm
Selectable Channel Bandwidths	5MHz, 10MHz, 20MHz, and 40MHz
Non-overlapping Channels <sup>b</sup>	

5MHz	10MHz	20MHz	40MHz
17	14	7	3

- a. Space-Time-Block Coding allows transmission out of both antennas simultaneously, even for single stream. Allows double the power for single-stream rates.
- b. Not all frequencies/channels are available in all regions.

## **Interfaces**

### **RF**

Connector	N-type female (2, rc-model only)
Impedance	50 Ohms
Antenna	23dBi gain, 10 degrees beamwidth 17dBi gain, 20 degrees beamwidth 9dBi gain, 60 degrees beamwidth

### **Ethernet**

Connectors	3x RJ48C/RJ-45, female
Interface Speed	1x 10/100/1000/BaseT with PoE 2x 10/100BaseT
Duplex	Auto-negotiate to Half or Full
Compliance	802.3

### **Sync-In Sync-Out**

Connector	RJ-45, female
-----------	---------------

### **Power — DC Power Injector (sold separately)**

Input Voltage	48VDC (802.3af compliant, 802.3at compatible)
Consumption	<13 W

## Interface Connections

This section provides the pin number assignment and wiring information for the connectors on the ExtendAir eMIMO and ExpandAir Series radios. All connectors are shown as viewed from the radio rear panel, oriented with the PoE connector at the lower left corner.

### Sync Connector

The connector is used for connection to send or receive sync signals to a collocated radio, or to an ExaltSync Collocation Kit, for multiple radio sync. Figure 39 illustrates the pin orientation and functionality for this connector.

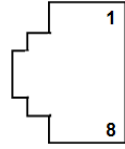

Pin	Function
1	(future use)
2	Ground
3	(future use)
4	(future use)
5	(future use)
6	Sync input signal
7	Unused
8	Sync output signal

Figure 39 Sync In/Sync Out connector

### Two Radio Internal Sync Out/ In

If using the Internal Sync Out/In function between two radios only, connect Pin 8 from the Sync Out radio to Pin 6 of the Sync In radio and use a straight connection for Pin 2. Connect no other pins. To ease the need to keep track of which end of the cable is for In and Out, consider cross-connecting Pins 6 and 8, with a straight connection for Pin 2. Connect no other pins.

### Sync Distribution Accessory

If using a sync distribution accessory (sold separately), connect CAT5e cabling straight from the radio Sync connector(s) to the accessory.



## Power/ ETH1 Connector

This connector is the primary connector on the radio, and must be connected to provide power to the radio, and primary Ethernet communications for traffic and Ethernet. Figure 40 illustrates the pin orientation and functionality for this connector. This connection supports 10/100/1000BaseT.

The Ethernet cable between the PoE injector must be wired as a straight connection. The wiring follows typical wiring for Power-over-Ethernet (PoE), and is 802.3af compliant and 802.3at compatible.

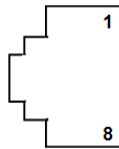

Pin	
1	Paired with Pin 2 (with 48VDC)
2	Paired with Pin 1 (with 48VDC)
3	Paired with Pin 6 (with 48VDC)
4	Paired with Pin 5 (with 48VDC)
5	Paired with Pin 4 (with 48VDC)
6	Paired with Pin 3 (with 48VDC)
7	Paired with Pin 8 (with 48VDC)
8	Paired with Pin 7 (with 48VDC)

Figure 40 Power/ETH1 connector

## Antennas

The ExtendAir eMIMO and ExpandAir Series digital microwave radios are intended for use in the USA. In some countries, antennas exceeding a certain level of gain may be unlawful. Refer to [RF Output Power Setting](#) for details on regulatory limits.

ExtendAir eMIMO and ExpandAir Series radios with integrated antennas have software selectable midband gain of 9, 17, or 23 dBi with a beamwidth of 3dB at 60, 20, and 10 degrees, respectively.

Table 6 lists dual-polarity antennas for the ExtendAir eMIMO and ExpandAir Series radios.

Table 6 Dual-polarity Antennas

Manufacturer	Model Number	Type	Diameter	Gain (dBi)	Band Support, GHz			
					4.9	5.3	5.5	5.8
MTI	MA-WC56-DP9	Panel	0.5 ft	9	X	X	X	X
Mars	MA-WE56-DP12	Panel	0.5 ft	12		X	X	X
Mars	MA-WD56-DP13	Panel	0.5 ft	13		X	X	X
MTI	MT-463012/NVH	Panel	1.5 ft	14	X	X	X	X
Mars	MA-WE56-DP15	Panel	1 ft	14.5		X	X	X
KBT	KBT65VH15-5158RT0	Panel	1 ft	15		X	X	X
MTI	MT-463013/NVH	Panel	1.5 ft	15.5	X	X	X	X
Mars	MA-WD55-DS16	Panel	1 ft	16	X	X	X	X
Mars	MA-WD56-DP16	Panel	1 ft	16	X	X	X	X
Mars	MA-WD56-DSV16	Panel	1 ft	16	X	X	X	X
Mars	MA-WD62-DS16	Panel	1 ft	16				X
Mars	MA-WD62-DP16	Panel	1 ft	16				X
MTI	MT-484052/NVH	Panel	0.5 ft	16	X	X	X	X
KBT	KBT65DP17-5158RT0	Panel	1 ft	17		X	X	X
Mars	MA-WC55-DS17	Panel	1 ft	17	X	X	X	X
Mars	MA-WC62-DP17	Panel	1 ft	17				X
KBT	TDJ-5158BKR×2	Panel	1 ft	18		X	X	X
Mars	MA-WC56-DP17	Panel	1 ft	18	X	X	X	X
MTI	MT-485005/VHN	Panel	0.5 ft	18		X	X	X
Mars	MA-WA56-DP19	Panel	0.5 ft	19	X	X	X	X
MTI	MA-WA56-DP19	Panel	0.5 ft	19	X	X	X	X

*Table 6 Dual-polarity Antennas (Continued)*

Manufacturer	Model Number	Type	Diameter	Gain (dBi)	Band Support, GHz			
					4.9	5.3	5.5	5.8
MTI	MT-485053/NVH	Panel	0.5 ft	19.5		X	X	X
MTI	MA-WA56-DP20	Panel	1 ft	21	X	X	X	X
MTI	MT-465017/NVH	Panel	1 ft	22.5	X	X	X	X
MTI	MT-485025/ND	Panel	1 ft	23		X	X	X
MTI	MA-WA56-DP25N	Panel	1 ft	23.5	X	X	X	X
RadioWaves	FPD1-5-24	Panel	1 ft	23.8		X	X	X
ARC Wireless	PD5823B88	Panel	1 ft	24	X	X	X	X
Mars	MA-WA56-DP25N	Panel	1 ft	24	X	X	X	X
Mars	MA-WA62-DP24	Panel	1 ft	24				X
Wireless Beehive	5.8DP-26	Solid Parabolic	1.5 ft	26		X	X	(X)
General Dynamics	HQFD2-52	Solid Parabolic	2 ft	28.1		X	X	X
General Dynamics	QFD2-52	Solid Parabolic	2 ft	28.4		X	X	X
KBT	TDJ-4958P6AC×2	Panel	2 ft	28.5	X	X	X	X
L-Com	HG5158DP-29D	Solid Parabolic	2 ft	28.5		X	X	X
MTI	MA-QA56-DP28NB	Panel	2 ft	28.5	X	X	X	X
RadioWaves	HPD2-5.2	Solid Parabolic	2 ft	28.6		X	X	X
CommScope	HPX2F-52	Solid Parabolic	2 ft	29		X	X	X
Laird	HDDA5W-29-DP	Solid Parabolic	2 ft	29	X	X	X	X
Mars	MA-WA62-DP30	Panel	2 ft	29			X	X
RadioWaves	SPD2-5.2	Solid Parabolic	2 ft	29		X	X	X
Wireless Beehive	5.8DP-29	Solid Parabolic	2 ft	29		X	X	(X)
CommScope	PX2F-52	Solid Parabolic	2 ft	29.4		X	X	X
ARC Wireless	DA5830SD1	Solid Parabolic	2 ft	30	X	X	X	X
Wireless Beehive	5.8DP-31	Solid Parabolic	3 ft	31		X	X	(X)
General Dynamics	QFD2.5-52	Solid Parabolic	2.5 ft	31.1		X	X	X
RadioWaves	HPD3-5.2	Solid Parabolic	3 ft	31.1		X	X	X

Table 6 Dual-polarity Antennas (Continued)

Manufacturer	Model Number	Type	Diameter	Gain (dBi)	Band Support, GHz			
					4.9	5.3	5.5	5.8
General Dynamics	HQFD2.5-52	Solid Parabolic	2.5 ft	31.2		X	X	X
Laird	HDDA5W-32-DP	Solid Parabolic	3 ft	32	X	X	X	X
L-Com	HG5158DP-32D	Solid Parabolic	3 ft	32		X	X	X
RadioWaves	SPD3-5.2	Solid Parabolic	3 ft	32.5		X	X	X
CommScope	PX3F-52	Solid Parabolic	3 ft	33.4		X	X	X
General Dynamics	QFD4-52	Solid Parabolic	4 ft	34.1		X	X	X
CommScope	HPX4F-52	Solid Parabolic	4 ft	34.5		X	X	X
General Dynamics	HQFD4-52	Solid Parabolic	4 ft	34.8		X	X	X
RadioWaves	HPD4-5.2	Solid Parabolic	4 ft	34.8		X	X	X
CommScope	PX4F-52	Solid Parabolic	4 ft	34.9		X	X	X
RadioWaves	SPD4-5.2	Solid Parabolic	4 ft	34.9		X	X	X
General Dynamics	QFD6-52	Solid Parabolic	6 ft	37.4		X	X	X
CommScope	PX6F-52	Solid Parabolic	6 ft	37.6		X	X	X
General Dynamics	HQFD6-52	Solid Parabolic	6 ft	37.8		X	X	X
CommScope	PARX6-59	Solid Parabolic	6 ft	37.9				X
RadioWaves	HPD6-5.2	Solid Parabolic	6 ft	37.9		X	X	X
RadioWaves	SPD6-5.2	Solid Parabolic	6 ft	37.9		X	X	X
Mars	MA-WA56-DP20	Panel	1 ft	22.5, 20.5	X	X	X	X
MTI	MT-485049/NVH	Panel	1 ft	23V/23H	X	X	X	X
MTI	MT-466010/NVH	Panel	2 ft	27.5, 28, 27	X	X	X	X
PC Tel	MPRD2449	Solid Parabolic	2 ft	27.5, 28.1, 29.4	X	X	X	X
MTI	MT-486013/NVH	Panel	2 ft	28, 29	X	X	X	X
L-Com	HG4958DP-30D	Solid Parabolic	2 ft	28, 30	X	X	X	X
Mars	MA-WA56-DP28N	Panel	2 ft	28.5, 29	X	X	X	X
PC Tel	MPRD3649	Solid Parabolic	3 ft	29.8, 31, 32	X	X	X	X
L-Com	HG4958DP-34D	Solid Parabolic	3 ft	31, 34	X	X	X	X

Table 7 lists single-polarity antennas for the ExtendAir eMIMO and ExpandAir Series radios.

*Table 7 Single-polarity Antennas*

Manufacturer	Model Number	Type	Diameter	Gain (dBi)	Bandwidth GHz			
					4.9	5.3	5.5	5.8
MTI	MT-462008/N/A	Panel	0.5 ft	9.5	X	X	X	X
MTI	MA-W55-10NH	Panel	1 ft	10	X	X	X	X
KBT	TDJ-5158BFA90-Y	Panel	0.5 ft	11		X	X	X
KBT	KBT120VP12-5158RT0	Panel	1 ft	12		X	X	X
KBT	KBT65VP15-5158RT0	Panel	1 ft	15		X	X	X
KBT	KBT120VP15-5158RT0	Panel	1 ft	15		X	X	X
MTI	MT-484034/NV/I	Panel	1.5 ft	15	X	X	X	X
KBT	KBT90VP16-5158RT0	Panel	1 ft	16		X	X	X
KBT	KBT65VP17-5158RT0	Panel	1 ft	17		X	X	X
KBT	KBT90VP17-5158RT0	Panel	2 ft	17		X	X	X
KBT	TDJ-5158BKC	Panel	1 ft	18		X	X	X
KBT	TDJ-5158BKR-C	Panel	1 ft	20		X	X	X
KBT	TDJ-5158BKR	Panel	1 ft	20		X	X	X
KBT	TDJ-5158BKB	Panel	1 ft	20		X	X	X
General Dynamics	EPD1-52	Panel	1 ft	23		X	X	X
KBT	TDJ-5158BKT-C	Panel	1 ft	23		X	X	X
KBT	TDJ-5158EB23	Panel	1 ft	23		X	X	X
KBT	TDJ-5158SPL4	Panel	1 ft	23.5		X	X	X
KBT	TDJ-5158P4	Panel	1 ft	24		X	X	X
Laird	PA58-24	Panel	1 ft	24		X	X	(X)
Laird	R2T58-24	Panel	1 ft	24	X	X	X	X
RadioWaves	FP1-5-24	Panel	1 ft	24.2		X	X	X
Laird	GD5W-25P	Grid Parabolic	2 ft	25	X	X	X	X
Laird	GD53-25	Grid Parabolic	2 ft	25		X		

Table 7 Single-polarity Antennas (Continued)

Manufacturer	Model Number	Type	Diameter	Gain (dBi)	Bandwidth GHz			
					4.9	5.3	5.5	5.8
Laird	GD57-25	Grid Parabolic	2 ft	25			X	
Laird	HDGD58-26	Grid Parabolic	2 ft	26				X
Laird	GD58-26	Grid Parabolic	2 ft	26				X
KBT	TDJ-5158SPL6	Panel	2 ft	26.5		X	X	X
Commscope	28T-5801-1	Grid Parabolic	3 ft	27				X
CommScope	UBP600-4-1	Panel	2 ft	27.5	X	X	X	X
PC Tel	MPRC2449	Solid Parabolic	2 ft	27.7	X	X	X	X
General Dynamics	EPD2-52	Panel	2 ft	28		X	X	X
KBT	TDJ-5158P6	Panel	2 ft	28		X	X	X
Laird	GD53-28	Grid Parabolic	3 ft	28		X		
Laird	GD57-28	Grid Parabolic	3 ft	28			X	
Laird	GD5W-28P	Grid Parabolic	3 ft	28	X	X	X	X
RadioWaves	FP2-5-28	Panel	2 ft	28		X	X	X
CommScope	UBG600-4-1	Grid Parabolic	3 ft	28.5		X	X	X
General Dynamics	HQF2-52	Solid Parabolic	2 ft	28.5		X	X	X
General Dynamics	QF2-52	Solid Parabolic	2 ft	28.5		X	X	X
Laird	GD58-29	Grid Parabolic	3 ft	29		X	X	(X)
Laird	HDGD58-29	Grid Parabolic	3 ft	29				(X)
Laird	HDDA5W-29-SP	Solid Parabolic	2 ft	29	X	X	X	X
RadioWaves	SP2-5.2	Solid Parabolic	2 ft	29		X	X	X
CommScope	P2F-57W	Solid Parabolic	2 ft	29.3				X
CommScope	P2F-52	Solid Parabolic	2 ft	29.4		X	X	X
General Dynamics	QF2.5-52	Solid Parabolic	2.5 ft	31.1		X	X	X
RadioWaves	G3-5.2	Grid Parabolic	3 ft	31.1		X	X	X
RadioWaves	HP2-5.2	Solid Parabolic	2 ft	31.4		X	X	X

*Table 7 Single-polarity Antennas (Continued)*

Manufacturer	Model Number	Type	Diameter	Gain (dBi)	Bandwidth GHz			
					4.9	5.3	5.5	5.8
RFS Cablewave	SPF3-52CN1S	Solid Parabolic	3 ft	31.4		X	X	X
Laird	HDDA5W-32	Solid Parabolic	3 ft	32	X	X	X	X
RadioWaves	HP3-5.2	Solid Parabolic	3 ft	32.5		X	X	X
RadioWaves	SP3-5.2	Solid Parabolic	3 ft	32.5		X	X	X
CommScope	P3F-52	Solid Parabolic	3 ft	33.5		X	X	X
RFS Cablewave	SDF4-52BN1S1	Solid Parabolic	4 ft	33.9		X	X	X
General Dynamics	SSP4-2357A	Solid Parabolic	4 ft	34.4				X
RFS Cablewave	SPF4-52CN1S1R	Solid Parabolic	4 ft	34.4		X	X	X
General Dynamics	HQF4-52	Solid Parabolic	4 ft	34.7		X	X	X
General Dynamics	QF4-52	Solid Parabolic	4 ft	34.8		X	X	X
CommScope	P4F-52	Solid Parabolic	4 ft	34.9		X	X	X
RadioWaves	SP4-5.2	Solid Parabolic	4 ft	34.9		X	X	X
RadioWaves	HP4-5.2	Solid Parabolic	4 ft	34.9		X	X	X
RFS Cablewave	DA4-W57BC1S1	Solid Parabolic	4 ft	35.5				X
RadioWaves	SP6-57	Solid Parabolic	6 ft	35.8				X
CommScope	P6F-52	Solid Parabolic	6 ft	37.6		X	X	X
General Dynamics	QF6-52	Solid Parabolic	6 ft	37.8		X	X	X
RadioWaves	HP6-5.2	Solid Parabolic	6 ft	37.9		X	X	X
RadioWaves	SP6-5.2	Solid Parabolic	6 ft	37.9		X	X	X
PC Tel	MPRC3649	Solid Parabolic	3 ft	30.4, 31.2, 32	X	X	X	X

## Troubleshooting

This section provides information regarding troubleshooting of common issues and alarms on these radios. Exalt Digital Microwave Radio systems are designed by Exalt's expert engineers with extensive experience through multiple generations of microwave radio design. These new-generation systems contain extensive diagnostic tools, alarm indications, and troubleshooting aids. And, as compared to other systems in their class, are easier to install, maintain, and troubleshoot. The GUI provides information to aid in troubleshooting.

Contact Exalt Customer Care for further assistance with issues with your Exalt radio and with suggestions on how the radio and documentation can be improved.

### General Practices

Troubleshooting a microwave radio link can be a complex task. Approach troubleshooting as a process of elimination, and first determine which portions of the system are operating properly.

In a vast majority of cases, failures or poor performance of microwave links is attributed to something other than the microwave radio hardware. In this respect, the back-to-back bench test (see [Back-to-back Bench Testing](#)) is very important to determine if radio hardware is operating properly and eliminate many variables in the troubleshooting process.

If a back-to-back bench test fails, then the radio hardware is either broken or the radios are improperly configured. Upgrade the radio to the most current release of firmware, and/or reset the radio to its critical factory settings, following the quick start guide instructions and those in [Configuration and Management](#), helps to confirm if configuration issues cause failure. The most common issues with microwave radio links are:

- An improperly terminated RF cable
- Multipath propagation
- RF interference
- Path obstruction
- Misaligned antenna
- Faulty antenna
- Improper grounding
- Insufficient link margin in the design/implementation
- Moisture in the transmission system (antenna feed and/or RF cable)

If the radio link has been operating without issues and is exhibiting new poor performance behavior or becomes completely inoperative, the troubleshooting process should pay close attention to any conditions that may have changed between the time when the system was working without issue and the time when the issues started.

Also, it can be helpful to compare some performance parameters of the system before and after the presence of issues. Often the source of the issues can be determined by thoughtful consideration of changes, such as:

- Changes in weather, including high winds
- Changes made to the radio equipment, transmission system, or connected equipment
- New radio systems or electronic equipment the nearby radio or transmission system



- New construction nearby either end of the link, or along the path
- Tree growth, flooded fields, or changes in rivers/lakes along the path

Verify that configurations are set as follows:

- RF matches at each end of the link
- Bandwidth matches at each end of the link
- Link distance matches at each end of the link
- TDD Frame Length matches at each end of the link
- Endpoint Identifier is different at each end of the link (one end Radio A/Hub, one end Radio B/Sub)
- Ethernet interfaces are enabled, as desired
- Link security key matches at each end of the link

### ***Typical Indications of Issues***

In many cases, microwave radio users do not notice changes or degradation to the radio system until the radio system fails completely or becomes highly errored or significantly intermittent. However, regular management of the radio system can help indicate changes in performance that have not yet impacted user performance, but may impact performance at a later date if left unchecked or unaddressed. The administrator can use this as an opportunity to be proactive and monitor the radio link performance regularly, watching for unexplained or unexpected changes in performance and trends in performance changes.

Most importantly, monitoring radio system RSL over time indicates the performance of the radio system. Address any long-term drop in RSL and erratic or unsteady RSL. Some RSL changes are expected and weather patterns and the related multipath can cause dramatic RSL changes resulting in system outage. However, that outage should not occur at a significantly greater rate than the designed long-term performance. Consult the path design engineer for more information about link reliability expectations and anticipated RSL deviation.

In addition, regular inspection of the transmission system (RF cables and antennas) and paying close attention to changes along the path, such as construction or tree height, or new microwave radio installations nearby, can be extremely helpful and proactive.

When link performance is very poor, alarms on the radio front panel and within the radio's management system indicates particular failures. Consult this manual for more information on the specific alarms and diagnostics, or contact Exalt Customer Care for assistance.

Exalt Customer Care is primarily motivated to determine if the radio hardware is faulty and require return for repair, and to help execute an effective and efficient repair and return process for radio terminals believed to be faulty. However, Exalt Customer Care provides advice regarding the total radio system and RF path engineering and environment, and advises on troubleshooting.

End users should first contact the installer and/or designer of the system. In many cases, an in-depth understanding of RF design is required, and on-site analysis and special test equipment, may be necessary. Compared to phone support from Exalt Customer Care, troubleshooting is much more expeditious if the professional installer and/or link designer examines the system and reviews the management information in the GUI. In turn, if the professional installer and/or link designer contacts Exalt Customer Care, the process to rectify the system is much more expedient due to the in-depth knowledge related to the implementation and the RF environment.

## **Improper RF Cable Termination**

Improper RF cable termination is a very common problem. In many cases, this is a problem that occurs during installation and is not a problem that suddenly appears. However, if cables are moved or flexed, especially near the termination points, and radio errors, changes in RSL, or other performance issues occur, this is a certain sign of this issue.

Another relatively easy method to test for this condition is to decrease the output power of the radio system (at each end, one end at a time). A poor RF cable termination may be reflecting too much RF energy back into the radio system, and reducing output power reduces the reflected energy at a faster rate than the transmitted energy towards the far end. Be careful not to reduce the output power to the point where the radio's threshold is reached. Typically, a reduction of just 3 to 6dB is enough to determine if this is the issue. If the reduction of output power clears the error condition, this is the likely cause.

Use a reflectometer or meter that can read VSWR at the operating frequency to identify poor terminations as well as poor antenna feeds.



**Note:** The Praxsyst VSWR meter is an excellent tool for this purpose.

---

## **Multipath Propagation**

Multipath propagation is a term that encompasses changes to the RF path, such as reflections and/or refraction, causing partial or complete destruction of the radio signal, and thus excessive bit errors and/or system outages.

Rapid changes in temperature, inversion layers, humidity, air pressure, water evaporation, as well as standing water or moisture on objects along the path are all examples of changes that can cause multipath propagation. New building construction near either end of the path or along the path can cause new reflection characteristics.

If your system has been operating without issue and is suddenly experiencing issues that are symptomatic of a certain time of day or related to change in climatic events or some of the external factors listed above, this is likely the cause. Consult a professional RF path engineer in these cases. Often, minor repositioning of the antennas at either or both ends can reduce or eliminate these problems.

## **RF Interference**

RF interference is usually indicative of another radio system nearby either end of your radio system or aimed towards one or both ends of your radio system – usually at or near the same frequency and usually with a similar signal level.

Other forms of RF interference also exist, such as electronic equipment placed close to the radio chassis or transmitters that couple onto the cabling or grounding system of the radio. Microwave ovens and wireless communication devices used near the equipment or cabling are examples of electronic equipment interference.



**Note:** Exalt Digital Microwave Radios operate in license-exempt bands. Microwave ovens, wireless Internet devices and cordless phone technology may also use this frequency band. It may be necessary to separate the radio chassis, cabling system and antenna from these devices.

RF interference, like most other causes of problems, is indicated by significant bit errors and/or system outages.

One means to determine presence of interference is the use of a spectrum analyzer that covers the same range as the radio system. A professional RF engineer can use a spectrum analyzer to locate sources of interference, measure these sources, and determine potential remedies to take to operate in the presence of interference.

If a spectrum analyzer is not available, the radio's RSL port can help determine RSL levels of interfering signals. By turning the far-end radio off, the residual RSL measured by the radio indicates the level of interference seen by the radio. It is possible that interference levels below that which can be measured still have an impact on the radio system – especially if the radio system has low fade margin or is using a high order modulation.

Exalt Digital Microwave Radios provides considerable flexibility to tune to different frequencies across the bands within which they operate. This is the easiest method to use to try to avoid existing interference. In addition, the occupied bandwidth of the radio can be reduced. This, along with re-tuning, can be very effective, however throughput is reduced.

Repositioning the antenna and/or changing polarization, or upgrading the antenna to a higher gain, and/or using a high-performance antenna, are all secondary means that can be used. It may be necessary to perform combinations of both radio changes (retuning, occupied bandwidth reduction) and antenna system changes (position, polarization, upgrade).

## ***Path Obstruction***

A path obstruction is defined as an object, such as a building or tree, impeding the proper path of the radio system. If the system design was proper at the time of installation and issues arise at a later date, an updated path profile and survey may be necessary to identify changes in path clearance.

## ***Misaligned Antenna***

At the time of initial installation, it is critical that the antennas at each end are properly aligned and that the designed RSL is achieved. However, antennas may become misaligned due to high winds, changes in the guy-wiring systems keeping the antenna mast stable, or loosening of the antenna mounting hardware. A reduction in the RSL of the link is symptomatic of this condition, but this condition is not the only condition that results in a reduction of RSL. However, if conditions occur where the antenna alignment may be suspected, the mechanics must be inspected and the antennas realigned.

## ***Faulty Antenna (connectorized antenna rc-models only)***

A faulty antenna is rare, but is still a possibility. In some cases, the mechanics of the antenna feed can get moisture inside, or a bad or weak connection in the pin and connector structure of the antenna may occur. A VSWR measurement of the antenna connection can be made to verify this condition.

## ***Improper Grounding***

In addition to being a potential human safety issue, improper system grounding is a somewhat common condition that can cause continuous bit errors or bit errors when metal objects come in

contact with the radio, transmission system, or racking system. If touching the radio causes errors, grounding is the cause. It can be difficult to identify grounding problems, but a professional electrician can normally inspect a system and identify if there are deficiencies in the grounding system.

### ***Insufficient Link Margin***

Ideally, the link was designed with enough link margin (fade margin) to allow for multipath propagation and atmospheric fading and still remain reliable. In some cases, link margin is compromised by economic factors, such as using low-cost RF cabling or lower-cost antennas that have less gain or deficient performance compared to higher cost transmission system components. In some cases, there may be antenna size restrictions that forced the design to not have the desired amount of link margin.

If the link was designed with poor link margin, there are likely many cases of bit errors and outages. The antenna system and transmission line can be upgraded to help reduce this. If the link design was installed with sufficient margin, but RSL is reduced, the remaining link margin may no longer be enough to maintain a reliable link. The causes of RSL reduction were previously described, but are usually due to new path obstruction(s) or antenna misalignment due to wind or mechanical factors. The antenna height or location can be changed to overcome new obstructions. Realignment of the antenna, and/or improvement to mechanical structures can help overcome antenna misalignment.

### ***Moisture in the Transmission System***

If the connectors on cables and antennas and egress junctions are not properly weatherproofed, moisture can get into the transmission system and cause significant error conditions and erratic performance. In many cases, the transmission system must be replaced. A VSWR meter is one means to identify such issues. Conduct physical inspections often. If changes to the weatherproofing (such as cracking) are noticed, replace the weatherproofing before leakage occurs.

## Back-to-back Bench Testing

Use back-to-back bench testing to test the radio before installation, pre-configure the radio and connected equipment before installation, or in the troubleshooting process to identify if the radio hardware is the source of a system issue. It is a critical process, and often required or highly desirable for any installation or troubleshooting exercise. This section describes how to properly configure the radio hardware and accessories for a proper back-to-back bench test.

For radio testing, there are two types of back-to-back configurations:

- 1 Basic test (test general operation)
- 2 Specification performance verification

### Basic Test

The basic test is a simple test of radio functionality. It verifies that the radios are properly configured to communicate to one another, and verifies general radio performance as operational.

For the basic test, the following items are needed:

- Radio pair
- Powering source
- RF interconnect cable(s) (any length – short is best)
- Fixed or variable attenuation, between 60 and 90dB (note: attenuation for basic test does not to be calibrated or precise)
- Computer/terminal with Ethernet port

Connect the items as follows:

- 1 Connect attenuation and (known-good) RF cable(s) between radio pair, shown in Figure 41.
- 2 Configure one radio as Radio A/Hub; the other as Radio B/Sub
- 3 Power on radio pair

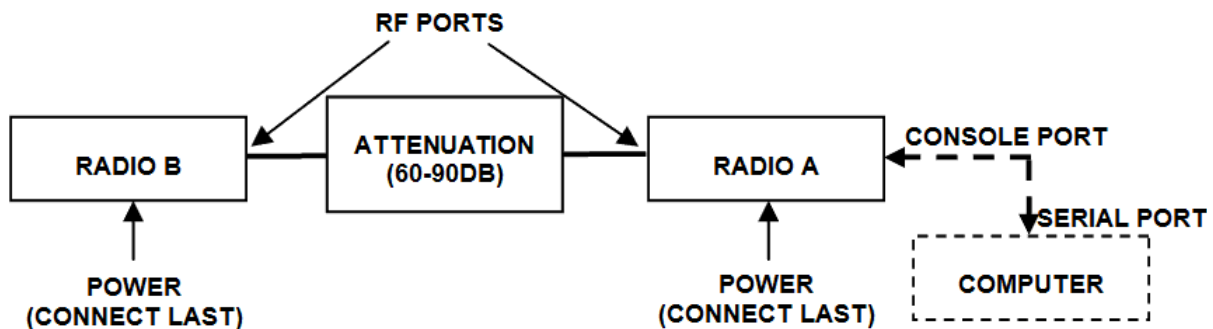

Figure 41 Basic back-to-back bench test configuration

After connecting and powering on, observe the front panel LEDs to verify that the LINK and STATUS LEDs are green. If so, the radios are communicating and all radio-related alarm conditions are normal.

It can be beneficial to have a computer to verify configuration in case of red LEDs or to pre-configure the radio as desired for operation. Follow the instructions in [Configuration and Management](#).

## Specification Performance Verification

The specification performance verification is a more detailed test that allows you to verify that the radio's output power and threshold specifications are being met. This is typically a test that would only be performed in a troubleshooting scenario, but can be performed before installation to provide a detailed record or ensure radio performance before installation.

This test is identical to the basic test, but in place of the fixed attenuation, it requires the use of calibrated variable attenuation, or a set of calibrated fixed attenuators, or a combination of both, adding to a total attenuation value of 120dB, as measured at the operating frequency of the radio. In addition, a volt meter or computer is also required.

Connect the system as shown in Figure 41, using the combination of fixed and variable attenuation between the radio's RF ports. Connect the volt meter to either radio's RSL test point and associated reference ground connection.

In this test, it is desirable to use pre-tested RF cables, known to be good, and the insertion loss is known at the operating frequency. If the cables are short (6'/2m or less), you can estimate the loss, including connectors, to be less than 1dB each. The estimate of cable loss is critical to the overall confidence of the measurements made in this test.

There are two critical specifications that can be tested in this configuration:

- RF output power
- Radio receiver threshold

To measure transmitter output power, simply insert any value of attenuation between the radios between 60 and 90dB. Ensure that both RF output power settings are at maximum. Use the volt meter to measure RSL in both directions. The RSL measured value should match the appropriate value according to the inserted attenuation, such as:

$$\text{RSL} = \text{RF Output Power} - \text{cabling losses} - \text{total attenuation}$$

Verify output power by adjusting output power using the Exalt GUI (in administration mode) and evaluate the corresponding change to the RSL measurement.

For threshold testing, the key is to insert a measured amount of loss that is close to, but not exceeding the radio's specified system gain. System gain is the difference between RF output power and receiver threshold. At your selected modulation and bandwidth settings, determine the specified threshold performance, and choose a value of attenuation (including cable losses) that adds to roughly 5 to 15dB less than the system gain.

For example, if the threshold for your measurement is -85dBm, the output power is +27dBm, so the system gain is 112dB. Choose a value of total attenuation in the range of roughly 100–105dB. Once this attenuation is inserted, verify RSL readings as in the first step, and then, using the GUI, reduce radio output power in 1dB steps until the receiving radio (the one whose output power not being adjusted) Link LED turns from green to yellow. This indicates that threshold has been reached. At this point, verify the equation for system gain using the new output power level setting and verify that the threshold performance is meeting or exceeding the published specification.



**Note:** Due to the variation of measurements and accuracies involved in this test, you may read a measurement that is 1dB to as much as 2dB off of the expected value. It should be of no concern unless the value is more than 3dB worse than expected.

---

## **General Compliance and Safety**

The usage of radio transmission devices is subject to specific regulatory requirements governed by regional legislation. In most cases, the specific device must be authorized for use in a given country and must be installed and adjusted in accordance with specific radio-frequency settings and in a manner that has been authorized specific to the device itself in accordance with the specific location of the device. Some users may be completely or partially restricted from use of the device. Please consult local governmental agency/agencies for regulatory requirements before use, or contact Exalt or your Exalt authorized dealer for assistance.

Do not modify this device in any way without the express written consent of Exalt. Modification voids the manufacturer warranty, and may also be illegal in accordance to government regulations. In addition, there are no user-serviceable parts or assemblies inside the product housing. There may also be voltages, signals, and mechanisms within the device that could be harmful to human safety.

The mounting of this device and associated peripherals and connections (inclusive of antenna mast, antenna, cabling, egress, lightning protection devices, grounding, power, and so on) may be subject to regional requirements for health and human safety. A qualified professional installer and an electrician are highly recommended, and may be required by law.

## **Dynamic Frequency Selection**

Dynamic Frequency Selection (DFS) may be required by regional regulation in some frequency bands to avoid causing interference to radar systems. Prior to the start of any transmission, devices equipped with DFS monitor the spectrum and are not permitted to transmit on any frequency in use for radar transmissions for a period of 30 minutes, during which time the frequency will not be available and the link will be dropped.

During operation of the device, the spectrum is continually monitored by DFS to detect radar transmissions on the operating frequency. If radar transmissions are detected, the device must drop the channel within a specified time period so as not to cause interference with the radar transmission. Devices equipped with DFS are required to stay off that part of the spectrum for a minimum of 30 minutes, after which time the device may then re-check the spectrum for radar transmissions and begin transmitting if no radar is detected.



## **Safety Notices**

- 1 Review this entire guide for important installation instructions BEFORE attempting to install this product.
- 2 This product is intended to be installed, used, and maintained by experienced telecommunications personnel only.
- 3 Employ a properly licensed or authorized electrician to install or evaluate/certify the installation of all power and grounding related to the use of this equipment and all connected devices.
- 4 The device(s) shall only be connected to AC power sources provided by the supplier or to DC sources within the device specifications. Use a separate breaker circuit at the power source.
- 5 Lightning, surge protection devices, and earth grounding are required for most installations to ensure human safety. Consult a qualified electrician.
- 6 Servicing of this device should be performed by authorized personnel only. Do not disassemble this device. By opening or removing any covers you may expose yourself to hazardous energy parts. Incorrect reassembly of this product can cause a malfunction, and/or electrical shock, when the unit is subsequently used.
- 7 Do not connect or disconnect the power connection to the device when the power supply is plugged into an AC outlet. To connect, first connect the power connection to the device, and then apply power (or plug in) at the outlet. To disconnect, disengage power at the outlet or unplug, and then disconnect the direct connection to the device.
- 8 Do not insert any object of any shape or size inside this product at any time, whether powered or not. Objects may contact hazardous energy components that could result in a risk of fire or personal injury.
- 9 Liquids shall not come in contact with, or enter the inside of the device at any time.
- 10 Proper ventilation and/or airflow shall be provided surrounding the equipment. Items shall not come in contact with heat-sinking materials. Ensure that ambient operational and storage temperature specifications are maintained at all times.
- 11 Equipment is suitable for mounting on noncombustible surfaces only.
- 12 Do not move or alter the marking labels.
- 13 A CSU or similar isolating device is necessary between the equipment and the public telecommunications network. The equipment has not been evaluated for direct connection to the public telecommunications network.

## **Regulatory Notices**

### ***United States Compliance***

When operating in the 4940–4990 MHz band, the ExtendAir eMIMO and ExpandAir Series models (regulatory model name/number eMIMO 100) are licensed-band products operating within Part 90 Subpart Y of the FCC regulations. This band is specifically reserved for Public Safety applications and related agencies, in accordance with these regulations.

Transmitter power reduction may be required, depending on transmission system gains and losses, in accordance with instructions found in this appendix.

When operating in the 5250-5850MHz bands, the ExtendAir eMIMO and ExpandAir Series models (regulatory model name/number eMIMO 100) operate under FCC Rule Part 15.407 as a license-exempt device. They may be used as a point-to-point or point-to-multipoint transmission device for fixed or temporary-fixed (non-mobile) installations. The devices are subject to the following restrictions:

- Do not use external amplifiers to boost the power or overcome transmission system losses, unless the specific amplifier/cable/antenna combination has expressly been authorized by the FCC.
- Cross-border transmissions are expressly prohibited, except with written permission from both the FCC and the governing body of the neighboring country (Cofetel for Mexico; Industry Canada for Canada).
- Use only parabolic dish antennas, directional flat-panel, or omni-directional antennas. No other types of antennas are authorized. Parabolic dishes of either grid or solid type are allowed.
- Antenna gains between 9dBi and 37.9dBi are permitted. The maximal effective antenna gain including transmission cable loss must not exceed 28dBi.

### **Federal Communications Commission (FCC), United States**

The device is allowed to be used provided it does not cause interference to other devices. It is not guaranteed to provide protection against interference from other electronic and radio devices.

The system has been tested and found to comply with the limits of a class B digital device, pursuant to Part 15 of the FCC Rules. These limits are designed to provide reasonable protection against harmful interference in a residential installation. This equipment generates uses and can radiate radio frequency energy and, if not installed and used in accordance with the instructions, may cause harmful interference to radio communications. However, there is no guarantee that interference will not occur in a particular installation. If this equipment does cause harmful interference to radio or television reception, which can be determined by turning the equipment off and on, the user is encouraged to try to correct the interference by one of more of the following measures:

- Reorient or relocate the receiving antenna.
- Increase the separation between the equipment and receiver.
- Connect the equipment into an outlet on a circuit different from that to which the receiver is connected.
- Consult the dealer or an experienced radio/TV technician for help.

Shielded cables and I/O cords must be used for this equipment to comply with the relevant FCC regulations.

Changes or modifications not expressly approved in writing by Exalt may void the user's authority to operate this equipment.

**This device must be professionally installed.**

To comply with regulations, the output power of this device may need to be adjusted in accordance to the associated transmission system. See [RF Output Power Setting](#) for details.

The antenna associated with this device shall be mounted in a location that is at least 10.5'/3.2m away from humans that may be subject to long-term or continuous exposure.

## **Canada Compliance**

When operating in the 4940–4990 MHz band, the ExtendAir eMIMO and ExpandAir Series models (regulatory model name/number eMIMO 100) are licensed-band products operating within RSS-111 of Industry Canada regulations. This band is specifically reserved for Public Safety applications and related agencies, in accordance with these regulations.

Transmitter power reduction may be required, depending on transmission system gains and losses, in accordance with instructions found in this appendix.

When operating in the 5250-5850MHz bands, the ExtendAir eMIMO and ExpandAir Series models (regulatory model name/number eMIMO 100) operate under RSS-210 of Industry Canada regulations. Operation is subject to the following conditions, unless express permission is granted by Industry Canada to operate in a different manner:

- External amplifiers cannot be used to boost the power or to overcome transmission system losses, unless the specific amplifier/cable/antenna combination is expressly authorized by Industry Canada.
- Cross-border transmissions are expressly prohibited, except with written permission from both Industry Canada and the governing body of the neighboring country (FCC for USA)
- Only parabolic dish antennas, directional flat-panel, or omni-directional antennas may be used. No other types of antennas are authorized. Parabolic dishes of either grid or solid type are allowed.
- Antenna gains between 9dBi and 37.9dBi are permitted. The maximal effective antenna gain including transmission cable loss must not exceed 28dBi.

## **Industry Canada (IC), Canada**

This Class B Digital apparatus meets all the requirements of the Canadian Interference-Causing Equipment Regulations.

Cet appareil numérique de la classe B respecte les exigences du Règlement sur le matériel brouilleur du Canada.

This device complies with RSS-210 of Industry Canada. Operation is subject to the following two conditions:

- 1 this device may not cause interference, and
- 2 this device must accept any interference, including interference that may cause undesired operation of the device.

## **Antennas Supported in Canada**

The ExtendAir eMIMO and ExpandAir Series models (regulatory model name/number eMIMO 100) are designed to operate with the antennas listed in [Table 7](#) and [Table 6](#), which have a maximum gain of

37.9dBi. Antennas not included in the list or having a gain greater than 37.9dBi are strictly prohibited for use with this device. The required antenna impedance is 50 Ohms.

## **Europe and ITU Country Compliance**

All of these permitted devices must be professionally installed. They can only be used as a point-to-point or point-to-multipoint transmission device for fixed or temporary-fixed (non-mobile) installations.



**Note:** Do not use external amplifiers to boost the power or overcome transmission system losses, unless the specific amplifier/cable/antenna combination has expressly been authorized by the specific country regulations. The output power must never exceed that specified in [Specifications–ExtendAir Models](#).

The ExtendAir eMIMO and ExpandAir Series 50xx models operate under EN 301 893 and EN 302 502 rules as a license-exempt device.

The ExtendAir eMIMO and ExpandAir Series 50xx models comply with ETS 301 893 for the 5.3 and 5.47 GHz bands for license-exempt use for most countries recognizing ETSI or ITU band assignments. This band is not yet harmonized for all countries recognizing ETSI or ITU band assignments. These bands require Dynamic Frequency Selection (DFS) and Transmitter Power Control (TPC) for radar-detection and avoidance. There is a +30dBm EIRP limit applied to this band. Transmitter power must be adjusted accordingly with respect to the RF cabling losses and antenna gains associated with each terminal.

The ExtendAir eMIMO and ExpandAir Series 50xx models comply with ETS 302 502 for the 5.8 GHz band. This band is not yet harmonized for all countries recognizing ETSI or ITU band assignments. Consult the individual country regulations or your Exalt representative for details. This band requires DFS and TPC for radar-detection and avoidance. There is a +33dBm EIRP limit for use of the 10 MHz BW setting, and a +36dBm EIRP limit for use of the 20 MHz BW setting. Some countries limit the EIRP to +5dBm for all bandwidths in this band.

All models comply with the requirements for CE Mark (EN 60950-1 and IEC 60950-1) and EMC (EN 301 489-17). No substitutions shall be made, and all wiring and grounding instructions contained in this manual must be followed to ensure safety in accordance to the standards and local rules.

## Regulatory Compliance

As of this printing, Exalt Wireless, Inc. has approvals for the products that are covered by this manual, as indicated in Table 8. If your application or country is not listed, check with your Sales Representative for the current status.

Notations are as follows: ✓ indicates approved; (✓) indicates in-process; \* indicates consult Exalt Wireless for availability.

Table 8 Product Approvals (Exalt)

Country	4.9GHz	5.3GHz	5.4GHz	5.8GHz
Austria				
Australia				
Belgium				
Brazil				
Bulgaria				
Canada	✓	(✓)	(✓)	✓
Cyprus				
Czech Republic				
Denmark				
Estonia				
Finland				
France				
Germany				
Great Britain				
Greece				
Hungary				
Iceland				
Ireland				
Italy				
Latvia				
Liechtenstein				
Lithuania				
Luxembourg				
Malta				
Mexico				

*Table 8 Product Approvals (Exalt) (Continued)*

<b>Country</b>	<b>4.9GHz</b>	<b>5.3GHz</b>	<b>5.4GHz</b>	<b>5.8GHz</b>
Netherlands				
Norway				
Philippines				
Poland				
Portugal				
Romania				
Slovak Republic				
Slovenia				
Spain				
Sweden				
Switzerland				
Thailand				
UAE				
United States	✓	(✓)	(✓)	✓

## EIRP Limits for the United States and Canada



**Note:** The professional installer is responsible to ensure that RF output power is properly adjusted to not exceed the regulatory limit.

### *EIRP for the USA and Canada*

#### **4940–4990 MHz Band**

For ExtendAir eMIMO and ExpandAir Series (regulatory model name/number eMIMO 100) operating within the 4940–4990 MHz band, the maximum EIRP allowed is +46dBm. The maximum output power of the radio shall never exceed +20dBm.

The transmit power must be reduced from maximum by 1 dB for every 1dB that the antenna gain exceeds 26dBi (including transmission system losses)

#### **5250–5350 MHz Band**

For operation within the 5250–5350 MHz band, the maximum EIRP is 30 dBm. The maximum output of the radio is +21 dBm.

$$P = 30 - G + L$$

where:

- $P =$  Maximum transmitter output power of radio, in dBm.
- $G =$  Specified gain of antenna, in dBi, from 5250 to 5350 MHz.
- $L =$  Total transmission system losses of all elements between the radio's RF connector and the antenna's RF connector (all cables, connectors, lightning suppressors), in dB, as specified or measured between 5250 and 5350 MHz.

#### **5470–5725 MHz Band**

For operation within the 5470–5725 MHz band, the maximum EIRP allowed is 30 dBm. The maximum output power of the radio is +21 dBm.

$$P = 30 - G + L$$

where:

- $P =$  Maximum transmitter output power of radio, in dBm.
- $G =$  Specified gain of antenna, in dBi, from 5470 to 5725 MHz.
- $L =$  Total transmission system losses of all elements between the radio's RF connector and the antenna's RF connector (all cables, connectors, lightning suppressors), in dB, as specified or measured between 5470 and 5725 MHz.

## **5725–5850 MHz Band**

For operation within the 5725–5850 MHz band, the maximum EIRP allowed is 61.9 dBm. The maximum output power of the radio is +28 dBm

$$P = 61.9 - G + L$$

where:

- P* = Maximum transmitter output power of radio, in dBm.
- G* = Specified gain of antenna, in dBi, from 5725 to 5850 MHz.
- L* = Total transmission system losses of all elements between the radio's RF connector and the antenna's RF connector (all cables, connectors, lightning suppressors), in dB, as specified or measured between 5725 and 5850 MHz.



## EIRP Limits for Australia



**Note:** The professional installer is responsible to ensure that RF output power is properly adjusted to not exceed the regulatory limit.

### 5470–5725 MHz Band



**Note:** Australian regulations have a no-transmit band from 5600–5650 MHz, adjust the transmitter to avoid this range.

For ExtendAir eMIMO and ExpandAir Series (regulatory model name/number eMIMO 100) models within the 5470–5725 MHz band, the maximum EIRP allowed is 30 dBm. The maximum output power of the radio is +21 dBm.

$$P = 30 - G + L$$

where:

- $P =$  Maximum transmitter output power of radio, in dBm.
- $G =$  Specified gain of antenna, in dBi, from 5470 to 5725 MHz.
- $L =$  Total transmission system losses of all elements between the radio's RF connector and the antenna's RF connector (all cables, connectors, lightning suppressors), in dB, as specified or measured between 5470 and 5725 MHz.

### 5725–5850 MHz Band

For ExtendAir eMIMO and ExpandAir Series (regulatory model name/number eMIMO 100) models within the 5725–5850 MHz band, the maximum EIRP allowed is 36 dBm. The maximum output power of the radio is +28 dBm.

$$P = 36 - G + L$$

where:

- $P =$  Maximum transmitter output power of radio, in dBm.
- $G =$  Specified gain of antenna, in dBi, from 5725 to 5850 MHz.
- $L =$  Total transmission system losses of all elements between the radio's RF connector and the antenna's RF connector (all cables, connectors, lightning suppressors), in dB, as specified or measured between 5725 and 5850 MHz.

## EIRP Limits for the European Union and ITU Countries

The countries that are covered by this Regulatory Domain are: Austria, Belgium, Cyprus, Czech Republic, Denmark, Estonia, Finland, France, Germany, Ghana, Great Britain, Greece, Hungary, Iceland, Ireland, Italy, Latvia, Liechtenstein, Lithuania, Luxembourg, Malta, Norway, Poland, Portugal, Slovak Republic, Slovenia, Spain, Sweden, Netherlands, Switzerland, and Turkey.



**Note:** The professional installer is responsible to ensure that RF output power is properly adjusted to not exceed the regulatory limit.

- Use only parabolic dish antennas, directional flat-panel, or omni-directional antennas. No other types of antennas are authorized. Parabolic dishes of either grid or solid type are allowed.
- Antenna gains between 9dBi and 37.9dBi are permitted. The maximal effective antenna gain including transmission cable loss must not exceed 28dBi.

### 50xx Series EIRP

Table 9 summarizes the maximum power by band and country for ExtendAir eMIMO and ExpandAir Series radios.

#### 5250–5350 MHz band

For all models within the 5250–5350 MHz band, the maximum EIRP is specified in Table 9. The maximum output of the radio is +21 dBm.

$$P = ME - G + L$$

where:

- $P$  = Maximum transmitter output power of radio, in dBm.  
 $ME$  = Maximum EIRP, as specified in Table 9.  
 $G$  = Specified gain of antenna, in dBi, from 5250 to 5350 MHz.  
 $L$  = Total transmission system losses of all elements between the radio's RF connector and the antenna's RF connector (all cables, connectors, lightning suppressors), in dB, as specified or measured between 5250 and 5350 MHz.

#### 5470–5725 MHz band

For all models within the 5470–5725 MHz band, the maximum EIRP allowed is specified in Table 9. The maximum output power of the radio is +21 dBm.

$$P = ME - G + L$$

where:

- $P$  = Maximum transmitter output power of radio, in dBm.  
 $ME$  = Maximum EIRP, as specified in Table 9.  
 $G$  = Specified gain of antenna, in dBi, from 5470 to 5725 MHz.  
 $L$  = Total transmission system losses of all elements between the radio's RF connector and the antenna's RF connector (all cables, connectors, lightning suppressors), in dB, as specified or measured between 5470 and 5725 MHz.

## 5725–5850 MHz band

For all models within the 5725–5850 MHz band, the maximum transmit power with respect to specific country EIRP regulations is determined based on the channel bandwidth. The EIRP power limit is specified in Table 9. The ExtendAir eMIMO and ExpandAir Series radios (regulatory model name/number eMIMO 100) maximum transmitter conducted power is +28 dBm. Use the following equation to determine the maximum transmitter power for the radio:

$$P = ME - G + L$$

where:

- $P =$  Maximum transmitter output power of radio, in dBm.
- $ME =$  Maximum EIRP, as specified in Table 9.
- $G =$  Specified gain of antenna, in dBi, from 5725 to 5850 MHz.
- $L =$  Total transmission system losses of all elements between the radio's RF connector and the antenna's RF connector (all cables, connectors, lightning suppressors), in dB, as specified or measured between 5725 and 5850 MHz.

*Table 9 EU and ITU Country Specific EIRP Levels*

<b>Country</b>	<b>Maximum EIRP 5.3 GHz band</b>	<b>Maximum EIRP 5.4 GHz band</b>	<b>Maximum EIRP 5.8 GHz band (BW dependent)<sup>a</sup></b>
Austria	23 dBm	30 dBm	5 dBm
Belgium		30 dBm	
Cyprus	23 dBm	30 dBm	
Czech	23 dBm	30 dBm	33/36 dBm
Denmark	23 dBm	30 dBm	33/36 dBm
Estonia	23 dBm	30 dBm	
Finland	23 dBm	30 dBm	
France	23 dBm	30 dBm	33/36 dBm
Germany	23 dBm	30 dBm	33/36 dBm
Ghana	23 dBm	30 dBm	33/36 dBm
Great	23 dBm	30 dBm	33/36 dBm
Hungary	23 dBm	30 dBm	33/36 dBm
Iceland	23 dBm	30 dBm	33/36 dBm
Ireland	23 dBm	30 dBm	33/36 dBm
Italy	23 dBm	30 dBm	33/36 dBm
Liechtens	23 dBm	30 dBm	5 dBm
Lithuania	23 dBm	30 dBm	33/36 dBm
Luxembo	23 dBm	30 dBm	
Netherla	23 dBm	30 dBm	33/36 dBm
Norway	23 dBm	30 dBm	33/36 dBm
Poland	23 dBm	30 dBm	33/36 dBm
Portugal	23 dBm	30 dBm	5 dBm
Romania	23 dBm	30 dBm	33/36 dBm
Slovak	23 dBm	30 dBm	5 dBm
Slovenia	23 dBm	30 dBm	
Spain	23 dBm	30 dBm	33/36 dBm
Sweden	23 dBm	30 dBm	33/36 dBm
Switzerla	23 dBm	30 dBm	5 dBm
Turkey	23 dBm	30 dBm	33/36 dBm

a. If the output power is designated as 33/36 dBm, the EIRP is limited to 33 dBm for 10 MHz bandwidth transmissions and 36 dBm for 20 MHz bandwidth transmissions.

## Declaration of Conformity to the R&TTE Directive 1999/ 5/ EC

English:	This equipment is in compliance with the essential requirements and other relevant provisions of Directive 1999/5/EC.
Deutsch:	Dieses Gerät entspricht den grundlegenden Anforderungen und den weiteren entsprechenden Vorgaben der Richtlinie 1999/5/EU.
Dansk:	Denne udstyr er i overensstemmelse med de væsentlige krav og andre relevante bestemmelser i Direktiv 1999/5/EF.
Español:	Este equipo cumple con los requisitos esenciales así como con otras disposiciones de la Directiva 1999/5/EC.
Ελληνικά:	Αυτός ο εξοπλισμός είναι σε συμμόρφωση με τις ουσιώδεις απαιτήσεις και άλλες σχετικές διατάξεις της Οδηγίας 1999/5/EC.
Français:	Cet appareil est conforme aux exigences essentielles et aux autres dispositions pertinentes de la Directive 1999/5/EC.
Íslenska:	Þessi búnaður samrýmist lögbodnum kröfum og öðrum ákvæðum tilskipunar 1999/5/ESB.
Italiano:	Questo apparato é conforme ai requisiti essenziali ed agli altri principi sanciti dalla Direttiva 1999/5/EC.
Nederlands:	Deze apparatuur voldoet aan de belangrijkste eisen en andere voorzieningen van richtlijn 1999/5/EC.
Norsk:	Denne utstyret er i samsvar med de grunnleggende krav og andre relevante bestemmelser i EU-direktiv 1999/5/EC.
Português:	Este equipamento satisfaz os requisitos essenciais e outras provisões da Directiva 1999/5/EC.
Suomalainen:	Tämä laite täyttää direktiivin 1999/5/EY oleelliset vaatimukset ja on siinä asetettujen muidenkin ehtojen mukainen.
Svenska:	Denna utrustning är i överensstämmelse med de väsentliga kraven och andra relevanta bestämmelser i Direktiv 1999/5/EC.

For 5 GHz radios, the following standards were applied:

- Radio: EN 301 893, EN 302 502
- EMC: EN 301 489-1, EN 301 489-17
- Safety: EN 60950-1, IEC 60950-1

The following CE mark is affixed to the product:



### **EU WEEE**

Exalt is committed to meeting the requirements of the European Union's Waste Electrical and Electronic Equipment (WEEE) Directive. The Directives require producers of electrical and electronic equipment to finance the take-back for re-use or recycling of their products placed on the EU market after 13 August 2005.

Exalt products that are within the scope of the Directives are labeled with a crossed-out "wheelie-bin" symbol as required by the Directives. This indicates that the product was placed on the market after 13 August 2005 and that end-users should segregate the product from other wastes at end-of-life.

The WEEE Directives are being implemented in each of the 28 EU and European Economic Area (EAA) countries through national legislation. This has resulted in considerable variation in the detailed requirements across the EU, many of which require presence in the EU. As a result, Exalt's WEEE compliance approach is to require the distributors and/or resellers in the EU to comply with each country's national legislation by registration of the distributor or reseller as the producer and for the reseller/distributor to carry out and fulfill the legislative requirements of each national compliance scheme.

Below is the crossed out wheelie bin symbol as required by the WEEE Directive.



## ***EU RoHS***

RoHS is the acronym used to refer to the European Union (EU) Directive 2002/95/EC on the Restriction of the use of certain hazardous substances in electrical and electronic equipment. Hazardous materials are those chemicals and substances that are legislatively, market, or customer banned or restricted for use in products and/or manufacturing. There are six (6) RoHS substances: lead (Pb), cadmium (Cd), mercury (Hg), hexavalent chromium (Cr+6), polybrominated biphenyls (PBB) and polybrominated diphenylethers (PBDE). Other countries may be introducing legislation that results in similar restrictions of hazardous substances. Many Exalt products will continue to use lead-based solder under the exemption allowed for network infrastructure equipment. Small amounts of lead, cadmium, mercury, hexavalent chromium, PBB, and PBDE can also be found in a few electrical and electrical components.

## Copyright Notices

This section presents copyright notices for third-party software licensed to Exalt Wireless, Inc.

### Net-SNMP

The following copyright notice applies to the open-source licensing agreement for Net-SNMP.

Copyright 1989, 1991, 1992 by Carnegie Mellon University

Derivative Work - 1996, 1998-2000

Copyright 1996, 1998-2000 The Regents of the University of California

All Rights Reserved

Permission to use, copy, modify and distribute this software and its documentation for any purpose and without fee is hereby granted, provided that the above copyright notice appears in all copies and that both that copyright notice and this permission notice appear in supporting documentation, and that the name of CMU and The Regents of the University of California not be used in advertising or publicity pertaining to distribution of the software without specific written permission.

CMU AND THE REGENTS OF THE UNIVERSITY OF CALIFORNIA DISCLAIM ALL WARRANTIES WITH REGARD TO THIS SOFTWARE, INCLUDING ALL IMPLIED WARRANTIES OF MERCHANTABILITY AND FITNESS. IN NO EVENT SHALL CMU OR THE REGENTS OF THE UNIVERSITY OF CALIFORNIA BE LIABLE FOR ANY SPECIAL, INDIRECT OR CONSEQUENTIAL DAMAGES OR ANY DAMAGES WHATSOEVER RESULTING FROM THE LOSS OF USE, DATA OR PROFITS, WHETHER IN AN ACTION OF CONTRACT, NEGLIGENCE OR OTHER TORTIOUS ACTION, ARISING OUT OF OR IN CONNECTION WITH THE USE OR PERFORMANCE OF THIS SOFTWARE.

Network Associates Technology, Inc.

Copyright (c) 2001-2003, Networks Associates Technology, Inc

All rights reserved.

Redistribution and use in source and binary forms, with or without modification, are permitted provided that the following conditions are met:

- \* Redistributions of source code must retain the above copyright notice, this list of conditions and the following disclaimer.
- \* Redistributions in binary form must reproduce the above copyright notice, this list of conditions and the following disclaimer in the documentation and/or other materials provided with the distribution.
- \* Neither the name of the Networks Associates Technology, Inc nor the names of its contributors may be used to endorse or promote products derived from this software without specific prior written permission.

THIS SOFTWARE IS PROVIDED BY THE COPYRIGHT HOLDERS AND CONTRIBUTORS "AS IS" AND ANY EXPRESS OR IMPLIED WARRANTIES, INCLUDING, BUT NOT LIMITED TO, THE IMPLIED WARRANTIES OF MERCHANTABILITY AND FITNESS FOR A PARTICULAR PURPOSE ARE DISCLAIMED. IN NO EVENT SHALL THE COPYRIGHT HOLDERS OR CONTRIBUTORS BE LIABLE FOR ANY DIRECT, INDIRECT, INCIDENTAL, SPECIAL, EXEMPLARY, OR CONSEQUENTIAL DAMAGES (INCLUDING, BUT NOT LIMITED TO, PROCUREMENT OF SUBSTITUTE GOODS OR SERVICES; LOSS OF USE, DATA, OR PROFITS; OR BUSINESS INTERRUPTION) HOWEVER CAUSED AND ON ANY THEORY OF LIABILITY, WHETHER IN CONTRACT, STRICT LIABILITY, OR TORT (INCLUDING

NEGLIGENCE OR OTHERWISE) ARISING IN ANY WAY OUT OF THE USE OF THIS SOFTWARE, EVEN IF ADVISED OF THE POSSIBILITY OF SUCH DAMAGE.

Cambridge Broadband, Ltd.

Portions of this code are copyright (c) 2001-2003, Cambridge Broadband Ltd.

All rights reserved.

Redistribution and use in source and binary forms, with or without modification, are permitted provided that the following conditions are met:

- \* Redistributions of source code must retain the above copyright notice, this list of conditions and the following disclaimer.
- \* Redistributions in binary form must reproduce the above copyright notice, this list of conditions and the following disclaimer in the documentation and/or other materials provided with the distribution.
- \* The name of Cambridge Broadband Ltd. may not be used to endorse or promote products derived from this software without specific prior written permission.

THIS SOFTWARE IS PROVIDED BY THE COPYRIGHT HOLDER ``AS IS" AND ANY EXPRESS OR IMPLIED WARRANTIES, INCLUDING, BUT NOT LIMITED TO, THE IMPLIED WARRANTIES OF MERCHANTABILITY AND FITNESS FOR A PARTICULAR PURPOSE ARE DISCLAIMED. IN NO EVENT SHALL THE COPYRIGHT HOLDER BE LIABLE FOR ANY DIRECT, INDIRECT, INCIDENTAL, SPECIAL, EXEMPLARY, OR CONSEQUENTIAL DAMAGES (INCLUDING, BUT NOT LIMITED TO, PROCUREMENT OF SUBSTITUTE GOODS OR SERVICES; LOSS OF USE, DATA, OR PROFITS; OR BUSINESS INTERRUPTION) HOWEVER CAUSED AND ON ANY THEORY OF LIABILITY, WHETHER IN CONTRACT, STRICT LIABILITY, OR TORT (INCLUDING NEGLIGENCE OR OTHERWISE) ARISING IN ANY WAY OUT OF THE USE OF THIS SOFTWARE, EVEN IF ADVISED OF THE POSSIBILITY OF SUCH DAMAGE.

Sun Microsystems, Inc.

Copyright © 2003 Sun Microsystems, Inc., 4150 Network Circle, Santa Clara, California 95054, U.S.A. All rights reserved.

Use is subject to license terms below.

This distribution may include materials developed by third parties.

Sun, Sun Microsystems, the Sun logo and Solaris are trademarks or registered trademarks of Sun Microsystems, Inc. in the U.S. and other countries.

Redistribution and use in source and binary forms, with or without modification, are permitted provided that the following conditions are met:

- \* Redistributions of source code must retain the above copyright notice, this list of conditions and the following disclaimer.
- \* Redistributions in binary form must reproduce the above copyright notice, this list of conditions and the following disclaimer in the documentation and/or other materials provided with the distribution.
- \* Neither the name of the Sun Microsystems, Inc. nor the names of its contributors may be used to endorse or promote products derived from this software without specific prior written permission.

THIS SOFTWARE IS PROVIDED BY THE COPYRIGHT HOLDERS AND CONTRIBUTORS "AS IS" AND ANY EXPRESS OR IMPLIED WARRANTIES, INCLUDING, BUT NOT LIMITED TO, THE IMPLIED WARRANTIES OF MERCHANTABILITY AND FITNESS FOR A PARTICULAR



PURPOSE ARE DISCLAIMED. IN NO EVENT SHALL THE COPYRIGHT HOLDERS OR CONTRIBUTORS BE LIABLE FOR ANY DIRECT, INDIRECT, INCIDENTAL, SPECIAL, EXEMPLARY, OR CONSEQUENTIAL DAMAGES (INCLUDING, BUT NOT LIMITED TO, PROCUREMENT OF SUBSTITUTE GOODS OR SERVICES; LOSS OF USE, DATA, OR PROFITS; OR BUSINESS INTERRUPTION) HOWEVER CAUSED AND ON ANY THEORY OF LIABILITY, WHETHER IN CONTRACT, STRICT LIABILITY, OR TORT (INCLUDING NEGLIGENCE OR OTHERWISE) ARISING IN ANY WAY OUT OF THE USE OF THIS SOFTWARE, EVEN IF ADVISED OF THE POSSIBILITY OF SUCH DAMAGE.

Sparta, Inc.

Copyright (c) 2003-2005, Sparta, Inc

All rights reserved.

Redistribution and use in source and binary forms, with or without modification, are permitted provided that the following conditions are met:

- \* Redistributions of source code must retain the above copyright notice, this list of conditions and the following disclaimer.
- \* Redistributions in binary form must reproduce the above copyright notice, this list of conditions and the following disclaimer in the documentation and/or other materials provided with the distribution.
- \* Neither the name of Sparta, Inc nor the names of its contributors may be used to endorse or promote products derived from this software without specific prior written permission.

THIS SOFTWARE IS PROVIDED BY THE COPYRIGHT HOLDERS AND CONTRIBUTORS "AS IS" AND ANY EXPRESS OR IMPLIED WARRANTIES, INCLUDING, BUT NOT LIMITED TO, THE IMPLIED WARRANTIES OF MERCHANTABILITY AND FITNESS FOR A PARTICULAR PURPOSE ARE DISCLAIMED. IN NO EVENT SHALL THE COPYRIGHT HOLDERS OR CONTRIBUTORS BE LIABLE FOR ANY DIRECT, INDIRECT, INCIDENTAL, SPECIAL, EXEMPLARY, OR CONSEQUENTIAL DAMAGES (INCLUDING, BUT NOT LIMITED TO, PROCUREMENT OF SUBSTITUTE GOODS OR SERVICES; LOSS OF USE, DATA, OR PROFITS; OR BUSINESS INTERRUPTION) HOWEVER CAUSED AND ON ANY THEORY OF LIABILITY, WHETHER IN CONTRACT, STRICT LIABILITY, OR TORT (INCLUDING NEGLIGENCE OR OTHERWISE) ARISING IN ANY WAY OUT OF THE USE OF THIS SOFTWARE, EVEN IF ADVISED OF THE POSSIBILITY OF SUCH DAMAGE.

Cisco, Inc.

Copyright (c) 2004, Cisco, Inc and Information Network

Center of Beijing University of Posts and Telecommunications.

All rights reserved.

Redistribution and use in source and binary forms, with or without modification, are permitted provided that the following conditions are met:

- \* Redistributions of source code must retain the above copyright notice, this list of conditions and the following disclaimer.
- \* Redistributions in binary form must reproduce the above copyright notice, this list of conditions and the following disclaimer in the documentation and/or other materials provided with the distribution.
- \* Neither the name of Cisco, Inc, Beijing University of Posts and Telecommunications, nor the names of their contributors may be used to endorse or promote products derived from this software without specific prior written permission.

THIS SOFTWARE IS PROVIDED BY THE COPYRIGHT HOLDERS AND CONTRIBUTORS "AS IS" AND ANY EXPRESS OR IMPLIED WARRANTIES, INCLUDING, BUT NOT LIMITED TO, THE IMPLIED WARRANTIES OF MERCHANTABILITY AND FITNESS FOR A PARTICULAR PURPOSE ARE DISCLAIMED. IN NO EVENT SHALL THE COPYRIGHT HOLDERS OR CONTRIBUTORS BE LIABLE FOR ANY DIRECT, INDIRECT, INCIDENTAL, SPECIAL, EXEMPLARY, OR CONSEQUENTIAL DAMAGES (INCLUDING, BUT NOT LIMITED TO, PROCUREMENT OF SUBSTITUTE GOODS OR SERVICES; LOSS OF USE, DATA, OR PROFITS; OR BUSINESS INTERRUPTION) HOWEVER CAUSED AND ON ANY THEORY OF LIABILITY, WHETHER IN CONTRACT, STRICT LIABILITY, OR TORT (INCLUDING NEGLIGENCE OR OTHERWISE) ARISING IN ANY WAY OUT OF THE USE OF THIS SOFTWARE, EVEN IF ADVISED OF THE POSSIBILITY OF SUCH DAMAGE.

Fabasoft R&D Software GmbH & Co.

Copyright (c) Fabasoft R&D Software GmbH & Co KG, 2003

oss@fabasoft.com

Author: Bernhard Penz

Redistribution and use in source and binary forms, with or without modification, are permitted provided that the following conditions are met:

- \* Redistributions of source code must retain the above copyright notice, this list of conditions and the following disclaimer.
- \* Redistributions in binary form must reproduce the above copyright notice, this list of conditions and the following disclaimer in the documentation and/or other materials provided with the distribution.

## END USER AGREEMENT

### *(including Limited Hardware Warranty, Software License and RMA Procedure)*

THIS IS AN AGREEMENT BETWEEN YOU (AS ORIGINAL END USER PURCHASER OF AN EXALT PRODUCT) AND EXALT WIRELESS, INC. ("EXALT"). THE END USER AGREEMENT APPLICABLE TO YOUR EXALT PRODUCT IS THE END USER AGREEMENT THAT IS PRE-LOADED ON THE EXALT PRODUCT, OR IF NONE IS PRE-LOADED, IT IS THE END USER AGREEMENT AVAILABLE ON THE EXALT WEBSITE @ [WWW.EXALTCOM.COM/EULA](http://WWW.EXALTCOM.COM/EULA) ON THE DATE OF YOUR PURCHASE OF THE EXALT PRODUCT OR OTHERWISE DIRECTLY AVAILABLE FROM EXALT UPON REQUEST. BY ACCEPTING THIS AGREEMENT OR BY USING THE EXALT PRODUCT WITH OR FOR WHICH THIS AGREEMENT IS PROVIDED ("PRODUCT"), YOU ARE AGREEING TO ALL OF THE BELOW TERMS AND CONDITIONS. IF YOU DO NOT AGREE WITH THESE TERMS AND CONDITIONS, YOU SHOULD NOT USE THE PRODUCT AND PROMPTLY RETURN IT TO YOUR PLACE OF PURCHASE FOR A REFUND. "YOU" MEANS THE LEGAL END USER ENTITY THAT PURCHASED THE PRODUCT FOR ITS OWN USE.

#### 1 Exalt Limited Hardware Warranty

- a. Exalt warrants solely to the original purchaser ("Purchaser") that the Exalt hardware product that this Agreement is provided with or for (the "Hardware Product") will substantially conform in all material respects to the relevant Exalt published specifications that apply at the time of manufacture of such Hardware Product for two (2) years from the date of purchase of Hardware Product by Purchaser (the "Warranty Period"). Proof-of-purchase in the form of an invoice, payment of invoice, or delivery waybill must be supplied, if requested by Exalt, in case of any dispute of warranty start date.
- b. In the event Purchaser notifies Exalt during the Warranty Period of a defective Hardware Product (material nonconformance with the published specifications), Exalt shall within the Warranty Period, at its own option either: (A) use reasonable efforts to remedy any reproducible Hardware Product defect covered by this limited warranty within a reasonable period of time; (B) replace the defective Hardware Product with a functionally equivalent product (repair parts and products may be either reconditioned or new, but, if reconditioned, shall be of the same quality as new parts or products); or (C) if Exalt determines that it is unable to repair or replace such Hardware Product, Exalt (or its applicable reseller) will refund to Purchaser the amount actually paid by Purchaser for the applicable Hardware Product. All replaced parts and products become the property of Exalt.
- c. The Exalt warranty does not cover any defective Hardware Product that (i) is subject to the exclusions set forth below in Section 3; (ii) cannot be demonstrated to have a defect of the types of defects covered by the Exalt warranty, or (iii) Purchaser is unable to provide adequate information describing how the Hardware Product failed that would allow Exalt to determine that the defect is covered by the Exalt warranty. Any Hardware Product that is returned by the Purchaser to Exalt and Exalt determines that such product is not covered by the Exalt warranty, will be, at Purchaser's option and expense (including any applicable shipping, handling, evaluation, repair, replacement and disposal fees), either be: (a) returned to Purchaser in the state received, (b) repaired or replaced, as applicable, and returned to Purchaser, or disposed of in accordance with Purchaser's instructions. Repaired or replaced Hardware Product will be warranted for the remainder of the original Warranty Period, but not less than ninety (90) days.

## 2 Warranty Registration

In order to facilitate warranty service and communication with Exalt, Exalt recommends that the Purchaser registers the Hardware Product with Exalt promptly following the Hardware Product purchase by providing to Exalt the requested registration information. *Product registration may be performed by completing and submitting the product registration form on [www.exaltcom.com/ProductRegistration](http://www.exaltcom.com/ProductRegistration).*

## 3 Limited Hardware Warranty Exclusions

This limited warranty will not apply to: (A) any Hardware Product that: (i) has been modified or altered by any party other than Exalt; (ii) has been subject to accident, misuse, neglect, or mistreatment; (iii) has been damaged during installation of the Hardware Product; (iv) has been damaged by failure of Purchaser or its agents to follow Exalt's instructions or specifications; (v) has been damaged by the equipment or system with which the Hardware Product is used; (vi) has sustained damage to the Hardware Products' interface or power connectors; (vii) is determined to be stolen; or (viii) has been damaged by water, fire, power changes, other hazards, or acts of God (including without limitation lightning); (B) any Software included in any such Hardware Product (see Software License below), or (C) any consumables. The warranty applies only to Hardware Products manufactured by or for Exalt and that can be identified by the Exalt trademark, trade name, serial number or logo affixed to them. Other products, including any third-party manufacturer products sold by Exalt on a resale basis, are subject to the applicable third-party manufacturer's warranty and end user agreement and are not warranted by Exalt. The Hardware Products covered by this warranty are not consumer products and are not intended for personal, family, or household purposes, nor are they intended for high-risk activities as described in Section 5 below.

## 4 Hardware Product RMA Procedure

A return material authorization (RMA) is required prior to returning Hardware Product to Exalt for in-warranty or out-of-warranty repair/evaluation. As such, Purchaser must use the then current Exalt RMA procedure. Such procedure is available on the Exalt website @ [www.exaltcom.com/RMA](http://www.exaltcom.com/RMA) or directly from Exalt upon request.

**PRODUCTS RETURNED WITHOUT A DULY ISSUED RMA NUMBER WILL BE RETURNED TO PURCHASER BY EXALT AT PURCHASER'S EXPENSE.**

## 5 PRODUCT WARRANTY DISCLAIMER AND LIMITATION OF LIABILITY

a. THE ABOVE EXPRESS LIMITED WARRANTY FOR THE HARDWARE PRODUCT, THE CONDITIONS AND OTHER TERMS SET FORTH IN THIS AGREEMENT ARE IN LIEU OF ALL OTHER WARRANTIES, CONDITIONS AND OTHER TERMS WHETHER EXPRESS, IMPLIED OR STATUTORY, REGARDING THE PRODUCT (HARDWARE PRODUCT AND SOFTWARE) AND ANY SERVICES PROVIDED BY EXALT, AND EXALT, ITS SUPPLIERS AND LICENSORS HEREBY EXPRESSLY DISCLAIM, TO THE EXTENT ALLOWED BY APPLICABLE LAW, ANY AND ALL SUCH EXPRESS, IMPLIED AND STATUTORY WARRANTIES, CONDITIONS AND OTHER TERMS, INCLUDING WITHOUT LIMITATION ANY AND ALL IMPLIED WARRANTIES OF FITNESS FOR A PARTICULAR PURPOSE, TITLE, INTERFERENCE WITH QUIET ENJOYMENT, NON-INFRINGEMENT OF THIRD-PARTY RIGHTS AND MERCHANTABILITY. FURTHER, EXALT DOES NOT WARRANT RESULTS OF USE OR THAT YOUR USE OF THE PRODUCT WILL BE UNINTERRUPTED OR ERROR FREE. NO WARRANTIES ARE MADE BY EXALT'S SUPPLIERS OR LICENSORS. EXCEPT FOR THE ABOVE EXPRESS LIMITED WARRANTY FOR THE HARDWARE PRODUCT, THE CONDITIONS AND OTHER TERMS STATED HEREIN, THE

PRODUCT IS PROVIDED "AS IS" AND WITH ALL FAULTS. THE ENTIRE RISK AS TO SATISFACTORY QUALITY, ACCURACY, AND EFFORT IS WITH YOU.

- b. THE PRODUCT IS NOT FAULT-TOLERANT AND IS NOT DESIGNED, MANUFACTURED OR INTENDED FOR USE OR RESALE AS ONLINE CONTROL EQUIPMENT IN HAZARDOUS ENVIRONMENTS REQUIRING FAIL-SAFE PERFORMANCE, SUCH AS IN THE OPERATION OF NUCLEAR FACILITIES, AIRCRAFT NAVIGATION OR COMMUNICATION SYSTEMS, AIR TRAFFIC CONTROL, DIRECT LIFE SUPPORT MACHINES OR WEAPONS SYSTEMS, IN WHICH THE FAILURE OF THE PRODUCT COULD LEAD DIRECTLY TO DEATH, PERSONAL INJURY, OR SEVERE PHYSICAL OR ENVIRONMENTAL DAMAGE. EXALT AND ITS SUPPLIERS AND LICENSORS SPECIFICALLY DISCLAIM ANY EXPRESS OR IMPLIED WARRANTY OF FITNESS FOR ANY HIGH-RISK USES LISTED ABOVE.
- c. REGARDLESS OF WHETHER ANY REMEDY SET FORTH HEREIN FAILS OF ITS ESSENTIAL PURPOSE OR OTHERWISE, AND TO THE EXTENT ALLOWED BY APPLICABLE LAW, IN NO EVENT WILL EXALT, ITS SUPPLIERS OR LICENSORS BE LIABLE TO YOU OR TO ANY THIRD PARTY UNDER ANY TORT, CONTRACT, NEGLIGENCE, STRICT LIABILITY OR OTHER LEGAL OR EQUITABLE THEORY FOR ANY LOST PROFITS, LOST OR CORRUPTED DATA, COMPUTER FAILURE OR MALFUNCTION, INTERRUPTION OF BUSINESS, OR OTHER SPECIAL, INDIRECT, INCIDENTAL OR CONSEQUENTIAL DAMAGES OF ANY KIND ARISING OUT OF (1) THE USE OR INABILITY TO USE THE PRODUCT OR (2) PRODUCT RELATED SERVICE OR SUPPORT, EVEN IF EXALT HAS BEEN ADVISED OF THE POSSIBILITY OF SUCH LOSS OR DAMAGES AND WHETHER OR NOT SUCH LOSS OR DAMAGES ARE FORESEEABLE.
- d. IN NO EVENT SHALL EXALT'S AND ITS SUPPLIERS'/LICENSORS' AGGREGATE LIABILITY EXCEED AN AMOUNT EQUAL TO THE PURCHASE PRICE PAID BY PURCHASER FOR THE PRODUCT OR SERVICE THAT IS THE SUBJECT OF A CLAIM. ANY CLAIM ARISING OUT OF OR RELATING TO THIS AGREEMENT MUST BE BROUGHT WITHIN ONE (1) YEAR AFTER THE OCCURRENCE OF THE EVENT GIVING RISE TO SUCH CLAIM. IN ADDITION, EXALT DISCLAIMS ALL LIABILITY OF ANY KIND OF EXALT'S SUPPLIERS/LICENSORS.

## 6 SOFTWARE LICENSE

- a. Subject to the terms and conditions of this Agreement, Exalt hereby grants You a non-exclusive, non-transferable, non-sublicensable license to use the Software that comes with the Product, if any is provided as part of the Product, only as part of the normal operation, use and maintenance of the Hardware Product for which the Software was provided. You may make back-up copies of such Software. You shall not otherwise copy, distribute or alter the Software. Furthermore, except to the extent allowed by applicable law if located in the European Union, and then only with prior written notice to Exalt, You shall not disassemble or reverse engineer the Software in whole or in part or authorize others to do so. No rights to distribute or sublicense the Software are granted herein.
- b. There may be certain third-party owned software provided along with, or incorporated within the Product ("Third Party Software"), and which Third Party Software has a separate license agreement and which is governed exclusively by such separate license agreement ("Third Party License") and not this Agreement. Such Third Party Software and applicable Third Party Licenses are listed in the document "EXALT WIRELESS, INC. THIRD-PARTY SOFTWARE AND THIRD-PARTY LICENSES USED WITH CERTAIN EXALT

PRODUCTS" available through the Web user interface application provided with this product or on the Exalt website. Except as Exalt may otherwise inform You in writing, the Third Party License gives You at least the license rights granted above in Section 6(a), and may provide additional license rights as to the Third-Party Software, but only with respect to the particular Third-Party Software to which the Third-Party License applies. SUCH THIRD-PARTY SOFTWARE IS PROVIDED WITHOUT ANY WARRANTY FROM EXALT AND ITS LICENSORS, INCLUDING BUT NOT LIMITED TO WARRANTIES OF MERCHANTABILITY, FITNESS FOR A PARTICULAR PURPOSE AND NON-INFRINGEMENT.

- c. Exalt and its licensors are the sole and exclusive owners of the Software, and all underlying intellectual property rights in the Software and Hardware Product. All rights not expressly granted to You relating to the Software are reserved by Exalt and its licensors. You take unencumbered title to the Hardware Product, subject to Exalt's and its licensors' ownership in the underlying intellectual property, upon payment in full to Exalt or the Exalt reseller for the Product(s).
- d. All licenses to the Software hereunder shall terminate if You fail to comply with any of the provisions of this Agreement and do not remedy such breach within thirty (30) days after receiving written notice from Exalt. You agree upon termination to immediately cease using the Software and to destroy all copies of the Software which may have been provided or created hereunder.

## 7 GOVERNMENT RESTRICTIONS

- a. You agree that you will not export or re-export the Products without Exalt's prior written consent, and then only in compliance with all requirements of applicable law, including but not limited to U.S. export control regulations. You have the responsibility to obtain any required licenses to export, re-export or import the Products. You shall defend, indemnify and hold Exalt and its suppliers/licensors harmless from any claims arising out of Your violation of any export control laws relating to any exporting of the Products. By accepting this Agreement and receiving the Products, You confirm that You are not listed on any governmental export exclusion lists and will not export or re-export the Products to any country embargoed by the U.S. Applicable export restrictions and exclusions are available at the official web site of the U.S. Department of Commerce Bureau of Industry and Security ([www.bis.doc.gov](http://www.bis.doc.gov)).
- b. For purchase by or on behalf of governmental entities (including federal, state or provincial, and local), the governmental entity's rights in any technical data and software in the Products include only those rights customarily provided to the public as defined in Exalt's standard End User Agreement. In connection with any purchase by or on behalf of a U.S. governmental entity, Exalt's customary commercial license in technical data and software is provided in accordance with FAR 12.211 (Technical Data) and FAR 12.212 (Software) and, for Department of Defense transactions, DFAR 252.227-7015 (Technical Data - Commercial Items) and DFAR 227.7202-3 (Rights in Commercial Computer Software or Computer Software Documentation). If a governmental entity has a need for rights not conveyed under these terms, it must negotiate a mutually acceptable written agreement with Exalt specifying and specifically conveying such rights. Any use, modification, reproduction, release, performing, displaying or disclosing of the Exalt Software by a governmental entity shall be governed solely by the terms of this Agreement.

## 8 CONFIDENTIALITY

Purchaser acknowledges and agrees that information supplied by Exalt in connection with the Product or this Agreement and designated by Exalt as confidential is the confidential information of Exalt, which confidential information includes the Software. Purchaser agrees: (i) to hold the confidential information in confidence using the same degree of care that it uses to protect its own

confidential information of similar importance, but not less than a reasonable degree of care, (ii) not to make use of confidential information other than as contemplated by this Agreement, and (iii) not to reproduce confidential information except as expressly authorized by this Agreement. Purchaser's obligations with respect to confidentiality do not apply to information which: (i) becomes generally available to the public other than as a result of unauthorized disclosure by Purchaser, or (ii) was in Purchaser's possession prior to disclosure by Exalt.

9 MISCELLANEOUS

Exalt shall be excused from delay or failure in performance caused by anything beyond its reasonable control, including, without limitation, acts of God or of any third party, government action, compliance with laws or regulations, shortages, strikes, lockouts or industrial disputes, or the unavailability of deliveries, supplies, or software. Purchaser shall not sell, transfer or assign this Agreement without the prior written consent of Exalt. Any act in derogation of the foregoing shall be null and void, and Purchaser will remain obligated under this Agreement. This Agreement shall benefit and be binding upon the parties to this Agreement and their respective permitted successors and assigns. The waiver or failure of either party to exercise in any respect any right provided for in this Agreement shall not be deemed a waiver of any further right under this Agreement. If any provision of this Agreement is held by a court of competent jurisdiction to be contrary to law, the remaining provisions of this Agreement will remain in full force and effect. This Agreement and any disputes arising out of, or in any way related to or connected with, this Agreement, its termination or the relationship of the parties will be governed by and construed in accordance with the laws of the State of California, excluding its conflict of laws principles and excluding the United Nations Convention on Contracts for the International Sale of Goods. All disputes arising out of, or in any way related to or connected with, with this Agreement, the Products or Services shall be administered by the American Arbitration Association under its commercial arbitration rules by a single arbitrator appointed in accordance with the rules. Both parties consent that the arbitration shall take place in Santa Clara County, California. The award rendered by the arbitrator shall be final and binding on the parties and judgment on the award may be entered in any court having jurisdiction thereof. Any litigation relating to this Agreement or the arbitration shall take place in the state courts of Santa Clara County or in the federal courts of the Northern District of California. The foregoing notwithstanding, Exalt may obtain preliminary and/or permanent injunctive relief in any court of competent jurisdiction worldwide to enforce the terms of Sections 6, 7 and 8. Purchaser hereby consents and submits to the exclusive jurisdiction and venue of these courts and agrees that process may be served in the manner provided or allowed by California or federal law. In any action or proceeding to enforce rights under this Agreement, the prevailing party shall be entitled to recover costs and attorneys' fees. If the party who initiates the proceeding unilaterally dismisses it, the other party will be deemed the prevailing party. This Agreement represents the complete agreement and understanding of the parties with respect to the subject matter herein. This Agreement may be modified only through a written instrument signed or otherwise agreed to by both parties.

-----  
Part Number 203985  
Revision 2.21, 11/6/2014  
Exalt Confidential

## Index

### A

Administration Settings page 27  
administrator privileges 22  
antennas  
    alignment 19, 91  
    Canada 100  
    mounting 16  
        indoor 19  
    mounting height 5  
    site preparation considerations 5  
    transmission line 17  
    troubleshooting 91

### B

back-to-back bench test 7, 93  
back-to-back bench test configuration 93  
Band parameter 35  
Bandwidth parameter 36  
browsers 21

### C

cables  
    Ethernet (CAT5e) 7  
    RF 5  
    troubleshooting  
        improper RF cable termination 90  
connections  
    RSL Sync 80  
    sync distribution accessory 80  
    Two-radio pin Internal Sync Out/In 80  
connectors 14  
    ETH2 and ETH3 14  
    GPS/RSL 14  
    PoE/ETH1 14  
    Power/Ethernet 81  
Current RSL field 49

### D

DC power source 15  
dimensions 66, 73  
Dynamic Frequency Selection (DFS) 96

### E

Effective Antenna Gain parameter 36  
effective isotropic radiated power (EIRP) 8  
Endpoint Identifier parameter 34  
Ethernet connectors 81  
Ethernet interface 72, 79

### F

factory default settings

Access List Filtering 9  
Administration Password 9  
Band/Frequency 9  
Bandwidth 9  
Encryption 9  
Endpoint Identifier 9  
IP Address 9  
IP Gateway 9  
IP Mask 9  
Link Distance 9  
Link Security Key 9  
Radio (RF) State 9  
Transmit Power Limit 9  
User Password 9  
fade margin 5, 92  
frame length *See TDD frame*  
frequency  
    center 5  
**G**  
GPS/RSL connector 14  
GPS/RSL LED 15  
grounding 91  
GUI  
    Access Control List 42  
    Administration Settings page 27  
    Antenna Alignment Settings page 47  
    browsers supported 21  
    description 21  
    DFS page 56  
    Ethernet Administration State page 38  
    Ethernet Negotiation State page 51  
    Event Log page 58  
    File Management page 32  
    IP address (default) 21  
    log in 21  
    login privileges 22  
    Manual page 65  
    Metrics page 53  
    NTP and Time Zone page 29  
    Performance page 49  
    Radio A configuration 21  
    Radio Default page 48  
    Radio Information page 26  
    Reboot page 63  
    Reset page 63  
    Shutdown page 64



SNMP Configuration page 30  
SNMP Trap Configuration page 31  
Subscriber page 52  
System Configuration page 34

**I**

interfaces

Ethernet 72, 79  
power 72, 79  
RF 72, 79

interference profile 5

Internal Sync Out/In (two-radio pin connection) 80

IP address conflicts 21

IP settings 7

**L**

LEDs

ETH2 or ETH3 15  
GPS/RSL 15  
Power/ETH1 15

License Key 27

lightning arrestor 5

lightning arrestors 19

link 5

orientation 9  
RF link testing 7

Link Distance parameter 36

link margin 92

link parameters 23

login names 22

login privileges 22

**M**

mounting

hardware 13

multipath 89

multipath propagation 90

**N**

noise profile 5

**P**

passwords 7, 22

path obstruction 91

performance degradation 89

Performance page 49

Power connector 81

power interface 72, 79

Power/Ethernet connector 14

**R**

radio

default settings 9

grounding 91

initiation tasks 11

installation tasks 11

mounting 5, 13

rebooting 63

Radio A configuration 6

Radio A/Hub 9

radio configuration 6

radio default button 48

Radio Information page 26

Radio Transmission Status parameter 34

Radio Transmit Power parameter 36

receiver threshold 5

record keeping 12

regulatory requirements

EIRP 104

USA 99

Reset page 63

RF connector termination 15

RF interface 72, 79

RF interference 90

RF lightning arrestor 19

RF output power 8

RSL 8

current RSL readings 49

monitor for performance 89

RSL field 49

RSL Sync 80

**S**

safety 95

shipping box contents 6

Shutdown button 64

site preparation 5

specifications 66, 73

ExpandAir 73

sync distribution accessory 80

system latency 5

system performance 49

system settings

Current BER field 49

grounding 91

Minimum RSL field 49

system specifications 67, 73

**T**

T1/E1 2&4 LED 15

TDD factors 8

TDD frame length 5  
testing 93  
    back-to-back bench 7  
    threshold 94  
threshold testing 94  
time division duplex (TDD) *See TDD frame*  
transmission line  
    coaxial 17  
transmitter  
    output power 7  
troubleshooting 88  
**U**  
unfaded error-free performance 7  
Update button 27  
user privileges 22  
**V**  
VSWR 90





