



**EX-5r**  
**5GHz Digital Microwave Radio**  
**Installation & Management**

Part Number: 50000007  
Date: 2006-05-17

## **Legal Notice**

The information contained herein is the property of Exalt Communications, Inc. (“Exalt”) and is supplied without liability for errors or omissions. No part of this document may be reproduced, in any form, except as authorized by contract or other written permission from the owner.

Any brand names and product names included in this manual are trademarks, registered trademarks, or trade names of their respective holders.

The contents of this document are current as of the date of publication. Exalt reserves the right to change the contents without prior notice.

The publication of information in this document does not imply freedom from patent or other rights of Exalt or others.

© Exalt Communications Inc., May 2006. All rights reserved.  
The Exalt logo is a trademark of Exalt Communications, Inc.

## About this Document

This manual provides a complete description of the Exalt EX-5r Digital Microwave Radio and related software. The purpose of this manual is to provide the planner, engineer, installer, system administrator, and technician with general and specific information related to the planning, installation, operation, management and maintenance of the device.

### Revision History

Date	Detail
2006-05-17	Initial release

### Icons

Throughout this document, the following icons are used to denote specific types of information as described here.



(Warning) Denotes information pertaining to potential danger to human life.



(Caution) Denotes information pertaining to potential danger to property.



(Note) Denotes information that may be particularly useful or unique

## **General Compliance and Safety**

The usage of radio transmission devices is subject to specific regulatory requirements governed by regional legislation. In most cases, the specific device must be authorized for use in a given country and must be installed and adjusted in accordance with specific radio-frequency settings and in a manner that has been authorized specific to the device itself in accordance with the specific location of the device. Some users may be completely or partially restricted from use of the device. Please consult your governmental agency/agencies for regulatory requirements before use, or contact Exalt or your Exalt authorized dealer for assistance.

This device may not be modified in any way without the express written consent of Exalt. Modification will not only void the manufacturer warranty, but may also be expressly illegal in accordance to government regulations. In addition, there are no user-serviceable parts or assemblies inside the product housing. There may also be voltages, signals and mechanisms within the device that could be harmful to human safety.

The mounting of this device and associated peripherals and connections (inclusive of antenna mast, antenna, cabling, egress, lightning protection devices, grounding, power, etc.) may be subject to regional requirements for health and human safety. A qualified professional installer and an electrician are highly recommended, and may be required by law. For example, within the USA, this device must be professionally installed to ensure that the system implementation meets FCC regulations.

Exalt cannot warrant the device or be found liable for any unauthorized use or installation of the device.

## **Regulatory Notices**

### **Federal Communications Commission (FCC), United States**

The device is allowed to be used provided it does not cause interference to other devices. It is not guaranteed to provide protection against interference from other electronic and radio devices.

The system has been tested and found to comply with the limits of a class B digital device, pursuant to Part 15 of the FCC Rules. These limits are designed to provide reasonable protection against harmful interference in a residential installation. This equipment generates uses and can radiate radio frequency energy and, if not installed and used in accordance with the instructions, may cause harmful interference to radio communications. However, there is no guarantee that interference will not occur in a particular installation. If this equipment does cause harmful interference to radio or television reception, which can be determined by turning the equipment off and on, the user is encouraged to try to correct the interference by one of more of the following measures:

- Reorient or relocate the receiving antenna.

- Increase the separation between the equipment and receiver.
- Connect the equipment into an outlet on a circuit different from that to which the receiver is connected.
- Consult the dealer or an experienced radio/TV technician for help.

Shielded cables and I/O cords must be used for this equipment to comply with the relevant FCC regulations.

Changes or modifications not expressly approved in writing by Exalt may void the user's authority to operate this equipment.

### **This device must be professionally installed.**

In order to comply with regulations, the output power of this device may need to be adjusted in accordance to the associated transmission system. See section 2.3 of this manual for details.

The antenna associated with this device shall be mounted in a location that is at least 22 feet away from humans that may be subject to long-term or continuous exposure.

### **Industry Canada (IC), Canada**

This device complies with RSS-210 of Industry Canada. Operation is subject to the following two conditions:

1. this device may not cause interference, and
2. this device must accept any interference, including interference that may cause undesired operation of the device.

This device has been designed to operate with the antennas, as listed below, and having a maximum gain of 37.5dBi. Antennas not included in the list or having a gain greater than 37.5dBi are strictly prohibited for use with this device. The required antenna impedance is 50 ohms.

<b>Manufacturer</b>	<b>Model #</b>	<b>Description</b>	<b>Gain dBi (mid-band)</b>
Andrew	P2F-52-N	2-foot Dish	29.4
Andrew	PX2F-52-N	2-foot Xpol Dish	29.4
Andrew	P3F-52-N	3-foot Dish	33.4
Andrew	PX3F-52-N	3-foot Xpol Dish	33.4
Andrew	P4F-52-N	4-foot Dish	34.9
Andrew	PX4F-52-N	4-foot Xpol Dish	34.9
Andrew	HP2F-52-NPA	2-foot HP Dish	29.0
Andrew	HPX2F-52-NPA	2-foot Xpol HP Dish	29.0
Andrew	HP3F-52-NPA	3-foot HP Dish	33.0
Andrew	HPX3F-52-NPA	3-foot Xpol HP Dish	33.0
Andrew	HP4F-52-NPA	4-foot HP Dish	34.5
Andrew	HPX4F-52-NPA	4-foot Xpol HP Dish	34.5
Andrew	HP6F-52-NPA	6-foot HP Dish	37.2

*Exalt Communications Inc.  
EX-5r Installation & Management*

Andrew	HPX6F-52-NPA	6-foot Xpol HP Dish	37.2
Andrew	FPA5250D06-N	6-inch Panel	18.0
Andrew	FPA5250D12-N	1-foot Panel	23.6
Exalt	(Integral)	1-foot Xpol Panel	20.0
Gabriel	DFPS.5-52	6-inch Panel	18.0
Gabriel	DFPD1-52	1-foot Panel	23.5
Gabriel	DFPD2-52	2-foot Panel	28.0
Gabriel	QF2-52-N	2-foot Dish	28.5
Gabriel	QF2.5-52-N	2.5-foot Dish	31.2
Gabriel	QF4-52-N	4-foot Dish	34.8
Gabriel	QFD2-52	2-foot Xpol Dish	28.4
Gabriel	QFD2.5-52	2.5-foot Xpol Dish	31.1
Gabriel	QFD4-52	4-foot Xpol Dish	34.7
Gabriel	HQF2-52-N	2-foot HP Dish	28.2
Gabriel	HQF4-52-N	4-foot HP Dish	34.4
Gabriel	HQF6-52-N	6-foot HP Dish	37.4
Gabriel	HQFD2-52	2-foot Xpol HP Dish	28.1
Gabriel	HQFD2.5-52	2.5-foot Xpol HP Dish	30.7
Gabriel	HQFD4-52	4-foot Xpol HP Dish	34.3
Gabriel	HQFD6-52	6-foot Xpol HP Dish	37.3
MTI	MT-485001	7.5-inch Panel	19.0
MTI	MT-485002	1-foot Panel	23.0
MTI	MT-486004	18-inch Panel	26.0
MTI	MT-486001	2-foot Panel	28.0
MTI	MT-485005	7.5-inch Xpol Panel	18.0
MTI	MT-485025	15-inch Xpol Panel	23.0
Proxim	5054-WA-15-STN	Window Panel	15.0
Radio Waves	FP.5-5-18	6-inch Panel	18.0
Radio Waves	FP1-5-24	1-foot Panel	23.8
Radio Waves	FP2-5-28	2-foot Panel	28.0
Radio Waves	FPD.5-5-18	6-inch Xpol Panel	18.0
Radio Waves	SP1-5.2	1-foot Dish	22.5
Radio Waves	SP2-5.2	2-foot Dish	29.0
Radio Waves	HP2-5.2	2-foot HP Dish	28.6
Radio Waves	SP3-5.2	3-foot Dish	32.0
Radio Waves	SP4-5.2	4-foot Dish	34.8
Radio Waves	SPD2-5.2	2-foot Xpol Dish	28.1
Radio Waves	SPD3-5.2	3-foot Xpol Dish	31.1
Radio Waves	SPD4-5.2	4-foot Xpol Dish	34.4
Radio Waves	SPD6-5.2	6-foot Xpol Dish	37.5
RFS	SPF2-52A	2-foot Dish	27.9
RFS	SPF3-52A	3-foot Dish	31.4
RFS	SPF4-52A	4-foot Dish	33.9
RFS	SPF6-52A	6-foot Dish	37.4
RFS	SDF4-52A	4-foot HP Dish	33.9
RFS	SDF6-52A	6-foot HP Dish	37.4
RFS	MA0528-19AN	7.5-inch Panel	19.0
RFS	MA0528-23AN	1-foot Panel	23.0
RFS	MA0528-28AN	2-foot Panel	28.0

The antenna associated with this device shall be mounted in a location that is at least 22 feet away from humans that may be subject to long-term or continuous exposure.

## **Safety Notices**

- Review this guide in its entirety for important installation instructions BEFORE you attempt to install this product.
- This product is intended to be installed, used, and maintained by experienced telecommunications personnel only.
- A properly licensed or authorized electrician should be employed to install or evaluate/certify the installation of all power and grounding related to the use of this equipment and all connected devices.
- The device(s) shall only be connected to AC power sources provided by the supplier or to DC sources within the device's specifications. A separate breaker circuit shall be employed at the power source.
- Lightning, surge protection devices and earth grounding are required for most installations to ensure human safety. Consult your qualified electrician.
- Servicing of this device should be performed by authorized personnel only. Do not disassemble this device. By opening or removing any covers you may expose yourself to hazardous energy parts. Incorrect reassembly of this product can cause a malfunction, and/or electrical shock, when the unit is subsequently used.
- Do not connect or disconnect the power connection to the device when the power supply is plugged into an AC outlet. To connect, first connect the power connection to the device, then apply power (or plug in) at the outlet. To disconnect, disengage power at the outlet or unplug, then disconnect the direct connection to the device.
- Do not insert any object of any shape or size inside this product at any time, whether powered or not. Objects may contact hazardous energy parts that could result in a risk of fire or personal injury.
- Liquids shall not come in contact with, or enter the inside of the device at any time.
- Proper ventilation and/or airflow shall be provided surrounding the equipment. Do not block any intake or exhaust vents. Items shall not come in contact with heat-sinking materials. Assure that ambient operational and storage temperature specifications are maintained at all times.
- Equipment is suitable for mounting on noncombustible surfaces only.
- Do not move or alter the marking labels.

## **Open-Source License Information**

In addition to proprietary software/firmware, which is the sole intellectual property of Exalt, the EX-5r Digital Microwave Radio makes use of public (open-source) software/firmware (such as Linux OS) within the terms of use of their respective shared license agreements. Interested parties may contact Exalt Communications for copies of specific license agreements for any open-source software/firmware utilized in this product.

## **Exalt Limited Hardware Warranty**

Exalt Communications, Inc. (“Exalt”) warrants solely to the original purchaser (“Purchaser”) that EX-5r (the “Product”) will substantially conform in all material respects to the relevant Exalt published specifications that apply at the time of manufacture of such Product for two (2) years from the date of tender of Product by Exalt from FOB point designated by Exalt (the “Warranty Period”). Proof-of-purchase in the form of an invoice, payment of invoice, or delivery waybill must be supplied, if requested by Exalt, in case of any dispute of warranty start date. Exalt shall within the Warranty Period, at its own option: (A) use reasonable efforts to remedy any reproducible Product defect covered by this limited warranty within a reasonable period of time; (B) replace the defective Product with a functionally equivalent product (repair parts and products may be either reconditioned or new, but, if reconditioned, shall be of the same quality as new parts or products); or (C) if Exalt determines that it is unable to repair or replace such Product, Exalt will refund to Purchaser the amount actually paid by Purchaser for the applicable Product. All replaced parts become the property of Exalt. Exalt may, at its sole option, refuse to accept as defective Product that (i) is subject to the exclusions set forth below; or (ii) cannot be demonstrated to be defective by Exalt and Purchaser is unable to provide adequate information describing how the Product failed. Such Product will, at Purchaser’s option and expense, either be: (a) returned to Purchaser in the state received, or (b) repaired and returned to Purchaser. Repaired or replaced Product will be warranted for the remainder of the original Warranty Period, but not less than ninety (90) days.

### Registration

Purchaser is required to register its Product for full warranty support. Unregistered Product will receive a Warranty Period of only one (1) year.

### Exclusions

This limited warranty will not apply to: (A) any Product that: (i) has been modified or altered by any party other than Exalt; (ii) has been subject to accident, misuse, abnormal wear and tear, neglect, or mistreatment; (iii) has been damaged during installation of the Product; (iv) has been damaged by the equipment or system with which the Product is used; (v) has sustained damage to the Products’ interface or power connectors; (vi) are determined to be stolen; or (vii) has been damaged caused by fire, power changes, other hazards, or acts of God (including without limitation lightning); or (B) any software included in any such Product. The warranty applies only to Products that can be identified by the Exalt trademark, trade name, serial number or logo affixed to them. Exalt does not warrant any Product that is not manufactured by, for, or with permission from Exalt. The Products covered by this warranty are not consumer products and are not intended for personal, family, or household purposes.

### RMA Procedures

A return material authorization (RMA) is required prior to returning Product to Exalt for warranty or out-of-warranty repair/evaluation. As such, Purchaser must follow the following procedures: (1) Contact Exalt (see Section 1.0 of this document for current contact data) and request an RMA number. Please be prepared to provide the serial number of the Product, the date of purchase, and a description of the failure that is as complete as possible; (2) Pack the Product



in its original container and packing or an equivalent; (3) Write the RMA number CLEARLY on the outside of the shipping box; (4) For services during the Warranty Period, cost of shipment to Exalt's authorized service center, taxes, duty, tariffs, risk of loss and insurance charges to Exalt shall be borne by the Purchaser. Cost of return shipment and insurance charges shall be borne by Exalt and will be made by Exalt's choice of carrier and method/schedule of shipment. Purchaser may expedite return shipments, upon request, at its own expense. PRODUCTS RETURNED WITHOUT A DULY ISSUED RMA NUMBER WILL BE RETURNED TO PURCHASER AT PURCHASER'S EXPENSE.

THIS EXPRESS WARRANTY IS IN LIEU OF ALL OTHER WARRANTIES, EXPRESSED, IMPLIED OR STATUTORY, REGARDING THE PRODUCT, AND EXALT, ITS SUPPLIERS AND LICENSORS HEREBY EXPRESSLY DISCLAIM ALL SUCH IMPLIED AND EXPRESS WARRANTIES, INCLUDING WITHOUT LIMITATION ANY AND ALL IMPLIED WARRANTIES OF FITNESS FOR A PARTICULAR PURPOSE, TITLE, INTERFERENCE WITH QUIET ENJOYMENT, NON-INFRINGEMENT OF THIRD-PARTY RIGHTS AND MERCHANTABILITY. FURTHER, EXALT DOES NOT WARRANT RESULTS OF USE OR THAT PURCHASER'S USE OF THE PRODUCT WILL BE UNINTERRUPTED OR ERROR FREE. NO WARRANTIES ARE MADE BY EXALT'S SUPPLIERS OR LICENSORS. EXCEPT FOR THE EXPRESS WARRANTY STATED HEREIN, THE PRODUCT IS PROVIDED "AS IS" AND WITH ALL FAULTS. THE ENTIRE RISK AS TO SATISFACTORY QUALITY, ACCURACY, AND EFFORT IS WITH PURCHASER.

REGARDLESS OF WHETHER ANY REMEDY SET FORTH HEREIN FAILS OF ITS ESSENTIAL PURPOSE OR OTHERWISE, AND EXCEPT FOR BODILY INJURY, IN NO EVENT WILL EXALT, ITS SUPPLIERS OR LICENSORS BE LIABLE TO PURCHASER OR TO ANY THIRD PARTY UNDER ANY TORT, CONTRACT, NEGLIGENCE, STRICT LIABILITY OR OTHER LEGAL OR EQUITABLE THEORY FOR ANY LOST PROFITS, LOST OR CORRUPTED DATA, COMPUTER FAILURE OR MALFUNCTION, INTERRUPTION OF BUSINESS, OR OTHER SPECIAL, INDIRECT, INCIDENTAL OR CONSEQUENTIAL DAMAGES OF ANY KIND ARISING OUT OF THE USE OR INABILITY TO USE THE PRODUCT, EVEN IF EXALT HAS BEEN ADVISED OF THE POSSIBILITY OF SUCH LOSS OR DAMAGES AND WHETHER OR NOT SUCH LOSS OR DAMAGES ARE FORESEEABLE.

IN NO EVENT SHALL EXALT'S AND ITS SUPPLIERS' AGGREGATE LIABILITY EXCEED AN AMOUNT EQUAL TO THE PURCHASE PRICE OF THE PRODUCT PAID BY PURCHASER THAT IS THE SUBJECT OF A CLAIM. ANY CLAIM ARISING OUT OF OR RELATING TO THIS AGREEMENT MUST BE BROUGHT WITHIN ONE (1) YEAR AFTER THE OCCURRENCE OF THE EVENT GIVING RISE TO SUCH CLAIM. IN ADDITION, EXALT DISCLAIMS ALL LIABILITY OF ANY KIND OF EXALT'S SUPPLIERS.

## Table of Contents

Legal Notice.....	i
About this Document .....	ii
Revision History .....	ii
Icons.....	ii
General Compliance and Safety.....	iii
Regulatory Notices.....	iii
Safety Notices .....	vi
Open-Source License Information.....	vi
Exalt Limited Hardware Warranty.....	vii
Section 1 – Introduction.....	1
1.0 Introduction to Exalt Communications.....	1
1.0.1 Other Documentation and Software.....	1
1.1 The EX-5r Digital Microwave Radio .....	1
1.2 EX-5r Basic Features .....	3
Section 2 – Before Installation.....	5
2.0 Link Engineering and Site Planning .....	5
2.1 Familiarizing Yourself with the EX-5r.....	6
2.1.1 Shipping Box Contents .....	6
2.2 Back-to-Back Bench Test and Configuration.....	7
2.3 RF Output Power Setting .....	8
2.3.1 United States .....	8
2.3.2 Canada.....	9
2.4 Time Division Duplex Factors.....	10
2.5 Link Orientation and Synchronization.....	11
2.5.1 Default Settings.....	12
Section 3 – System Installation and Initiation Process .....	14
3.0 Task Overview .....	14
3.1 Record Keeping .....	15
Section 4 – Installation.....	16
4.0 Mechanical Configuration and Mounting.....	16
4.0.1 Pole Mounting the System.....	16
4.1 User Interfaces .....	17
4.1.2 Indicator Overview .....	18
4.2 Applying Power .....	18
4.2.1 Terminating the RF Connector .....	19
4.2.2 AC Power.....	19
4.2.3 DC Power.....	20
4.2.4 Reset to Critical Factory Settings .....	20
4.3 The Antenna/Transmission System .....	21
4.3.1 Initial Antenna Mounting.....	22
4.3.2 Transmission Line from Antenna to Radio.....	24
4.3.3 RF Lightning Arrestor.....	26
4.3.4 Transmission Line from Egress to Radio.....	26
4.4 Antenna Alignment.....	27

Section 5 – Configuration and Management .....	28
5.0 Using the Command Line Interface (CLI).....	28
5.0.1 Connecting to the Radio with a Telnet Connection .....	28
5.1 Using the CLI.....	28
5.2 Introduction to the Graphical User Interface (GUI) .....	29
5.2.1 Preparing to Connect.....	29
5.2.2 Making the Connection.....	30
5.2.3 Logging In.....	30
5.2.4 Login Privileges .....	31
5.3 Quick-Start.....	32
5.4 Graphical User Interface Fundamentals.....	33
5.4.1 Summary Status Section .....	33
5.4.2 Navigation Section.....	34
5.5 Radio Information Page .....	34
5.6 Administration Settings Page.....	35
5.7 System Configuration Page.....	36
5.8 Ethernet Interface Configuration Page.....	38
5.9 T1/E1 Configuration Pages.....	39
5.9.1 T1 Configuration Page.....	39
5.9.2 E1 Configuration Page.....	40
5.10 File Transfer Page .....	40
5.11 File Activation Page.....	42
5.12 Alarms Page .....	43
5.13 Performance Page .....	44
5.14 Event Log Page .....	46
5.15 Diagnostic Charts Page .....	47
5.16 Spectrum Analyzer Page.....	48
5.17 Reboot Page .....	48
5.18 Manual Page.....	49
Section 6 – Troubleshooting .....	50
6.1 General Troubleshooting Practices .....	50
6.2 Typical Indications of Issues .....	51
6.3 Improper RF Cable Termination.....	52
6.4 Multipath Propagation .....	53
6.5 RF Interference .....	53
6.6 Path Obstruction.....	54
6.7 Misaligned Antenna.....	54
6.8 Faulty Antenna.....	54
6.9 Improper Grounding .....	54
6.10 Insufficient Link Margin.....	54
6.11 Moisture in the Transmission System.....	55
Appendix A – Specifications .....	56
A-1 Physical Specifications .....	56
A-2 System Specifications .....	56
A-3 Interfaces.....	57
Appendix B – Back-to-back Bench Testing .....	58

B-1	Introduction.....	58
B-2	Basic Test.....	58
B-3	Specification Performance Verification.....	59
Appendix C – Interface Connections.....		62
C-1	Introduction.....	62
C-2	T1/E1 Connections.....	62
C-3	Ethernet/Power Connection .....	62
C-4	Sync Connection .....	62

## Figures and Tables

Figure 1-1:	The EX-5r (Integrated Antenna Version) .....	2
Figure 1-2:	Mounting and Cabling - Integrated Antenna Version.....	3
Figure 1-3:	Mounting and Cabling - External Antenna Version .....	4
Figure 3-1:	Radio Installation Flowchart.....	14
Figure 4-1:	Pole Mount Mechanics .....	16
Figure 4-2:	Connections.....	17
Table 4-1:	Connectors .....	17
Table 4-2:	Indicators.....	18
Table 4-3:	Recommended Antennas .....	22
Figure 5-1:	Main CLI Menu .....	28
Table 5-1:	CLI Tree Structure .....	29
Figure 5-2:	Initiating Browser Connection.....	31
Figure 5-3:	Browser Login Window.....	31
Table 5-2:	Default Login Information.....	31
Figure 5-4:	Radio Information Page .....	32
Figure 5-5:	GUI Sections (Radio Information Page).....	33
Figure 5-6:	Collapsed Browser Windows for Summary Status of Multiple Radios .....	34
Figure 5-7:	Radio Information Page .....	35
Figure 5-8:	Administration Settings Page.....	36
Figure 5-9:	System Configuration Page.....	38
Figure 5-10:	Ethernet Interface Configuration Page.....	39
Figure 5-11:	T1 Configuration Page.....	40
Figure 5-12:	E1 Configuration Page.....	40
Figure 5-13:	File Transfer Page .....	41
Figure 5-14:	Download File Link .....	41
Figure 5-15:	File Activation Page.....	42
Figure 5-16:	Alarms Page .....	43
Figure 5-17:	Performance Page .....	46
Figure 5-18:	Event Log Page .....	47
Figure 5-19:	Diagnostic Charts Page .....	48
Figure 5-20:	Reboot Page .....	49
Figure 5-21:	Manual Page.....	49
Figure B-1:	Basic Back-to-Back Bench Test Configuration.....	59
Figure C-1:	T1/E1 Connectors .....	62
Figure C-2:	Ethernet/Power Connector .....	62
Figure C-3:	Sync Connector .....	63

## Section 1 – Introduction

### 1.0 Introduction to Exalt Communications

Exalt Communications, Inc. thanks you for your purchase of the EX-5r Digital Microwave Radio. Our goal is to build the highest quality, highest reliability digital microwave radio products for our customers. This commitment to quality and reliability extends to our employees and partners alike. We appreciate any comments on how we can improve our products, as well as your sales and customer care experience.

Customer Care Hotline:	+1 408-871-9890
USA Toll-Free Customer Care Hotline:	+1 877-EXALT-01 (392-5801)
Website:	www.exaltcom.com (launching June 2006)
Sales E-mail:	sales@exaltcom.com
Customer Care E-mail:	support@exaltcom.com

Mailing Address:	Exalt Communications, Inc. 580 Division St. Campbell, CA 95008 USA
------------------	---

Direct-Dial Telephone:	+1 (408) 871-1804
------------------------	-------------------

#### 1.0.1 Other Documentation and Software

This manual makes reference to other documentation and software files that may be necessary to obtain. The Quick Start Guide provided with the equipment provides information on where this documentation can be found. Or contact Exalt, as described in section 1.0.

### 1.1 The EX-5r Digital Microwave Radio

The EX-5r Digital Microwave Radio is the most advanced carrier class point-to-point terrestrial radio communications device operating in the 5250 to 5850 MHz frequency range.

The EX-5r is used to connect voice and/or digital data from one location to another, obviating the need for copper or fiber connectivity, or enhancing existing connectivity by providing a redundancy solution, a primary solution and/or additional capacity.

Generally, the EX-5r requires clear line-of-sight and proper path clearance to achieve a high-performance, reliable connection. Professional path engineering and site planning should be performed BEFORE the installation of this equipment. This document primarily focuses on the installation and maintenance of the microwave radio, and assumes that path engineering and site planning has already been performed. Please refer to Exalt's document "**Guidance for Engineering and Site Planning of Terrestrial Wireless Links**" for detailed information on these activities.



Figure 1-1: The EX-5r (Integrated Antenna Version)

The EX-5r utilizes radio frequencies in the range of 5250 to 5850MHz, in one or both of the following bands:

- 5350 to 5350 MHz
- 5725 to 5850 MHz

In many countries, one or both of these frequency bands are considered as ‘license-exempt’ or ‘unlicensed.’ This means that virtually any user may use these frequencies freely, without paying for access, or any type of pre-notification, post-notification or registration. As a result of this designation, users may also move or change these systems at any time, with significant flexibility to the location, orientation and configuration of the system. However, due also to this designation, there may be uncontrolled interference from other similar devices that occupy this spectrum. In these cases, it is up to engineering and maintenance personnel to design the system with existing and future interference sources in mind, recognizing that there is a chance that the interference conditions could be very dynamic, and outages may occur on the system as a result, and that, in some very rare cases, the system may cause interference into another system and may be required to be disengaged or modified/re-oriented to eliminate the interference.

If the spectrum in your country is designated as ‘license-exempt’ or similar, this does not infer that the installer may configure the system in **any** manner, at **any** location. In most cases, there are regulations, or device-based conditions that limit the use of the device, such as maximum gain antenna, antenna types and maximum output power, as well as, in some cases, application limits, limited geography of use, and other unique regulations. **The link design engineer and/or professional installer must determine these limitations and engineer/install the system within the confines of all local regulations.** Also, it is required to examine any regulations that may apply to peripheral equipment, installation and cabling of the system, which may be regulated for human safety, electrical code, air-traffic control, and other safety-related categories.

In certain countries, the spectrum for this product is **NOT** considered to be license-exempt. In these cases, there may be additional regulatory requirements concerning the location, frequency, power, orientation, configuration and other aspects of the system, including, in some cases, a need for link registration, coordination and fees that may apply to the system usage. Please consult your local regulatory organization(s) to determine the usage requirements.

In almost all cases, either for license-exempt or other designation, the product itself must be authorized for use in your country. Either Exalt or Exalt's agent must have applied for certification or authorization to allow the sale and deployment of the system within the country. It is also possible that only certain versions or configurations of the device are allowed within a particular country. Please contact Exalt or your authorized Exalt representative for information pertaining to your country.



**It is the (professional) installer's responsibility to assure that the radio system is implemented in a legal fashion. Exalt cannot be held liable for any unsafe or illegal installation.**

## 1.2 EX-5r Basic Features

The EX-5r Digital Microwave Radio is intended for all-outdoor mounting. It is accompanied with an indoor-mounted power injector. The EX-5r may also be mounted indoors or in an enclosure, if desired. Depending on the configuration purchased, the associated antenna is either integrated as part of the unit or connected separately. For the integrated antenna version, the entire unit is typically mounted on a tower or rooftop mast structure, with Ethernet/Power and other optional interface cabling running from the unit's location, through a structure penetration, to the power injector and connected communications equipment. For the external antenna configuration, the unit is typically mounted very close to the external antenna to minimize RF cabling and associated losses. Alternatively, the unit may be mounted at an easily-accessible location with longer RF cabling to the antenna. Proper lightning or surge suppression devices and associated grounding are required for all connections.

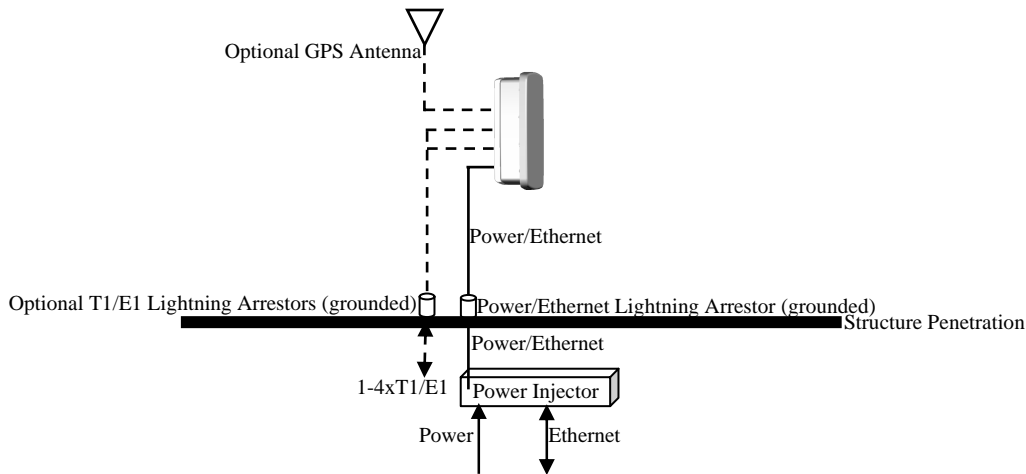
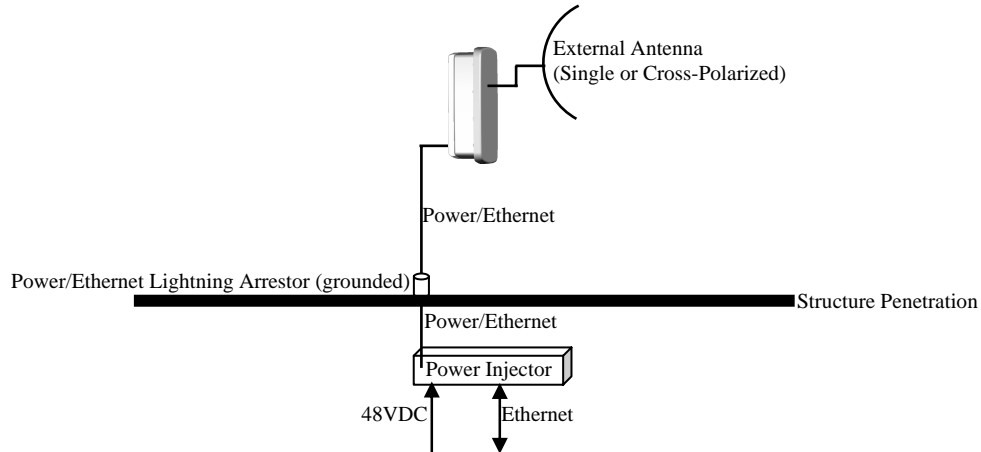

Figure 1-2: Mounting and Cabling - Integrated Antenna Version



*Figure 1-3: Mounting and Cabling - External Antenna Version*

For highest performance and reliability, it is advised to minimize the length of RF cable, and associated transmission system losses between the antenna and the radio's RF port.

The EX-5r provides connection for any of the following data communication interfaces, or a combination thereof:

- 10/100BaseT Ethernet
- 1-4xT1/E1 interfaces for synchronous voice traffic

The EX-5r is powered by a combined Power/Ethernet cable, and associated power injector. The power injector provides 48VDC to the unit.

The EX-5r provides the following primary features and benefits:

- Low-latency optimization and control for voice and data connections
- Very high throughput and flexible interface configurations with voice+data combinations
- Encryption for extreme wireless security
- Easy-to-use management and configuration
- Flexible utilized channel bandwidth selection for interference avoidance and frequency coordination
- Flexible center frequency tuning for interference avoidance and frequency coordination
- Flexible capacity to meet current connection requirements, and future growth needs
- Carrier-class reliability and performance



## **Section 2 – Before Installation**

### **2.0 Link Engineering and Site Planning**

Any terrestrial wireless link should be designed prior to purchase and installation. Generally, professional wireless engineering personnel are engaged to determine the viability and requirements for a well-engineered link that will meet the users' needs for performance and reliability.

The reader is referred to the Exalt document “**Guidance for Engineering and Site Planning of Terrestrial Wireless Links**” and the “**ExaltCalc**” path calculator. This document and calculator aid in the pre-planning and engineering that is required for determination of the following attributes:

- Antenna type/gain at each end of the link
- Antenna mounting height/location for proper path clearance
- Antenna polarization orientation
- RF cabling type, length, connectors, route and mounting
- Antenna system grounding
- Lightning arrestor type(s), location(s) and grounding
- Radio mounting location and mechanisms
- Radio grounding
- Radio transmitter output power setting
- Anticipated received signal level (RSL) at each end
- Anticipated fade margin and availability performance at each end
- Radio settings for TDD Frame Length and Occupied Bandwidth (BW)
- Anticipated throughput performance (TDM circuit support and Ethernet)
- Anticipated system latency

With respect to radio path and site planning, the EX-5r is generally identical to any other microwave terrestrial wireless system. Engineering of these systems will require specific knowledge about the EX-5r itself, including:

- RF specifications (transmitter output power, receiver threshold, occupied channel bandwidth, carrier-to-interference tolerance)
- Regulatory limitations on transmitter output power setting and antenna type/gain
- Noise/interference profile for the intended location
- Impact on throughput and latency relative to link distance, occupied bandwidth and TDD Frame Size setting, and the planned implementation of these parameters

## 2.1 Familiarizing Yourself with the EX-5r

The EX-5r utilizes time division duplex (TDD) radio transmission. That is, that the transmitted signal in both directions is using the same center frequency and is transmitting in one direction for a period of time, then transmitting in the opposite direction for another period of time. This total period of time is referred to as the “Frame Length” or “TDD Frame Length”, and is further discussed in section 2.4.

The two radio terminals are identical hardware to one another, except for this configuration setting in software. When the radios are in their default state (such as they are when they are initially shipped), both radios are configured as Radio B. **One end of the link must be configured as Radio A before the two ends of the radio system will communicate.** It can be considered that Radio A is the primary radio of the link. Radio A provides the master clocking and control to Radio B. For most applications, it is not important how the radio link is oriented, only that one end is configured for Radio A, and the other for Radio B. For some applications, such as multi-radio hub sites or repeaters, the orientation of the radio systems may be more critical. Details about link orientation can be found in section 2.5.

There are two means to configure the radios for Radio A/B determination:

- 1) Using the browser-based graphical user interface (GUI)
- 2) Using Telnet command line interface (CLI)

It is encouraged to use the browser-based GUI for radio configuration, as there are many settings that will be necessary to adjust the device to meet your operational needs, and the GUI is a very intuitive interface. This interface requires a computer with an Ethernet port and web browser software, such as Microsoft Internet Explorer 5.0 or above. See section 5.2 for details on how to connect to and use the browser-based GUI interface.

### 2.1.1 Shipping Box Contents

Unless purchased as a spare terminal, the EX-5r is shipped as a complete ‘hop’ (radio link pair consisting of two terminals). An outer box has labeling that indicates the contents of the box, with the part number and serial number details for both radio terminals.

Inside the outer box are two identical boxes, each of these boxes is also marked with the part number and serial number of the individual terminal contained inside the box. The terminal box has the following items inside:

- Radio terminal (configured for Radio B)
- AC adapter
- DC injector
- Pole mounting kit
- Pre-terminated Ethernet/Power Cable (50 ft. each)

- Registration card
- Quick-start guide

Inspect the outer packaging and the contents of the boxes upon receipt. If you suspect any shipping damage or issues with the contents, Exalt Customer Care should be contacted to address any issues as soon as possible.



**Register your system as soon as possible. A 2-year Warranty period applies to properly registered products. The Warranty period is reduced to 1-year for unregistered products.**

## **2.2 Back-to-Back Bench Test and Configuration**

Every Exalt digital microwave radio goes through extensive quality testing and performance evaluation over full temperature range prior to shipment. However, before installation, it is strongly advised to perform several tests and tasks that can be much more difficult to perform once the radio link endpoints are distant from one another. A back-to-back bench test and pre-configuration will provide confidence that the radio link is operational and configured properly **prior** to installation, so that if troubleshooting is necessary, the radio hardware and configuration settings are eliminated from the troubleshooting process.

- Confirm that the radio system is generally operational
  - Radios power-up with planned power and wiring solutions
  - RF link can connect in both directions
  - Traffic can be passed across the link
- Configure connected equipment and cabling
  - Test Ethernet (CAT5) cabling, and/or T1/E1 cabling, any auxiliary connector cabling and configure all interfaces
  - Configure IP settings for configuration and management
  - Configure passwords and security modes
  - Become familiar with the configuration and management interfaces through the browser-based GUI interface.
- Configure radio parameters
  - Set transmitter output power to engineered or allowed level (see section 2.3)
  - Set operating center frequency
  - Set link distance, occupied channel bandwidth and frame length
- Make detailed radio performance measurements
  - Measure transmitter output power
  - Measure receiver threshold performance
  - Confirm unfaded error-free performance

Some of the above tasks may not be possible or practical within a bench test environment, due to the nature of the remote connectivity of peripheral equipment. However, it is a good practice to perform as much as possible in this environment to minimize field/installation time and troubleshooting efforts.

Detailed performance measurements are usually not required for pre-installation, but they can typically be easily performed at this stage and may be helpful for later troubleshooting efforts or for internal records. During troubleshooting, there may often be a point at which a back-to-back bench test should be performed to re-verify many or all of the items above, and in the case of a suspected faulty device to help confirm the fault, and determine which end of the system is at fault and in need of repair/replacement.



Detailed instructions for back-to-back bench testing are included in Appendix B.

## 2.3 RF Output Power Setting

The maximum RF output power is bounded by one of the following criteria:

- Maximum RF output power setting capability of the radio device
- Maximum RF output power allowed/authorized by the local government regulations and for this specific device
- Maximum EIRP (effective isotropic radiated power) of the transmission system allowed/authorized by the local government regulations and for this specific device
- Desired RSL to not exceed the maximum RSL allowed by the device
- Desired RSL to minimize/eliminate interference into neighboring systems



In many cases, the radio must be pre-configured for legal maximum output power before connecting to the antenna and transmission system. Instructions for adjusting the output power can be found in this section (below) and in section 5.7.

The following information pertains to specific regulatory requirements based on up-to-date information for countries where the EX-5r is authorized. A list of recommended antennas can be found in section 4.3.

### 2.3.1 United States

The EX-5r operates under FCC Rule Parts 15.247 and 15.407 as a license-exempt device, and must be professionally installed. It may only be used as a point-to-point transmission device for fixed or temporary-fixed (non-mobile) installations. The device is subject to the following restrictions:

- External amplifiers may not be used to boost the power, or to overcome transmission system losses, unless the specific amplifier/cable/antenna combination has expressly been authorized by the FCC. The output power must never exceed +24dBm.
- Cross-border transmissions are expressly prohibited, except with written permission from both the FCC and the governing body of the neighboring country (Cofetel for Mexico, Industry Canada for Canada).
- Only parabolic dish antennas or directional flat-panel antennas may be used. No other types of antennas (omni-directional, etc.) are authorized. Parabolic dishes of either grid or solid type are allowed. Maximum gain of each type of antenna certified is:
  - Parabolic Dish: 37.5 dBi (6-foot diameter)

- Directional Flat Panel: 28 dBi (~2-foot square)
- Maximum transmit power for operation within the 5725-5850 MHz band, with respect to FCC (USA) EIRP regulations, is unlimited.
- Maximum transmit power for operation within the 5250-5350 MHz band, with respect to FCC (USA) EIRP regulations, is determined with the following equation:

$$P = 30 - G + L$$

Where:

$P$  = Maximum transmitter output power of radio, in dBm, not to exceed +13dBm

$G$  = Specified gain of antenna, in dBi, from 5250-5350 MHz

$L$  = Total transmission system losses of all elements between the radio's RF connector and the antenna's RF connector (all cables, connectors, lightning suppressors), in dB, as specified or measured between 5250 and 5350 MHz

For the 5725-5850 MHz band, the maximum EIRP allowed for this device is 67.5dBm. The maximum output power of the radio shall never exceed +30dBm.

For the 5250-5350 MHz band, the maximum EIRP allowed for this device is 30dBm. The maximum output power of the radio shall never exceed +20dBm.

The professional installer is responsible to assure that RF output power has been properly adjusted so that it does not exceed the regulatory limit, per these conditions.

### **2.3.2 Canada**

The EX-5r operates under RSS-210 of Industry Canada regulations. Operation is subject to the following conditions, unless express permission is granted by Industry Canada to operate in a different manner:

- External amplifiers may not be used to boost the power, or to overcome transmission system losses, unless the specific amplifier/cable/antenna combination has expressly been authorized by Industry Canada.
- Cross-border transmissions are expressly prohibited, except with written permission from both Industry Canada and the governing body of the neighboring country (FCC for USA)
- Only parabolic dish antennas or directional flat-panel antennas may be used. No other types of antennas (omni-directional, yagi, etc.) are authorized. Parabolic dishes of either grid or solid type are allowed. Maximum gain of each type of antenna allowed is:
  - Parabolic Dish: 37.5dBi (6-foot diameter)
  - Directional Flat Panel: 28 dBi (~2-foot square)

A complete list of allowed antennas can be found within the Industry Canada regulatory statement at the front section of this manual.

- Maximum transmit power for operation within the 5725-5850 MHz band, with respect to Industry Canada (IC) EIRP regulations, is unlimited.
- Maximum transmit power for operation within the 5250-5350 MHz band, with respect to Industry Canada (IC) EIRP regulations, is determined with the following equation:

$$P = 30 - G + L$$

Where:

P = Maximum transmitter output power of radio, in dBm, not to exceed +13dBm

G = Specified gain of antenna, in dBi, from 5250-5350 MHz

L = Total transmission system losses of all elements between the radio's RF connector and the antenna's RF connector (all cables, connectors, lightning suppressors), in dB, as specified or measured between 5250 and 5350 MHz

For the 5725-5850 MHz band, the maximum EIRP allowed for this device is +67.5dBm. The maximum output power of the radio shall never exceed +30dBm.

For the 5250-5350 MHz band, the maximum EIRP allowed for this device is +30dBm. The maximum output power of the radio shall never exceed +20dBm.

The professional installer is responsible to assure that RF output power has been properly adjusted so that it does not exceed the regulatory limit, per these conditions.

## 2.4 Time Division Duplex Factors

The EX-5r is a very dynamic radio, allowing the installer to optimize and control the performance of the radio system for the intended application. The following parameters need to be carefully determined during the link engineering phase:

- Link Distance
- Bandwidth
- TDD Frame Size
- Mode (modulation)

The setting of the above parameters will determine the following performance factors:

- Number of T1/E1 channels supported
- Ethernet throughput
- System latency (delay)

Use the **ExaltCalc** calculator to help determine the optimum settings for the above parameters to meet the needs of your application.

The following generalizations can be made with regards to these factors:

- The shorter the TDD Frame Size, the lower the latency
- The shorter the Link Distance, the lower the latency, the higher the throughput
- The longer the TDD Frame Size, the higher the throughput
- The higher the Bandwidth, the higher the capacity
- The higher the Mode, the higher the capacity



If there are no T1/E1 interfaces connected, all T1/E1 ports should be disabled. This will shift the available throughput to the Ethernet interface.



If a selected combination of Link Distance, Frame Size, Bandwidth and Mode cannot support all four (4) T1 or E1 ports, the ports that cannot be supported will be disabled automatically. Priority is placed on the T1/E1 port number. That is, the first port to be disabled, if necessary, is Port 4. More information on T1/E1 configuration can be found in Section 5.9.

## 2.5 Link Orientation and Synchronization

Link orientation refers to the Radio A and Radio B placement in your network. Link synchronization refers to using external or internal timing to coordinate multiple links.

As mentioned, for every link, one end of the radio link must be configured as Radio A, while the other end configured as Radio B. In single-link systems, it does not matter which end of the system is mounted at which end of the link, and there is typically no requirement for any link synchronization.

Link orientation and synchronization are more important for networks that have any site(s) where there is more than one EX-5 link or for EX-5 sites that are very close to one another.

Collocated radio terminals should be configured for the same link orientation. That is, all radios at the same location should be Radio A or all radios should be Radio B.

In addition, it can be advantageous to utilize link synchronization for collocated links. The EX-5r allows the use of an optional GPS synchronization kit or internal synchronization. This synchronization controls the transmitter and receiver frame timing so that collocated radios are transmitting at the same time and receiving at the same time. This can substantially reduce the opportunity for self-interference. Without synchronization, collocated radios may be transmitting and receiving at the same time, and thus, near-end interference may occur.



It is not always necessary to synchronize collocated radios. If antennas are substantially separated, or blocked from one another, and/or frequency separation tuning is used, the opportunity for near-end interference can be eliminated.

## **2.5.1 Default Settings**

It is advised to use the browser-based GUI, or alternatively, the Telnet CLI, to configure the radio terminals for Radio A and Radio B orientation. Since many other parameters also need to be set, and the GUI is needed for these configurations, this is the best way to completely configure the radio terminals.

If the radios are new from the factory or Exalt's authorized distributor, they will be set to the factory default configuration. In this case, both radios will be configured as Radio B. They will also be configured to the factory default settings for:

- Frequency = 5780 MHz
- Transmit Power = 4dBm
- Link Distance = <10 miles
- Bandwidth = 8MHz
- Mode = Mode 1
- TDD Frame Size = 2ms
- Link Security Key = 000000000000
- Administration Password = admin
- User Password = user
- IP address = 10.0.0.1
- IP mask = 255.0.0.0
- IP gateway = 0.0.0.0
- Ethernet Interfaces = Enabled; 100/Full
- AUX port NMS Access = in-band
- T1/E1 enabling = all circuits disabled
- DS3 enabling = all circuits disabled

If the current IP address of the radio is unknown, it may be necessary to “reset” some of the radio parameters to gain management access. A reset connector is provided in the accessory kit for this purpose.

To use the reset connector, follow these steps:

1. Remove power from the radio by disconnecting power from the power injector
2. Remove the data connector from the power injector (this is the connector normally connected to your local networking equipment NOT the connector leading up to the radio)
3. Connect the reset connector to the data port on the power injector
4. Apply power to the power injector
5. Wait 1 minute
6. Remove the reset connector
7. Replace the original data connector to the data port on the power injector

The following configurations are changed on the radio:



- IP address = 10.0.0.1
- IP mask = 255.0.0.0
- IP gateway = 0.0.0.0
- Administration password = admin
- User password = user
- Endpoint Identifier = Radio B

## Section 3 – System Installation and Initiation Process

### 3.0 Task Overview

The tasks for radio installation and initiation are outlined in the figure below.

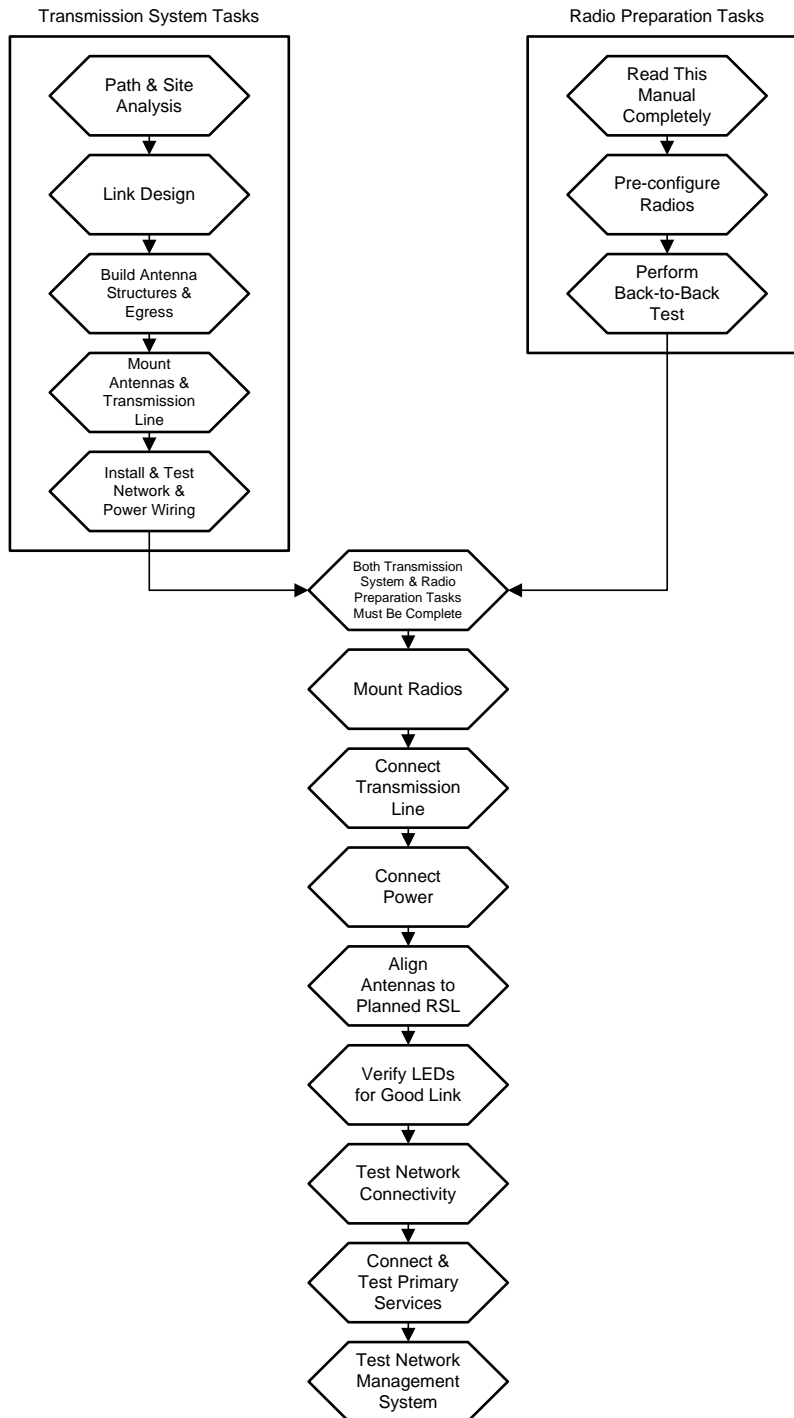

Figure 3-1: Radio Installation Flowchart

### **3.1 Record Keeping**

After installation, it is advised that the following items are recorded for the sake of ongoing maintenance and any future troubleshooting. A record should be kept for each end of the radio link. It is advised to store a copy of these records at the radio location, at the opposite end radio location, and a central record-keeping storage location.

- GPS coordinates for antenna locations at each site
- Antenna heights above ground level (AGL), as mounted
- Antenna model numbers, serial numbers and specifications
- Antenna polarization as mounted
- Length/type of primary transmission lines at each site
- Model number and serial number of RF lightning arrestor used
- Length/type of secondary transmission line(s)
- Transmitter output power setting as installed at each site
- RSL as measured after antenna alignment at each site
- Designed RSL per original design at each site
- RSL reading with far-end power off (from each end)
- Spectrum analyzer plot with far end off at each site
- VSWR/Return Loss at Radio's antenna connector at each site
- Radio's network management IP address at each site
- Radio's Network Management Gateway address at each site
- Radio's operating frequency, bandwidth setting, mode of operation
- Optionally purchased extended warranty and/or emergency service contract details

In addition, certain information may be desired for central record-keeping only:

- Security codes and login passwords (should be kept in a secure place or memorized)
- Photographs of complete installation
- End-user sign-off/acceptance documentation (if any)
- Photo of rear panel label (part number, serial number, MAC address information)
- Site access information phone numbers, access codes, directions

## Section 4 – Installation

### 4.0 Mechanical Configuration and Mounting

The EX-5r is an environmentally sealed unit intended for deployment outdoors. The device must be deployed within an ambient temperature range as specified and with non-restrictive airflow around the chassis. The external antenna version of the EX-5r may alternatively be mounted in an enclosure or indoors, if desired, under the same airflow and temperature conditions.

The EX-5r is accompanied by a power injector and power supply that must be placed indoors or in an enclosure.

With respect to the connections, proper clearance shall be provided for all cables and connectors that affix to the device. Most notably, for the external antenna version, the RF cable connector may require significant clearance for the bend radius of the coaxial cable assembly. If desired, a properly-specified 90-degree RF connector may be used on this connector to minimize clearance requirements. All RF connectors, cables and adapters must be rated for operation over 5250 to 5850 MHz and their losses must be accounted for within the link engineering design and output power settings.

#### 4.0.1 Pole Mounting the System

Pole mounting hardware for a pole from 2 to 5 inches diameter is included. It is advised to affix the radio to the pole mount bracket system first, then attach the entire assembly to the pole. However, if desired, the pole mount bracket system can be mounted to the pole first, and the radio connected after.

For the integrated antenna version, it is critical to mount the entire device at the predetermined location for proper path clearance to the opposite end. There should be adequate space around the mounting system and the radio to allow for antenna alignment for both azimuth and elevation adjustments.

For the external antenna version, it is advised to mount the radio as close to the antenna as possible, so as to minimize the length and associated losses of RF cabling.

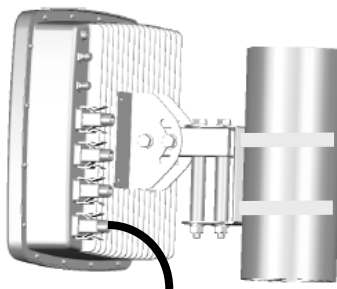

Figure 4-1: Pole Mount Mechanics

The pole-mounting bracket is affixed to the pole by using the two band clamp straps that are provided. Thread the band clamp straps through the mounting bracket, wrap around the pole, and thread through the adjustment end. Pull the straps by hand as much as possible, and using a screwdriver, the band clamps should be tightened until the entire assembly is secure.

If the radio was not attached to the bracket, tighten all mechanics of the bracket, and attach the radio.

For the integrated antenna version, gently loosen the nuts that hold the azimuth adjustment plate in place. Roughly align the radio by sight, to the rough azimuth of the link, and tighten the azimuth adjustment nuts.

If required, perform the same function for rough elevation adjustment.

## 4.1 User Interfaces

This section is intended to provide a brief familiarization of the connectors, controls and indicators on the device. More details about each item are found in other sections of this document. The EX-5r connections are shown here:

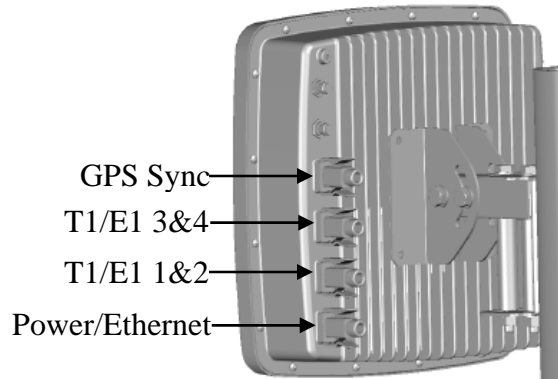

Figure 4-2: Connections

Connector	Type	Gender	Function
Antenna (0, 1 or 2)	N	F	(External antenna version only) Transmission line connection to antenna (on front face of unit)
T1/E1 (1&2, 3&4)	RJ-48C	F	Primary ports for User T1 or E1 circuits to traverse link
Ethernet/Power (Main/Aux)	RJ-45	F	Primary port for power and Ethernet (10BaseT or 100BaseT) to traverse link
GPS Sync	RJ-45	F	External radio synchronizing source (GPS) input
(Ground)	Threaded (M5) Receptacle	F	Chassis ground connection (M5 x 0.8 thread)

Table 4-1: Connectors

Detailed pin structures for each connector can be found in Appendix C.

### 4.1.2 Indicator Overview

The following table provides detail of the indicators on the EX-5r.

<b>Location</b>	<b>Type</b>	<b>Function</b>
Power/Ethernet Right Corner	Green LED	Solid = Radio is on with proper power Blink = Radio is booting Off = Radio is not powered, or fatal system failure
Power/Ethernet Left Corner	Green LED	Solid = Negotiated @ 100Mbps Blinking = Negotiated @ 10Mbps Off = No Ethernet link
T1/E1 1&2 Left Corner	Green LED	Solid = Input 1 connection present (clocking confirmed) Blink Fast = Input 1 connection present, coding/clock problem Blink Slow = Input 1 connection present but unexpected Off = Input 1 no connection/clock or interface/alarm is disabled
T1/E1 1&2 Right Corner	Green LED	Solid = Input 2 connection present (clocking confirmed) Blink Fast = Input 2 connection present, coding/clock problem Blink Slow = Input 2 connection present but unexpected Off = Input 2 no connection/clock or interface/alarm is disabled
T1/E1 3&4 Left Corner	Green LED	Solid = Input 3 connection present (clocking confirmed) Blink Fast = Input 3 connection present, coding/clock problem Blink Slow = Input 3 connection present but unexpected Off = Input 3 no connection/clock or interface/alarm is disabled
T1/E1 3&4 Right Corner	Green LED	Solid = Input 4 connection present (clocking confirmed) Blink Fast = Input4 connection present, coding/clock problem Blink Slow = Input 4 connection present but unexpected Off = Input 4 no connection/clock or interface/alarm is disabled
SYNC Left Corner	Green LED	On = Sync input connected Off = Synch input not connected
SYNC Right Corner	Green LED	Unused

*Table 4-2: Indicators*

## 4.2 Applying Power

The radio requires a DC power source within specifications, as stated. The DC may be provided from a DC battery source, central lab/rack supply or from the AC adaptor supplied. Read this section completely before applying power.

## **4.2.1 Terminating the RF Connector**

Before applying power, if using the external antenna version, the device's RF connector(s) must be properly terminated into a 50-ohm load. If this is not performed, the radio may be damaged by simply applying power. Also, for both the integrated and external antenna versions, there are human safety factors to consider regarding potentially harmful RF radiation.

There are a few simple means to accommodate this proper termination:

- Connect a 50-ohm coaxial termination device to the RF port of the radio. The termination needs to be rated to 1W (or more). Example(s) include:
  - Broadwave Technologies P/N 552-200-002, or similar
- Connect the complete transmission system. That is, the RF cabling including the antenna. The cabled antenna provides a proper termination for the RF output.
- Connect a fixed (or a series of fixed) 50-ohm attenuator(s) to the RF connector, either directly or at the end of an RF transmission line. The attenuator should be at least 30dB as specified between 5250 and 5850 MHz, and rated for a minimum of 0.5W input power. Examples include:
  - Broadwave Technologies P/N 352-103-xxx
  - Bird 2-A-MFN-xx
  - JFW Industries 50FP-xxx-H6-N

## **4.2.2 AC Power**

The AC adaptor comes equipped for easy direct connection to the power injector. The AC rating of the adapter accepts most worldwide standard voltages and frequencies. Please refer to the input voltage requirements stated on the label that is affixed to the adapter to assure that the adapter may be used with your AC mains supply. The AC plug outlet provided with the adapter may need to be replaced to match your country configuration. The adapter cable uses a standard connector for this cable so that you can simply use a pre-wired cable that is appropriate to your outlet configuration. If that type of cable is not available, the existing AC plug end can be severed and a replacement plug affixed. Consult a qualified electrician for this activity.

Do not plug the adapter into your mains power. First, verify that the RF connector is properly terminated (per section 4.2.1 above). Next, connect the supplied CAT5 cable between the Power/Ethernet connector on the radio and the Data+Power connector of the power injector. Now plug in the injector-side connector from the AC adapter to the injector. If your AC mains can be turned off by a switch, disable the power first, plug the AC side of the adapter into the AC mains socket, and then enable power to the circuit. If your AC mains cannot be turned off, simply plug into the AC main socket to apply power. Verify that the radio is active by observing LED activity. All LEDs on the radio will flash at initial power cycle, for the user to verify that all LEDs are operational.

It is strongly encouraged that the AC Mains supply be fused or on a breaker to ensure against over-voltage and/or over-current situations to provide some form of protection to the radio electronics and other devices that may be connected to the same supply. In addition, if your AC power is subject to significant spikes or variation, power conditioning is a worthwhile

investment, as the quality of mains power may have a direct impact on the device operation, performance and/or reliability. Many users will deploy an Uninterruptible Power Source (UPS) or other form of battery-backed system, to protect against brown-out and black-out conditions, as well as to condition the power being presented to the adapter.

It is also important to evaluate the opportunity for lightning or other similar surges to become present on the powering system, including the ability for surges to couple to the power wiring system. If an evaluation indicates that there is a potential likelihood for these conditions to occur, additional surge protection may be recommended for the input power wiring, especially for the CAT5 cable running from the injector to the radio.

The above statement is similarly true for every wired connection to the device. While the configuration for surge suppression or line conditioning is of a different type for each kind of signal interface, the opportunity for damage to the device, loss of communications and property can be significant. In some cases, there can also be a risk to human life by not protecting against lightning entering a building through wiring or improper grounding. If you do not have experience in this type of installation practice, it is strongly suggested that a qualified electrician and/or telecoms professional is consulted during the installation of the equipment and wiring.

### **4.2.3 DC Power**

The injector accepts direct DC power within the voltage specifications stated (48 Volts, nominal) and with enough current delivery capacity, also per the specifications stated. Using the proper DC connector and polarity (as shown on the injector), DC power may be directly connected to the injector. There are different system grounding considerations depending on the nature of the DC supply grounding, and your qualified electrician or telecoms professional should be consulted on the proper wiring and grounding process. Often, the injector housing should be properly grounded, and the DC source can be floating.

### **4.2.4 Reset to Critical Factory Settings**

If necessary, the radio terminal may be reset to critical factory settings. This may be necessary if the IP address and/or passwords for the system are not known. All other configurations are left at their current settings. If a complete default factory configuration is desired, the Default Configuration File may be loaded into the system, as described in sections 5.10 and 5.11.

The following parameters will be configured after a reset to critical factory settings:

- IP Address = 10.0.0.1
- IP Mask = 255.0.0.0
- IP Gateway = 0.0.0.0
- Administration password = admin
- User password = user
- Endpoint Identifier = Radio B (unless temporary hardware configuration key is installed)

To perform a reset to critical factory settings:



1. Remove power from the radio by disconnecting power from the power injector
2. Remove the data connector from the power injector (this is the connector normally connected to your local networking equipment NOT the connector leading up to the radio)
3. Connect the reset connector to the data port on the power injector
4. Apply power to the power injector
5. Wait 1 minute
6. Remove the reset connector
7. Replace the original data connector to the data port on the power injector

### **4.3 The Antenna/Transmission System**

This section provides general guidance to the mounting and connecting of the RF transmission system, consisting of the antenna, RF cabling and RF lightning arrestors. This section only applies when using the external antenna version.

Manufacturer's instructions for proper mounting, grounding and wiring of these devices should be consulted for definitive direction, and those instructions supersede any of the information in this section.

The following list of antennas is recommended in conjunction with this product. In some countries, antennas exceeding a certain level of gain may be unlawful. Refer to section 2.3 for details on regulatory limits.

<b>Manufacturer</b>	<b>Model #</b>	<b>Description</b>	<b>Gain dBi (mid-band)</b>
Andrew	P2F-52-N	2-foot Dish	29.4
Andrew	PX2F-52-N	2-foot Xpol Dish	29.4
Andrew	P3F-52-N	3-foot Dish	33.4
Andrew	PX3F-52-N	3-foot Xpol Dish	33.4
Andrew	P4F-52-N	4-foot Dish	34.9
Andrew	PX4F-52-N	4-foot Xpol Dish	34.9
Andrew	HP2F-52-NPA	2-foot HP Dish	29.0
Andrew	HPX2F-52-NPA	2-foot Xpol HP Dish	29.0
Andrew	HP3F-52-NPA	3-foot HP Dish	33.0
Andrew	HPX3F-52-NPA	3-foot Xpol HP Dish	33.0
Andrew	HP4F-52-NPA	4-foot HP Dish	34.5
Andrew	HPX4F-52-NPA	4-foot Xpol HP Dish	34.5
Andrew	HP6F-52-NPA	6-foot HP Dish	37.2
Andrew	HPX6F-52-NPA	6-foot Xpol HP Dish	37.2
Andrew	FPA5250D06-N	6-inch Panel	18.0
Andrew	FPA5250D12-N	1-foot Panel	23.6
Gabriel	DFPS.5-52	6-inch Panel	18.0
Gabriel	DFPD1-52	1-foot Panel	23.5
Gabriel	DFPD2-52	2-foot Panel	28.0
Gabriel	QF2-52-N	2-foot Dish	28.5
Gabriel	QF2.5-52-N	2.5-foot Dish	31.2
Gabriel	QF4-52-N	4-foot Dish	34.8
Gabriel	QFD2-52	2-foot Xpol Dish	28.4

Gabriel	QFD2.5-52	2.5-foot Xpol Dish	31.1
Gabriel	QFD4-52	4-foot Xpol Dish	34.7
Gabriel	HQF2-52-N	2-foot HP Dish	28.2
Gabriel	HQF4-52-N	4-foot HP Dish	34.4
Gabriel	HQF6-52-N	6-foot HP Dish	37.4
Gabriel	HQFD2-52	2-foot Xpol HP Dish	28.1
Gabriel	HQFD2.5-52	2.5-foot Xpol HP Dish	30.7
Gabriel	HQFD4-52	4-foot Xpol HP Dish	34.3
Gabriel	HQFD6-52	6-foot Xpol HP Dish	37.3
MTI	MT-485001	7.5-inch Panel	19.0
MTI	MT-485002	1-foot Panel	23.0
MTI	MT-486004	18-inch Panel	26.0
MTI	MT-486001	2-foot Panel	28.0
MTI	MT-485005	7.5-inch Xpol Panel	18.0
MTI	MT-485025	15-inch Xpol Panel	23.0
Proxim	5054-WA-15-STN	Window Panel	15.0
Radio Waves	FP.5-5-18	6-inch Panel	18.0
Radio Waves	FP1-5-24	1-foot Panel	23.8
Radio Waves	FP2-5-28	2-foot Panel	28.0
Radio Waves	FPD.5-5-18	6-inch Xpol Panel	18.0
Radio Waves	SP1-5.2	1-foot Dish	22.5
Radio Waves	SP2-5.2	2-foot Dish	29.0
Radio Waves	HP2-5.2	2-foot HP Dish	28.6
Radio Waves	SP3-5.2	3-foot Dish	32.0
Radio Waves	SP4-5.2	4-foot Dish	34.8
Radio Waves	SPD2-5.2	2-foot Xpol Dish	28.1
Radio Waves	SPD3-5.2	3-foot Xpol Dish	31.1
Radio Waves	SPD4-5.2	4-foot Xpol Dish	34.4
Radio Waves	SPD6-5.2	6-foot Xpol Dish	37.5
RFS	SPF2-52A	2-foot Dish	27.9
RFS	SPF3-52A	3-foot Dish	31.4
RFS	SPF4-52A	4-foot Dish	33.9
RFS	SPF6-52A	6-foot Dish	37.4
RFS	SDF4-52A	4-foot HP Dish	33.9
RFS	SDF6-52A	6-foot HP Dish	37.4
RFS	MA0528-19AN	7.5-inch Panel	19.0
RFS	MA0528-23AN	1-foot Panel	23.0
RFS	MA0528-28AN	2-foot Panel	28.0

*Table 4-3: Recommended Antennas*

### **4.3.1 Initial Antenna Mounting**

The antenna should be the exact model recommended by the path and site planning engineer(s). The antenna should be mounted at the proper height, mast/mounting location and polarization orientation also as determined by the path and site planning engineer(s). The model type, location and orientation of the antenna is critical with respect to achieving proper path clearance as well as to mitigate external or self-interference from nearby or co-located systems operating in or near the same frequency band.



The antenna shall be mounted in a restricted area and in a manner which prevents long-term human exposure to the transmitted RF energy. To comply with FCC and Industry Canada regulations, the minimum safe distance from the antenna for continuous human exposure is 22 feet (6.7m). Warning signage may be required in accordance to federal or local regulations.

The antenna structure must be secure and safe with respect to the mounting of the antenna, transmission system weight, and the combined weight of any personnel that may climb or attach to the structure. The combined weight of items and forces on the structure must be carefully considered in the design and construction of the structure. This must include the weight bearing on the structure in the highest wind conditions possible in the region, and with respect to all objects that may be affixed to the structure.

If additional objects may be affixed to the structure in the future, it may be important to evaluate both the mechanical impact of these planned additions (with respect to wind and weight loading) as well as the potential impact to RF interference and frequency coordination if additional radio equipment is anticipated. This is especially important if future equipment is likely to operate within the same frequency band.

Once you have mounted, cabled and aligned the antenna, your goal will be to never require modification, so this prior planning can be important in the path and site planning stage, and the construction of the antenna structure.

Follow the antenna manufacturer's instructions for mechanical mounting of the antenna. Make sure that there will be enough room around the antenna to allow for alignment activities (moving the antenna in vertical and horizontal arcs) and for the RF transmission line to connect to the antenna connector unobstructed and within the specified bend radius requirements of the transmission line.

At this point, the antenna mounts should be fully secure to the structure, the feed of the antenna securely mounted to the antenna (if the feed is a separate assembly), and the azimuth and elevation adjustments not completely tightened to prepare for the antenna alignment activity. It is a good practice to connect the transmission line to the antenna connector as early in the process as possible, so as to reduce the opportunity for debris or moisture to enter either the antenna connector or the transmission line connector. Otherwise, a connector cover or other temporary measures can be taken to keep the connector clear. Extra care must be taken if the antenna is installed during inclement weather to be certain that no moisture gets inside the antenna connector at any time.

The antenna may be aimed at this point in the general direction required for the link. Using a compass, a reference bearing, binoculars or any other similar device, you may point the antenna in the direction (generally) of the far-end, and slightly tighten the azimuth and elevation adjustments enough so that the antenna maintains its general position and is safe to be left without additional securing. See the Exalt White Paper entitled **Antenna Alignment** for more information on the general topic of antenna alignment techniques.

### **4.3.2 Transmission Line from Antenna to Radio**

For the external antenna version, most installations use coaxial transmission line for the connection between the antenna and the radio device. In typical EX-5r installations, this coaxial transmission line is very short, and may not require or benefit from RF lightning protection. However, a properly grounded RF lightning protection device is recommended, where necessary, and is highly recommended when the RF cable length exceeds 10 feet.

Coaxial transmission line may be either solid-shield or braided-shield variety. Solid-shield cables are more resistant to external signal coupling and interference, but are generally stiffer than braided cables. The path or site engineer(s) should be consulted to assure that the proper materials were chosen for the installation with all factors considered.

Generally, the larger the diameter of the transmission line, the lower the loss. So for longer runs of transmission line, larger diameter cables are highly advised. However, at every frequency, there is a maximum diameter cable that will support the operating frequency, so be certain to verify the specifications. This should have all been determined during the path and site planning process.

In some cases, the choice of transmission line will not be coaxial cable, but instead will be air-dielectric waveguide. This is an expensive solution and is generally not necessary, but may be required for very long transmission line runs and/or for very long link distances and/or for systems that require extremely high reliability.

The following is a representative sample of transmission line types that are recommended for this radio:

- Andrew HELIAX® LDF4-50, 1/2-inch solid copper shielded coaxial cable, 6dB/100ft.
- Andrew HELIAX® LDF4.5-50, 5/8-inch solid copper shielded coaxial cable, 4.7dB/100ft.
- Times LMR-600, 1/2-inch braided coaxial cable, 7.3dB/100ft.
- Times LMR-900, 5/8-inch braided coaxial cable, 4.9dB/100ft.

There are several other brands and models of transmission line that are perfectly acceptable. As mentioned, for extremely long transmission lines and/or extremely long radio paths, it may be necessary to use waveguide transmission line instead of coaxial transmission line. In these cases, waveguide type EW52 is recommended, with a loss of 1.3dB/100ft.

It is critical that the transmission line and antenna be capable of supporting the same type of connector, or easily adapted. Keep in mind that it can be important to minimize the number of connectors and adaptors, so it is ideal if they match directly without adaptation. In most cases, transmission line will allow for N-type male connectors and antennas have N-type female connectors. For waveguide, the waveguide flange can typically accommodate a direct adapter to an N connector, or alternatively, the antenna can be purchased with a direct waveguide connection. But often a flexible coaxial jumper is needed to connect between the waveguide to the antenna, as waveguide is generally inflexible and can be mechanically challenging to align to the exact antenna connector location.

If possible, connect the primary transmission line directly to the antenna. It is desired to have the fewest possible pieces of transmission line in the system, to minimize losses and points of failure from connectors, and the antenna can typically accommodate a direct connection if planned in advance. You may use a 90-degree adaptor for the connection to the antenna, if necessary – but be certain to confirm that all connectors and transmission lines are properly specified for the operating frequency (5250 to 5850 MHz, in this case) with minimum loss, proper impedance (50 ohm) and proper Voltage Standing Wave Ratio (VSWR) characteristics.

Transmission line connector termination is perhaps the most critical element of the installation. Many ‘factory built’ RF transmission lines may actually not provide the proper characteristics for proper transmission, despite their published specifications, often due to the fully- or semi-automated process of factory termination, which may not have considered the frequency of your system. When buying pre-terminated transmission line, it is strongly advised to receive documentation of the test measurements on the connected transmission line showing that the loss characteristics and VSWR are within specified limits specifically at your operating frequency. In addition to factory-built transmission line, self-terminated transmission line can suffer the same issues. Always follow the manufacturer’s termination process EXACTLY, and only use the manufacturer’s authorized tools and connectors for a given transmission line type. The manufacturers of transmission line typically offer instruction and certification for transmission line termination, and may also provide videos illustrating the process. There is no amount of extra care, education, precision and effort that can be overstated for this process.

Once the transmission line is connected to the antenna, traverse the exact route provided by the site planner (if applicable). There may be a need for a small excess of transmission line near the antenna to accommodate both the need for extra slack as the antenna is loosened and moved for the alignment process, as well as to accommodate a drip loop for the transmission line, and the initial transmission line securing hardware and grounding near the antenna. In addition, the transmission line is typically very stiff, and can provide undue pulling force on the antenna connector. Take care to align the cable with the connector in a manner that does not provide any torque or strain on the connector.

Consult your transmission line manufacturer for proper transportation, hoisting, securing and grounding process. Always be very mindful to the entire length of transmission line to assure that the transmission line is never twisted or kinked or over-bent past the specified bend radius. Once a transmission line is over-bent or kinked, it will likely never recover its specified characteristics, even after straightening and will often be completely unusable.

The opposite end of this primary transmission line will typically terminate directly into the externally-mounted radio. When the radio is mounted in an enclosure or indoors, the transmission line will typically terminate at the building or enclosure egress point. This is the location where the RF lightning arrestor shall be located. A proper termination to the connector-type of the lightning arrestor shall be made at this location. Once again, a drip loop may be required, and proper securing hardware and grounding needs to be accommodated.

As soon as practical, the connected ends of the transmission line to the antenna and lightning arrester should be weatherproofed, but this process should be delayed as long as possible to be certain that all systems are working properly before weatherproofing is applied, as once weatherproofing is applied, you may be required to remove it if any tests or changes are needed before installation is complete. With this in mind, if the installation is occurring during inclement weather, extra care must be taken at all times to assure that no moisture enters any connector at any time. If moisture is suspected to have compromised the antenna or transmission line, it may render those devices useless without any means for remedy except for full replacement.

It bears mention that on rare occasion, the antenna might be mounted indoors and behind a window. In these cases, there would not be a need for drip loops or an RF lightning arrester. In cases such as these, a very short transmission line can typically be connected directly between the antenna and the radio mounted nearby. In these cases, the weatherproofing process can also be omitted.

### **4.3.3 RF Lightning Arrester**

The purpose of the RF lightning arrester is to provide a direct path to ground for any lightning strike that may couple to or directly hit the outdoor transmission system or antenna structure. As such, the RF lightning arrester prevents the associated voltage and current from entering the building or enclosure, where it might harm the radio equipment, other equipment, or humans.

The following lightning arrestors are examples of proper devices for this model:

- Polyphaser AL-LSXM
- Andrew BB-BNFE-26

The RF lightning arrester shall be mounted and grounded in accordance to the manufacturer's recommendations. It shall be placed as close as possible to the radio, if the radio is mounted outdoors, or for indoor-mounted radios, at the egress point where the next piece of transmission line enters the building or enclosure. Minimize the distance to the egress to lessen the opportunity for lightning to couple to or strike the section of transmission line that is unprotected (if any). Where possible, a bulkhead connector should be used to eliminate any opportunity for this risk. If cable lengths behind the arrester and into the egress are kept substantially short (less than 1m), this is typically considered safe practice. Your qualified electrician or installer shall be consulted in all cases of grounding and lightning arrester implementation.

### **4.3.4 Transmission Line from Egress to Radio**

Once again, it is desired to have a single transmission line section from the egress to the radio RF connection. Always minimize the number of connectors and adaptors. For indoor runs, a cable ladder or tray may be needed to properly secure the cable. In some cases, a short flexible jumper may be needed to allow for ease of connection to the radio's RF connector. A properly specified 90-degree connector can often eliminate this need. Or an installation with space accommodated around the radio for a gentle bend radius of the transmission line can also accommodate a direct

connection. In all cases, be certain that the transmission line is not providing any pulling force onto the RF connector of the radio. Transmission lines can be very stiff, and can damage the connector if not dressed properly. Also, follow the transmission line manufacturer's instructions for proper cable securing devices.

## 4.4 Antenna Alignment

Antennas must be installed at both ends of the planned link to commence precision alignment. Refer to the Exalt White Paper entitled **Antenna Alignment** for more information on this topic.

Antennas are typically aligned using the radio hardware to aid in the precision alignment process. However, there are many very useful tools available to aid in this process, inclusive of devices that are specifically designed solely for the purpose of aligning antennas. Some examples of these devices are:

- XL Microwave Path Align-R
- Teletronics 17-402

Using these devices can be extremely advantageous compared to using the radio, as they employ many unique facilities to aid in this process. In addition, using these tools makes it possible to align the antennas before the radio equipment is delivered on site. However, many installers routinely use the radios as the means for antenna alignment, and they have much success with this method as well.

If using the radio, there are two primary facilities to aid in antenna alignment:

- Internal alignment beeper
  - This function must be enabled within the GUI or by CLI. When enabled, the beeper frequency rises as RSL increases and falls when RSL decreases. Align the antennas separately for azimuth and elevation, at each end separately, until the highest beeper frequency is reached. Then disable the beeper function using the GUI or CLI.
- Browser-based GUI interface RSL reading
  - The browser-based GUI interface of the radio indicates the current RSL in dBm.

The browser-based GUI should only be used for antenna alignment if using the beeper is not practical. If this method is required, refer to section 5.2 for instruction on using the browser-based GUI. The RSL reading can be read on a PC or any handheld computing device that supports an HTML browser and Ethernet connectivity.



There is a slight delay in RSL reading on the browser-based GUI as RSL levels change. In this case, fine alignment should be done in small adjustments, with a small gap of time, to see the impact of the adjustment on the GUI display.

## Section 5 – Configuration and Management

### 5.0 Using the Command Line Interface (CLI)

The EX-5r utilizes a CLI through a Telnet (Ethernet) connection as a means to set key parameters on the system.

#### 5.0.1 Connecting to the Radio with a Telnet Connection

For a Telnet connection to the radio through the Ethernet AUX port, using Windows OS, perform the following steps:

- Open a Command Prompt, or MS-DOS prompt (Start>Run>cmd)
- Enter the following at the command line of the command prompt window:  
C:\>Telnet <IP Address>  
Note: The default IP address of the EX-5r is **10.0.0.1**  
Note: You may reset the IP address to the default address by radio reset (as described in section 4.2.4)  
Note: Your computer needs to be in the same IP subnet as the radio to use the Telnet function.

### 5.1 Using the CLI

Using CLI, when prompted, enter the administration level login and password:

The default administration login is **admin** and password is **admin**

You may reset to the default administration password by performing a radio reset (as described in section 4.2.4)

After logging in, there are three menu choices available as shown.

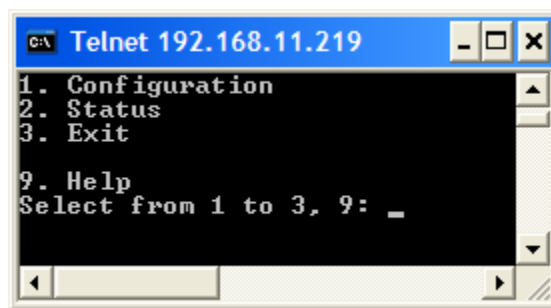

Figure 5-1: Main CLI Menu



Selecting 1 or 2 will reveal the Configuration or Status menus respectively. Selecting 3 will exit from the CLI/Telnet session.

For all screens, the following selections can be made:

- 0 = back to previous screen
- 9 = help
- Ctrl+\ (control and backslash keys) = exit session

The following table depicts the complete CLI tree structure:

1. Configuration
  1. IP address and Mask
  2. IP default gateway
  3. Administration
    1. System time and date
    2. System reboot
    3. Password
    4. File transfer
    5. File activation
2. Status
  1. Refresh summary (not active in this release)
  2. More...
    1. Radio alarm
    2. Radio performance
    3. Radio performance reset
    4. Radio status
    5. Radio log

Table 5-1: CLI Tree Structure

## 5.2 Introduction to the Graphical User Interface (GUI)

The browser-based GUI provides the primary user interface for configuration and troubleshooting of the radio and radio system.

A computer or hand-held device with a conventional html browser and Ethernet port is required. Microsoft Internet Explorer is the preferred browser to use with the EX-5r, however other browsers may operate without issue.

### 5.2.1 Preparing to Connect

If the radios are new out-of-the box, both radios will be configured as Radio B, and both radios will have the same (default) IP address. The initial priority will be to configure one radio to Radio A, and to have two different IP addresses assigned, one unique to each radio.

Regarding IP address, follow these instructions to change to your desired IP address:

1. Connect to the browser-based GUI using the default IP address, and change the IP address through the GUI interface, as described in this section.



The factory default IP address of the radio is **10.0.0.1**



If you do not know the radio's current IP address, you may perform a radio reset as described in section 4.2.4.



In order to connect to the radio's Ethernet port and use the browser-based GUI interface, your computer will need to match the radio's IP address subnet. With this in mind, either change the radio's IP address through the CLI to match the subnet of your computer, or change your computer's IP address to match the subnet of the radio's IP address (such as a computer IP address of 10.0.0.10 if trying to connect to a radio set to the factory default IP address of 10.0.0.1).

One end of the link must be configured to Radio A configuration. Connect to the browser-based GUI, and change the configuration through the GUI interface, as discussed in this section.

### 5.2.2 Making the Connection

It is best/easiest to configure one radio at a time, on a bench, before taking the radios to the field for installation.

- If using the external antenna version, terminate the RF connector with a 50-ohm termination or a fixed attenuator of at least 20dB. See section 4.2.1.
- Apply power to the radio. See section 4.2.2 or 4.2.3.



At this point, do not connect the radios in a back-to-back configuration. If the radios are currently set to factory default settings, both radios are configured as Radio B and will not communicate, and both radios will have the same IP address, which will cause configuration issues.



As mentioned in section 5.2.1, your computer's IP address subnet must match the radio's IP address subnet to connect via Ethernet.

Once you have connected to the radio using Ethernet, you are ready to login to the browser-based GUI.

### 5.2.3 Logging In

Launch your computer's browser software. Microsoft Internet Explorer is the recommended browser, but other browsers may also provide full functionality. If there are issues with other browsers, you are encouraged to report them to Exalt customer service, however, you may be required to use a different browser to overcome issues immediately.

On the browser address bar, type the IP address of the radio, as shown below.

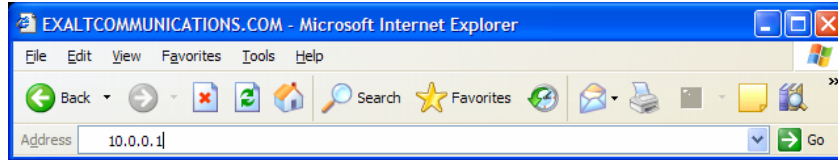

Figure 5-2: Initiating Browser Connection

After pressing the return/enter key on your keyboard, or the Go button on the browser, the following window will appear.

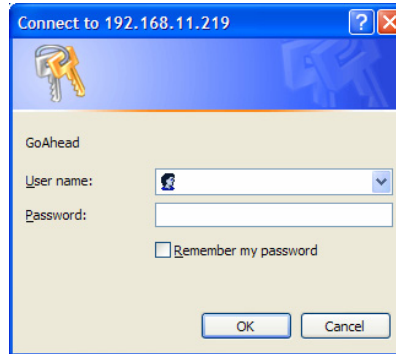

Figure 5-3: Browser Login Window

## 5.2.4 Login Privileges

There are two levels of privileges for login:

- Administrator (admin) – Has complete rights to view, edit and configure
- User (user) – Has rights for limited viewing only with no edit or configuration rights

The default login names and passwords are as follows:

	<b>User name</b>	<b>Default Password</b>
Administrator	admin	admin
User	user	user

Table 5-2: Default Login Information

For the purposes of configuration, the Administrator login credentials will be needed. Type the user name and passwords for Administrator level and press OK. The screen below should be displayed.

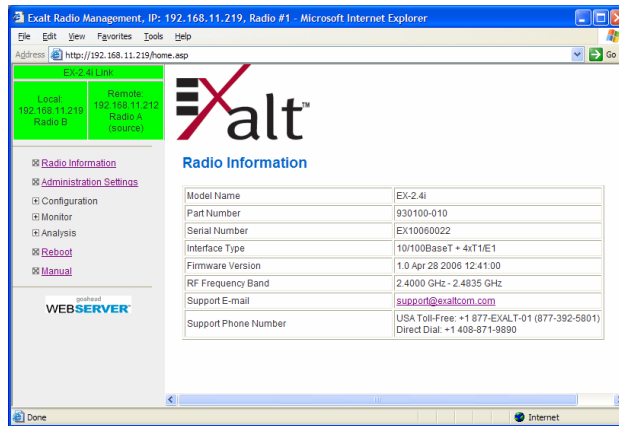

Figure 5-4: Radio Information Page

### 5.3 Quick-Start

At this stage, it may be desirable to apply some basic configurations to the radio terminal so that a link can be established on the bench.

Follow the steps in the **Quick Start Guide** that came with the radio. A summary of the items that need to be configured is listed here.

- Set Radio IP Address at each end.
  - Each end should have a different IP address from each other and also not match your computer's IP address or any address already assigned if the radios will be part of a larger network.
  - It may be required to change the IP address of your computer after you have changed the IP address of the radio so that the IP subnet is matching.
  - Radio IP address is on the **Administration Settings Page**
- Set one radio to Radio A, and the other to Radio B
  - The radio selected as Radio A needs to be configured.
  - Radio A/B selection is on the **System Configuration Page** called "**Endpoint Identifier**"
  - Even though both radios are defaulted as Radio B, this should configuration should be confirmed on the radio intended to be Radio B.

If all other parameters are still configured at factory default settings, the radios may now be connected back-to-back to verify that the link is communicating and to perform any other tests desired. Back-to-back bench testing is described in Appendix B.

Section 5.4 describes each page of the GUI in more detail. Most of the configuration parameters are fairly intuitive. The following parameters must match at both ends in order for the link to communicate.

- Link Security Key (Administration Settings Page)
- Bandwidth (System Configuration Page)
- RF Frequency (System Configuration Page)

- Link Distance (System Configuration Page)
- TDD Frame Size (System Configuration Page)



Changing any of these parameters will cause a temporary loss of link. The GUI will warn of this condition and will provide an opportunity to cancel changes.

## 5.4 Graphical User Interface Fundamentals

The browser-based Graphical User Interface (GUI) provides the primary interface for all configuration and management.

There are three primary sections of the GUI:

- Summary status information section (in the upper left corner)
- Navigation tree (along the left edge)
- Main window

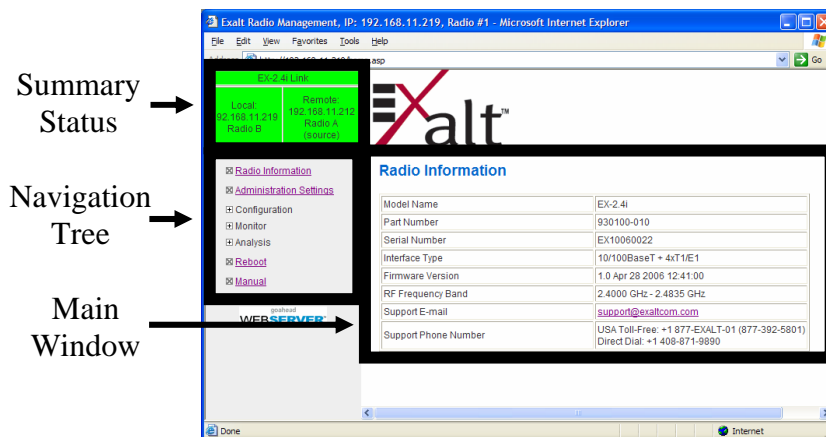

Figure 5-5: GUI Sections (Radio Information Page)

### 5.4.1 Summary Status Section

This section provides an easy at-a-glance review of the system status.

The top bar illustrates the alarm condition of the link. The background color of this bar is equivalent to the color of the LINK LED on the radio front panel(s), as described in section 4.1.2. The information inside the bar is equivalent to the entry of the Link Name, as set by the Administrator in the **Administration Settings Page**, as described in section 5.6.

The background color of the left box illustrates the summary alarm conditions of the local radio (the radio that matches the IP address to which you are connected). The color follows the same convention as the rear panel SUMMARY LED, as described in section 4.1.2. The information inside the bar illustrates the IP address and the Endpoint Identifier (Radio A or Radio B).

The background color of the right box illustrates the summary alarm conditions of the remote radio (the radio that is linked to the local radio).



The **'local' radio might be the near-end or the far-end radio**, depending on how you have connected to the radio's management interface. The terms 'local' and 'remote' simply refer to the orientation of the radio terminals relative to the IP address that you are managing. When making certain changes to a near-end radio without first making changes to the far-end radio, it is possible to disconnect the link unless configuration changes are made back to their original settings. When making changes that have the opportunity to disrupt the link, **always change the far-end radio first, then the near-end radio to match.**

The Summary Status Section can allow the browser-based GUI to be used as a rudimentary management system. Shrink the browser window to display just the top bar or also the radio information, and several separate browsers may be placed on your computer desktop simultaneously. When a window status changes to yellow or red, you may quickly expand that browser window to determine the issues.

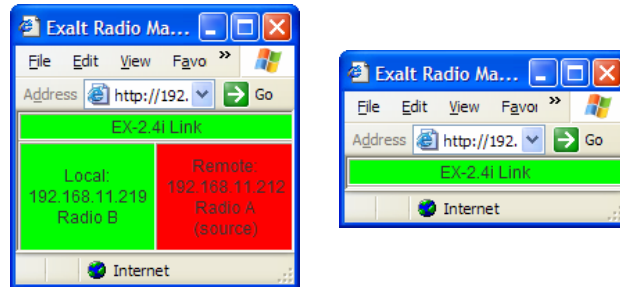

Figure 5-6: Collapsed Browser Windows for Summary Status of Multiple Radios

## 5.4.2 Navigation Section

Navigating the browser-based GUI is similar to browsing folders on a typical window-based computer.

The menus that can be expanded are illustrated with a plus (+) to the left of the page name. Clicking on the plus or on the page name title will expand the menu to reveal sub-menus that are available. Likewise, menus may be collapsed when a minus (-) sign appears to the left of the page name.

Management pages are indicated with an X to the left of the page name. Clicking on the X or on the page name will reveal the specific page within the main window.

## 5.5 Radio Information Page

This page provides general information about the local radio terminal. This information can be very helpful in a troubleshooting situation and for your records.

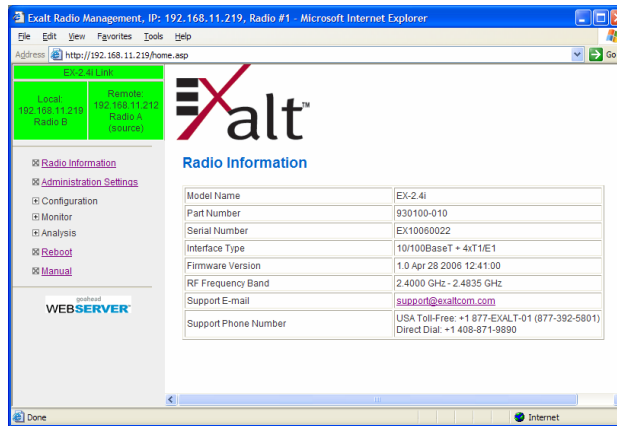

Figure 5-7: Radio Information Page

## 5.6 Administration Settings Page

This page allows entry of many general parameters for the radio system. The current entries are listed in one column, and any changes desired may be entered in the New Value column.

After all of the desired changes are entered in the New Value column, pressing the UPDATE button will enact these changes.

Most of the entries on this page are self-explanatory. Unique or important items are listed below.

- The date and time fields should be filled in as soon as practical. Events are captured with time/date stamps that can be very valuable information for troubleshooting.
- The link security key should be set to something other than the factory default setting (12 characters, all zeros) at each end. The security key must match at both sides of the link. Leaving the security key at the factory default setting makes the radio link open for hacking by an experienced RF hacker with the same radio model. Also, it is advisable to use a unique security key for each link. Using the same security key for every link in your network may allow the radio to link to any other radio with the same security key, which can be problematic in multi-radio networks.
  - The security key must be exactly 12 characters long. Any printable ASCII character may be used in any position. The security key IS case sensitive.



**Changing the link security key will interrupt data transmission until the opposite end is changed to match. Always change the far-end radio first, then the near-end radio. The temporary mismatched security key may also mute the Ethernet connection (depending on the selection of in-band or out-of-band management, and which Ethernet connector is used for management). It may be necessary to physically connect to the AUX port to gain access to the GUI so that the second radio's security key can be changed to match, at which point the link and traffic will return to normal. Alternatively, the link security key can be changed on each terminal, individually, when there is no link between the radios.**

- Admin and User passwords should be set to something other than the factory default setting, and should not match each other. Leaving the Admin password at the factory

default setting leaves an opportunity for anyone on the connected network to hack into the radio and change settings.

- The system requires that you type the changed password twice, once in the main window and once again in the confirmation window below. If the passwords do not match, and the UPDATE button is pressed, the password will not change, and will remain set to the previous password.

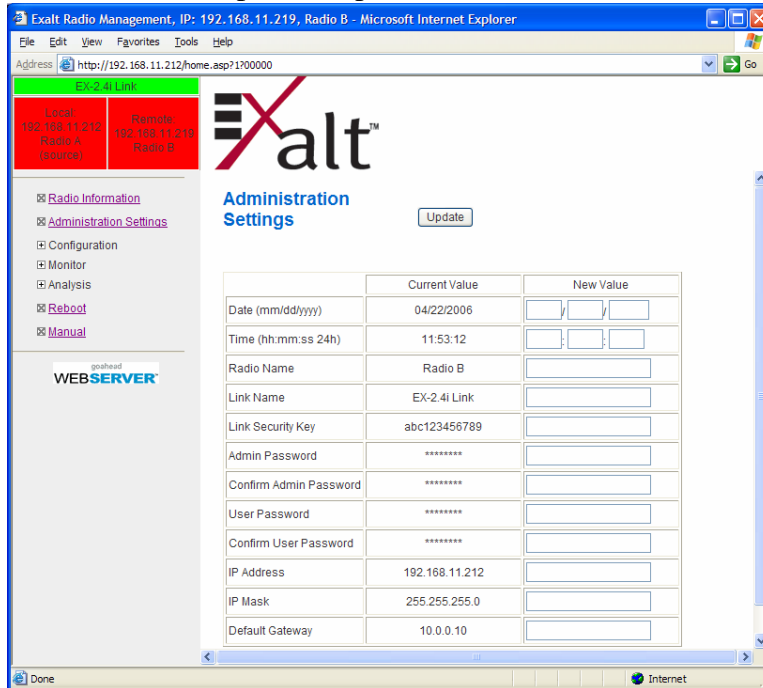

Figure 5-8: Administration Settings Page

## 5.7 System Configuration Page

The System Configuration Page allows adjustment of several critical system parameters.

Most of the entries on this page are self-explanatory. Unique or important items are listed below.

- Radio Transmit Power must be set to the designed level. The professional installer shall set this value, or dictate the value of this setting to the system administrator per the system design and local regulations. In many cases, the setting of this value must be proper in order to comply with legal restrictions that apply to the use of this device. Improper setting can result in liability to the user and/or installer.



**Changing Radio Transmit Power may temporarily interrupt traffic.** Small changes in output power will normally not interrupt traffic, but larger changes may. Do not adjust Radio Transmit Power to a value higher than is legally allowed. Do not adjust Radio Transmit Power lower than the link budget and fade margin can afford. **The link may be lost and unrecoverable** through GUI control. If the link is lost due to reduction of Radio Transmit Power, travel to the radio location(s) may be required to reset the value.



- Bandwidth must be set to the designed level. The value of this setting should have been determined in the design/engineering stage. The Bandwidth setting must also match at both ends of the link. The Bandwidth setting directly relates to the capacity, latency and the number of TDM circuits that can be supported. It may also be critical to set this with respect to the local RF noise and interference profile, and/or in relation to any multi-link network design.



**Changing Bandwidth *will temporarily interrupt traffic.* The Bandwidth setting must match at each end** – adjust the far-end radio first, then the near-end radio.

Changing Bandwidth will change the radio's threshold. A narrower bandwidth has better threshold performance, therefore if changing to a wider bandwidth, there is an opportunity that **the link may be lost and unrecoverable** through GUI control. Check the available fade margin and determine if the impact to threshold will be sufficient to maintain the link and the desired performance. If the link is lost due to increasing Bandwidth, travel to the radio location(s) may be required to reset the value.

- RF Frequency must be set to the designed point. The value of this setting should have been determined in the design/engineering stage. The RF Frequency must also match at both ends of the link. It may be critical to set the RF Frequency with respect to the local RF noise and interference profile, and/or in relation to any multi-link network design.



**Changing RF Frequency *will temporarily interrupt traffic.* The RF Frequency setting must match at each end** – adjust the far-end radio first, then the near-end radio.

If the RF Frequency is changed to a frequency that has interference, there is an opportunity that **the link may be lost and unrecoverable** through GUI control. If the link is lost due to changing RF Frequency, travel to the radio location(s) may be required to reset the value.

- Endpoint Identifier **must be set so that one end of the link is set to Radio A and the opposite end set to Radio B.** In single-link networks, it is unimportant which end is designated A or B. However, in multi-link networks, it may be important to orient the links so that, at any co-location site (where there are multiple radios of the same type at the same site), all radios have the same Endpoint Identifier (all A or all B). See section 2.5 for more information.



**Changing Endpoint Identifier initiates a reboot of the radio. The reboot will temporarily interrupt traffic.**

- Link Distance **must be set to the range that is equal to or greater than the actual link distance.** The value of this setting should have been determined in the design/engineering stage.



**Changing Link Distance *will temporarily interrupt traffic.* The Link Distance setting must match at each end and must not be less than the actual link distance** – adjust the far-end radio first, then the near-end radio.

If the Link Distance is changed

to a setting that is less than the actual distance there is an opportunity that **the link may be lost and unrecoverable** through GUI control. If the link is lost due to this situation, travel to the radio location(s) may be required to reset the value. If the Link Distance setting is set to a distance that is unnecessarily higher than the actual link distance, the radio may have **substantially reduced performance** with respect to throughput and latency.

- TDD Frame Size must be set to the designed level. The value of this setting should have been determined in the design/engineering stage. The TDD Frame Size must also match at both ends of the link. The TDD Frame Size setting directly relates to the capacity, latency and the number of TDM circuits that can be supported over the given link distance. In multi-link networks, especially where there are collocated links, it may also be important to set all radios to the same TDD Frame Size to avoid self-interference. The (future) GPS or internal synch function may be necessary for these types of networks. See sections 2.4 and 2.5 for more information.



**Changing TDD Frame Size will temporarily interrupt traffic. The TDD Frame Size must match at each end** – adjust the far-end radio first, then the near-end radio. If the TDD Frame Size is set to a value that cannot be supported for the link distance, there is an opportunity that **the link may be lost and unrecoverable** through GUI control. If the link is lost due to this situation, travel to the radio location(s) may be required to reset the value.

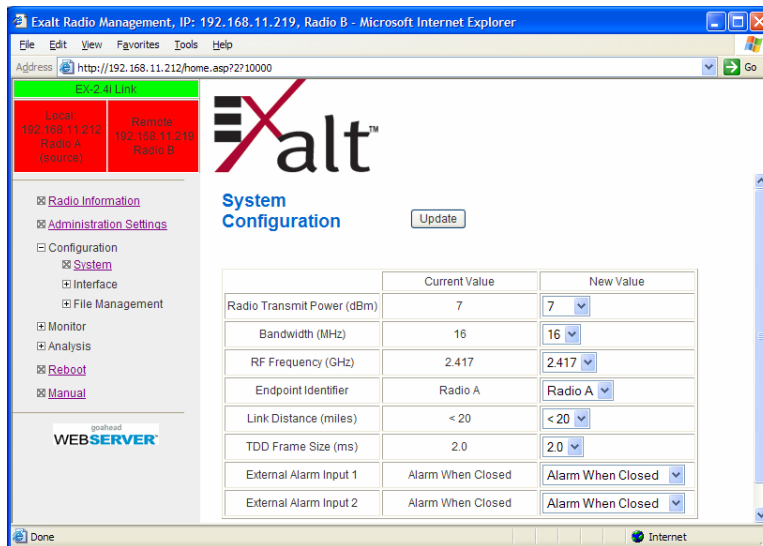

Figure 5-9: System Configuration Page

## 5.8 Ethernet Interface Configuration Page

The Ethernet Interface Configuration Page allows the administrator to set the alarming and duplex settings of the Ethernet connection.

Depending on the connected equipment, optimum Ethernet performance may be achieved by a variety of combinations of speed/duplex settings. That is, the system may perform best if both

devices (the radio and the connected equipment) are set to auto-negotiate, both hard set to 100/Full, or one set to 100/Full and the other auto-negotiate. Device performance varies widely. Therefore, it can be advantageous to attempt different combinations of settings to determine the best combination for your application.

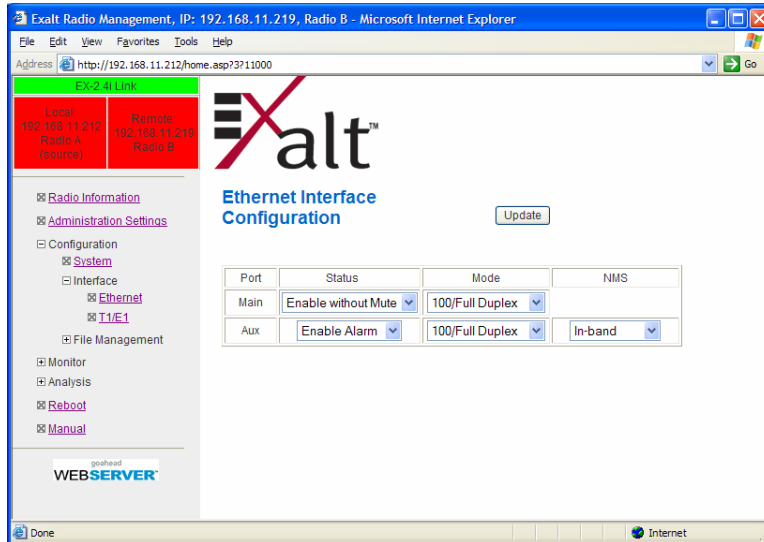

Figure 5-10: Ethernet Interface Configuration Page

## 5.9 T1/E1 Configuration Pages

This page allows the administrator to selectively enable or disable T1 or E1 circuits, one at a time. If T1 or E1 circuits are not going to be used, they should be disabled so that alarms are turned off and so that more throughput is allocated to the Ethernet interface. Every T1 or E1 input enabled, even if there is no T1 or E1 signal present, reduces the aggregate throughput of the Ethernet interface by roughly 3Mbps (for T1) or 4Mbps (for E1).

This page toggles between T1 or E1, as required, by pressing the ‘SET TO T1’ or ‘SET TO E1’ button. Pressing this button will warn the administrator that a reboot is necessary, and the radio will reboot if the administrator continues. **This will interrupt traffic**, and it may be necessary to re-login to the radio after the reboot is completed. Changing T1/E1 mode will self-coordinate across the link if the link is active. In other words, this change only needs to occur at one side of the link. In addition, enabling and disabling T1/E1 circuits also will self-coordinate across the link if the link is active.



Certain combinations of TDD Frame Size, Link Distance and Bandwidth will limit the number of T1/E1 circuits that can be carried by the radio. In these cases, the selections on the T1/E1 Interface Configuration pages will not be available, starting with Port 4. For example, if only three (3) circuits can be carried, Port 4 will not be available for configuration and will be disabled. If only two (2) circuits can be carried, Port 3 and Port 4 will not be available.

### 5.9.1 T1 Configuration Page

The T1 Configuration Page allows the administrator to enable/disable each individual T1, set the Line Build Out (LBO) and Line Code (either AMI or B8ZS). Also, AIS (alarm indication signal)

may be enabled/disabled for each input. If enabled, the radio will place an AIS code on the output of the associated interface if/when the link fails or there is no T1 signal available from the far end to provide the user at the local end.

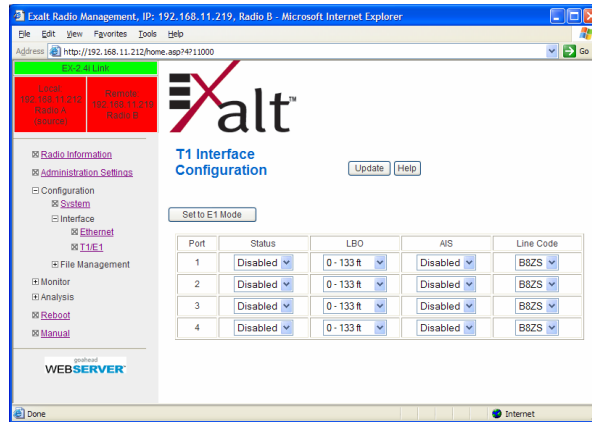

Figure 5-11: T1 Configuration Page

### 5.9.2 E1 Configuration Page

The E1 Configuration Page allows the administrator to enable/disable each individual E1. Also, AIS (alarm indication signal) may be enabled/disabled for each input. If enabled, the radio will place an AIS code on the output of the associated interface if/when the link fails or there is no E1 signal available from the far end to provide the user at the local end.

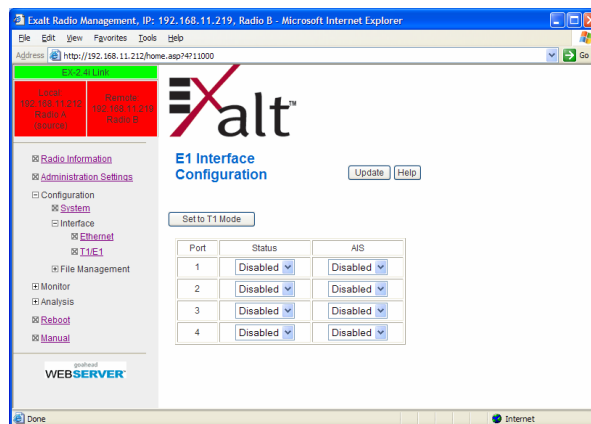

Figure 5-12: E1 Configuration Page

### 5.10 File Transfer Page

The File Transfer Page allows the administrator to upload and download files to and from the radio. Uploading files will place these new files in a reserve memory space. After files are uploaded the File Activation Page is used to enable these files. Uploading files does not automatically enable them.



It is advisable to check the File Activation Page before uploading new files. New file uploads will over-write the secondary file location. If important files reside in

the secondary file location, you may wish to download these files first before uploading new files.

Downloading files is a two-step process. You must first select the type of file to download, select the DOWNLOAD button and wait for the radio to prepare the file for download. A second page/link will appear as shown below. Follow the instructions on the page to download the file.

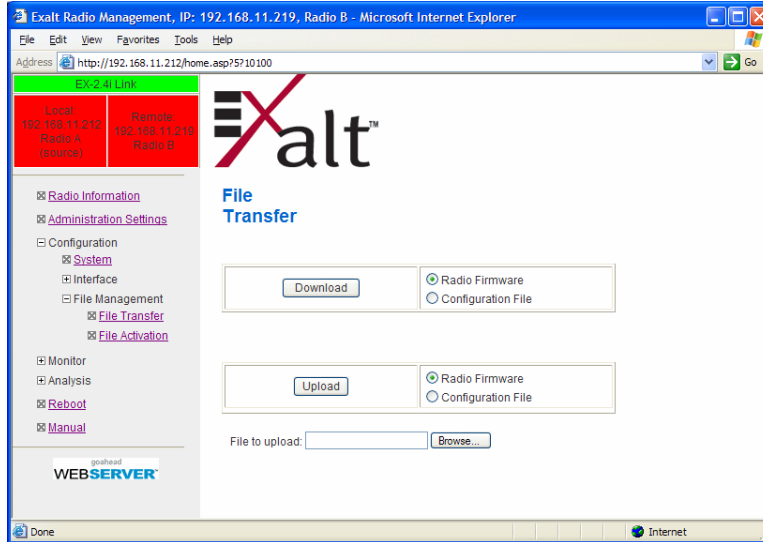

Figure 5-13: File Transfer Page

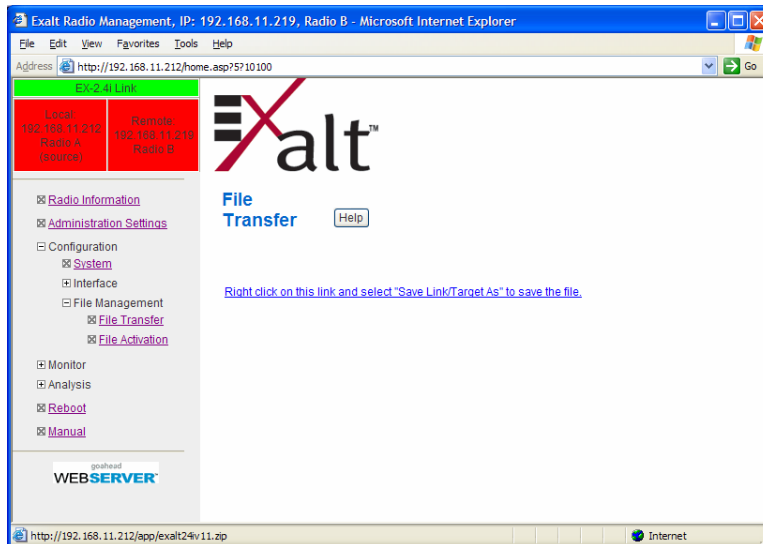

Figure 5-14: Download File Link

File download and upload can be useful if you are configuring several radios to very similar settings. Also, for record-keeping, a copy of the configuration file can help restore the radio to the original installed settings. In addition, a copy of the Exalt default configuration file can be helpful to re-configure the radio to factory settings.

If copying the same configuration file into multiple radios, some care needs to be taken, because some parameters will match that may be undesirable. However, it can be easier to change just a

subset of parameters rather than every parameter, therefore copying configuration still serves a very useful purpose. The following list of parameters may cause problems or confusion if they match at each of a link.

- Radio Name
- Endpoint Identifier
- IP address

However, it is helpful to have the following parameters match:

- Link Name
- Link Security Key (although each link should be different)
- Admin and User passwords
- Bandwidth
- RF Frequency
- Link Distance
- TDD Frame Size
- T1/E1 configurations
- Ethernet configurations

## 5.11 File Activation Page

The File Activation Page is used to move stored files or uploaded files into use on the radio. The page indicates which file is currently in use, and which file is available for use. Pressing the SWAP button places the file shown in the Alternative File column into active state and moves the Current File into the alternative file location.



**In all cases, the radio will require a reboot after a new file is selected using the SWAP function. This will place the radio out of service for a short period.**

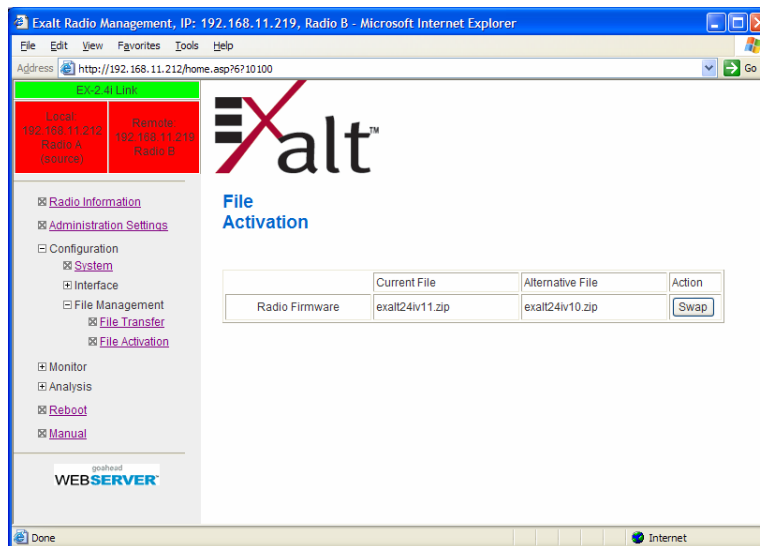

Figure 5-15: File Activation Page

## 5.12 Alarms Page

The Alarms Page provides an easy-to-read summary of the alarm status of both the local and remote radio. Generally, the colors shown on this page will reflect the color of alarms that are shown on the radio front panel. However, additional detail is illustrated on this page to aid in quick assessment of issues and status.

Refer to section 4.1.2 for more information about the front panel LEDs. Additional information about the Alarm status is provided here.

- The Internal Fan alarm monitors all three internal fans. The radio only requires one fan to be operational for full specification performance. The additional fans are provided for redundancy and to increase overall reliability. If one or two fan alarms are yellow or red, it is prudent to plan to install a spare radio at the earliest opportunity and return the radio for repair (RMA authorization required). If all three fans are in alarm, the radio should be taken out of service more immediately, as damage may occur to the internal electronics, especially in hotter ambient environments or thermal exchange from neighboring equipment.
- The Temperature alarm monitors the internal temperature of the unit, based on specific points inside the radio chassis. It is normal for the internal temperature to be above the ambient temperature, and thus the temperature may be higher than the highest specified ambient temperature. When the internal electronics reach a point that is higher than the normal temperature rise at the highest ambient temperature, the temperature alarm will turn to yellow. In this case, the radio should be powered down as soon as possible, and an investigation as to the cause of the temperature rise should commence and be resolved before the radio is put back into service. In almost all cases, a temperature alarm will be due to an external cause, unless the fans in the unit are also in alarm, in which case, the alarmed fans are likely the cause.

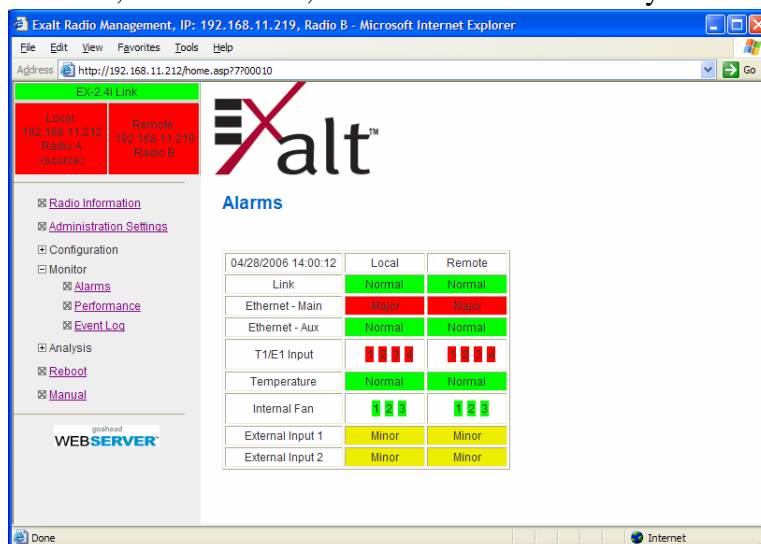

Figure 5-16: Alarms Page

### 5.13 Performance Page

The Performance Page provides statistical information about the performance of the system in relation to the integrity of the user data and the RF link. The list below provides a brief summary of this information.

- Current BER indicates the current Bit Error Rate of the link. If the link is operating perfectly, this should indicate zero. Generally, the link should remain at a BER less than  $1 \times 10^{-6}$  (1 bit out of every million bits errored). This is the threshold performance specification and the standard to which the link was engineered. However, radio links can and will be affected by weather, interference and other external sources and will occasionally have a higher error rate. A link will remain operational unless the BER exceeds  $1 \times 10^{-3}$  (1 bit out of every hundred bits errored). Consult the link design engineer for an understanding of the predicted error rate of the radio link as it has been designed. Many applications will be largely unaffected by bit errors, but TDM circuits (e.g. T1 or E1) are more sensitive. Also, if the link operator is providing a service guarantee, this value may need to be monitored or examined in cases of service issues. The behavior of BER in relation to other alarms or measurements and external events can be very helpful in troubleshooting activities.
- Current RSL is the measurement of the received signal level at the radio antenna port. This is the measured level of the RF signal coming from the opposite end of the radio link. The link was engineered to a specific RSL by the link design engineer, and this RSL should be obtained during installation and stay relatively stable during the operation of the link. RSL can and will vary as a result of weather changes and other external sources, such as path obstructions. Once again, this variation was part of the original design to achieve a certain level of performance over time. When the RSL falls to a level within roughly 3dB of the threshold specification, bit errors will occur. When the RSL falls below the threshold specification, the link will disconnect and will not reconnect until the RSL is above the threshold specification. The behavior of RSL in relation to other alarms or measurements and external events can be very helpful in troubleshooting activities.
- Errored Seconds (ES) indicates the total number of seconds that have occurred where there has been at least one bit error, since the last time that the radio statistics counter has been reset. Generally, ES are not a significant concern, so long as they are not continuous or above the anticipated performance based on the original link engineering goals. If ES are continuous or at a high rate, this is normally an indication of poor link performance due to poor RSL or interference, or severe impact by weather or other environmental factors. However, similar to the performance factors listed above, ES can and will occur in any radio link. Once again, the link engineer should be consulted to determine the original design goals, and compare actual performance to these expectations to determine if any improvements are necessary or if other problems may be causing excessive ES.



SES (as described below) do not register as ES. In other words, the ES counter will count ONLY seconds that are errored and are not SES.



- Severely Errored Seconds (SES) are similar to ES, but this counter keeps track of every second where the bit error rate exceeds  $1 \times 10^{-3}$ , over the period since the last counter reset. If SES are continuous or at a high rate, this is normally an indication of poor link performance due to poor RSL or interference, or severe impact by weather or other environmental factors. However, similar to the performance factors listed above, SES can and will occur in any radio link. Once again, the link engineer should be consulted to determine the original design goals, and compare actual performance to these expectations to determine if any improvements are necessary or if other problems may be causing excessive SES.
- Minimum RSL indicates the worst-case Received Signal Level that has occurred since the last counter reset. It can be helpful to know if the RSL has dropped significantly from normal level, or has reached a level near or below threshold.
- Maximum RSL indicates the best-case RSL that has occurred since the last counter reset. This indicates the best performance that the radio link has seen, which is normally equal to the installed value, which is usually the designed value.
- Time Since Reset indicates the amount of time that has passed since the last counter reset. This can help quantify the seriousness of other statistics, such as ES and SES, such as if there have been high numbers of ES and/or SES over a relatively short period of time.

Each end of the link statistics on this page can independently be reset using the Reset Statistics button for the Local or Remote radio. It is good practice to reset the statistics at the time that the link is commissioned (after all antenna alignment is complete and stable RSL at designed levels is achieved, and no more system reboots are anticipated). It is also a good practice to re-visit this statistics page on a regular basis, make records of the performance and reset the statistics so that counters can more precisely pinpoint issues.



Resetting statistics from one end will also reset the statistics for the same radio at the opposite end. That is, if the Local statistics are reset, logging into the remote end will show the Remote statistics on that end (which is the local radio in the first condition) as having been reset at the same time.

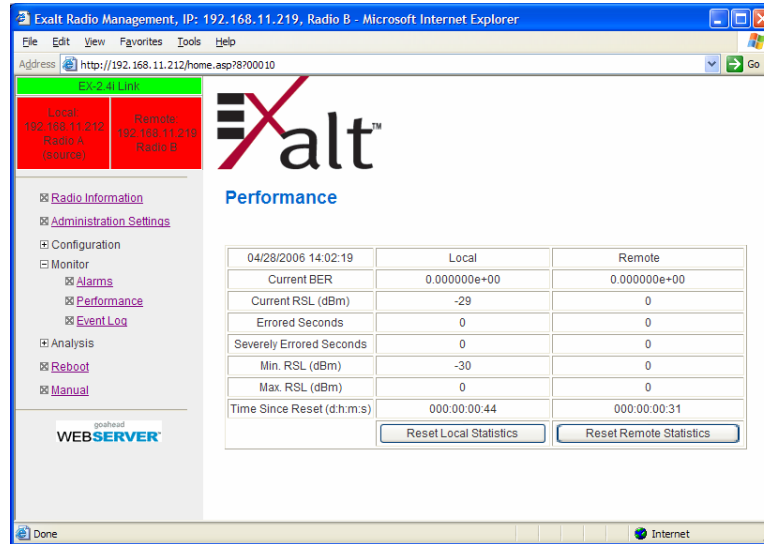

Figure 5-17: Performance Page

## 5.14 Event Log Page

The Event Log Page is used to review a list of the events that have been logged by the radio. At the present radio firmware release, the following items are listed in the event log.

- Alarms
- Alarms clearing (Normal)
- Radio Reboots

Every event is tagged with the time that the event took place and a severity/type for further categorization. The event log also allows filtering to limit the view of the log to the lowest level of information that is desired. For example, a filter level of Minor will show Minor, Major and Critical.

The log contains the last 200 events and will purge in a FIFO basis, erasing the oldest entries to make room for the newest entries.

The event log may be cleared, if desired. The event log may be downloaded from the radio (this feature may require a future software upgrade), or a screen capture of your browser window can serve as a useful record for troubleshooting.

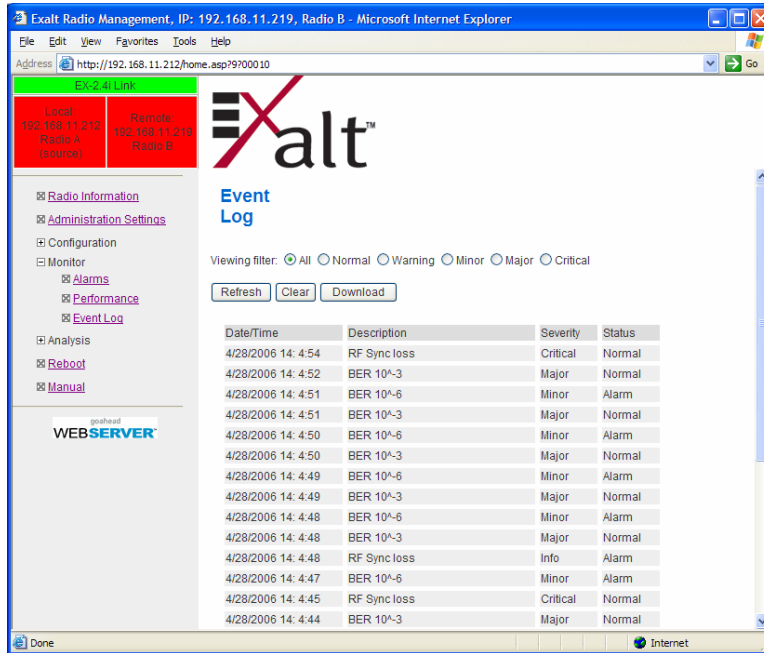

Figure 5-18: Event Log Page

## 5.15 Diagnostic Charts Page

The Diagnostics Charts Page is used to aid in troubleshooting. This page illustrates the historical (and current) performance for three parameters, RSL, BER and Radio Temperature.

The horizontal scale illustrates 120 points of time measurement and is synchronized for all three graphs. The scale may be changed from seconds, to minutes, to hours, to days. Therefore, you may display the last two minutes (120 seconds), last two hours (120 minutes), last 5 days (120 hours) or last 4 months (120 days) of information. All of this information is stored, so it is possible to review all of these periods for short and long-term performance analysis. The right hand side of the graph represents the most recent measurement and data ‘marches’ from the right towards the left at every interval.

The vertical scale of each chart independently scales to show the maximum resolution based on the maximum variation of the data over the selected measurement period.

Using your cursor, you may point to any spot on any of the three charts and all three charts will illustrate the measurements taken for that time interval in the upper left corner of each chart. The time interval is indicated by T=(value). This is followed by the value of the measurement, listing the highest value, lowest value and average value measured over that interval of time.

For example if the time interval displayed is seconds, and you hold your cursor over the graph at the T=50 mark on the horizontal axis, the measurements shown indicate performance from 50 seconds ago. The high/low/average values shown will be measurements that were made across the 1 second interval that data was measured.

Changes in RSL often have an impact to BER, and this can be confirmed by looking for synchronized events. When BER events occur without corresponding changes in RSL, this is normally an indication of interference, atmospheric changes, transmission system issues (such as problems with cables, connectors or antennas) or possibly radio hardware problems.

It also can be useful to determine if changes in radio temperature are occurring, and also if they are having any impact on RSL or BER. If the radio is mounted in an environmentally controlled location, this has less relevance. However, temperature monitoring can be helpful to assure that the radio is being operated within specifications.

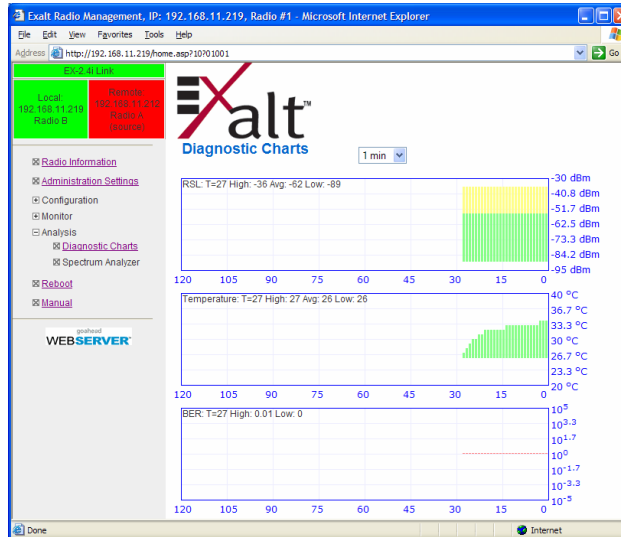

Figure 5-19: Diagnostic Charts Page

## 5.16 Spectrum Analyzer Page

This page is currently not available. In a future software release, a built-in spectrum analyzer will be provided and documentation on this feature provided.

## 5.17 Reboot Page

This page is used to enact a reboot of the radio. The function should never be required, but can be used in cases of emergency. All configurations that require reboot will automatically reboot when the administrator confirms.

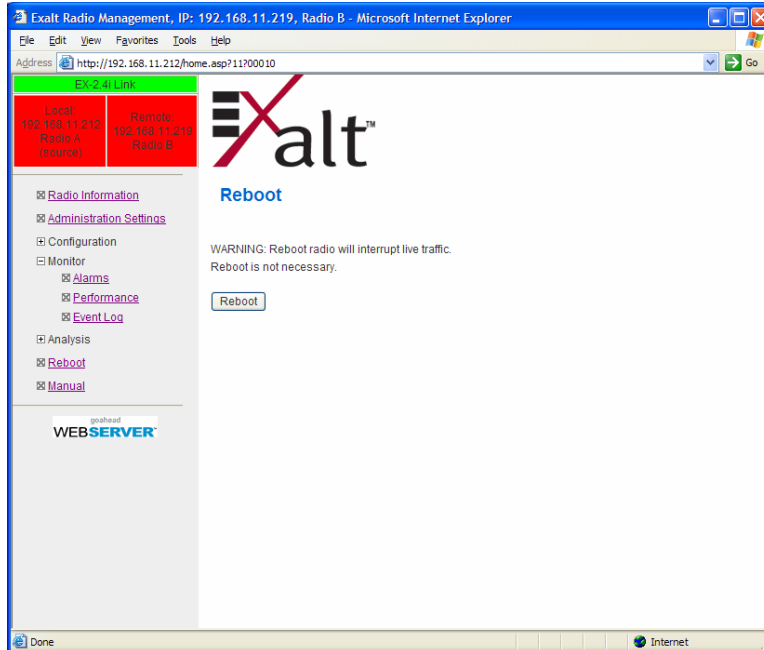

Figure 5-20: Reboot Page

### 5.18 Manual Page

The Installation & Management manual (this document, or the version that matches the installed firmware) is available within the GUI. Click on Manual and the manual will be displayed within the browser window. Your browser must support viewing Adobe pdf files for this function to operate. Once the manual is displayed, you may select the SAVE function within the pdf window (typically the upper left button, with a floppy disk icon) to download the manual to your computer.

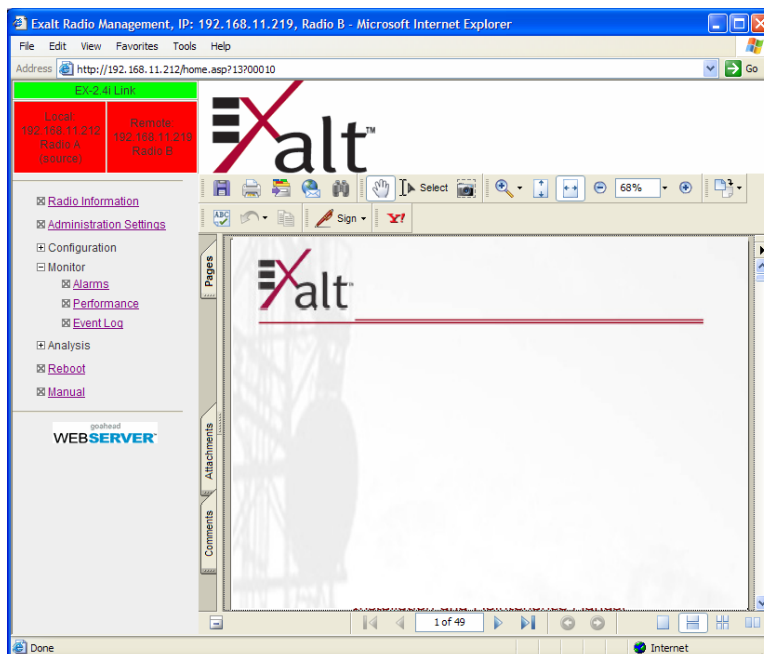

Figure 5-21: Manual Page

## **Section 6 – Troubleshooting**

This section provides information regarding troubleshooting of common issues and alarms on the EX-5r.

Exalt radio systems have been designed by Exalt's expert engineers with extensive experience through multiple generations of microwave radio design. As such, these new generation systems contain extensive diagnostic tools, alarm indications and troubleshooting aids. And, as compared to other systems in their class, they should be much easier to install, maintain and troubleshoot. The GUI of the radio system provides information that will substantially aid in troubleshooting. Refer to section 5 for details.

Please feel free to contact Exalt Customer Care if you need further assistance with issues you may have with your Exalt radio, or for suggestions on how the radio and/or documentation may be improved.

### **6.1 General Troubleshooting Practices**

Troubleshooting a microwave radio link can be a complex task. In many cases, troubleshooting should be approached as a process of elimination by proving which portions of the system are operating properly.

In a vast majority of cases, failures or poor performance of microwave links is attributed to something other than the microwave radio hardware. In this respect, the back-to-back bench test (as described in Appendix B) is a very important means to determine if the radio hardware is operating properly and to eliminate many variables in the troubleshooting process.

If a back-to-back bench test fails, then the radio hardware is either broken or the radios are configured improperly. Upgrading the radio to the most current release of firmware, and/or resetting the radio to critical factory settings and following the original Quick Start instructions, and the instructions in this manual, will often help confirm if configuration issues are the cause of failure.

The most common issues with microwave radio links are:

- An improperly terminated RF cable
- Multipath propagation
- RF interference
- Path obstruction
- Misaligned antenna
- Faulty antenna
- Improper grounding
- Insufficient link margin in the design/implementation
- Moisture in the transmission system (antenna feed and/or RF cable)

If the radio link has been operating without issues, and has exhibited new behavior of poor performance or has become completely inoperative, the troubleshooting process should pay close attention to any conditions that may have changed between the time when the system was working without issue and the time when issues started. Also, it can be helpful to compare some performance parameters of the system before and after the presence of issues. Often the source of the issues can be determined by thoughtful consideration of changes, such as:

- Changes in weather, including high winds
- Changes made to the radio equipment, transmission system or connected equipment
- New radio systems or electronic equipment nearby radio or transmission system
- New construction nearby either end of the link, or along the path
- Growth of trees, flooded fields, changes in rivers/lakes along the path

Verify that configurations are set as follows:

- RF Frequency matches at each end
- Bandwidth matches at each end
- Link distance matches at each end
- TDD Frame Length matches at each end
- Endpoint Identifier is different at each end (one end Radio A, one end Radio B)
- Ethernet interfaces are enabled, as desired
- AUX Ethernet is set for in-band, or out-of-band NMS, as desired
- T1/E1 enabling matches at each end
- Link security key matches at each end

Also, the **ExaltCalc** should have been used in the design phase to determine optimum setting of Bandwidth and TDD Frame Length for the given link distance, and provides guidance to the expected RF link performance as well as the throughput, latency and number of T1/E1 circuits supported.

## **6.2 Typical Indications of Issues**

In many cases, microwave radio users will not notice changes or degradation to the radio system until the radio system fails completely or becomes highly errored or significantly intermittent. However, regular management of the radio system can help indicate changes in performance that have not yet impacted user performance, but may impact performance at a later date if left unchecked or unaddressed. In this manner, the administrator has the opportunity to be very proactive, by monitoring the radio link performance regularly, and watching for unexplained or unexpected changes in performance and trends in performance changes.

Most importantly, monitoring radio system received signal level (RSL) over time will indicate that the performance of the radio system is relatively steady. If there is a long-term drop in RSL, this should be addressed. If there is erratic or unsteady RSL, this should be addressed. Some level of RSL changes are to be expected, and weather patterns and related multipath will cause dramatic RSL changes that may result in system outage. However, that outage should not occur

at a significantly greater rate than the designed long-term performance. Consult the path design engineer for more information about link reliability expectation and anticipated RSL deviation.

In addition, regular inspection of the transmission system (RF cables and antennas), and paying close attention to changes along the path, such as construction or tree height, or new microwave radio installations nearby, can be extremely helpful and proactive.

When link performance is very poor, alarms on the radio front panel and within the radio's management system will indicate particular failures. Consult this manual for more information on the specific alarms and diagnostics, or contact Exalt Customer Care for assistance.

Exalt Customer Care is primarily motivated to determine if the radio hardware is faulty and needs to be returned for repair, and to help execute an effective and efficient repair and return process for radio terminals believed to be faulty. However, Exalt Customer Care will provide advice regarding the rest of the radio system and RF path engineering and environment, and advise steps that may be taken to troubleshoot the system.

End-users should get first-line support from the installer and/or designer of the system. In many cases, an in-depth understanding of RF design is required, and on-site analysis, and special test equipment, may be necessary. Troubleshooting will be much more expeditious if the professional installer and/or link designer is able to review the system in-person and review the management information from the radio's GUI. In turn, if the professional installer and/or link designer contacts Exalt Customer Care, the process to rectify the system will normally be much more expedient.

### **6.3 Improper RF Cable Termination**

Improper RF cable termination is a very common problem. In many cases, this will be a problem that occurs during installation, and not a problem that will suddenly appear. However, if cables are moved or flexed, especially near the termination points, and radio errors, changes in RSL or other performance issues occur, this is a certain sign of this issue.

Another relatively easy method to test for this condition is to decrease the output power of the radio system (at each end, one end at a time). A poor RF cable termination may be reflecting too much RF energy back into the radio system, and reducing output power will reduce the reflected energy at a faster rate than the transmitted energy towards the far-end. Be careful not to reduce the output power to the point where the radio's threshold is reached. Typically, a reduction of just 3 to 6dB will be enough to see if this is the issue. If reduction of output power clears the error condition, this is the likely cause.

A reflectometer, or meter that can read voltage standing wave ratio (VSWR) at the operating frequency (5250-5850 MHz) can be used to identify poor terminations as well as poor antenna feeds.

- The Praxsym VSWR meter is an excellent tool for this purpose



## **6.4 Multipath Propagation**

Multipath propagation is a term that encompasses changes to the RF path, such as reflections and/or refraction, that can cause partial or complete destruction of the radio signal, and thus excessive bit errors and/or system outages.

Rapid changes in temperature, inversion layers, humidity, air pressure, water evaporation, as well as standing water or moisture on objects along the path, are all examples of changes that can cause multipath propagation. New building construction near either end of the path, or along the path, may cause new reflection characteristics.

If your system has been operating without issue and is suddenly experiencing issues that are symptomatic of a certain time of day, or related to change in climatic events or some of the external factors listed above, this is likely the cause.

A professional RF path engineer should be consulted in these cases. Often, minor repositioning of the antennas at either or both ends may reduce or eliminate these problems.

## **6.5 RF Interference**

RF interference is usually indicative of another radio system nearby either end of your radio system, or aimed towards one or both ends of your radio system – usually at or near the same frequency, and usually a signal level similar to the level of the signal of your own radio system.

Other forms of RF interference also exist, such as electronic equipment that may be placed close to the radio chassis, or transmitters that may couple onto the cabling or grounding system of the radio. Microwave ovens and wireless communication devices used nearby the equipment or cabling are examples of electronic equipment interference.



The EX-5r operates in the 5250 to 5850 MHz band. Wireless Internet devices and cordless phone technology may also use this frequency band. It may be necessary to separate the EX-5r chassis, cabling system and antenna from these types of devices.

RF interference, like most other causes of problems, will be indicated by significant bit errors and/or system outages.

One means to determine presence of interference is the use of a spectrum analyzer that covers the same range as the radio system. A professional RF engineer can use a spectrum analyzer to locate sources of interference, measure these sources, and determine potential remedies that may be taken to operate in the presence of interference.

If a spectrum analyzer is not available, the radio's RSL port may be used to determine RSL levels of interfering signals. By turning the far-end radio off, the residual RSL measured by the radio indicates the level of interference seen by the radio. It is possible that interference levels below that which can be measured will still have impact on the radio system – especially if the radio system has low fade margin or is using a high order modulation.

The EX-5r provides considerable flexibility to tune to different frequencies across the band. This is the easiest method to use to try to avoid existing interference. In addition, the occupied bandwidth of the radio may be reduced, and along with re-tuning, this can be very effective, however throughput will be reduced.

Repositioning the antenna and/or changing polarization, or upgrading the antenna to a higher gain and/or using a high-performance antenna, are all secondary means that can be used. It may be necessary to perform combinations of both radio changes (retuning, occupied bandwidth reduction) and antenna system changes (position, polarization, upgrade).

## **6.6 Path Obstruction**

A path obstruction is defined as an object, such as a building or tree, that is impeding the proper path clearance of the radio system. If the system design was proper at the time of installation, and issues have arisen at a later date, an updated path profile and survey may be necessary to identify changes in the path clearance.

## **6.7 Misaligned Antenna**

At the time of initial installation, it is critical that the antennas at each end are properly aligned and that the designed RSL is achieved. However, antennas may become misaligned due to high winds, changes in the guy-wiring systems keeping the antenna mast stable, or loosening of the antenna mounting hardware. A reduction in the RSL of the link will be symptomatic of this condition, but this condition is not the only condition that results in a reduction of RSL. However, if conditions have occurred where the antenna alignment may be suspected, the mechanics may need to be inspected, and the antennas may need to be realigned.

## **6.8 Faulty Antenna**

A faulty antenna is rare, but still a possibility. In some cases, the mechanics of the antenna feed can get moisture inside, or a bad or weak connection in the pin and connector structure of the antenna may occur. A VSWR measurement of the antenna connection can be made to verify this condition.

## **6.9 Improper Grounding**

In addition to being a potential human safety issue, improper system grounding is a somewhat common condition that can cause continuous bit errors, or bit errors when metal objects come in contact with the radio, transmission system or racking system. If touching the radio causes errors, grounding is the cause. It can be difficult to identify grounding problems, but a professional electrician can normally inspect a system and identify if there are deficiencies in the grounding system.

## **6.10 Insufficient Link Margin**

Ideally, your link was designed with enough link margin (fade margin) to allow for multipath propagation and atmospheric fading and remain reliable. In some cases, link margin is compromised by economic factors, such as using low-cost RF cabling or lower-cost antennas that have less gain or deficient performance compared to higher cost transmission system

components. In some cases, there may be antenna size restrictions that forced the design to not have the desired amount of link margin.

If the link was designed with poor link margin, there will likely be many cases of bit errors and outages. The antenna system and transmission line system, can be upgraded to help reduce this opportunity.

If the link design was installed with sufficient margin, but RSL has reduced, the remaining link margin may no longer be enough to maintain a reliable link. Causes of RSL reduction have been described above, but are usually due to new path obstruction(s) or antenna misalignment due to wind or mechanical factors. The antenna height or location can be changed to overcome new obstructions. Realignment of the antenna, and/or improvement to mechanical structures can help overcome antenna misalignment.

### **6.11 Moisture in the Transmission System**

If the connectors on cables and antennas and egress junctions are not properly weatherproofed, moisture can get into the transmission system and cause significant error conditions and erratic performance. In many cases, the transmission system will need to be replaced if this occurs. A VSWR meter is one means to identify such issues. Physical inspection can be helpful, and if changes to the weatherproofing occur (such as cracks), the weatherproofing should be replaced before it leaks.

## Appendix A – Specifications

### A-1 Physical Specifications

Physical Configuration	Single-piece Outdoor Unit (ODU)
Dimensions (H x W x D)	12 x 12 x 5 inches; 30.5 x 30.5 x 12.7 cm
Weight	11.3 pounds; 5.1 kg
Operating Temperature	-40 to +65 degrees C; -40 to +149 degrees F
Altitude	15,000 feet; 4.6 km
Humidity	95% non-condensing

### A-2 System Specifications

Frequency Bands	5250 to 5350 MHz 5725 to 5850 MHz
Tuning Resolution	1MHz
Output Power (at full power)	+24dBm (0.25W), Mode 1, 5725-5850 MHz +21dBm (0.125W), Mode 2, 5725-5850 MHz +18dBm (0.063W), Mode 3, 5725-5850 MHz +13dBm (0.02W), all Modes, 5250-5350 MHz
Output Power attenuation range	20dB
Power Control Step Size	0.5dB
Selectable Modulation Modes	Mode 1 (QPSK), Mode 2 (16QAM), Mode 3 (64QAM)
Selectable Channel Bandwidths	8MHz, 16MHz, 32MHz, 64MHz
Receiver Threshold (BER=10e-6)	

(dBm)	Mode 1	Mode 2	Mode 3
<b>8MHz</b>	-88	-80	-74
<b>16MHz</b>	-85	-77	-71
<b>32MHz</b>	-82	-74	-68
<b>64MHz</b>	-79	-71	-65

Maximum RSL	Mode 1: -25dBm error-free; +3dBm no damage
Selectable Frame Lengths	0.5ms, 1ms, 2ms, 2.5ms, 4ms, 5ms
Maximum Aggregate User Capacity	

(Mbps)	Mode 1	Mode 2	Mode 3
<b>8MHz</b>	13	27	40
<b>16MHz</b>	27	55	82
<b>32MHz</b>	55	110	165
<b>64MHz</b>	110	216	216

Error Floor	10 <sup>-12</sup>
Frequency Stability	±7ppm
Link Security	96-bit Security Code
Regulatory Compliance	FCC 15.247; FCC 15.407; IC RSS-210
FCC ID	TTM-105P25R
IC ID	6254A-105P25R

Emission Designator(s)

	<b>5250-5350MHz</b>	<b>5725-5850MHz</b>
<b>8MHz</b>	9M1W7D	9M5W7D
<b>16MHz</b>	18M2W7D	17M4W7D
<b>32MHz</b>	36M1W7D	33M7W7D
<b>64MHz</b>	71M0W7D	65M1W7D

### **A-3 Interfaces**

RF

Connector N-type Female  
Impedance 50 ohms

T1/E1 (x4)

Connector RJ-45 (RJ48C), Female  
T1 Impedance 100 Ohms, balanced  
T1 Line Codes AMI, B8ZS, selectable  
T1 LBO Settings (in ft.) 0-133, 133-266, 266-399, 399-533, 533-655  
T1 Clocking Speed 1.544Mbps  
T1 Compliance ANSI T1.102-1987; ITU-T; G.823; GR-49T-CORE  
E1 Impedance 120 Ohms, balanced  
E1 Line Codes HDB3  
E1 Clocking Speed 2.048Mbps  
E1 Compliance CEPT-1; G.703; ITU-T-G703  
Loopback Modes Remote Internal, Remote External, Local Line

Ethernet/Power

Connector RJ-45, Female, auto-MDIX  
Interface Speed 10 or 100Mbps  
Duplex Half, Full, Auto, selectable  
Compliance 802.3  
Input Voltage 48VDC nominal  
Consumption <1.2A @ 48V (<58 Watts)

Sync

Connector RJ45, Female  
Signal 1pps (GPS)

Injector Power

Connector 6-pin barrier strip  
Input Voltage 40-60Vdc  
Consumption <1.2A @ 48V (<58 Watts)

## Appendix B – Back-to-back Bench Testing

### **B-1 Introduction**

Back-to-back bench testing is used to test the radio before installation, pre-configure the radio and connected equipment before installation, or in the troubleshooting process to identify if the radio hardware is the source of a system issue. It is a critical process, and often required or highly desirable for any installation or troubleshooting exercise. This section describes how to properly configure the radio hardware and accessories for a proper back-to-back bench test.

For radio testing, there are two types of back-to-back configurations:

- Basic test (test general operation)
- Specification performance verification

### **B-2 Basic Test**

The basic test is a simple test of radio functionality. It verifies that the radios are configured properly to communicate to one another, and verifies general radio performance to be operational.

For the basic test on the external antenna version, the following items are needed:

- Radio pair
- Powering source
- RF interconnect cable(s) (any length – short is best)
- Fixed or variable attenuation, between 60 and 90dB at 5800 MHz (note: attenuation for basic test does not to be calibrated or precise)
- Computer/Terminal with either Serial or Ethernet port (helpful, but not necessary)
  - If no computer is available, you will need the temporary hardware configuration key

Connect the items as follows:

- Connect attenuation and (known-good) RF cable(s) between radio pair, as shown in Figure B-1.
- Configure one radio to be Radio A, the other to be Radio B
- Power on radio pair

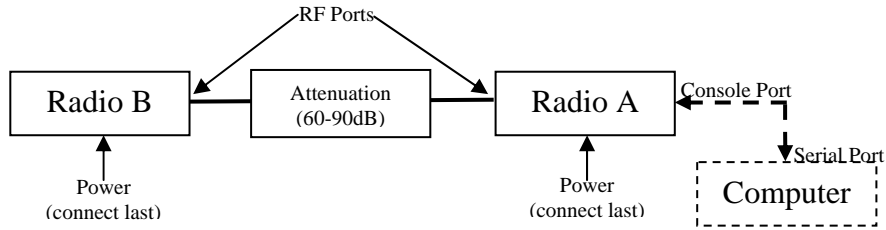

Figure B-1: Basic Back-to-Back Bench Test Configuration

Connect the items as follows:

- Connect attenuation and (known-good) RF cable(s) between radio pair, as shown in Figure B-1.
- Configure one radio to be Radio A, the other to be Radio B
- Power on radio pair

For the basic test on the integral antenna version, the following items are needed:

- Radio pair
- Powering source
- RF absorbing material (e.g. Emerson Cummings Echosorb, minimum 60dB at 5GHz)
  - Computer/Terminal with Ethernet port

The RF absorbing material is used in place of fixed cables and attenuators.

After connecting and powering on, the GUI may be observed to verify that the Link and Status alarms both green. If they are green, the radios are communicating and all radio-related alarm conditions are normal.

### **B-3 Specification Performance Verification**

The specification performance verification is a more detailed test that allows you to verify that the radio's output power and threshold specifications are being met. This test can be challenging, and potentially impossible, to do with the integrated antenna versions. This is typically a test that would only be performed in a troubleshooting scenario, but can be performed before installation if you wish to have a detailed record or be extremely certain of the radio performance before installation.

This test is identical to the basic test, but in place of the fixed attenuation, it requires the use of calibrated variable attenuation, or a set of calibrated fixed attenuators, or a combination of both, adding to a total attenuation value of 120dB, as measured at the operating frequency of the radio (roughly 5.8 GHz, in this case). In addition, a voltmeter or computer is also required.

Connect the system as in figure B-1, using the combination of fixed and variable attenuation in between the radio's RF ports. Connect the voltmeter to either radio's RSL test point and the associated reference ground connection.

In this test, it is highly desirable to utilize RF cables that are pre-tested, known good and the insertion loss is known at the operating frequency. If the cables are short (in the range of 6 feet or less), you can estimate the loss, including connectors, to be less than 1dB each. The estimate of cable loss is critical to the overall confidence of the measurements made in this test.

There are two critical specifications that can be tested in this configuration:

- RF output power
- Radio receiver threshold

To measure transmitter output power, simply insert any value of attenuation between the radios between 60 and 90dB. Make sure that both of the radio's RF output power settings are at maximum. Using the voltmeter, measure RSL in both directions. The RSL measured value should match the appropriate value in accordance to the inserted attenuation. Such as:

$$RSL = RF \text{ Output Power} - \text{cabling losses} - \text{total attenuation}$$

You can further verify output power by adjusting output power using your computer (in administration mode) and evaluate the corresponding change to the RSL measurement.

For threshold testing, the key is to insert a measured amount of loss that is close to, but not exceeding the radio's specified system gain. System gain is the difference between RF output power and receiver threshold. At your selected modulation and bandwidth settings, determine the specified threshold performance, and choose a value of attenuation (including cable losses) that adds to roughly 5 to 15dB less than the system gain.

For example, if the threshold for your measurement is -88dBm and the output power is +24dBm, so the System Gain is 112dB. Choose a value of total attenuation in the range of roughly 100-105dB. Once this attenuation is inserted, verify RSL readings as in the first step, and then, using your computer, reduce radio output power in 1dB steps until the receiving radio (the one whose output power you are not adjusting) Link LED turns from green to yellow. This would indicate that threshold has been reached. At this point, verify the equation for system gain using the new output power level setting and verify that the threshold performance is meeting or exceeding the published specification.



Due to the variation of measurements and accuracies involved in this test, you may read a measurement that is 1 to as much as 2dB off of the expected value. It should be of no concern unless the value is more than 3dB worse than expected.

Once threshold is verified in this direction, you may repeat the process in the opposite direction by adjusting RF output power of the radio at the opposite end. You should return the first radio to its original power setting before adjusting the second radio.



You may wish to perform threshold measurement tests for all combinations of bandwidth and mode (modulation) that you are using – especially if testing for the purposes of troubleshooting. It should not be necessary to vary center frequency, as this does not have any appreciable impact on system gain performance – however, any combination of settings may be tried to gain confidence in the radio performance parameters.

## Appendix C – Interface Connections

### C-1 Introduction

This appendix provides the pin number assignment and wiring information for the connectors on the EX-5r. All connectors are shown as viewed from the radio front panel.

### C-2 T1/E1 Connections

There are two dual-T1/E1 connections. Channels 1 and 2 are on one connector, while channels 3 and 4 are on the other. Channel 1 and 2 are closest to the Power/Ethernet connector near the corner of the unit.

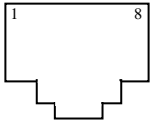

Pin	Function
1	#1 or #2 Tip Out (from radio)
2	#1 or #2 Ring Out (from radio)
3	#3 or #4 Tip Out (from radio)
4	#1 or #2 Tip In (to radio)
5	#1 or #2 Ring In (to radio)
6	#3 or #4 Ring Out (from radio)
7	#3 or #4 Tip In (to radio)
8	#3 or #4 Ring In (to radio)

Figure C-1: T1/E1 Connectors

### C-3 Ethernet/Power Connection

The Ethernet/Power connection of the EX-5r implements Auto-MDIX for the Ethernet function, and therefore either ‘straight’ or ‘crossover’ Ethernet cables may be used at the data end of the injector, independent of the wiring of the connected device. The connector on the radio unit carries DC power on the unused pins. The connector on the injector (the non-DC side of the injector) is wired as a standard Ethernet connection and implements the Auto-MDIX feature.

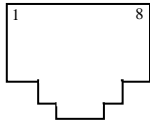

Pin	Function
1	Paired with Pin 2
2	Paired with Pin 1
3	Paired with Pin 6
4	DC+
5	DC+
6	Paired with Pin 3
7	DC-
8	DC-

Figure C-2: Ethernet/Power Connector

### C-4 Sync Connection

The Sync connector is normally connected to a (custom) GPS antenna system.

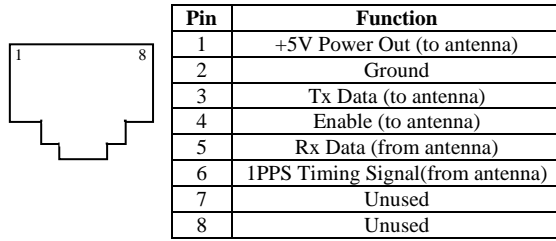

Figure C-3: Sync Connector



© May 2006  
Exalt Communications Inc.  
580 Division St. Campbell, CA 95008 USA