

Test of EX-4.9i Microwave Fixed Link

To: FCC Part 90 Subpart Y & IC RSS-111

Test Report Serial No.: EXLT13-A1 Rev A





Test of EX-4.9i Microwave Fixed Link

To FCC Part 90 Subpart Y & IC RSS-111

Test Report Serial No.: EXLT13-A1 Rev A

This report supersedes NONE

Manufacturer: Exalt Communications, Inc
580 Division Street
Campbell, California 95008
USA

Product Function: 4.9 GHz Microwave Fixed Link

Copy No: pdf **Issue Date:** 12th February 2007

This Test Report is Issued Under the Authority of:

MiCOM Labs, Inc.
440 Boulder Court, Suite 200
Pleasanton, CA 94566 USA
Phone: +1 (925) 462-0304
Fax: +1 (925) 462-0306
www.micomlabs.com



CERTIFICATE #2381.01

MiCOM Labs is an ISO 17025 Accredited Testing Laboratory



Title: EX-4.9i Microwave Fixed Link
To: FCC Part 90 Subpart Y & IC RSS-111
Serial #: EXLT13-A1 Rev A
Issue Date: 12th February 2007
Page: 3 of 102

This page has been left intentionally blank

This test report may be reproduced in full only. The document may only be updated by MiCOM Labs personnel. Any changes will be noted in the Document History section of the report.



Title: EX-4.9i Microwave Fixed Link
To: FCC Part 90 Subpart Y & IC RSS-111
Serial #: EXLT13-A1 Rev A
Issue Date: 12th February 2007
Page: 4 of 102

TABLE OF CONTENTS

COVER PAGE	1
ACCREDITATION & LISTINGS.....	5
1. TEST RESULT CERTIFICATE	8
2. REFERENCES AND MEASUREMENT UNCERTAINTY	9
2.1. Normative References	9
2.2. Test and Uncertainty Procedures	10
3. PRODUCT DETAILS AND TEST CONFIGURATIONS	11
3.1. Technical Details	11
3.2. Scope of Test Program	12
3.3. Equipment Model(s) and Serial Number(s)	13
3.4. Antenna Details	14
3.5. Cabling and I/O Ports	14
3.6. Test Configurations.....	15
3.7. Equipment Modifications.....	16
3.8. Deviations from the Test Standard	16
3.9. Subcontracted Testing or Third Party Data	16
4. TEST SUMMARY	17
5. TEST RESULTS	18
5.1. Device Characteristics	18
5.1.1. <i>Occupied Bandwidth and Emission Mask</i>	18
5.1.2. <i>Peak Output Power</i>	42
5.1.3. <i>Peak Power Spectral Density (PPSD)</i>	54
5.1.4. <i>Maximum Permissible Exposure</i>	65
5.1.5. <i>Frequency Stability; Temperature Variations, and Voltage Variations</i> ..	66
5.1.6. <i>Spurious Emissions at Antenna Terminals</i>	70
5.1.7. <i>Radiated Spurious Emissions</i>	86
5.1.8. <i>AC Wireline Conducted Emissions (150 kHz – 30 MHz)</i>	95
6. TEST SET-UP PHOTOGRAPHS.....	98
6.1. General Measurement Test Set-Up	98
6.2. Radiated Spurious Emissions	99
6.3. Conducted Emissions (150 kHz - 30 MHz).....	100
7. TEST EQUIPMENT DETAILS.....	101

This test report may be reproduced in full only. The document may only be updated by MiCOM Labs personnel. Any changes will be noted in the Document History section of the report.

ACCREDITATION & LISTINGS

MiCOM Labs, Inc. an accredited laboratory complies with the international standard BS EN ISO/IEC 17025. The company is accredited by the American Association for Laboratory Accreditation (A2LA) www.a2la.org test laboratory number 2381.01. MiCOM Labs test schedule is available at the following URL; <http://www.a2la.org/scopepdf/2381-01.pdf>



THE AMERICAN
ASSOCIATION
FOR LABORATORY
ACCREDITATION

ACCREDITED LABORATORY

A2LA has accredited

MICOM LABS
Pleasanton, CA

for technical competence in the field of

Electrical Testing

The accreditation covers the specific tests and types of tests listed on the agreed scope of accreditation. This laboratory meets the requirements of ISO/IEC 17025 - 1999 "General Requirements for the Competence of Testing and Calibration Laboratories" and any additional program requirements in the identified field of testing.

Presented this 14th day of September 2005.





President
For the Accreditation Council
Certificate Number 2381.01
Valid to: November 30, 2007

For tests or types of tests to which this accreditation applies,
please refer to the laboratory's Electrical Scope of Accreditation.

This test report may be reproduced in full only. The document may only be updated by MiCOM Labs personnel. Any changes will be noted in the Document History section of the report.



Title: EX-4.9i Microwave Fixed Link
To: FCC Part 90 Subpart Y & IC RSS-111
Serial #: EXLT13-A1 Rev A
Issue Date: 12th February 2007
Page: 6 of 102

LISTINGS

MiCOM Labs test facilities are listed by the following organizations;

North America

United States of America

Federal Communications Commission (FCC) Listing #: 102167

This test report may be reproduced in full only. The document may only be updated by MiCOM Labs personnel. Any changes will be noted in the Document History section of the report.



Title: EX-4.9i Microwave Fixed Link
To: FCC Part 90 Subpart Y & IC RSS-111
Serial #: EXLT13-A1 Rev A
Issue Date: 12th February 2007
Page: 7 of 102

DOCUMENT HISTORY

Document History		
Revision	Date	Comments
Draft		
Rev A	12th February 2007	First issue.

This test report may be reproduced in full only. The document may only be updated by MiCOM Labs personnel. Any changes will be noted in the Document History section of the report.



Title: EX-4.9i Microwave Fixed Link
To: FCC Part 90 Subpart Y & IC RSS-111
Serial #: EXLT13-A1 Rev A
Issue Date: 12th February 2007
Page: 8 of 102

1. TEST RESULT CERTIFICATE

Manufacturer:	Exalt Communications, Inc 580 Division Street, Campbell, California 95008 USA	Tested By:	MiCOM Labs, Inc. 440 Boulder Court Suite 200 Pleasanton California, 94566, USA
EUT:	4.9 GHz Point to Point Fixed Link Radio	Telephone:	+1 925 462 0304
Model:	EX-4.9i	Fax:	+1 925 462 0306
S/N:	N/A		
Test Date(s):	30th Dec '06 - 6th Jan '07	Website:	www.micomlabs.com

STANDARD(S)	TEST RESULTS
FCC Part 90 Subpart Y & IC RSS-111	EQUIPMENT COMPLIES

MiCOM Labs, Inc. tested the equipment mentioned in accordance with the requirements set forth in the above standards. Test results indicate that the equipment tested is capable of demonstrating compliance with the requirements as documented within this report.

Notes:

1. This document reports conditions under which testing was conducted and the results of testing performed.
2. Details of test methods used have been recorded and kept on file by the laboratory.
3. Test results apply only to the item(s) tested.

Approved & Released for MiCOM Labs, Inc. by:



Graeme Grieve
Quality Manager MiCOM Labs,



Gordon Hurst
President & CEO MiCOM Labs, Inc.

This test report may be reproduced in full only. The document may only be updated by MiCOM Labs personnel. Any changes will be noted in the Document History section of the report.

2. REFERENCES AND MEASUREMENT UNCERTAINTY

2.1. Normative References

Ref.	Publication	Year	Title
(i)	FCC 47 CFR Part 90	2004	Code of Federal Regulations
(ii)	FCC 47 CFR Part 90 Sect 90.210 Sect 90.1215	18 th May 2005	90.210 Emission Masks (Revised requirements) 90.1215 Power Limits (Revised requirements)
(iii)	Industry Canada	Issue 1 July 2006	Broadband Public Safety Equipment Operating in the Band 4940 4990 MHz
(iv)	ANSI C63.4	2003	American National Standards for Methods of Measurement of Radio-Noise Emissions from Low-Voltage Electrical and Electronic Equipment in the Range of 9 kHz to 40 GHz
(v)	CISPR 22/ EN 55022	1997 1998	Limits and Methods of Measurements of Radio Disturbance Characteristics of Information Technology Equipment
(vi)	ANSI/TIA-603	2004	Land Mobile FM or PM Communications Equipment Measurement and Performance Standards
(vii)	M 3003	Edition 1 Dec. 1997	Expression of Uncertainty and Confidence in Measurements
(viii)	LAB34	Edition 1 Aug 2002	The expression of uncertainty in EMC Testing
(ix)	ETSI TR 100 028	2001	Parts 1 and 2 Electromagnetic compatibility and Radio Spectrum Matters (ERM); Uncertainties in the measurement of mobile radio equipment characteristics
(x)	A2LA	14 th September 2005	Reference to A2LA Accreditation Status – A2LA Advertising Policy

This test report may be reproduced in full only. The document may only be updated by MiCOM Labs personnel. Any changes will be noted in the Document History section of the report.



Title: EX-4.9i Microwave Fixed Link
To: FCC Part 90 Subpart Y & IC RSS-111
Serial #: EXLT13-A1 Rev A
Issue Date: 12th February 2007
Page: 10 of 102

2.2. Test and Uncertainty Procedures

Conducted and radiated emission measurements were conducted in accordance with American National Standards Institute ANSI C63.4, listed in the Normative References section of this report.

Measurement uncertainty figures are calculated in accordance with ETSI TR 100 028 Parts 1 and 2.

Measurement uncertainties stated are based on a standard uncertainty multiplied by a coverage factor $k = 2$, providing a level of confidence of approximately 95 % in accordance with UKAS document M 3003 listed in the Normative References section of this report.

This test report may be reproduced in full only. The document may only be updated by MiCOM Labs personnel. Any changes will be noted in the Document History section of the report.



Title: EX-4.9i Microwave Fixed Link
To: FCC Part 90 Subpart Y & IC RSS-111
Serial #: EXLT13-A1 Rev A
Issue Date: 12th February 2007
Page: 11 of 102

3. PRODUCT DETAILS AND TEST CONFIGURATIONS

3.1. Technical Details

Details	Description		
Purpose:	Test of the EX-4.9i Microwave Fixed Link to FCC 47 CFR Part 90 Subpart Y regulations and Industry Canada RSS-111 regulations.		
Applicant:	As Manufacturer		
Manufacturer:	Exalt Communications, Inc 580 Division Street Campbell, California 95008, USA		
Laboratory performing the tests:	MiCOM Labs, Inc. 440 Boulder Court, Suite 200 Pleasanton, California 94566 USA		
Test report reference number:	EXLT13-A1 Rev A		
Date EUT received:	29 th December 2006		
Dates of test (from - to):	30th Dec '06 - 6th Jan '07		
Standard(s) applied:	FCC Part 90 Subpart Y & IC RSS-111		
No of Units Tested:	1		
Type of Equipment:	4.9 GHz Point to Point Fixed Link Radio		
Manufacturers Trade Name:	Exalt Communications, Inc		
Model:	EX-4.9i		
Location for use:	Indoor use only		
Declared Frequency Range(s):	4940 to 4990 MHz		
Type of Modulation:	QPSK, 16QAM, 64QAM		
Operational Bandwidths:	10 MHz, 20 MHz.		
Declared Maximum Output Power:	+24 dBm		
ITU Emission Designator:	Modulation	10 MHz	20 MHz:
	QPSK	8M72W7D	19M0W7D
	16QAM	8M72W7D	19M0W7D
	64QAM	8M72W7D	19M0W7D
Transmit/Receive Operation:	Time Division Duplex (TDD)		
Rated Input Voltage and Current:	+48 Vdc 0.8 A +24 Vdc 1.6A.		
Operating Temperature Range:	-25°C to +65°C		
Microprocessor(s) Model:	MPC852T		
Clock/Oscillator(s):	25MHz, 1.544 MHz, 2.048 MHz, 12.880 MHz, 44.736 MHz, 34.368 MHz, 100 MHz, 120 MHz		
Frequency Stability:	±7 ppm		
Equipment Dimensions:	44cm x 36 cm x 6.5 cm		
Weight:	5.4 kgs		
Primary function of equipment:	4.9 GHz Point to Point Fixed Link Radio		

This test report may be reproduced in full only. The document may only be updated by MiCOM Labs personnel. Any changes will be noted in the Document History section of the report.

3.2. Scope of Test Program

The scope of the test program was to test the Exalt Communications, Inc EX-4.9i Microwave Fixed Link for compliance against:-

FCC 47 CFR Part 90, Subpart Y regulatory requirements.

18th May 2005 revision of FCC 47 CFR Part 90;-

Sub Section 90.210	Emission Masks (revised requirements)
Sub Section 90.1215	Power Limits (revised requirements)

and Industry Canada RSS-111 specifications.

The EX-4.9i Microwave Fixed Link has a connector for external antenna use. It has two operational bandwidths 10 and 20 MHz and employs three modulation schemes QPSK, 16QAM, 64QAM in the frequency range 4940 to 4990 MHz;

Exalt Communications, Inc

EX-4.9i Microwave Fixed Link Public Safety Band Radio



This test report may be reproduced in full only. The document may only be updated by MiCOM Labs personnel. Any changes will be noted in the Document History section of the report.

3.3. Equipment Model(s) and Serial Number(s)

EUT/ Support	Name	Manufacturer	Model No.	Serial No.
EUT	4.9 GHz Public Safety Band Radio	Exalt Communications, Inc	EX-4.9i	N/A
EUT	Cincon	48 Vdc Power Supply	TR45A4801 A03	
Support	Laptop	IBM	2896-72U	FX-05793 - 4/03

Test Set-Up for Conducted Emissions

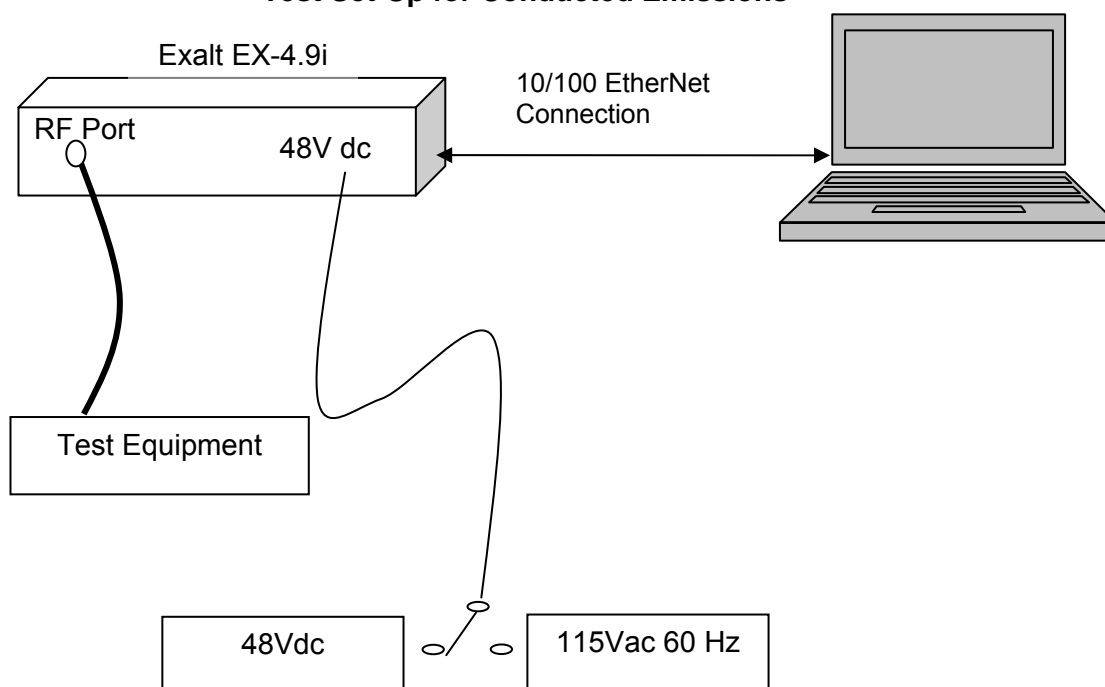

This test report may be reproduced in full only. The document may only be updated by MiCOM Labs personnel. Any changes will be noted in the Document History section of the report.



Title: EX-4.9i Microwave Fixed Link
To: FCC Part 90 Subpart Y & IC RSS-111
Serial #: EXLT13-A1 Rev A
Issue Date: 12th February 2007
Page: 14 of 102

3.4. Antenna Details

Antenna Type	Gain (dBi)	Manufacturer	Model No.	Serial No.

No antennas were submitted for test purposes

3.5. Cabling and I/O Ports

Number and type of I/O ports

Number and type of I/O ports

1. 10/100 BT Ethernet: 2 ports
2. T1/E1: 4 ports
3. Sync In/Out
4. Console and Alarms

This test report may be reproduced in full only. The document may only be updated by MiCOM Labs personnel. Any changes will be noted in the Document History section of the report.



3.6. Test Configurations

Matrix of test configurations

Parameter	Operational Mode	Test Conditions	Bandwidths (MHz)
26 dB / 99% Occupied BW & Emission Mask	Modulated - QPSK, 16QAM, 64QAM	Ambient, 48Vdc	10, 20
Average Output power			
Peak Output power			
Peak Power Spectral Density			
Frequency Stability	CW	Temperature and Voltage Variations (48, 43.2, 52.8 Vdc)	20
Conducted Spurious Emissions	Modulated - QPSK, 16QAM, 64QAM	Ambient , 48Vdc	10, 20
Radiated Spurious Emissions	Modulated - QPSK	Ambient 115 Vac 60 Hz	10
AC Wireline Emissions	Modulated - QPSK	Ambient 115 Vac 60 Hz	10

BW (MHz)	Modulation								
	QPSK			16QAM			64QAM		
	Low (MHz)	Mid (MHz)	High (MHz)	Low (MHz)	Mid (MHz)	High (MHz)	Low (MHz)	Mid (MHz)	High (MHz)
10	4945	4965	4985	4945	4965	4985	4945	4965	4985
20	4950	4965	4980	4950	4965	4980	4950	4965	4980

Only worst case plots are provided for each test parameter are identified within this report. Plots not included are held on file by the test laboratory and available upon request with client permission.



Title: EX-4.9i Microwave Fixed Link
To: FCC Part 90 Subpart Y & IC RSS-111
Serial #: EXLT13-A1 Rev A
Issue Date: 12th February 2007
Page: 16 of 102

3.7. Equipment Modifications

The following modifications were required to bring the equipment into compliance:

1. NONE

3.8. Deviations from the Test Standard

The following deviations from the test standard were required in order to complete the test program:

1. NONE

3.9. Subcontracted Testing or Third Party Data

1. NONE

This test report may be reproduced in full only. The document may only be updated by MiCOM Labs personnel. Any changes will be noted in the Document History section of the report.



4. TEST SUMMARY

List of Measurements

The following table represents the list of measurements required under the **FCC CFR47 Part 90, Subpart Y, Industry Canada RSS-111**, and **Industry Canada RSS-Gen**.

Section(s)	Test Items	Description	Condition	Result	Test Report Section
2.1049; 90.210(m) 4.4	26 dB / 99% Occupied BW & Emission Mask	Emission mask and bandwidth measurement(s)	Conducted	Complies	5.1.1
2.1046; 90.1215 (a) 4.3	Peak and Average Output Power	Modulated Output Power	Conducted	Complies	5.1.2
2.1046; 90.1215 (a) 4.3	Peak Power Spectral Density	Maximum Spectral Density	Conducted	Complies	5.1.3
Subpart C 90.1217	Maximum Permissible Exposure	Exposure to radio frequency energy levels	Radiated	Complies	5.1.4
2.1055(a)(1); 90.213 4.2	Frequency Stability	Includes temperature and voltage variations	Conducted	Complies	5.1.5
2.1051; 90.210(m) 4.4/4.5 6	Conducted Spurious Emissions at Antenna Port	Emissions from the antenna port 30 MHz – 40 GHz	Conducted	Complies	5.1.6
2.1053; 90.210(m) ANSI/TIA- 603 4.4	Radiated Spurious Emissions	Spurious emissions 30 MHz – 40 GHz	Radiated	Complies	5.1.7
15.207 7.2.2	AC Wireline Conducted	Emissions 150 kHz–30 MHz	Conducted	Complies	5.1.8

Note 1: Test results reported in this document relate only to the items tested

Note 2: The required tests demonstrated compliance as per client declaration of test configuration, monitoring methodology and associated pass/fail criteria

This test report may be reproduced in full only. The document may only be updated by MiCOM Labs personnel. Any changes will be noted in the Document History section of the report.

5. TEST RESULTS

5.1. Device Characteristics

5.1.1. Occupied Bandwidth and Emission Mask

FCC 47 CFR Part 90, Subpart Y; 2.1049; §90.210(m)
Industry Canada RSS-111 §4.4

Test Procedure

The transmitter terminal of EUT was connected to the input of the spectrum analyzer set to measure the 26 dB and 99% occupied bandwidth and emission mask for the radio. The system highest power setting was selected with modulation ON and duty cycle set for 100% i.e. continuous operation at all times.

For emission masks the zero dB reference is measured relative to the highest average power of the fundamental emission measured across the designated channel bandwidth using a resolution bandwidth of at least one percent of the occupied bandwidth of the fundamental emission and a video bandwidth of 30 kHz.

The EUT is not equipped with an audio low-pass filter.

Test Measurement Set up

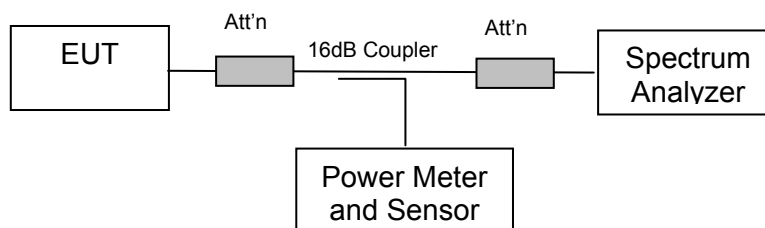

Test set up for Occupied Bandwidth and Mask measurement(s)

Ambient conditions.

Temperature: 19 to 26 °C Relative humidity: 31 to 57 % Pressure: 999 to 1009 mbar



Title: EX-4.9i Microwave Fixed Link
To: FCC Part 90 Subpart Y & IC RSS-111
Serial #: EXLT13-A1 Rev A
Issue Date: 12th February 2007
Page: 19 of 102

QPSK Modulation

Modulation	Bandwidth (MHz)	Center Frequency (MHz)	26 dB Bandwidth (MHz)	99% Bandwidth (MHz)
QPSK	10	4945	10.887	8.717
		4965	10.851	8.717
		4985	10.887	8.717
	20	4950	18.859	16.082
		4965	19.009	15.932
		4980	18.963	15.932

This test report may be reproduced in full only. The document may only be updated by MiCOM Labs personnel. Any changes will be noted in the Document History section of the report.

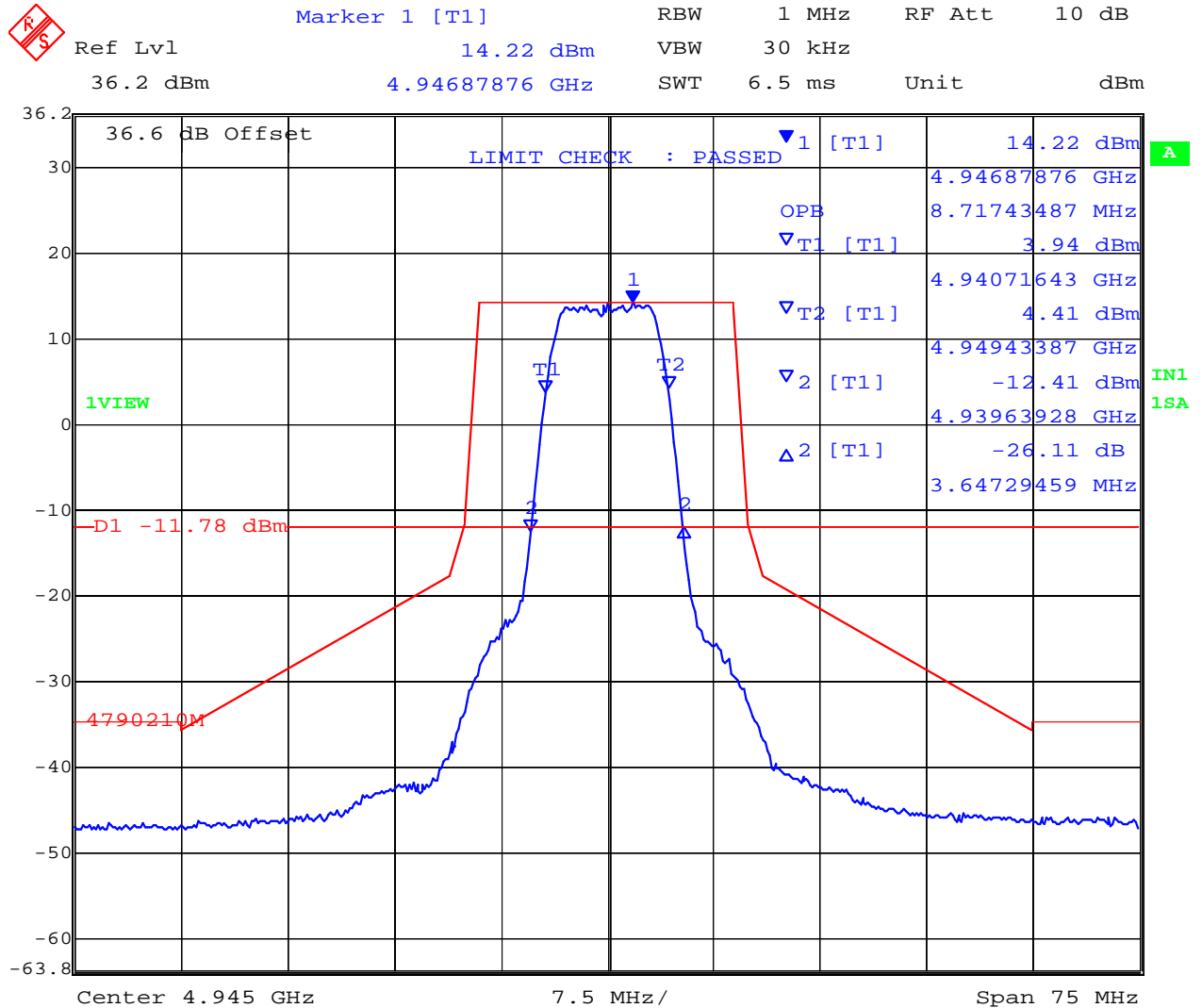

Date: 31.DEC.2006 13:01:47

PLOT - 26 dB & 99% Bandwidths 10 MHz QPSK Channel Frequency 4945 MHz

This test report may be reproduced in full only. The document may only be updated by MiCOM Labs personnel. Any changes will be noted in the Document History section of the report.

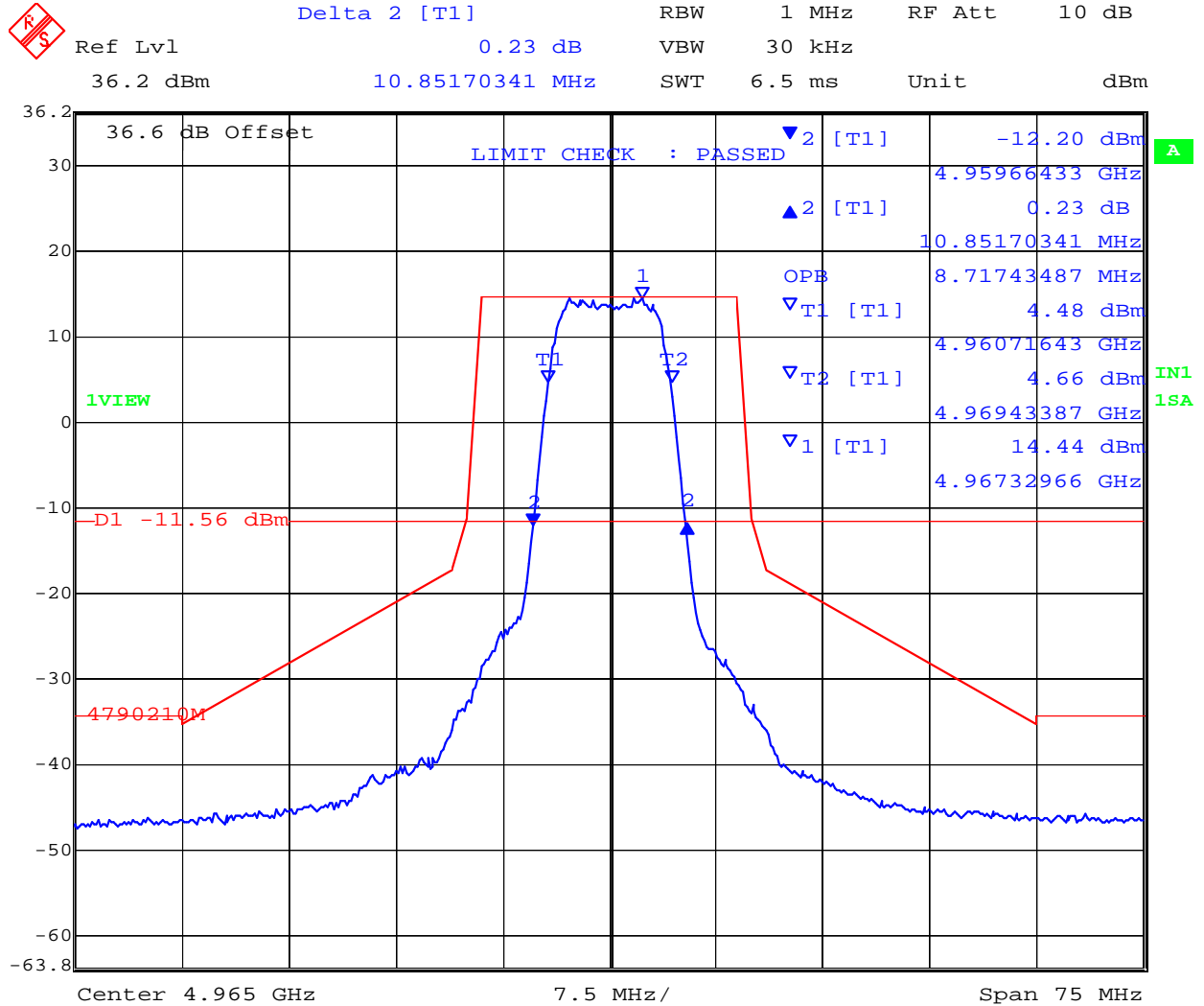

PLOT - 26 dB & 99% Bandwidths 10 MHz QPSK Channel Frequency 4965 MHz

This test report may be reproduced in full only. The document may only be updated by MiCOM Labs personnel. Any changes will be noted in the Document History section of the report.

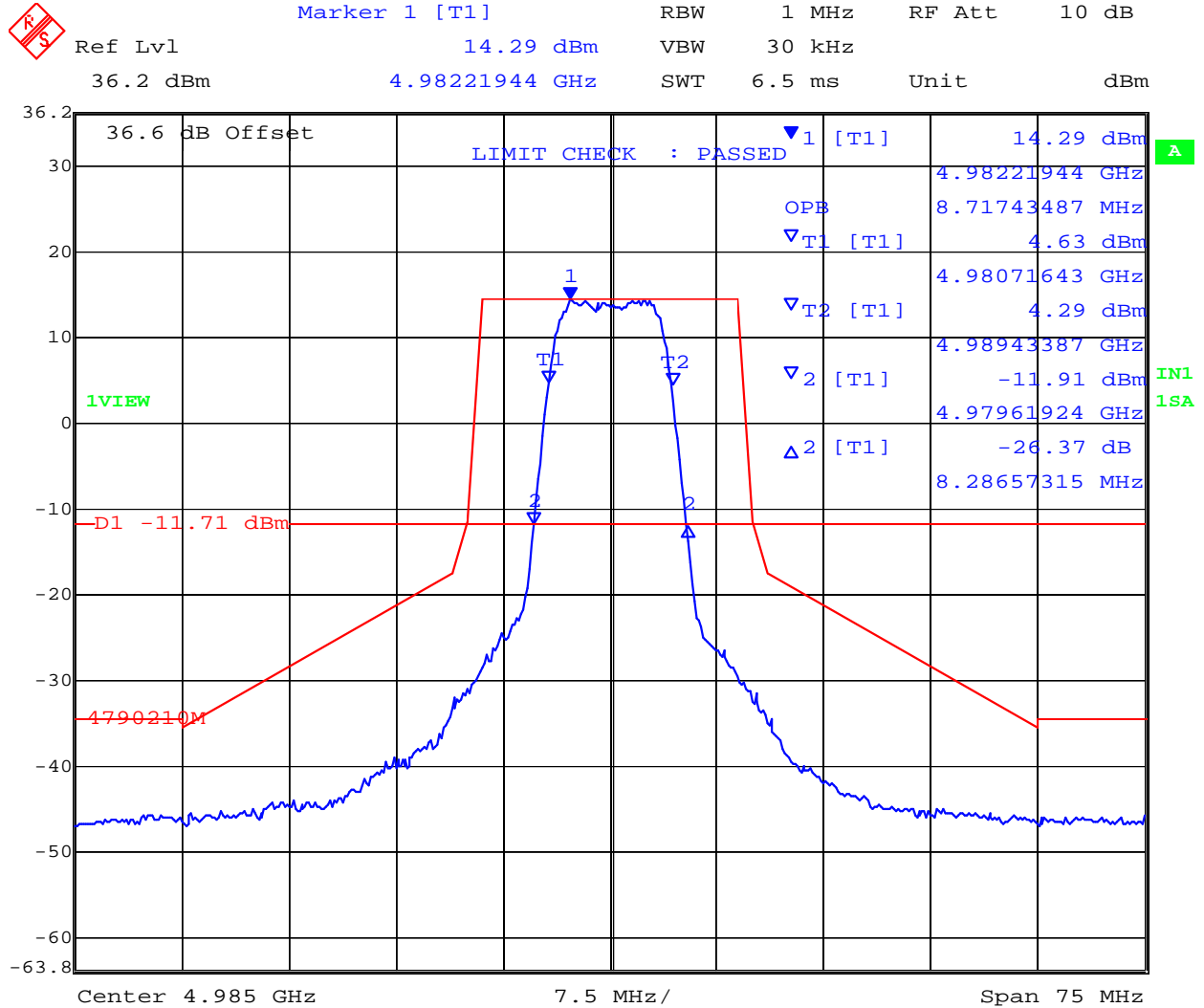

Date: 31.DEC.2006 13:04:55

PLOT - 26 dB & 99% Bandwidths 10 MHz QPSK Channel Frequency 4985 MHz

This test report may be reproduced in full only. The document may only be updated by MiCOM Labs personnel. Any changes will be noted in the Document History section of the report.

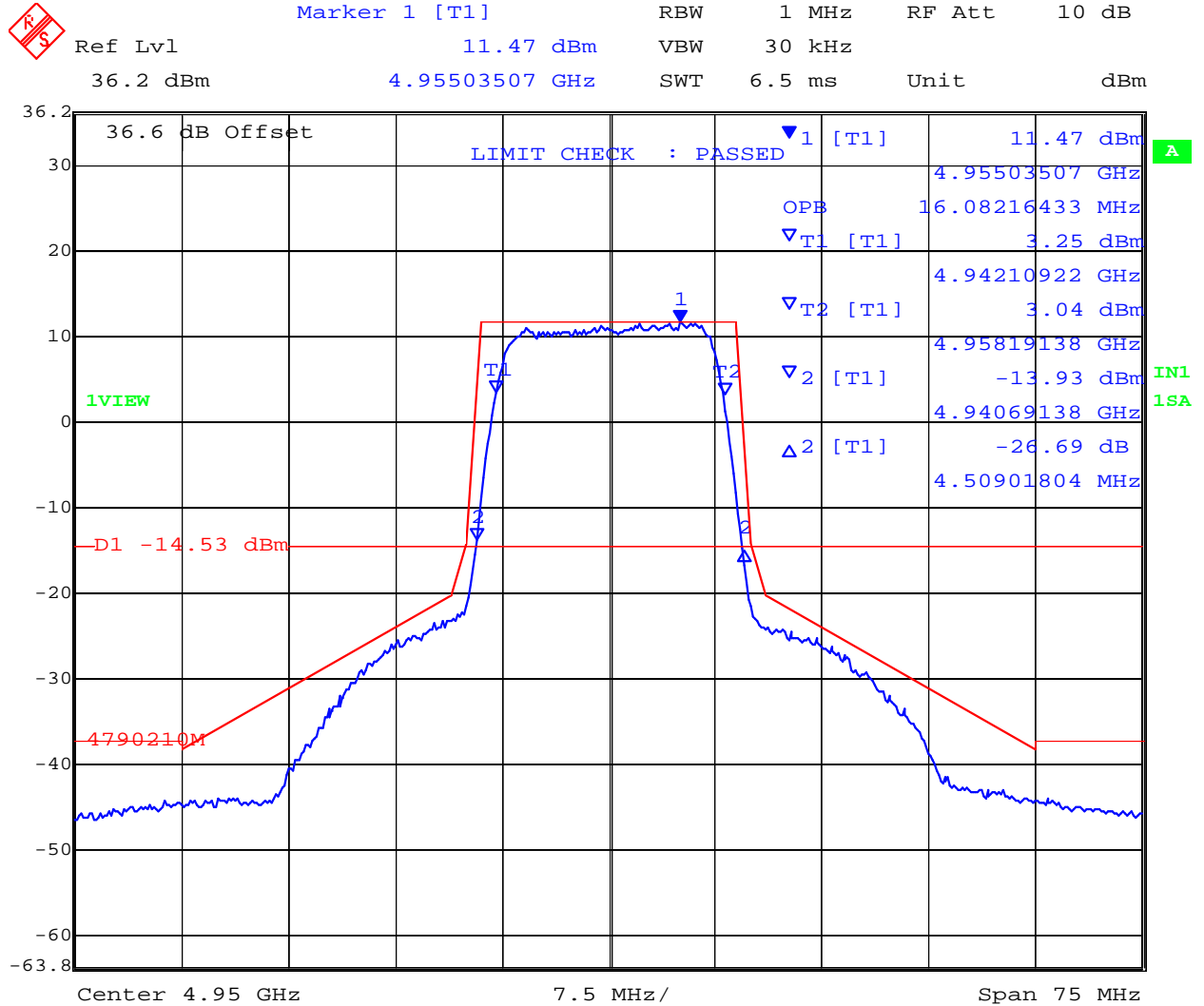

Date: 31.DEC.2006 12:58:33

PLOT - 26 dB & 99% Bandwidths 20 MHz QPSK Channel Frequency 4950 MHz

This test report may be reproduced in full only. The document may only be updated by MiCOM Labs personnel. Any changes will be noted in the Document History section of the report.

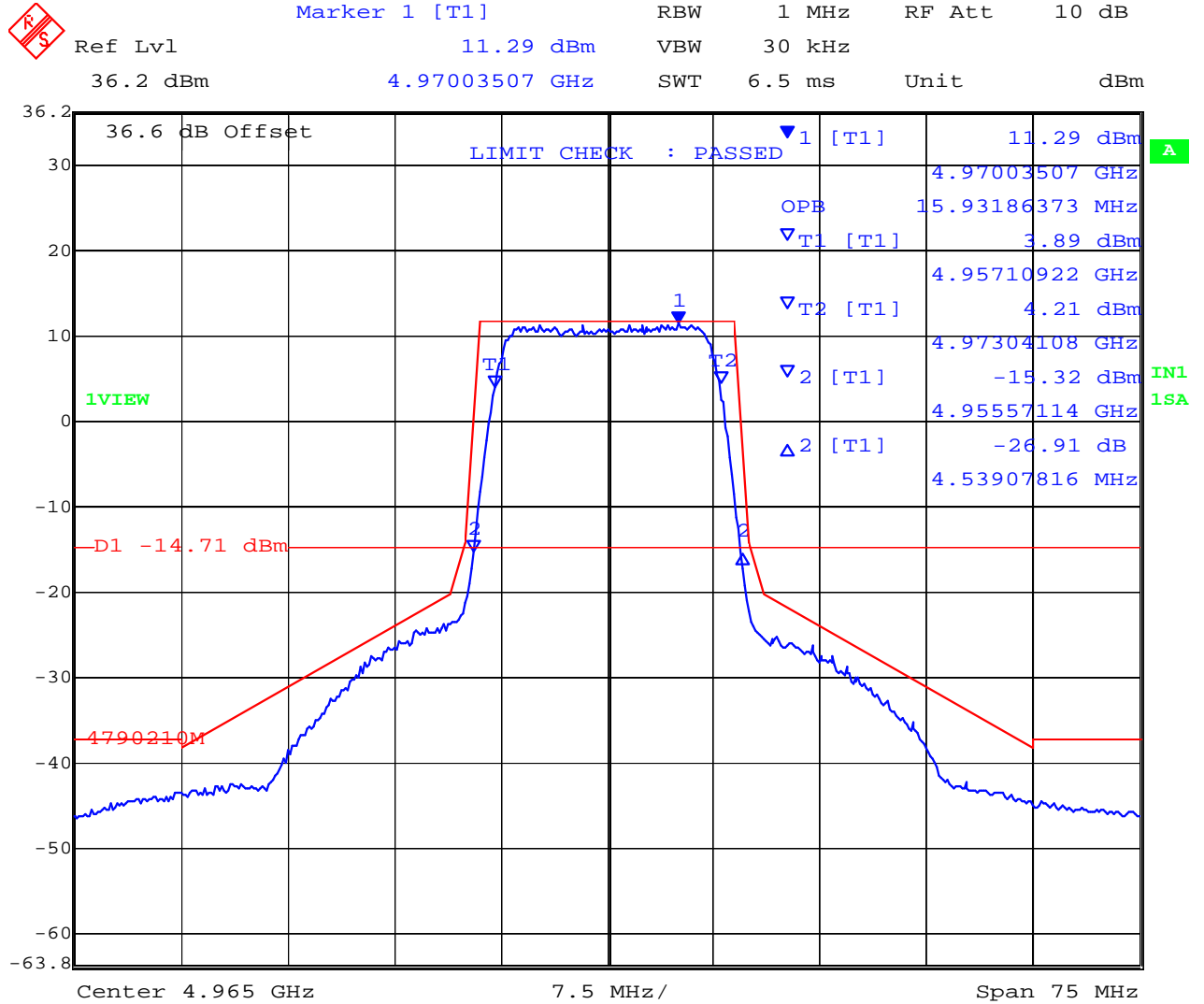

Date: 31.DEC.2006 12:54:11

PLOT - 26 dB & 99% Bandwidths 20 MHz QPSK Channel Frequency 4965 MHz

This test report may be reproduced in full only. The document may only be updated by MiCOM Labs personnel. Any changes will be noted in the Document History section of the report.

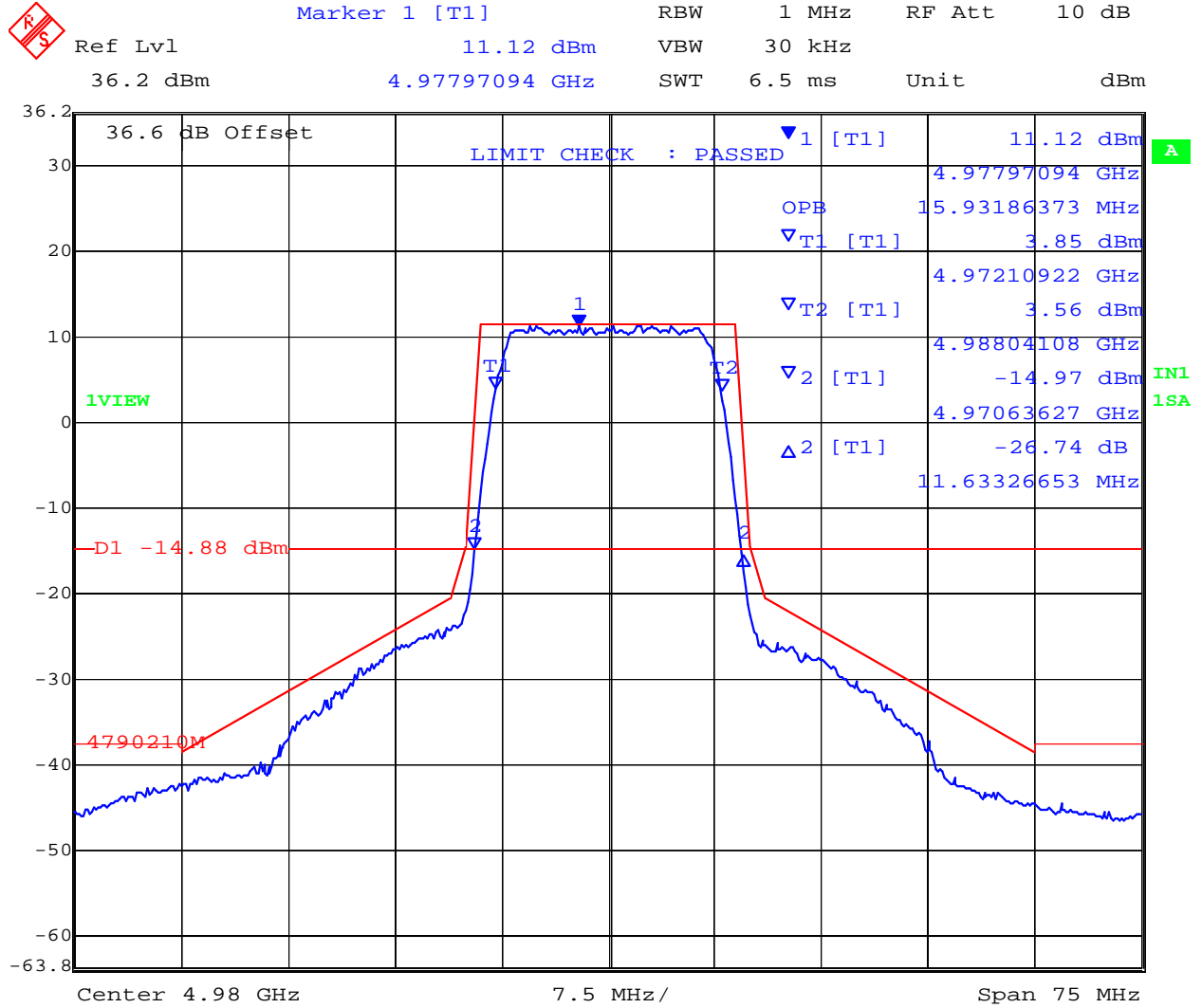

Date: 31.DEC.2006 13:29:07

PLOT - 26 dB & 99% Bandwidths 20 MHz QPSK Channel Frequency 4980 MHz

This test report may be reproduced in full only. The document may only be updated by MiCOM Labs personnel. Any changes will be noted in the Document History section of the report.



Title: EX-4.9i Microwave Fixed Link
To: FCC Part 90 Subpart Y & IC RSS-111
Serial #: EXLT13-A1 Rev A
Issue Date: 12th February 2007
Page: 26 of 102

16QAM Modulation

Modulation	Bandwidth (MHz)	Center Frequency (MHz)	26 dB Bandwidth (MHz)	99% Bandwidth (MHz)
16QAM	10	4945	10.847	8.717
		4965	10.848	8.717
		4985	10.993	8.717
	20	4950	19.007	16.082
		4965	19.008	15.932
		4980	18.851	15.932

This test report may be reproduced in full only. The document may only be updated by MiCOM Labs personnel. Any changes will be noted in the Document History section of the report.

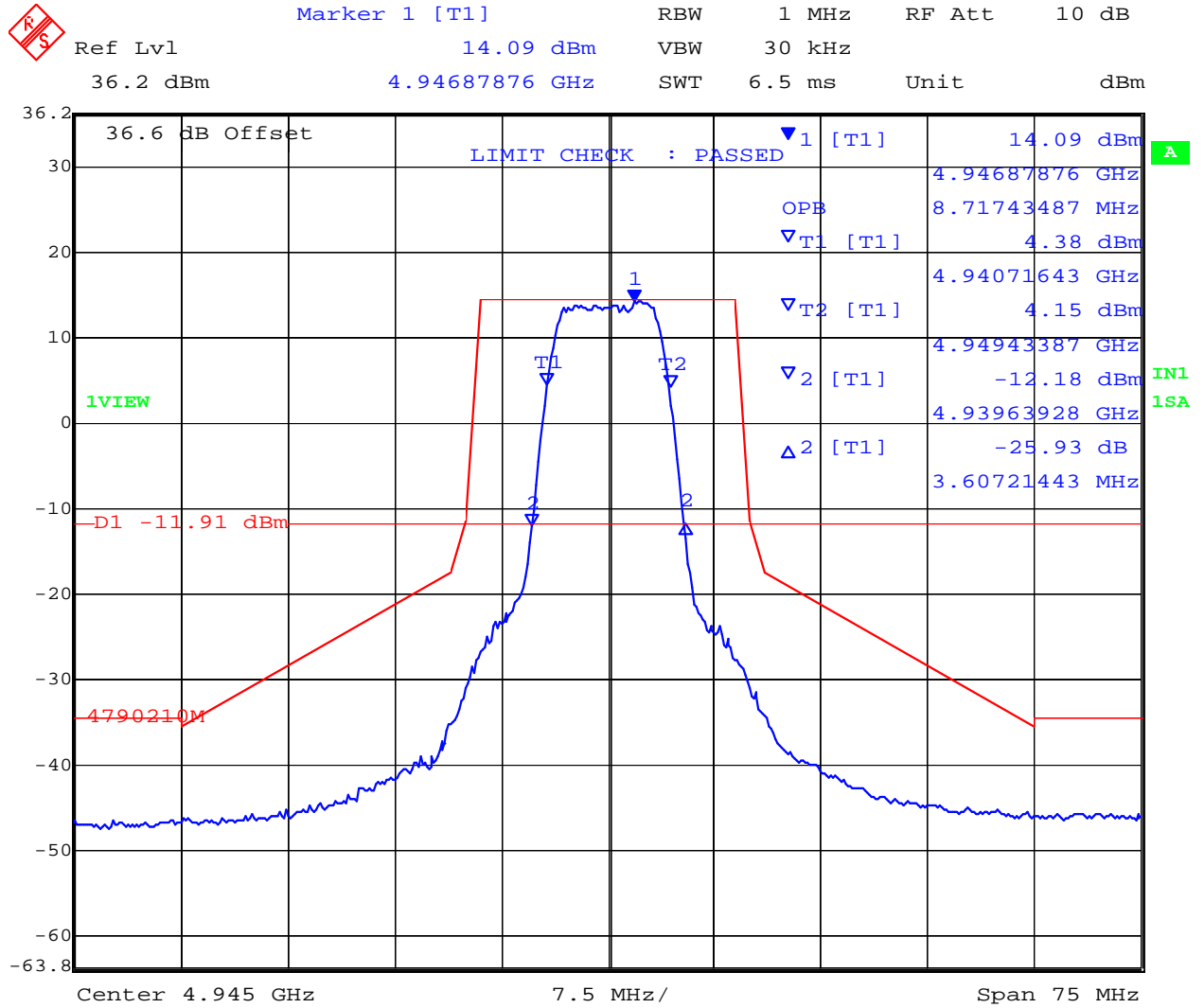

Date: 31.DEC.2006 13:08:07

PLOT - 26 dB & 99% Bandwidths 10 MHz 16 QAM Channel Frequency 4945 MHz

This test report may be reproduced in full only. The document may only be updated by MiCOM Labs personnel. Any changes will be noted in the Document History section of the report.

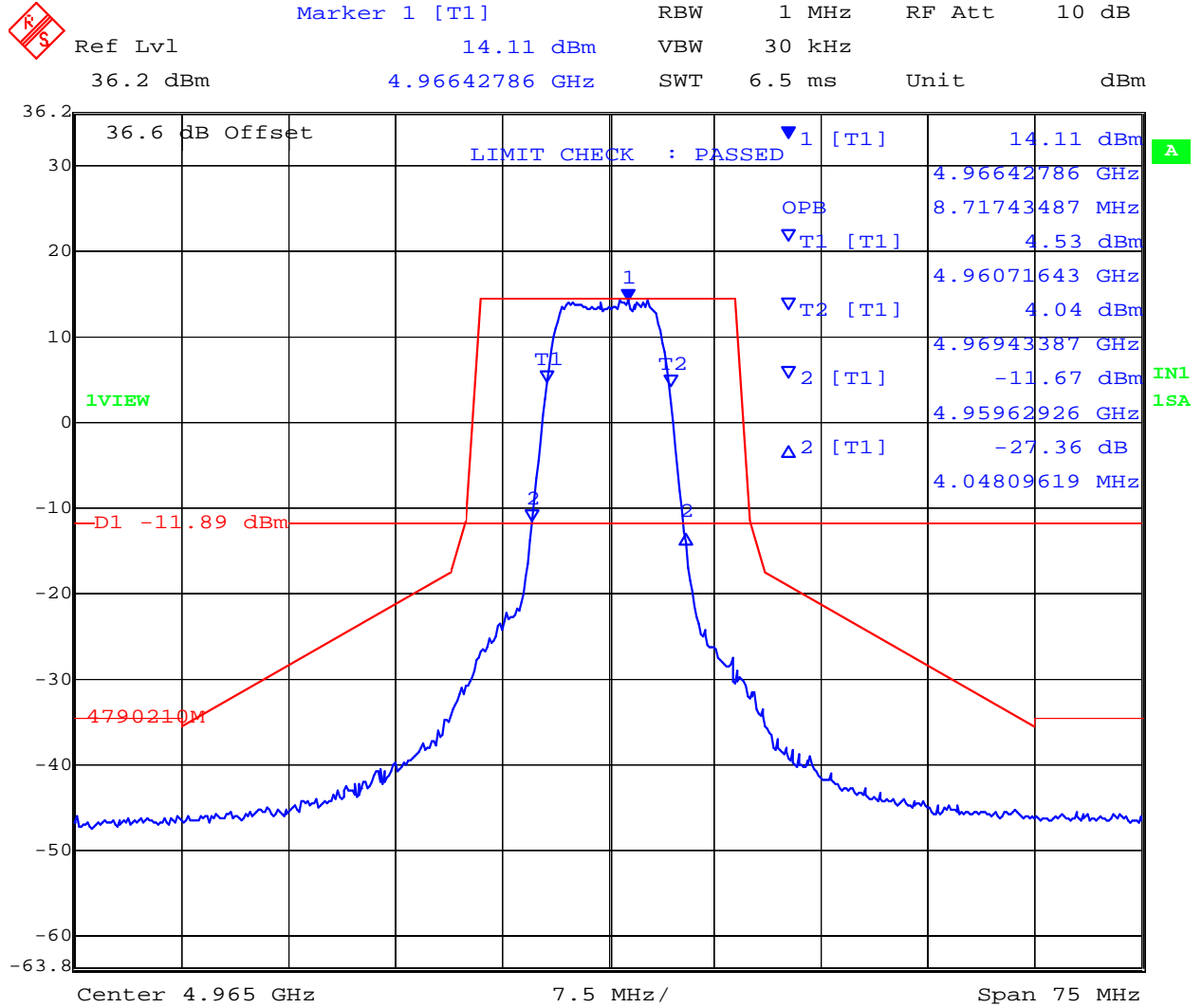

Date: 31.DEC.2006 13:09:53

PLOT - 26 dB & 99% Bandwidths 10 MHz 16 QAM Channel Frequency 4965 MHz

This test report may be reproduced in full only. The document may only be updated by MiCOM Labs personnel. Any changes will be noted in the Document History section of the report.

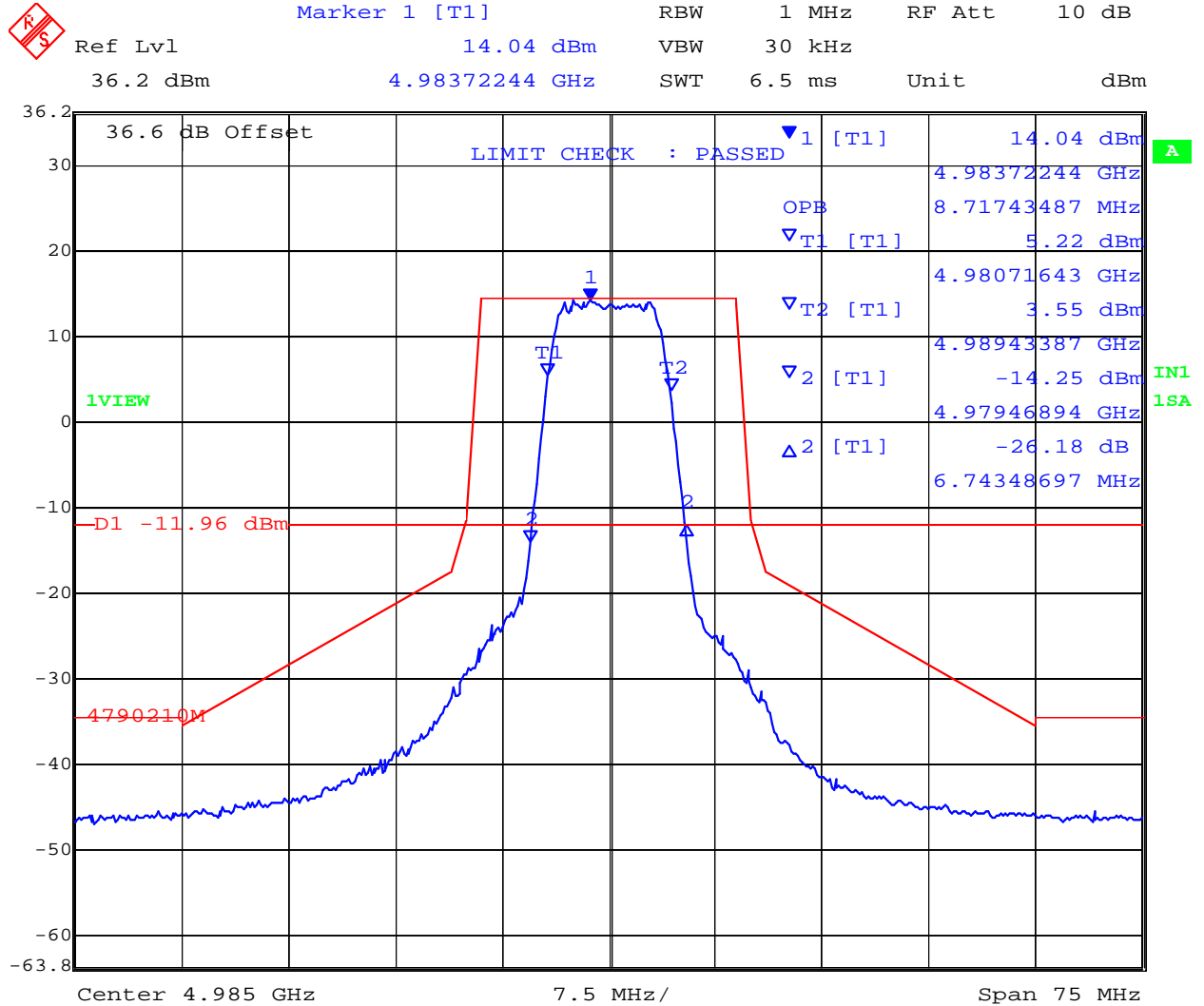

Date: 31.DEC.2006 13:11:17

PLOT - 26 dB & 99% Bandwidths 10 MHz 16 QAM Channel Frequency 4985 MHz

This test report may be reproduced in full only. The document may only be updated by MiCOM Labs personnel. Any changes will be noted in the Document History section of the report.

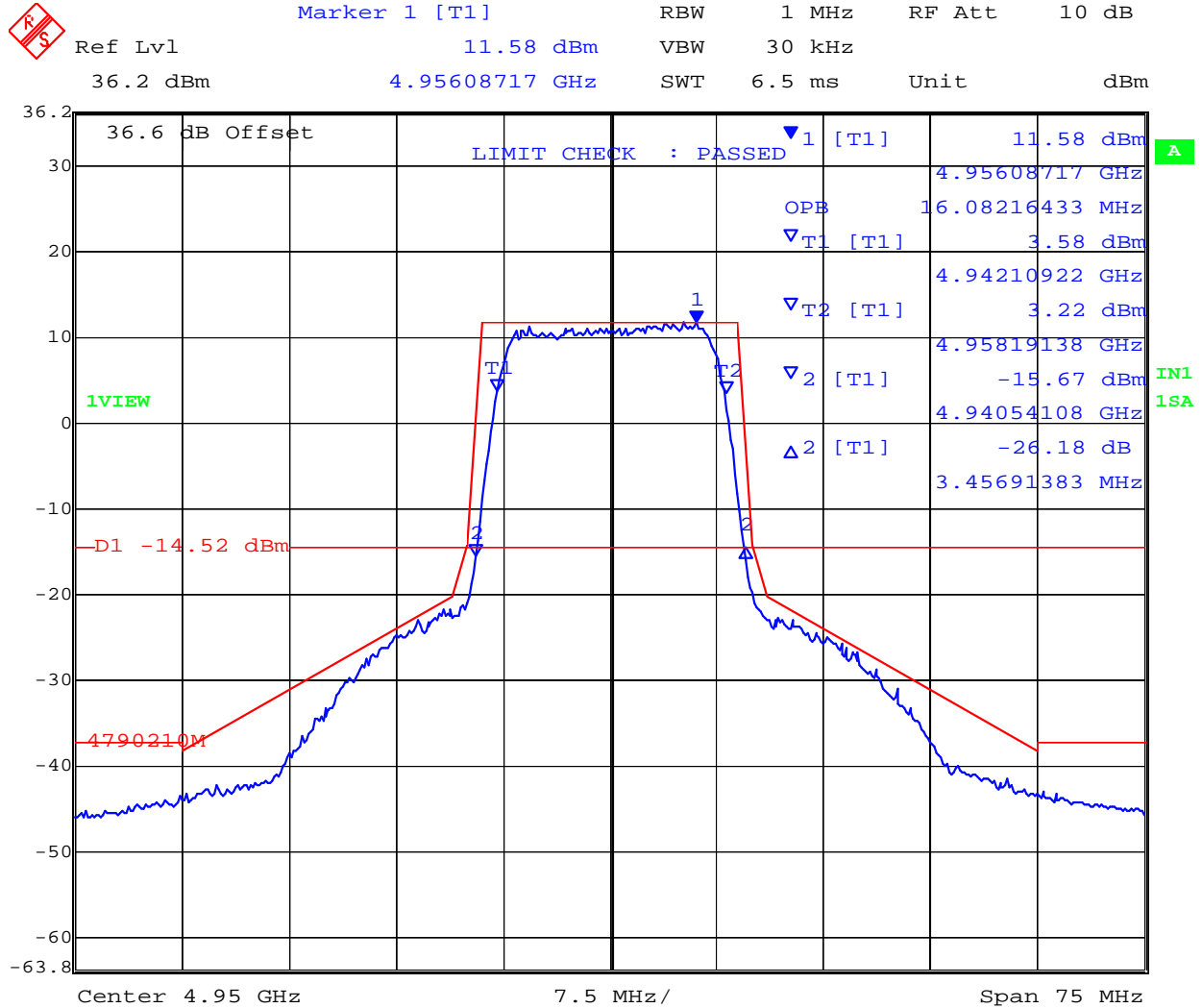

Date: 31.DEC.2006 12:39:52

PLOT - 26 dB & 99% Bandwidths 20 MHz 16 QAM Channel Frequency 4950 MHz

This test report may be reproduced in full only. The document may only be updated by MiCOM Labs personnel. Any changes will be noted in the Document History section of the report.

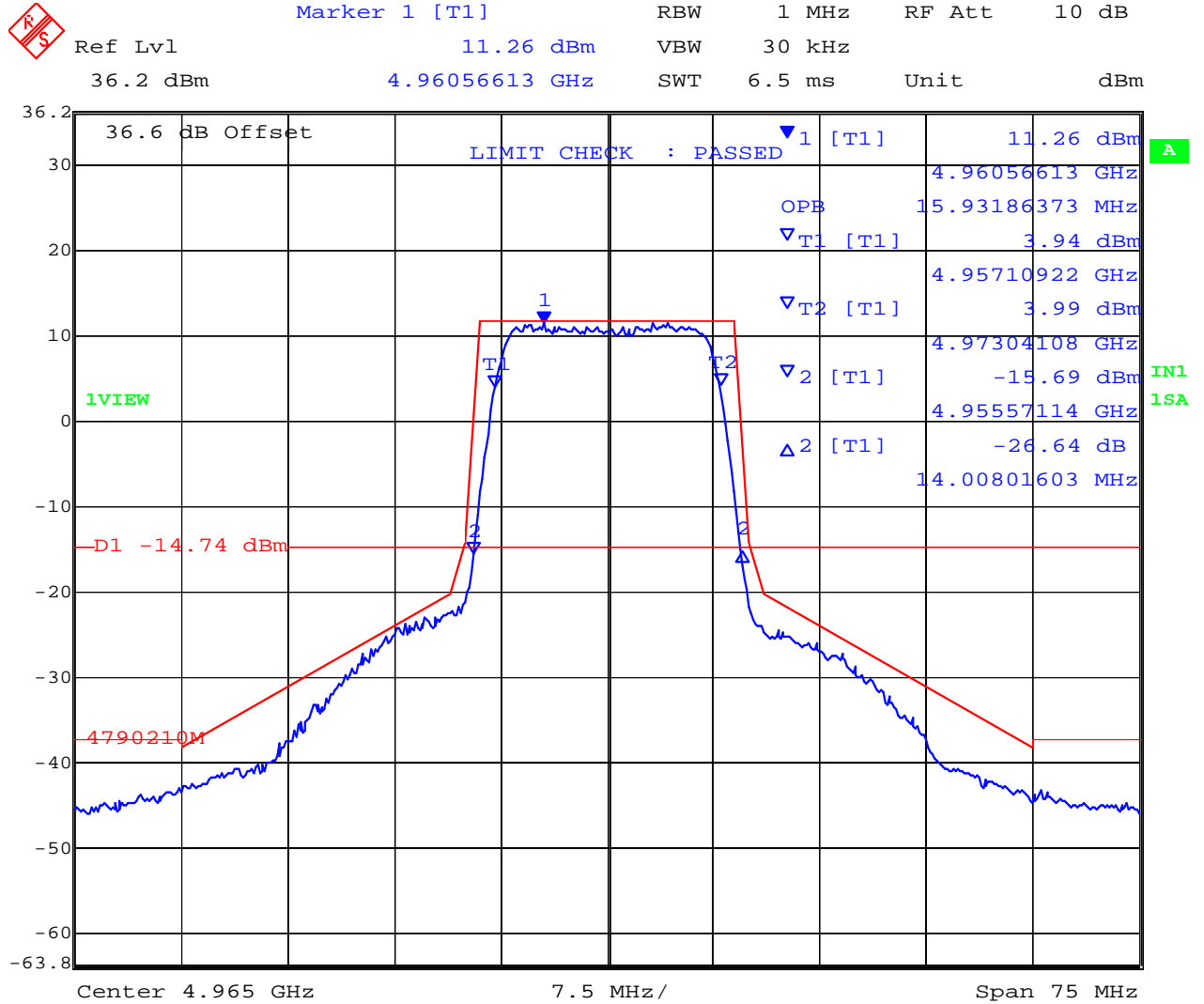

Date: 31.DEC.2006 12:42:16

PLOT - 26 dB & 99% Bandwidths 20 MHz 16 QAM Channel Frequency 4965 MHz

This test report may be reproduced in full only. The document may only be updated by MiCOM Labs personnel. Any changes will be noted in the Document History section of the report.

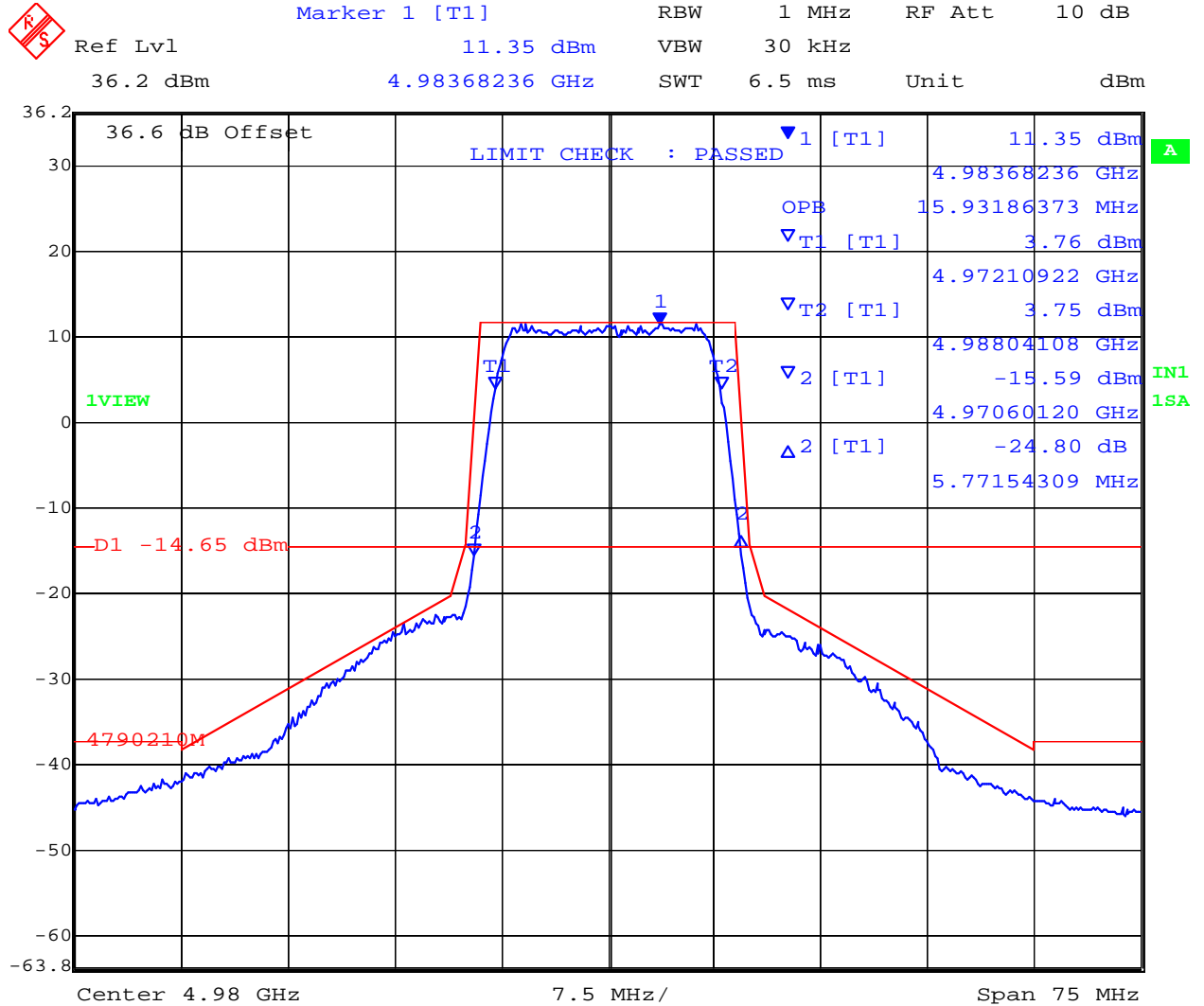

Date: 31.DEC.2006 12:44:09

PLOT - 26 dB & 99% Bandwidths 20 MHz 16 QAM Channel Frequency 4980 MHz

This test report may be reproduced in full only. The document may only be updated by MiCOM Labs personnel. Any changes will be noted in the Document History section of the report.



Title: EX-4.9i Microwave Fixed Link
To: FCC Part 90 Subpart Y & IC RSS-111
Serial #: EXLT13-A1 Rev A
Issue Date: 12th February 2007
Page: 33 of 102

64QAM Modulation

Modulation	Bandwidth (MHz)	Center Frequency (MHz)	26 dB Bandwidth (MHz)	99% Bandwidth (MHz)
64QAM	10	4945	10.846	8.717
		4965	10.827	8.717
		4985	10.827	8.717
	20	4950	18.962	16.082
		4965	18.968	15.932
		4980	18.808	15.932

This test report may be reproduced in full only. The document may only be updated by MiCOM Labs personnel. Any changes will be noted in the Document History section of the report.

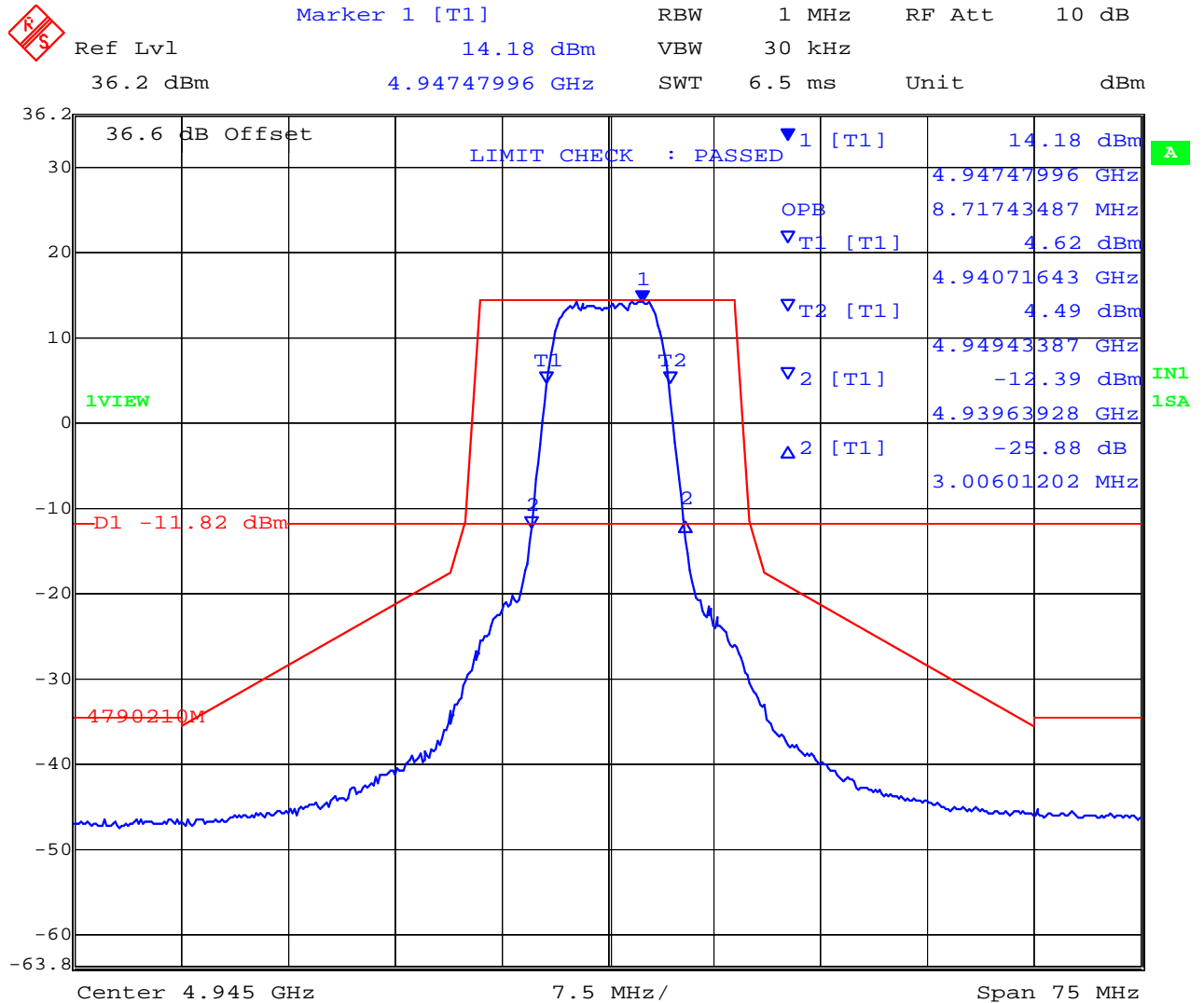

Date: 31.DEC.2006 13:13:53

PLOT - 26 dB & 99% Bandwidths 10 MHz 64QAM Channel Frequency 4945 MHz

This test report may be reproduced in full only. The document may only be updated by MiCOM Labs personnel. Any changes will be noted in the Document History section of the report.

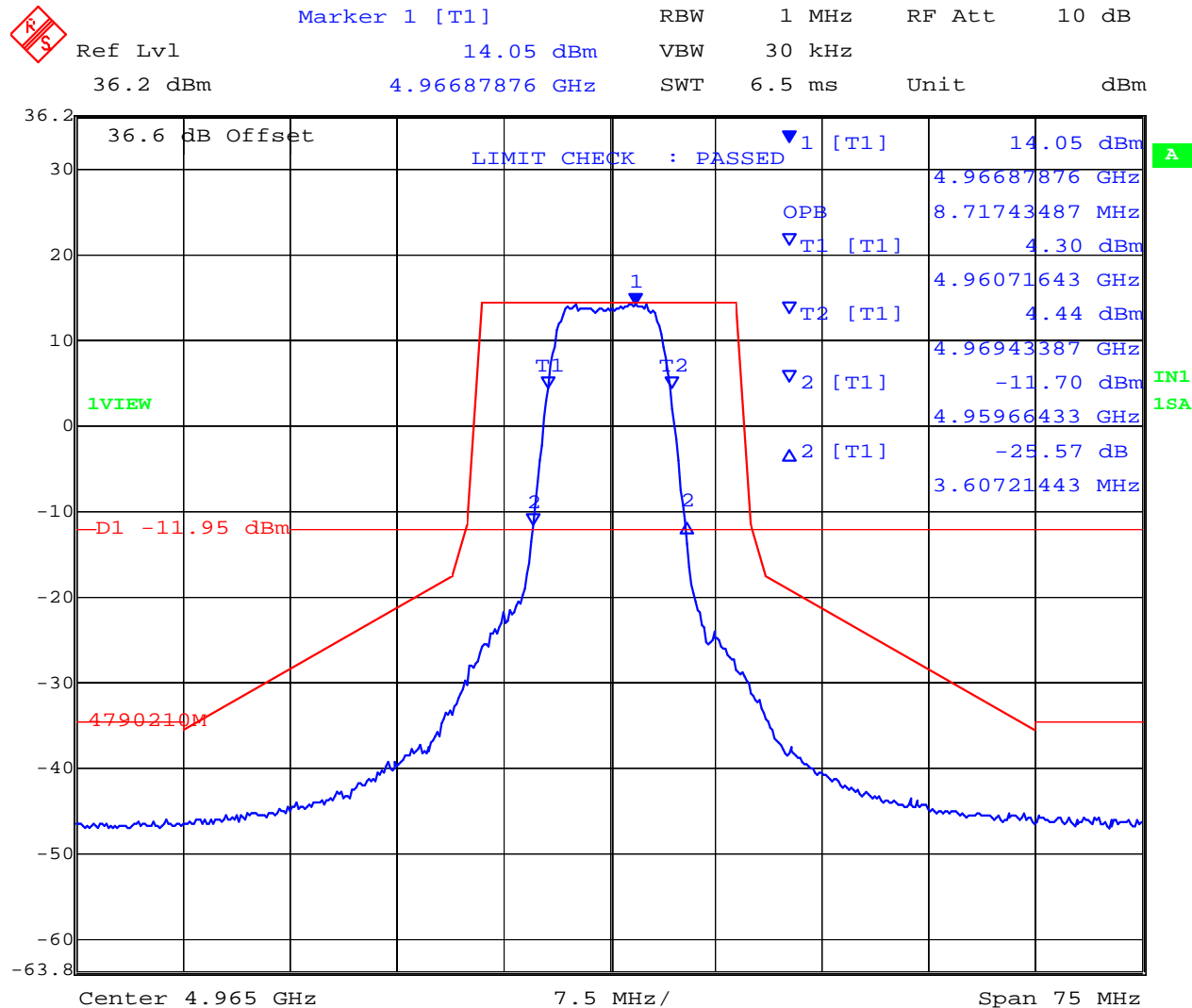

Date: 31.DEC.2006 13:15:57

PLOT - 26 dB & 99% Bandwidths 10 MHz 64QAM Channel Frequency 4965 MHz

This test report may be reproduced in full only. The document may only be updated by MiCOM Labs personnel. Any changes will be noted in the Document History section of the report.

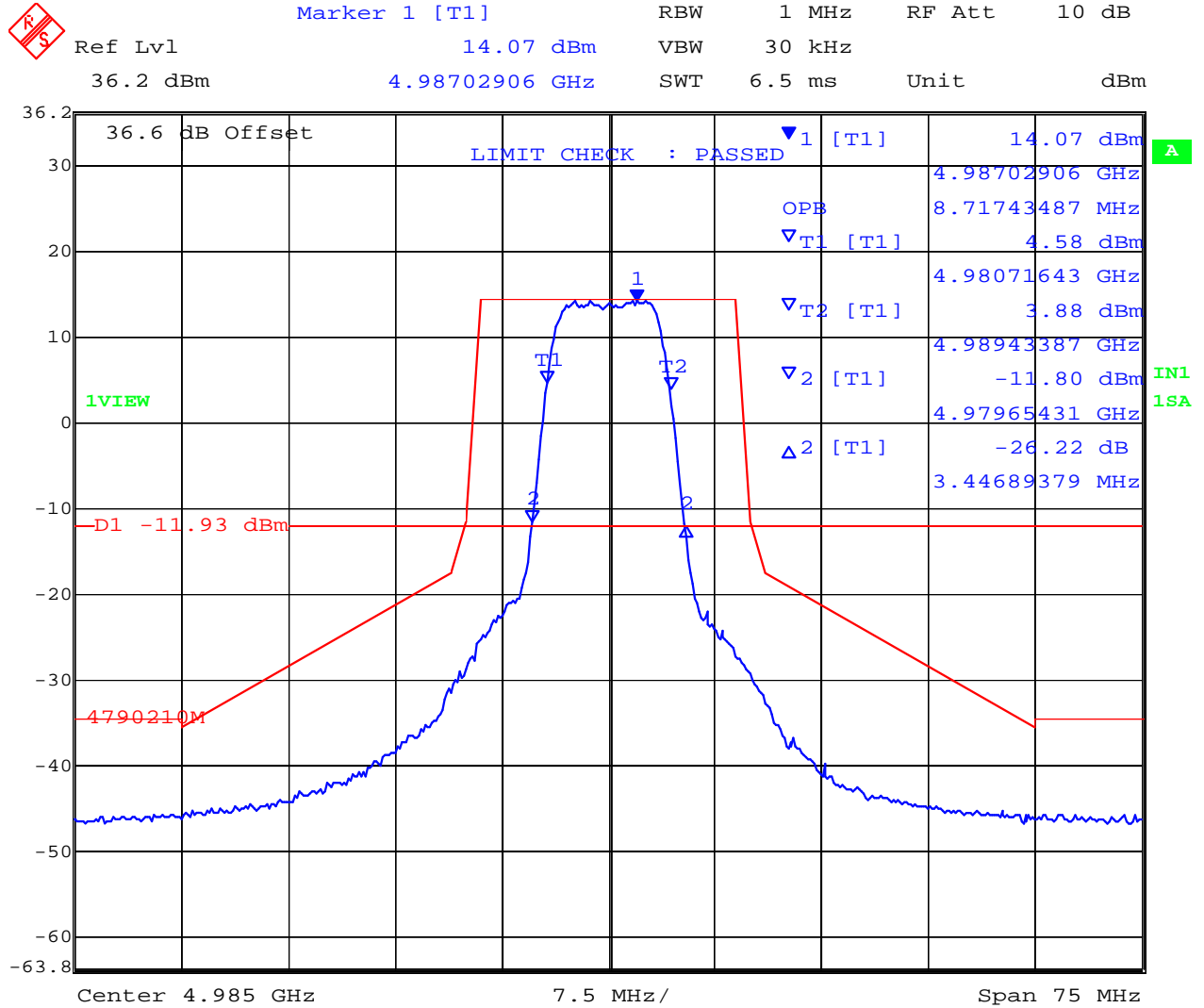

Date: 31.DEC.2006 13:17:23

PLOT - 26 dB & 99% Bandwidths 10 MHz 64QAM Channel Frequency 4985 MHz

This test report may be reproduced in full only. The document may only be updated by MiCOM Labs personnel. Any changes will be noted in the Document History section of the report.

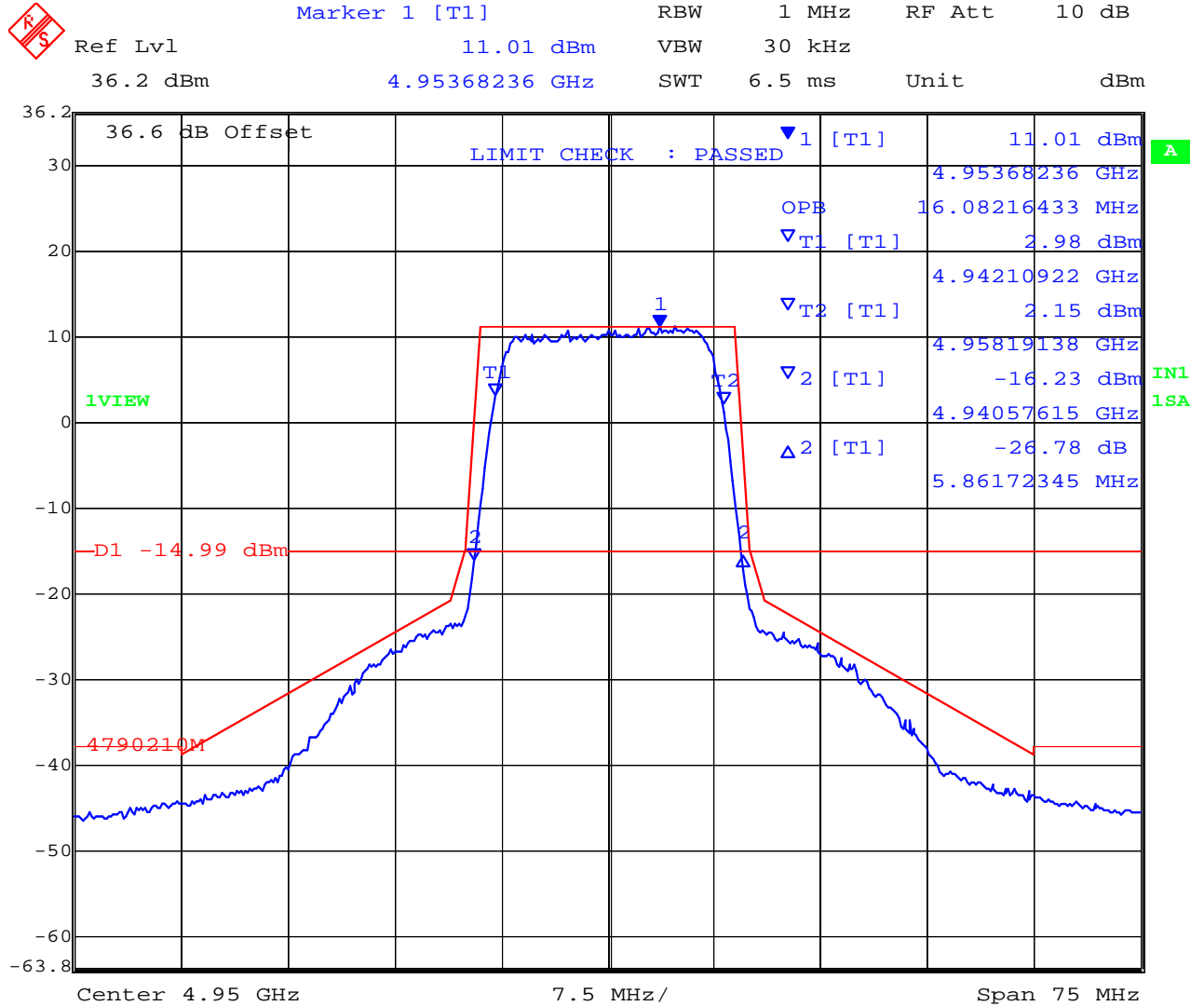

Date: 31.DEC.2006 13:20:41

PLOT - 26 dB & 99% Bandwidths 20 MHz 64QAM Channel Frequency 4950 MHz

This test report may be reproduced in full only. The document may only be updated by MiCOM Labs personnel. Any changes will be noted in the Document History section of the report.

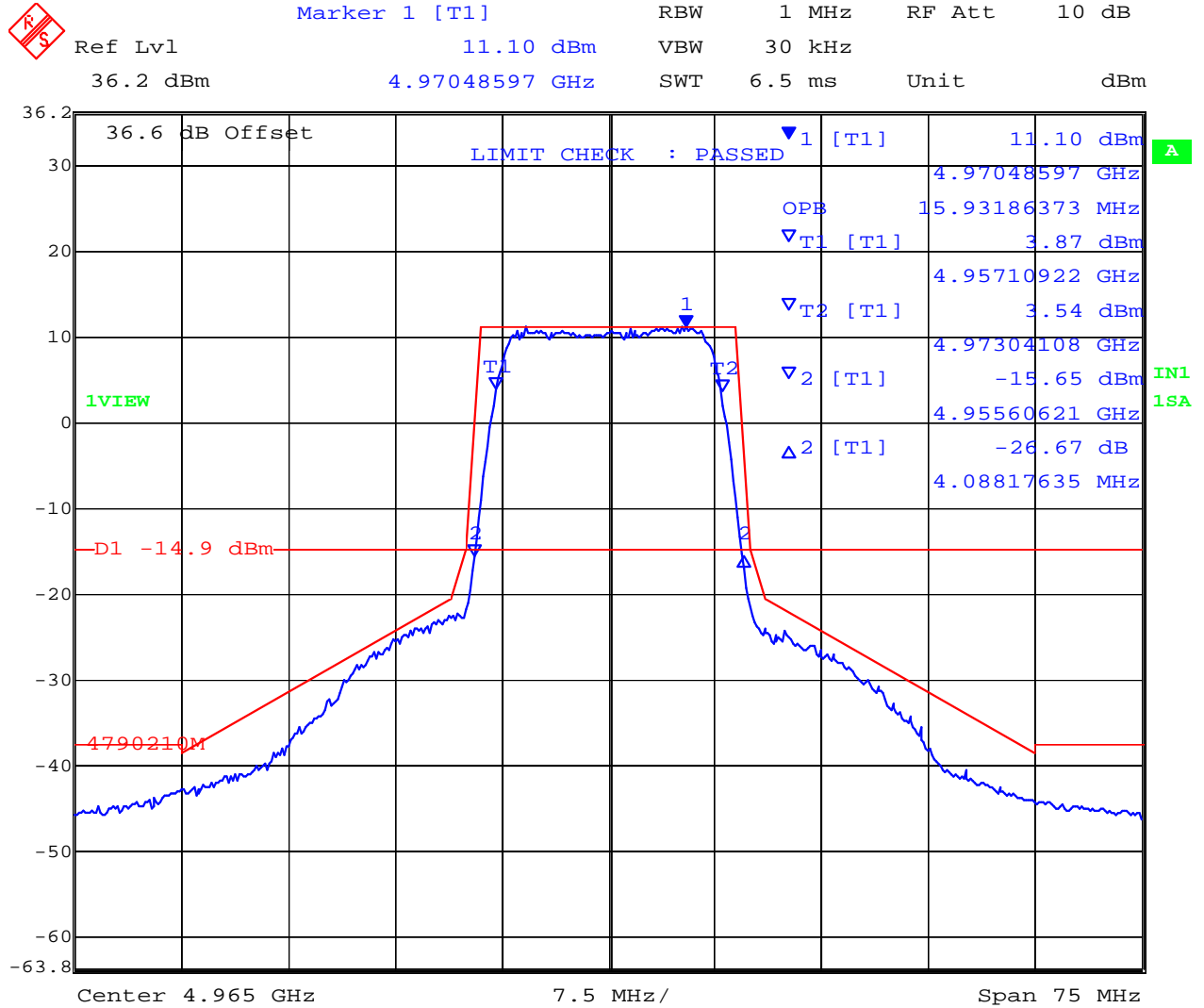

Date: 31.DEC.2006 13:23:02

PLOT - 26 dB & 99% Bandwidths 20 MHz 64QAM Channel Frequency 4965 MHz

This test report may be reproduced in full only. The document may only be updated by MiCOM Labs personnel. Any changes will be noted in the Document History section of the report.

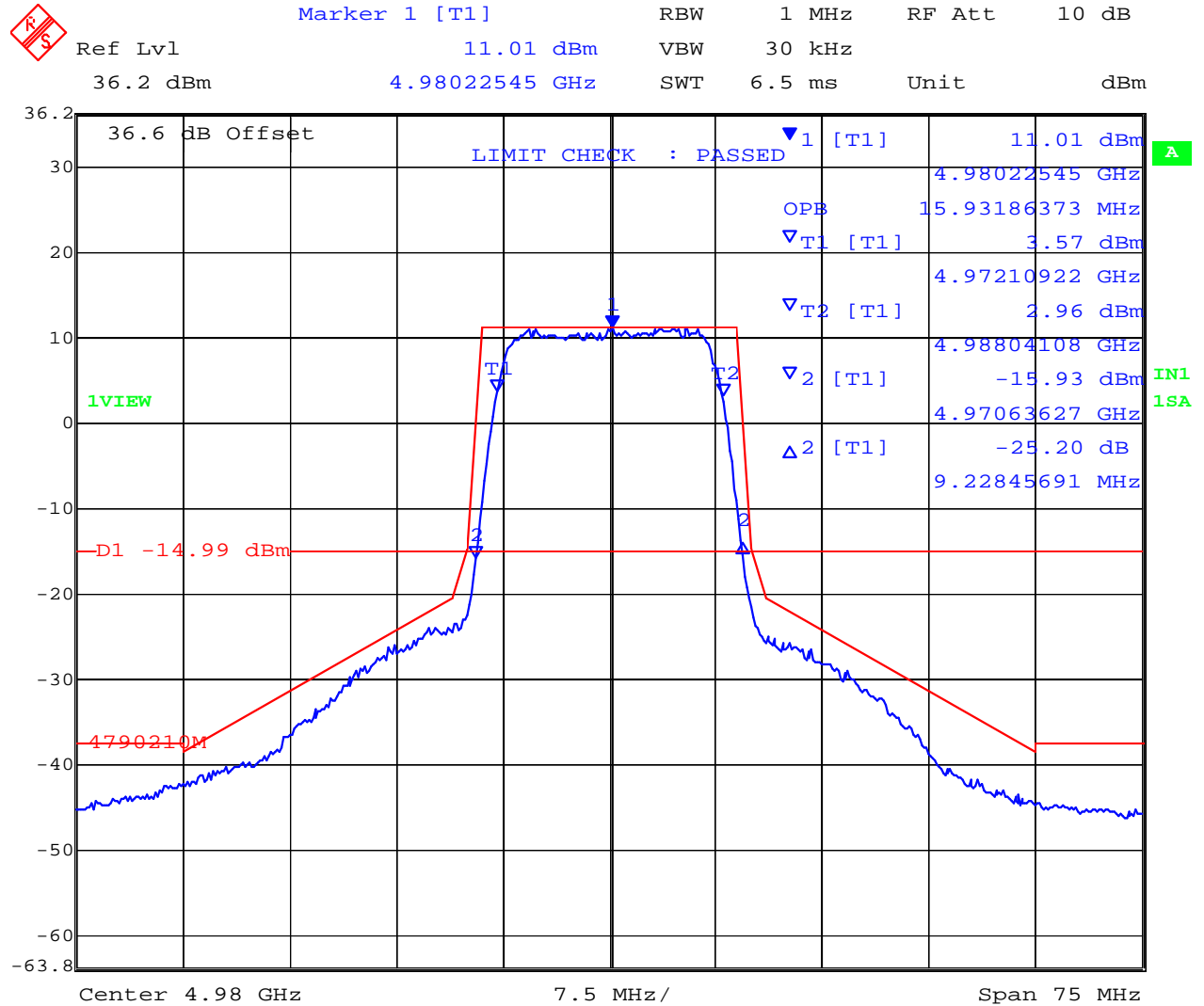

Date: 31.DEC.2006 13:25:13

PLOT - 26 dB & 99% Bandwidths 20 MHz 64QAM Channel Frequency 4980 MHz

This test report may be reproduced in full only. The document may only be updated by MiCOM Labs personnel. Any changes will be noted in the Document History section of the report.



Specification Limits
FCC Part §90.210

Limits for Authorized Bandwidth

Frequency Band (MHz) and Related Documents	Spectrum Masks with Audio Filter	Without Audio Filter
4950 – 4990 MHz	L or M	L or M

Reference to the emission masks are provided below

Limits Emission Masks

90.210(L), Emission Mask L. For low power transmitters (20 dBm or less) operating in the 4940 – 4990 MHz frequency band, the power spectral density of the emissions must be attenuated below the output power of the transmitter as follows:

- (1) On any frequency removed from the assigned frequency between 0 – 45% of the authorized bandwidth (BW) : 0dB.
- (2) On any frequency removed from the assigned frequency between 45 – 50 % of the authorized bandwidth: $219 \log (\% \text{ of } (BW)/45)$ dB.
- (3) On any frequency removed from the assigned frequency between 50 – 55 % of the authorized bandwidth: $10 + 242 \log (\% \text{ of } (BW)/50)$ dB.
- (4) On any frequency removed from the assigned frequency between 55 – 100 % of the authorized bandwidth: $20 + 31 \log (\% \text{ of } (BW)/55)$ dB attenuation.
- (5) On any frequency removed from the assigned frequency between 100 – 150 % of the authorized bandwidth: $28 + 68 \log (\% \text{ of } (BW)/100)$ dB attenuation.
- (6) On any frequency removed from the assigned frequency above 150 % of the authorized bandwidth: 50 dB.
- (7) The zero dB reference is measured relative to the highest average power of the fundamental emission measured across the designated channel bandwidth using a resolution bandwidth of at least one percent of the occupied bandwidth of the fundamental emission and a video bandwidth of 30 kHz. The power spectral density is the power measured within the resolution bandwidth of the measurement device divided by the resolution bandwidth of the measurement device. Emission levels are also based on the use of measurement instrumentation employing a resolution bandwidth of at least one percent of the occupied bandwidth.

This test report may be reproduced in full only. The document may only be updated by MiCOM Labs personnel. Any changes will be noted in the Document History section of the report.



Limits Emission Masks (continued)

90.210(m), Emission Mask M. For high power transmitters (greater than 20 dBm) operating in the 4940 – 4900 MHz frequency band, the power spectral density of the emissions must be attenuated below the output power of the transmitter as follows:

- (1) On any frequency removed from the assigned frequency between 0 – 45% of the authorized bandwidth (BW) : 0dB.
- (2) On any frequency removed from the assigned frequency between 45 – 50 % of the authorized bandwidth: $568 \log (\% \text{ of } (BW)/45)$ dB.
- (3) On any frequency removed from the assigned frequency between 50 – 55 % of the authorized bandwidth: $26 + 145 \log (\% \text{ of } (BW)/50)$ dB.
- (4) On any frequency removed from the assigned frequency between 55 – 100 % of the authorized bandwidth: $32 + 31 \log (\% \text{ of } (BW)/55)$ dB attenuation.
- (5) On any frequency removed from the assigned frequency between 100 – 150 % of the authorized bandwidth: $40 + 57 \log (\% \text{ of } (BW)/100)$ dB attenuation.
- (6) On any frequency removed from the assigned frequency between above 150 % of the authorized bandwidth: 50 dB or $55 + 10 \log (P)$ dB, whichever is the lesser attenuation.
- (7) The zero dB reference is measured relative to the highest average power of the fundamental emission measured across the designated channel bandwidth using a resolution bandwidth of at least one percent of the occupied bandwidth of the fundamental emission and a video bandwidth of 30 kHz. The power spectral density is the power measured within the resolution bandwidth of the measurement device divided by the resolution bandwidth of the measurement device. Emission levels are also based on the use of measurement instrumentation employing a resolution bandwidth of at least one percent of the occupied bandwidth.

Note to paragraph m: Low power devices may as an option, comply with paragraph (m).

Laboratory Measurement Uncertainty for Power Measurements

Measurement uncertainty	± 1.33 dB
-------------------------	---------------

Traceability

Method	Test Equipment Used
Measurements were made per work instruction WI-03 'Measurement of RF Spectrum Mask'	0070, 0116, 0158, 0193, 0252, 0313, 0314.

This test report may be reproduced in full only. The document may only be updated by MiCOM Labs personnel. Any changes will be noted in the Document History section of the report.

5.1.2. Peak Output Power

FCC 47 CFR Part 90, Subpart Y; 2.1046; §90.1215
Industry Canada RSS-111 §4.3

Test Procedure

Average power measurements were measured with the use of an average power head. Peak power measurements were recorded via the spectrum analyzer. The system highest power setting was selected with modulation ON and duty cycle set for 100% i.e. continuous operation at all times.

The 26 dB emission bandwidth (see Section 5.1.1) was used by the spectrum analyzer to measure peak output power.

Test Measurement Set up

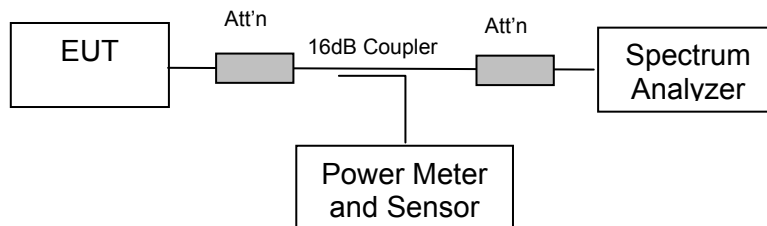

Test set up for Peak and Average Output Power

Ambient conditions.

Temperature: 19 to 26 °C

Relative humidity: 31 to 57 %

Pressure: 999 to 1009 mbar



Title: EX-4.9i Microwave Fixed Link
To: FCC Part 90 Subpart Y & IC RSS-111
Serial #: EXLT13-A1 Rev A
Issue Date: 12th February 2007
Page: 43 of 102

QPSK Modulation

Modulation	Bandwidth (MHz)	Center Frequency (MHz)	Average Power (dBm)	Peak Power (dBm)
QPSK	10	4945	+23.17	+30.26
		4965	+23.20	+30.22
		4985	+22.87	+30.01
	20	4950	+24.20	+31.94
		4965	+24.20	+31.87
		4980	+24.20	+31.92

This test report may be reproduced in full only. The document may only be updated by MiCOM Labs personnel. Any changes will be noted in the Document History section of the report.

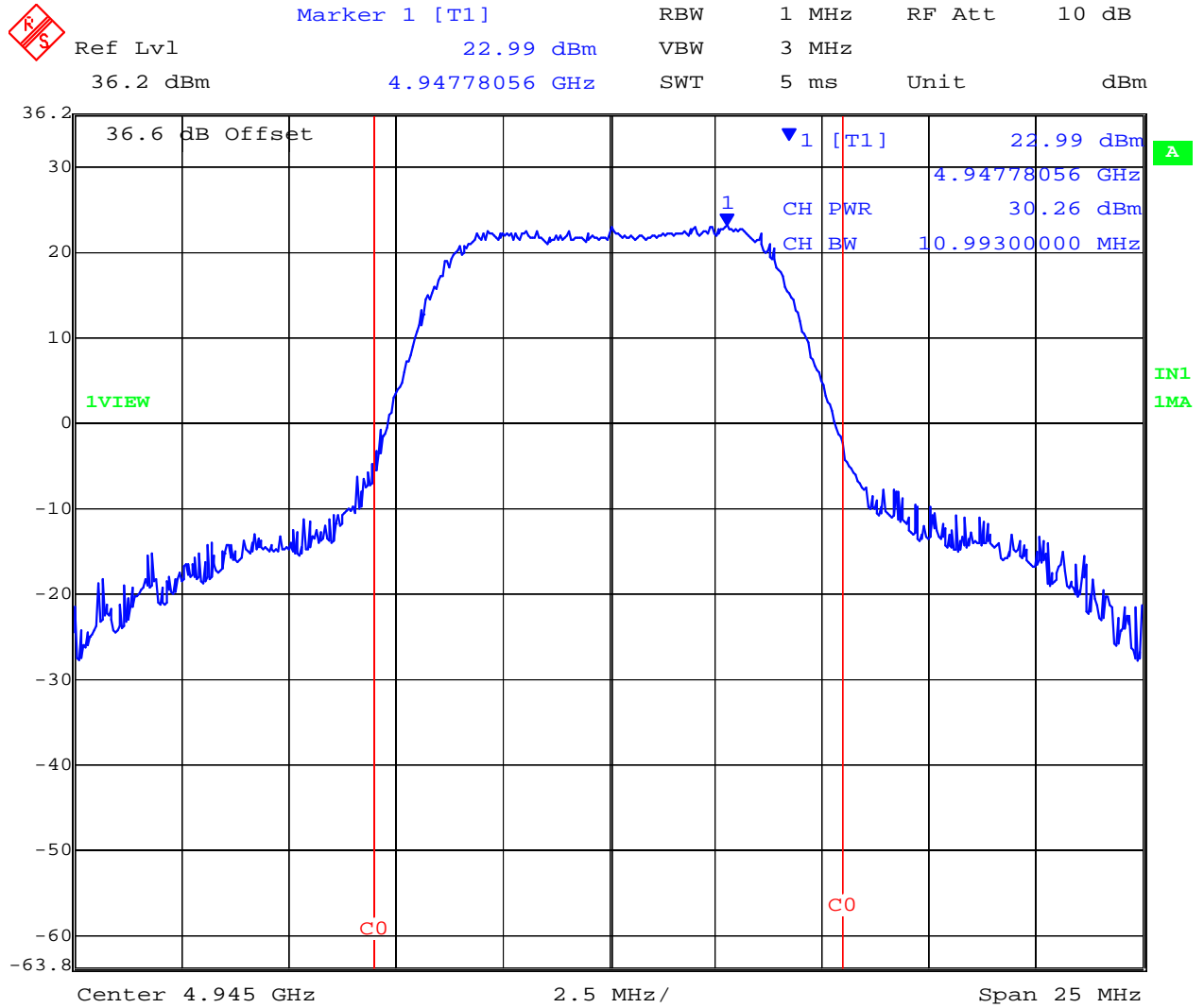

Date: 31.DEC.2006 15:02:17

PLOT-Max Peak Power 10 MHz QPSK Channel Frequency 4945 MHz (+30.26 dBm)

This test report may be reproduced in full only. The document may only be updated by MiCOM Labs personnel. Any changes will be noted in the Document History section of the report.

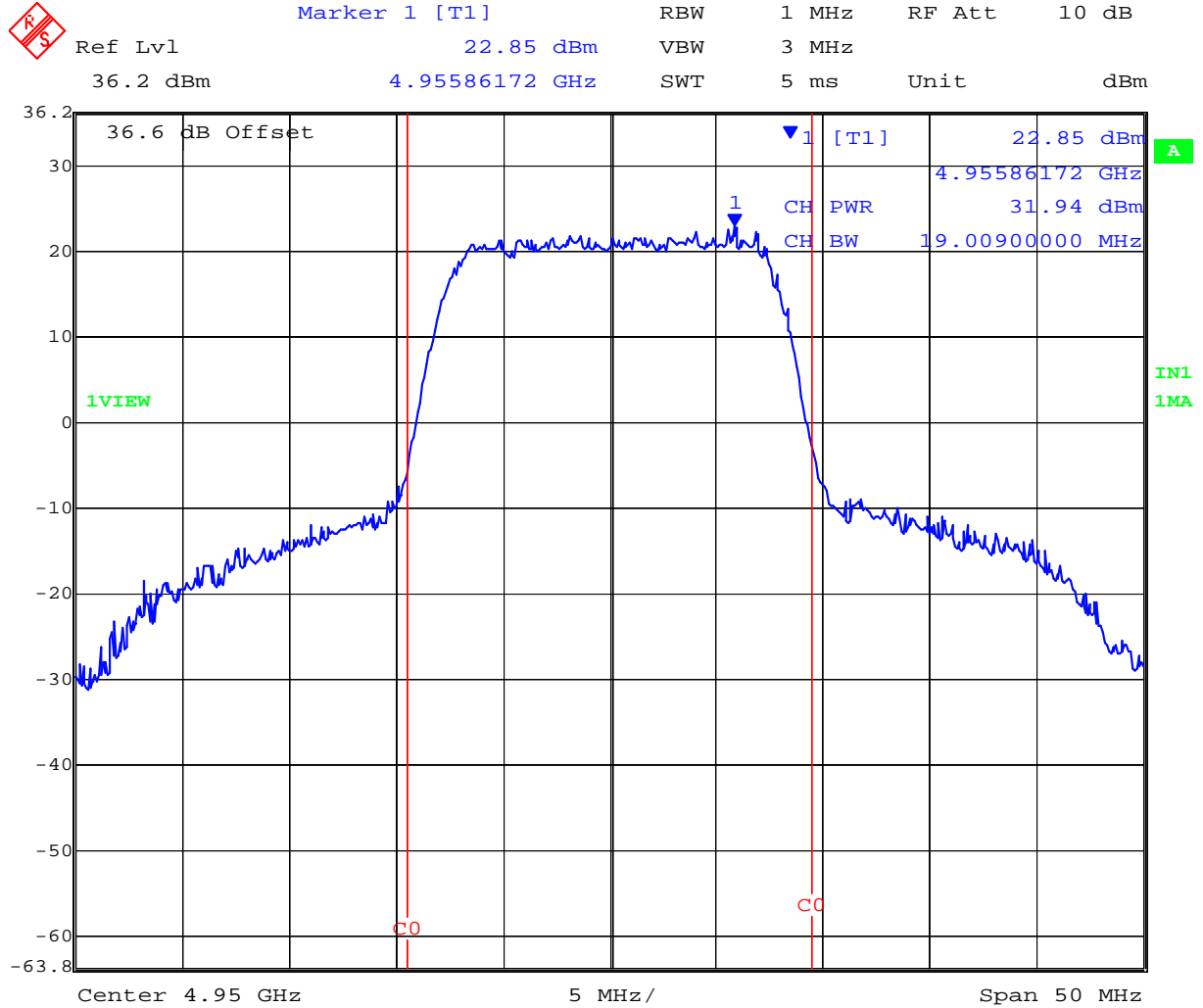

Date: 31.DEC.2006 14:49:57

PLOT-Max Peak Power 20 MHz QPSK Channel Frequency 4950 MHz (+31.94 dBm)

This test report may be reproduced in full only. The document may only be updated by MiCOM Labs personnel. Any changes will be noted in the Document History section of the report.



Title: EX-4.9i Microwave Fixed Link
To: FCC Part 90 Subpart Y & IC RSS-111
Serial #: EXLT13-A1 Rev A
Issue Date: 12th February 2007
Page: 46 of 102

16QAM Modulation

Modulation	Bandwidth (MHz)	Center Frequency (MHz)	Average Power (dBm)	Peak Power (dBm)
16QAM	10	4945	+22.79	+30.35
		4965	+22.83	+30.48
		4985	+22.67	+30.40
	20	4950	+24.25	+31.91
		4965	+24.23	+31.97
		4980	+24.24	+31.87

This test report may be reproduced in full only. The document may only be updated by MiCOM Labs personnel. Any changes will be noted in the Document History section of the report.

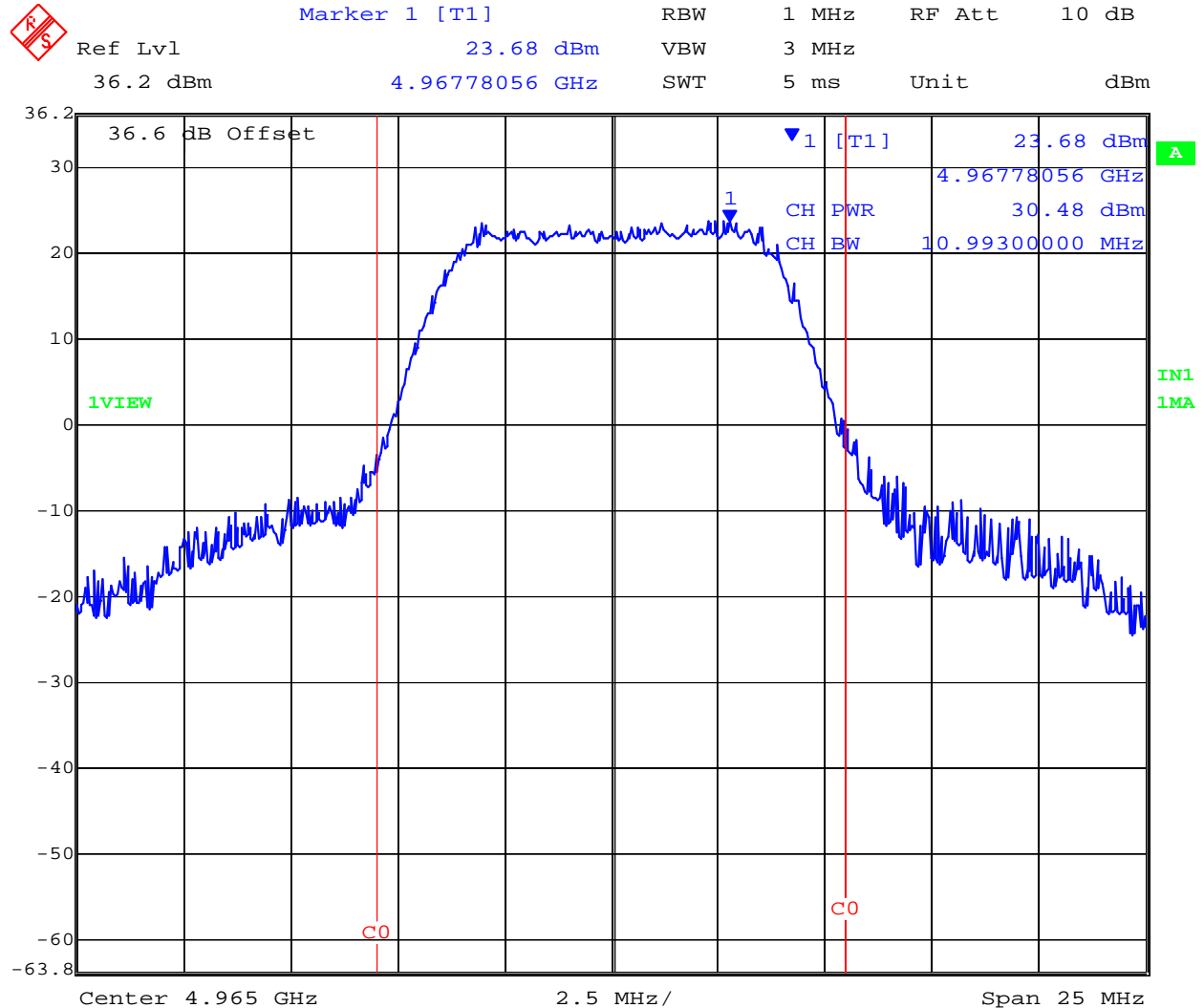

Date: 31.DEC.2006 15:06:55

PLOT—Max Peak Power 10MHz 16QAM Channel Frequency 4965 MHz (+30.48 dBm)

This test report may be reproduced in full only. The document may only be updated by MiCOM Labs personnel. Any changes will be noted in the Document History section of the report.

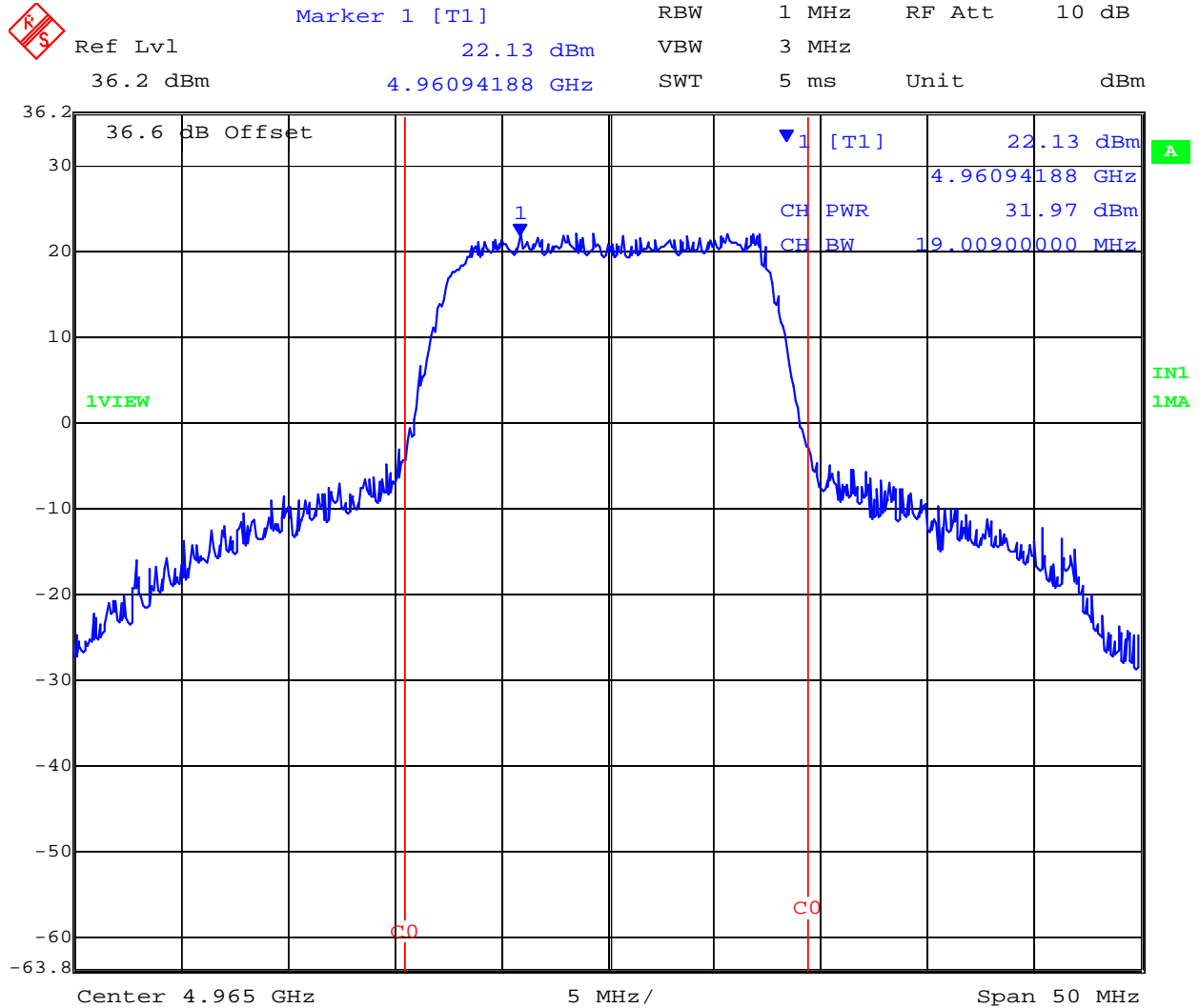

Date: 31.DEC.2006 14:56:47

PLOT—Max Peak Power 20MHz 16QAM Channel Frequency 4965 MHz (+31.97 dBm)

This test report may be reproduced in full only. The document may only be updated by MiCOM Labs personnel. Any changes will be noted in the Document History section of the report.



Title: EX-4.9i Microwave Fixed Link
To: FCC Part 90 Subpart Y & IC RSS-111
Serial #: EXLT13-A1 Rev A
Issue Date: 12th February 2007
Page: 49 of 102

64QAM Modulation

Modulation	Bandwidth (MHz)	Center Frequency (MHz)	Average Power (dBm)	Peak Power (dBm)
64QAM	10	4945	+22.99	+30.44
		4965	+22.46	+30.28
		4985	+22.13	+30.12
	20	4950	+23.77	+31.85
		4965	+24.01	+31.96
		4980	+23.79	+31.99

This test report may be reproduced in full only. The document may only be updated by MiCOM Labs personnel. Any changes will be noted in the Document History section of the report.

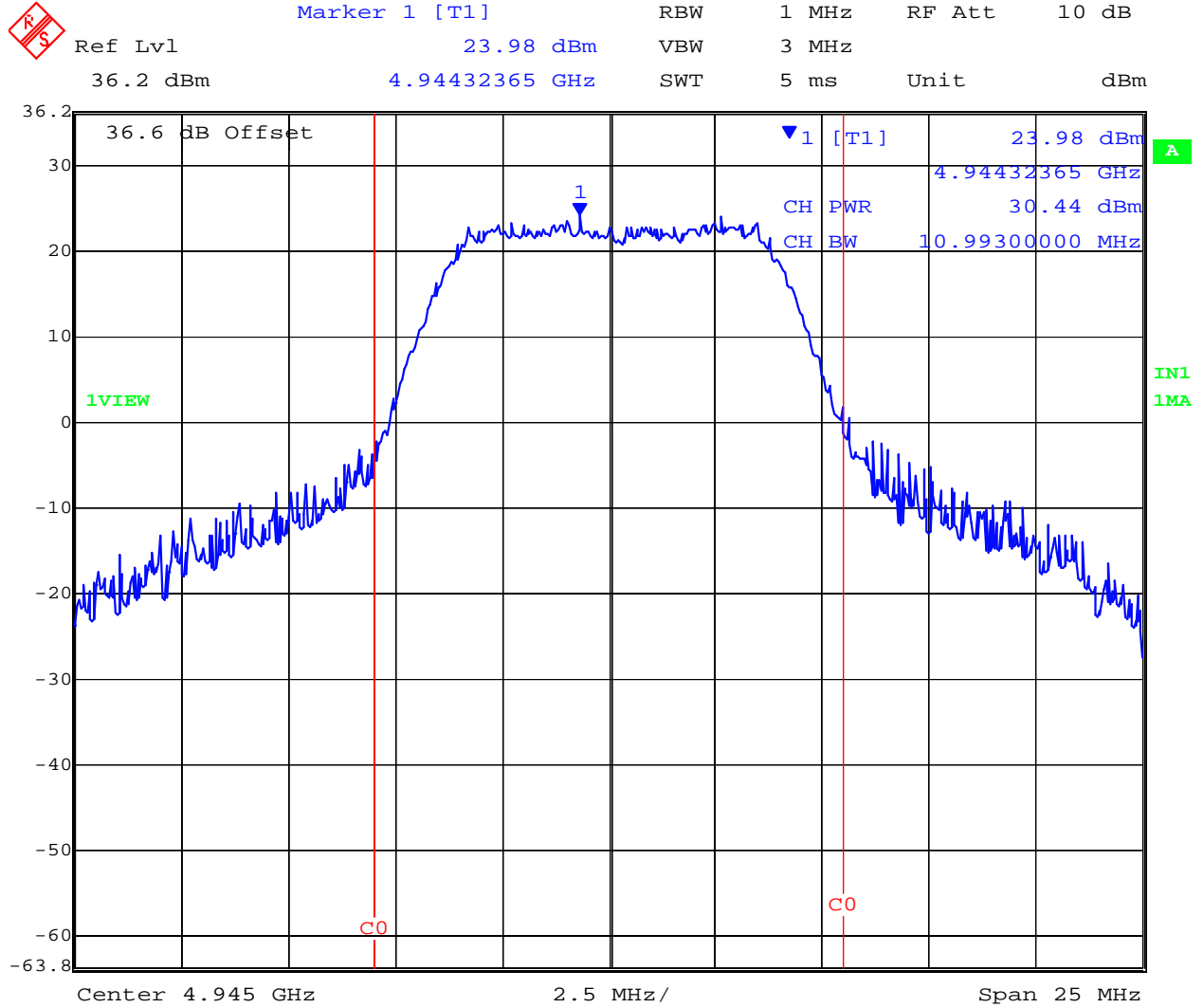

Date: 31.DEC.2006 15:08:20

PLOT—Max Peak Power 10MHz 64QAM Channel Frequency 4945 MHz (+30.44 dBm)

This test report may be reproduced in full only. The document may only be updated by MiCOM Labs personnel. Any changes will be noted in the Document History section of the report.

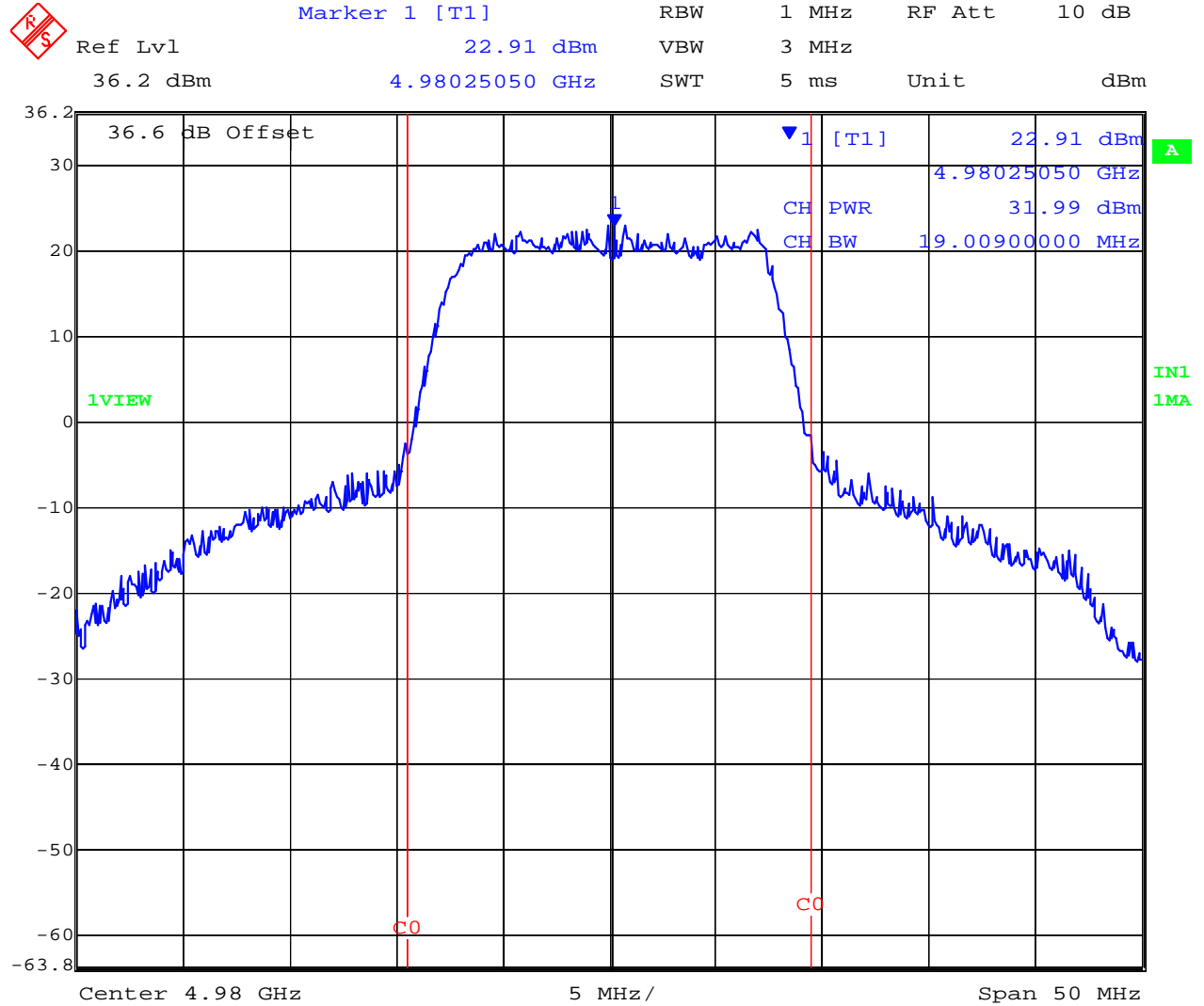

Date: 31.DEC.2006 14:58:25

PLOT—Max Peak Power 20MHz 64QAM Channel Frequency 4980 MHz (+31.99 dBm)

This test report may be reproduced in full only. The document may only be updated by MiCOM Labs personnel. Any changes will be noted in the Document History section of the report.



Specification Limits

FCC Part §90.1215(a)

Power limits.

The transmitting power of stations operating in the 4940-4990 MHz band must not exceed the maximum limits in this section.

(a) The peak transmit power should not exceed:

Channel Bandwidth (MHz)	Low power peak transmitter power (dBm)	High power peak transmitter power (dBm)
1	7	20
5	14	27
10	17	30
15	18.8	31.8
20	20	33

High power devices are also limited to a peak power spectral density of 21 dBm per one MHz. High power devices using channel bandwidths other than those listed above are permitted; however, they are limited to a peak power spectral density of 21 dBm/MHz. If transmitting antennas of directional gain greater than 9 dBi are used, both the peak transmit power and the peak power spectral density should be reduced by the amount in decibels that the directional gain of the antenna exceeds 9 dBi. However, high power point-to-point or point-to-multipoint operation (both fixed and temporary-fixed rapid deployment) may employ transmitting antennas with directional gain up to 26 dBi without any corresponding reduction in the transmitter power or spectral density. Corresponding reduction in the peak transmit power and peak power spectral density should be the amount in decibels that the directional gain of the antenna exceeds 26 dBi.

(b) Low power devices are also limited to a peak power spectral density of 8 dBm per one MHz. Low power devices using channel bandwidths other than those listed above are permitted; however, they are limited to a peak power spectral density of 8 dBm/MHz. If transmitting antennas of directional gain greater than 9 dBi are used, both the peak transmit power and the peak power spectral density should be reduced by the amount in decibels that the directional gain of the antenna exceeds 9 dBi.

(c) The peak transmit power is measured as a conducted emission over any interval of continuous transmission calibrated in terms of an RMS-equivalent voltage. If the device cannot be connected directly, alternative techniques acceptable to the Commission may be used. The measurement results shall be properly adjusted for any instrument limitations, such as detector response times, limited resolution bandwidth capability when compared to the emission bandwidth, sensitivity, etc., so as to obtain a true peak measurement conforming to the definitions in this paragraph for the emission in question.

(d) The peak power spectral density is measured as conducted emission by direct connection of a calibrated test instrument to the equipment under test. If the device cannot be connected



Title: EX-4.9i Microwave Fixed Link
To: FCC Part 90 Subpart Y & IC RSS-111
Serial #: EXLT13-A1 Rev A
Issue Date: 12th February 2007
Page: 53 of 102

directly, alternative techniques acceptable to the Commission may be used. Measurements are made over a bandwidth of one MHz or the 26 dB emission bandwidth of the device, whichever is less. A resolution bandwidth less than the measurement bandwidth can be used, provided that the measured power is integrated to show total power over the measurement bandwidth. If the resolution bandwidth is approximately equal to the measurement bandwidth, and much less than the emission bandwidth of the equipment under test, the measured results shall be corrected to account for any difference between the resolution bandwidth of the test instrument and its actual noise bandwidth.

Laboratory Measurement Uncertainty for Power Measurement

Measurement uncertainty	± 1.33 dB
-------------------------	---------------

Traceability

Method	Test Equipment Used
Measurements were made per work instruction WI-03 'Measurement of RF Output Power'	0070, 0116, 0158, 0193, 0252, 0313, 0314.

This test report may be reproduced in full only. The document may only be updated by MiCOM Labs personnel. Any changes will be noted in the Document History section of the report.

5.1.3. Peak Power Spectral Density (PPSD)

FCC 47 CFR Part 90, Subpart Y; 2.1046; §90.1215
Industry Canada RSS-111 §4.3

Test Procedure

The test methodology used for this measurement was determined to provide the highest possible PPSD readings.

Peak power spectral density measurements were performed via the spectrum analyzer and plots were recorded. Modulation was ON and the system duty cycle was set for 100% i.e. continuous operation at all times. The system highest power setting was selected with modulation ON and duty cycle set for 100% i.e. continuous operation at all times.

Test Measurement Set up

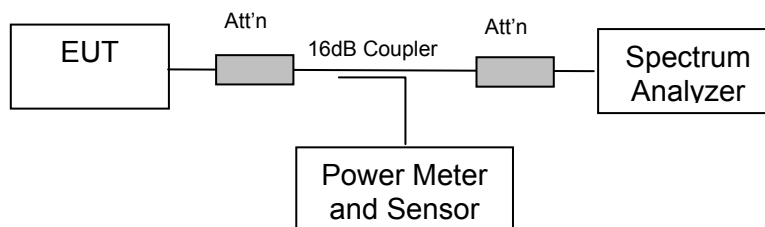

Test set up for Peak Power Spectral Density measurement(s)

Ambient conditions.

Temperature: 19 to 26 °C

Relative humidity: 31 to 57 %

Pressure: 999 to 1009 mbar



Title: EX-4.9i Microwave Fixed Link
To: FCC Part 90 Subpart Y & IC RSS-111
Serial #: EXLT13-A1 Rev A
Issue Date: 12th February 2007
Page: 55 of 102

QPSK Modulation

Modulation	Bandwidth (MHz)	Center Frequency (MHz)	PPSD Maximum Frequency (MHz)	PPSD (dBm)
QPSK	10	4945	4947.30461	+20.95
		4965	4967.30461	+20.93
		4985	4983.01603	+20.75
	20	4950	4955.63126	+19.99
		4965	4971.03206	+19.55
		4980	4979.53908	+19.64

This test report may be reproduced in full only. The document may only be updated by MiCOM Labs personnel. Any changes will be noted in the Document History section of the report.

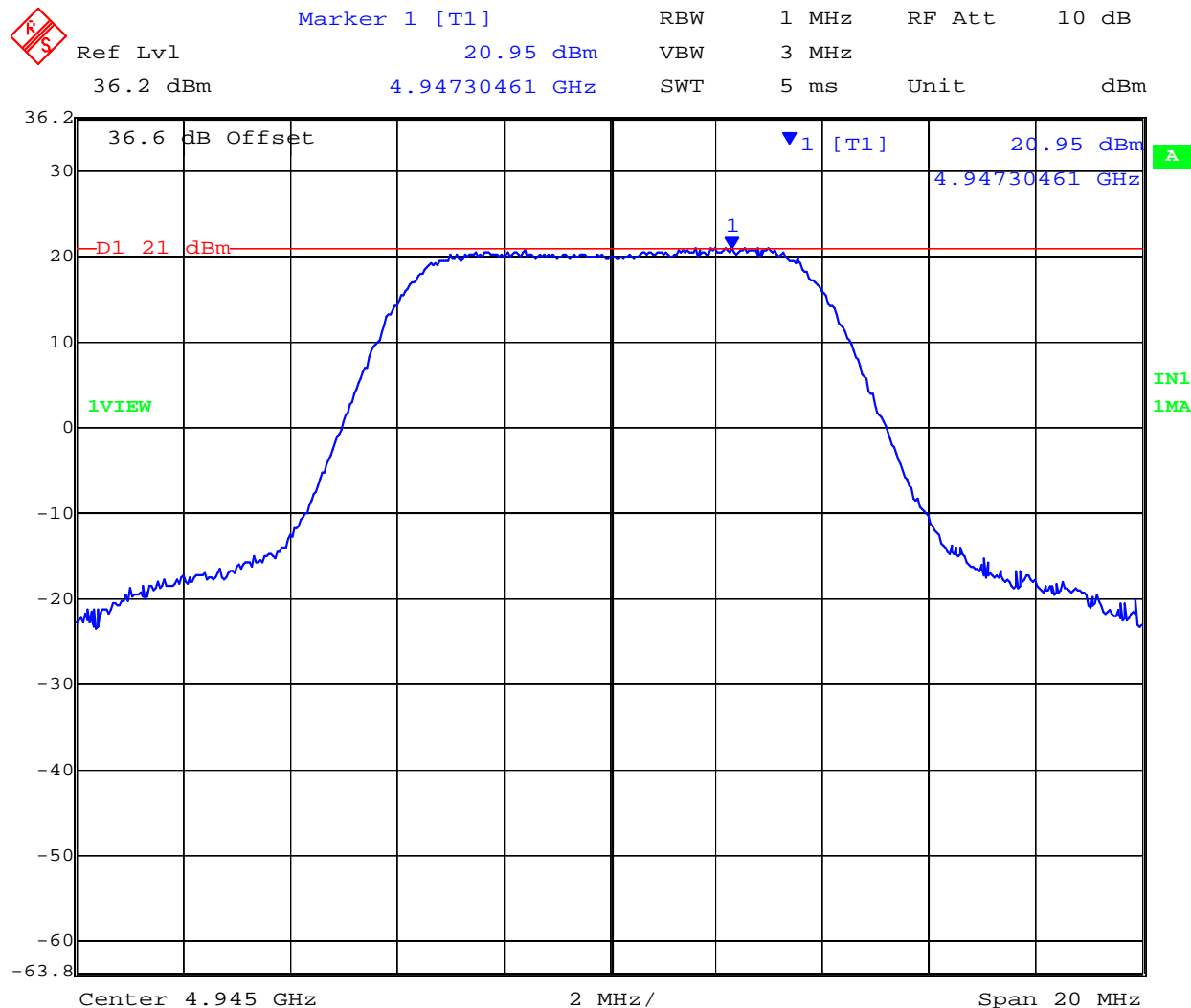

Date: 31.DEC.2006 13:38:26

PLOT-Max PPSD 10MHz QPSK Channel Frequency 4945 MHz (+20.95 dBm)

This test report may be reproduced in full only. The document may only be updated by MiCOM Labs personnel. Any changes will be noted in the Document History section of the report.



 Marker 1 [T1] RBW 1 MHz RF Att 10 dB
Ref Lvl 19.99 dBm VBW 3 MHz
36.2 dBm 4.95563126 GHz SWT 5 ms Unit dBm

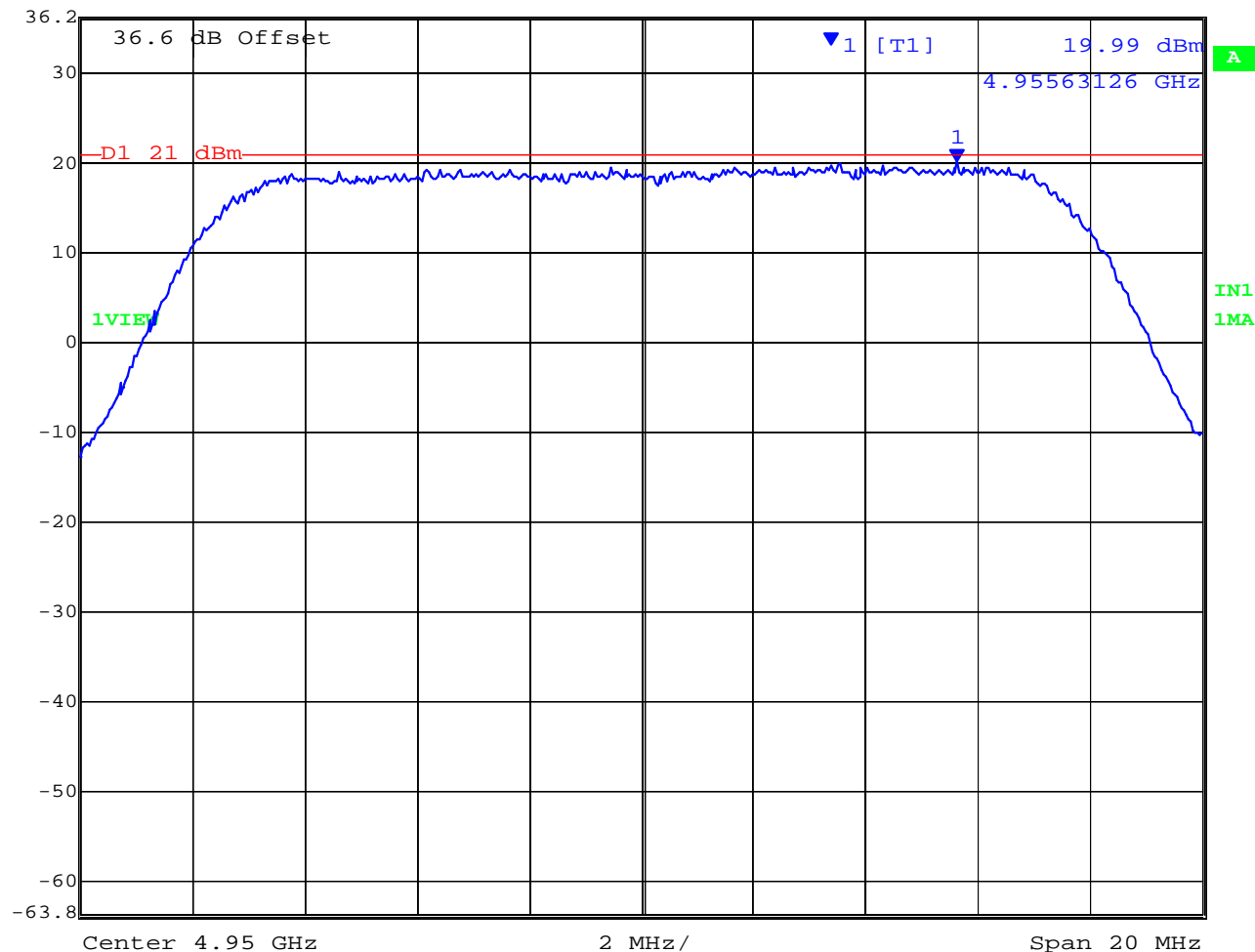

Date: 31.DEC.2006 13:43:08

PLOT-Max PPSD 20MHz QPSK Channel Frequency 4950 MHz (+19.99 dBm)

This test report may be reproduced in full only. The document may only be updated by MiCOM Labs personnel. Any changes will be noted in the Document History section of the report.



Title: EX-4.9i Microwave Fixed Link
To: FCC Part 90 Subpart Y & IC RSS-111
Serial #: EXLT13-A1 Rev A
Issue Date: 12th February 2007
Page: 58 of 102

16QAM Modulation

Modulation	Bandwidth (MHz)	Center Frequency (MHz)	PPSD Maximum Frequency (MHz)	PPSD (dBm)
16QAM	10	4945	4947.46493	+20.73
		4965	4966.54309	+20.62
		4985	4987.02405	+20.98
	20	4950	4954.98998	+19.76
		4965	4971.27255	+19.82
		4980	4983.30661	+19.53

This test report may be reproduced in full only. The document may only be updated by MiCOM Labs personnel. Any changes will be noted in the Document History section of the report.



 Marker 1 [T1] RBW 1 MHz RF Att 10 dB
Ref Lvl 20.98 dBm VBW 3 MHz
36.2 dBm 4.98702405 GHz SWT 5 ms Unit dBm

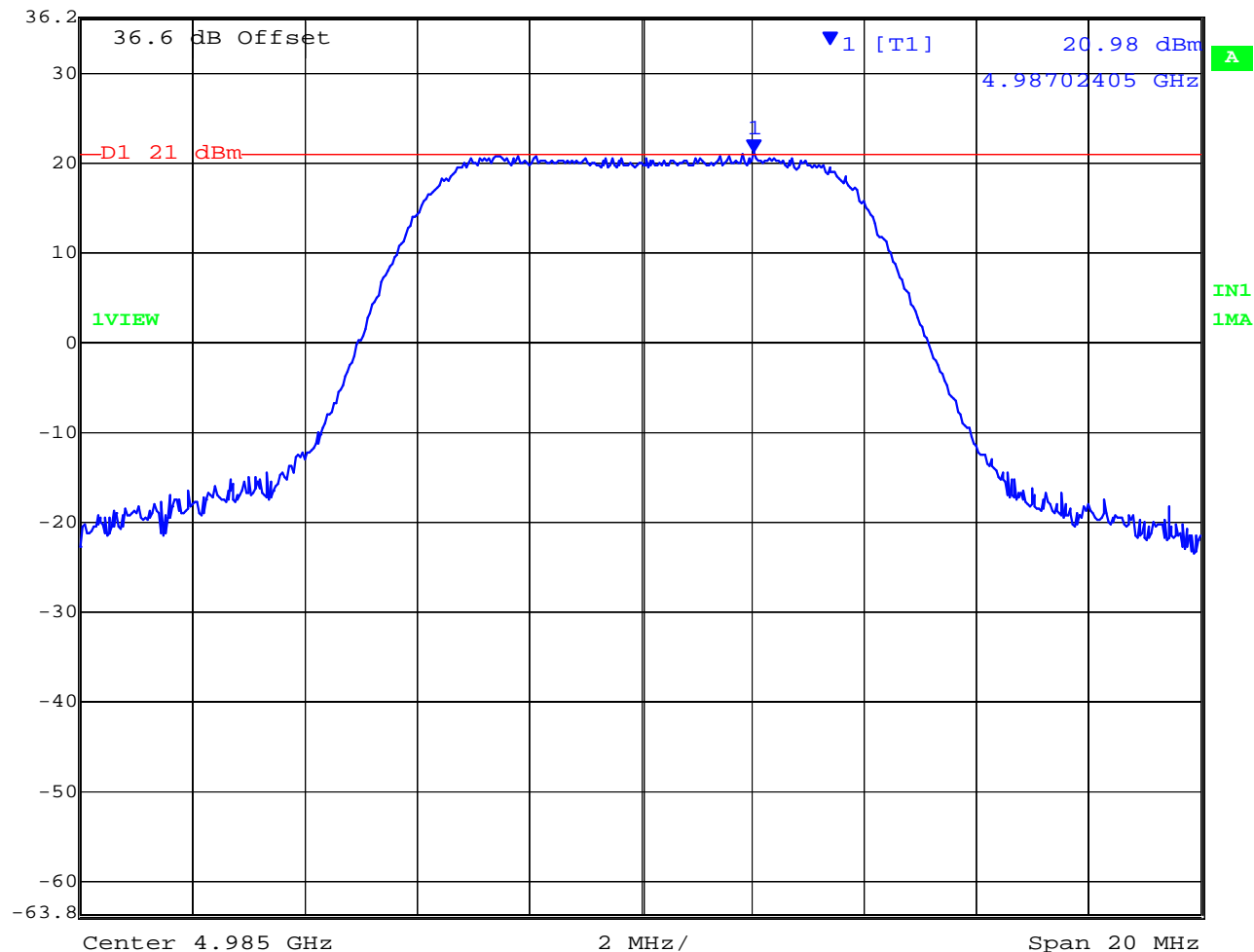

Date: 31.DEC.2006 13:51:22

PLOT-Max PPSD 10MHz 16QAM Channel Frequency 4985 MHz (+20.98 dBm)

This test report may be reproduced in full only. The document may only be updated by MiCOM Labs personnel. Any changes will be noted in the Document History section of the report.

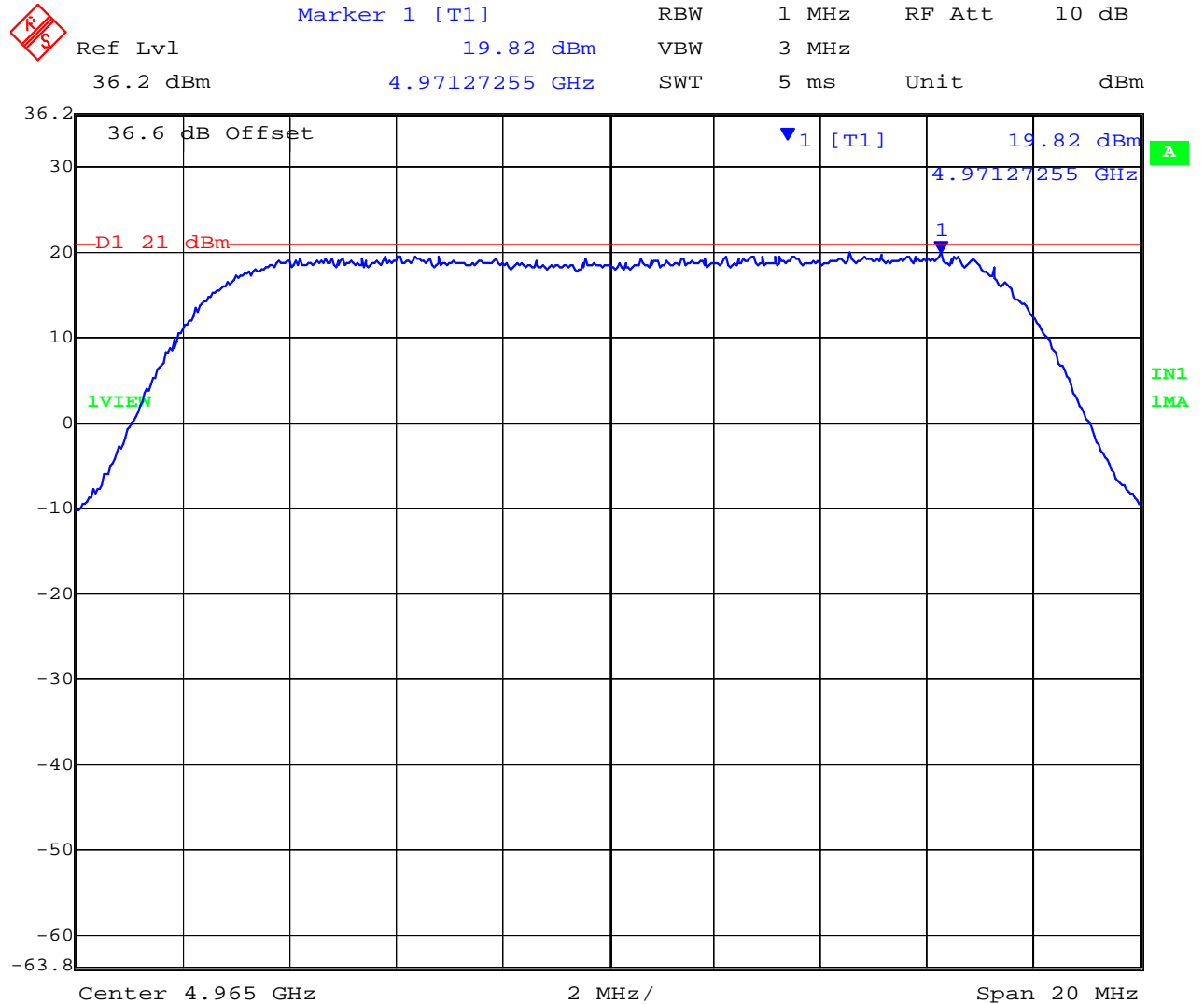

Date: 31.DEC.2006 13:53:58

PLOT-Max PPSD 20MHz 16QAM Channel Frequency 4965 MHz (+19.82 dBm)

This test report may be reproduced in full only. The document may only be updated by MiCOM Labs personnel. Any changes will be noted in the Document History section of the report.



Title: EX-4.9i Microwave Fixed Link
To: FCC Part 90 Subpart Y & IC RSS-111
Serial #: EXLT13-A1 Rev A
Issue Date: 12th February 2007
Page: 61 of 102

64QAM Modulation

Modulation	Bandwidth (MHz)	Center Frequency (MHz)	PPSD Maximum Frequency (MHz)	PPSD (dBm)
64QAM	10	4945	4947.70541	+20.99
		4965	4963.45691	+20.66
		4985	4982.65531	+20.26
	20	4950	4956.91383	+19.54
		4965	4960.85170	+19.64
		4980	4975.89178	+19.24

This test report may be reproduced in full only. The document may only be updated by MiCOM Labs personnel. Any changes will be noted in the Document History section of the report.

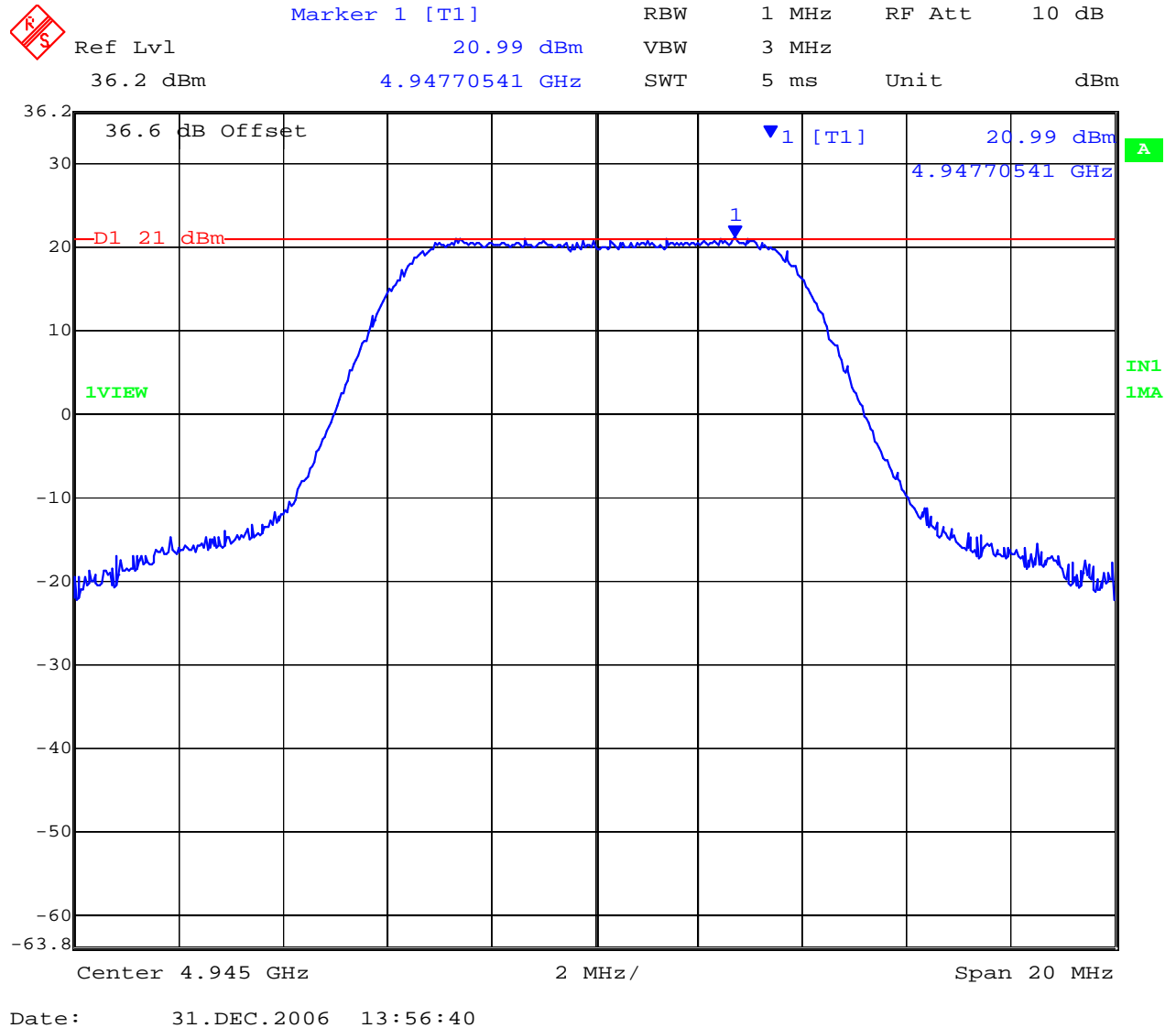

PLOT-Max PPSD 10MHz 64QAM Channel Frequency 4945 MHz (+20.99 dBm)

This test report may be reproduced in full only. The document may only be updated by MiCOM Labs personnel. Any changes will be noted in the Document History section of the report.

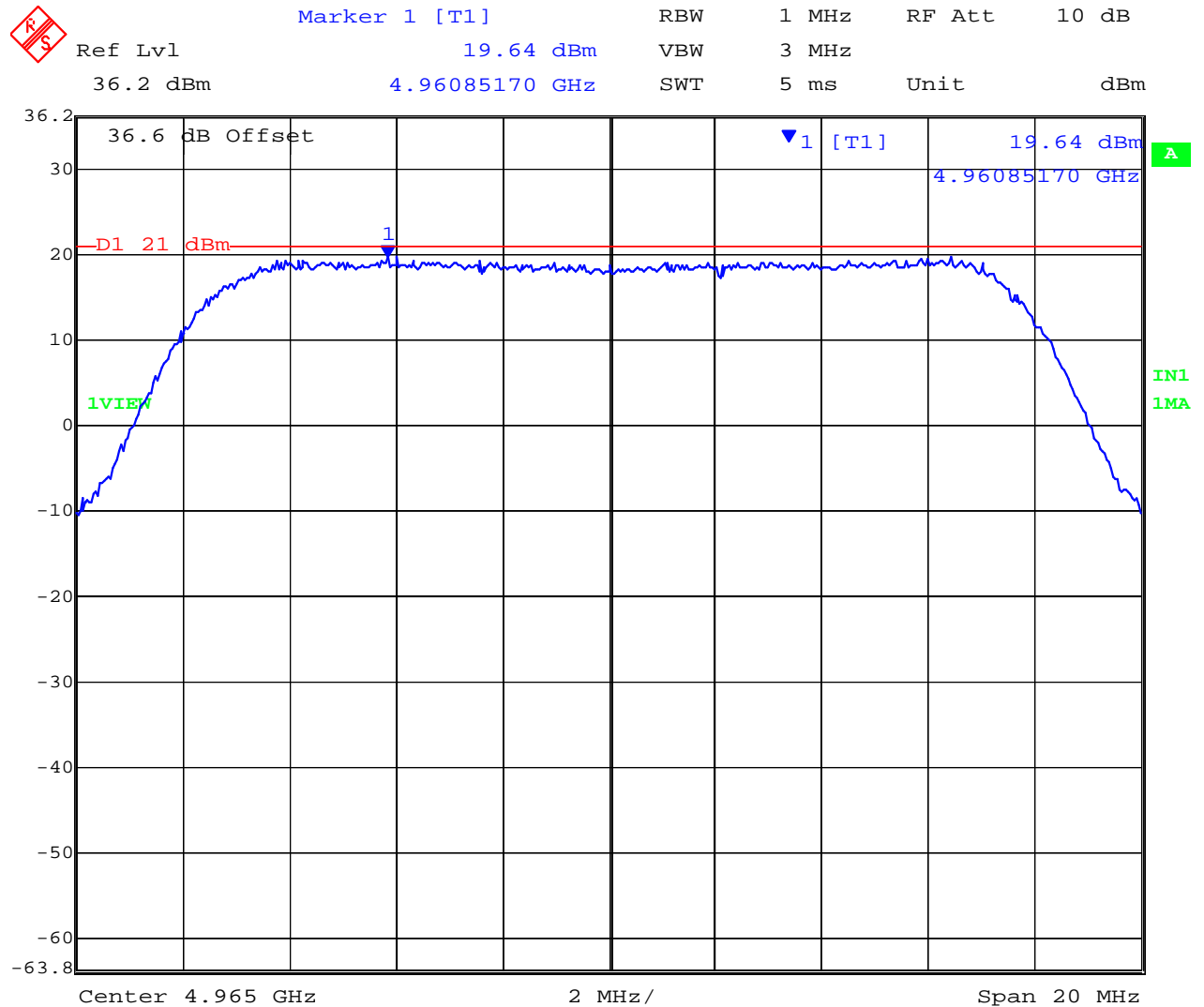

Date: 31.DEC.2006 14:03:23

PLOT-Max PPSD 20MHz 64QAM Channel Frequency 4965 MHz (+19.64 dBm)

This test report may be reproduced in full only. The document may only be updated by MiCOM Labs personnel. Any changes will be noted in the Document History section of the report.



Title: EX-4.9i Microwave Fixed Link
To: FCC Part 90 Subpart Y & IC RSS-111
Serial #: EXLT13-A1 Rev A
Issue Date: 12th February 2007
Page: 64 of 102

Specification Limits
FCC Part §90.1215

Refer to the Power Limits Specification in Section 5.1.2 of this report.

Laboratory Measurement Uncertainty for Power Measurement

Measurement uncertainty	± 1.33 dB
-------------------------	---------------

Traceability

Method	Test Equipment Used
Measurements were made per work instruction WI-03 'Measurement of RF Output Power'	0070, 0116, 0158, 0193, 0252, 0313, 0314.

This test report may be reproduced in full only. The document may only be updated by MiCOM Labs personnel. Any changes will be noted in the Document History section of the report.



5.1.4. Maximum Permissible Exposure
FCC, Part 90 Subpart C §90.1217

Calculations for Maximum Permissible Exposure Levels

Power Density = Pd (mW/cm²) = EIRP/(4πd²)

EIRP = P * G

P = Peak output power (mW)

G = Antenna numeric gain (numeric)

d = Separation distance (cm)

Numeric Gain = 10 ^ (G (dBi)/10)

Max Antenna Gain (dBi)	Max Power (dBm)	Reduction in Power (dBm)	Peak Output Power Setting (dBm)
44.5	+31.99	44.5 – 26 = 18.5	+31.99 – 18.5 = +13.49

High power point-to-point or point-to-multipoint operation (both fixed and temporary-fixed rapid deployment) may employ transmitting antennas with directional gain up to 26 dBi without any corresponding reduction in the transmitter power or spectral density. Corresponding reduction in the peak transmit power and peak power spectral density should be the amount in decibels that the directional gain of the antenna exceeds 26 dBi. **Ref FCC Part §90.1215(a)**

4.9 GHz 64 QAM 20 MHz Channel Peak Output Pwr Setting = +13.49 dBm **numeric** 22.336
 Max. Antenna Gain = 44.5 dBi, **numeric** 28,183.83

The EUT belongs to the Occupational/Controlled Exposure class of devices; power density limit is 5.0mW/cm²

Maximum Gain Antenna – Calculated Safe Distance @ 5 mW/cm²

Antenna Gain (Numeric)	Peak Output Power (mW)	Calculated Safe Distance at 5 mW/cm ² (cm)	Limit (mW/cm ²)
28,183.83	22.336	100.09	5.0

Specification

Maximum Permissible Exposure Limits

§90.1217 Systems operating under the provisions of this section shall be operated in a manner that ensures that the public is not exposed to radio frequency levels in excess of the Commission’s guidelines. See §1.1307 (b)(1) of this chapter.

Limit = 5mW / cm² from 1.310 Table 1

Note: for mobile or fixed location transmitters the minimum separation distance is 20cm, even if calculations indicate the MPE distance to be less.

Laboratory Measurement Uncertainty for Power Measurements

Measurement uncertainty	±1.33dB
-------------------------	---------

This test report may be reproduced in full only. The document may only be updated by MiCOM Labs personnel. Any changes will be noted in the Document History section of the report.

5.1.5. Frequency Stability; Temperature Variations, and Voltage Variations

FCC 47 CFR Part 90, Subpart Y; 2.1055(a)(1); §90.213
Industry Canada RSS-111 §4.2

Test Procedure

The transmitter output was connected to a spectrum analyzer and the frequency stability was measured in a CW (continuous wave) operational mode. Frequency stability was measured through the extremes of temperature on the mid channel only. Before measurements were taken at each temperature the equipment waited until thermal balance was obtained.

Test Measurement Set up

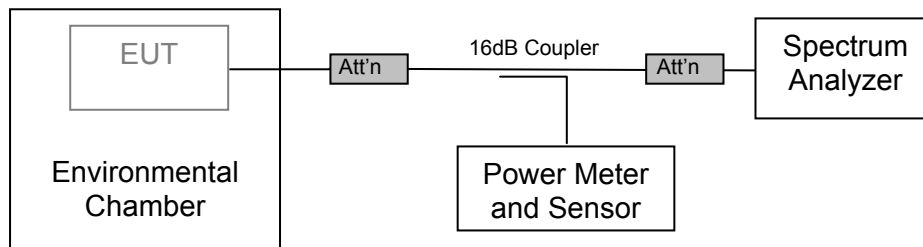

Measurement set up for Frequency Stability



Ambient conditions.

Temperature: 19 to 26 °C Relative humidity: 31 to 57 % Pressure: 999 to 1009 mbar

TABLE OF RESULTS Frequency Stability

Voltage	Temperature (°C)	FREQUENCY (MHz)
		Channel (CW) 4965 MHz
48 Vdc	-25	4965.01859
	-15	4965.01870
	-5	4965.01998
	+5	4965.03198
	+15	4965.02287
	+25	4965.02303
	+35	4965.02263
	+45	4965.02295
	+55	4965.02383
	+65	4965.02134
Maximum Frequency Drift with respect to the nominal frequency		+18.59kHz / +31.98kHz +3.74ppm / +6.44ppm

This test report may be reproduced in full only. The document may only be updated by MiCOM Labs personnel. Any changes will be noted in the Document History section of the report.



Title: EX-4.9i Microwave Fixed Link
To: FCC Part 90 Subpart Y & IC RSS-111
Serial #: EXLT13-A1 Rev A
Issue Date: 12th February 2007
Page: 68 of 102

TABLE OF RESULTS Frequency Stability;-

Voltage Variations at Ambient

Temperature	Voltage (Vac, 60 Hz)	FREQUENCY (MHz)
		Channel 4965 MHz
Ambient	+48.0	4965.02303
	+52.8	4965.02303
	+43.2	4965.02303
Maximum Frequency Drift		-0.00 / +0.00

Frequency stability did not change with voltage variation per the voltages identified in the above table.

This test report may be reproduced in full only. The document may only be updated by MiCOM Labs personnel. Any changes will be noted in the Document History section of the report.



Title: EX-4.9i Microwave Fixed Link
To: FCC Part 90 Subpart Y & IC RSS-111
Serial #: EXLT13-A1 Rev A
Issue Date: 12th February 2007
Page: 69 of 102

Manufacturers Specification for Frequency Stability

As no apparent frequency stability limits were provided the manufacturer's specification was used ± 20 ppm.

Laboratory Measurement Uncertainty for Frequency Stability

Measurement uncertainty	± 0.866 ppm
-------------------------	-----------------

Traceability

Method	Test Equipment Used
Measurements were made per work instruction WI-02 'Frequency Measurement'	0070, 0116, 0158, 0193, 0252, 0313, 0314.

This test report may be reproduced in full only. The document may only be updated by MiCOM Labs personnel. Any changes will be noted in the Document History section of the report.

5.1.6. Spurious Emissions at Antenna Terminals

FCC 47 CFR Part 90, Subpart Y; 2.1051; §90.210(m)
Industry Canada RSS-111 §4.4

5.1.6.1. Transmitter Conducted Spurious Emissions (30 M- 40 GHz)

Test Procedure

Transmitter conducted spurious emissions were measured for each bandwidth and modulation state. Measurement were made while EUT was operating in a modulated transmit mode of operation, at the appropriate center frequency, 100% duty cycle and maximum power at all times. Conducted spurious emissions were measured to 40 GHz.

Limits were calculated which depended on average transmit power level(s).

See test report Section 5.1.2 for average power level measurements

Highest power level: +24.25 dBm

Lowest Power Level: +22.13 dBm

Limit

From FCC Part 90.210 (m)

On any frequency removed from the assigned frequency between above 150 % of the authorized bandwidth: 50 dB or $55 + 10 \log (P)$ dB, whichever is the lesser attenuation.

Attenuation

$55 + 10 \log (P)$ dB for maximum power = 49.24 dB attenuation

$55 + 10 \log (P)$ dB for lowest power = 47.12 dB attenuation

Highest Power Limit: $+24.25 - 49.24 = -24.99$ dBm

Lowest Power Limit: $+22.13 - 47.12 = -24.99$ dBm

Test Measurement Set up

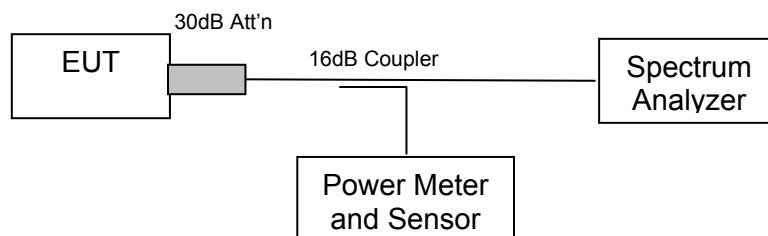

Conducted spurious emission test configuration

Ambient conditions.

Temperature: 19 to 26 °C

Relative humidity: 31 to 57 %

Pressure: 999 to 1009 mbar

This test report may be reproduced in full only. The document may only be updated by MiCOM Labs personnel. Any changes will be noted in the Document History section of the report.

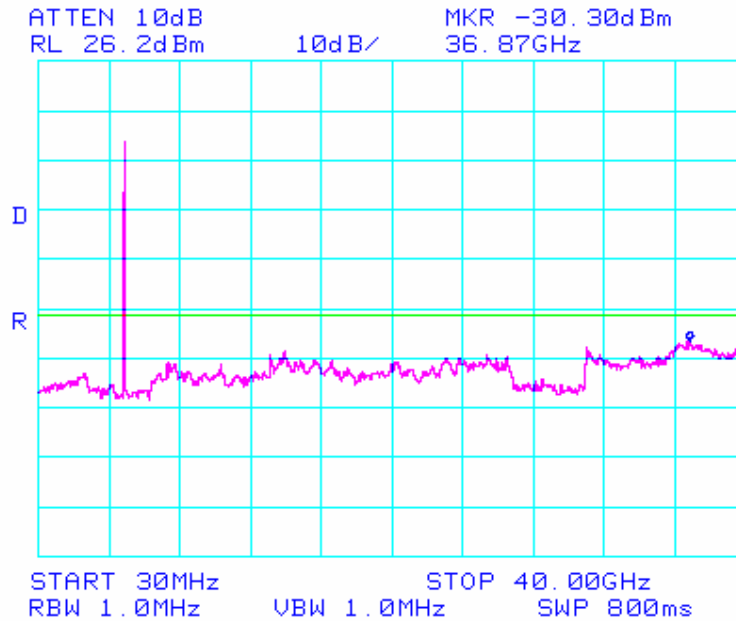

Spurious Emissions QPSK 10 MHz BW
4945 MHz 30 MHz – 40 GHz: Limit -25 dBm

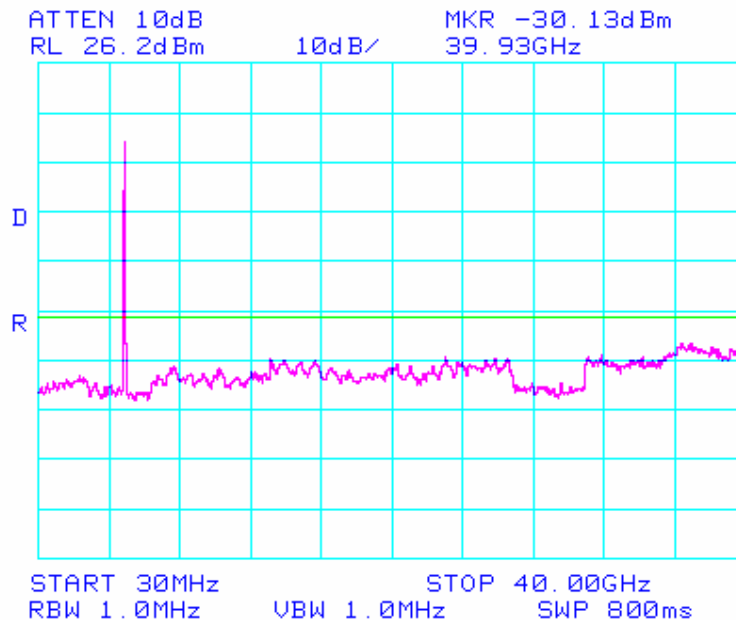

Spurious Emissions QPSK 10 MHz BW
4965 MHz 30 MHz – 40 GHz: Limit -25 dBm

This test report may be reproduced in full only. The document may only be updated by MiCOM Labs personnel. Any changes will be noted in the Document History section of the report.



Title: EX-4.9i Microwave Fixed Link
To: FCC Part 90 Subpart Y & IC RSS-111
Serial #: EXLT13-A1 Rev A
Issue Date: 12th February 2007
Page: 72 of 102

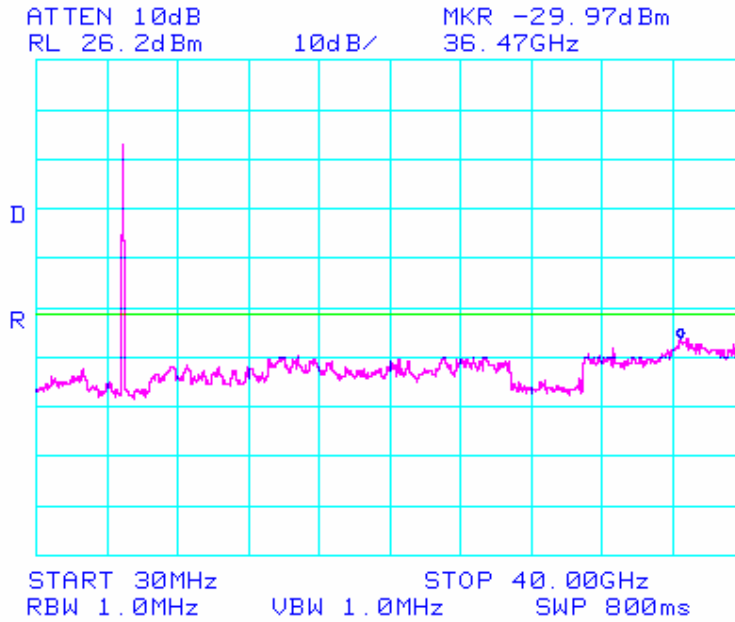

Spurious Emissions QPSK 10 MHz BW
4985 MHz 30 MHz – 40 GHz: Limit -25 dBm

This test report may be reproduced in full only. The document may only be updated by MiCOM Labs personnel. Any changes will be noted in the Document History section of the report.

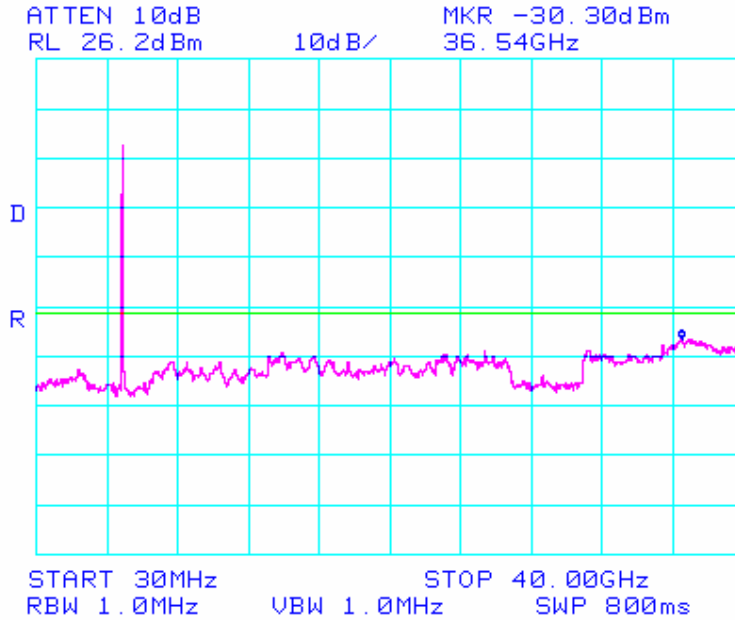

Spurious Emissions QPSK 20 MHz BW
4950 MHz 30 MHz – 40 GHz: Limit -25 dBm

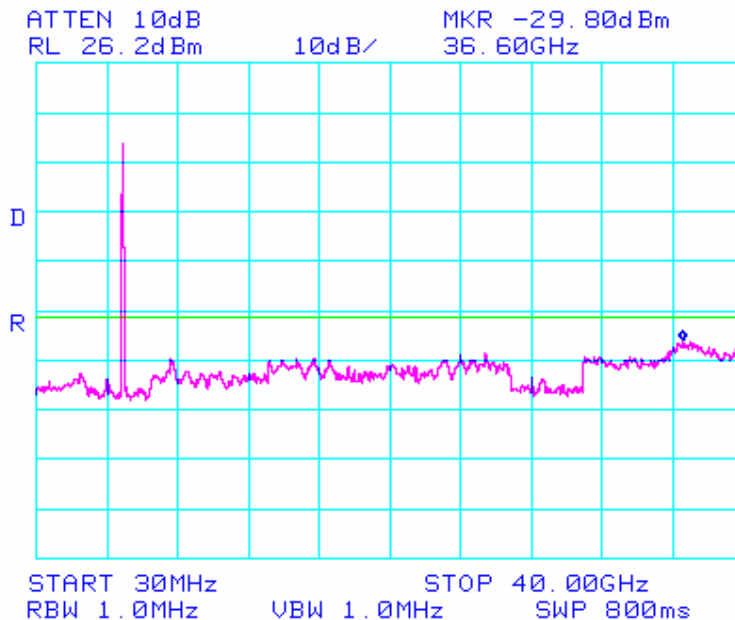

Spurious Emissions QPSK 20 MHz BW
4965 MHz 30 MHz – 40 GHz: Limit -25 dBm

This test report may be reproduced in full only. The document may only be updated by MiCOM Labs personnel. Any changes will be noted in the Document History section of the report.



Title: EX-4.9i Microwave Fixed Link
To: FCC Part 90 Subpart Y & IC RSS-111
Serial #: EXLT13-A1 Rev A
Issue Date: 12th February 2007
Page: 74 of 102

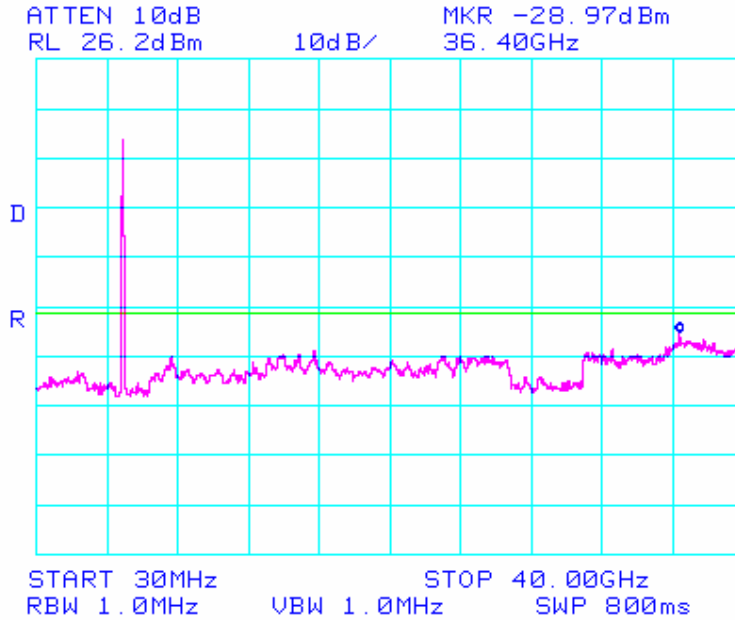

Spurious Emissions QPSK 20 MHz BW
4980 MHz 30 MHz – 40 GHz: Limit -25 dBm

This test report may be reproduced in full only. The document may only be updated by MiCOM Labs personnel. Any changes will be noted in the Document History section of the report.



Title: EX-4.9i Microwave Fixed Link
To: FCC Part 90 Subpart Y & IC RSS-111
Serial #: EXLT13-A1 Rev A
Issue Date: 12th February 2007
Page: 75 of 102

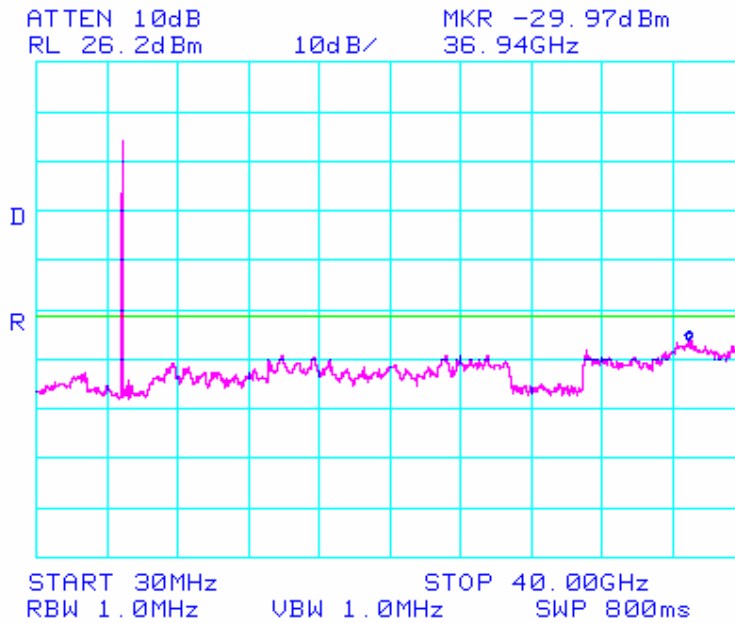

Spurious Emissions 16QAM 10 MHz BW
4945 MHz 30 MHz – 40 GHz: Limit -25 dBm

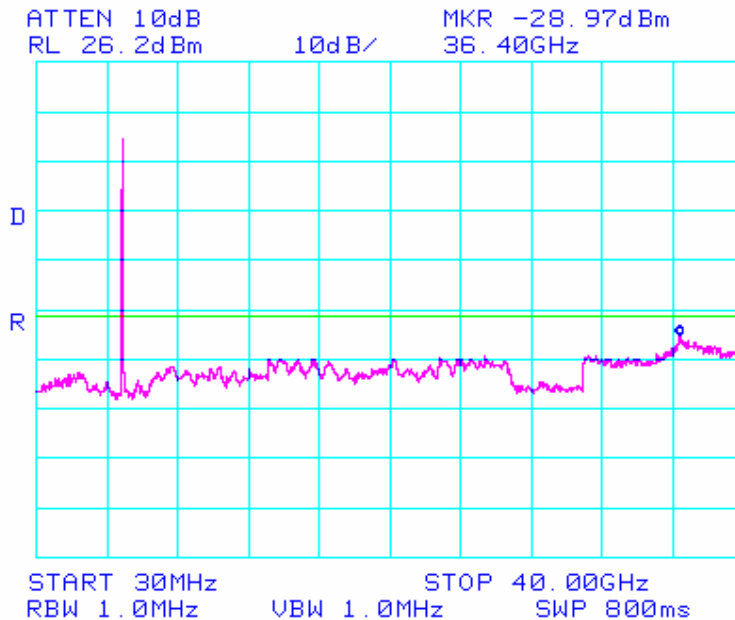

Spurious Emissions 16QAM 10 MHz BW
4965 MHz 30 MHz – 40 GHz: Limit -25 dBm

This test report may be reproduced in full only. The document may only be updated by MiCOM Labs personnel. Any changes will be noted in the Document History section of the report.



Title: EX-4.9i Microwave Fixed Link
To: FCC Part 90 Subpart Y & IC RSS-111
Serial #: EXLT13-A1 Rev A
Issue Date: 12th February 2007
Page: 76 of 102

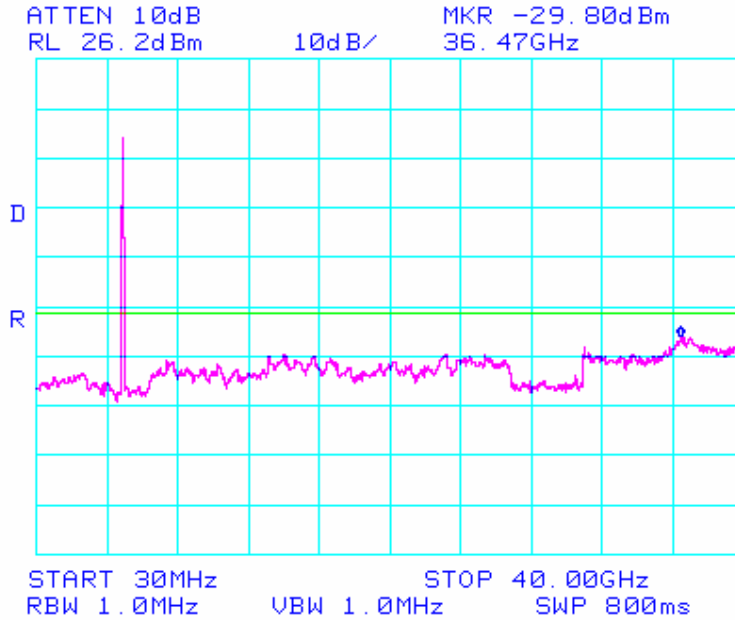

Spurious Emissions 16QAM 10 MHz BW
4985 MHz 30 MHz – 40 GHz: Limit -25 dBm

This test report may be reproduced in full only. The document may only be updated by MiCOM Labs personnel. Any changes will be noted in the Document History section of the report.

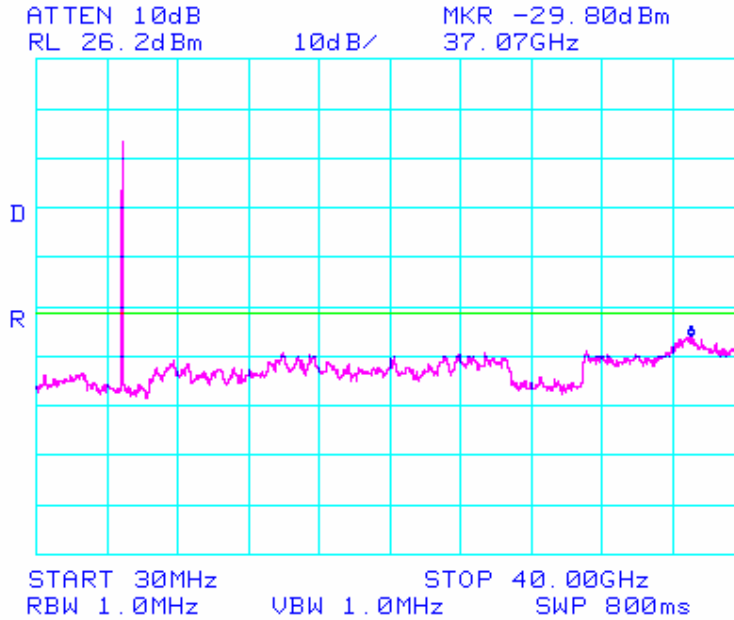

Spurious Emissions 16QAM 20 MHz BW
4950 MHz 30 MHz – 40 GHz: Limit -25 dBm

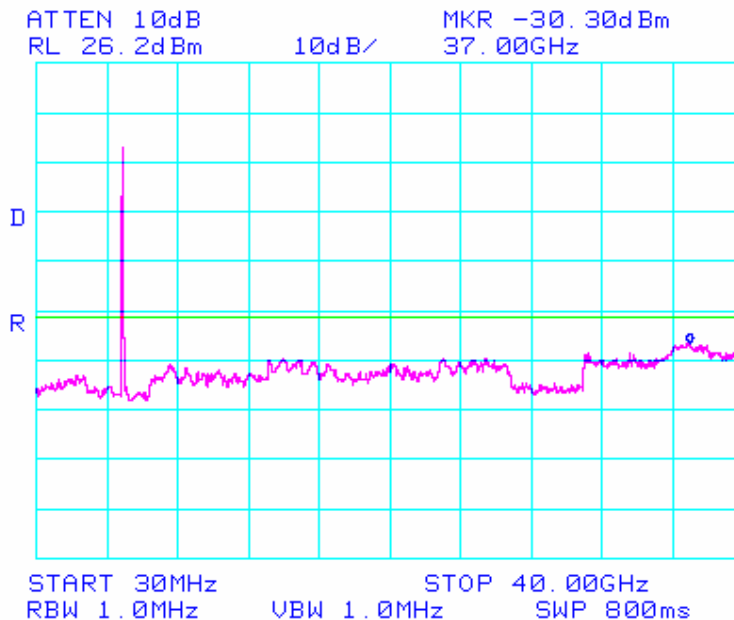

Spurious Emissions 16QAM 20 MHz BW
4965 MHz 30 MHz – 40 GHz: Limit -25 dBm

This test report may be reproduced in full only. The document may only be updated by MiCOM Labs personnel. Any changes will be noted in the Document History section of the report.



Title: EX-4.9i Microwave Fixed Link
To: FCC Part 90 Subpart Y & IC RSS-111
Serial #: EXLT13-A1 Rev A
Issue Date: 12th February 2007
Page: 78 of 102

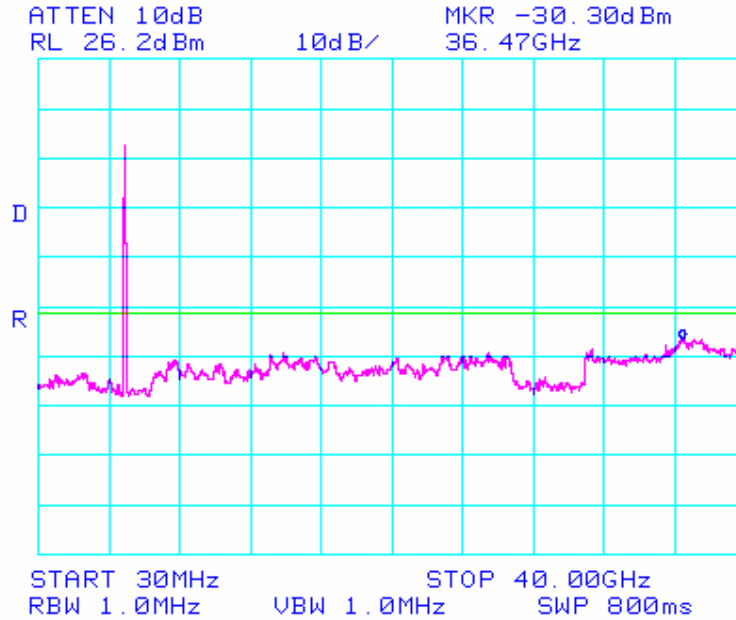

Spurious Emissions 16QAM 20 MHz BW
4980 MHz 30 MHz – 40 GHz: Limit -25 dBm

This test report may be reproduced in full only. The document may only be updated by MiCOM Labs personnel. Any changes will be noted in the Document History section of the report.

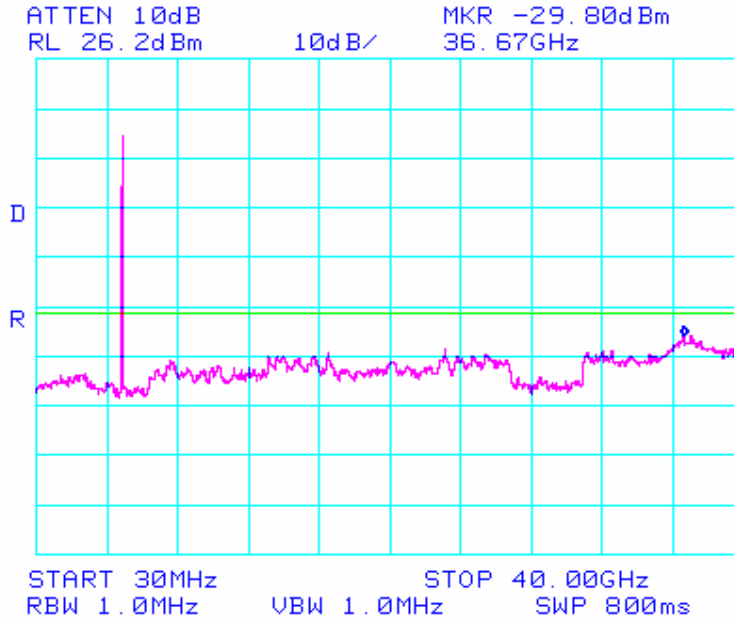

Spurious Emissions 64QAM 10 MHz BW
4945 MHz 30 MHz – 40 GHz: Limit -25 dBm

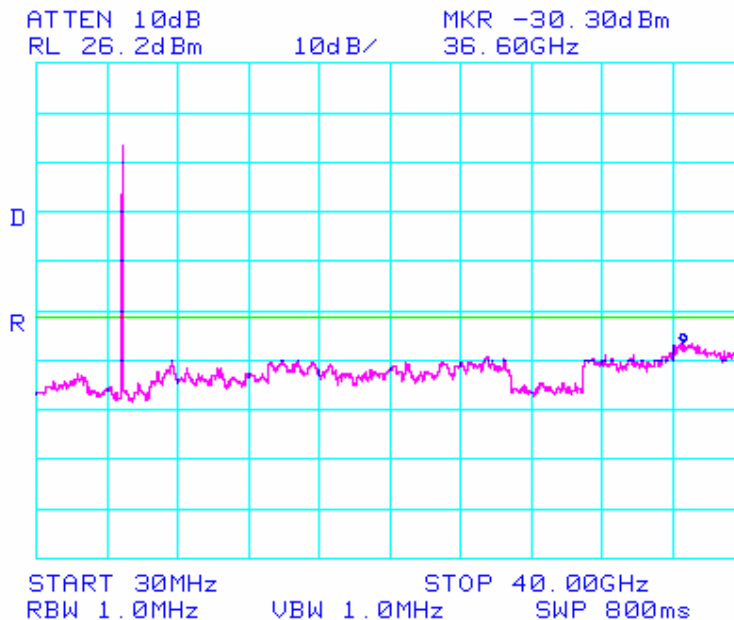

Spurious Emissions 64QAM 10 MHz BW
4965 MHz 30 MHz– 40 GHz: Limit -25 dBm

This test report may be reproduced in full only. The document may only be updated by MiCOM Labs personnel. Any changes will be noted in the Document History section of the report.



Title: EX-4.9i Microwave Fixed Link
To: FCC Part 90 Subpart Y & IC RSS-111
Serial #: EXLT13-A1 Rev A
Issue Date: 12th February 2007
Page: 80 of 102

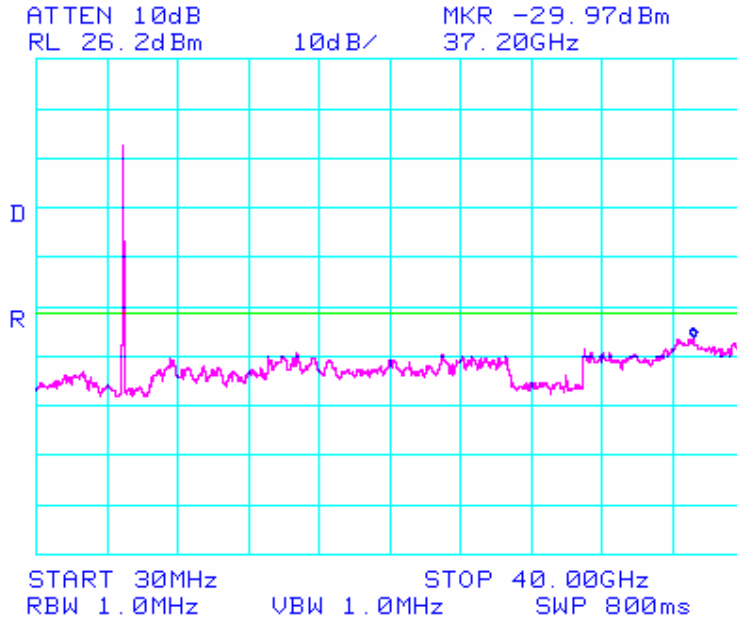

Spurious Emissions 64QAM 10 MHz BW
4985 MHz 30 MHz – 40 GHz: Limit -25 dBm

This test report may be reproduced in full only. The document may only be updated by MiCOM Labs personnel. Any changes will be noted in the Document History section of the report.

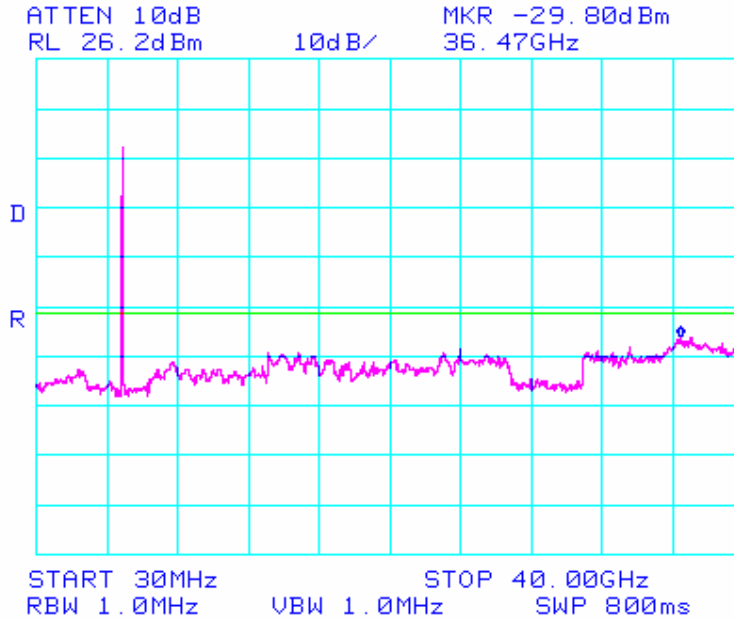

Spurious Emissions 64QAM 20 MHz BW
4950 MHz 30 MHz – 40 GHz: Limit -25 dBm

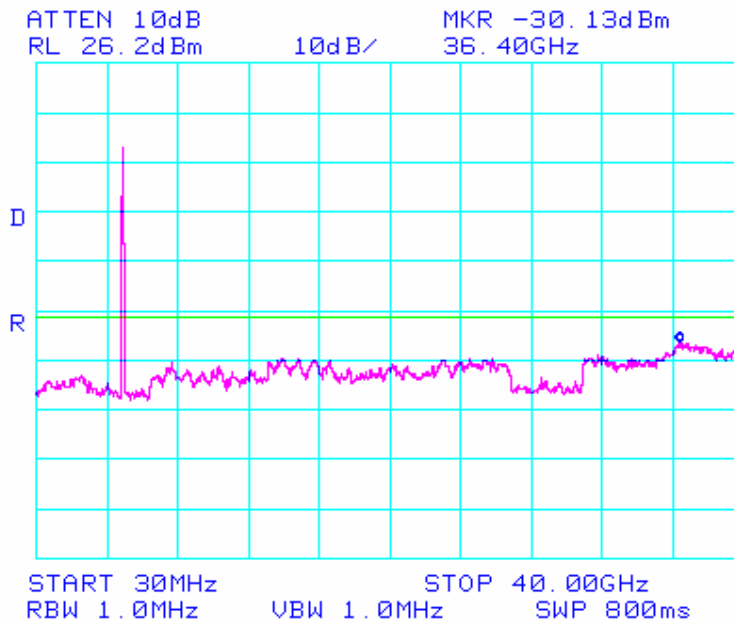

Spurious Emissions 64QAM 20 MHz BW
4965 MHz 30 MHz – 40 GHz: Limit -25 dBm

This test report may be reproduced in full only. The document may only be updated by MiCOM Labs personnel. Any changes will be noted in the Document History section of the report.



Title: EX-4.9i Microwave Fixed Link
To: FCC Part 90 Subpart Y & IC RSS-111
Serial #: EXLT13-A1 Rev A
Issue Date: 12th February 2007
Page: 82 of 102

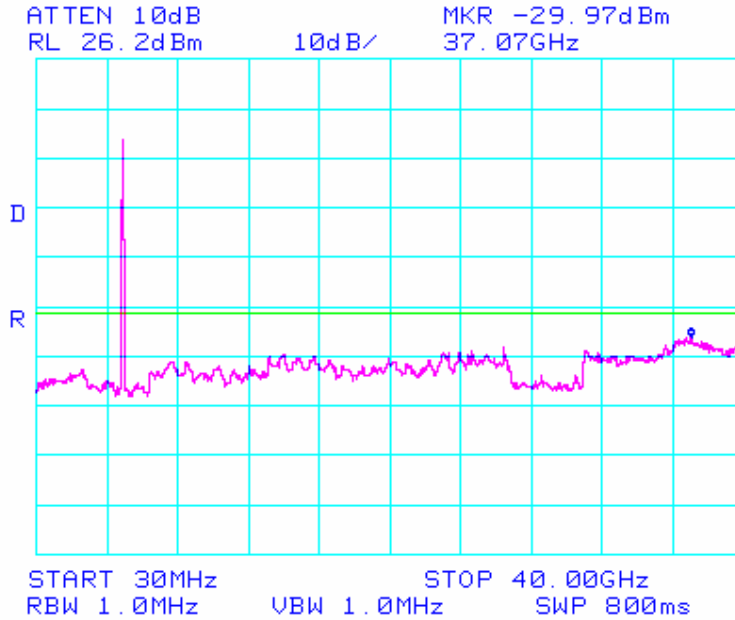

Spurious Emissions 64QAM 20 MHz BW
4980 MHz 30 MHz – 40 GHz: Limit -25 dBm

This test report may be reproduced in full only. The document may only be updated by MiCOM Labs personnel. Any changes will be noted in the Document History section of the report.



5.1.6.2. Receiver Conducted Spurious Emissions (30 M- 40 GHz)

Industry Canada RSS-Gen §6

Receiver Limits

If a conducted measurement is made, no spurious output signals appearing at the antenna terminals shall exceed 2 nanowatts (-57 dBm) per any 4 kHz spurious frequency in the band 30-1000 MHz, or 5 nanowatts (-53dBm) above 1 GHz.

Measurements were performed on the following channels;

4945 MHz, 4965 MHz, 4985 MHz

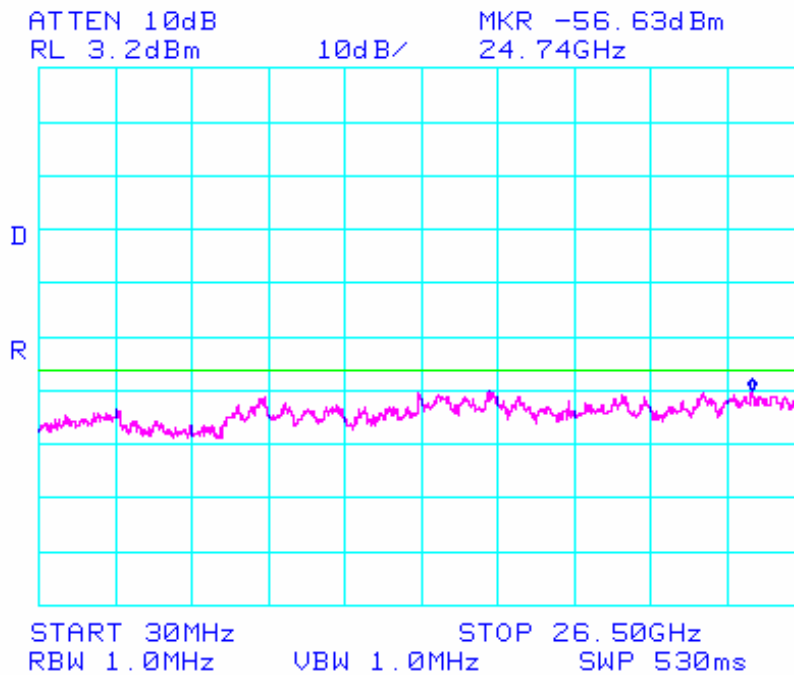

Channel 4945 MHz



Title: EX-4.9i Microwave Fixed Link
To: FCC Part 90 Subpart Y & IC RSS-111
Serial #: EXLT13-A1 Rev A
Issue Date: 12th February 2007
Page: 85 of 102

Laboratory Measurement Uncertainty for Conducted Spurious Emissions

Measurement uncertainty	±2.37 dB
-------------------------	----------

Traceability

Method	Test Equipment Used
Measurements were made per work instruction WI-05 'Measurement of Spurious Emissions'	0070, 0116, 0158, 0088, 0252, 0313, 0314

This test report may be reproduced in full only. The document may only be updated by MiCOM Labs personnel. Any changes will be noted in the Document History section of the report.



Title: EX-4.9i Microwave Fixed Link
To: FCC Part 90 Subpart Y & IC RSS-111
Serial #: EXLT13-A1 Rev A
Issue Date: 12th February 2007
Page: 86 of 102

5.1.7. Radiated Spurious Emissions

5.1.7.1. Transmitter Radiated Emissions above 1 GHz

FCC 47 CFR Part 90, Subpart Y; 2.1053; §90.210(m)
ANSI/TIA-603
Industry Canada RSS-111 §4.4

Test Procedure

Measurements were made while EUT was operating in a modulated transmit mode of operation, at the appropriate center frequency, 100% duty cycle and maximum power at all times. Radiated spurious emissions were measured to 40 GHz. Substitution was performed on any emissions observed. The antenna port was attenuated with a 50 Ω termination.

As no antennae were required for testing purposes and only QPSK 10 MHz bandwidth was tested to prove compliance.

The measurement equipment was set to measure in peak hold mode. The emissions were measured in the anechoic chamber at a 3-meter distance on every azimuth in both horizontal and vertical polarities. The emissions are recorded and maximized as a function of azimuth by rotation through 360° with a spectrum analyzer in peak hold mode.

The highest emissions relative to the limit are listed for each frequency spanned.

Measurements below 1 GHz utilized 120 KHz RBW, measurements above 1 GHz were performed using a minimum RBW of 1 MHz.

Limits were calculated which depended on average transmit power level(s). See test report Section 5.1.2 for average power level measurements

Highest power level: +24.25 dBm

Lowest Power Level: +22.13 dBm

Limit

From FCC Part 90.210 (m)

On any frequency removed from the assigned frequency between above 150 % of the authorized bandwidth: 50 dB or 55 + 10 log (P) dB, whichever is the lesser attenuation.

Attenuation

55 + 10 log (P) dB for maximum power = 49.24 dB attenuation

55 + 10 log (P) dB for lowest power = 47.12 dB attenuation

Highest Power Limit: +24.25 – 49.24 = -24.99 dBm

Lowest Power Limit: +22.13 – 47.12 = -24.99 dBm

This test report may be reproduced in full only. The document may only be updated by MiCOM Labs personnel. Any changes will be noted in the Document History section of the report.

Test Measurement Set up

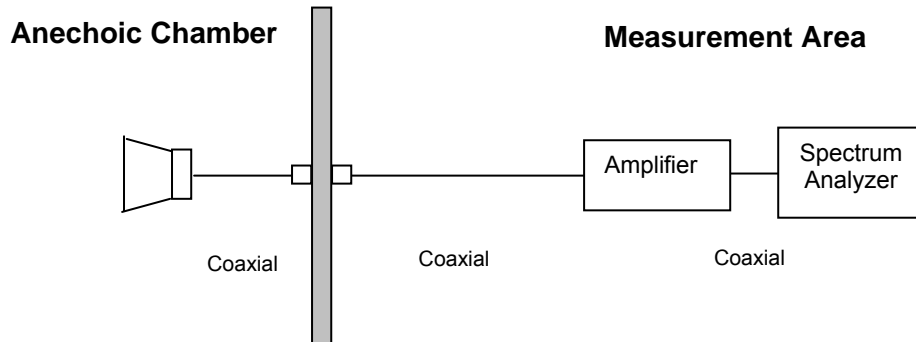

Measurement set up for Radiated Emission Test



Radio parameters

10 MHz QPSK Maximum Power, Channel 4945 MHz

INITIAL INVESTIGATION				SUBSTITUTION RESULTS				
Freq. (MHz)	Pol.	Raw (dBuV)	Res BW (KHz)	Pwr @ Antenna (dBm)	Ant. Gain (dB)	EIRP (dBm)	Limit (dBm)	Margin (dB)

No emissions found within 6 dB of the limit. Emission breaking the limit is the carrier

QPSK 10 MHz Bandwidth Channel Frequency 4945 MHz Results

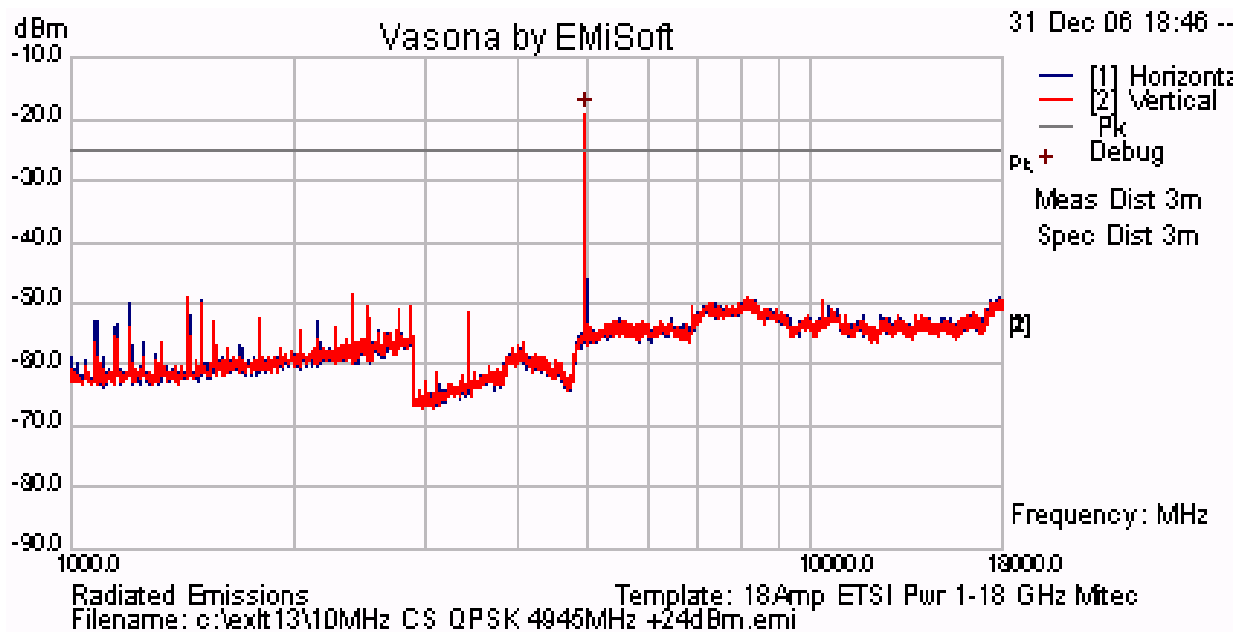

This test report may be reproduced in full only. The document may only be updated by MiCOM Labs personnel. Any changes will be noted in the Document History section of the report.



10 MHz QPSK Maximum Power, Channel 4965 MHz

INITIAL INVESTIGATION				SUBSTITUTION RESULTS				
Freq. (MHz)	Pol.	Raw (dBuV)	Res BW (KHz)	Pwr @ Antenna (dBm)	Ant. Gain (dB)	EIRP (dBm)	Limit (dBm)	Margin (dB)

No emissions found within 6 dB of the limit. Emission breaking the limit is the carrier

QPSK 10 MHz Bandwidth Channel Frequency 4965 MHz Results

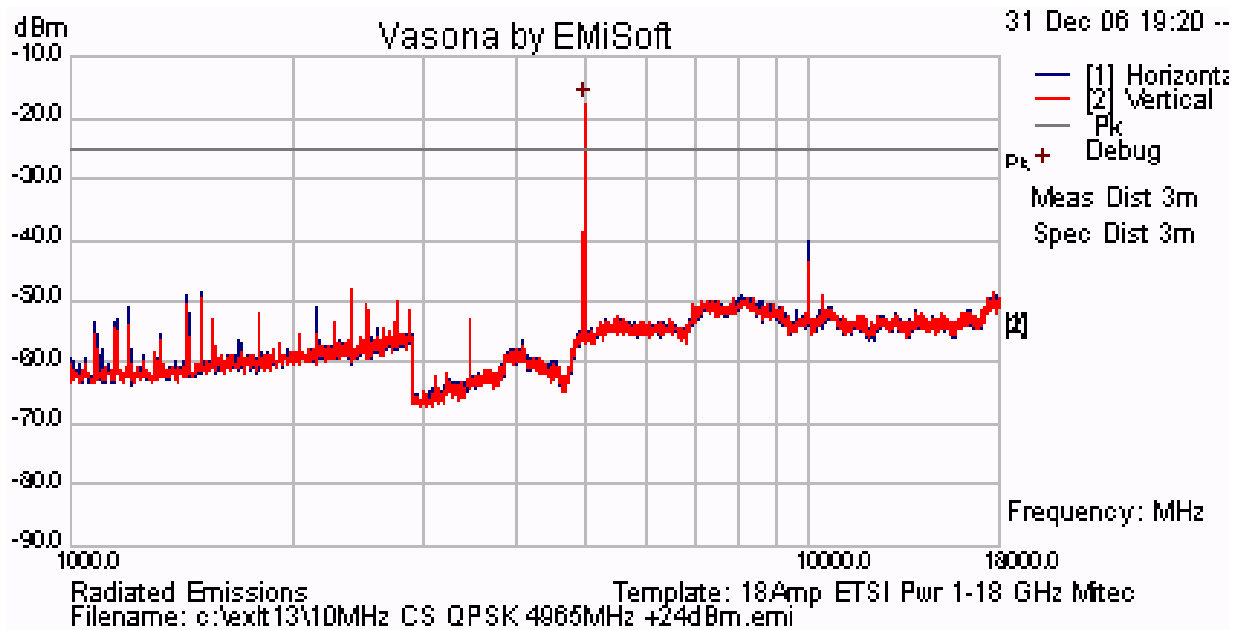

This test report may be reproduced in full only. The document may only be updated by MiCOM Labs personnel. Any changes will be noted in the Document History section of the report.



10 MHz QPSK Maximum Power, Channel 4985 MHz

INITIAL INVESTIGATION				SUBSTITUTION RESULTS				
Freq. (MHz)	Pol.	Raw (dBuV)	Res BW (KHz)	Pwr @ Antenna (dBm)	Ant. Gain (dB)	EIRP (dBm)	Limit (dBm)	Margin (dB)

No emissions found within 6 dB of the limit. Emission breaking the limit is the carrier

QPSK 10 MHz Bandwidth Channel Frequency 4985 MHz Results

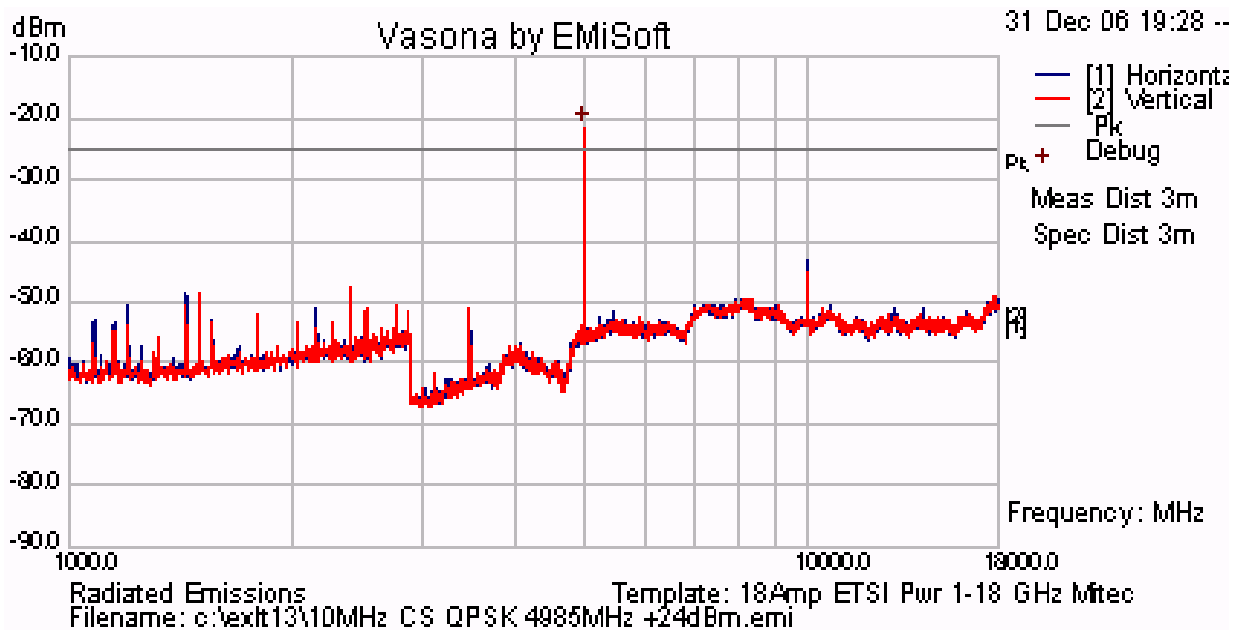

This test report may be reproduced in full only. The document may only be updated by MiCOM Labs personnel. Any changes will be noted in the Document History section of the report.



Title: EX-4.9i Microwave Fixed Link
To: FCC Part 90 Subpart Y & IC RSS-111
Serial #: EXLT13-A1 Rev A
Issue Date: 12th February 2007
Page: 91 of 102

Laboratory Measurement Uncertainty for Radiated Emissions

Measurement uncertainty	+5.6/ -4.5 dB
-------------------------	---------------

Traceability

Method	Test Equipment Used
Measurements were made per work instruction WI-03 'Measurement of Radiated Emissions'	0088, 0104, 0158, 0134, 0310, 0312, Dipole.

This test report may be reproduced in full only. The document may only be updated by MiCOM Labs personnel. Any changes will be noted in the Document History section of the report.

5.1.7.2. Transmitter Radiated Spurious Emissions (30M-1 GHz)

FCC, Part 15 Subpart C §15.205/ §15.209
Industry Canada RSS-111 §4.4

Test Procedure

Preliminary radiated emissions were measured in the anechoic chamber at a 10-meter distance on every azimuth in both horizontal and vertical polarity. The emissions are recorded with a spectrum analyzer in peak hold mode. Emissions closest to the limits are measured in the quasi-peak mode with the tuned receiver using a bandwidth of 120 kHz. Only the highest emissions relative to the limit are listed. The anechoic chamber test set-up is identified in Section 6 Test Set-Up Photographs.

System operation was completed with five operational transmitters terminated in a 50Ω load at maximum power and one 2.4 GHz transmitter terminated in the 16.4 dBi Sector antenna.

Test Measurement Set up

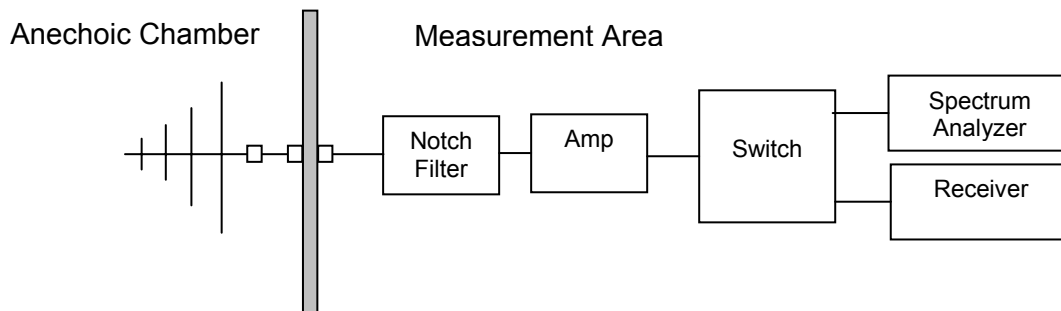

Field Strength Calculation

The field strength is calculated by adding the Antenna Factor and Cable Loss, and subtracting Amplifier Gain from the measured reading. In this test facility, the Antenna Factor, Cable Loss, and Amplifier Gains are loaded into the Rohde & Schwarz Receiver and the corrected field strength can be read directly on the receiver.

where:

$$FS = R + AF + CORR$$

FS = Field Strength
R = Measured Receiver Input Amplitude
AF = Antenna Factor
CORR = Correction Factor = CL – AG + NFL
CL = Cable Loss
AG = Amplifier Gain



Title: EX-4.9i Microwave Fixed Link
To: FCC Part 90 Subpart Y & IC RSS-111
Serial #: EXLT13-A1 Rev A
Issue Date: 12th February 2007
Page: 93 of 102

For example:

Given a Receiver input reading of 51.5dB μ V; Antenna Factor of 8.5dB; Cable Loss of 1.3dB; Falloff Factor of 0dB, an Amplifier Gain of 26dB and Notch Filter Loss of 1dB. The Field Strength of the measured emission is:

$$FS = 51.5 + 8.5 + 1.3 - 26.0 + 1 = 36.3\text{dB}\mu\text{V}/\text{m}$$

Conversion between dB μ V/m (or dB μ V) and μ V/m (or μ V) are done as:

$$\text{Level (dB}\mu\text{V}/\text{m)} = 20 * \text{Log (level (\mu\text{V}/\text{m}))}$$

$$40 \text{ dB}\mu\text{V}/\text{m} = 100\mu\text{V}/\text{m}$$

$$48 \text{ dB}\mu\text{V}/\text{m} = 250\mu\text{V}/\text{m}$$

Measurement Results for Spurious Emissions (30 MHz – 1 GHz)

Ambient conditions.

Temperature: 19 to 26 °C Relative humidity: 31 to 57 % Pressure: 999 to 1009 mbar

Radio parameters.

10 MHz BW

Modulation: QPSK

Full Power: +24dBm

This test report may be reproduced in full only. The document may only be updated by MiCOM Labs personnel. Any changes will be noted in the Document History section of the report.

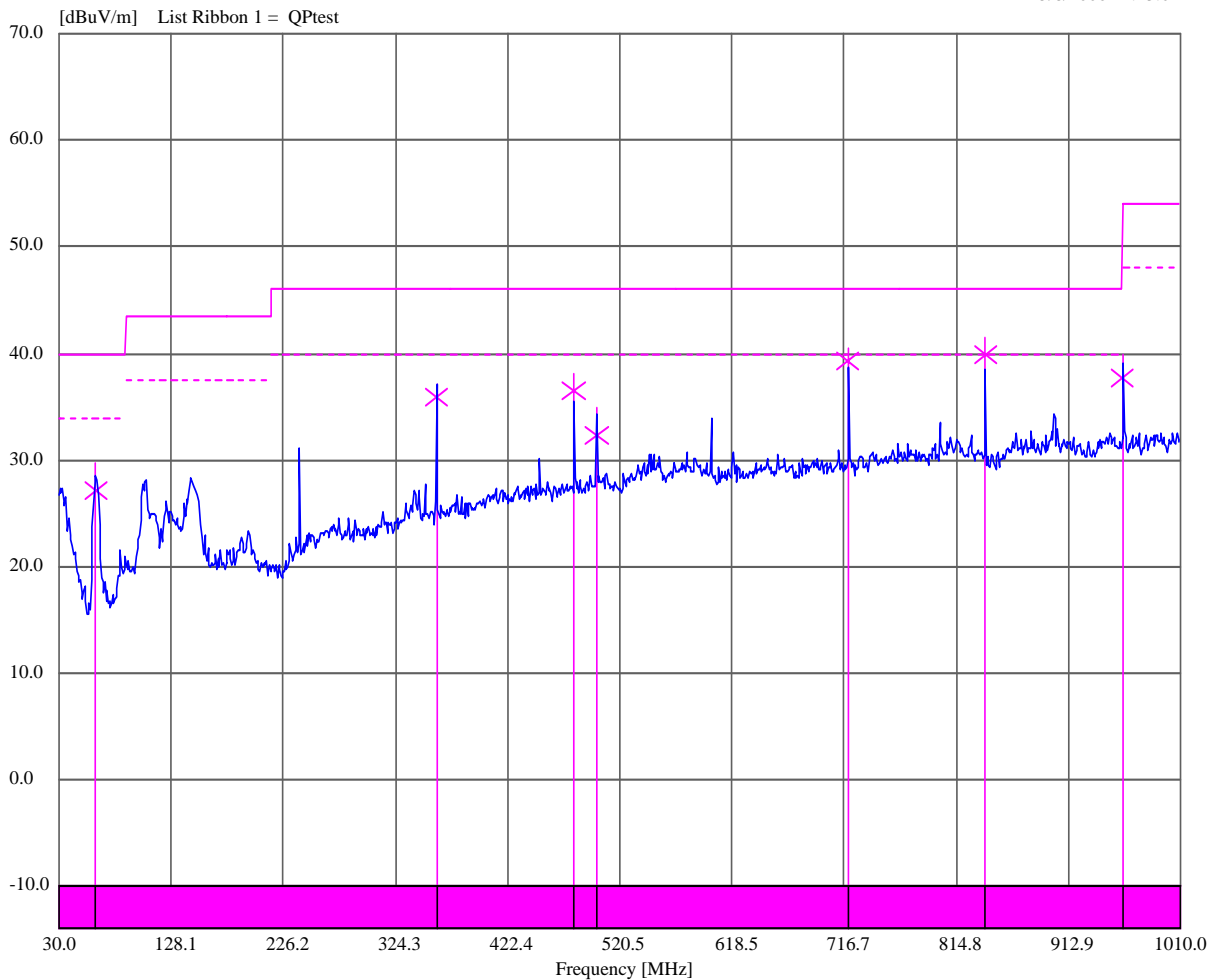

TABLE OF RESULTS

Freq. (MHz)	Peak (dBuV/m)	QP (dBuV/m)	QP Lmt (dBuV/m)	QP Margin (dB)	Angle (deg)	Height (cm)	Polarity
62.348724	29.71	27.09	40.00	-12.91	348	196	Vert
359.990465	37.15	35.94	46.00	-10.06	11	396	Horz
479.992743	38.18	36.58	46.00	-9.42	4	300	Horz
499.982538	34.96	32.40	46.00	-13.60	338	332	Horz
720.007412	40.52	39.24	46.00	-6.76	86	294	Vert
840.004616	41.59	39.93	46.00	-6.07	129	200	Vert
960.011077	39.87	37.68	54.00	-16.32	41	200	Vert

Radiated Spurious Emissions 30 MHz to 1 GHz

5/8/2006 14:23:04



This test report may be reproduced in full only. The document may only be updated by MiCOM Labs personnel. Any changes will be noted in the Document History section of the report.

5.1.8. AC Wireline Conducted Emissions (150 kHz – 30 MHz)

FCC, Part 15 Subpart C §15.207
Industry Canada RSS-Gen §7.2.2

Test Procedure

The EUT is configured in accordance with ANSI C63.4. The conducted emissions are measured in a shielded room with a spectrum analyzer in peak hold in the first instance. Emissions closest to the limit are measured in the quasi-peak mode (QP) with the tuned receiver using a bandwidth of 9 kHz. The emissions are maximized further by cable manipulation. The highest emissions relative to the limit are listed.

Test Measurement Set up

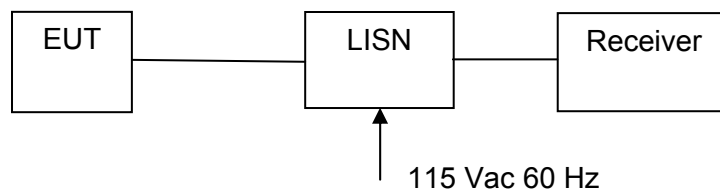

Measurement set up for AC Wireline Conducted Emissions Test

Measurement Results for AC Wireline Conducted Emissions (150 kHz – 30 MHz)

Ambient conditions.

Temperature: 19 to 26 °C Relative humidity: 31 to 57 % Pressure: 999 to 1009 mbar

Radio parameters.

Power: Full power (+24 dBm)

Transmitter Port: Terminated in 50 Ohm load

Duty Cycle: 100%



TABLE OF RESULTS

Freq (MHz)	Line	Peak (dB μ V)	QP (dB μ V)	QP Limit (dB μ V)	QP Margin (dB)	Ave. (dB μ V)	Ave. Limit (dB μ V)	Ave. Margin (dB)
2.672	N	44.59	42.81	56	-13.19	40.34	46	-5.66
4.377	N	44.21	41.75	56	-14.25	37.86	46	-8.14
4.82	N	44.18	36.68	56	-19.32	32.69	46	-13.31
4.885	N	44.14	21.16	56	-34.84	15.90	46	-30.10
4.603	N	44.1	43.35	56	-12.65	40.27	46	-5.73
4.158	N	43.8	43.29	56	-12.71	40.10	46	-5.90

AC Wireline Conducted Emissions (150 kHz – 30 MHz)

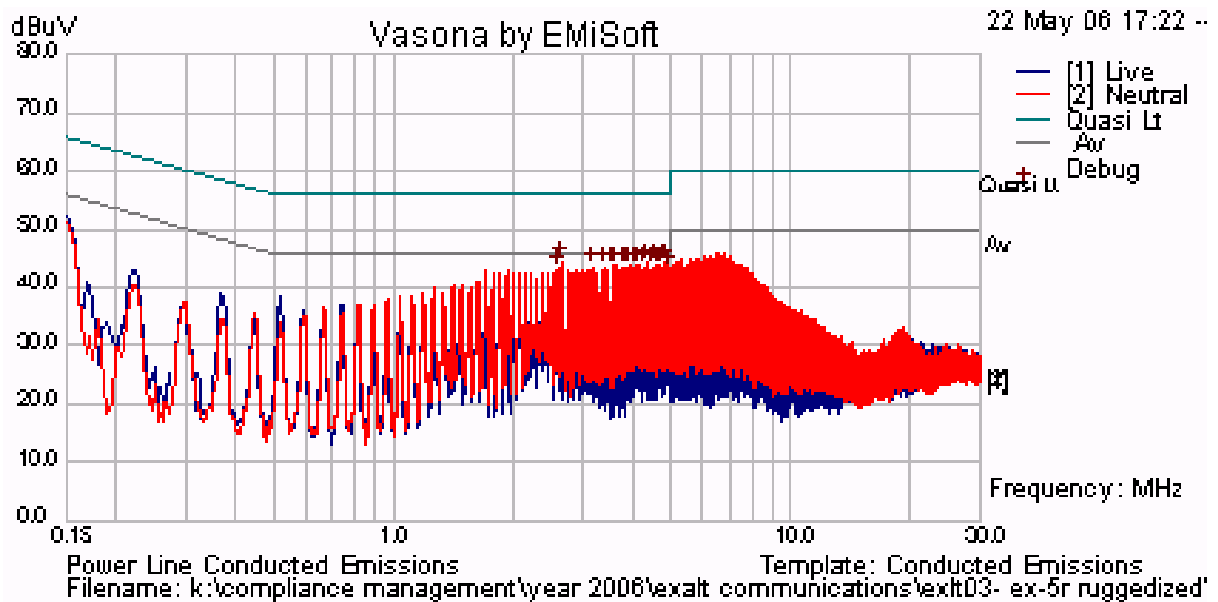

This test report may be reproduced in full only. The document may only be updated by MiCOM Labs personnel. Any changes will be noted in the Document History section of the report.



Specification

Limit

§15.207 (a) Except as shown in paragraphs (b) and (c) of this section, for an intentional radiator that is designed to be connected to the public utility (AC) power line, the radio frequency voltage that is conducted back onto the AC power line on any frequency or frequencies within the band 150 kHz to 30 MHz shall not exceed the limits in the following table, as measured using a 50 $\mu\Omega$ line impedance stabilization network (LISN), see §15.207 (a) matrix below. Compliance with the provisions of this paragraph shall be based on the measurement of the radio frequency voltage between each power line and ground at the power terminal.

§15.207 (a) Limit Matrix

The lower limit applies at the boundary between frequency ranges

Frequency of Emission (MHz)	Conducted Limit (dB μ V)	
	Quasi-peak	Average
0.15-0.5	66 to 56*	56 to 46*
0.5-5	56	46
5-30	60	50

* Decreases with the logarithm of the frequency

Laboratory Measurement Uncertainty for Conducted Emissions

Measurement uncertainty	± 2.64 dB
-------------------------	---------------

Traceability

Method	Test Equipment Used
Measurements were made per work instruction WI-EMC-01 'Measurement of Conducted Emissions'	0158, 0184, 0193, 0190, 0293, 0307

This test report may be reproduced in full only. The document may only be updated by MiCOM Labs personnel. Any changes will be noted in the Document History section of the report.

6. TEST SET-UP PHOTOGRAPHS

6.1. General Measurement Test Set-Up

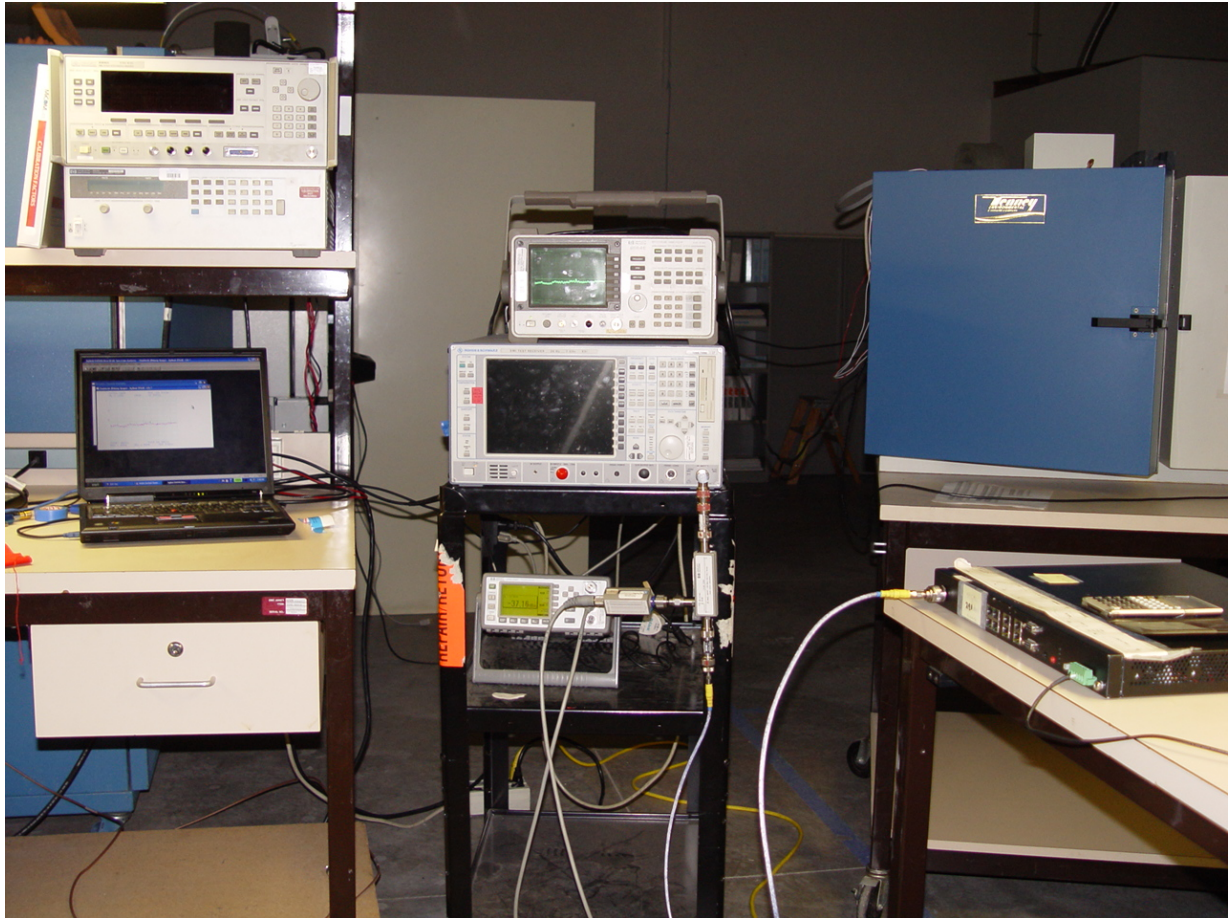

This test report may be reproduced in full only. The document may only be updated by MiCOM Labs personnel. Any changes will be noted in the Document History section of the report.

6.2. Radiated Spurious Emissions



This test report may be reproduced in full only. The document may only be updated by MiCOM Labs personnel. Any changes will be noted in the Document History section of the report.

6.3. Conducted Emissions (150 kHz - 30 MHz)



This test report may be reproduced in full only. The document may only be updated by MiCOM Labs personnel. Any changes will be noted in the Document History section of the report.



Title: EX-4.9i Microwave Fixed Link
To: FCC Part 90 Subpart Y & IC RSS-111
Serial #: EXLT13-A1 Rev A
Issue Date: 12th February 2007
Page: 101 of 102

7. TEST EQUIPMENT DETAILS

Asset #	Instrument	Manufacturer	Model #	Serial #
0088	Spectrum Analyzer	Hewlett Packard	8564E	3410A00141
0104	1-18GHz Horn Antenna	The Electro-Mechanics Company	3115	9205-3882
0134	Amplifier	Com Power	PA 122	181910
0158	Barometer /Thermometer	Control Co.	4196	E2846
0193	EMI Receiver	Rhode & Schwartz	ESI 7	838496/007
0252	SMA Cable	Megaphase	Sucoflex 104	None
0304	2.4GHzHz Notch Filter	Micro-Tronics	--	001
0310	2m SMA Cable	Micro-Coax	UFA210A-0-0787-3G03G0	209089-001
0312	3m SMA Cable	Micro-Coax	UFA210A-1-1181-3G0300	209092-001
0313	Coupler	Hewlett Packard	86205A	3140A01285
0314	30dB N-Type Attenuator	ARRA	N9444-30	1623
0223	Power Meter	Hewlett Packard	EPM-442A	3125U11552
0116	Power Sensor	Hewlett Packard	8485A	3318A19694
0117	Power Sensor	Hewlett Packard	8487D	3318A00371
0184	Pulse Limiter	Rhode & Schwartz	ESH3Z2	357.8810.52
0190	LISN	Rhode & Schwartz	ESH3Z5	836679/006
0293	BNC Cable	Megaphase	1689 1GVT4	15F50B001
0307	BNC Cable	Megaphase	1689 1GVT4	15F50B002
	Dipole Antenna	EMCO	3121C	9009 - 605

This test report may be reproduced in full only. The document may only be updated by MiCOM Labs personnel. Any changes will be noted in the Document History section of the report.



440 Boulder Court, Suite 200
Pleasanton, CA 94566, USA
Tel: 1.925.462.0304
Fax: 1.925.462.0306
www.micomlabs.com