

Test of Exalt EX-2.4i-16 Fixed Link Radio

To: FCC 47 CFR Part15.247 & IC RSS-210

Test Report Serial No.: EXLT19-A1 Rev A





Test of Model EX-2.4i-16

To FCC 47 CFR Part15.247 & IC RSS-210

Test Report Serial No.: EXLT19-A1 Rev A

This report supersedes None

Manufacturer: Exalt Communications, Inc
580 Division Street
Campbell, California 95008
USA

Product Function: 2.4 GHz Point to Point Fixed Link Radio

Copy No: pdf **Issue Date:** 28th Feb 2007

This Test Report is Issued Under the Authority of:

MiCOM Labs, Inc.
440 Boulder Court, Suite 200
Pleasanton, CA 94566 USA
Phone: +1 (925) 462-0304
Fax: +1 (925) 462-0306
www.micomlabs.com



CERTIFICATE #2381.01

MiCOM Labs is an ISO 17025 Accredited Testing Laboratory



Title: Exalt EX-2.4i-16 Fixed Link Radio
To: FCC 47 CFR Part15.247 & IC RSS-210
Serial #: EXLT19-A1 Rev A
Issue Date: 28th Feb 2007
Page: 3 of 248

This page has been left intentionally blank

This test report may be reproduced in full only. The document may only be updated by MiCOM Labs personnel. Any changes will be noted in the Document History section of the report.



Title: Exalt EX-2.4i-16 Fixed Link Radio
To: FCC 47 CFR Part15.247 & IC RSS-210
Serial #: EXLT19-A1 Rev A
Issue Date: 28th Feb 2007
Page: 4 of 248

TABLE OF CONTENTS

COVER PAGE	1
ACCREDITATION & LISTINGS.....	5
1. TEST RESULT CERTIFICATE	8
2. REFERENCES AND MEASUREMENT UNCERTAINTY	9
2.1. Normative References	9
2.2. Test and Uncertainty Procedures	9
3. PRODUCT DETAILS AND TEST CONFIGURATIONS	10
3.1. Technical Details	10
3.2. Scope of Test Program.....	12
3.3. Equipment Model(s) and Serial Number(s)	13
3.4. Antenna Details	14
3.5. Cabling and I/O Ports	14
3.6. Test Configurations.....	15
3.7. Equipment Modifications.....	15
3.8. Deviations from the Test Standard	15
3.9. Subcontracted Testing or Third Party Data	16
4. TEST SUMMARY	17
5. TEST RESULTS	19
5.1. Device Characteristics	19
5.1.1. <i>6 dB and 99 % Bandwidth</i>	19
5.1.2. <i>Peak Output Power</i>	45
5.1.3. <i>Peak Power Spectral Density</i>	59
5.1.4. <i>Maximum Permissible Exposure</i>	73
5.1.5. <i>Conducted Spurious Emissions</i>	75
5.1.6. <i>Radiated Emissions</i>	135
5.1.7. <i>AC Wireline Conducted Emissions (150 kHz – 30 MHz)</i>	240
6. PHOTOGRAPHS.....	243
6.1. Radiated Emissions (30 MHz-1 GHz).....	243
6.2. Radiated Emissions >1 GHz.....	244
6.3. Conducted Emissions (150 kHz - 30 MHz).....	245
6.4. General Measurement Test Set-Up.....	246
7. TEST EQUIPMENT DETAILS.....	247

This test report may be reproduced in full only. The document may only be updated by MiCOM Labs personnel. Any changes will be noted in the Document History section of the report.



Title: Exalt EX-2.4i-16 Fixed Link Radio
To: FCC 47 CFR Part15.247 & IC RSS-210
Serial #: EXLT19-A1 Rev A
Issue Date: 28th Feb 2007
Page: 5 of 248

ACCREDITATION & LISTINGS

MiCOM Labs, Inc. an accredited laboratory complies with the international standard BS EN ISO/IEC 17025. The company is accredited by the American Association for Laboratory Accreditation (A2LA) www.a2la.org test laboratory number 2381.01. MiCOM Labs test schedule is available at the following URL; <http://www.a2la.org/scopepdf/2381-01.pdf>



THE AMERICAN
ASSOCIATION
FOR LABORATORY
ACCREDITATION

ACCREDITED LABORATORY

A2LA has accredited

MICOM LABS
Pleasanton, CA

for technical competence in the field of

Electrical Testing

The accreditation covers the specific tests and types of tests listed on the agreed scope of accreditation. This laboratory meets the requirements of ISO/IEC 17025 - 1999 "General Requirements for the Competence of Testing and Calibration Laboratories" and any additional program requirements in the identified field of testing.

Presented this 14th day of September 2005.



Peter Almy

President
For the Accreditation Council
Certificate Number 2381.01
Valid to: November 30, 2007

For tests or types of tests to which this accreditation applies,
please refer to the laboratory's Electrical Scope of Accreditation.

This test report may be reproduced in full only. The document may only be updated by MiCOM Labs personnel. Any changes will be noted in the Document History section of the report.



Title: Exalt EX-2.4i-16 Fixed Link Radio
To: FCC 47 CFR Part15.247 & IC RSS-210
Serial #: EXLT19-A1 Rev A
Issue Date: 28th Feb 2007
Page: 6 of 248

LISTINGS

MiCOM Labs test facilities are listed by the following organizations;

North America

United States of America

Federal Communications Commission (FCC) Listing #: 102167

This test report may be reproduced in full only. The document may only be updated by MiCOM Labs personnel. Any changes will be noted in the Document History section of the report.



Title: Exalt EX-2.4i-16 Fixed Link Radio
To: FCC 47 CFR Part15.247 & IC RSS-210
Serial #: EXLT19-A1 Rev A
Issue Date: 28th Feb 2007
Page: 7 of 248

DOCUMENT HISTORY

Document History		
Revision	Date	Comments
Draft		
Rev A	28 th February 2007	First issue.

This test report may be reproduced in full only. The document may only be updated by MiCOM Labs personnel. Any changes will be noted in the Document History section of the report.



Title: Exalt EX-2.4i-16 Fixed Link Radio
To: FCC 47 CFR Part15.247 & IC RSS-210
Serial #: EXLT19-A1 Rev A
Issue Date: 28th Feb 2007
Page: 8 of 248

1. TEST RESULT CERTIFICATE

Manufacturer:	Exalt Communications, Inc 580 Division Street Campbell, California 95008 USA	Tested By:	MiCOM Labs, Inc. 440 Boulder Court Suite 200 Pleasanton California, 94566, USA
EUT:	EX-2.4i-16 2.4GHz Point to Point Fixed Link Radio	Telephone:	+1 925 462 0304
Model:	EX-2.4i-16	Fax:	+1 925 462 0306
S/N:	SM44060018, & 001		
Test Date(s):	28th Oct 05 to 24th Jan 06	Website:	www.micomlabs.com

STANDARD(S)	TEST RESULTS
FCC 47 CFR Part15.247 & IC RSS-210	EQUIPMENT COMPLIES

MiCOM Labs, Inc. tested the equipment mentioned in accordance with the requirements set forth in the above standards. Test results indicate that the equipment tested is capable of demonstrating compliance with the requirements as documented within this report.

Notes:

1. This document reports conditions under which testing was conducted and the results of testing performed.
2. Details of test methods used have been recorded and kept on file by the laboratory.
3. Test results apply only to the item(s) tested.

Approved & Released for MiCOM Labs, Inc. by:



CERTIFICATE #2381.01

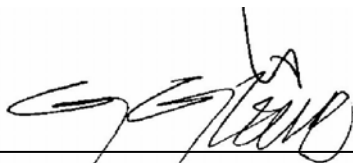

 Graeme Grieve
 Quality Manager MiCOM Labs,

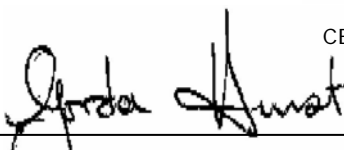

 Gordon Hurst
 President & CEO MiCOM Labs, Inc.

This test report may be reproduced in full only. The document may only be updated by MiCOM Labs personnel. Any changes will be noted in the Document History section of the report.

2. REFERENCES AND MEASUREMENT UNCERTAINTY

2.1. Normative References

Ref.	Publication	Year	Title
(i)	FCC 47 CFR Part 15.247	2001	Code of Federal Regulations
(ii)	Industry Canada RSS-210	Issue 6 Sept 2005	Low Power License-Exempt Radiocommunication Devices (All Frequency Bands)
(iii)	Industry Canada RSS-Gen	Issue 1 Sept 2005	General Requirements and Information for
(iv)	ANSI C63.4	2003	American National Standards for Methods of Measurement of Radio-Noise Emissions from Low-Voltage Electrical and Electronic Equipment in the Range of 9 kHz to 40 GHz
(v)	CISPR 22/ EN 55022	1997 1998	Limits and Methods of Measurements of Radio Disturbance Characteristics of Information Technology Equipment
(vi)	M 3003	Edition 1 Dec. 1997	Expression of Uncertainty and Confidence in Measurements
(vii)	LAB34	Edition 1 Aug 2002	The expression of uncertainty in EMC Testing
(viii)	ETSI TR 100 028	2001	Parts 1 and 2 Electromagnetic compatibility and Radio Spectrum Matters (ERM); Uncertainties in the measurement of mobile radio equipment characteristics
(ix)	A2LA	14 th September 2005	Reference to A2LA Accreditation Status – A2LA Advertising Policy

2.2. Test and Uncertainty Procedures

Conducted and radiated emission measurements were conducted in accordance with American National Standards Institute ANSI C63.4, listed in the Normative References section of this report.

Measurement uncertainty figures are calculated in accordance with ETSI TR 100 028 Parts 1 and 2.

Measurement uncertainties stated are based on a standard uncertainty multiplied by a coverage factor $k = 2$, providing a level of confidence of approximately 95 % in accordance with UKAS document M 3003 listed in the Normative References section of this report.



Title: Exalt EX-2.4i-16 Fixed Link Radio
To: FCC 47 CFR Part15.247 & IC RSS-210
Serial #: EXLT19-A1 Rev A
Issue Date: 28th Feb 2007
Page: 10 of 248

3. PRODUCT DETAILS AND TEST CONFIGURATIONS

3.1. Technical Details

Details	Description
Purpose:	Test of the Exalt Communications Inc Model EX-2.4i-16 to FCC and Industry Canada regulations.
Applicant:	Same as manufacturer
Manufacturer:	Exalt Communications, Inc 580 Division Street Campbell, California 95008 USA
Laboratory performing the tests:	MiCOM Labs, Inc. 440 Boulder Court, Suite 200 "B" Pleasanton, California 94566 USA
Test report reference number:	EXLT19-A1 Rev A
Standard(s) applied:	FCC 47 CFR Part15.247 & IC RSS-210
Dates of test (from - to):	28th Oct 05 to 24th Jan 06
No of Units Tested:	1
Type of Equipment:	2.4 GHz Point to Point Microwave Fixed Link
Manufacturers Trade Name:	Model EX-2.4i-16
Model:	EX-2.4i-16
Location for use:	Indoor use only
Declared Frequency Range(s):	2,400 to 2,483.5 MHz
Type of Modulation:	QPSK; 16QAM; 64QAM
Declared Nominal Output Power:	+27 dBm
EUT Modes of Operation:	QPSK; 16QAM; and 64QAM modulation available at 9 MHz, 18 MHz, 36 MHz, & 72 MHz Bandwidths.
Transmit/Receive Operation:	Time Division Duplex (TDD)
Rated Input Voltage and Current:	-48 Vdc
Operating Temperature Range:	Declared -25 to +65°C

This test report may be reproduced in full only. The document may only be updated by MiCOM Labs personnel. Any changes will be noted in the Document History section of the report.



Title: Exalt EX-2.4i-16 Fixed Link Radio
To: FCC 47 CFR Part15.247 & IC RSS-210
Serial #: EXLT19-A1 Rev A
Issue Date: 28th Feb 2007
Page: 11 of 248

ITU Emission Designator:	<u>9 MHz Bandwidth</u> QPSK 10M2W7D 16QAM 9M9W7D 64QAM 10M2W7D <u>18 MHz Bandwidth</u> QPSK 17M3W7D 16QAM 19M0W7D 64QAM 20M2W7D <u>36 MHz Bandwidth</u> QPSK 34M7W7D 16QAM 36M0W7D 64QAM 38M1W7D <u>72 MHz Bandwidth</u> QPSK 60M7W7D 16QAM 61M3W7D 64QAM 61M7W7D
Microprocessor(s) Model:	MPC852T
Clock/Oscillator(s):	Crystal: 25MHz, Oscillator: 10MHz, 2.048MHz, 44.736MHz/34.368MHz/12.880MHz
Frequency Stability:	±7 ppm
Equipment Dimensions:	17" x 14" x 2.63"
Weight:	12 lbs
Primary function of equipment:	2.4 GHz point-point microwave radio communications

This test report may be reproduced in full only. The document may only be updated by MiCOM Labs personnel. Any changes will be noted in the Document History section of the report.

3.2. Scope of Test Program

The scope of the test program was to test the Exalt Communications EX-2.4i-16 radio for compliance against FCC 47 CFR Part 15.247 and Industry Canada RSS-210 specifications.

The Exalt Communications EX-2.4i-16 employs QPSK, 16QAM & 64QAM modulation in the frequency ranges 2.400 to 2.4835 GHz.

The EX-2.4i-16 is identical to the EX-2.4i with the exception of the Interface PCB Assembly which has sixteen E1/T1 data tributaries (thus the -16 designation) as compared to the four found on the EX-2.4i version. As a result the test results used in this test report with the exception of the Radiated Emissions below 1 GHz are reproduced from the data used in test report EXLT01-A1 for the EX-2.4i.

**Exalt Communications Inc
Model EX-2.4i-16
2.4 GHz Point to Point Microwave Radio**



This test report may be reproduced in full only. The document may only be updated by MiCOM Labs personnel. Any changes will be noted in the Document History section of the report.

3.3. Equipment Model(s) and Serial Number(s)

EUT/ Support	Manufacturer	Equipment Description (Including Brand Name)	Model No.	Serial No.
EUT	Exalt Communications Inc	EX-2.4i-16 2.4 GHz Point to Point Fixed Link Radio	EX-2.4i-16	SM44060018
Support	Power supply	International Power Sources	CUP70-18 B2	70480-0000106
Support	IBM Laptop	Computer	2896-72U	FX-05793 -4/03
Support	IBM AC Adaptor	100-240VAC 50/60Hz	02K6749	ZJ1MN33631NN

Test Set-Up for Conducted Emissions

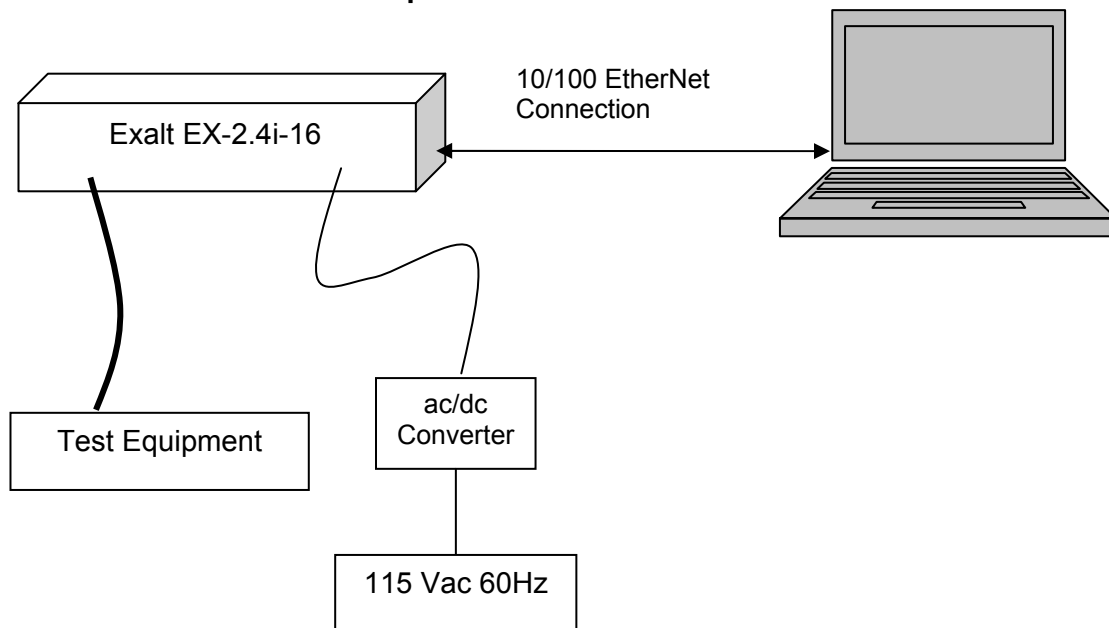

This test report may be reproduced in full only. The document may only be updated by MiCOM Labs personnel. Any changes will be noted in the Document History section of the report.



Title: Exalt EX-2.4i-16 Fixed Link Radio
To: FCC 47 CFR Part15.247 & IC RSS-210
Serial #: EXLT19-A1 Rev A
Issue Date: 28th Feb 2007
Page: 14 of 248

3.4. Antenna Details

Antenna Type	Gain (dBi)	Manufacturer	Model No.	Serial No.
Parabolic	21.3	Radio Waves	SP2-2.4	14734
Parabolic	30.3	Radio Waves	SP6-2.4NS	128434
Panel	20	Super Pass	SPAPG20	None

3.5. Cabling and I/O Ports

Number and type of I/O ports

1. E1/T1: 16 ports
2. Ethernet: 2 ports
3. Sync Interface: 2 ports (In and Out)
4. Alarm: 1 port
5. Console: 1 port
6. RSL test point: 2
7. RF: 1 port
8. DC Voltage Supply port: 1 port

This test report may be reproduced in full only. The document may only be updated by MiCOM Labs personnel. Any changes will be noted in the Document History section of the report.



3.6. Test Configurations

Matrix of test configurations

BW (MHz)	Modulation								
	QPSK			16QAM			64QAM		
	Low (MHz)	Mid (MHz)	High (MHz)	Low (MHz)	Mid (MHz)	High (MHz)	Low (MHz)	Mid (MHz)	High (MHz)
9	2406	2437	2468	2406	2437	2468	2406	2437	2468
18	2417	2437	2465	2417	2437	2465	2417	2437	2465
36	2426	2437	2455	2426	2437	2455	2426	2437	2455
72		2437			2437			2437	

Only worst case plots are provided for each test parameter are identified within this report. Plots not included are held on file by the test laboratory and available upon request with client permission.

3.7. Equipment Modifications

The following modifications were required to bring the equipment into compliance:

3.8. Deviations from the Test Standard

The following deviations from the test standard were required in order to complete the test program:

1. NONE



Title: Exalt EX-2.4i-16 Fixed Link Radio
To: FCC 47 CFR Part15.247 & IC RSS-210
Serial #: EXLT19-A1 Rev A
Issue Date: 28th Feb 2007
Page: 16 of 248

3.9. Subcontracted Testing or Third Party Data

Radiated emissions are tested below and verified above 1 GHz at TUV Rheinland of North America's 10m chamber located at the following address;-

2305 Mission College Blvd.
Santa Clara
California 95054
USA

TUV Rheinland of North America IC Registration Number: IC 4453-1

This test report may be reproduced in full only. The document may only be updated by MiCOM Labs personnel. Any changes will be noted in the Document History section of the report.



4. TEST SUMMARY

List of Measurements

The following table represents the list of measurements required under the **FCC CFR47 Part 15.247**, **Industry Canada RSS-210**, and **Industry Canada RSS-Gen**.

Section(s)	Test Items	Description	Condition	Result	Test Report Section
15.247(a)(2) 4.4	6 dB and 99 % Bandwidths	>=500 kHz	Conducted	Complies	5.1.1
15.247(b) 15.31(e) A8.4(4) 4.6	Peak Output Power Voltage Variation	Shall not exceed 1W Variation of supply voltage 85 % -115 %	Conducted	Complies	5.1.2
15.247(d) A8.2	Peak Power Spectral Density	Shall not be greater than +8 dBm in any 3 kHz band	Conducted	Complies	5.1.3
15.247(i)) RSS-102	Maximum Permissible Exposure	Exposure to radio frequency energy levels	Conducted	Complies	5.1.4
15.247(c) 15.205(a) / 15.209(a) A8.5 4.7	Spurious Emissions (30MHz - 26 GHz)	The radiated emission in any 100 kHz of out-band shall be at least 20 dB below the highest in-band spectral density	Conducted	Complies	5.1.5

This test report may be reproduced in full only. The document may only be updated by MiCOM Labs personnel. Any changes will be noted in the Document History section of the report.



List of Measurements (continued)

The following table represents the list of measurements required under the **FCC CFR47 Part 15.247**, **Industry Canada RSS-210**, and **Industry Canada RSS-Gen**.

Section(s)	Test Items	Description	Condition	Result	Test Report Section
15.247(c) 15.205(a) / 15.209(a) 2.2	Radiated Emissions	Restricted Bands Spurious Emissions Band edge	Radiated	Complies	5.1.6
2.6 4.7	Transmitter Radiated Spurious Emissions	Emissions above 1 GHz	Radiated	Complies	5.1.6.1
4.8	Receiver Radiated Spurious Emissions	Emissions above 1 GHz	Radiated	Complies	5.1.6.2
	Peak Field Strength	Peak emission from intentional radiator	Radiated	Complies	5.1.6.3
	Radiated Band Edge	Band edge results	Radiated	Complies	5.1.6.4
5.205(a) / 15.209(a) 2.2,	Radiated Spurious Emissions	Emissions <1 GHz (30M-1 GHz)	Radiated	Complies	5.1.6.5
15.207 7.2.2	AC Wireline Conducted Emissions 150 kHz–30 MHz	Conducted Emissions	Conducted	Complies	5.1.7

Note 1: Test results reported in this document relate only to the items tested

Note 2: The required tests demonstrated compliance as per client declaration of test configuration, monitoring methodology and associated pass/fail criteria

Note 3: Section 3.7 Equipment Modifications highlights the equipment modifications that were required to bring the product into compliance with the above test matrix

5. TEST RESULTS

5.1. Device Characteristics

5.1.1. 6 dB and 99 % Bandwidth

FCC, Part 15 Subpart C §15.247(a)(2)

Industry Canada RSS-Gen §4.4

Test Procedure

The bandwidth at 6 dB and 99 % is measured with a spectrum analyzer connected to the antenna terminal, while EUT is operating in transmission mode at the appropriate center frequency and maximum power. Using a 6 dB resolution bandwidth filter setting the spectrum analyzer was set to the following for both 6 dB BW and 99 % BW measurements;

Test Measurement Set up

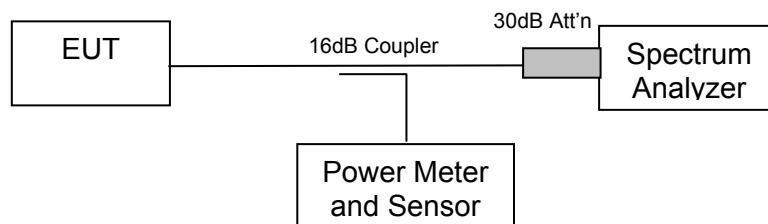

Measurement set up for 6 dB and 99 % bandwidth test



Title: Exalt EX-2.4i-16 Fixed Link Radio
To: FCC 47 CFR Part15.247 & IC RSS-210
Serial #: EXLT19-A1 Rev A
Issue Date: 28th Feb 2007
Page: 20 of 248

Measurement Results for 6 dB and 99 % Operational Bandwidth(s)

Ambient conditions.

Temperature: 19 to 26 °C Relative humidity: 31 to 57 % Pressure: 999 to 1009 mbar

9 MHz Bandwidth Test Results

TABLE OF RESULTS – 9 MHz Bandwidth QPSK Modulation

Center Frequency (MHz)	6 dB Bandwidth (MHz)	6 dB Plot #	99 % BW (MHz)	99 % BW Plots
2,406	8.4769	1	10.1703	2
2,437	8.4168	On File	9.1182	On File
2,468	8.4769	On File	9.0180	On File

Plot 1
2,406 MHz 6 dB Bandwidth 9 MHz QPSK

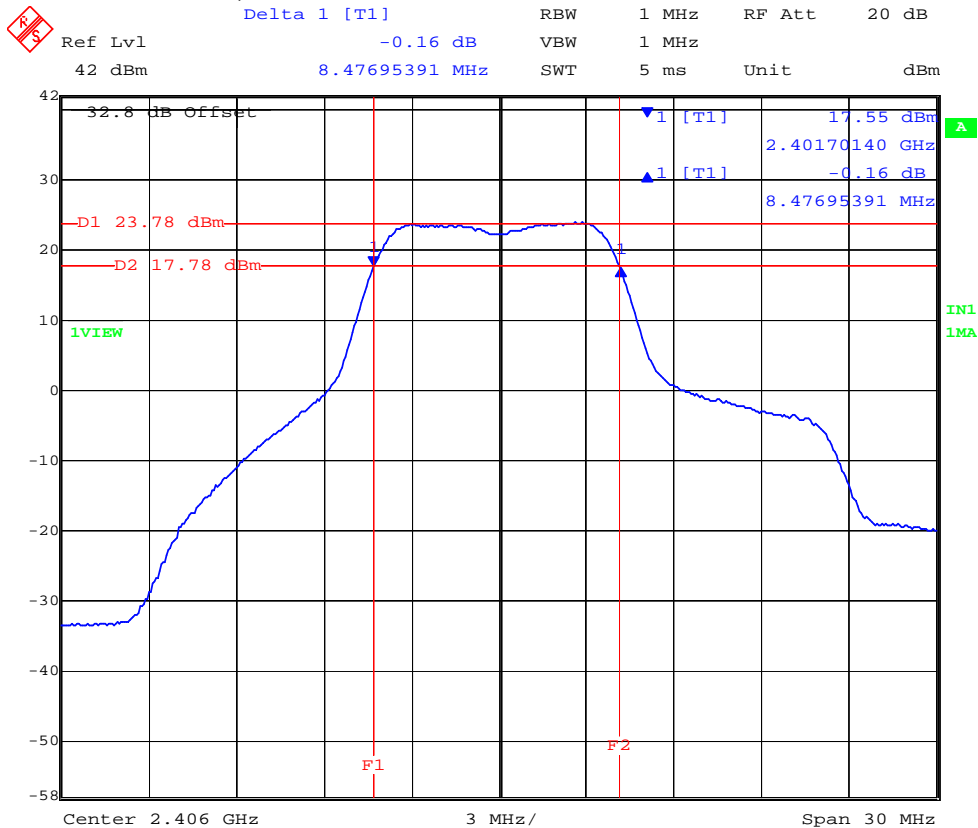

Date: 28.OCT.2005 14:52:01

This test report may be reproduced in full only. The document may only be updated by MiCOM Labs personnel. Any changes will be noted in the Document History section of the report.



Title: Exalt EX-2.4i-16 Fixed Link Radio
To: FCC 47 CFR Part15.247 & IC RSS-210
Serial #: EXLT19-A1 Rev A
Issue Date: 28th Feb 2007
Page: 21 of 248

Plot 2

2,406 MHz 99% Bandwidth 9 MHz QPSK

 **Marker 1 [T1]** RBW 1 MHz RF Att 20 dB
Ref Lvl 23.83 dBm VBW 1 MHz
42 dBm 2.40878056 GHz SWT 5 ms Unit dBm

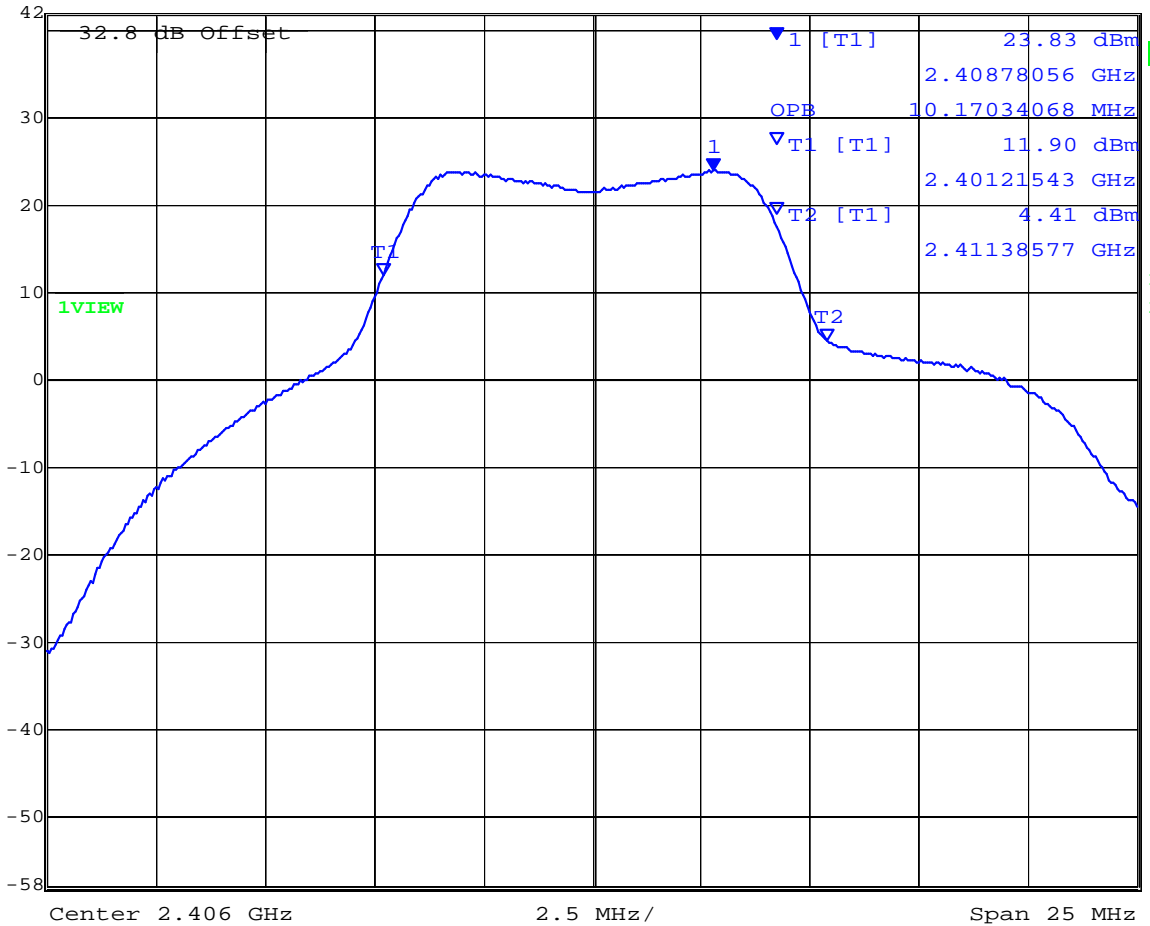

Date: 28.OCT.2005 13:47:02

This test report may be reproduced in full only. The document may only be updated by MiCOM Labs personnel. Any changes will be noted in the Document History section of the report.



Title: Exalt EX-2.4i-16 Fixed Link Radio
To: FCC 47 CFR Part15.247 & IC RSS-210
Serial #: EXLT19-A1 Rev A
Issue Date: 28th Feb 2007
Page: 22 of 248

TABLE OF RESULTS – 9 MHz Bandwidth 16QAM Modulation

Center Frequency (MHz)	6 dB Bandwidth (MHz)	6 dB Plot #	99 % BW (MHz)	99 % BW Plots
2,406	8.4769	3	9.8697	4
2,437	8.4168	On File	9.2685	On File
2,468	8.4769	On File	9.1182	On File

**Plot 3
2,406 MHz 6 dB Bandwidth 9 MHz 16QAM**

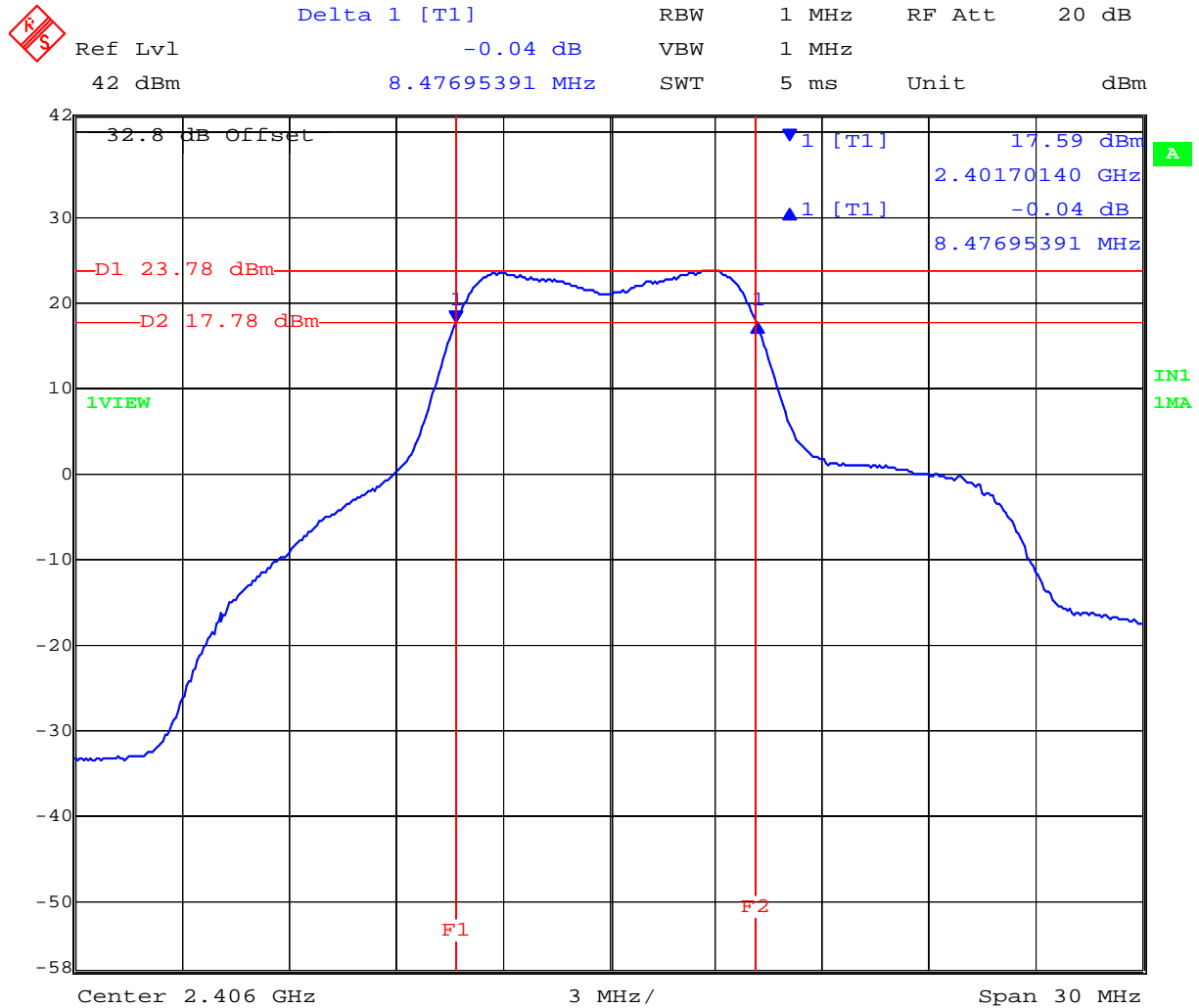

Date: 28.OCT.2005 14:51:29

This test report may be reproduced in full only. The document may only be updated by MiCOM Labs personnel. Any changes will be noted in the Document History section of the report.



Title: Exalt EX-2.4i-16 Fixed Link Radio
To: FCC 47 CFR Part15.247 & IC RSS-210
Serial #: EXLT19-A1 Rev A
Issue Date: 28th Feb 2007
Page: 23 of 248

Plot 4
2,406 MHz 99% Bandwidth 9 MHz 16QAM

 Marker 1 [T1] RBW 1 MHz RF Att 20 dB
 Ref Lvl 23.72 dBm VBW 1 MHz
 42 dBm 2.40878056 GHz SWT 5 ms Unit dBm

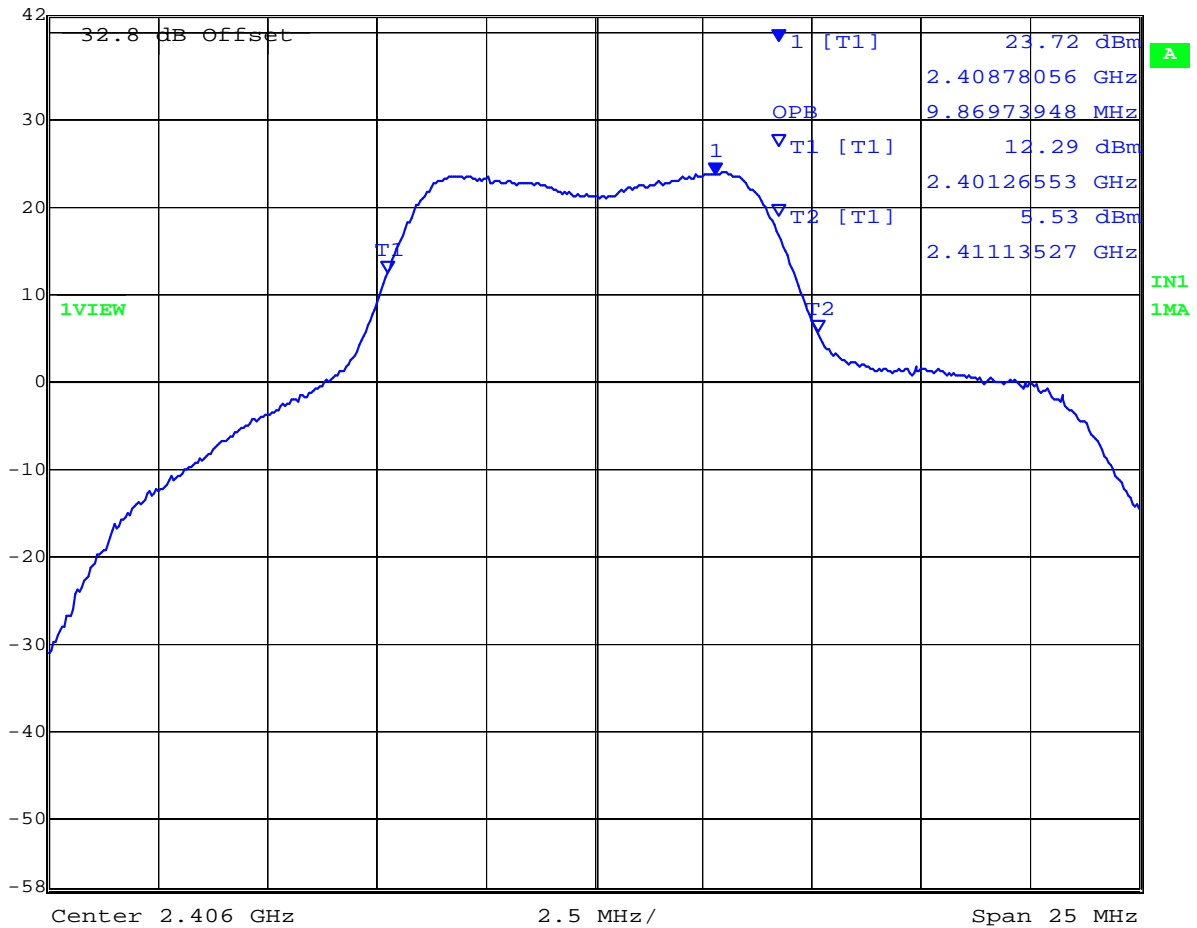

Date: 28.OCT.2005 13:47:39

This test report may be reproduced in full only. The document may only be updated by MiCOM Labs personnel. Any changes will be noted in the Document History section of the report.



Title: Exalt EX-2.4i-16 Fixed Link Radio
To: FCC 47 CFR Part15.247 & IC RSS-210
Serial #: EXLT19-A1 Rev A
Issue Date: 28th Feb 2007
Page: 24 of 248

TABLE OF RESULTS – 9 MHz Bandwidth 64QAM Modulation

Center Frequency (MHz)	6 dB Bandwidth (MHz)	6 dB Plot #	99 % BW (MHz)	99 % BW Plots
2,406	8.5371	5	10.1703	6
2,437	8.5371	On File	9.8697	On File
2,468	8.4769	On File	9.1683	On File

Plot 5
2,406 MHz 6 dB Bandwidth 9 MHz 64QAM

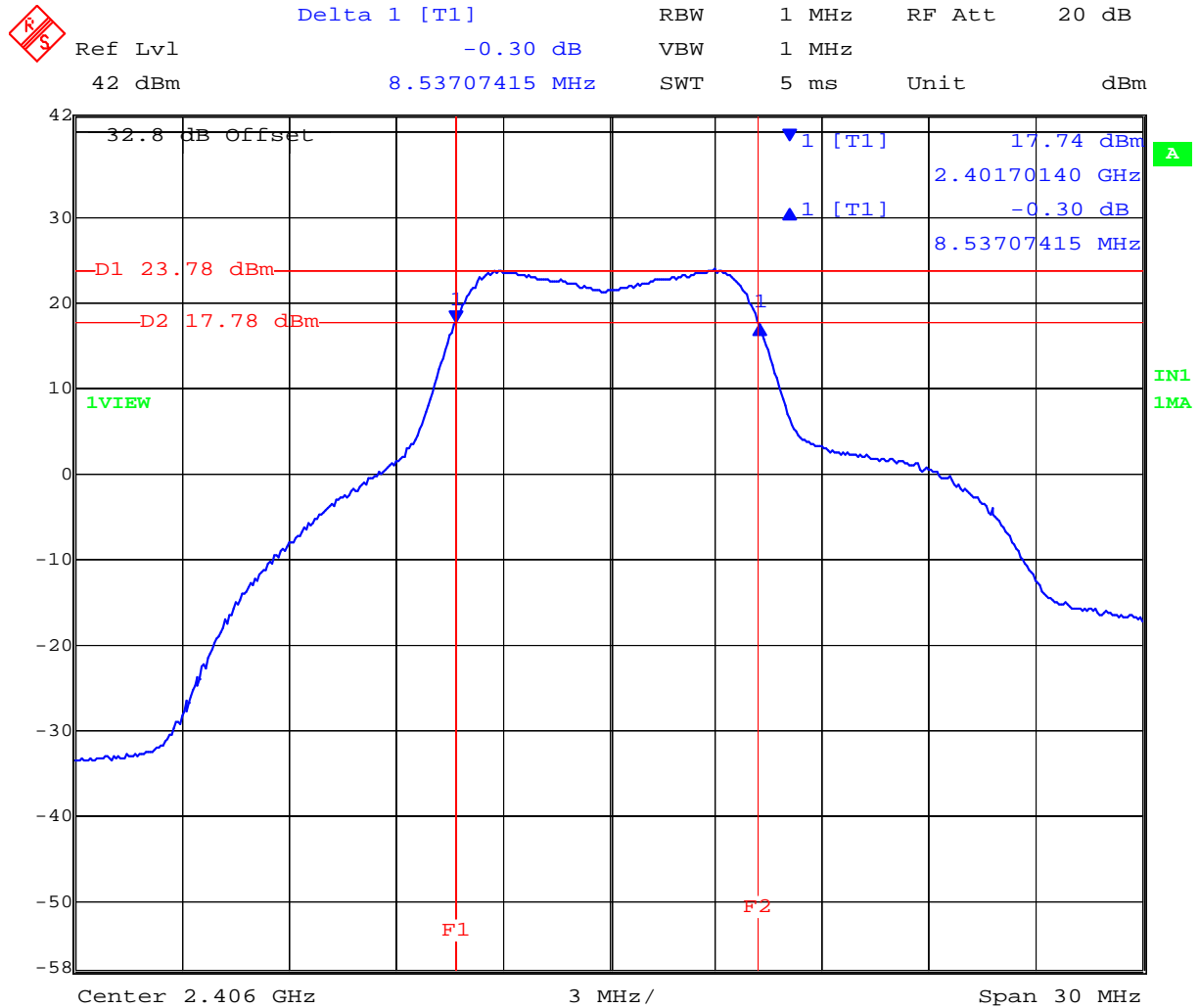

Date: 28.OCT.2005 14:50:24

This test report may be reproduced in full only. The document may only be updated by MiCOM Labs personnel. Any changes will be noted in the Document History section of the report.



Title: Exalt EX-2.4i-16 Fixed Link Radio
To: FCC 47 CFR Part15.247 & IC RSS-210
Serial #: EXLT19-A1 Rev A
Issue Date: 28th Feb 2007
Page: 25 of 248

Plot 6
2,406 MHz 99% Bandwidth 9 MHz 64QAM

Marker 1 [T1] RBW 1 MHz RF Att 20 dB
Ref Lvl 23.67 dBm VBW 1 MHz
42 dBm 2.40878056 GHz SWT 5 ms Unit dBm

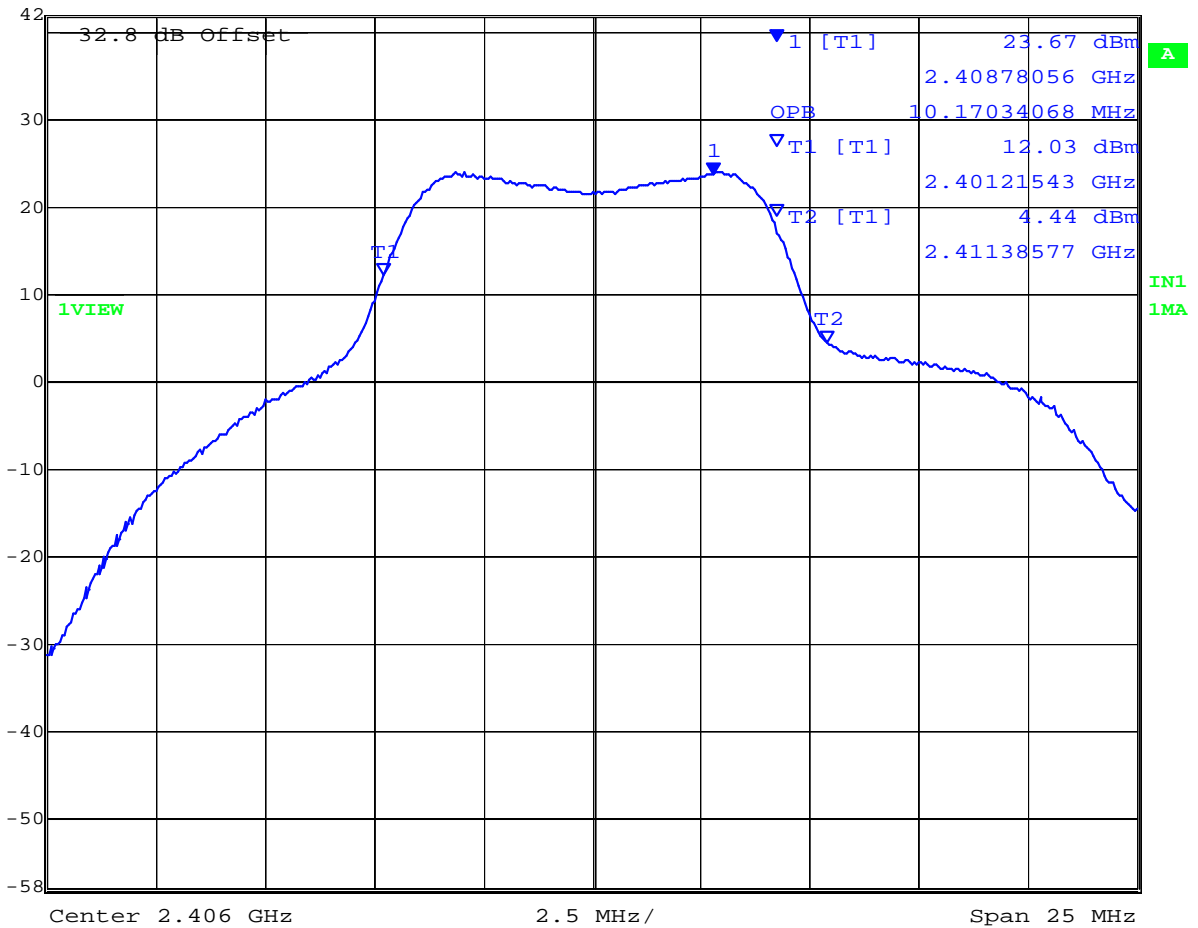

Date: 28.OCT.2005 13:48:26

This test report may be reproduced in full only. The document may only be updated by MiCOM Labs personnel. Any changes will be noted in the Document History section of the report.



18MHz Bandwidth Test Results

TABLE OF RESULTS – 18 MHz Bandwidth QPSK Modulation

Center Frequency (MHz)	6 dB Bandwidth (MHz)	6 dB Plot #	99 % BW (MHz)	99 % BW Plots
2,417	15.3307	7	16.4329	On File
2,437	15.3307	On File	17.3347	8
2,465	15.3307	On File	17.0341	On File

Plot 7
2,417 MHz 6 dB Bandwidth 18 MHz QPSK

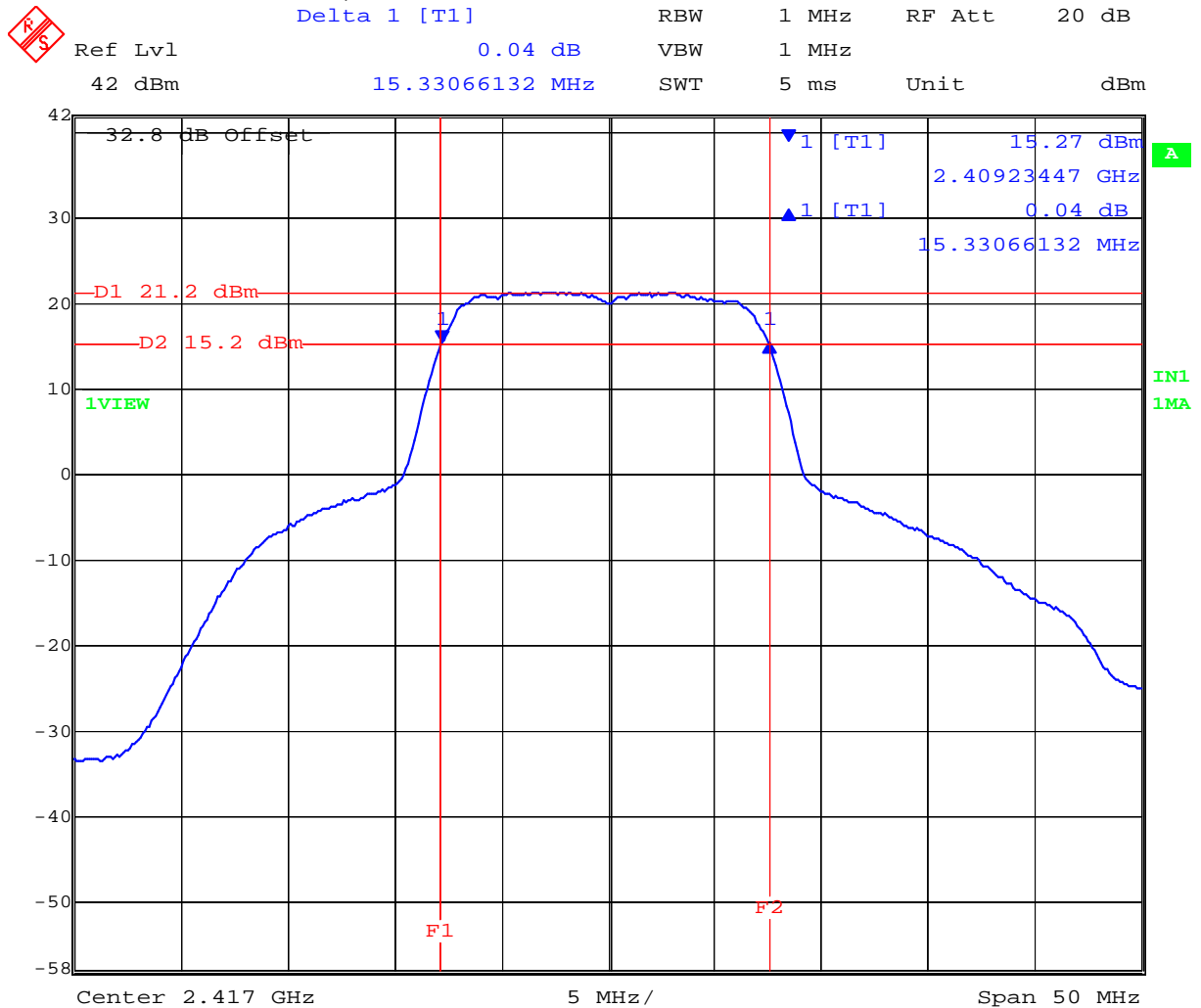

Date: 28.OCT.2005 14:54:20

This test report may be reproduced in full only. The document may only be updated by MiCOM Labs personnel. Any changes will be noted in the Document History section of the report.



Plot 8
2,437 MHz 99% Bandwidth 18 MHz QPSK

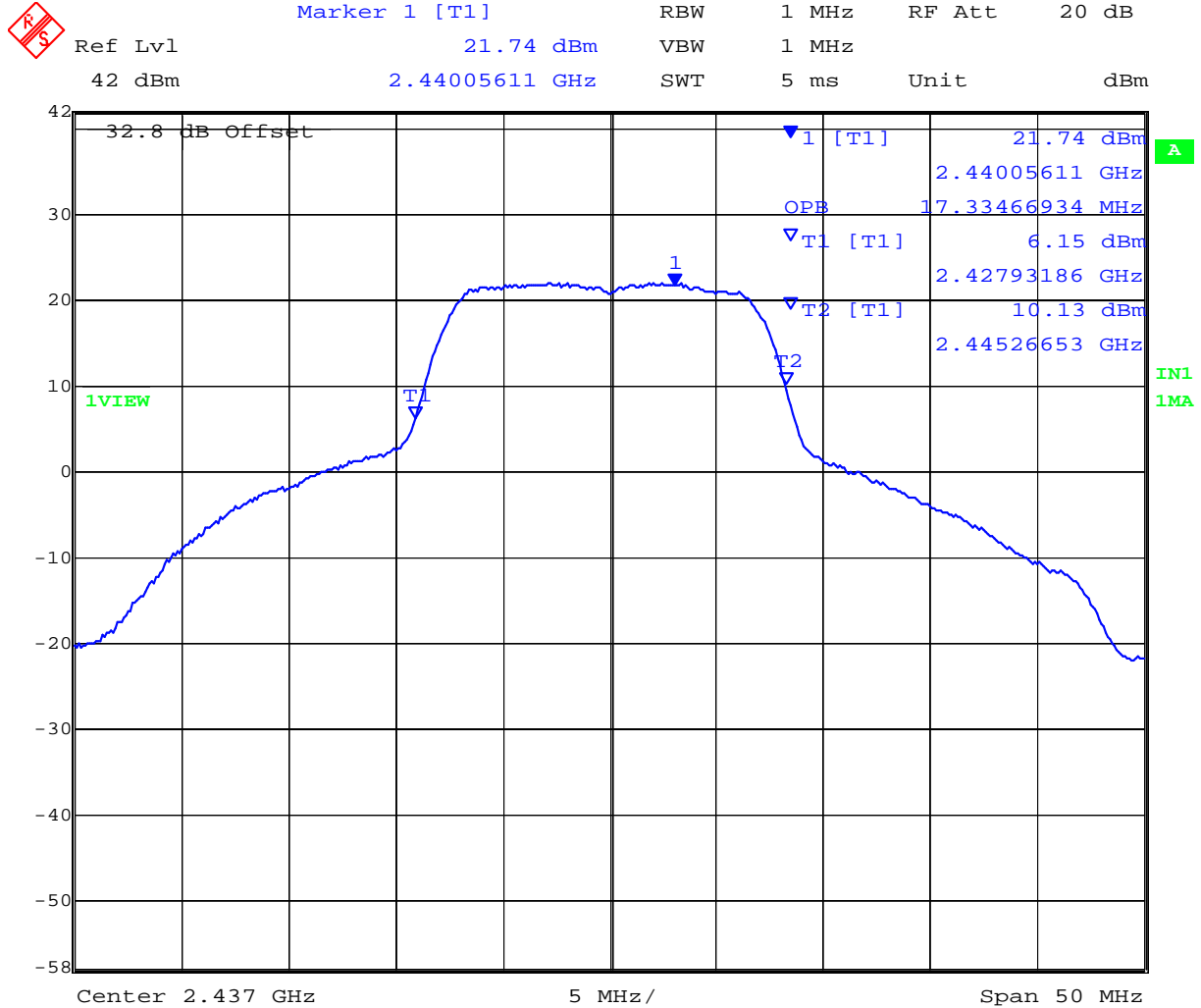

Date: 28.OCT.2005 14:00:53

This test report may be reproduced in full only. The document may only be updated by MiCOM Labs personnel. Any changes will be noted in the Document History section of the report.



TABLE OF RESULTS – 18 MHz Bandwidth 16QAM Modulation

Center Frequency (MHz)	6 dB Bandwidth (MHz)	6 dB Plot #	99 % BW (MHz)	99 % BW Plots
2,417	15.7315	9	16.7335	On File
2,437	15.6313	On File	19.0381	10
2,465	15.4309	On File	18.4369	On File

Plot 9
2,417 MHz 6 dB Bandwidth 18 MHz 16QAM

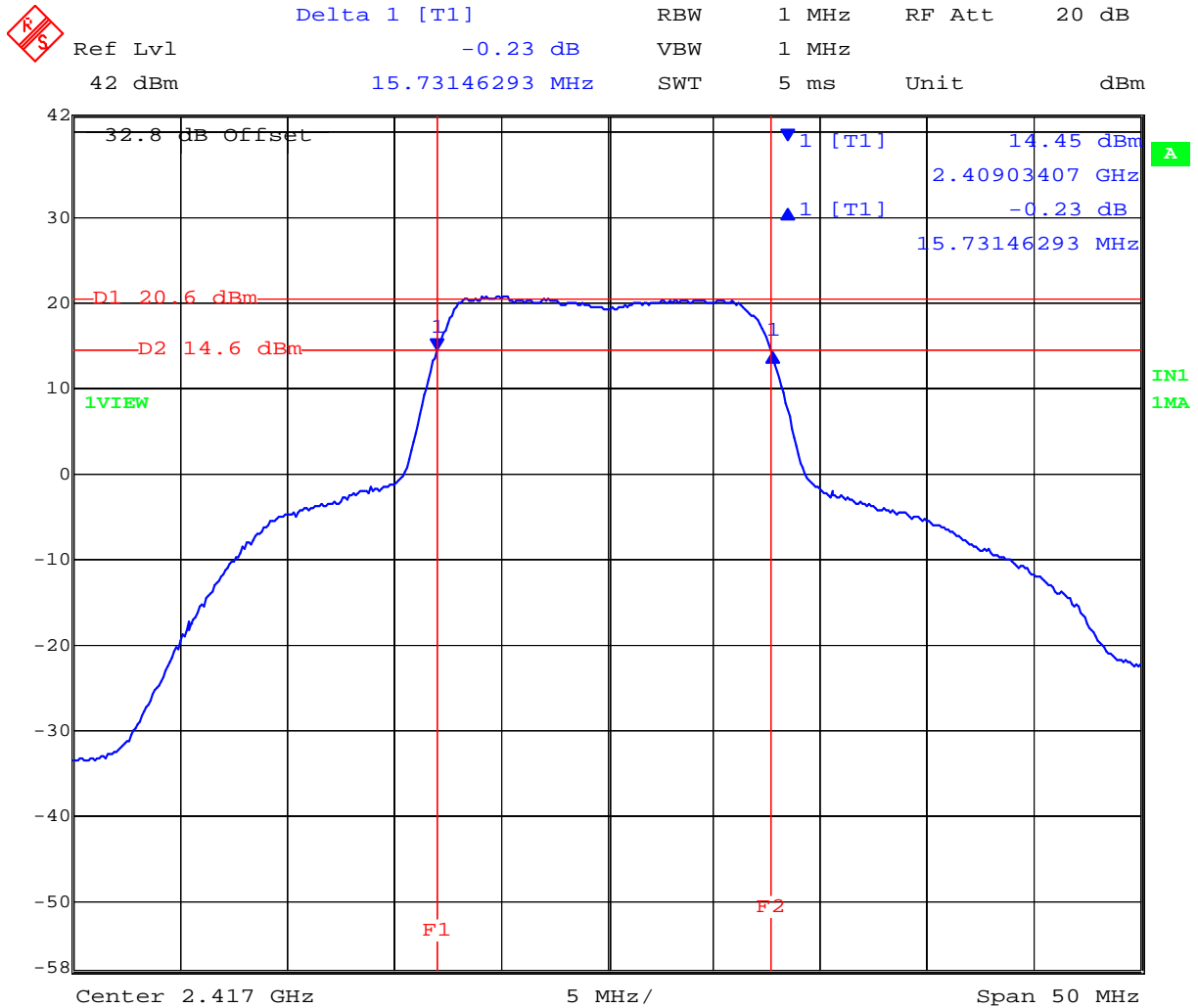

Date: 28.OCT.2005 14:55:48

This test report may be reproduced in full only. The document may only be updated by MiCOM Labs personnel. Any changes will be noted in the Document History section of the report.



Title: Exalt EX-2.4i-16 Fixed Link Radio
To: FCC 47 CFR Part15.247 & IC RSS-210
Serial #: EXLT19-A1 Rev A
Issue Date: 28th Feb 2007
Page: 29 of 248

Plot 10

2,437 MHz 99% Bandwidth 18 MHz 16QAM

 Marker 1 [T1] RBW 1 MHz RF Att 20 dB
Ref Lvl 20.79 dBm VBW 1 MHz
42 dBm 2.44005611 GHz SWT 5 ms Unit dBm

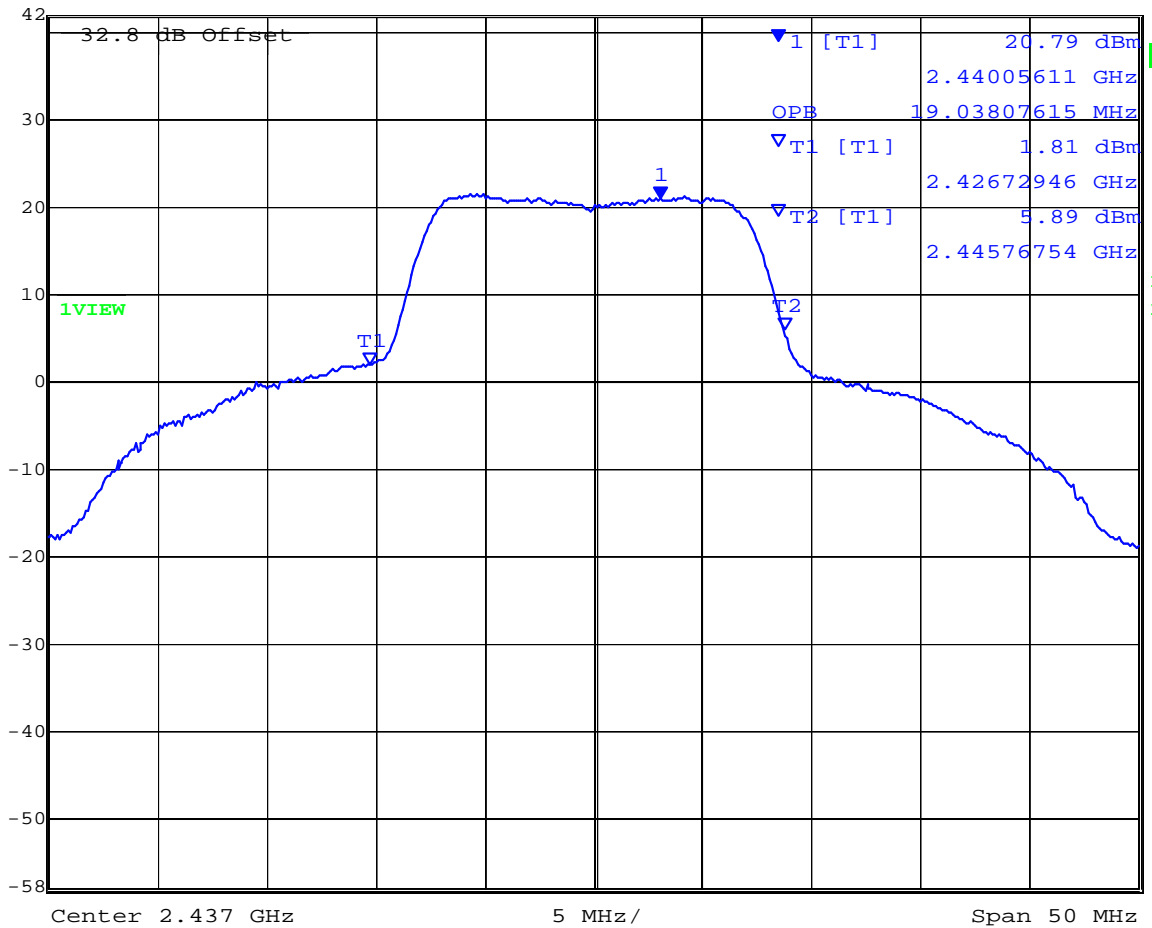

Date: 28.OCT.2005 14:01:40

This test report may be reproduced in full only. The document may only be updated by MiCOM Labs personnel. Any changes will be noted in the Document History section of the report.



TABLE OF RESULTS – 18 MHz Bandwidth 64QAM Modulation

Center Frequency (MHz)	6 dB Bandwidth (MHz)	6 dB Plot #	99 % BW (MHz)	99 % BW Plots
2,417	15.6313	On File	17.1343	On File
2,437	15.8317	11	20.2405	12
2,465	15.6313	On File	19.3387	On File

Plot 11
2,437 MHz 6 dB Bandwidth 18 MHz 64QAM

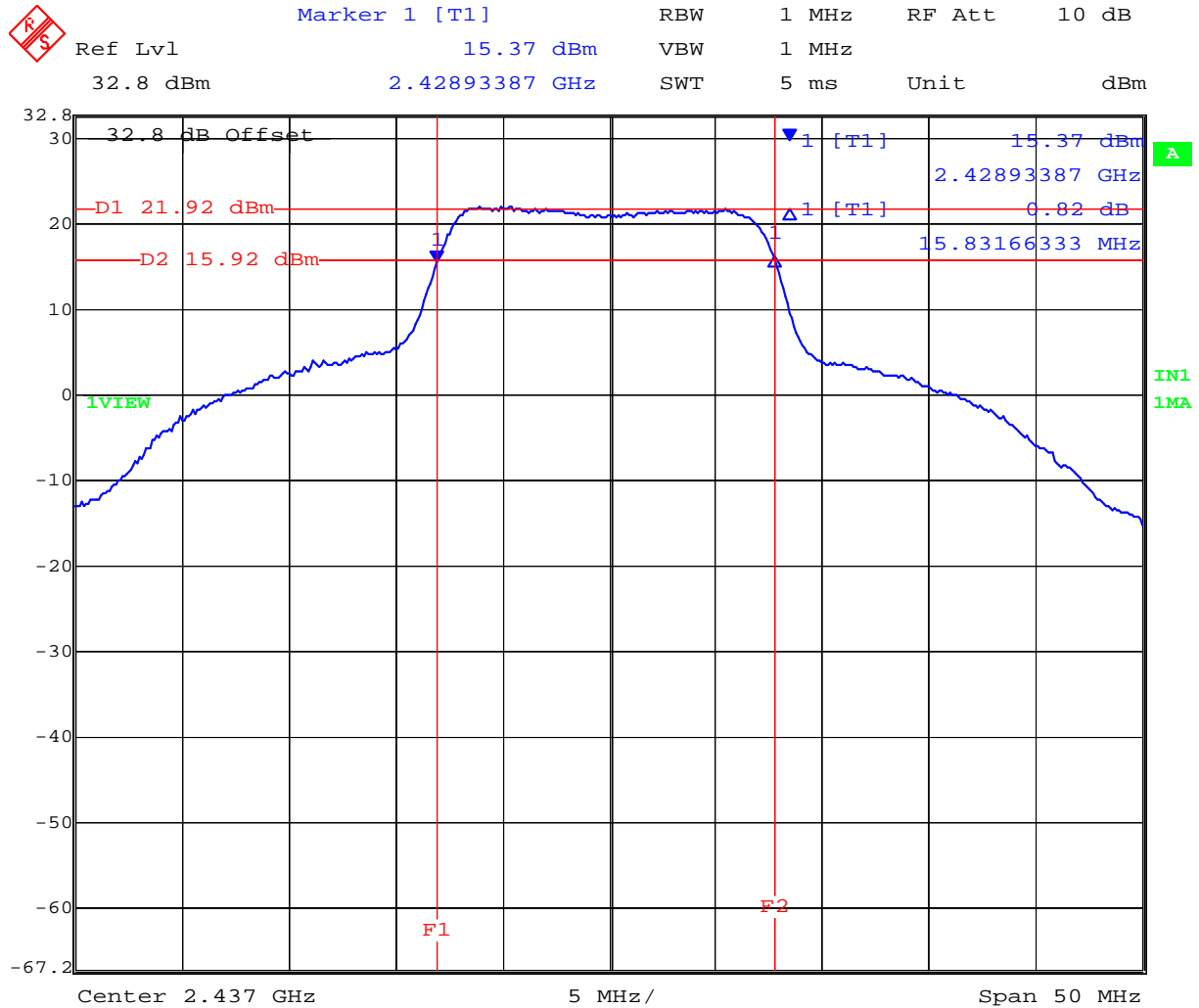

Date: 28.OCT.2005 11:13:47

This test report may be reproduced in full only. The document may only be updated by MiCOM Labs personnel. Any changes will be noted in the Document History section of the report.



Plot 12

2,437 MHz 99% Bandwidth 18 MHz 64QAM

 Ref Lvl 42 dBm
Marker 1 [T1] 20.52 dBm
2.44005611 GHz
RBW 1 MHz
RF Att 20 dB
VBW 1 MHz
SWT 5 ms
Unit dBm

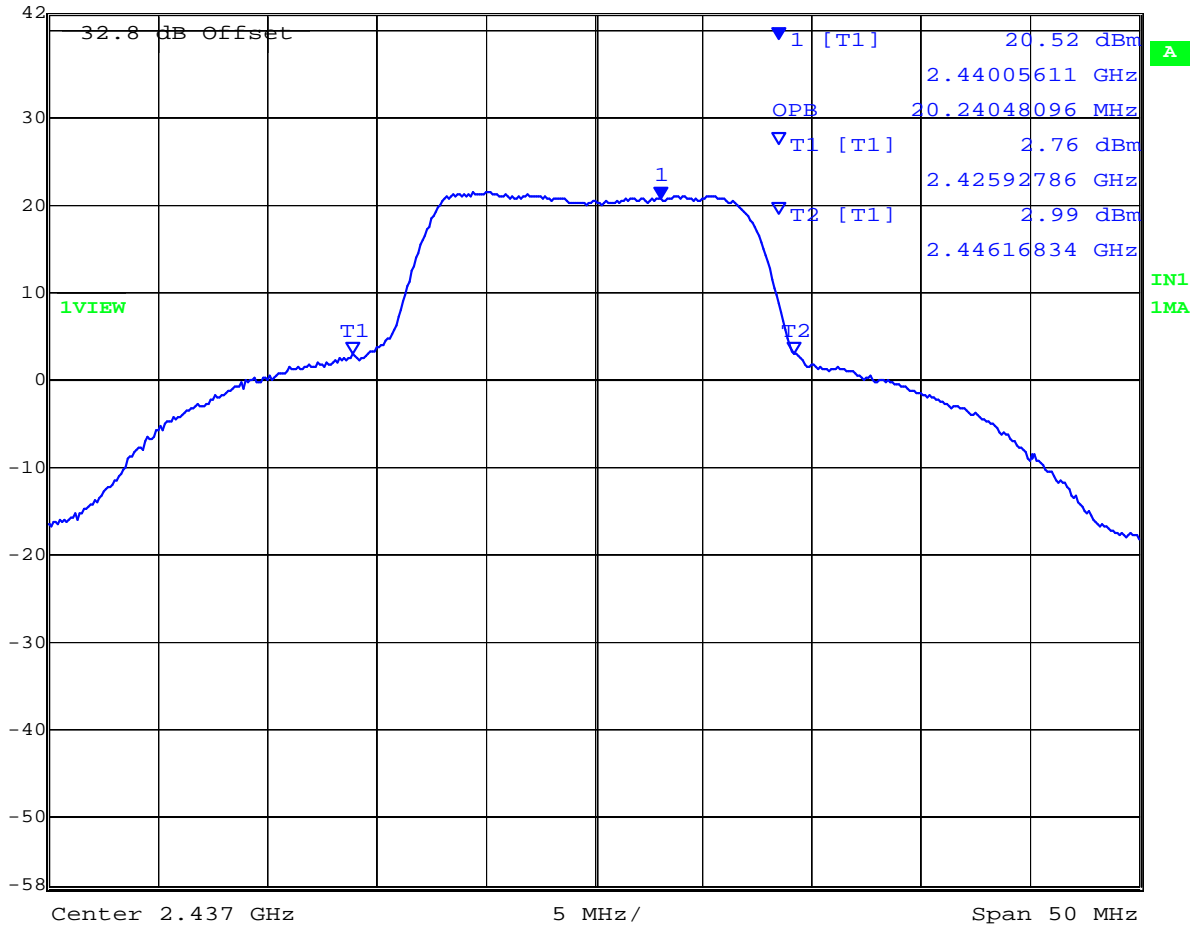

Date: 28.OCT.2005 14:02:17

This test report may be reproduced in full only. The document may only be updated by MiCOM Labs personnel. Any changes will be noted in the Document History section of the report.



36MHz Bandwidth Test Results

TABLE OF RESULTS – 36 MHz Bandwidth QPSK Modulation

Center Frequency (MHz)	6 dB Bandwidth (MHz)	6 dB Plot #	99 % BW (MHz)	99 % BW Plots
2,426	30.8617	13	34.6693	14
2,437	30.8617	On File	32.4649	On File
2,455	30.6613	On File	32.2645	On File

Plot 13
2,426 MHz 6 dB Bandwidth 36 MHz QPSK

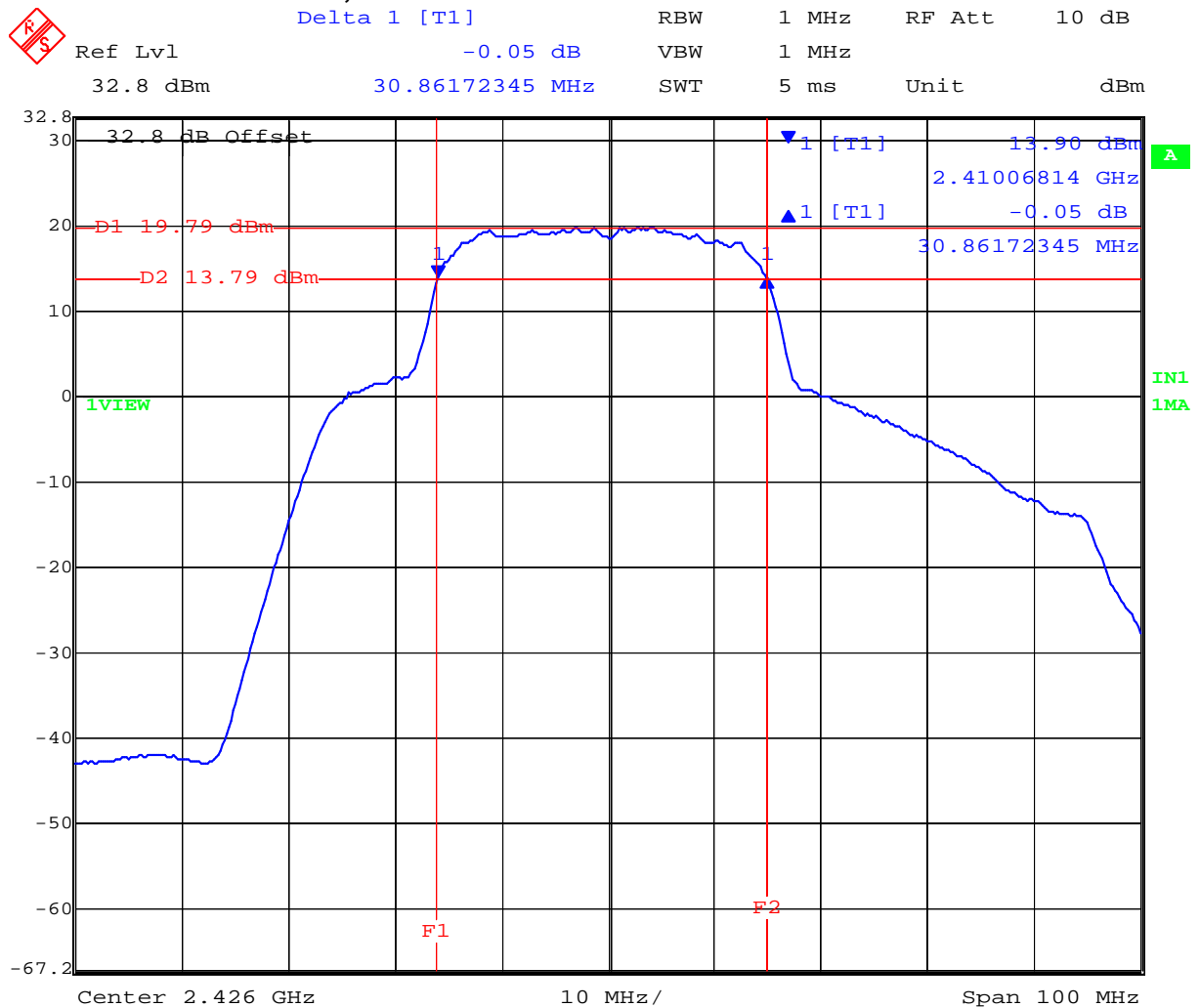

Date: 28.OCT.2005 12:15:24

This test report may be reproduced in full only. The document may only be updated by MiCOM Labs personnel. Any changes will be noted in the Document History section of the report.



Plot 14
2,426 MHz 99% Bandwidth 36 MHz QPSK

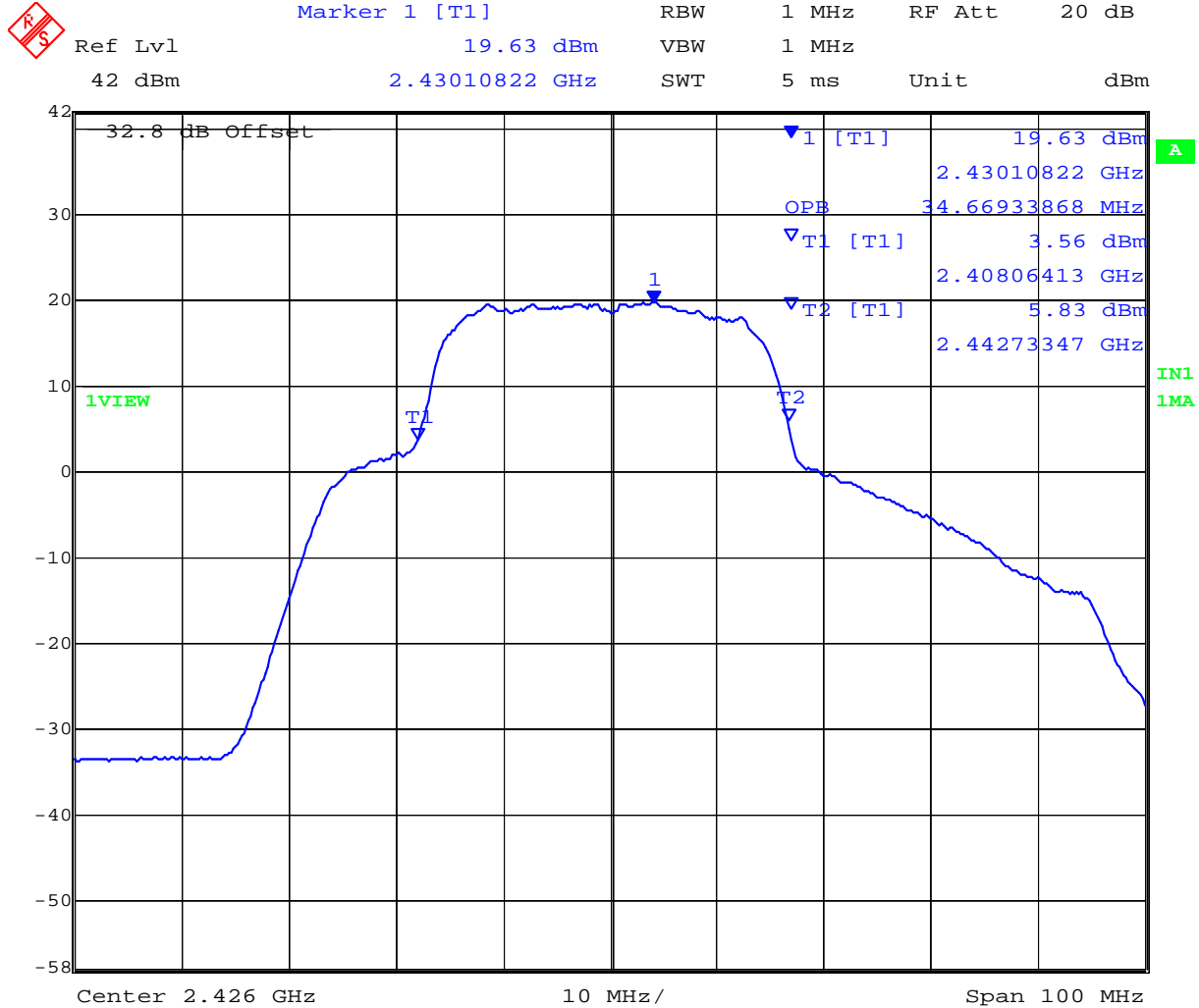

Date: 28.OCT.2005 14:14:34

This test report may be reproduced in full only. The document may only be updated by MiCOM Labs personnel. Any changes will be noted in the Document History section of the report.



TABLE OF RESULTS – 36 MHz Bandwidth 16QAM Modulation

Center Frequency (MHz)	6 dB Bandwidth (MHz)	6 dB Plot #	99 % BW (MHz)	99 % BW Plots
2,426	31.4629	15	36.0721	16
2,437	31.0621	On File	33.0661	On File
2,455	30.6613	On File	33.2665	On File

Plot 15
2,426 MHz 6 dB Bandwidth 36 MHz 16QAM

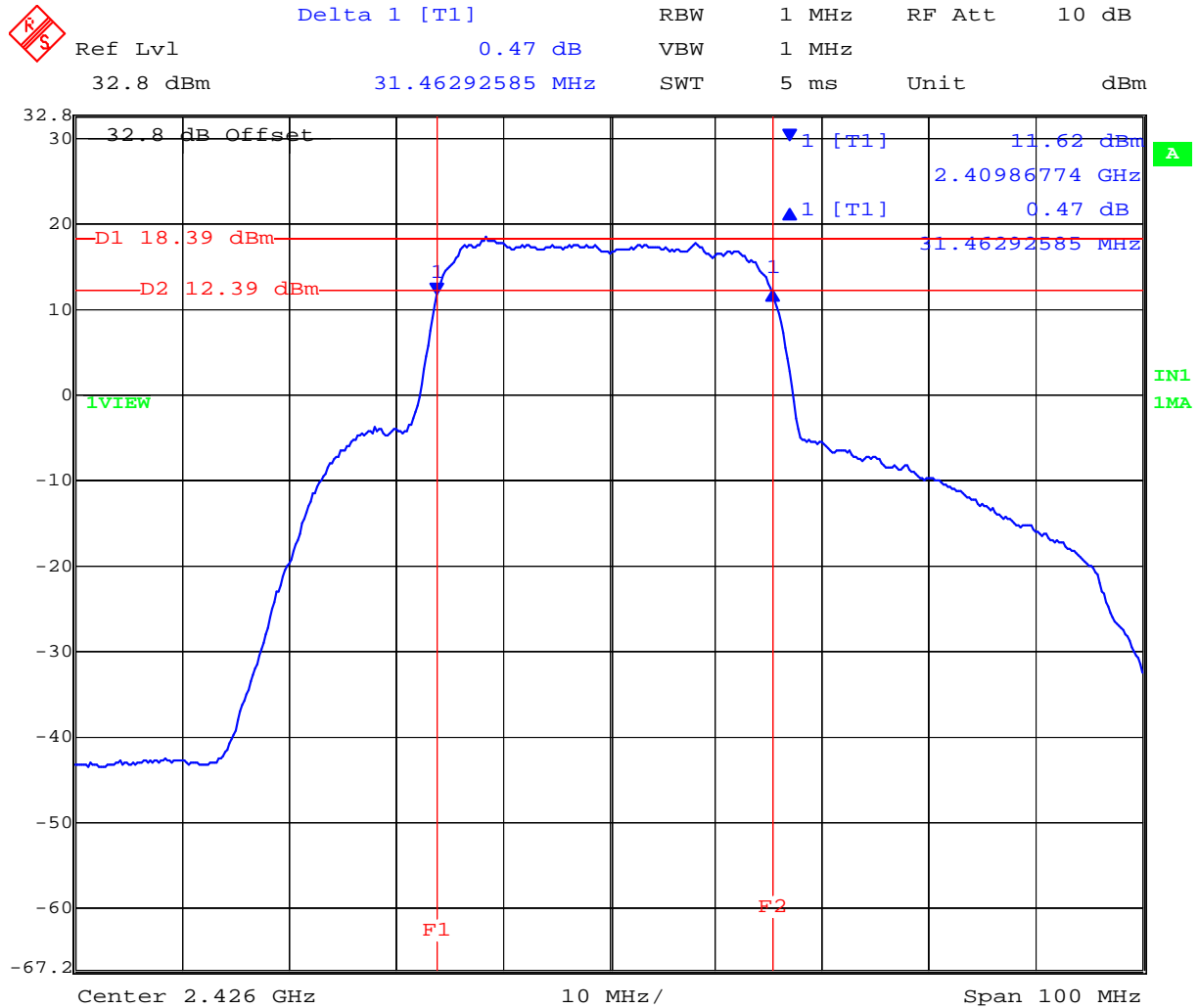

Date: 28.OCT.2005 12:22:00

This test report may be reproduced in full only. The document may only be updated by MiCOM Labs personnel. Any changes will be noted in the Document History section of the report.



Title: Exalt EX-2.4i-16 Fixed Link Radio
To: FCC 47 CFR Part15.247 & IC RSS-210
Serial #: EXLT19-A1 Rev A
Issue Date: 28th Feb 2007
Page: 35 of 248

Plot 16

2,426 MHz 99% Bandwidth 36 MHz 16QAM

Marker 1 [T1] RBW 1 MHz RF Att 20 dB
 Ref Lvl 42 dBm 18.52 dBm VBW 1 MHz
 2.43010822 GHz SWT 5 ms Unit dBm

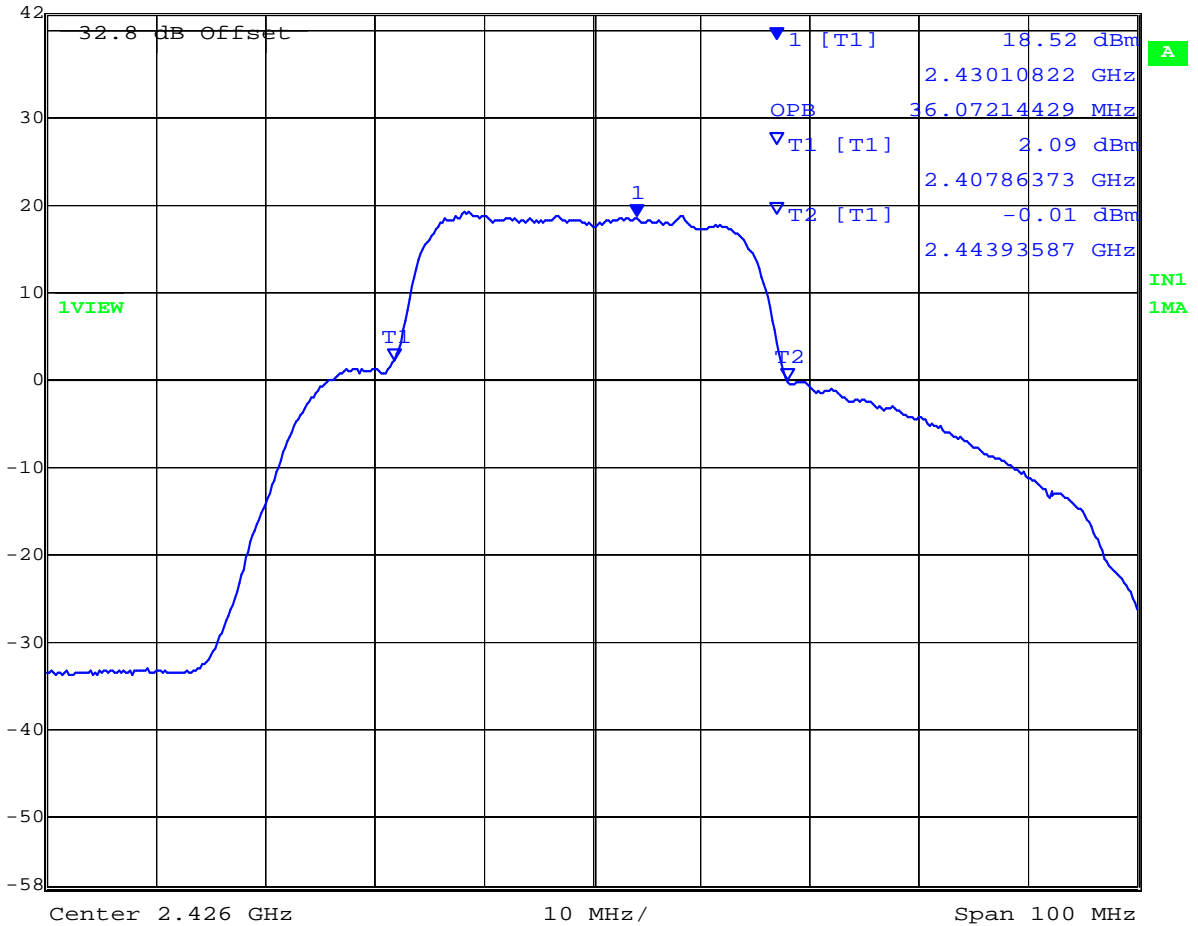

Date: 28.OCT.2005 14:15:13

This test report may be reproduced in full only. The document may only be updated by MiCOM Labs personnel. Any changes will be noted in the Document History section of the report.



Title: Exalt EX-2.4i-16 Fixed Link Radio
To: FCC 47 CFR Part15.247 & IC RSS-210
Serial #: EXLT19-A1 Rev A
Issue Date: 28th Feb 2007
Page: 36 of 248

TABLE OF RESULTS – 36 MHz Bandwidth 64QAM Modulation

Center Frequency (MHz)	6 dB Bandwidth (MHz)	6 dB Plot #	99 % BW (MHz)	99 % BW Plots
2,426	31.8637	17	38.0761	18
2,437	31.4629	On File	36.6733	On File
2,455	31.8637	On File	33.2665	On File

Plot 17
2,426 MHz 6 dB Bandwidth 36 MHz 64QAM

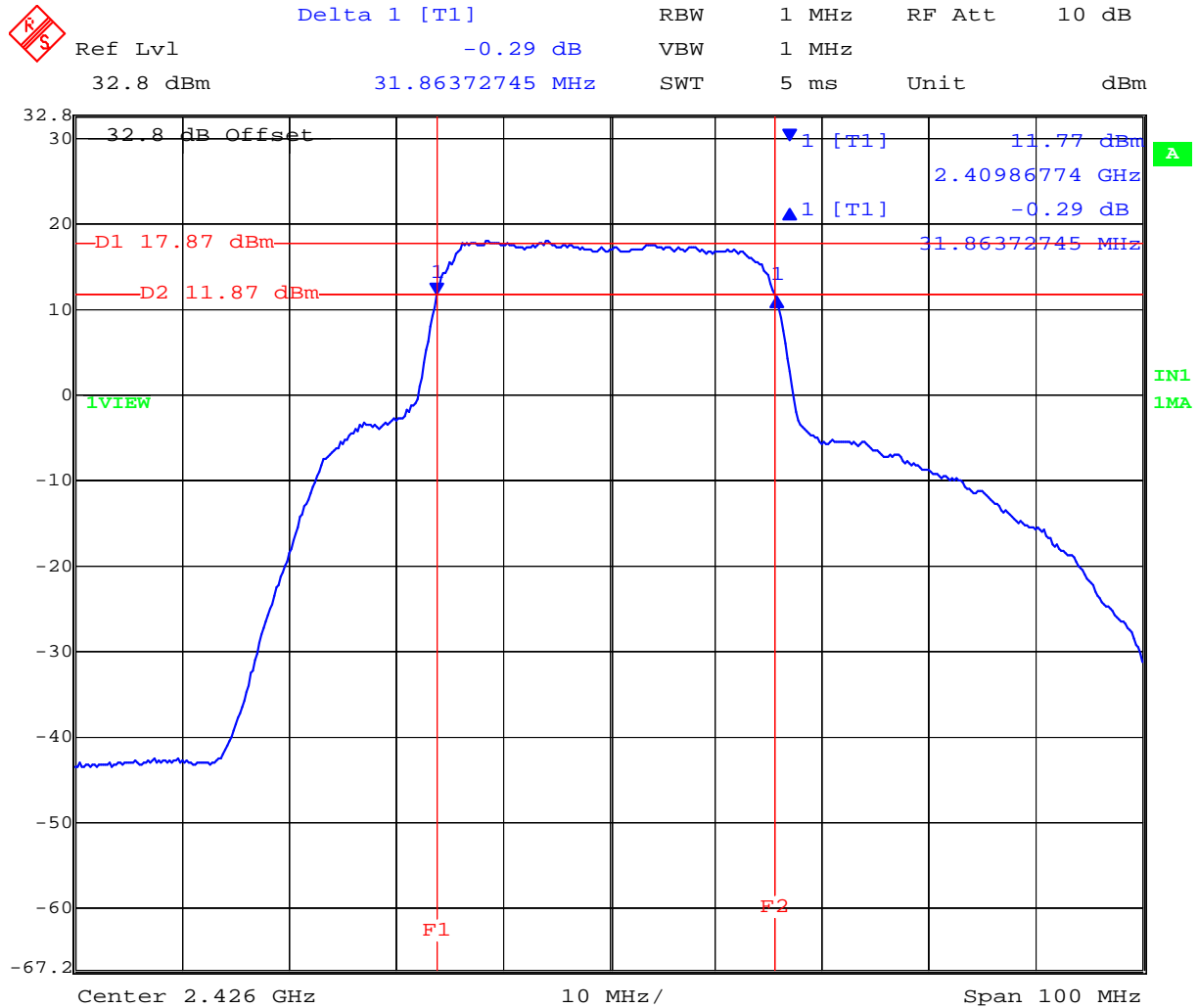

Date: 28.OCT.2005 12:23:46

This test report may be reproduced in full only. The document may only be updated by MiCOM Labs personnel. Any changes will be noted in the Document History section of the report.



Title: Exalt EX-2.4i-16 Fixed Link Radio
To: FCC 47 CFR Part15.247 & IC RSS-210
Serial #: EXLT19-A1 Rev A
Issue Date: 28th Feb 2007
Page: 37 of 248

Plot 18

2,426 MHz 99% Bandwidth 36 MHz 64QAM

Marker 1 [T1] RBW 1 MHz RF Att 20 dB
 Ref Lvl 18.64 dBm VBW 1 MHz
 42 dBm 2.43010822 GHz SWT 5 ms Unit dBm

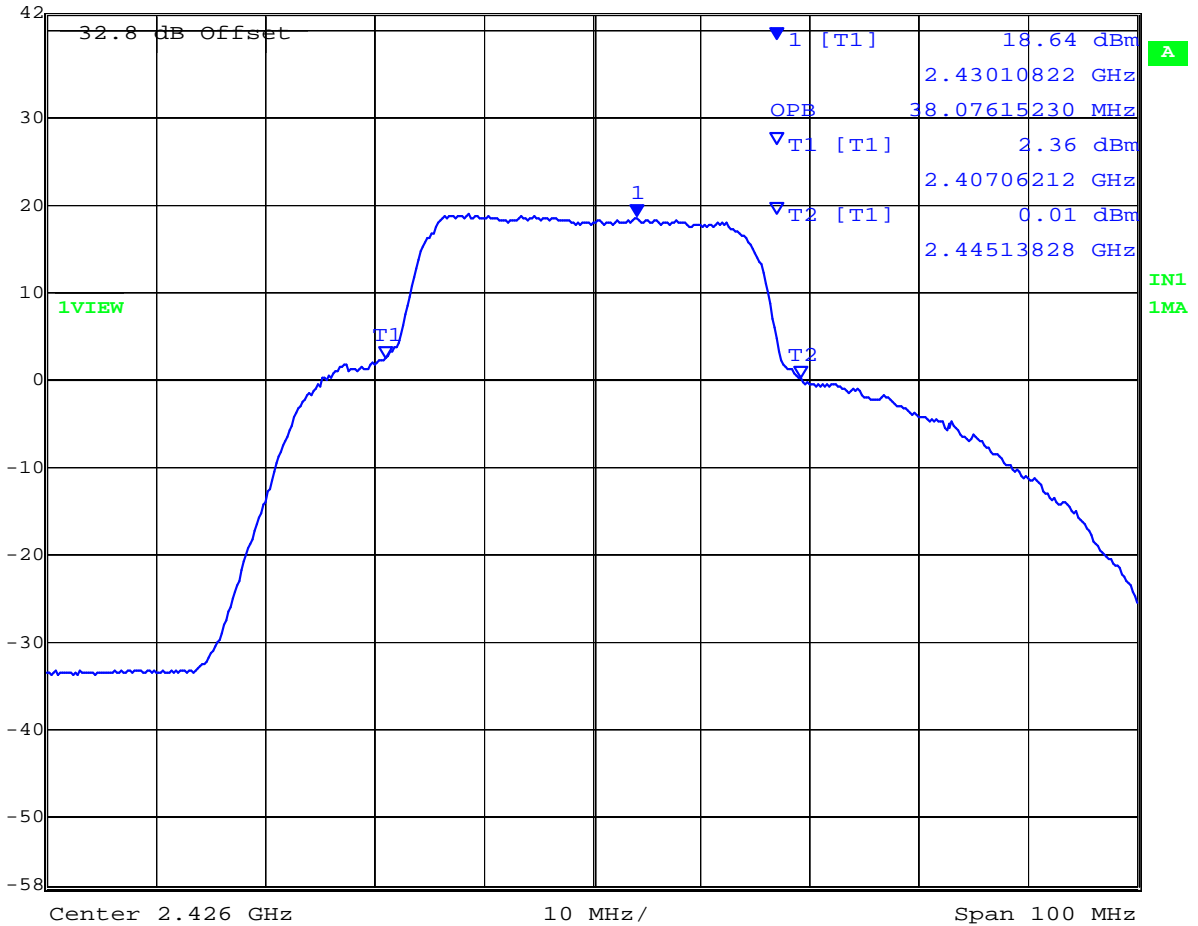

Date: 28.OCT.2005 14:15:55

This test report may be reproduced in full only. The document may only be updated by MiCOM Labs personnel. Any changes will be noted in the Document History section of the report.



72MHz Bandwidth Test Results

TABLE OF RESULTS – 72 MHz Bandwidth QPSK Modulation

Center Frequency (MHz)	6 dB Bandwidth (MHz)	6 dB Plot #	99 % BW (MHz)	99 % BW Plots
2,437	54.3086	19	60.7214	20

Plot 19
2,437 MHz 6 dB Bandwidth 72 MHz QPSK

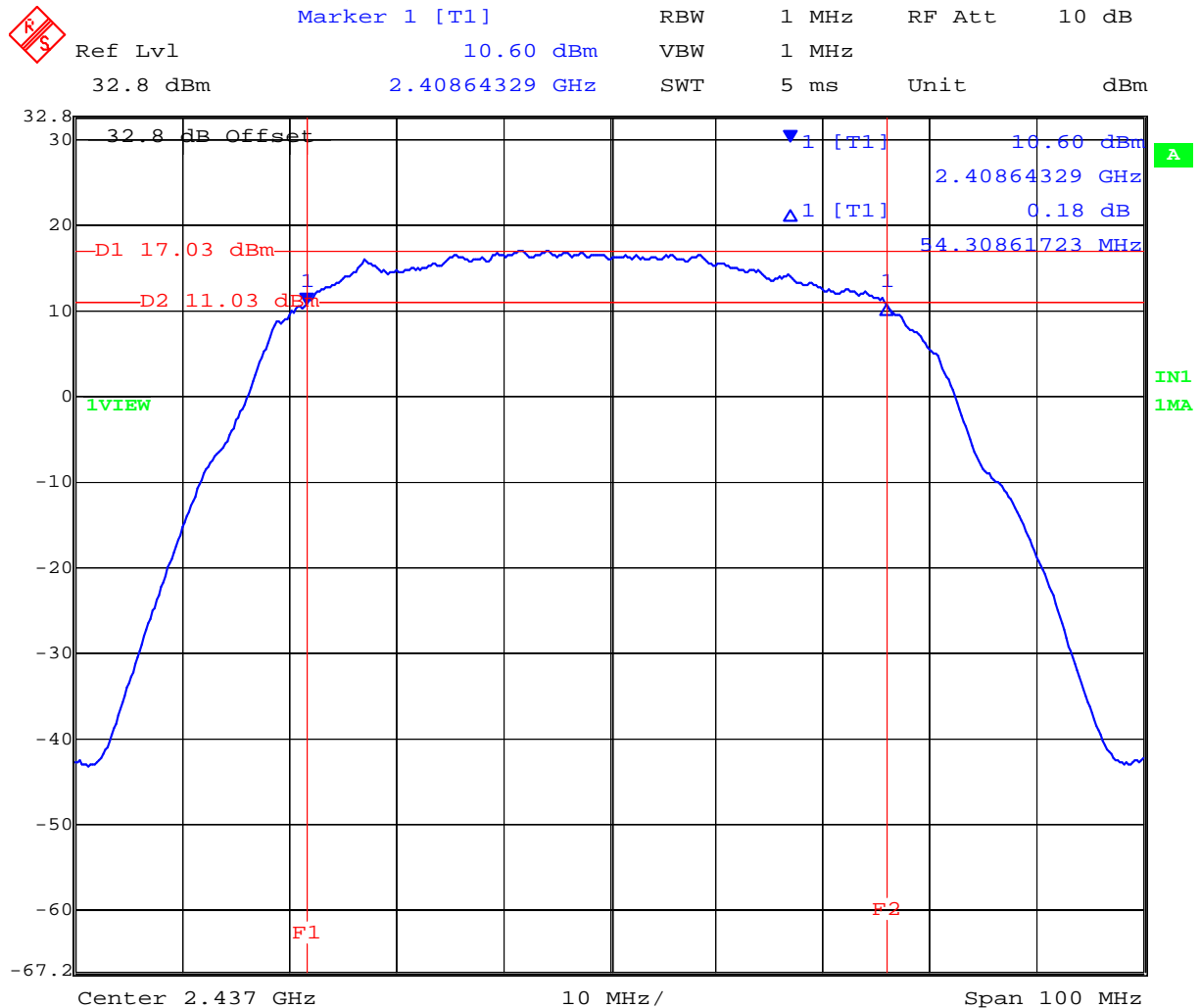

Date: 28.OCT.2005 10:48:10

This test report may be reproduced in full only. The document may only be updated by MiCOM Labs personnel. Any changes will be noted in the Document History section of the report.



Plot 20
2,437 MHz 99% Bandwidth 72 MHz QPSK

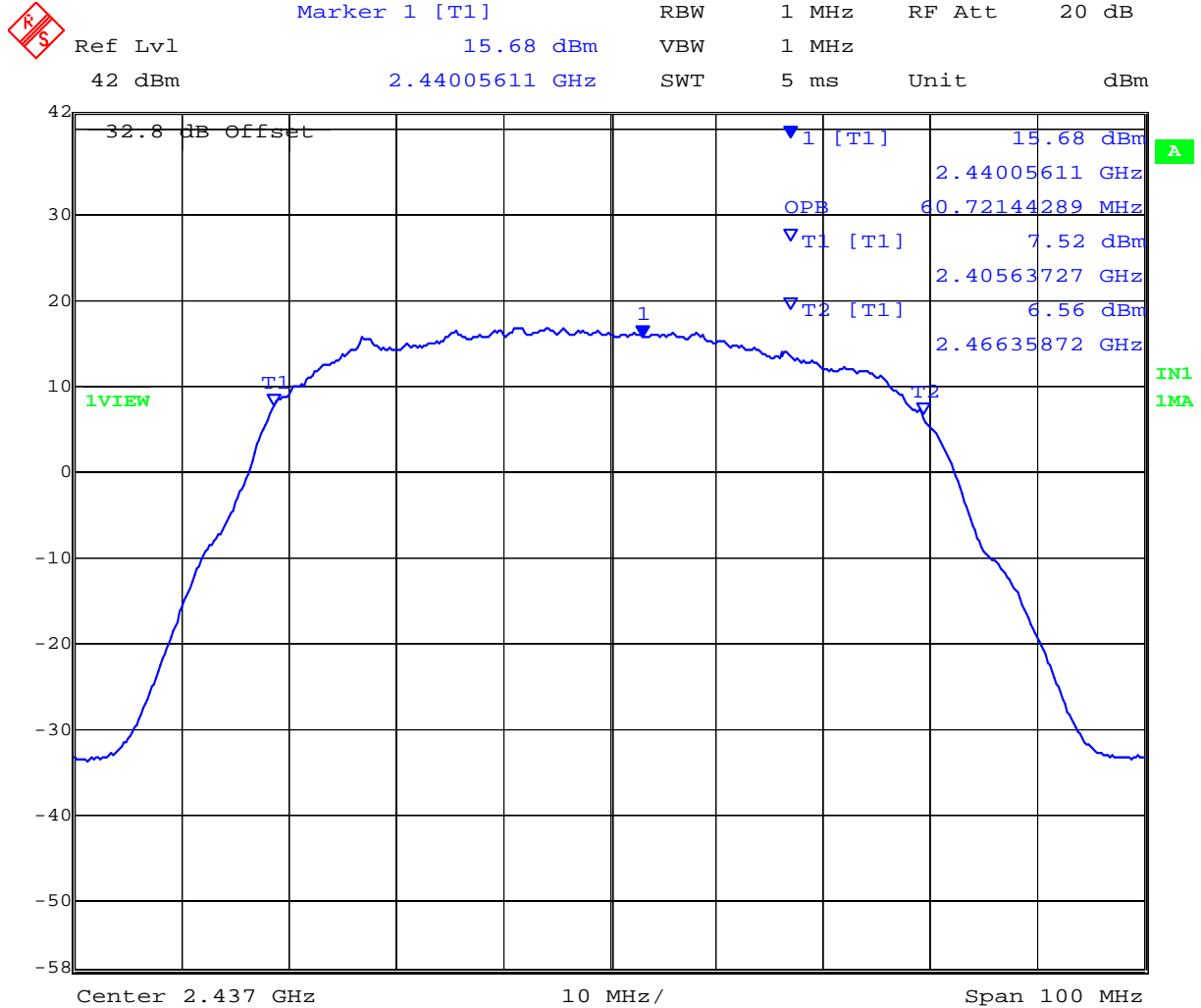

Date: 28.OCT.2005 14:09:11

This test report may be reproduced in full only. The document may only be updated by MiCOM Labs personnel. Any changes will be noted in the Document History section of the report.



Title: Exalt EX-2.4i-16 Fixed Link Radio
To: FCC 47 CFR Part15.247 & IC RSS-210
Serial #: EXLT19-A1 Rev A
Issue Date: 28th Feb 2007
Page: 40 of 248

TABLE OF RESULTS – 72 MHz Bandwidth 16QAM Modulation

Center Frequency (MHz)	6 dB Bandwidth (MHz)	6 dB Plot #	99 % BW (MHz)	99 % BW Plots
2,437	55.7114	21	61.3226	22

Plot 21
2,437 MHz 6 dB Bandwidth 72 MHz 16QAM

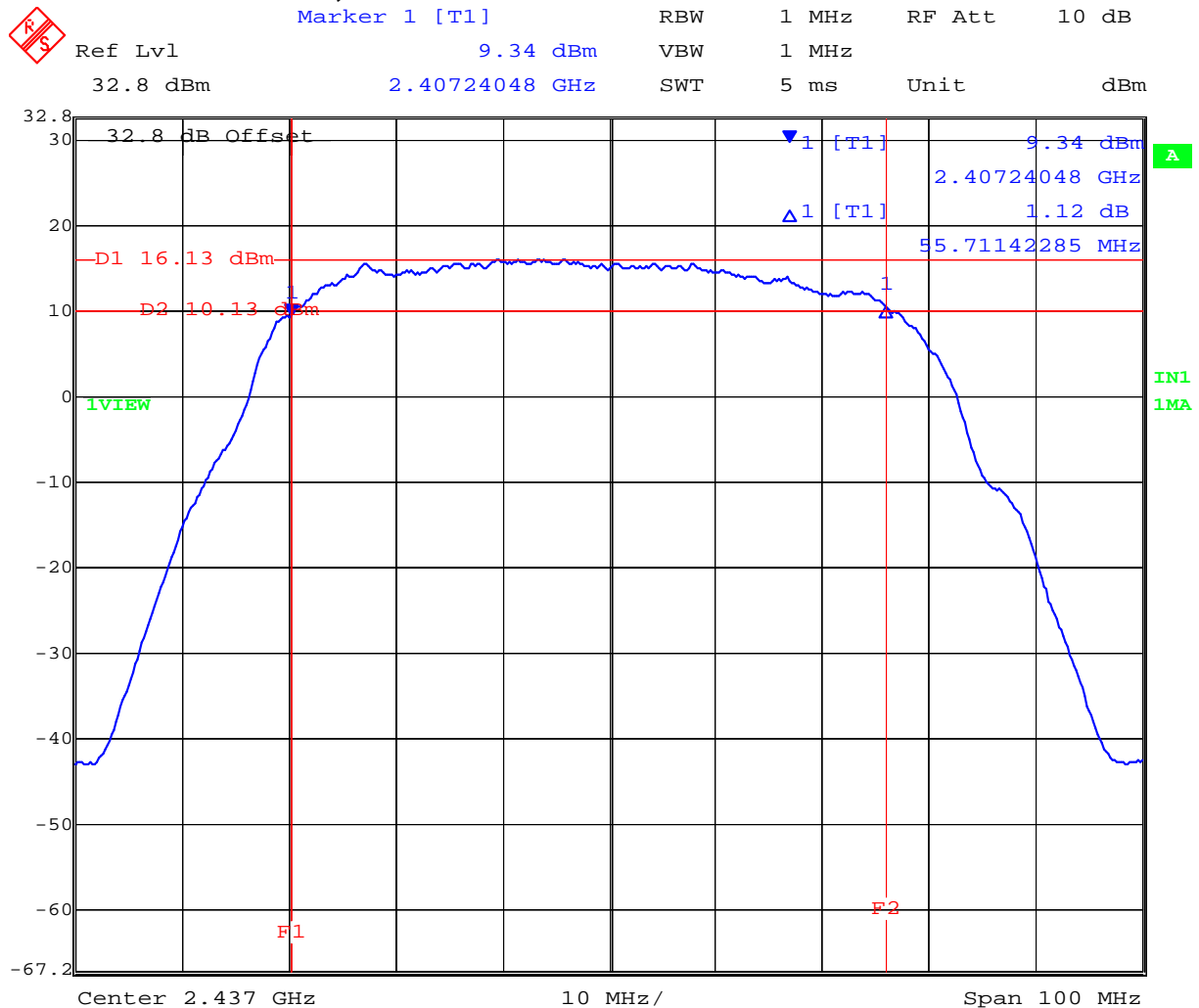

Date: 28.OCT.2005 10:53:02

This test report may be reproduced in full only. The document may only be updated by MiCOM Labs personnel. Any changes will be noted in the Document History section of the report.



Title: Exalt EX-2.4i-16 Fixed Link Radio
To: FCC 47 CFR Part15.247 & IC RSS-210
Serial #: EXLT19-A1 Rev A
Issue Date: 28th Feb 2007
Page: 41 of 248

Plot 22
2,437 MHz 99% Bandwidth 72 MHz 16QAM

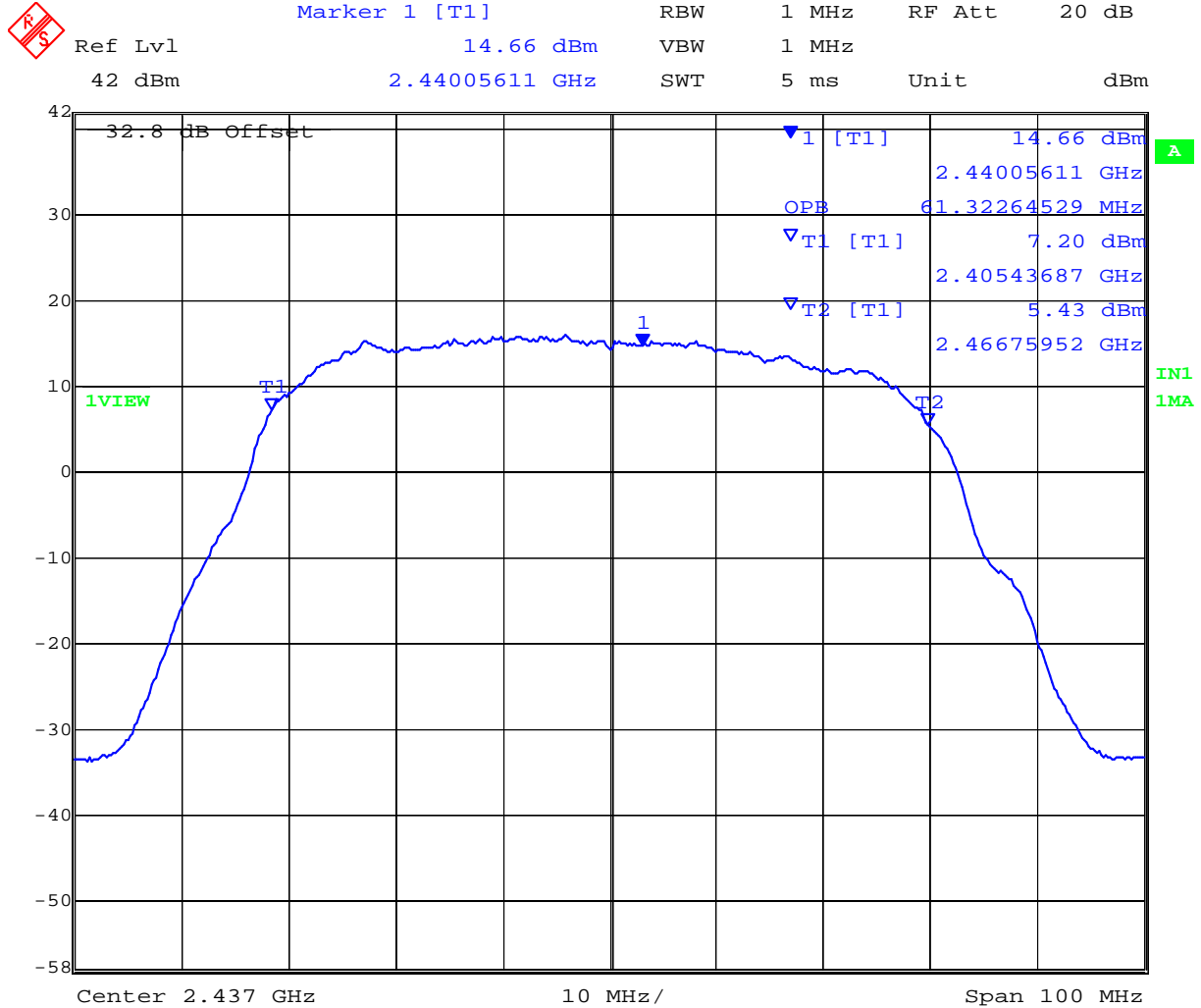

Date: 28.OCT.2005 14:09:58

This test report may be reproduced in full only. The document may only be updated by MiCOM Labs personnel. Any changes will be noted in the Document History section of the report.



Title: Exalt EX-2.4i-16 Fixed Link Radio
To: FCC 47 CFR Part15.247 & IC RSS-210
Serial #: EXLT19-A1 Rev A
Issue Date: 28th Feb 2007
Page: 42 of 248

TABLE OF RESULTS – 72 MHz Bandwidth 64QAM Modulation

Center Frequency (MHz)	6 dB Bandwidth (MHz)	6 dB Plot #	99 % BW (MHz)	99 % BW Plots
2,437	55.7114	23	61.7234	24

Plot 23
2,437 MHz 6 dB Bandwidth 72 MHz 64QAM

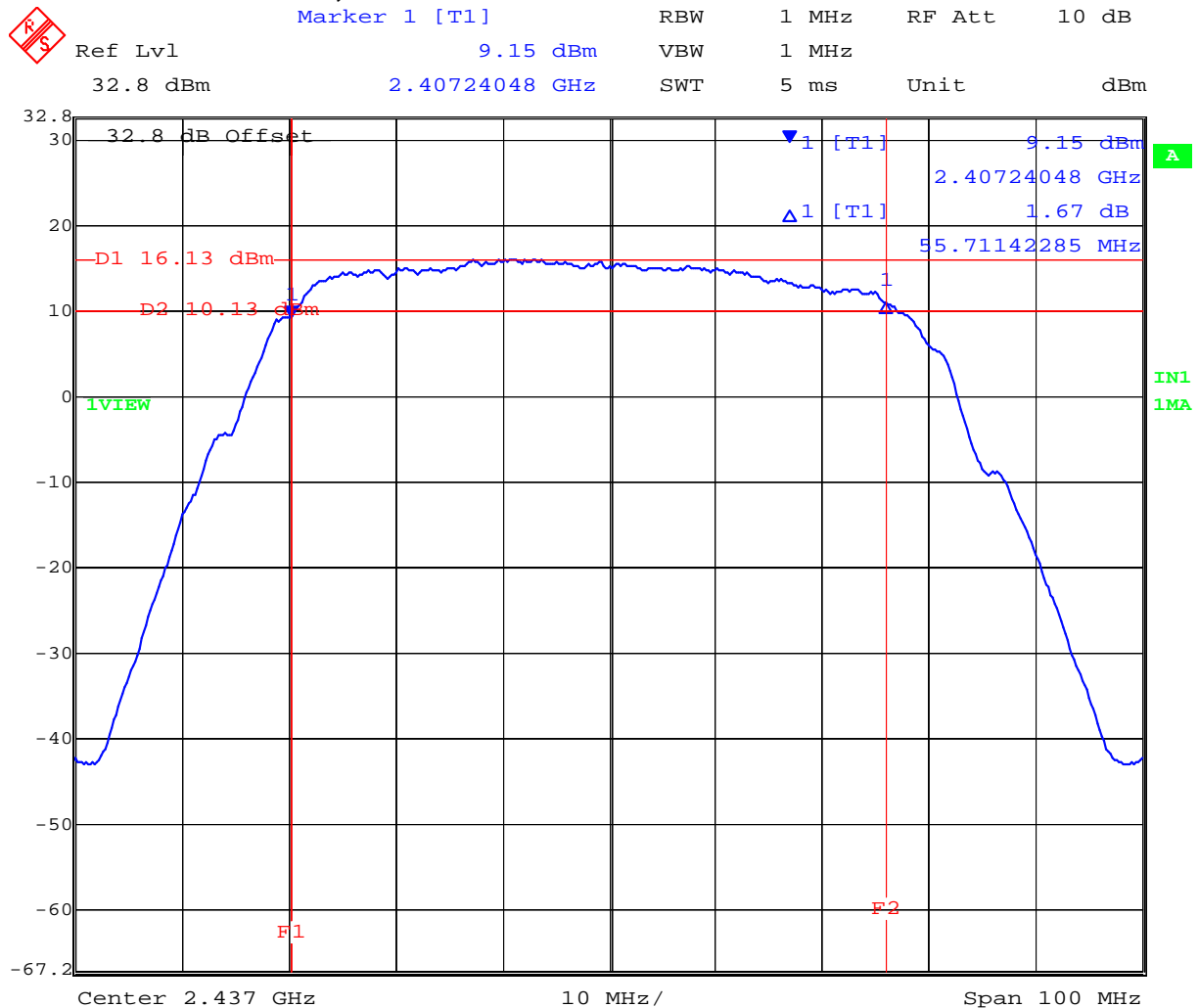

Date: 28.OCT.2005 10:51:07

This test report may be reproduced in full only. The document may only be updated by MiCOM Labs personnel. Any changes will be noted in the Document History section of the report.



Title: Exalt EX-2.4i-16 Fixed Link Radio
To: FCC 47 CFR Part15.247 & IC RSS-210
Serial #: EXLT19-A1 Rev A
Issue Date: 28th Feb 2007
Page: 43 of 248

Plot 24
2,437 MHz 99% Bandwidth 72 MHz 64QAM

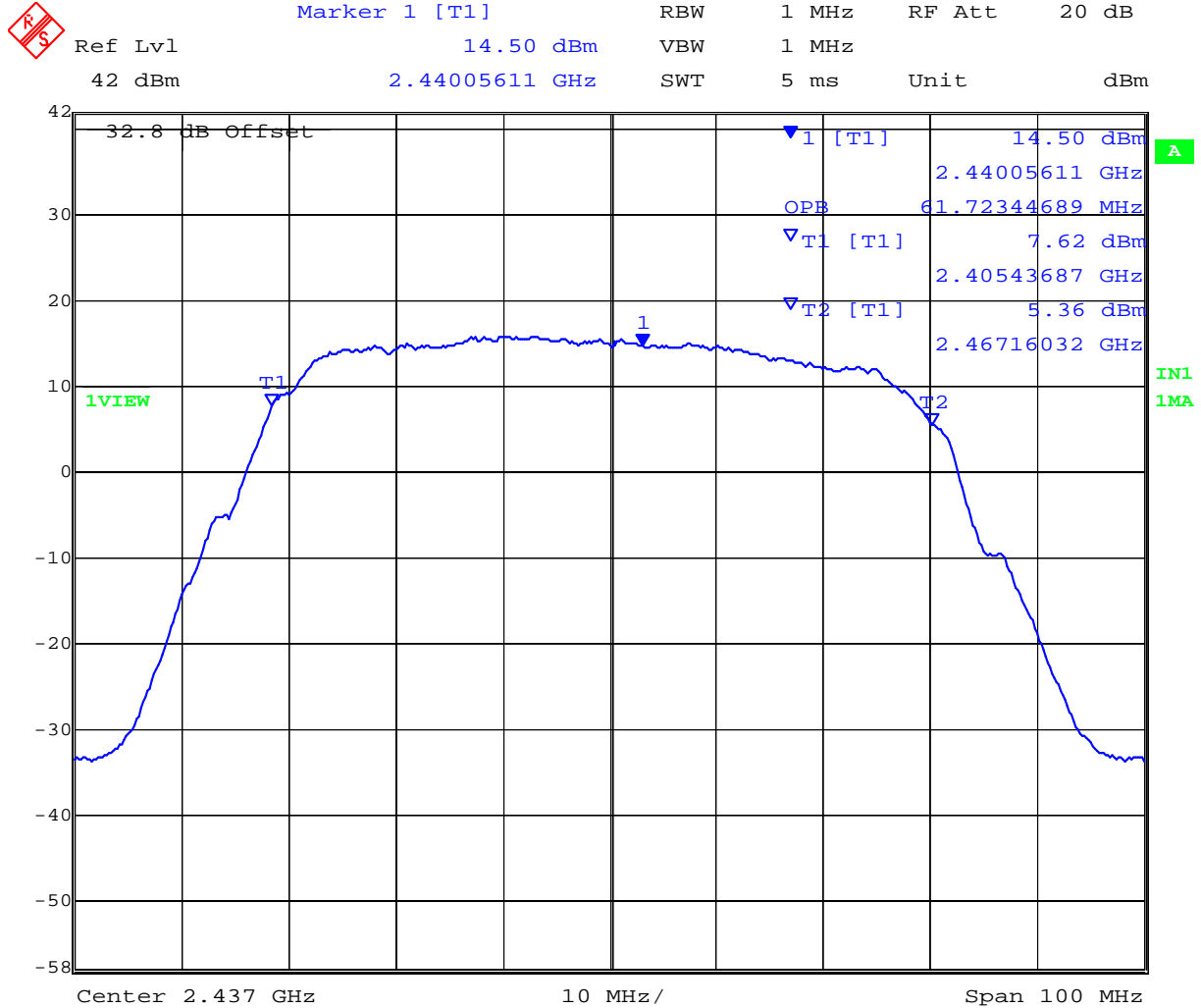

Date: 28.OCT.2005 14:10:37

This test report may be reproduced in full only. The document may only be updated by MiCOM Labs personnel. Any changes will be noted in the Document History section of the report.



Title: Exalt EX-2.4i-16 Fixed Link Radio
To: FCC 47 CFR Part15.247 & IC RSS-210
Serial #: EXLT19-A1 Rev A
Issue Date: 28th Feb 2007
Page: 44 of 248

Specification

Limits

§15.247 (a)(2) For direct sequence systems the minimum 6 dB bandwidth shall be at least 500 kHz

IC RSS-Gen §4.4.1 The transmitted bandwidth to be reported is to be its 99% emission bandwidth, as calculated or measured.

§ IC RSS-Gen 4.4.2 Where indicated, the 6 dB bandwidth is measured at the points when the spectral density of the signal is 6 dB down from the in -band spectral density of the modulated signal, with the transmitter modulated by a representative signal.

Laboratory Measurement Uncertainty for Spectrum Measurement

Measurement uncertainty	±2.81 dB
-------------------------	----------

Traceability

Method	Test Equipment Used
Measurements were made per work instruction WI-03 'Measurement of RF Spectrum Mask'	0070, 0116, 0158, 0193, 0252, 0313, 0314

This test report may be reproduced in full only. The document may only be updated by MiCOM Labs personnel. Any changes will be noted in the Document History section of the report.

5.1.2. Peak Output Power

FCC, Part 15 Subpart C §15.247(b)
Industry Canada RSS-210 § A8.4(4), RSS-Gen § 4.6

Test Procedure

The transmitter terminal of EUT was connected to the input of the spectrum analyzer set to measure peak power. The resolution filter bandwidth was set to 6 dB, peak detector selected and the analyzer built-in power function was used to measure peak power over the maximum 99 % bandwidth for each modulation and bandwidth.

Test Measurement Set up

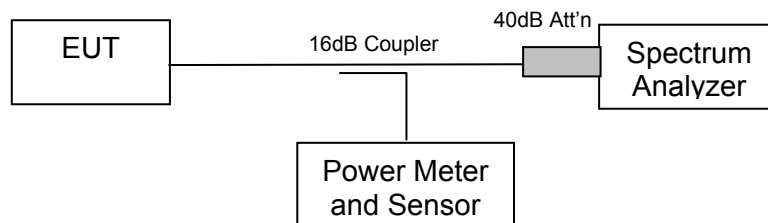

Measurement set up for Transmitter Peak Output Power

Antenna Gain - Maximum Allowable Power Level

For fixed point to point operation.

Systems operating in the 2400-2483.5 MHz band that are used exclusively for fixed, point-to-point operations may employ transmitting antennas with directional gain greater than 6 dBi provided the maximum conducted output power of the intentional radiator is reduced by 1 dB for every 3 dB that the directional gain of the antenna exceeds 6 dBi.

Antenna Type	Gain (dBi)	Antenna Gain >6dBi (dB)	Power Reduction (dB)	Maximum Peak Power (dBm)
Parabolic	21.3	15.3	5.10	+24.9
Parabolic	30.3	24.3	8.10	+21.9
Panel	20.0	14.0	4.67	+25.3



Measurement Results for Peak Output Power

Ambient conditions.

Temperature: 19 to 26 °C Relative humidity: 31 to 57 % Pressure: 999 to 1009 mbar

TABLE OF RESULTS – 9 MHz Bandwidth QPSK Modulation

Center Frequency (MHz)	99% Measurement Bandwidth (MHz)	Peak Power (dBm)	Average Power (dBm)	Plot #
2,406	10.170	29.96	23.63	25
2,437	10.170	29.76	23.62	On File
2,468	10.170	29.71	23.56	On File

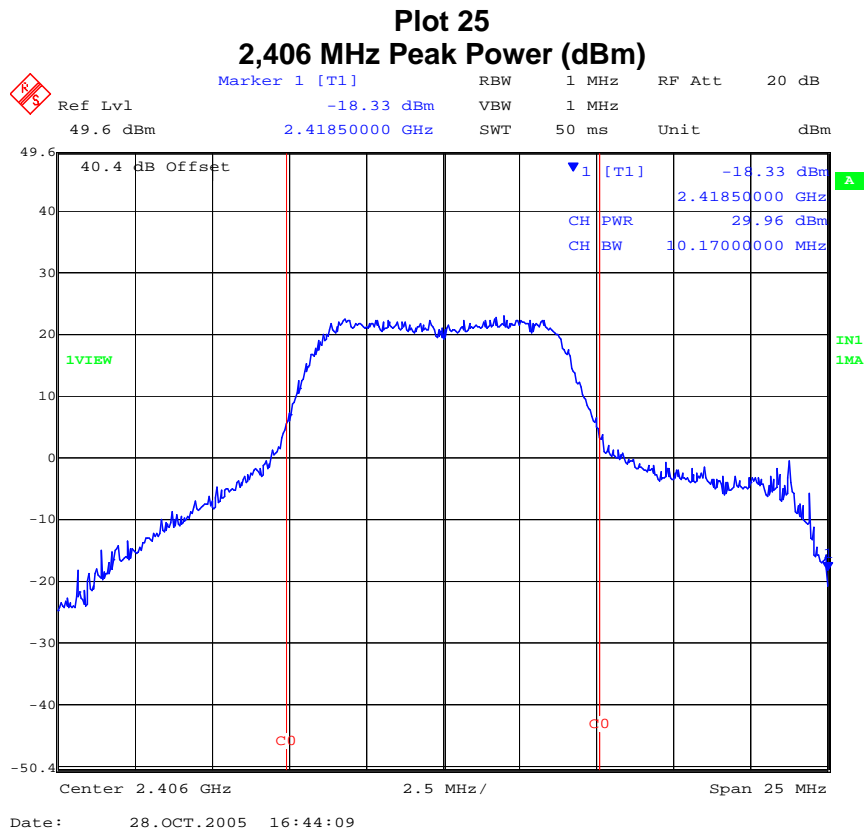

This test report may be reproduced in full only. The document may only be updated by MiCOM Labs personnel. Any changes will be noted in the Document History section of the report.



Title: Exalt EX-2.4i-16 Fixed Link Radio
To: FCC 47 CFR Part15.247 & IC RSS-210
Serial #: EXLT19-A1 Rev A
Issue Date: 28th Feb 2007
Page: 47 of 248

TABLE OF RESULTS – 9 MHz Bandwidth 16QAM Modulation

Center Frequency (MHz)	99% Measurement Bandwidth (MHz)	Peak Power (dBm)	Average Power (dBm)	Plot #
2,406	10.170	29.74	23.21	On File
2,437	10.170	29.59	23.59	On File
2,468	10.170	29.95	23.68	26

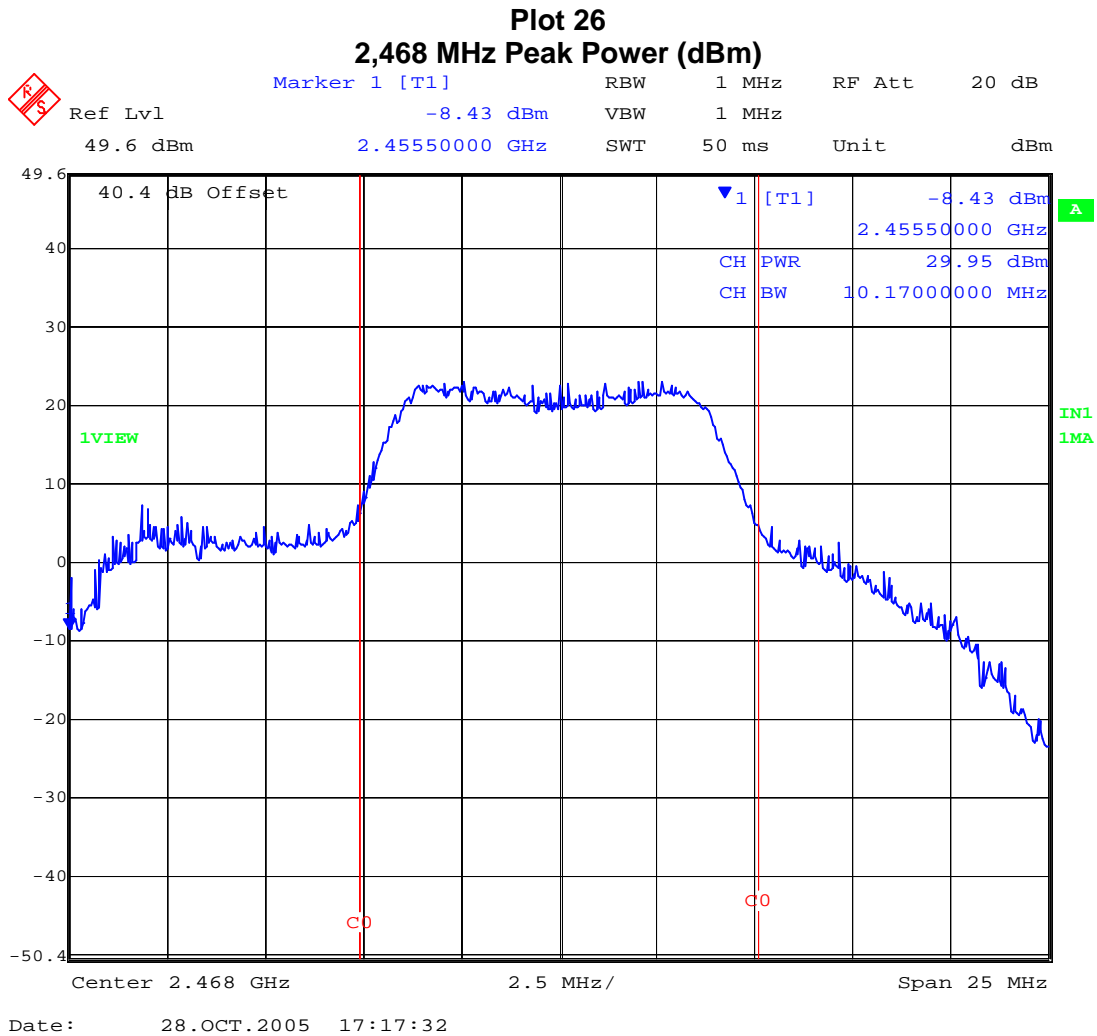

This test report may be reproduced in full only. The document may only be updated by MiCOM Labs personnel. Any changes will be noted in the Document History section of the report.



Title: Exalt EX-2.4i-16 Fixed Link Radio
To: FCC 47 CFR Part15.247 & IC RSS-210
Serial #: EXLT19-A1 Rev A
Issue Date: 28th Feb 2007
Page: 48 of 248

TABLE OF RESULTS – 9 MHz Bandwidth 64QAM Modulation

Center Frequency (MHz)	99% Measurement Bandwidth (MHz)	Peak Power (dBm)	Average Power (dBm)	Plot #
2,406	10.170	29.72	23.17	On File
2,437	10.170	29.89	23.53	27
2,468	10.170	29.64	23.27	On File

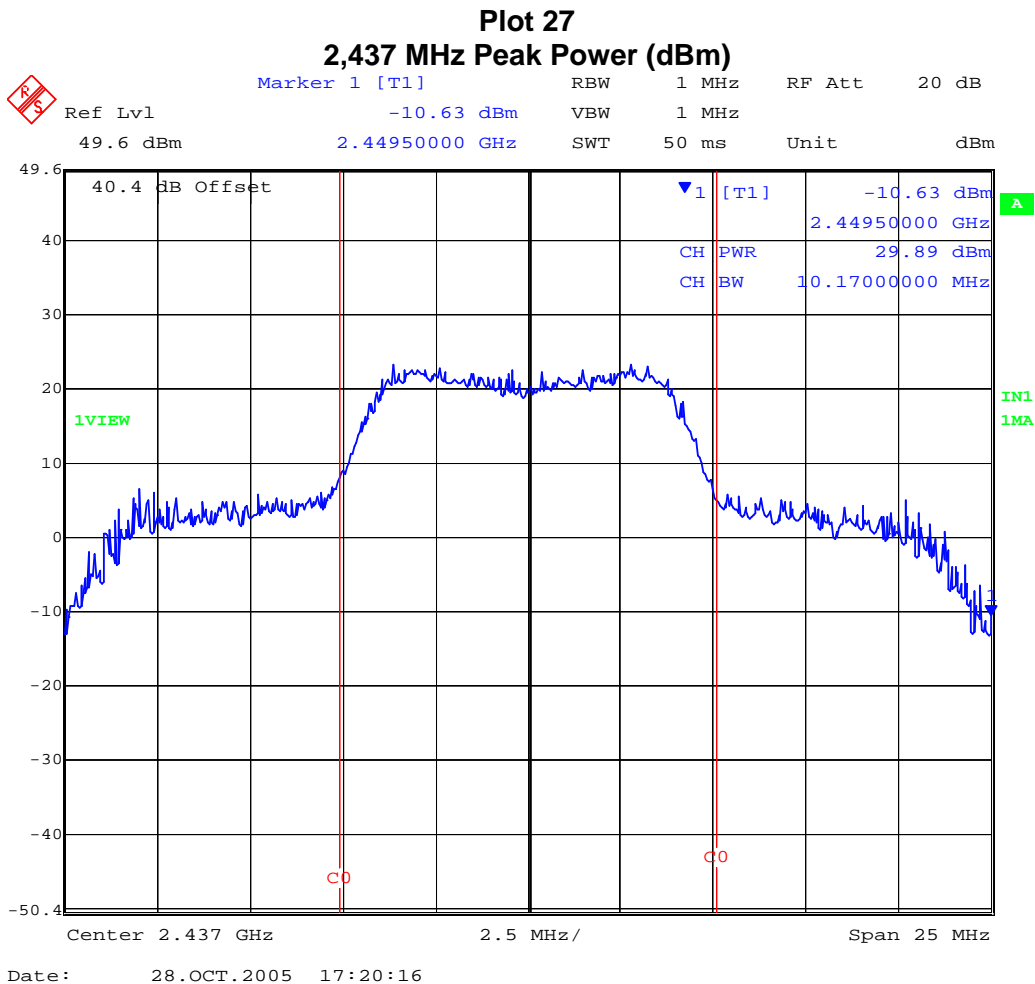

This test report may be reproduced in full only. The document may only be updated by MiCOM Labs personnel. Any changes will be noted in the Document History section of the report.



Title: Exalt EX-2.4i-16 Fixed Link Radio
To: FCC 47 CFR Part15.247 & IC RSS-210
Serial #: EXLT19-A1 Rev A
Issue Date: 28th Feb 2007
Page: 49 of 248

TABLE OF RESULTS – 18 MHz Bandwidth QPSK Modulation

Center Frequency (MHz)	99% Measurement Bandwidth (MHz)	Peak Power (dBm)	Average Power (dBm)	Plot #
2,417	20.24	29.84	22.60	On File
2,437	20.24	29.94	23.19	On File
2,465	20.24	29.96	23.17	28

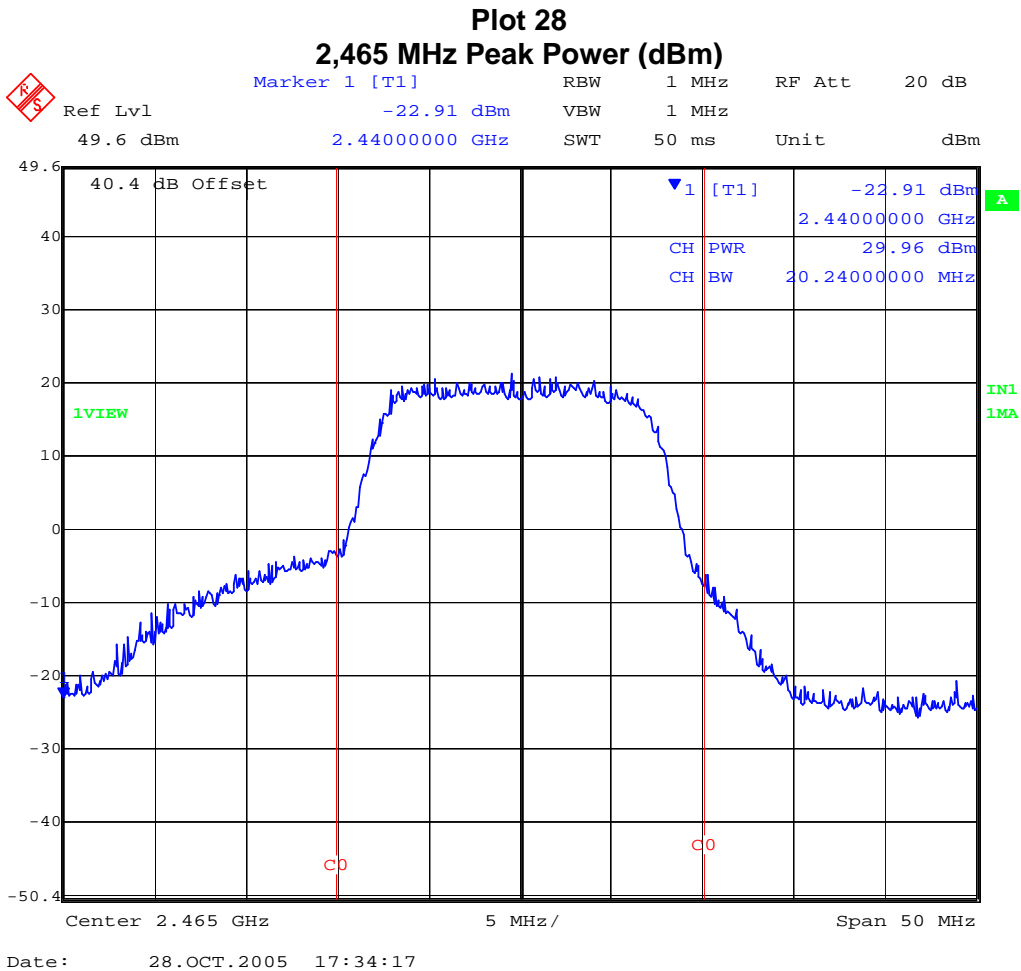

This test report may be reproduced in full only. The document may only be updated by MiCOM Labs personnel. Any changes will be noted in the Document History section of the report.



Title: Exalt EX-2.4i-16 Fixed Link Radio
To: FCC 47 CFR Part15.247 & IC RSS-210
Serial #: EXLT19-A1 Rev A
Issue Date: 28th Feb 2007
Page: 50 of 248

TABLE OF RESULTS – 18 MHz Bandwidth 16QAM Modulation

Center Frequency (MHz)	99% Measurement Bandwidth (MHz)	Peak Power (dBm)	Average Power (dBm)	Plot #
2,417	20.24	29.80	23.05	29
2,437	20.24	29.72	23.04	On File
2,465	20.24	29.73	23.08	On File

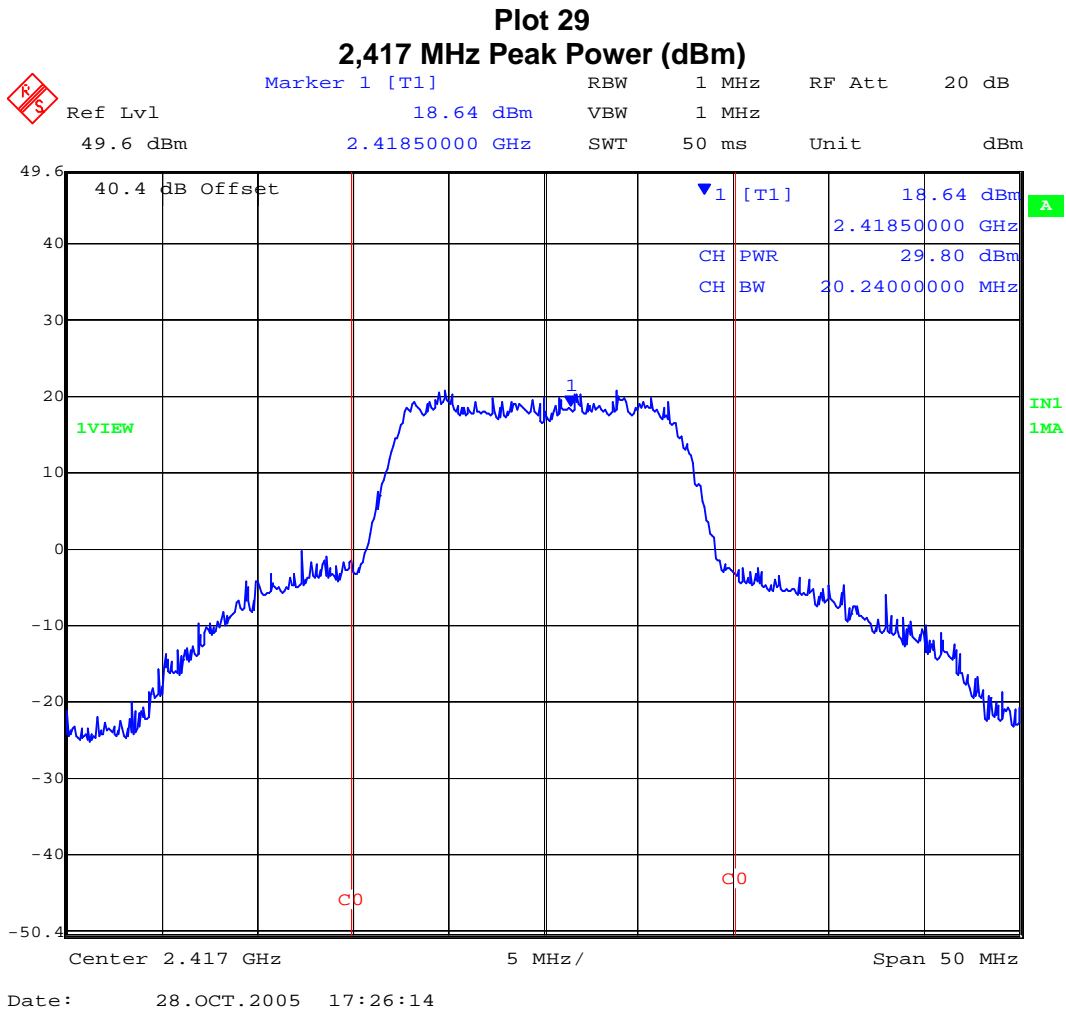

This test report may be reproduced in full only. The document may only be updated by MiCOM Labs personnel. Any changes will be noted in the Document History section of the report.



Title: Exalt EX-2.4i-16 Fixed Link Radio
To: FCC 47 CFR Part15.247 & IC RSS-210
Serial #: EXLT19-A1 Rev A
Issue Date: 28th Feb 2007
Page: 51 of 248

TABLE OF RESULTS – 18 MHz Bandwidth 64QAM Modulation

Center Frequency (MHz)	99% Measurement Bandwidth (MHz)	Peak Power (dBm)	Average Power (dBm)	Plot #
2,417	20.24	29.83	23.00	On File
2,437	20.24	29.76	23.07	On File
2,465	20.24	29.93	23.15	30

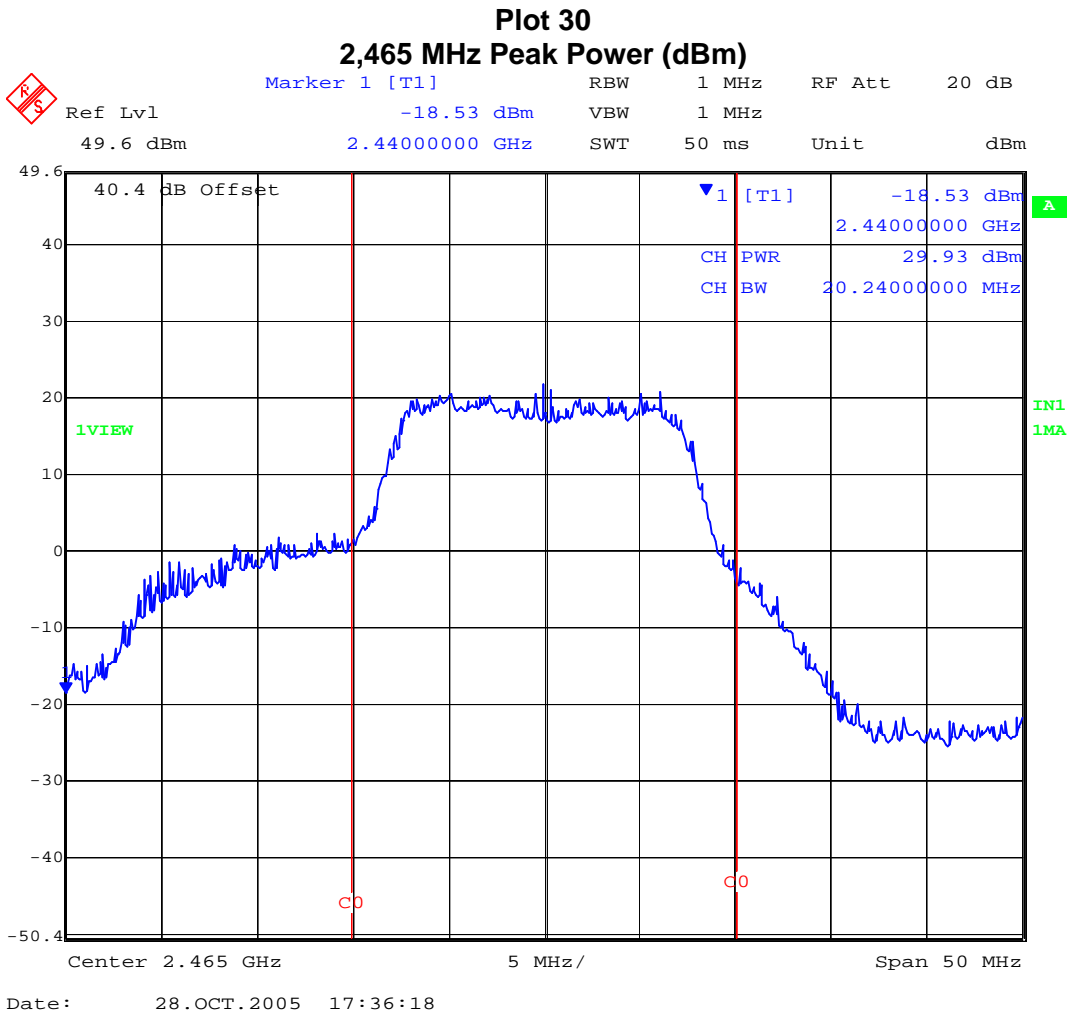

This test report may be reproduced in full only. The document may only be updated by MiCOM Labs personnel. Any changes will be noted in the Document History section of the report.



Title: Exalt EX-2.4i-16 Fixed Link Radio
To: FCC 47 CFR Part15.247 & IC RSS-210
Serial #: EXLT19-A1 Rev A
Issue Date: 28th Feb 2007
Page: 52 of 248

TABLE OF RESULTS – 36 MHz Bandwidth QPSK Modulation

Center Frequency (MHz)	99% Measurement Bandwidth (MHz)	Peak Power (dBm)	Average Power (dBm)	Plot #
2,426	38.08	29.85	22.97	31
2,437	38.08	29.71	22.88	On File
2,455	38.08	29.65	22.85	On File

**Plot 31
2,426 MHz Peak Power (dBm)**

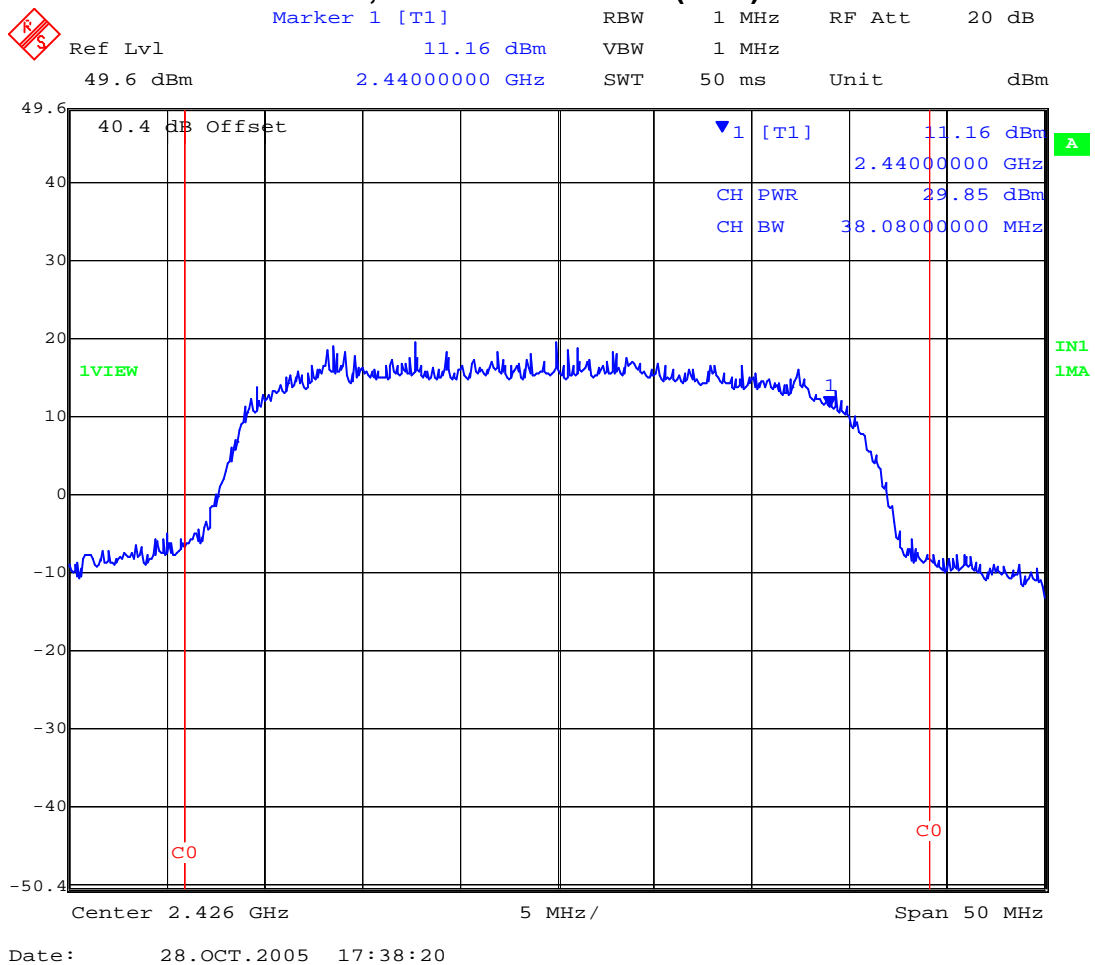

This test report may be reproduced in full only. The document may only be updated by MiCOM Labs personnel. Any changes will be noted in the Document History section of the report.



Title: Exalt EX-2.4i-16 Fixed Link Radio
To: FCC 47 CFR Part15.247 & IC RSS-210
Serial #: EXLT19-A1 Rev A
Issue Date: 28th Feb 2007
Page: 53 of 248

TABLE OF RESULTS – 36 MHz Bandwidth 16QAM Modulation

Center Frequency (MHz)	99% Measurement Bandwidth (MHz)	Peak Power (dBm)	Average Power (dBm)	Plot #
2,426	38.08	29.72	22.87	32
2,437	38.08	29.66	22.86	On File
2,455	38.08	29.72	22.82	On File

Plot 32
2,426 MHz Peak Power (dBm)

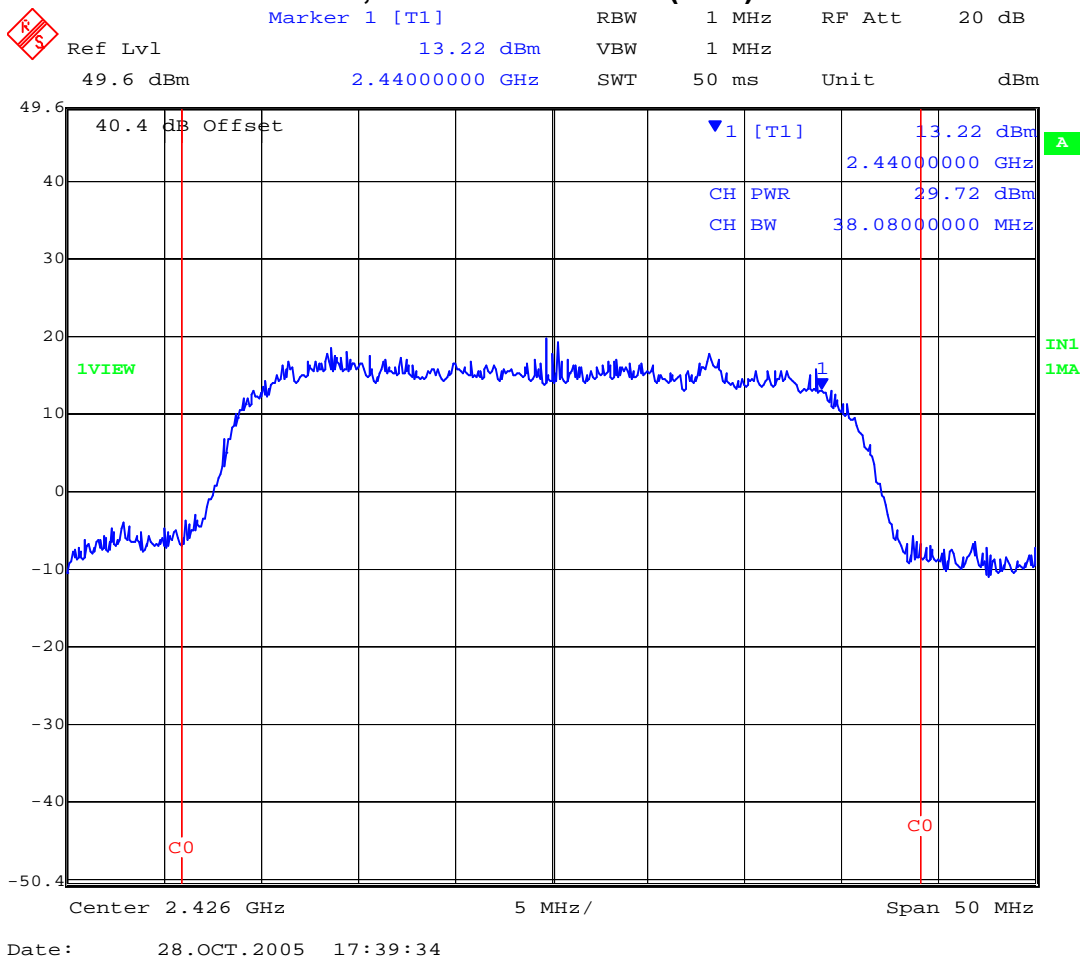

This test report may be reproduced in full only. The document may only be updated by MiCOM Labs personnel. Any changes will be noted in the Document History section of the report.



Title: Exalt EX-2.4i-16 Fixed Link Radio
To: FCC 47 CFR Part15.247 & IC RSS-210
Serial #: EXLT19-A1 Rev A
Issue Date: 28th Feb 2007
Page: 54 of 248

TABLE OF RESULTS – 36 MHz Bandwidth 64QAM Modulation

Center Frequency (MHz)	99% Measurement Bandwidth (MHz)	Peak Power (dBm)	Average Power (dBm)	Plot #
2,426	38.08	29.66	22.67	On File
2,437	38.08	29.65	22.74	On File
2,455	38.08	29.72	22.84	33

Plot 33
2,455 MHz Peak Power (dBm)

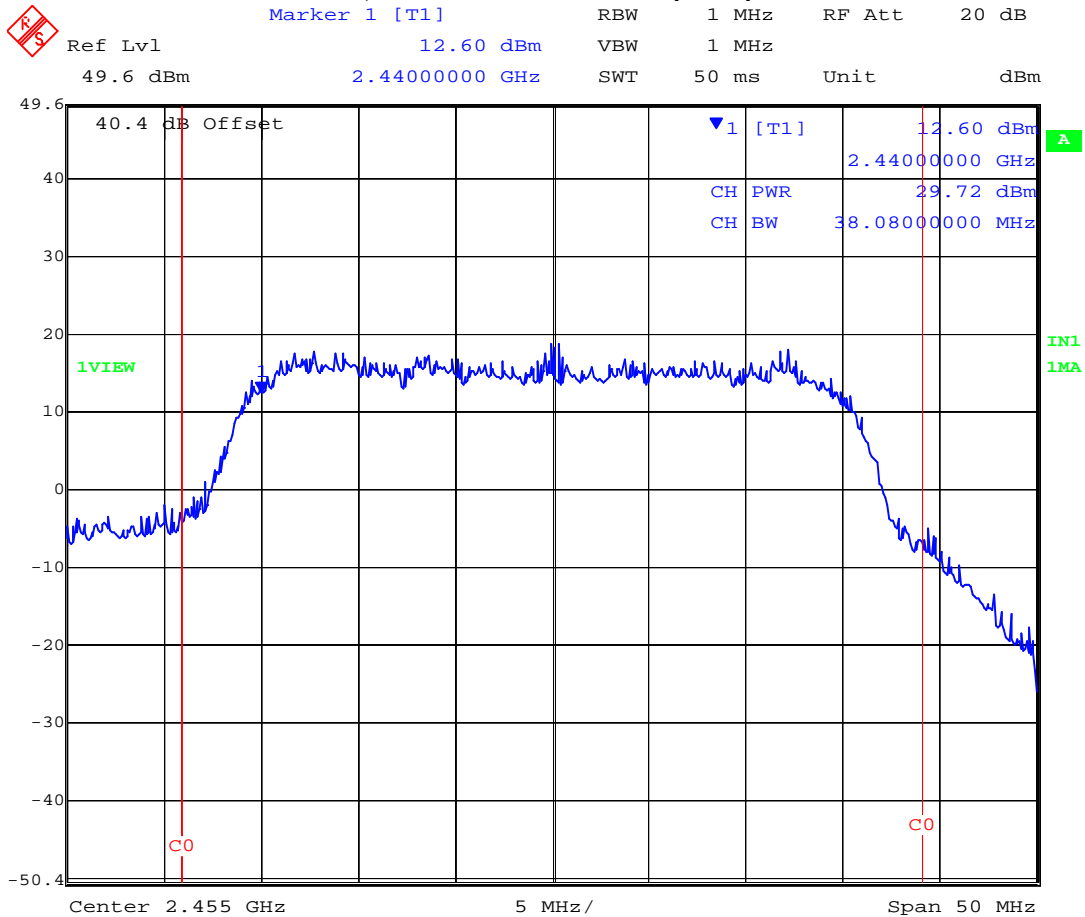

Date: 28.OCT.2005 17:49:43

This test report may be reproduced in full only. The document may only be updated by MiCOM Labs personnel. Any changes will be noted in the Document History section of the report.



Title: Exalt EX-2.4i-16 Fixed Link Radio
To: FCC 47 CFR Part15.247 & IC RSS-210
Serial #: EXLT19-A1 Rev A
Issue Date: 28th Feb 2007
Page: 55 of 248

TABLE OF RESULTS – 72 MHz Bandwidth QPSK Modulation

Center Frequency (MHz)	99% Measurement Bandwidth (MHz)	Peak Power (dBm)	Average Power (dBm)	Plot #
2,437	61.72	29.79	22.82	34

**Plot 34
2,437 MHz Peak Power (dBm)**

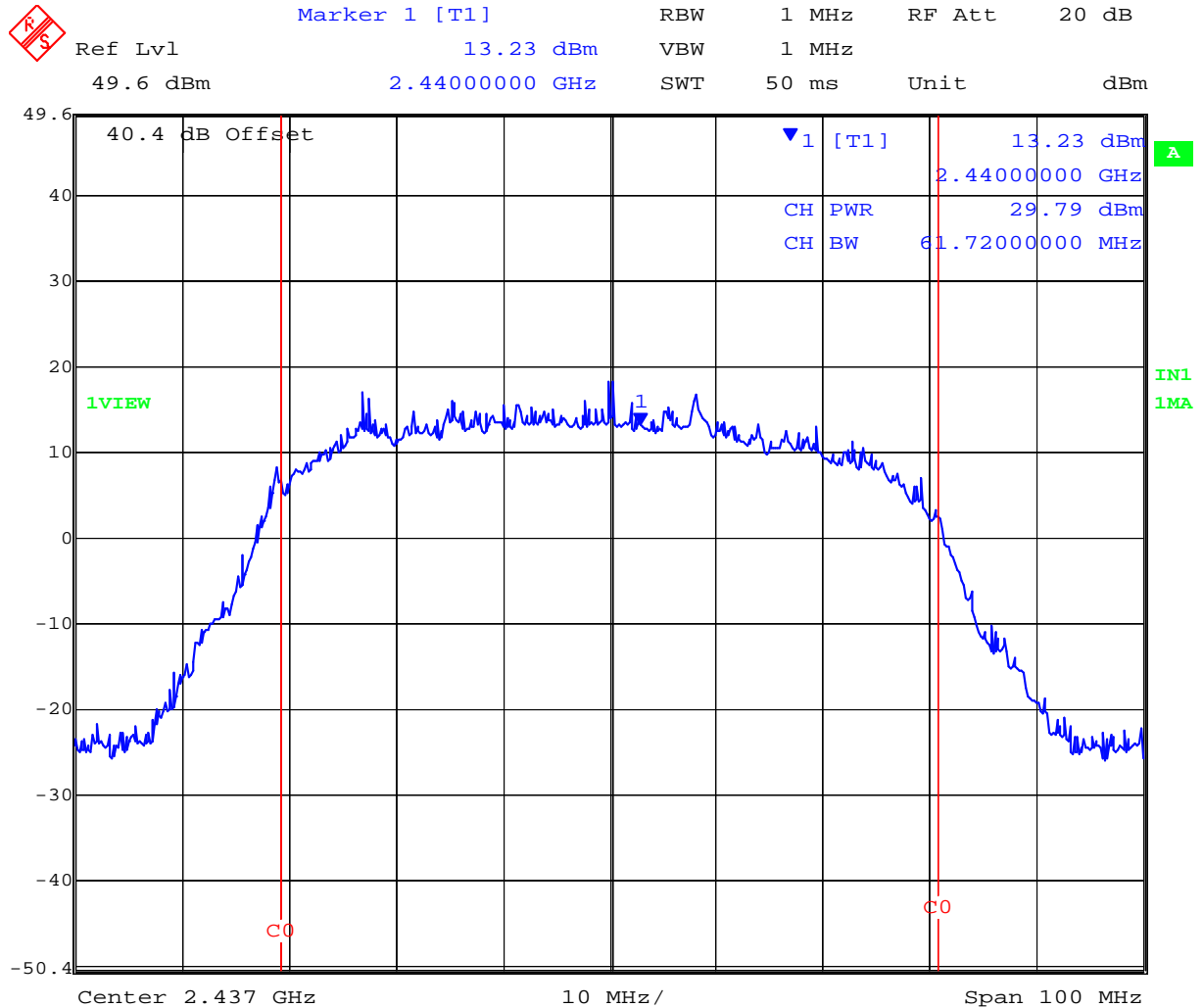

Date: 28.OCT.2005 17:51:16

This test report may be reproduced in full only. The document may only be updated by MiCOM Labs personnel. Any changes will be noted in the Document History section of the report.



TABLE OF RESULTS – 72 MHz Bandwidth 16QAM Modulation

Center Frequency (MHz)	99% Measurement Bandwidth (MHz)	Peak Power (dBm)	Average Power (dBm)	Plot #
2,437	61.72	29.68	22.71	35

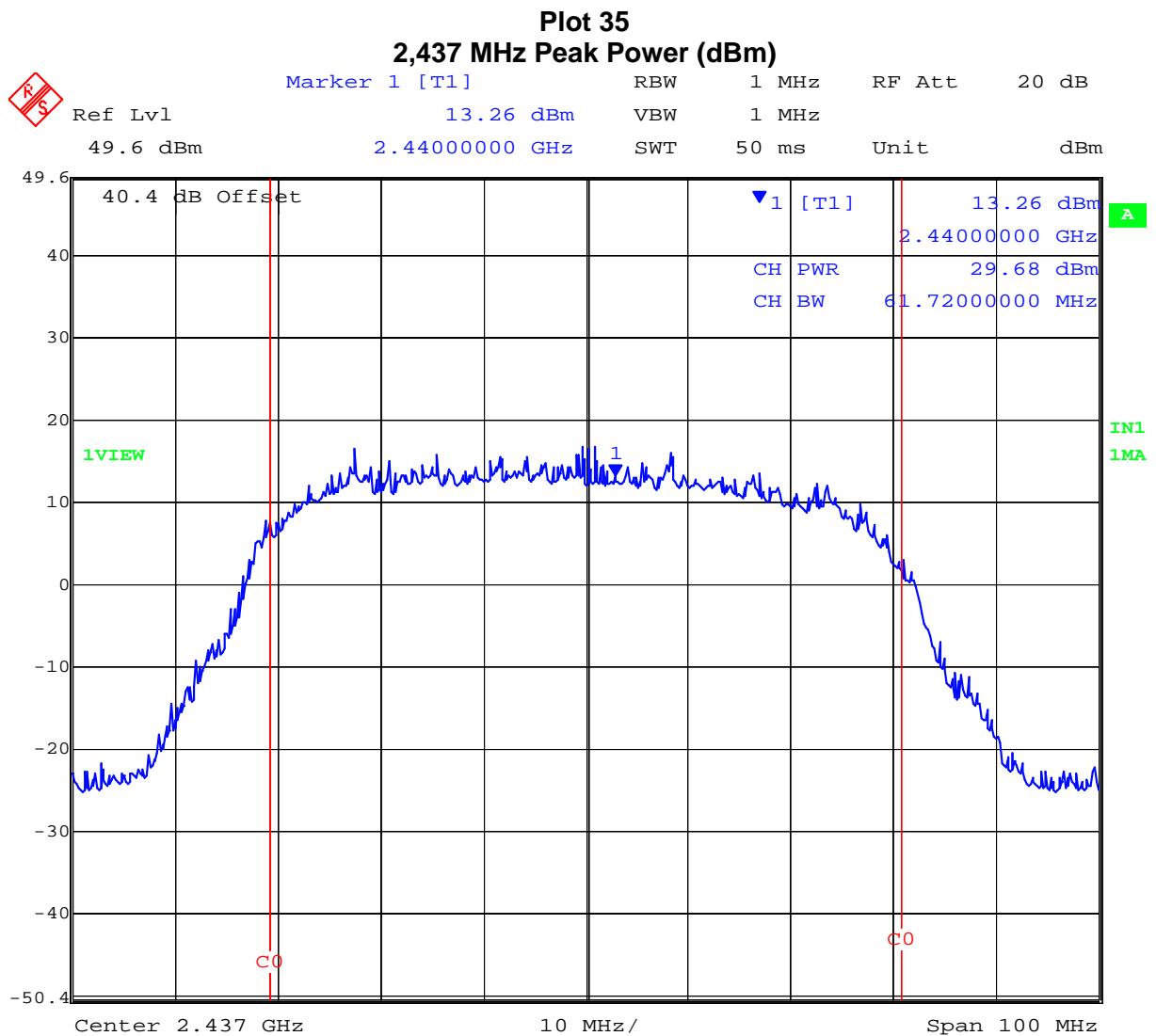

Date: 28.OCT.2005 17:52:30

This test report may be reproduced in full only. The document may only be updated by MiCOM Labs personnel. Any changes will be noted in the Document History section of the report.



Title: Exalt EX-2.4i-16 Fixed Link Radio
To: FCC 47 CFR Part15.247 & IC RSS-210
Serial #: EXLT19-A1 Rev A
Issue Date: 28th Feb 2007
Page: 57 of 248

TABLE OF RESULTS – 72 MHz Bandwidth 64QAM Modulation

Center Frequency (MHz)	99% Measurement Bandwidth (MHz)	Peak Power (dBm)	Average Power (dBm)	Plot #
2,437	61.72	29.91	22.83	36

**Plot 36
2,437 MHz Peak Power (dBm)**

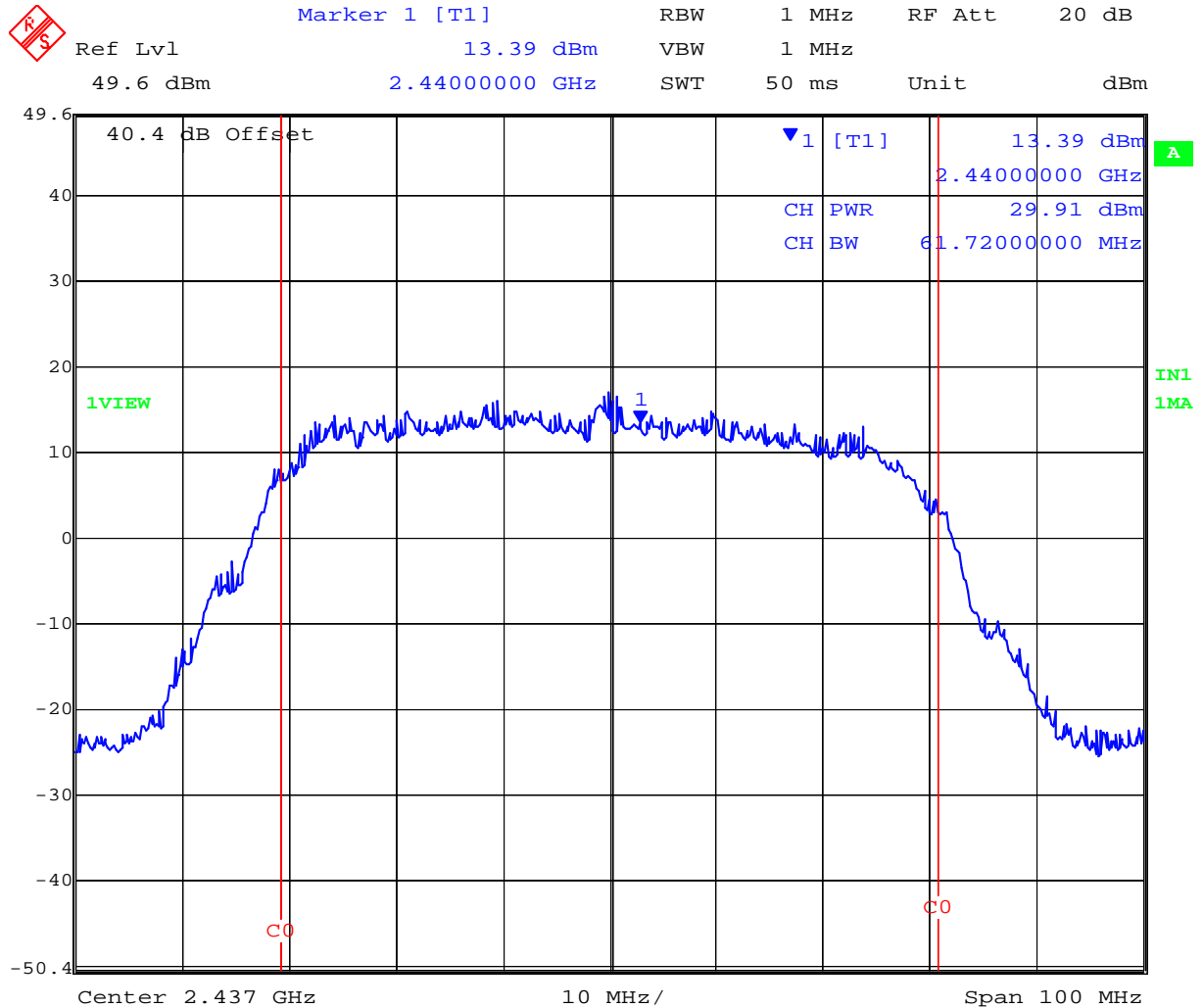

Date: 28.OCT.2005 17:53:19

This test report may be reproduced in full only. The document may only be updated by MiCOM Labs personnel. Any changes will be noted in the Document History section of the report.



Title: Exalt EX-2.4i-16 Fixed Link Radio
To: FCC 47 CFR Part15.247 & IC RSS-210
Serial #: EXLT19-A1 Rev A
Issue Date: 28th Feb 2007
Page: 58 of 248

Supply Voltage Variation

The supply voltage was varied between 97.75 Vac and 132.25 Vac. The system operated as intended at either extreme with no change in the above measurement bandwidths.

Specification

Limits

§15.247 (b) The maximum peak output power of the intentional radiator shall not exceed the following:

§15.247 (b) (3) For systems using digital modulation in the 902-928 MHz, 2400-2483.5 MHz and 5725-5850 MHz bands: 1watt

§15.247 (b) (4) Except as shown in paragraphs (b)(3)(i), (ii) and (iii) of this section, if transmitting antennas of directional gain greater than 6 dBi are used the peak output power from the intentional radiator shall be reduced below the stated values in paragraphs (b) (1) or (b)(2) of this section, as appropriate by the amount in dB that the directional gain of the antenna exceeds 6 dBi.

IC RSS-210 § A8.4(4) For systems employing digital modulation techniques operating in the 2400 – 2483.5 MHz band, the maximum peak conducted power shall not exceed 1 W.

Laboratory Measurement Uncertainty for Power Measurements

Measurement uncertainty	±1.33 dB
-------------------------	----------

Traceability

Method	Test Equipment Used
Measurements were made per work instruction WI-01 'Measuring RF Output Power'	0070, 0116, 0158, 0193, 0252, 0313, 0314

This test report may be reproduced in full only. The document may only be updated by MiCOM Labs personnel. Any changes will be noted in the Document History section of the report.

5.1.3. Peak Power Spectral Density

FCC, Part 15 Subpart C §15.247(d)
Industry Canada RSS-210 § A8.2

Test Procedure

The transmitter output was connected to a spectrum analyzer and the maximum level in a 3 kHz bandwidth was measured. A peak value was found over the full emission bandwidth and the frequency span reduced to obtain enhanced resolution. Sweep time => span / 3 kHz with video averaging turned off. The Peak Power Spectral Density is the highest level found across the emission in a 3 kHz resolution bandwidth.

Test Measurement Set up

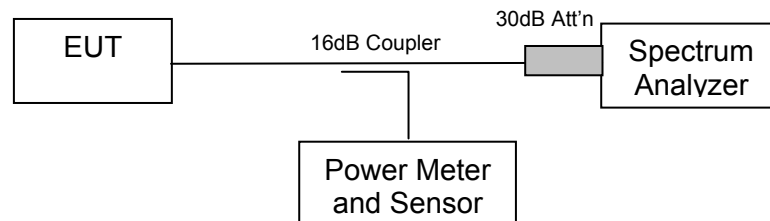

Measurement set up for Peak Power Spectral Density

Measurement Results for Peak Power Spectral Density

Ambient conditions.

Temperature: 19 to 26 °C Relative humidity: 31 to 57 % Pressure: 999 to 1009 mbar



Title: Exalt EX-2.4i-16 Fixed Link Radio
To: FCC 47 CFR Part15.247 & IC RSS-210
Serial #: EXLT19-A1 Rev A
Issue Date: 28th Feb 2007
Page: 60 of 248

TABLE OF RESULTS – 9 MHz Bandwidth QPSK Modulation

Center Frequency (MHz)	Peak Frequency (MHz)	PPSD (dBm)	Plot #
2,406	2402.80261	6.57	37
2,437	2433.80160	6.19	On File
2,468	2464.80060	5.66	On File

Plot 37

2,406 MHz Peak Power Spectral Density (dBm)

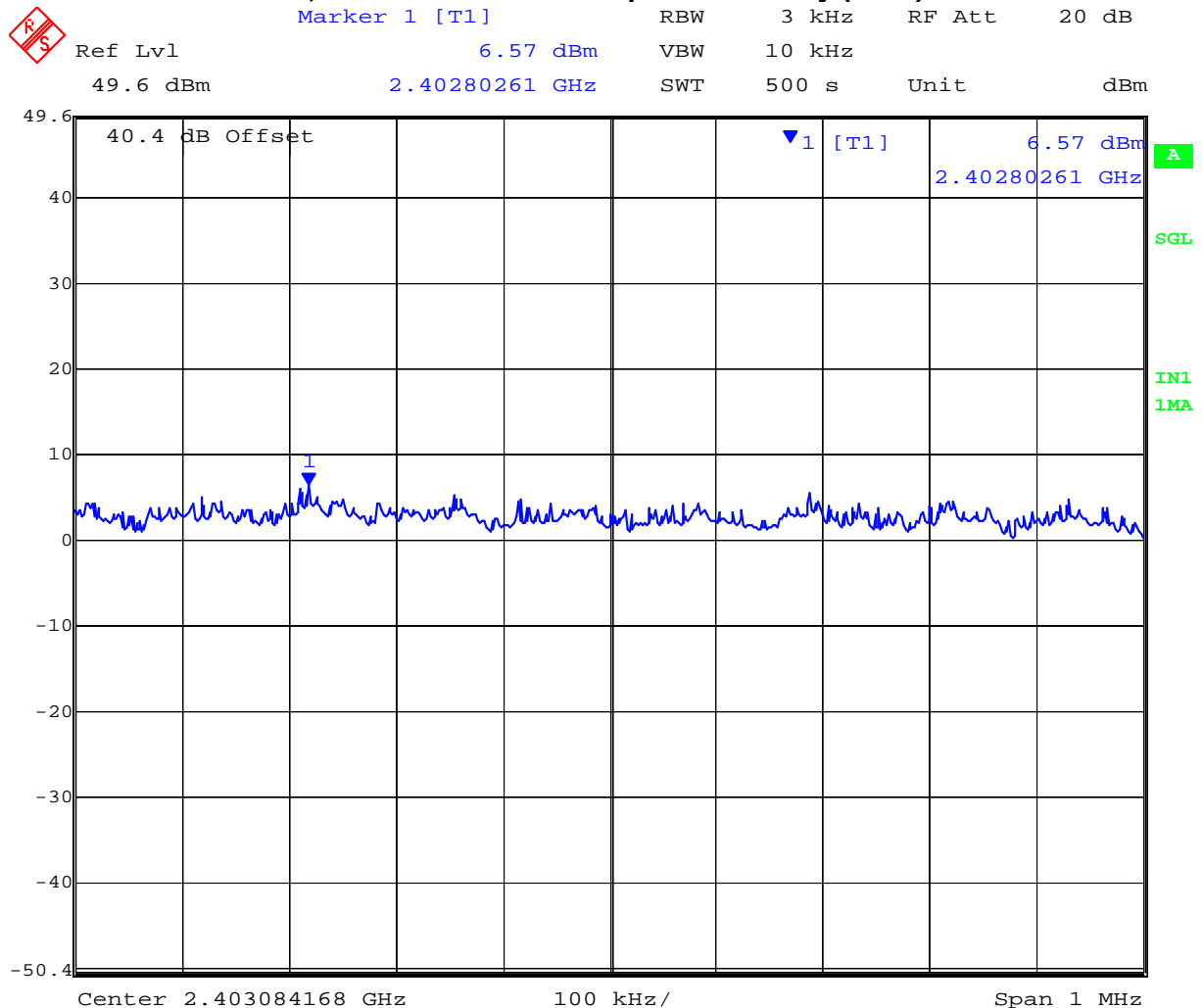

Date: 31.OCT.2005 08:27:38

This test report may be reproduced in full only. The document may only be updated by MiCOM Labs personnel. Any changes will be noted in the Document History section of the report.



Title: Exalt EX-2.4i-16 Fixed Link Radio
To: FCC 47 CFR Part15.247 & IC RSS-210
Serial #: EXLT19-A1 Rev A
Issue Date: 28th Feb 2007
Page: 61 of 248

TABLE OF RESULTS – 9 MHz Bandwidth 16QAM Modulation

Center Frequency (MHz)	Peak Frequency (MHz)	PPSD (dBm)	Plot #
2,406	2409.07916	5.70	On File
2,437	2433.73647	5.97	38
2,468	2464.97896	5.95	On File

Plot 38

2,437 MHz Peak Power Spectral Density (dBm)

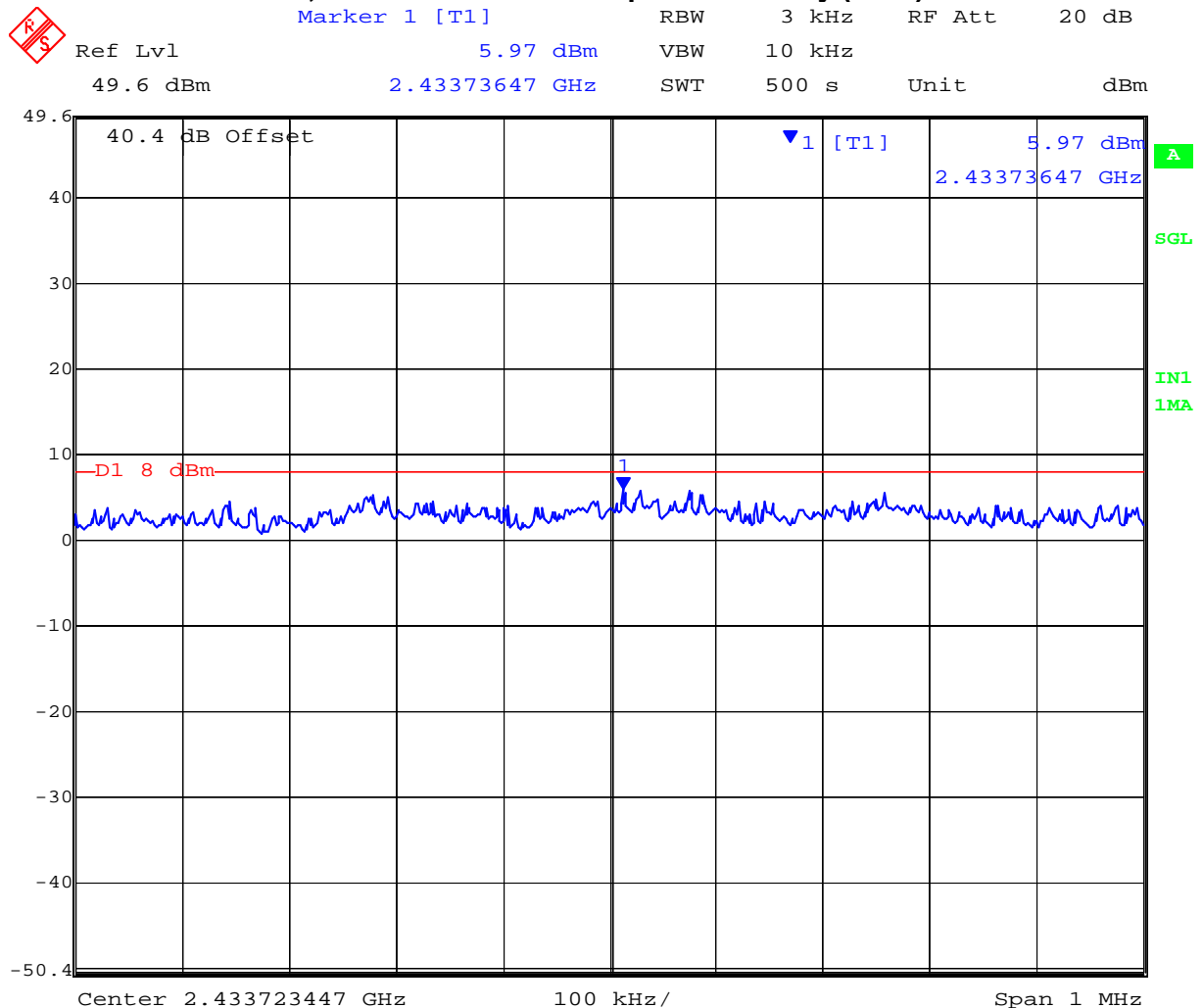

Date: 31.OCT.2005 09:04:11

This test report may be reproduced in full only. The document may only be updated by MiCOM Labs personnel. Any changes will be noted in the Document History section of the report.



Title: Exalt EX-2.4i-16 Fixed Link Radio
To: FCC 47 CFR Part15.247 & IC RSS-210
Serial #: EXLT19-A1 Rev A
Issue Date: 28th Feb 2007
Page: 62 of 248

TABLE OF RESULTS – 9 MHz Bandwidth 64QAM Modulation

Center Frequency (MHz)	Peak Frequency (MHz)	PPSD (dBm)	Plot #
2,406	2408.79058	5.99	39
2,437	2439.78858	5.09	On File
2,468	2464.78457	5.95	On File

Plot 39

2,406 MHz Peak Power Spectral Density (dBm)

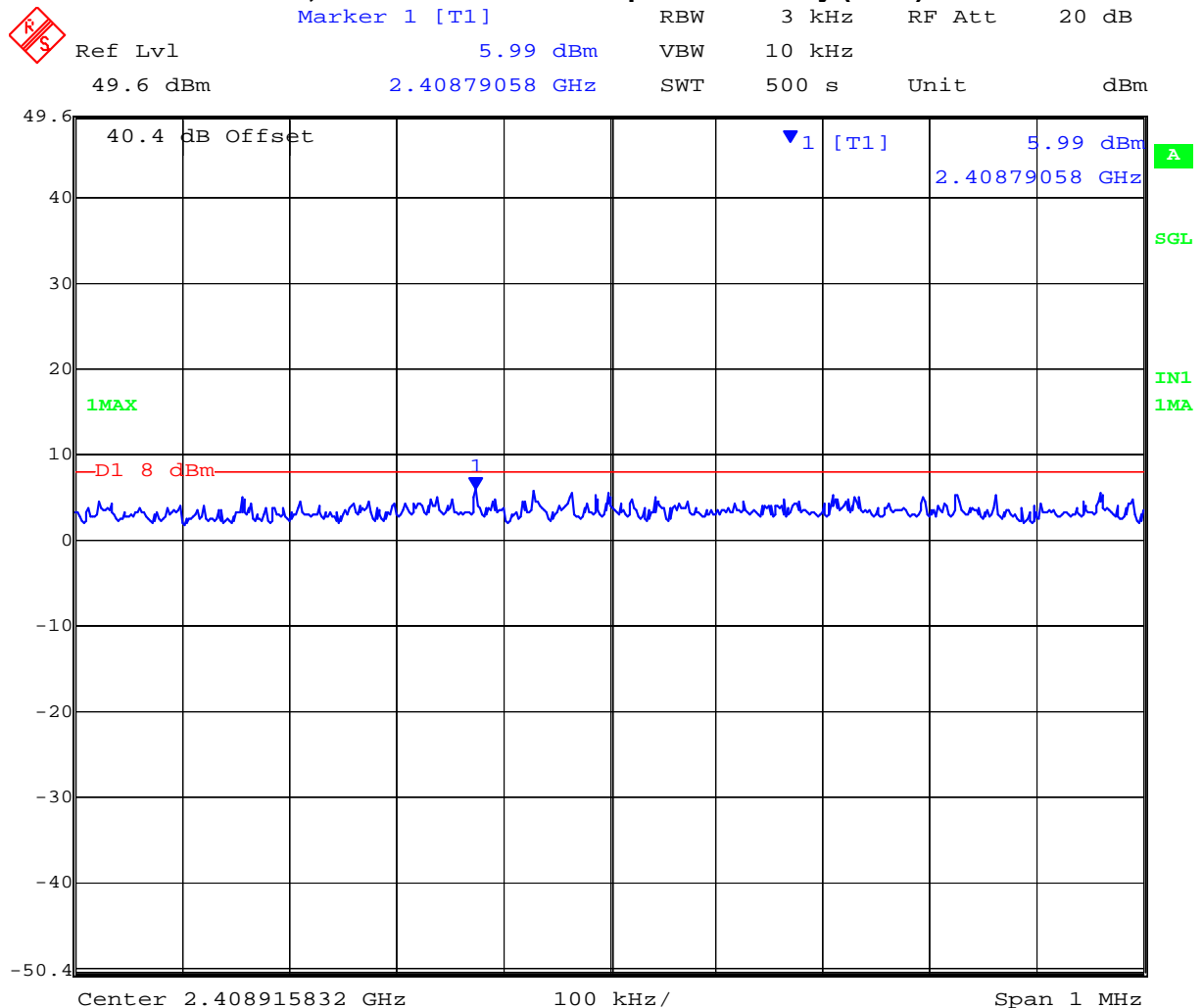

Date: 31.OCT.2005 09:39:21

This test report may be reproduced in full only. The document may only be updated by MiCOM Labs personnel. Any changes will be noted in the Document History section of the report.



Title: Exalt EX-2.4i-16 Fixed Link Radio
To: FCC 47 CFR Part15.247 & IC RSS-210
Serial #: EXLT19-A1 Rev A
Issue Date: 28th Feb 2007
Page: 63 of 248

TABLE OF RESULTS – 18 MHz Bandwidth QPSK Modulation

Center Frequency (MHz)	Peak Frequency (MHz)	PPSD (dBm)	Plot #
2,437	2436.85671	2.05	40

Plot 40
2,437 MHz Peak Power Spectral Density (dBm)

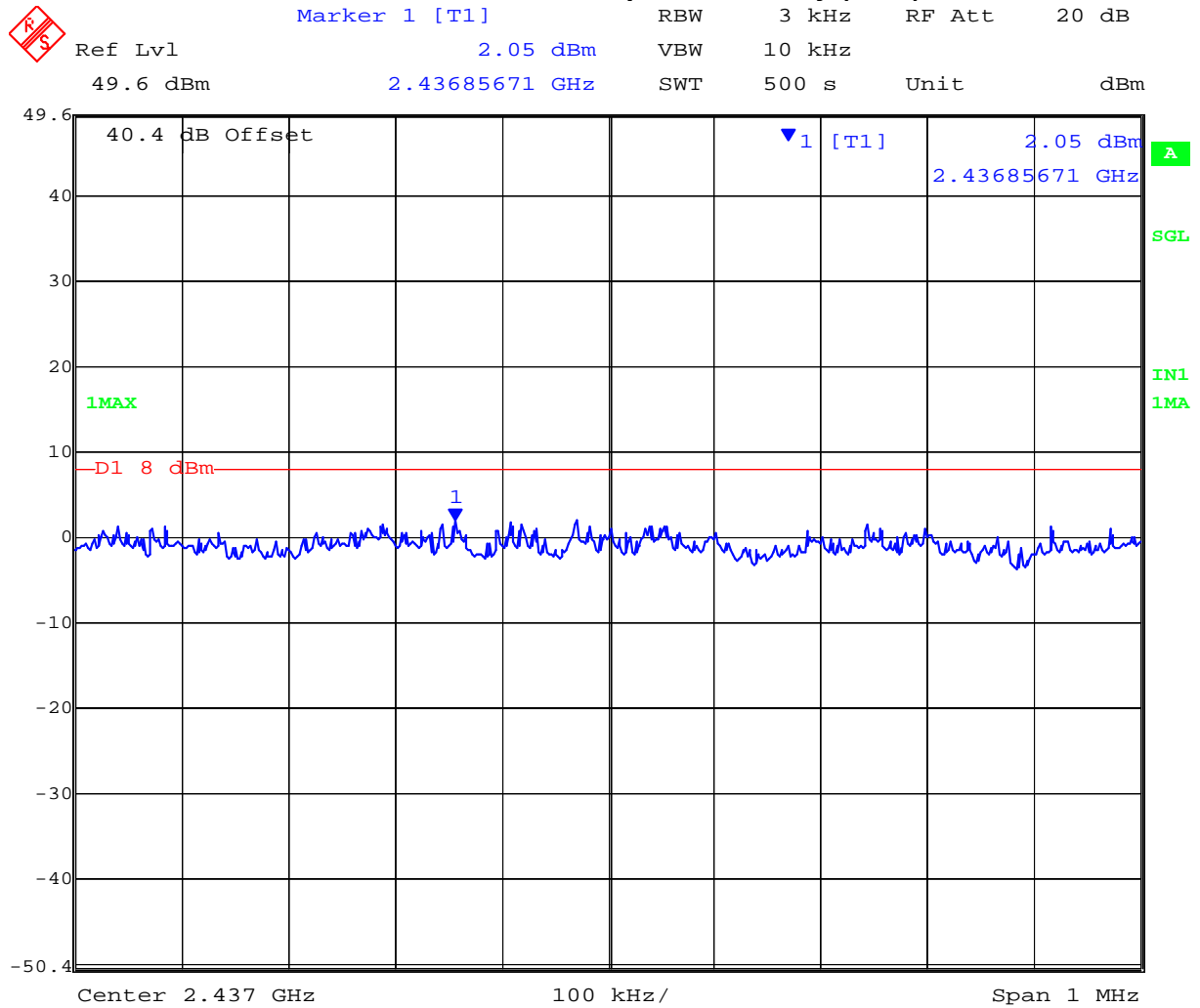

Date: 31.OCT.2005 08:52:11

This test report may be reproduced in full only. The document may only be updated by MiCOM Labs personnel. Any changes will be noted in the Document History section of the report.



Title: Exalt EX-2.4i-16 Fixed Link Radio
To: FCC 47 CFR Part15.247 & IC RSS-210
Serial #: EXLT19-A1 Rev A
Issue Date: 28th Feb 2007
Page: 64 of 248

TABLE OF RESULTS – 18 MHz Bandwidth 16QAM Modulation

Center Frequency (MHz)	Peak Frequency (MHz)	PPSD (dBm)	Plot #
2,437	2440.90681	0.95	41

Plot 41
2,437 MHz Peak Power Spectral Density (dBm)

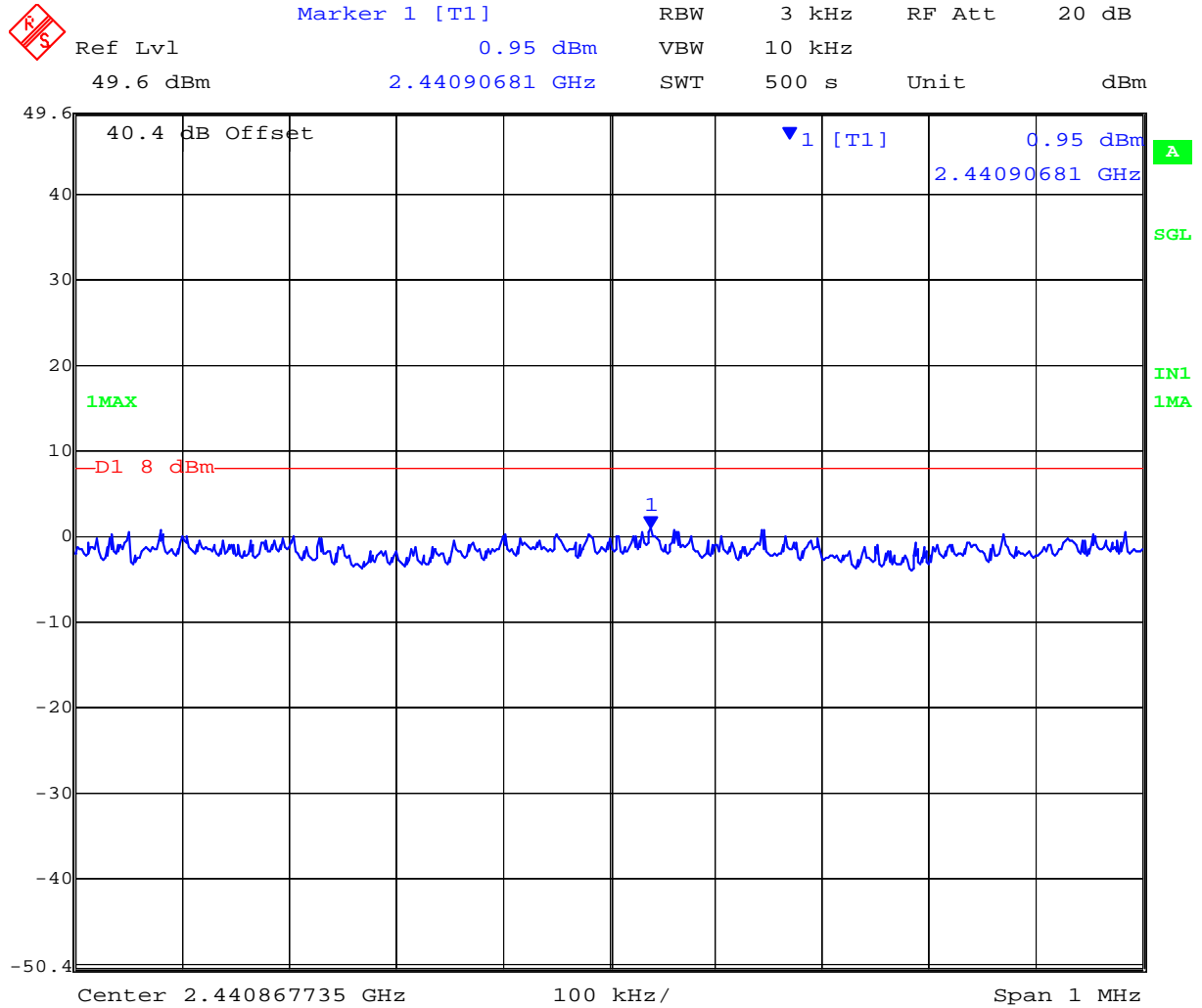

Date: 31.OCT.2005 11:50:00

This test report may be reproduced in full only. The document may only be updated by MiCOM Labs personnel. Any changes will be noted in the Document History section of the report.



Title: Exalt EX-2.4i-16 Fixed Link Radio
To: FCC 47 CFR Part15.247 & IC RSS-210
Serial #: EXLT19-A1 Rev A
Issue Date: 28th Feb 2007
Page: 65 of 248

TABLE OF RESULTS – 18 MHz Bandwidth 64QAM Modulation

Center Frequency (MHz)	Peak Frequency (MHz)	PPSD (dBm)	Plot #
2,437	2435.02906	0.84	42

Plot 42
2,437 MHz Peak Power Spectral Density (dBm)

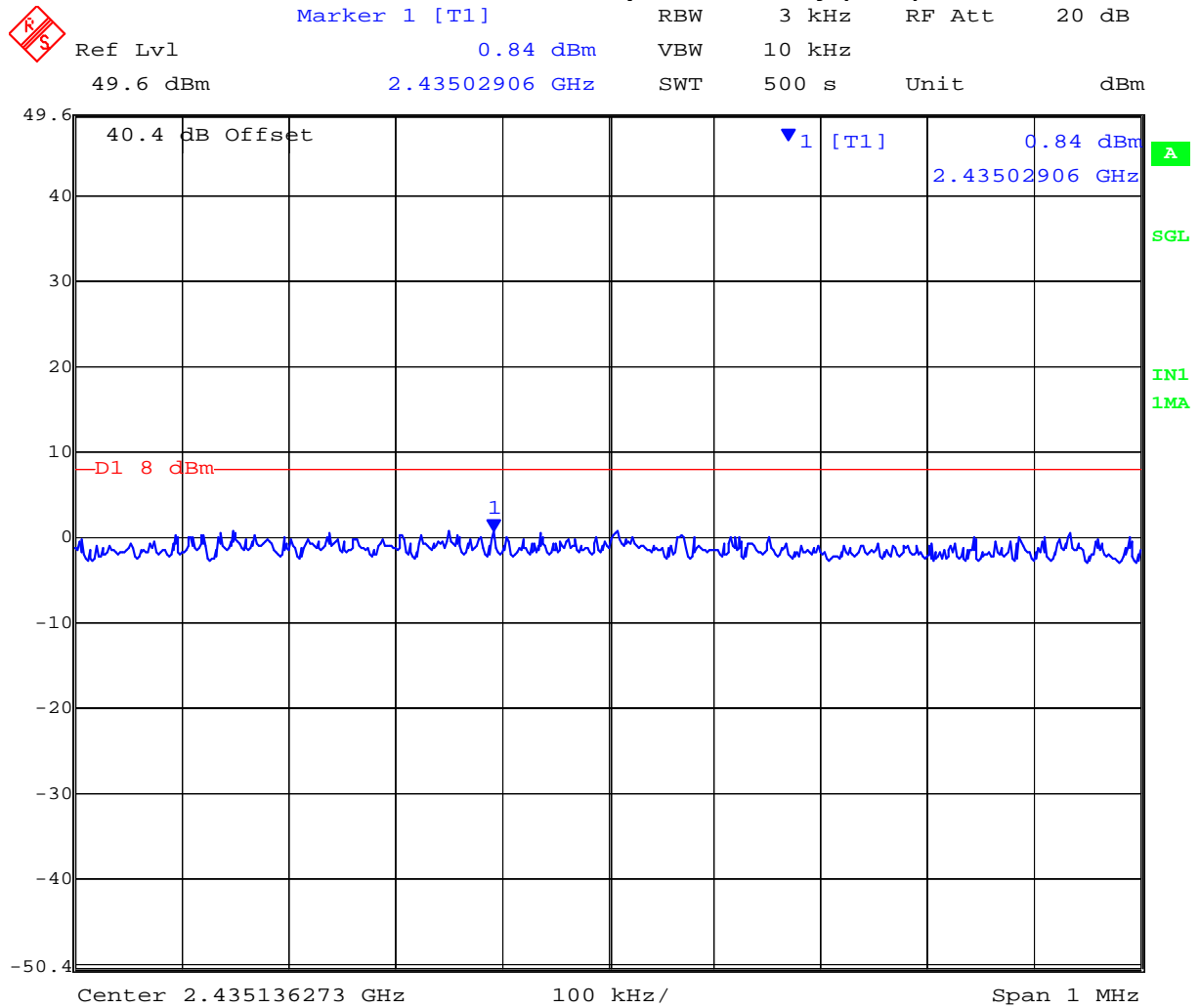

Date: 31.OCT.2005 12:01:04

This test report may be reproduced in full only. The document may only be updated by MiCOM Labs personnel. Any changes will be noted in the Document History section of the report.



Title: Exalt EX-2.4i-16 Fixed Link Radio
To: FCC 47 CFR Part15.247 & IC RSS-210
Serial #: EXLT19-A1 Rev A
Issue Date: 28th Feb 2007
Page: 66 of 248

TABLE OF RESULTS – 36 MHz Bandwidth QPSK Modulation

Center Frequency (MHz)	Peak Frequency (MHz)	PPSD (dBm)	Plot #
2,437	2429.64228	-2.18	43

Plot 43
2,437 MHz Peak Power Spectral Density (dBm)

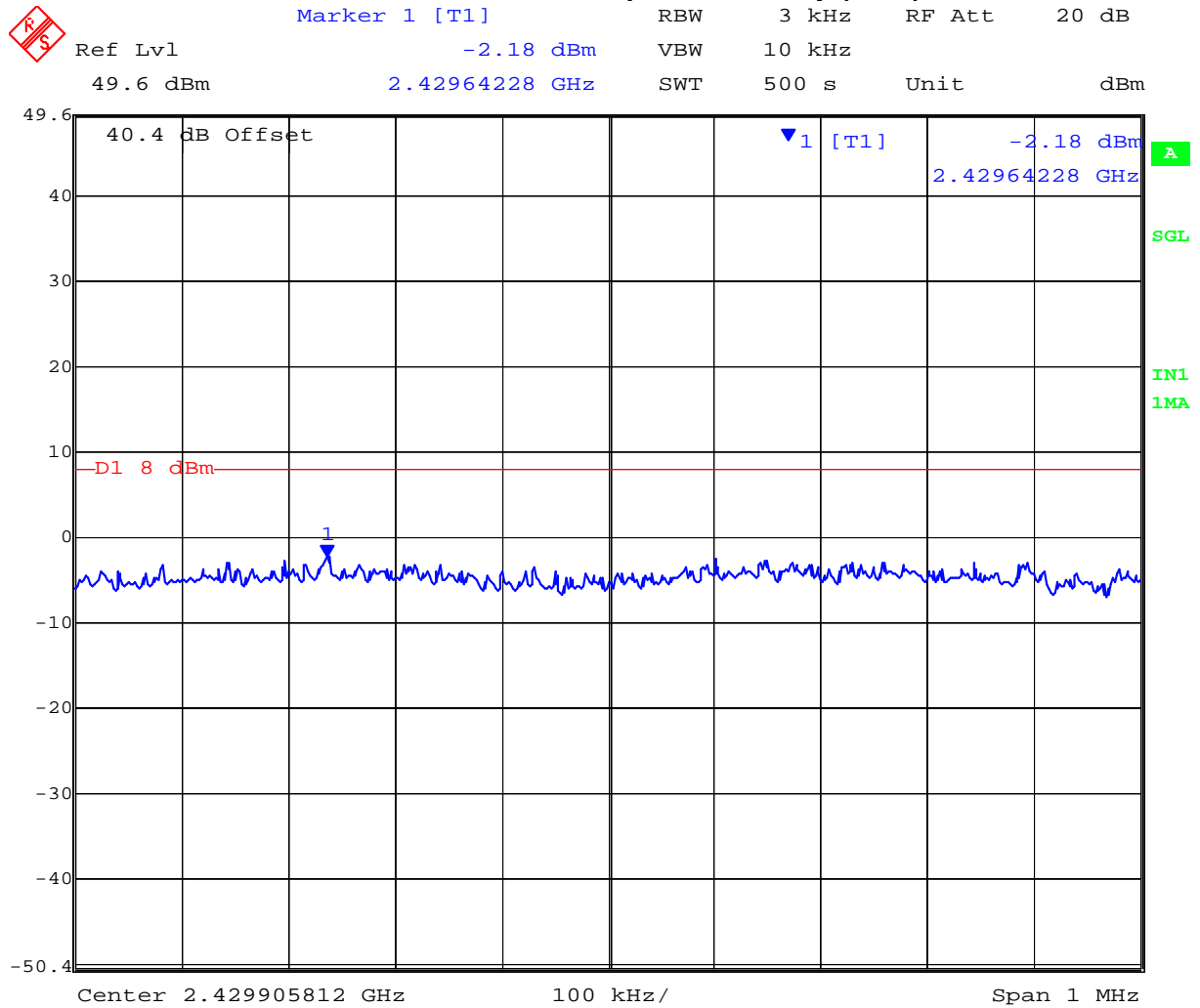

Date: 31.OCT.2005 10:24:24

This test report may be reproduced in full only. The document may only be updated by MiCOM Labs personnel. Any changes will be noted in the Document History section of the report.



Title: Exalt EX-2.4i-16 Fixed Link Radio
To: FCC 47 CFR Part15.247 & IC RSS-210
Serial #: EXLT19-A1 Rev A
Issue Date: 28th Feb 2007
Page: 67 of 248

TABLE OF RESULTS – 36 MHz Bandwidth 16QAM Modulation

Center Frequency (MHz)	Peak Frequency (MHz)	PPSD (dBm)	Plot #
2,437	2425.91483	-1.61	44

Plot 44
2,437 MHz Peak Power Spectral Density (dBm)

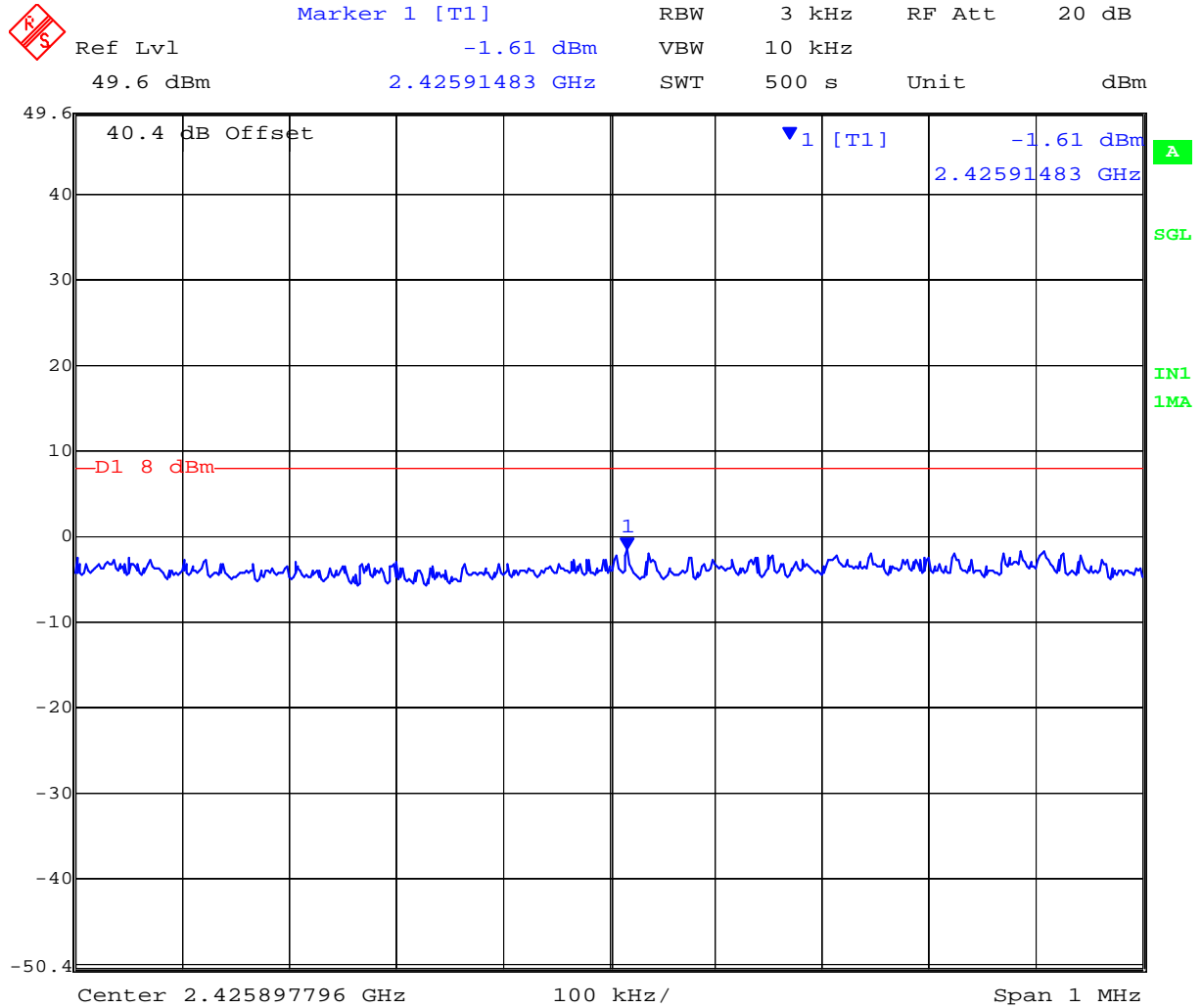

Date: 31.OCT.2005 10:35:34

This test report may be reproduced in full only. The document may only be updated by MiCOM Labs personnel. Any changes will be noted in the Document History section of the report.



Title: Exalt EX-2.4i-16 Fixed Link Radio
To: FCC 47 CFR Part15.247 & IC RSS-210
Serial #: EXLT19-A1 Rev A
Issue Date: 28th Feb 2007
Page: 68 of 248

TABLE OF RESULTS – 36 MHz Bandwidth 64QAM Modulation

Center Frequency (MHz)	Peak Frequency (MHz)	PPSD (dBm)	Plot #
2,437	2424.42786	-1.90	45

Plot 45
2,437 MHz Peak Power Spectral Density (dBm)

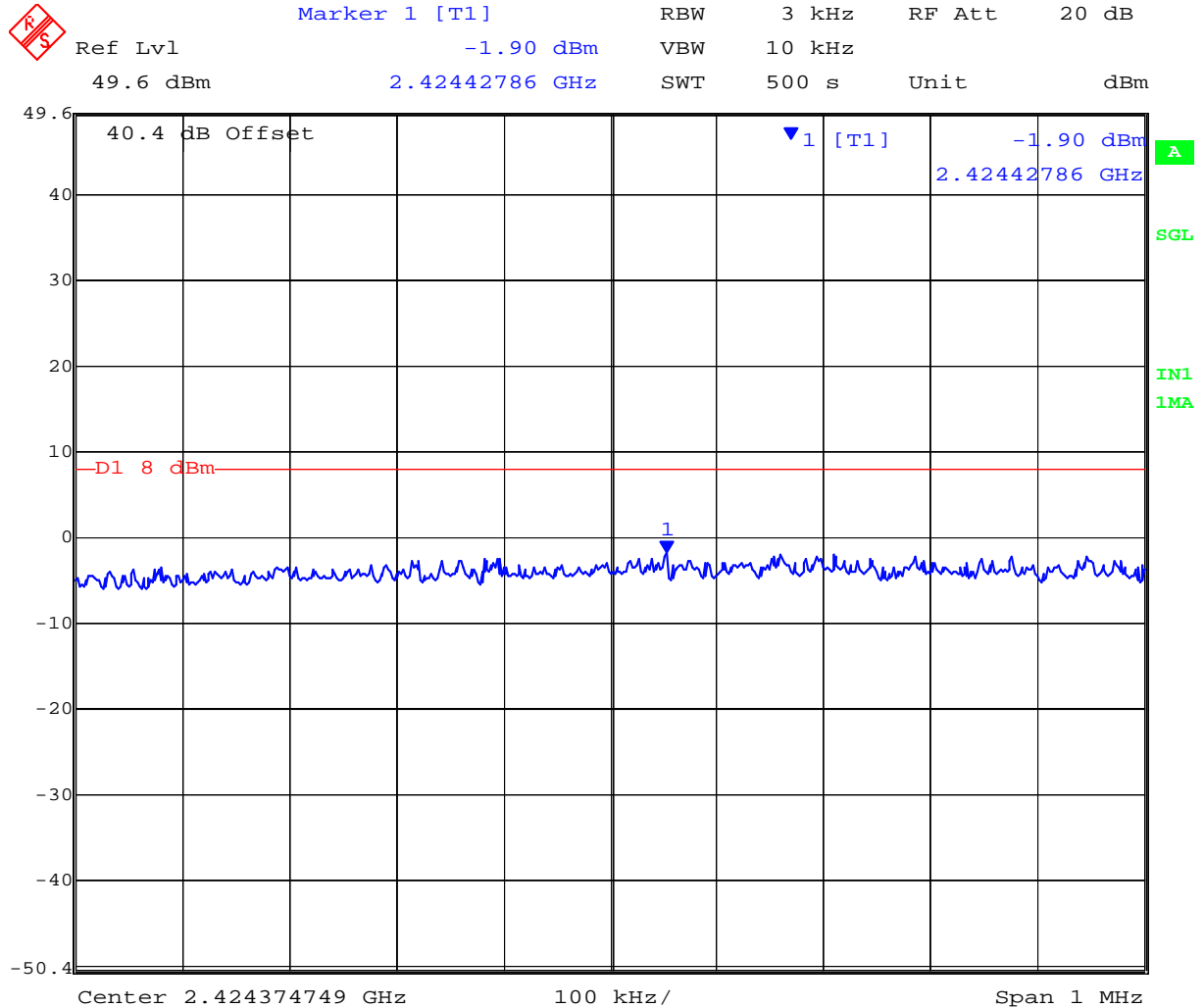

Date: 31.OCT.2005 11:02:58

This test report may be reproduced in full only. The document may only be updated by MiCOM Labs personnel. Any changes will be noted in the Document History section of the report.



Title: Exalt EX-2.4i-16 Fixed Link Radio
To: FCC 47 CFR Part15.247 & IC RSS-210
Serial #: EXLT19-A1 Rev A
Issue Date: 28th Feb 2007
Page: 69 of 248

TABLE OF RESULTS – 72 MHz Bandwidth QPSK Modulation

Center Frequency (MHz)	Peak Frequency (MHz)	PPSD (dBm)	Plot #
2,437	2437.58317	-4.13	46

Plot 46
2,437 MHz Peak Power Spectral Density (dBm)

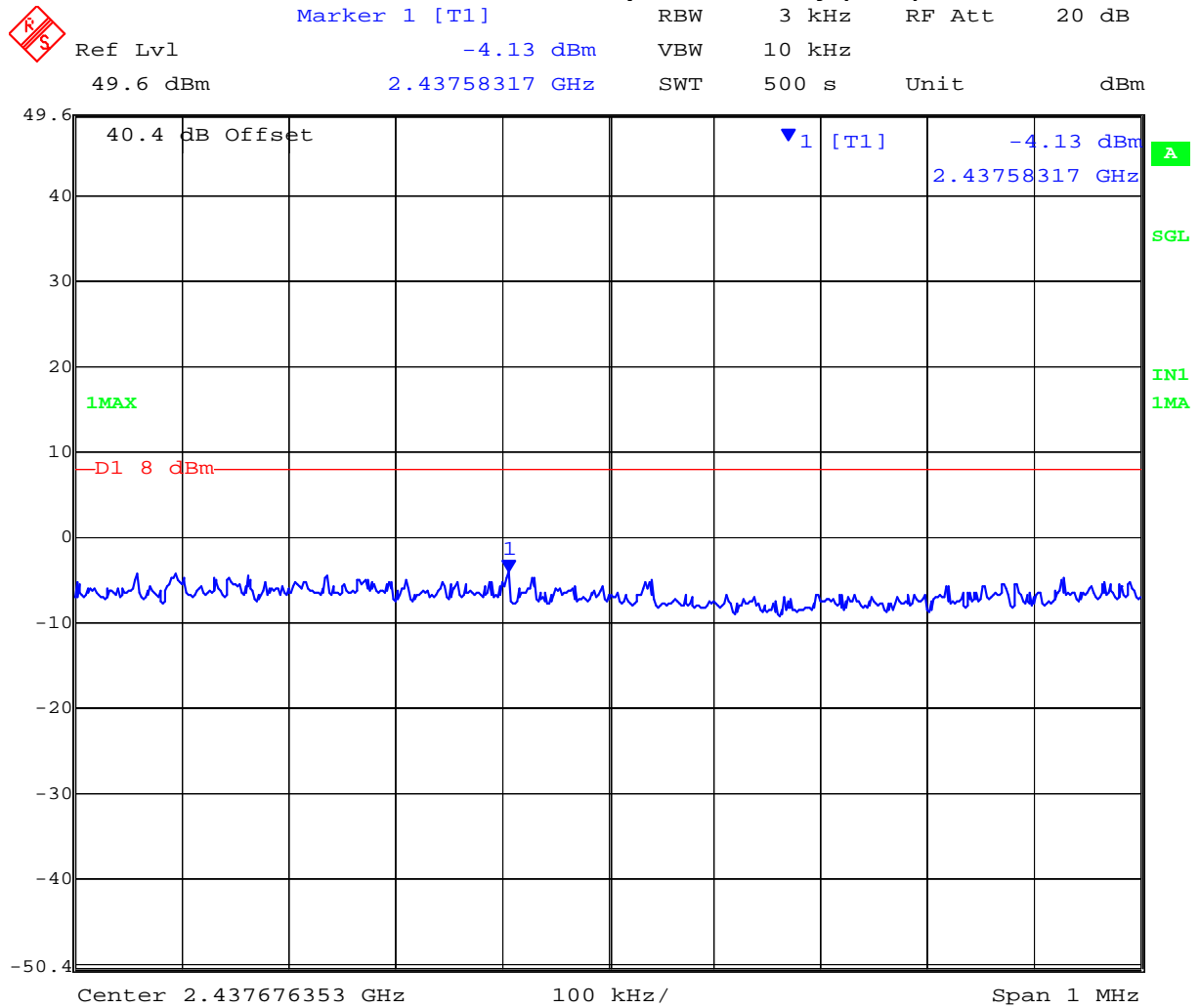

Date: 31.OCT.2005 11:14:43

This test report may be reproduced in full only. The document may only be updated by MiCOM Labs personnel. Any changes will be noted in the Document History section of the report.



Title: Exalt EX-2.4i-16 Fixed Link Radio
To: FCC 47 CFR Part15.247 & IC RSS-210
Serial #: EXLT19-A1 Rev A
Issue Date: 28th Feb 2007
Page: 70 of 248

TABLE OF RESULTS – 72 MHz Bandwidth 16QAM Modulation

Center Frequency (MHz)	Peak Frequency (MHz)	PPSD (dBm)	Plot #
2,437	2428.50902	-4.08	47

Plot 47
2,437 MHz Peak Power Spectral Density (dBm)

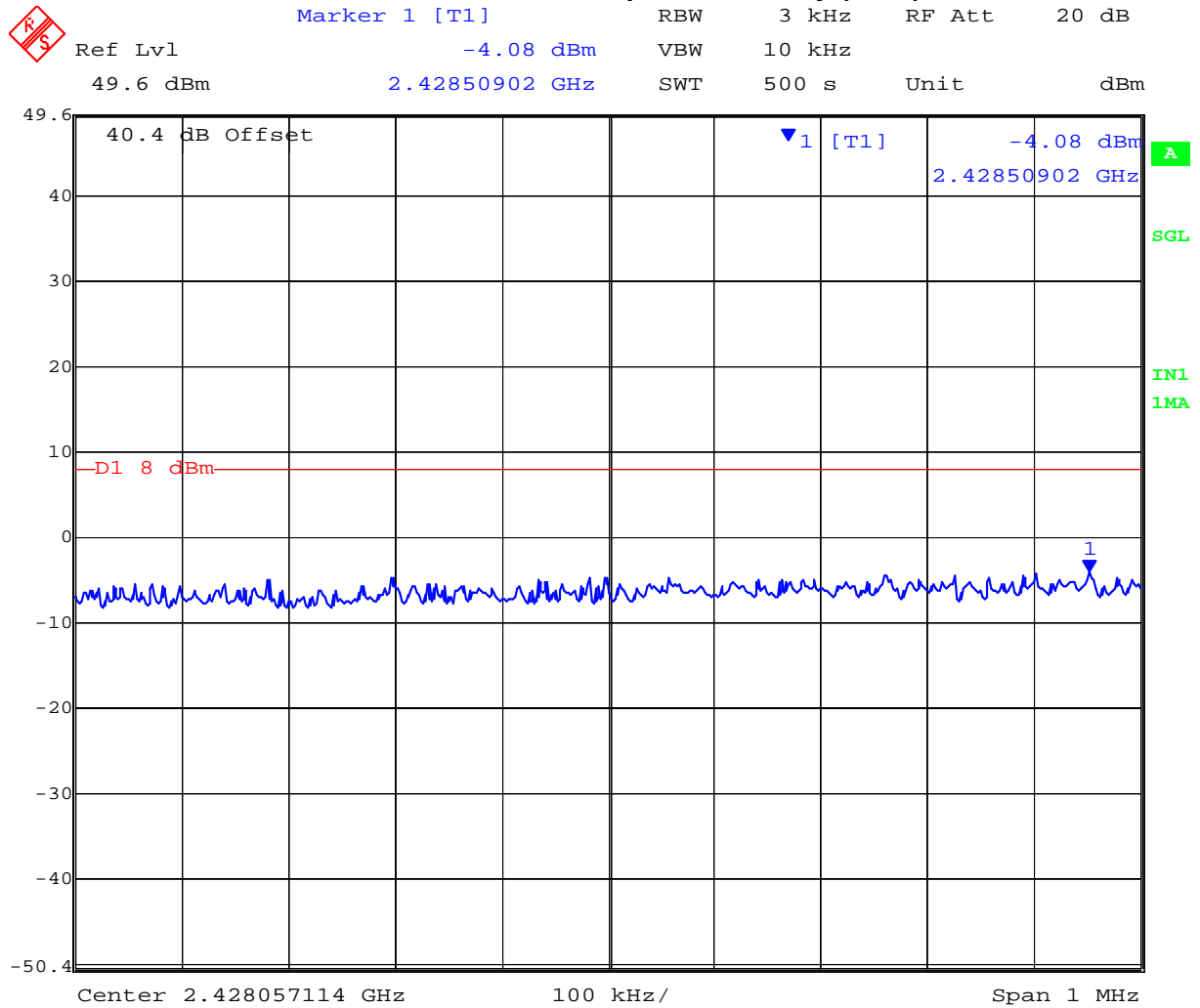

Date: 31.OCT.2005 11:27:09

This test report may be reproduced in full only. The document may only be updated by MiCOM Labs personnel. Any changes will be noted in the Document History section of the report.



Title: Exalt EX-2.4i-16 Fixed Link Radio
To: FCC 47 CFR Part15.247 & IC RSS-210
Serial #: EXLT19-A1 Rev A
Issue Date: 28th Feb 2007
Page: 71 of 248

TABLE OF RESULTS – 72 MHz Bandwidth 64QAM Modulation

Center Frequency (MHz)	Peak Frequency (MHz)	PPSD (dBm)	Plot #
2,437	2420.96994	-4.53	48

Plot 48
2,437 MHz Peak Power Spectral Density (dBm)

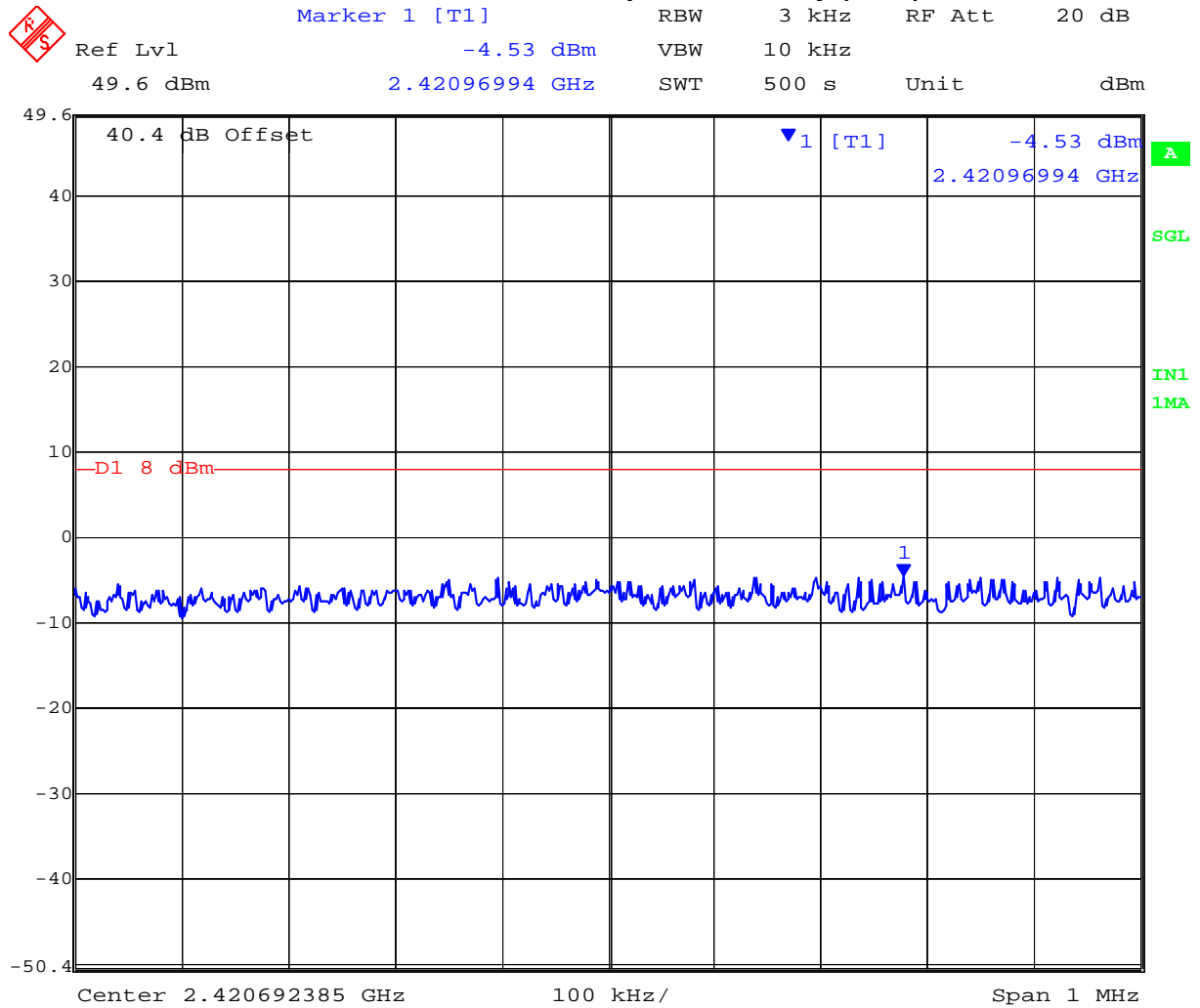

Date: 31.OCT.2005 11:37:46

This test report may be reproduced in full only. The document may only be updated by MiCOM Labs personnel. Any changes will be noted in the Document History section of the report.



Title: Exalt EX-2.4i-16 Fixed Link Radio
To: FCC 47 CFR Part15.247 & IC RSS-210
Serial #: EXLT19-A1 Rev A
Issue Date: 28th Feb 2007
Page: 72 of 248

Specification
Peak Power Spectral Density Limits

§15.247 (d) For direct sequence systems the peak power spectral density conducted from the intentional radiator to the antenna shall not be greater than +8 dBm in any 3 kHz band during any time interval of continuous transmission

IC-RSS-210 § A8.2(2) The transmitter power spectral density (into the antenna) shall not be greater than 8 dBm in any 3 kHz band during any time interval of continuous transmission or over 1.0 second if the transmission exceeds 1.0 second duration.

Laboratory Measurement Uncertainty for Spectral Density

Measurement uncertainty	±1.33 dB
-------------------------	----------

Traceability

Method	Test Equipment Used
Measurements were made per work instruction WI-01 'Measuring RF Output Power'	0070, 0116, 0158, 0193, 0252, 0313, 0314

This test report may be reproduced in full only. The document may only be updated by MiCOM Labs personnel. Any changes will be noted in the Document History section of the report.



5.1.4. Maximum Permissible Exposure

FCC, Part 15 Subpart C §15.247(i), §1.1310
Industry Canada RSS-102

Calculations for Maximum Permissible Exposure Levels

$$\text{Power Density} = P_d \text{ (mW/cm}^2\text{)} = \text{EIRP}/(4\pi d^2)$$

$$\text{EIRP} = P * G$$

P = Peak output power (mW)

G = Antenna numeric gain (numeric)

d = Separation distance (cm)

$$\text{Numeric Gain} = 10 ^ (G \text{ (dBi)}/10)$$

P (worst case) = +29.96 dBm, 990.80 mW

Antenna Gain (Worst Case) = 30.3 dBi, 1071.5 numeric

Because the EUT belongs to the General Population/Uncontrolled Exposure the limit of power density is 1.0 mW/cm²

The MPE calculations are calculated using the maximum allowable power levels calculated for each antenna in Section 5.1.2 "Peak Output Power" of the report.

Antenna Gain (dBi)	Numeric Gain (numeric)	Max Allowable Peak Power (dBm)	Max Allowable Peak Power (mW)	Calculated Safe Distance at 1 mW/cm ² (cm)
21.3	134.9	24.9	309.03	57.60
30.3	1071.5	21.9	154.88	114.92
20.0	100	25.3	338.84	51.93



Title: Exalt EX-2.4i-16 Fixed Link Radio
To: FCC 47 CFR Part15.247 & IC RSS-210
Serial #: EXLT19-A1 Rev A
Issue Date: 28th Feb 2007
Page: 74 of 248

Specification

Maximum Permissible Exposure Limits

§15.247 (b)(5) Systems operating under the provisions of this section shall be operated in a manner that ensures that the public is not exposed to radio frequency levels in excess of the Commission's guidelines. See §1.1307 (b)(1) of this chapter.

Limit S = 1mW / cm² from 1.310 Table 1

Note: for mobile or fixed location transmitters the minimum separation distance is 20cm, even if calculations indicate the MPE distance to be less.

IC-RSS-Gen §5.5 Before equipment certification is granted, the procedures of RSS-102 shall be met.

Laboratory Measurement Uncertainty for Power Measurements

Measurement uncertainty	±1.33 dB
-------------------------	----------

This test report may be reproduced in full only. The document may only be updated by MiCOM Labs personnel. Any changes will be noted in the Document History section of the report.

5.1.5. Conducted Spurious Emissions

FCC, Part 15 Subpart C §15.247(c)
Industry Canada RSS-210 § A8.5, & IC RSS-Gen § 4.7

Test Procedure

Conducted emissions were measured at a limit of 20 dB below the highest in-band spectral density measured with a spectrum analyzer connected to the antenna terminal. Emissions at the band edge were measured and recorded. Measurements were made while EUT was operating in transmit mode of operation at the appropriate center frequency.

Test Measurement Set up

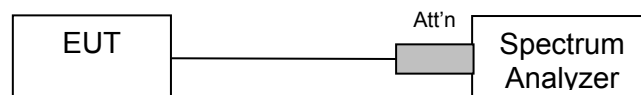

Band-edge measurement test configuration

Measurement Results of Conducted Spurious Emissions

Ambient conditions.

Temperature: 19 to 26 °C Relative humidity: 31 to 57 % Pressure: 999 to 1009 mbar



Conducted Band-Edge Results

TABLE OF RESULTS – 9 MHz Bandwidth QPSK Modulation

Center Frequency (MHz)	Band edge Frequency (MHz)	Limit (20 dB below peak of fundamental)	Amplitude @ Band edge (dBm)	Plot #	Margin (dB)
2,406	2,400	1.30	-4.81	49	-6.11
2,468	2,483.5	1.90	-36.27	50	-38.17

Plot 49
9 MHz Bandwidth QPSK Modulation
Conducted Spurious Emissions at the 2,400 MHz Band Edge

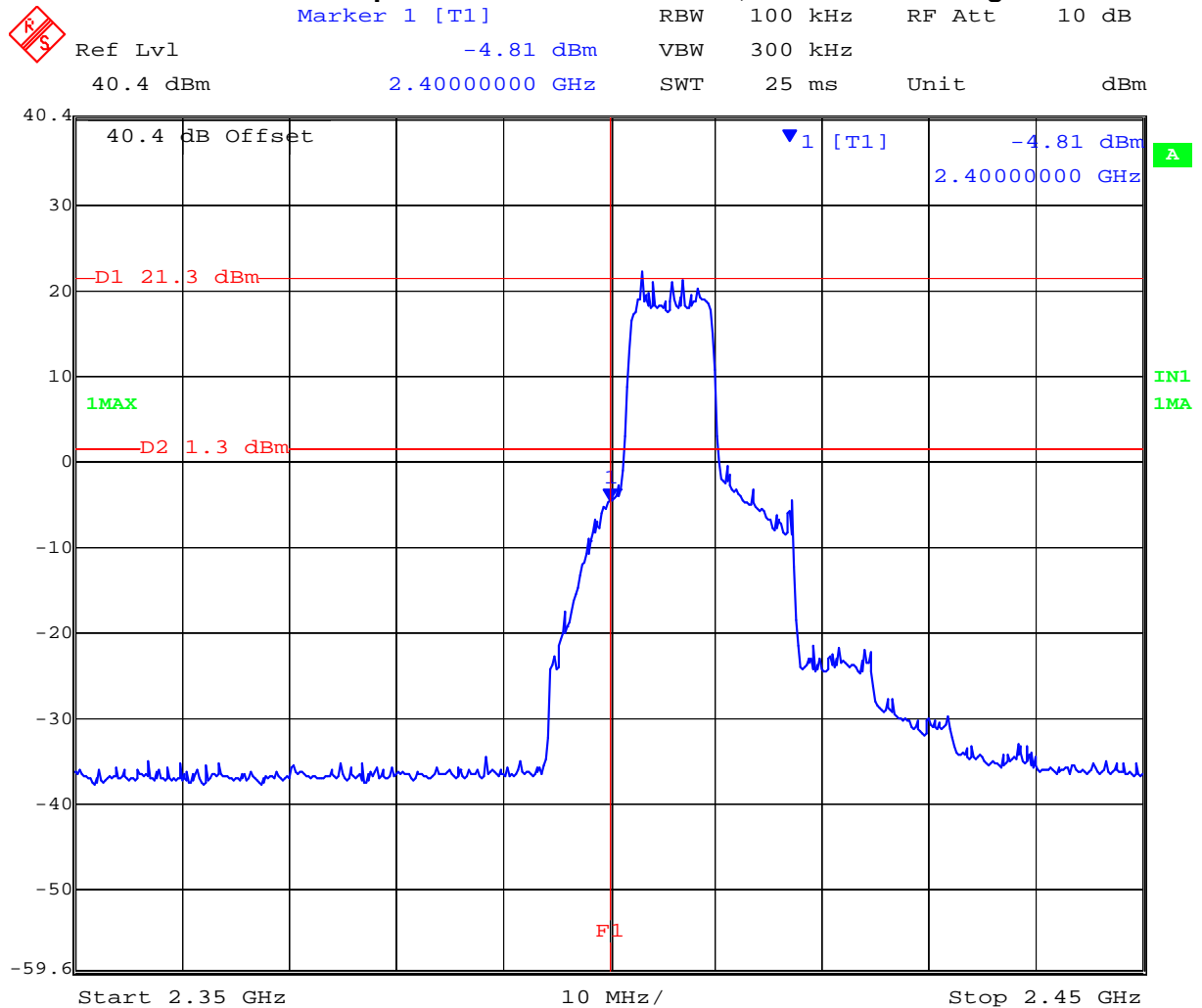

Date: 31.OCT.2005 14:02:35

This test report may be reproduced in full only. The document may only be updated by MiCOM Labs personnel. Any changes will be noted in the Document History section of the report.



Title: Exalt EX-2.4i-16 Fixed Link Radio
To: FCC 47 CFR Part15.247 & IC RSS-210
Serial #: EXLT19-A1 Rev A
Issue Date: 28th Feb 2007
Page: 77 of 248

Plot 50
9 MHz Bandwidth QPSK Modulation
Conducted Spurious Emissions at the 2,483.5 MHz Band Edge

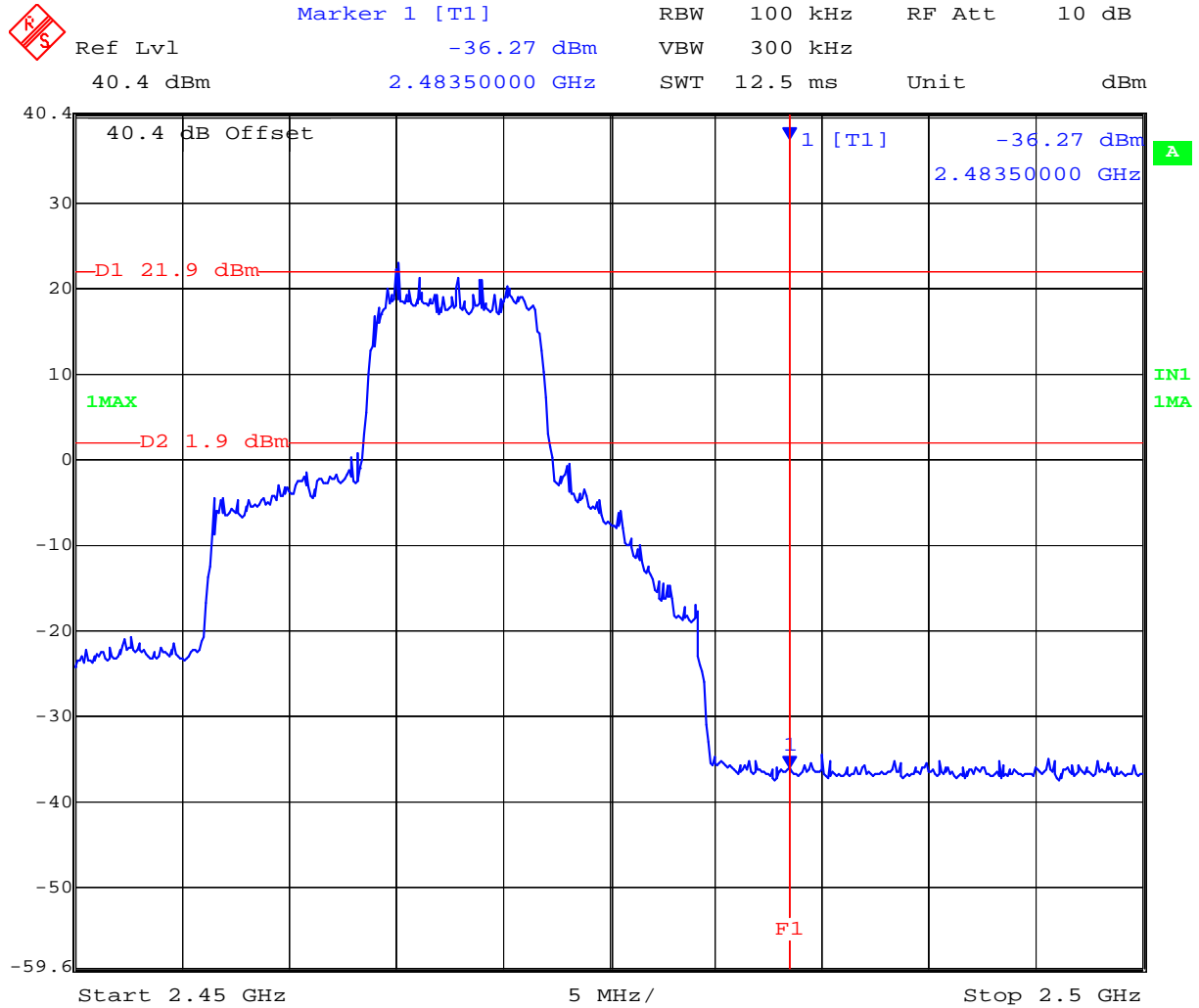

Date: 31.OCT.2005 13:14:07

This test report may be reproduced in full only. The document may only be updated by MiCOM Labs personnel. Any changes will be noted in the Document History section of the report.



TABLE OF RESULTS – 9 MHz Bandwidth 16QAM Modulation

Center Frequency (MHz)	Band edge Frequency (MHz)	Limit (20 dB below peak of fundamental)	Amplitude @ Band edge (dBm)	Plot #	Margin (dB)
2,406	2,400	1.40	-4.39	51	-5.79
2,468	2,483.5	1.30	-36.35	52	-37.65

Plot 51
9 MHz Bandwidth 16QAM Modulation
Conducted Spurious Emissions at the 2,400 MHz Band Edge

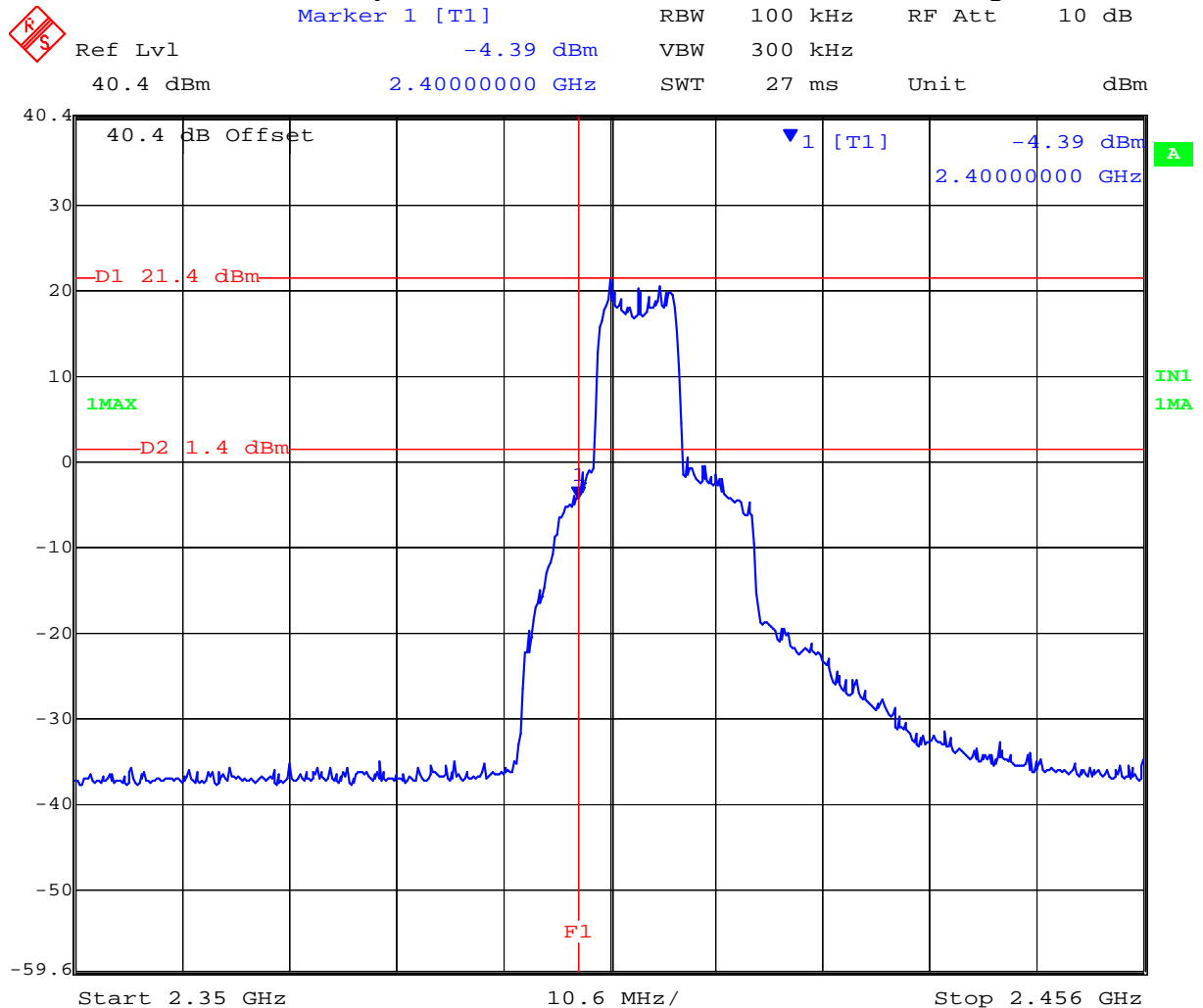

Date: 31.OCT.2005 13:07:18

This test report may be reproduced in full only. The document may only be updated by MiCOM Labs personnel. Any changes will be noted in the Document History section of the report.



Plot 52
9 MHz Bandwidth 16QAM Modulation
Conducted Spurious Emissions at the 2,483.5 MHz Band Edge

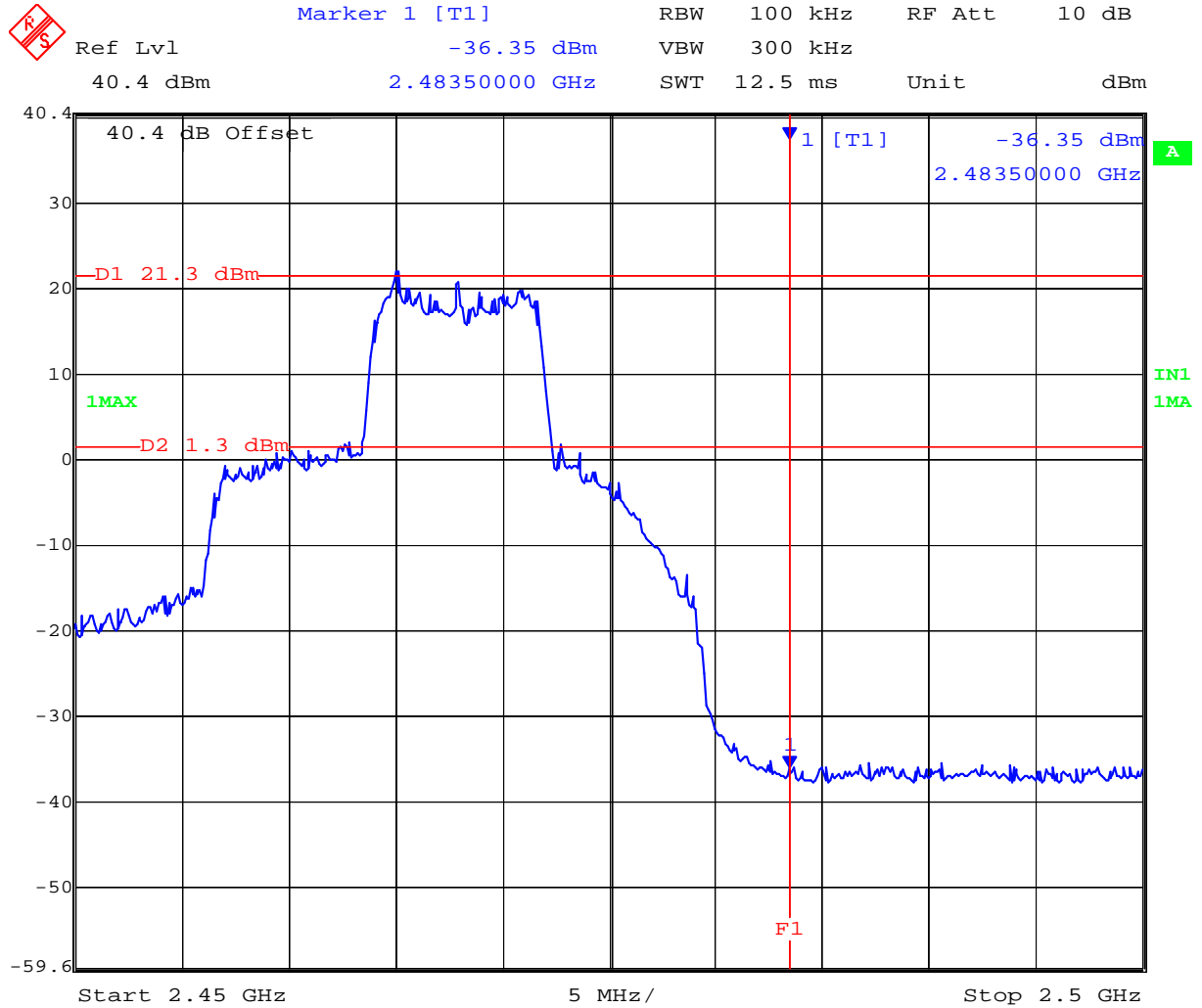

Date: 31.OCT.2005 13:17:37

This test report may be reproduced in full only. The document may only be updated by MiCOM Labs personnel. Any changes will be noted in the Document History section of the report.



Title: Exalt EX-2.4i-16 Fixed Link Radio
To: FCC 47 CFR Part15.247 & IC RSS-210
Serial #: EXLT19-A1 Rev A
Issue Date: 28th Feb 2007
Page: 80 of 248

TABLE OF RESULTS – 9 MHz Bandwidth 64QAM Modulation

Center Frequency (MHz)	Band edge Frequency (MHz)	Limit (20 dB below peak of fundamental)	Amplitude @ Band edge (dBm)	Plot #	Margin (dB)
2,406	2,400	1.40	-3.65	53	-5.05
2,468	2,483.5	1.30	-37.13	54	-38.43

Plot 53

9 MHz Bandwidth 64QAM Modulation

Conducted Spurious Emissions at the 2,400 MHz Band Edge

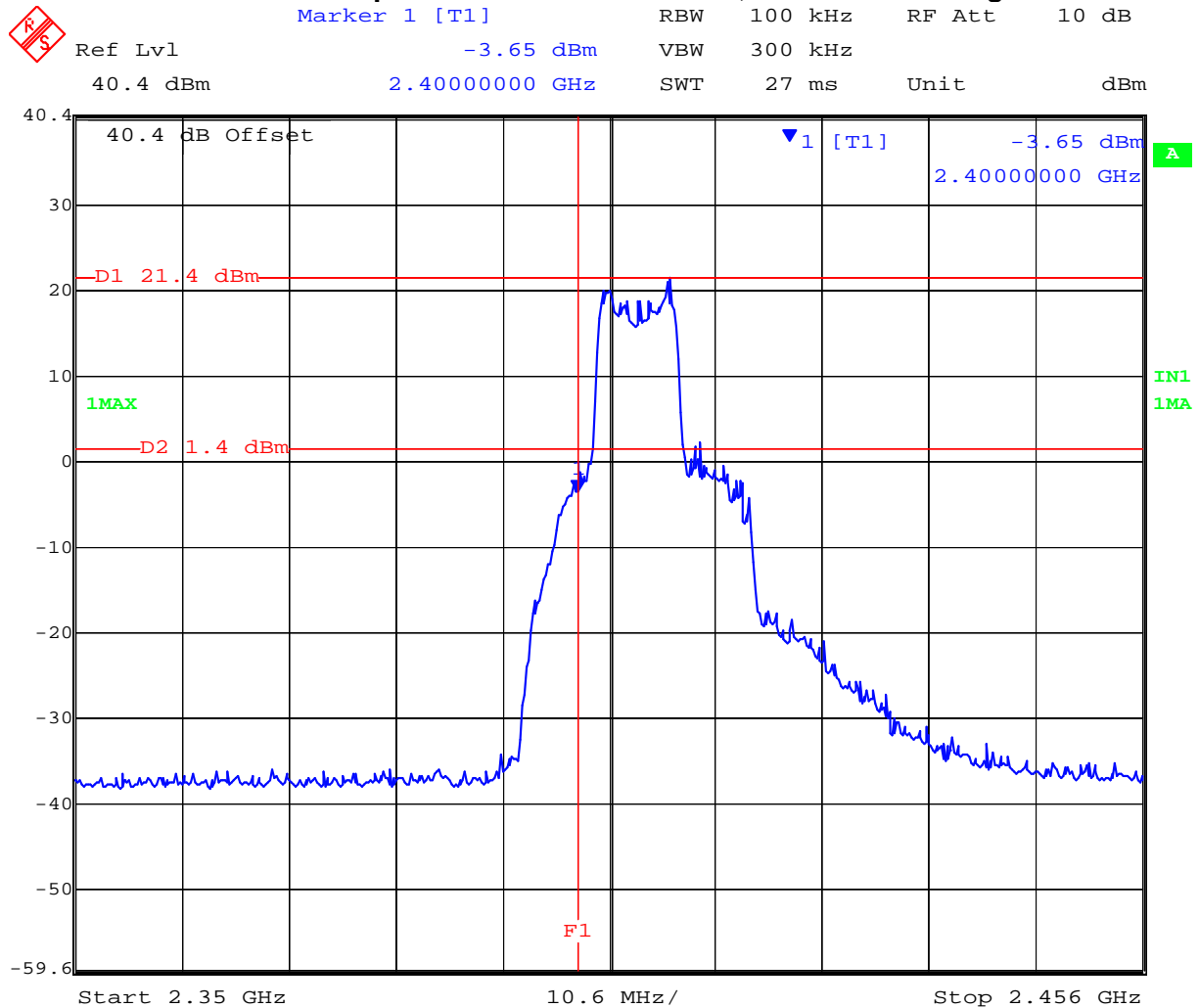

Date: 31.OCT.2005 13:09:42

This test report may be reproduced in full only. The document may only be updated by MiCOM Labs personnel. Any changes will be noted in the Document History section of the report.



Plot 54

9 MHz Bandwidth 64QAM Modulation

Conducted Spurious Emissions at the 2,483.5 MHz Band Edge

Marker 1 [T1] RBW 100 kHz RF Att 10 dB
Ref Lvl -37.13 dBm VBW 300 kHz
40.4 dBm 2.48350000 GHz SWT 12.5 ms Unit dBm

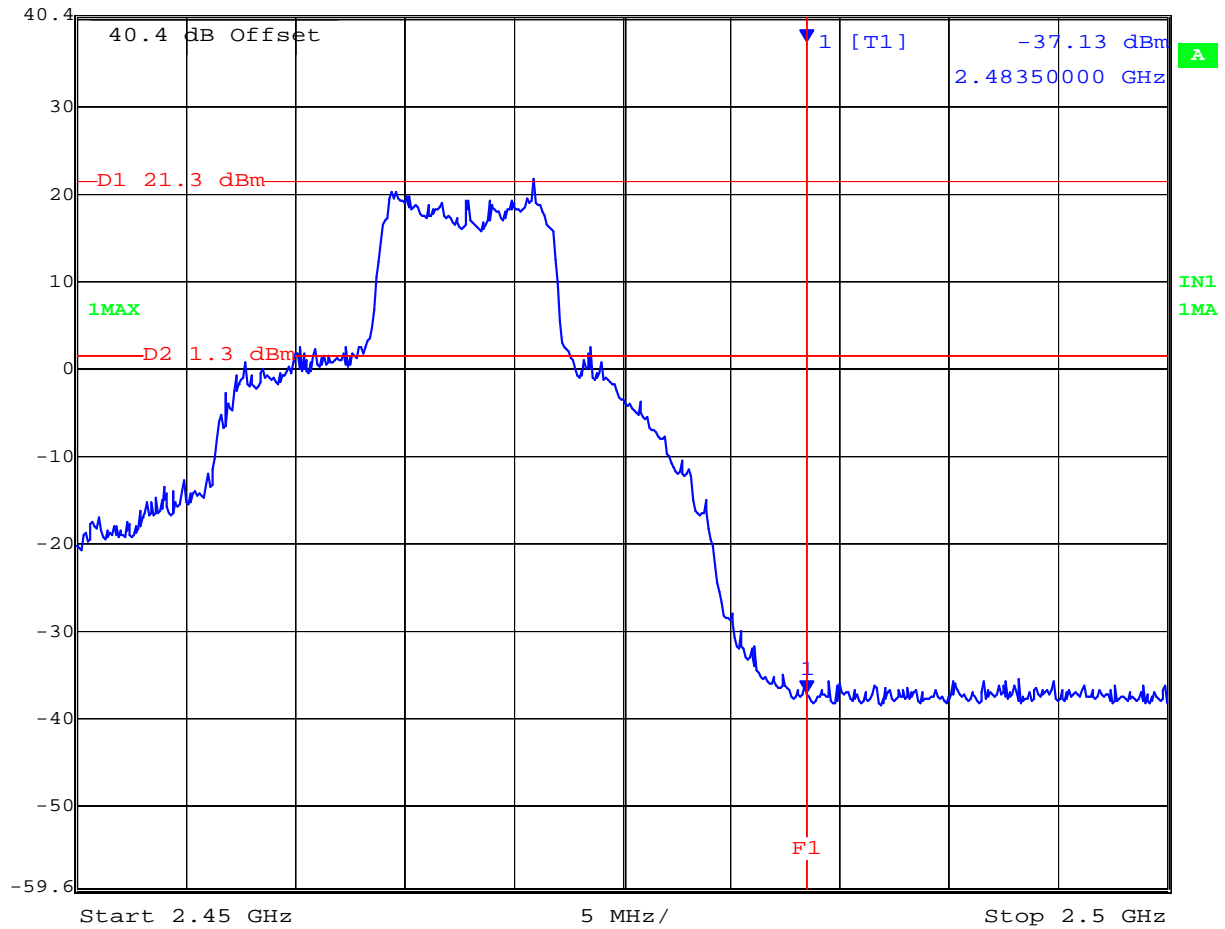

Date: 31.OCT.2005 13:19:26

This test report may be reproduced in full only. The document may only be updated by MiCOM Labs personnel. Any changes will be noted in the Document History section of the report.



TABLE OF RESULTS – 18 MHz Bandwidth QPSK Modulation

Center Frequency (MHz)	Band edge Frequency (MHz)	Limit (20 dB below peak of fundamental)	Amplitude @ Band edge (dBm)	Plot #	Margin (dB)
2,417	2,400	-0.60	-12.78	55	-12.18
2,465	2,483.5	-2.50	-36.80	56	-34.30

Plot 55

18 MHz Bandwidth QPSK Modulation

Conducted Spurious Emissions at the 2,400 MHz Band Edge

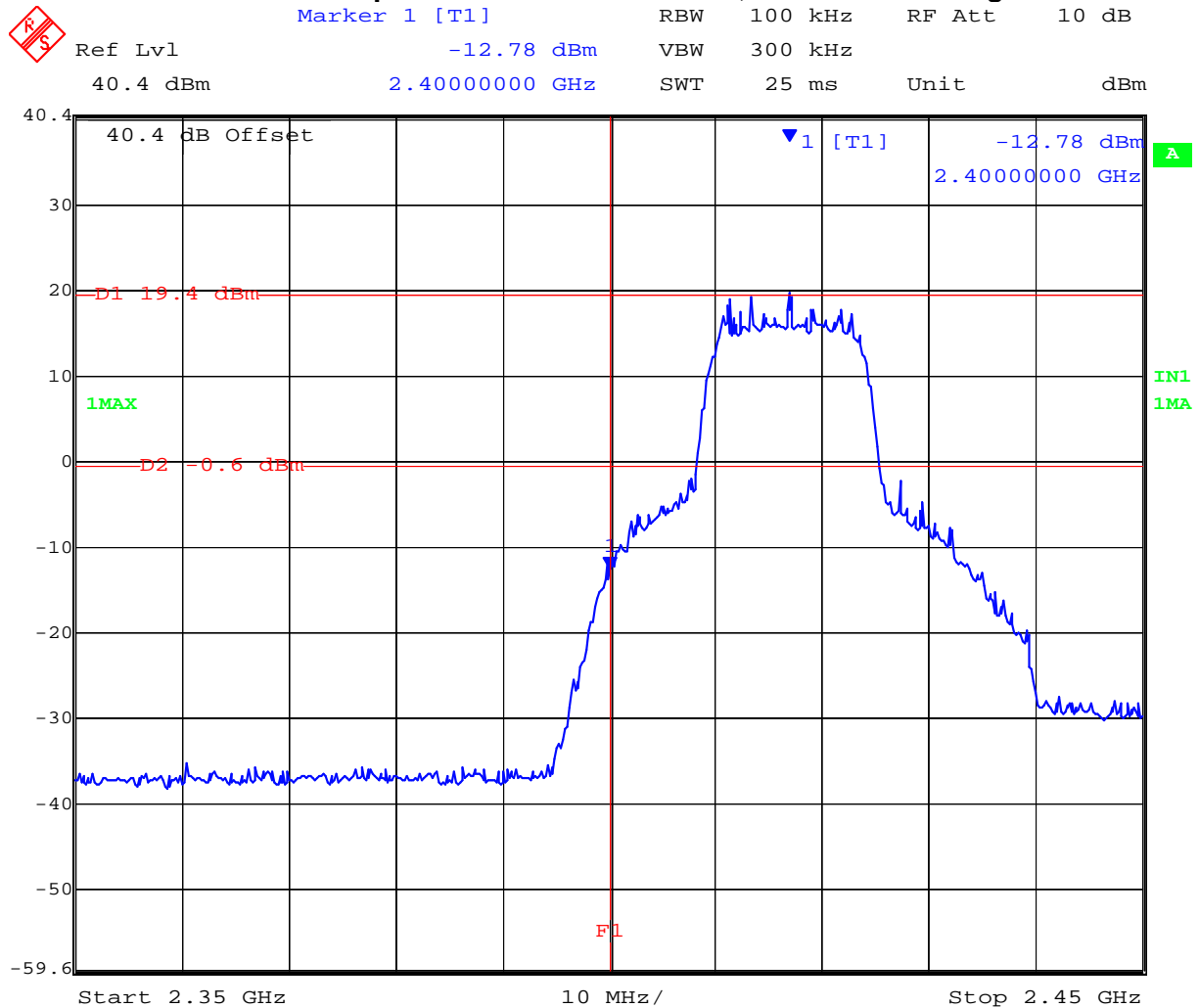

Date: 31.OCT.2005 13:23:28

This test report may be reproduced in full only. The document may only be updated by MiCOM Labs personnel. Any changes will be noted in the Document History section of the report.



Plot 56

18 MHz Bandwidth QPSK Modulation

Conducted Spurious Emissions at the 2,483.5 MHz Band Edge

 Ref Lvl 40.4 dBm
Marker 1 [T1] -36.80 dBm
RBW 100 kHz
RF Att 10 dB
VBW 300 kHz
SWT 12.5 ms
Unit dBm

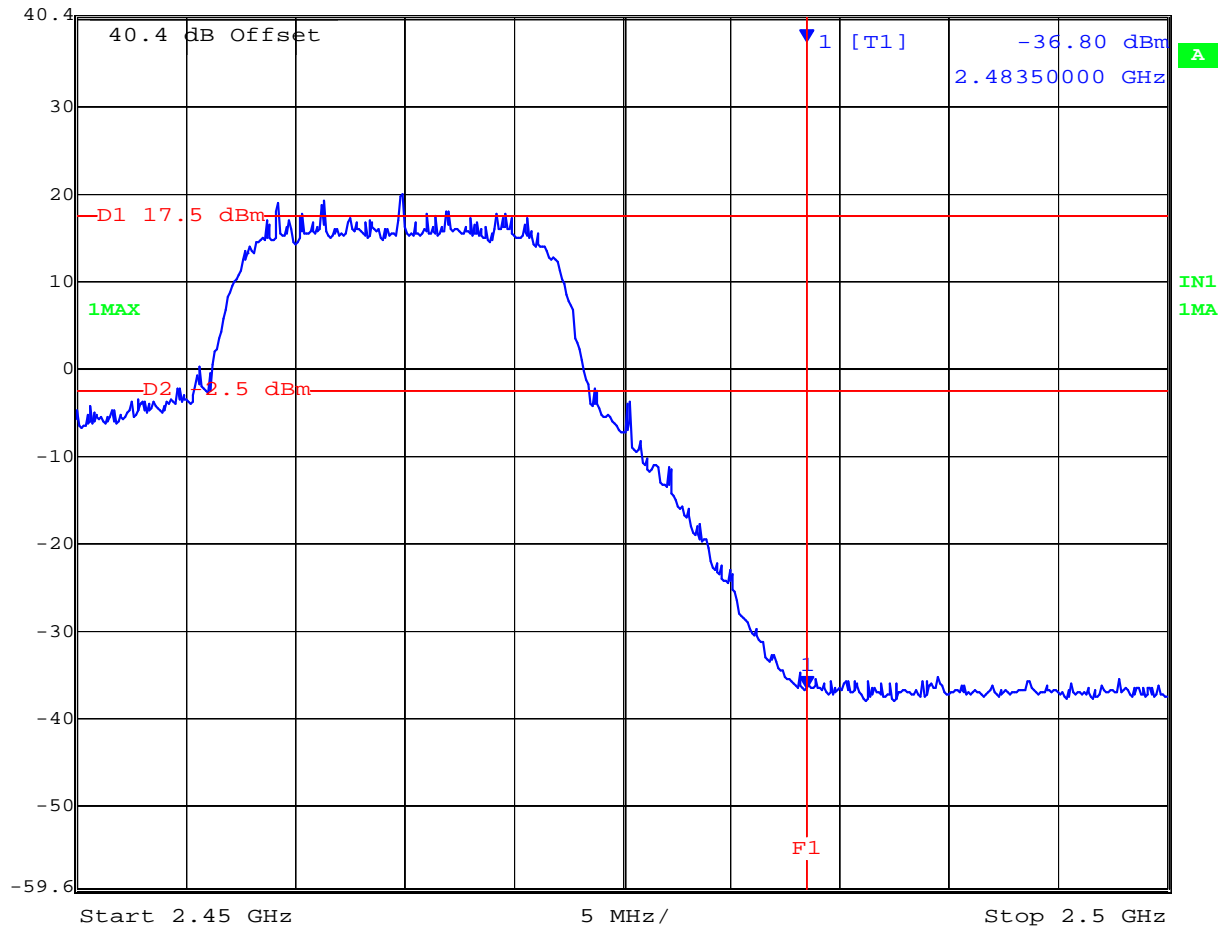

Date: 31.OCT.2005 13:34:41

This test report may be reproduced in full only. The document may only be updated by MiCOM Labs personnel. Any changes will be noted in the Document History section of the report.



TABLE OF RESULTS – 18 MHz Bandwidth 16QAM Modulation

Center Frequency (MHz)	Band edge Frequency (MHz)	Limit (20 dB below peak of fundamental)	Amplitude @ Band edge (dBm)	Plot #	Margin (dB)
2,417	2,400	-1.60	-11.04	57	-9.44
2,465	2,483.5	-2.50	-36.88	58	-34.38

Plot 57
18 MHz Bandwidth 16QAM Modulation
Conducted Spurious Emissions at the 2,400 MHz Band Edge

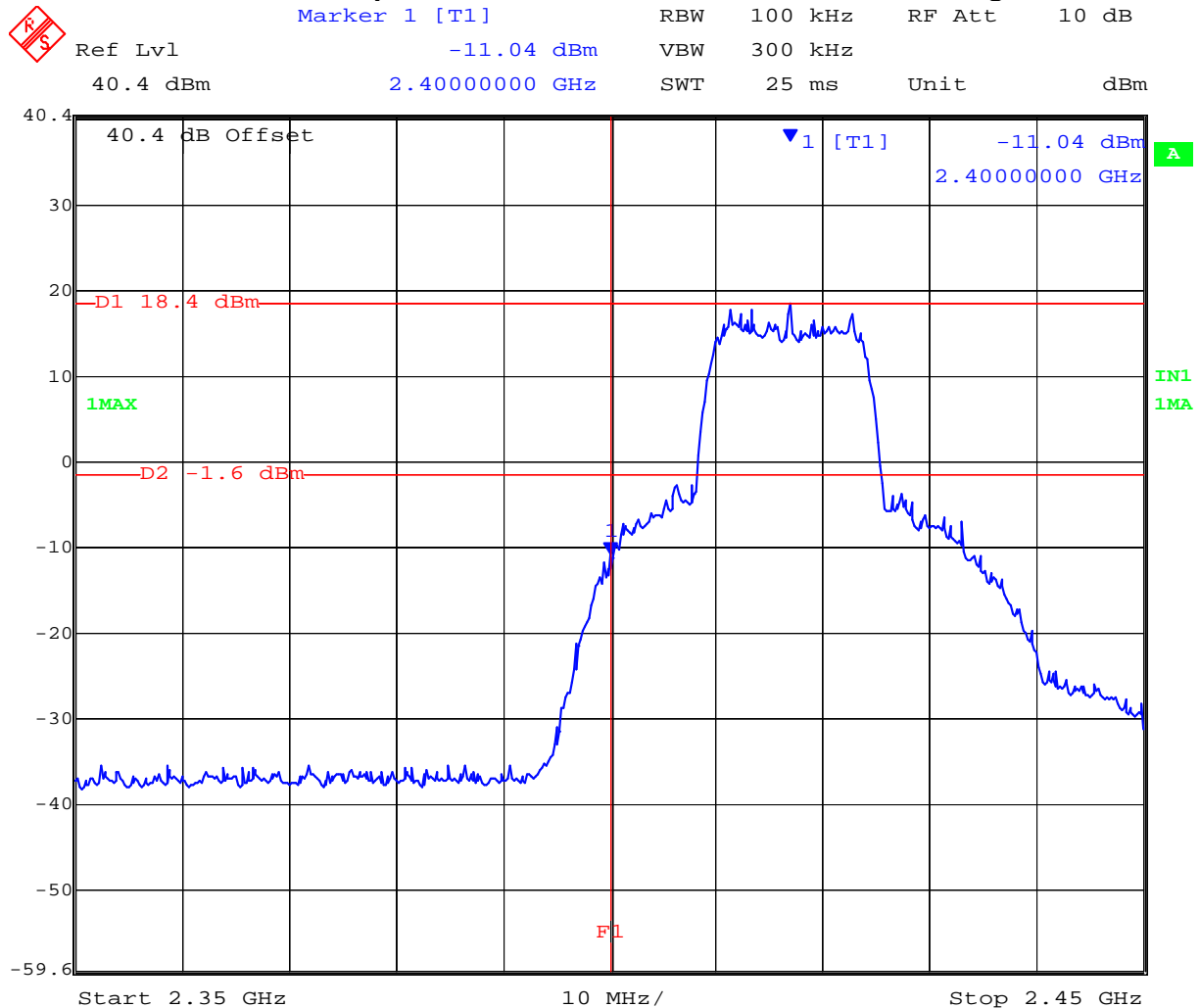

Date: 31.OCT.2005 13:27:30

This test report may be reproduced in full only. The document may only be updated by MiCOM Labs personnel. Any changes will be noted in the Document History section of the report.



Plot 58
18 MHz Bandwidth 16QAM Modulation
Conducted Spurious Emissions at the 2,483.5 MHz Band Edge

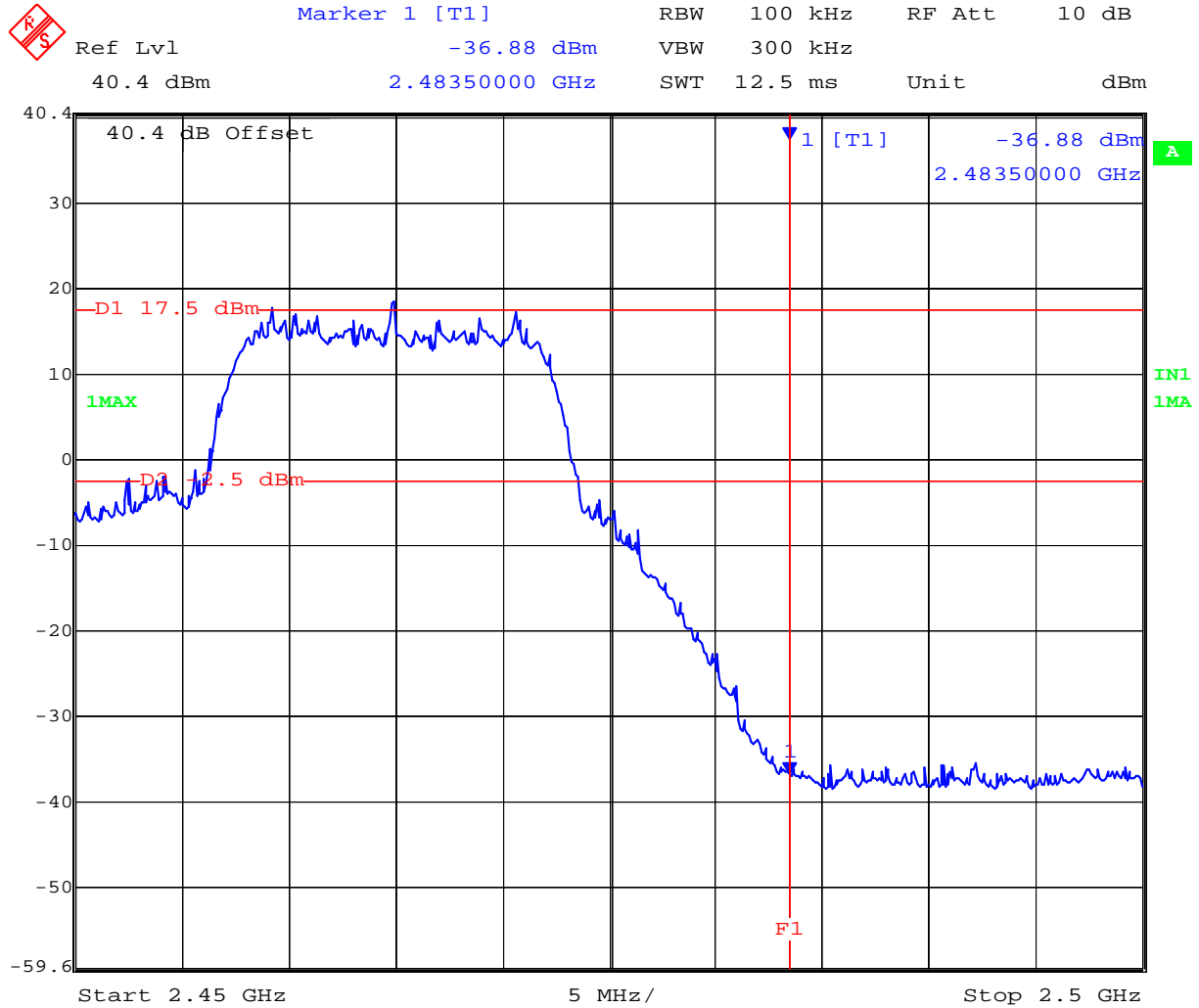

Date: 31.OCT.2005 13:36:37

This test report may be reproduced in full only. The document may only be updated by MiCOM Labs personnel. Any changes will be noted in the Document History section of the report.



TABLE OF RESULTS – 18 MHz Bandwidth 64QAM Modulation

Center Frequency (MHz)	Band edge Frequency (MHz)	Limit (20 dB below peak of fundamental)	Amplitude @ Band edge (dBm)	Plot #	Margin (dB)
2,417	2,400	-2.50	-9.67	59	-7.17
2,465	2,483.5	-2.50	-36.25	60	-33.75

Plot 59
18 MHz Bandwidth 64QAM Modulation
Conducted Spurious Emissions at the 2,400 MHz Band Edge

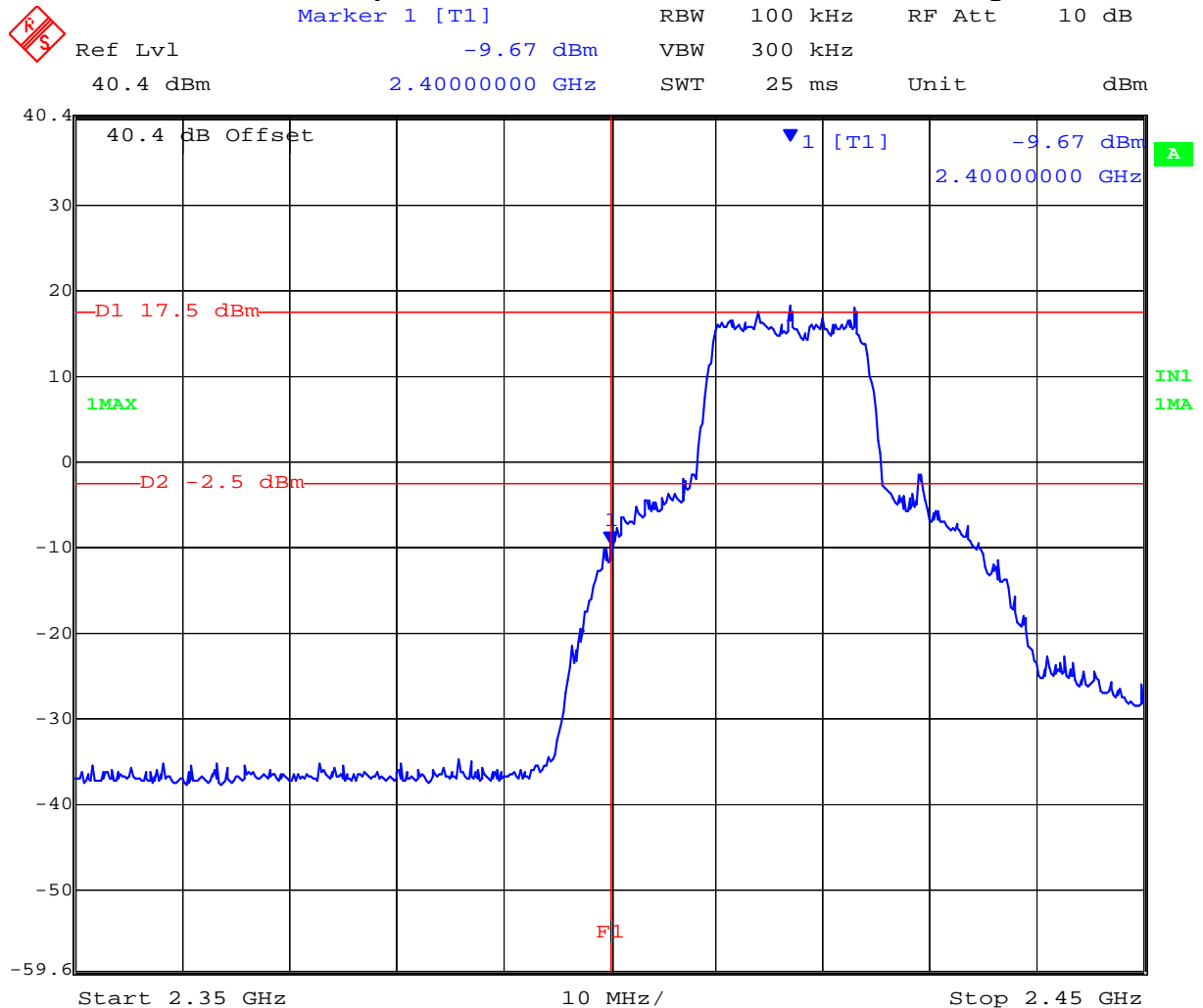

Date: 31.OCT.2005 13:29:45

This test report may be reproduced in full only. The document may only be updated by MiCOM Labs personnel. Any changes will be noted in the Document History section of the report.



Title: Exalt EX-2.4i-16 Fixed Link Radio
To: FCC 47 CFR Part15.247 & IC RSS-210
Serial #: EXLT19-A1 Rev A
Issue Date: 28th Feb 2007
Page: 87 of 248

Plot 60
18 MHz Bandwidth 64QAM Modulation
Conducted Spurious Emissions at the 2,483.5 MHz Band Edge

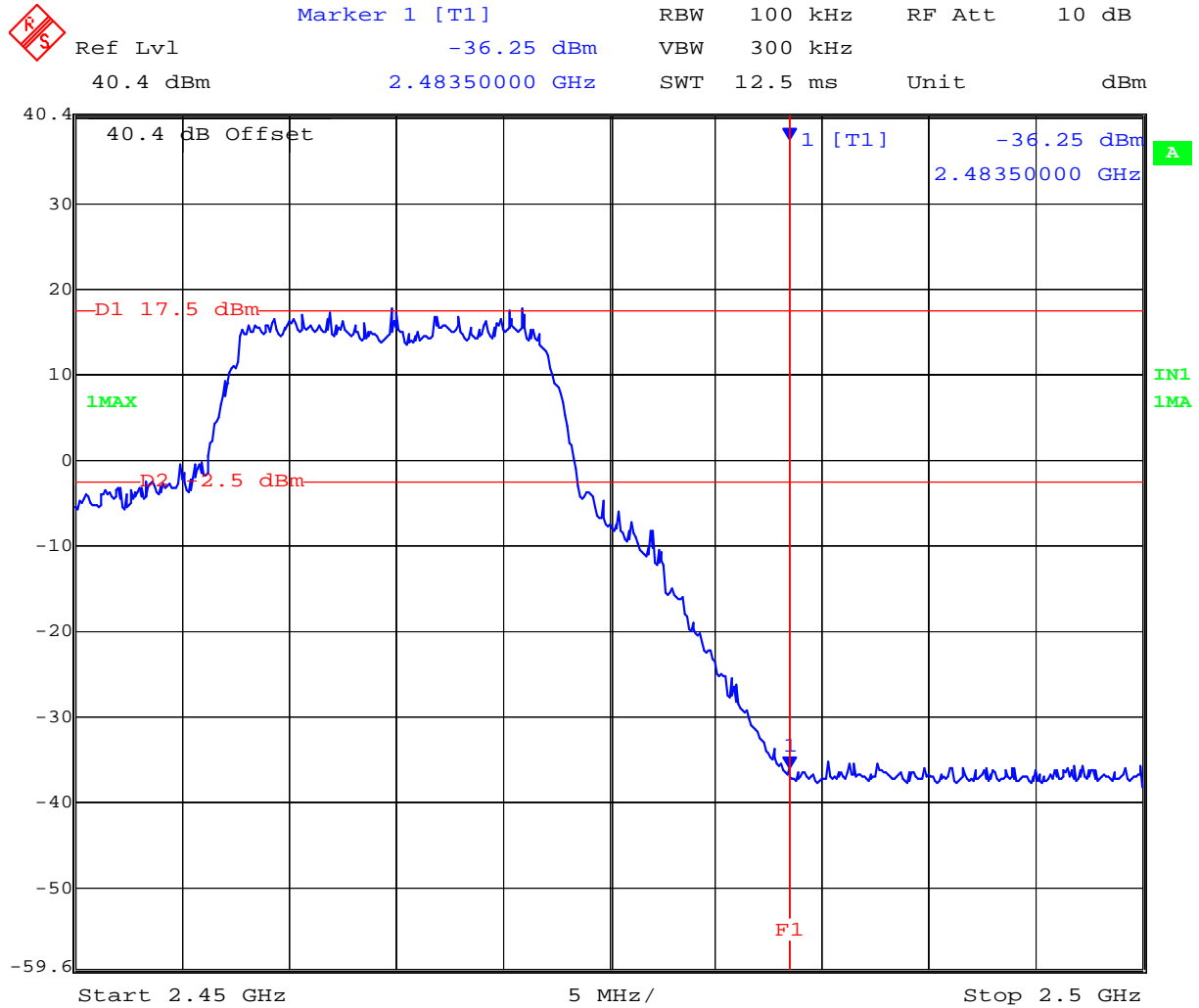

Date: 31.OCT.2005 13:38:44

This test report may be reproduced in full only. The document may only be updated by MiCOM Labs personnel. Any changes will be noted in the Document History section of the report.



TABLE OF RESULTS – 36 MHz Bandwidth QPSK Modulation

Center Frequency (MHz)	Band edge Frequency (MHz)	Limit (20 dB below peak of fundamental)	Amplitude @ Band edge (dBm)	Plot #	Margin (dB)
2,426	2,400	-4.00	-10.01	61	-6.01
2,455	2,483.5	-4.90	-36.50	62	-31.60

Plot 61

36 MHz Bandwidth QPSK Modulation

Conducted Spurious Emissions at the 2,400 MHz Band Edge

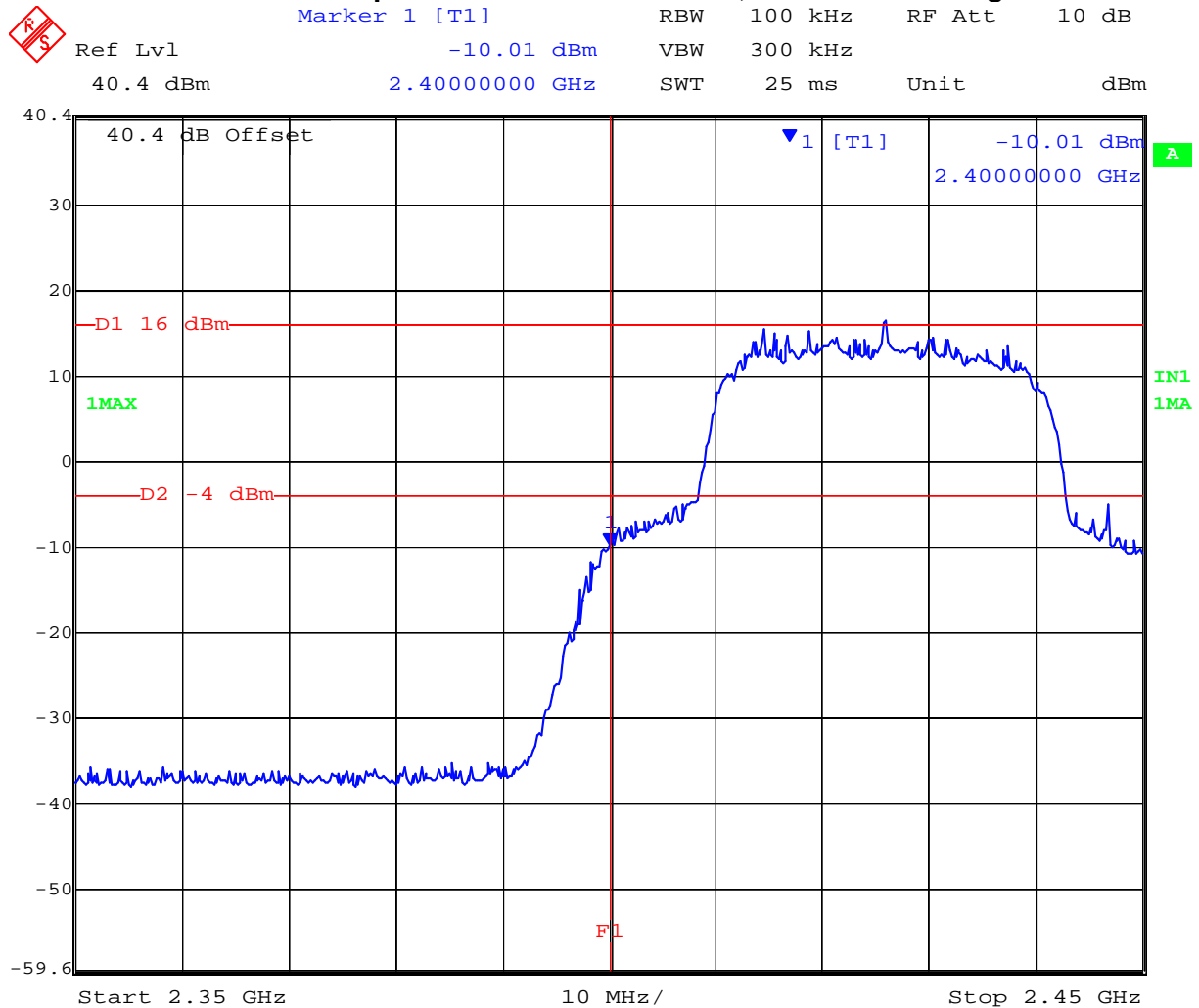

Date: 31.OCT.2005 14:09:38

This test report may be reproduced in full only. The document may only be updated by MiCOM Labs personnel. Any changes will be noted in the Document History section of the report.



Plot 62

36 MHz Bandwidth QPSK Modulation

Conducted Spurious Emissions at the 2,483.5 MHz Band Edge

 Ref Lvl 40.4 dBm
Marker 1 [T1] 2.48350000 GHz
RBW 100 kHz
RF Att 10 dB
VBW 300 kHz
SWT 12.5 ms
Unit dBm

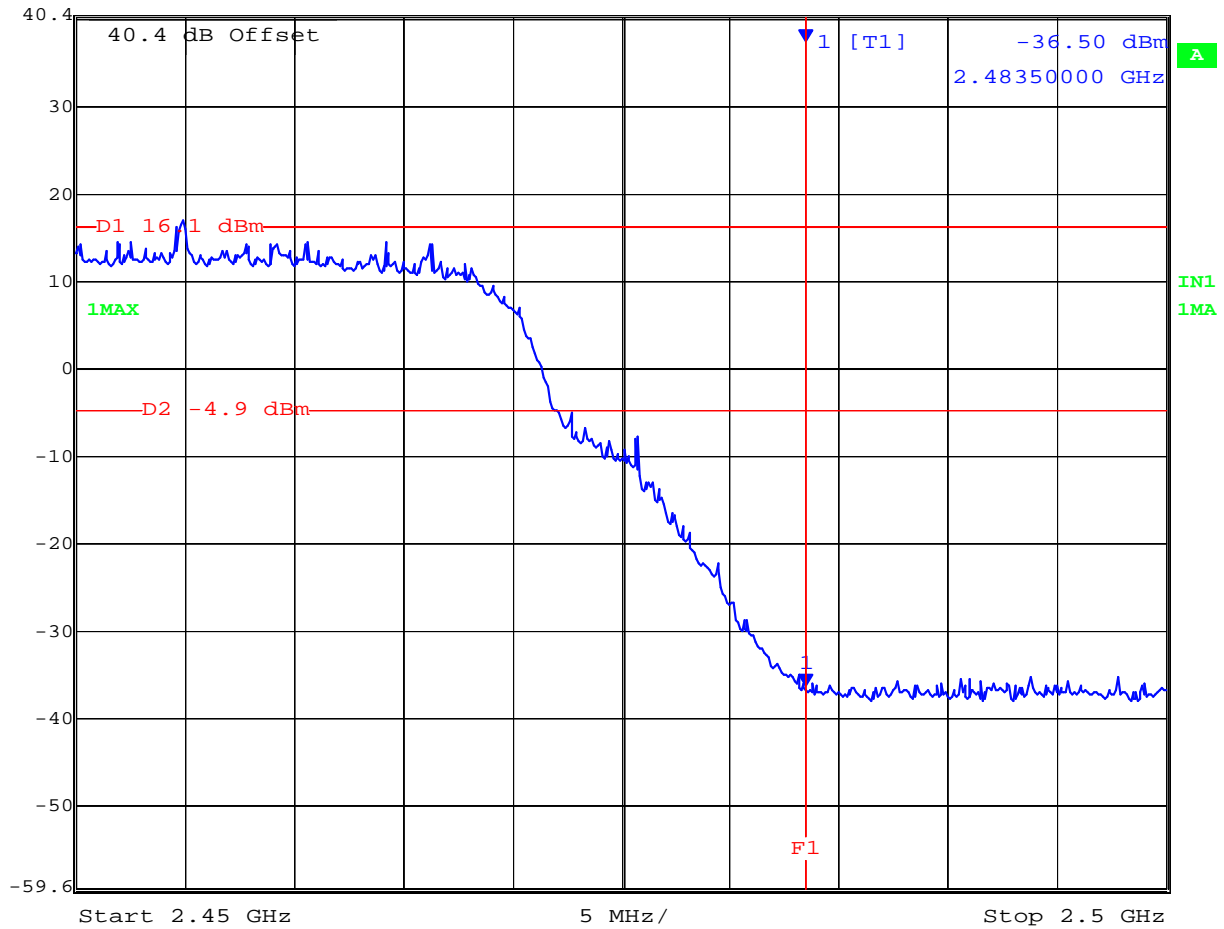

Date: 31.OCT.2005 14:32:33

This test report may be reproduced in full only. The document may only be updated by MiCOM Labs personnel. Any changes will be noted in the Document History section of the report.



TABLE OF RESULTS – 36 MHz Bandwidth 16QAM Modulation

Center Frequency (MHz)	Band edge Frequency (MHz)	Limit (20 dB below peak of fundamental)	Amplitude @ Band edge (dBm)	Plot #	Margin (dB)
2,426	2,400	-4.50	-10.71	63	-6.21
2,455	2,483.5	-4.40	-37.19	64	-32.79

Plot 63

36 MHz Bandwidth 16QAM Modulation

Conducted Spurious Emissions at the 2,400 MHz Band Edge

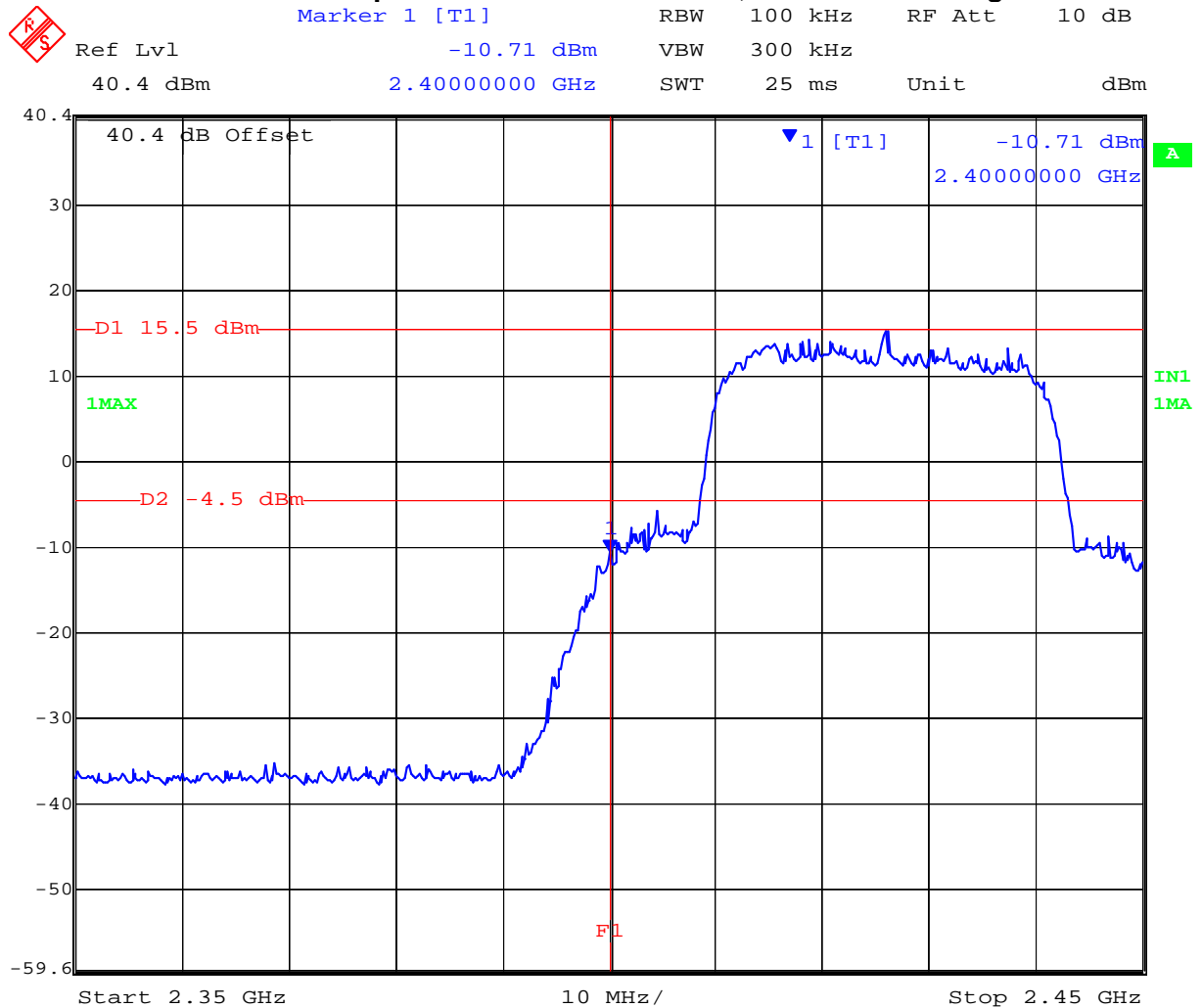

Date: 31.OCT.2005 14:21:39

This test report may be reproduced in full only. The document may only be updated by MiCOM Labs personnel. Any changes will be noted in the Document History section of the report.



Plot 64

36 MHz Bandwidth 16QAM Modulation

Conducted Spurious Emissions at the 2,483.5 MHz Band Edge

 Ref Lvl 40.4 dBm
Marker 1 [T1] 2.48350000 GHz
RBW 100 kHz
RF Att 10 dB
VBW 300 kHz
SWT 12.5 ms
Unit dBm

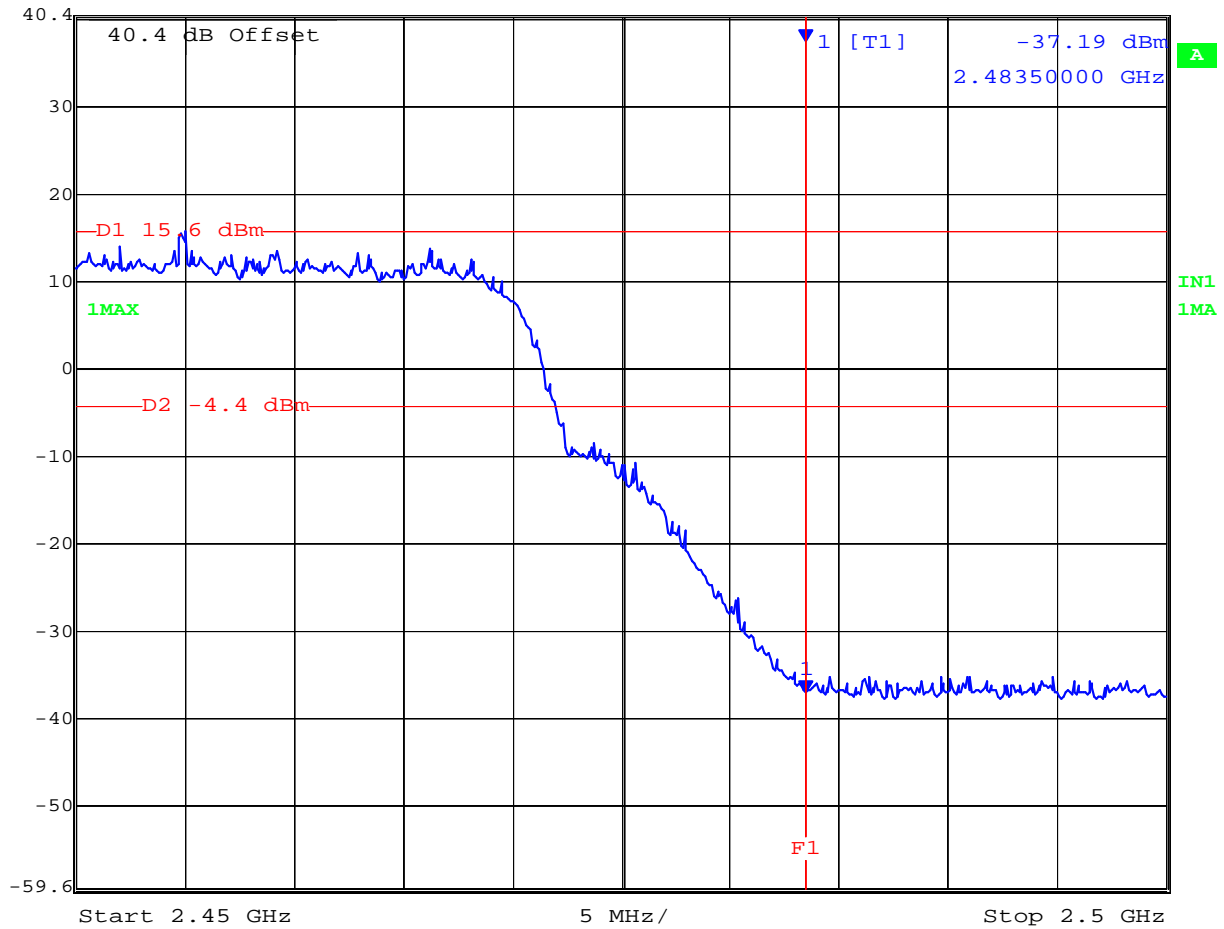

Date: 31.OCT.2005 14:34:39

This test report may be reproduced in full only. The document may only be updated by MiCOM Labs personnel. Any changes will be noted in the Document History section of the report.



TABLE OF RESULTS – 36 MHz Bandwidth 64QAM Modulation

Center Frequency (MHz)	Band edge Frequency (MHz)	Limit (20 dB below peak of fundamental)	Amplitude @ Band edge (dBm)	Plot #	Margin (dB)
2,426	2,400	-5.80	-10.17	65	-4.37
2,455	2,483.5	-5.60	-36.52	66	-30.92

Plot 65

36 MHz Bandwidth 64QAM Modulation

Conducted Spurious Emissions at the 2,400 MHz Band Edge

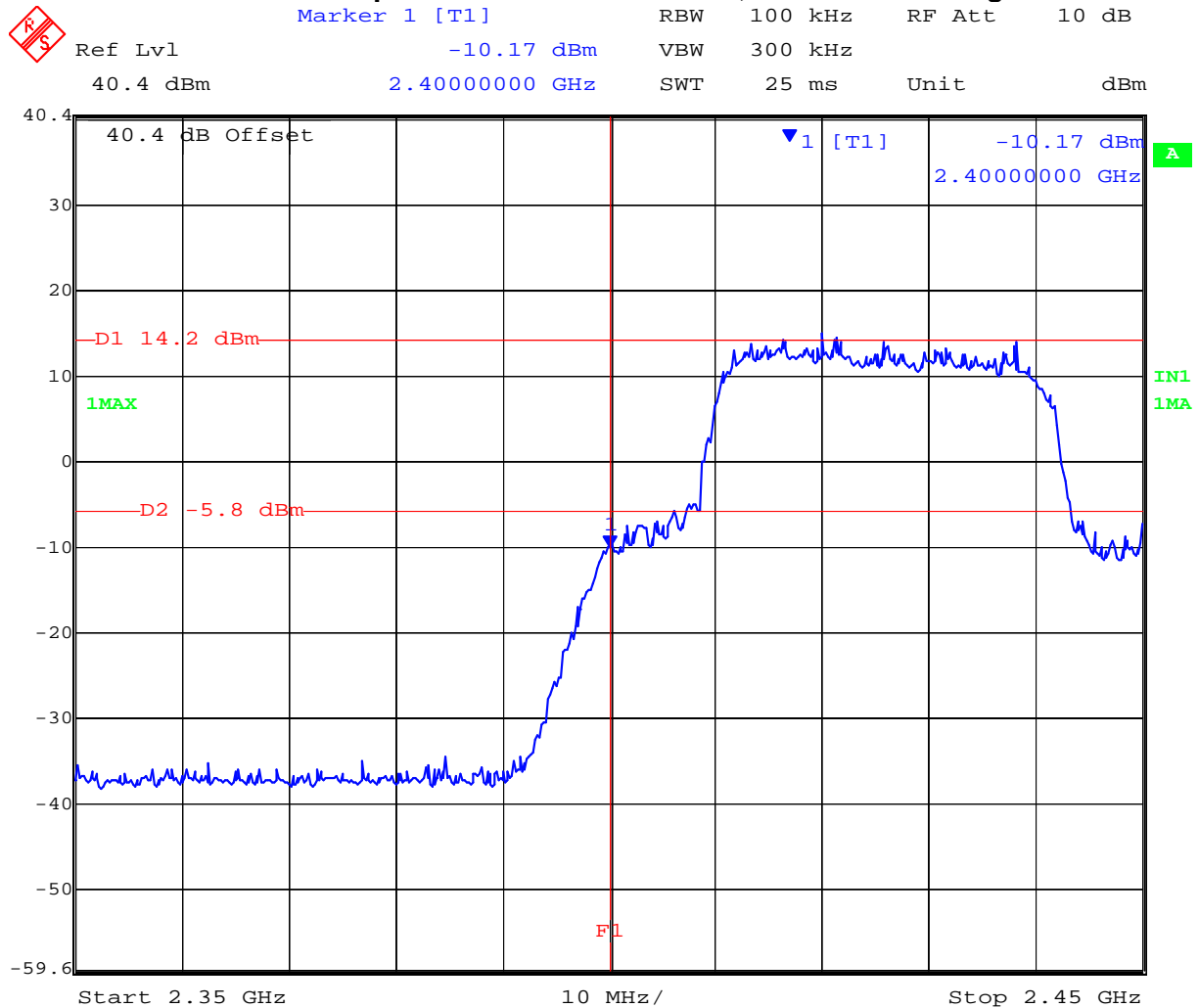

Date: 31.OCT.2005 14:29:36

This test report may be reproduced in full only. The document may only be updated by MiCOM Labs personnel. Any changes will be noted in the Document History section of the report.



Plot 66

36 MHz Bandwidth 64QAM Modulation

Conducted Spurious Emissions at the 2,483.5 MHz Band Edge

 Ref Lvl 40.4 dBm
Marker 1 [T1] -36.52 dBm
RBW 100 kHz RF Att 10 dB
VBW 300 kHz
SWT 12.5 ms Unit dBm

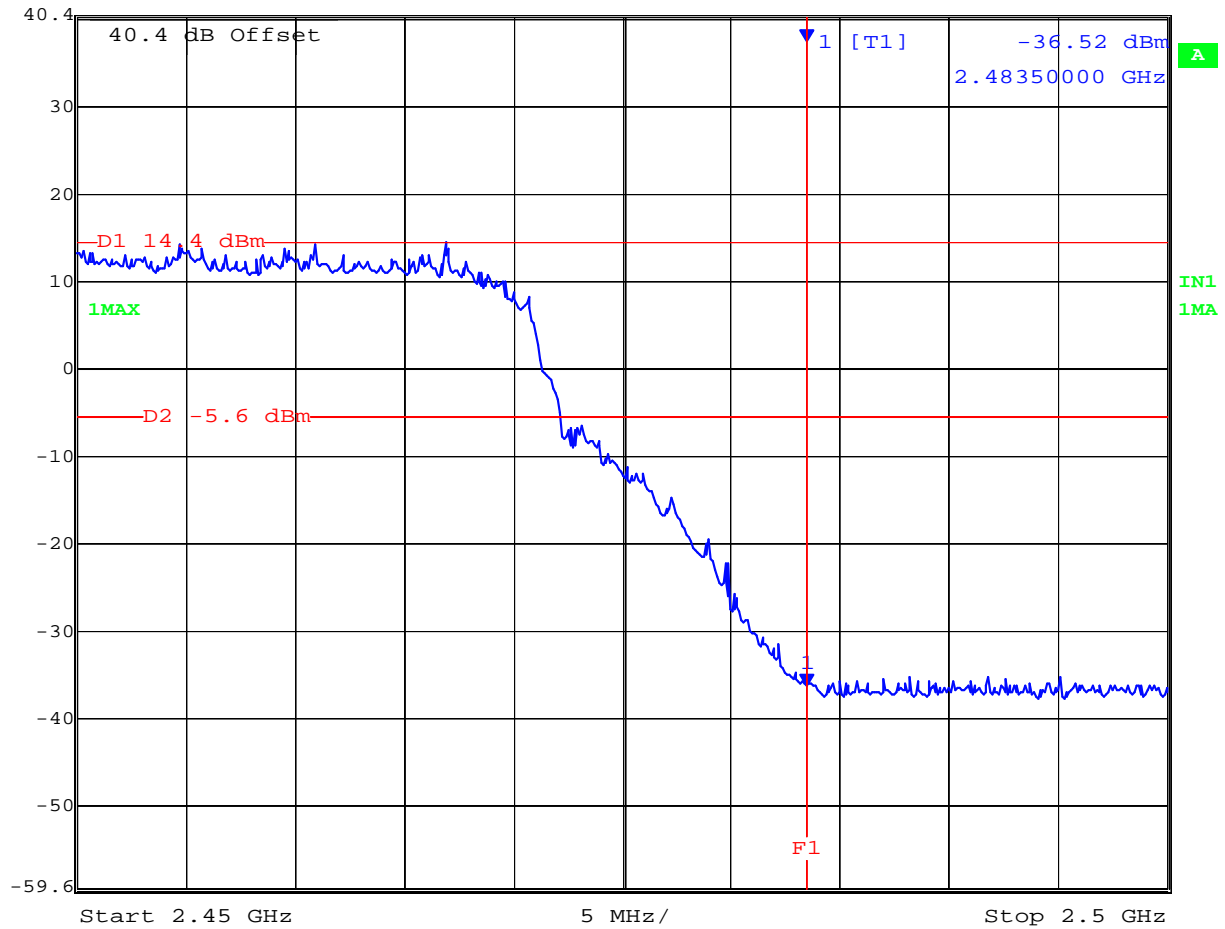

Date: 31.OCT.2005 14:36:42

This test report may be reproduced in full only. The document may only be updated by MiCOM Labs personnel. Any changes will be noted in the Document History section of the report.



TABLE OF RESULTS – 72 MHz Bandwidth QPSK Modulation

Center Frequency (MHz)	Band edge Frequency (MHz)	Limit (20 dB below peak of fundamental)	Amplitude @ Band edge (dBm)	Plot #	Margin (dB)
2,437	2,400	-6.70	-12.30	67	-5.60
	2,483.5	-6.70	-35.09	67	-28.39

Plot 67
72 MHz Bandwidth QPSK Modulation
Conducted Spurious Emissions at the 2,400 MHz and 2,483.5 MHz Band Edges

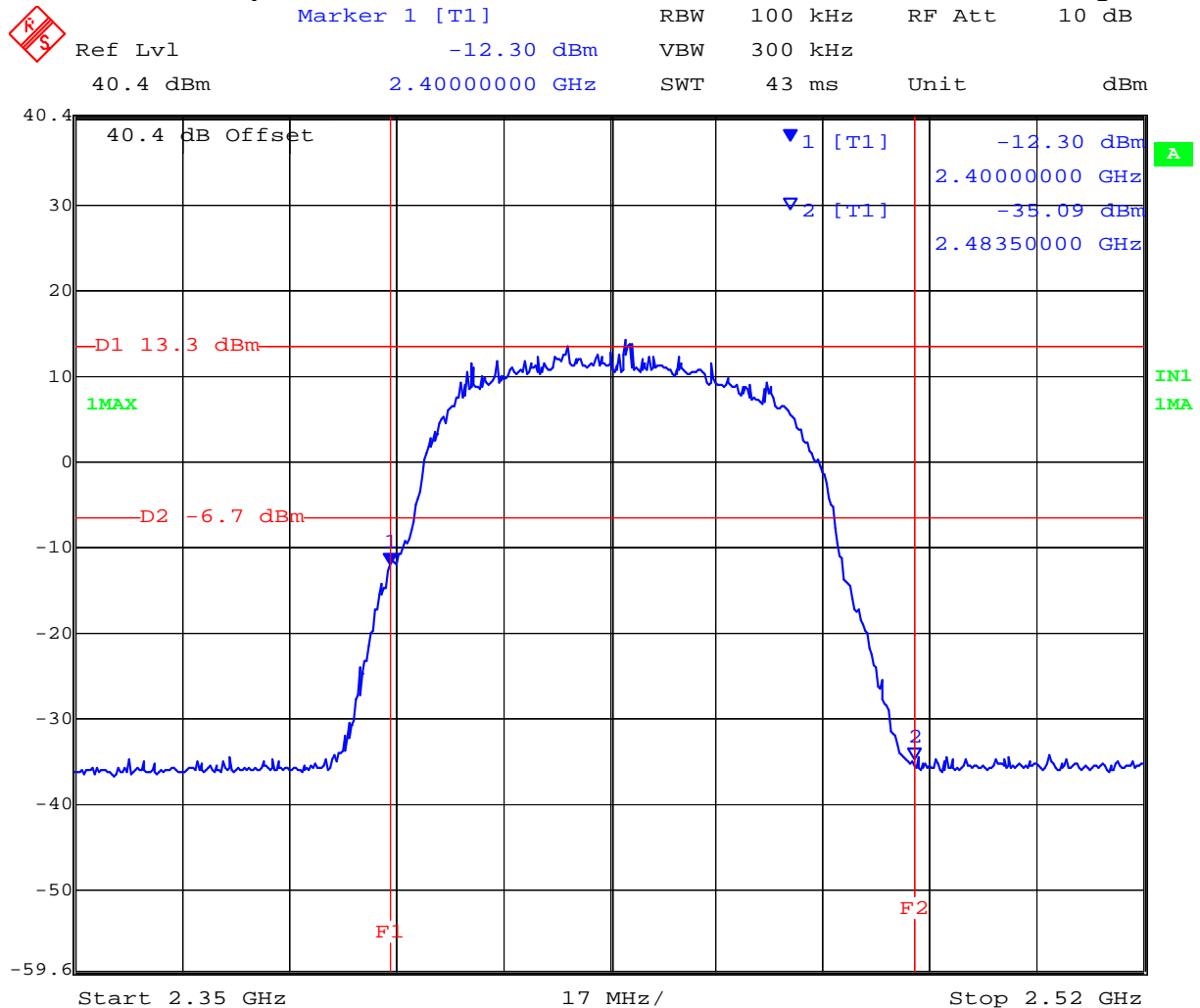

Date: 31.OCT.2005 15:02:29

This test report may be reproduced in full only. The document may only be updated by MiCOM Labs personnel. Any changes will be noted in the Document History section of the report.



TABLE OF RESULTS – 72 MHz Bandwidth 16QAM Modulation

Center Frequency (MHz)	Band edge Frequency (MHz)	Limit (20 dB below peak of fundamental)	Amplitude @ Band edge (dBm)	Plot #	Margin (dB)
2,437	2,400	-8.50	-14.17	68	-5.67
	2,483.5	-8.50	-36.67	68	-28.17

Plot 68

72 MHz Bandwidth 16QAM Modulation

Conducted Spurious Emissions at the 2,400 MHz and 2,483.5 MHz Band Edges

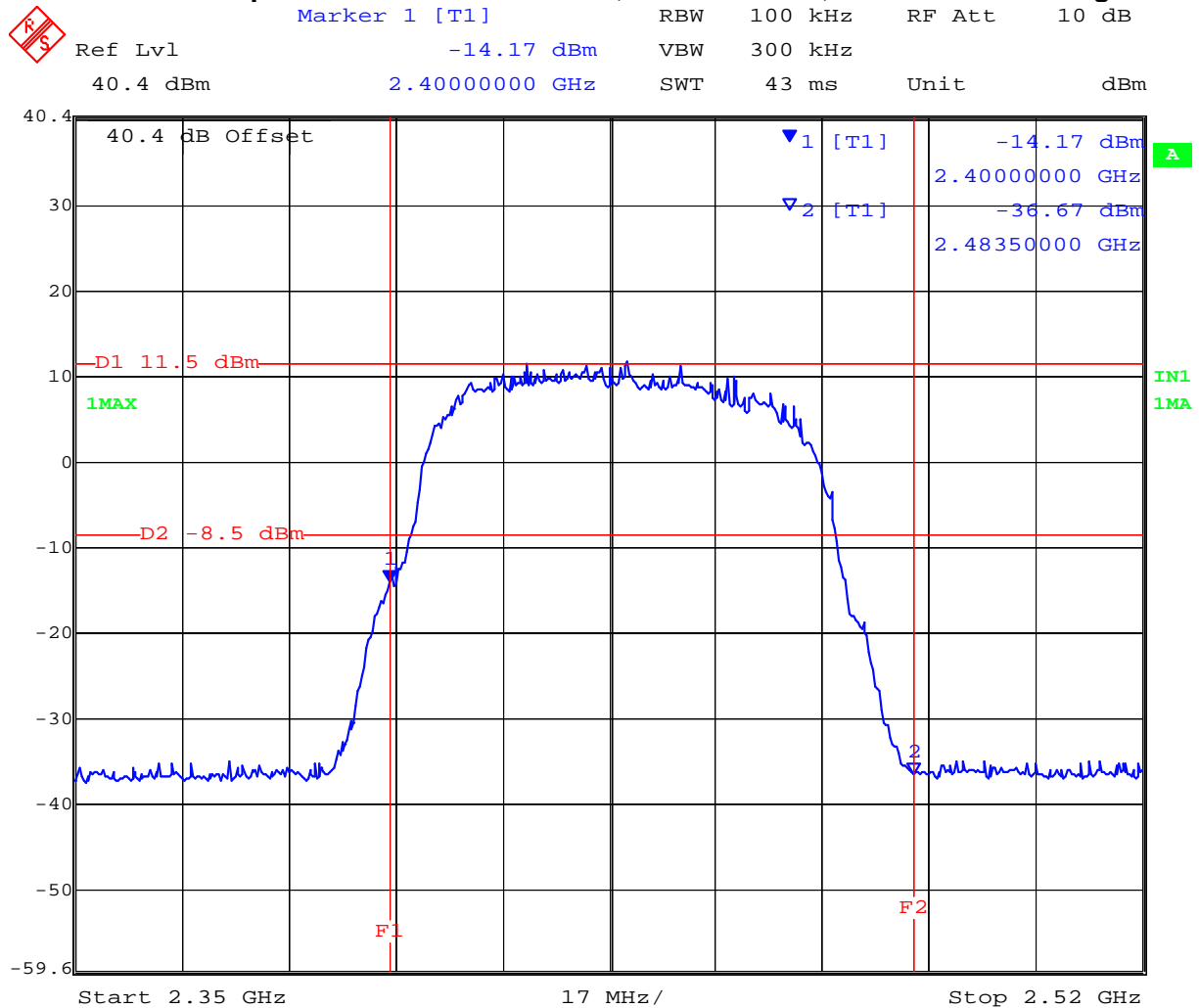

Date: 31.OCT.2005 15:06:40

This test report may be reproduced in full only. The document may only be updated by MiCOM Labs personnel. Any changes will be noted in the Document History section of the report.



Title: Exalt EX-2.4i-16 Fixed Link Radio
To: FCC 47 CFR Part15.247 & IC RSS-210
Serial #: EXLT19-A1 Rev A
Issue Date: 28th Feb 2007
Page: 96 of 248

TABLE OF RESULTS – 72 MHz Bandwidth 64QAM Modulation

Center Frequency (MHz)	Band edge Frequency (MHz)	Limit (20 dB below peak of fundamental)	Amplitude @ Band edge (dBm)	Plot #	Margin (dB)
2,437	2,400	-8.40	-12.52	69	-4.12
	2,483.5	-8.40	-36.63	69	-28.23

Plot 69

72 MHz Bandwidth 64QAM Modulation

Conducted Spurious Emissions at the 2,400 MHz and 2,483.5 MHz Band Edges

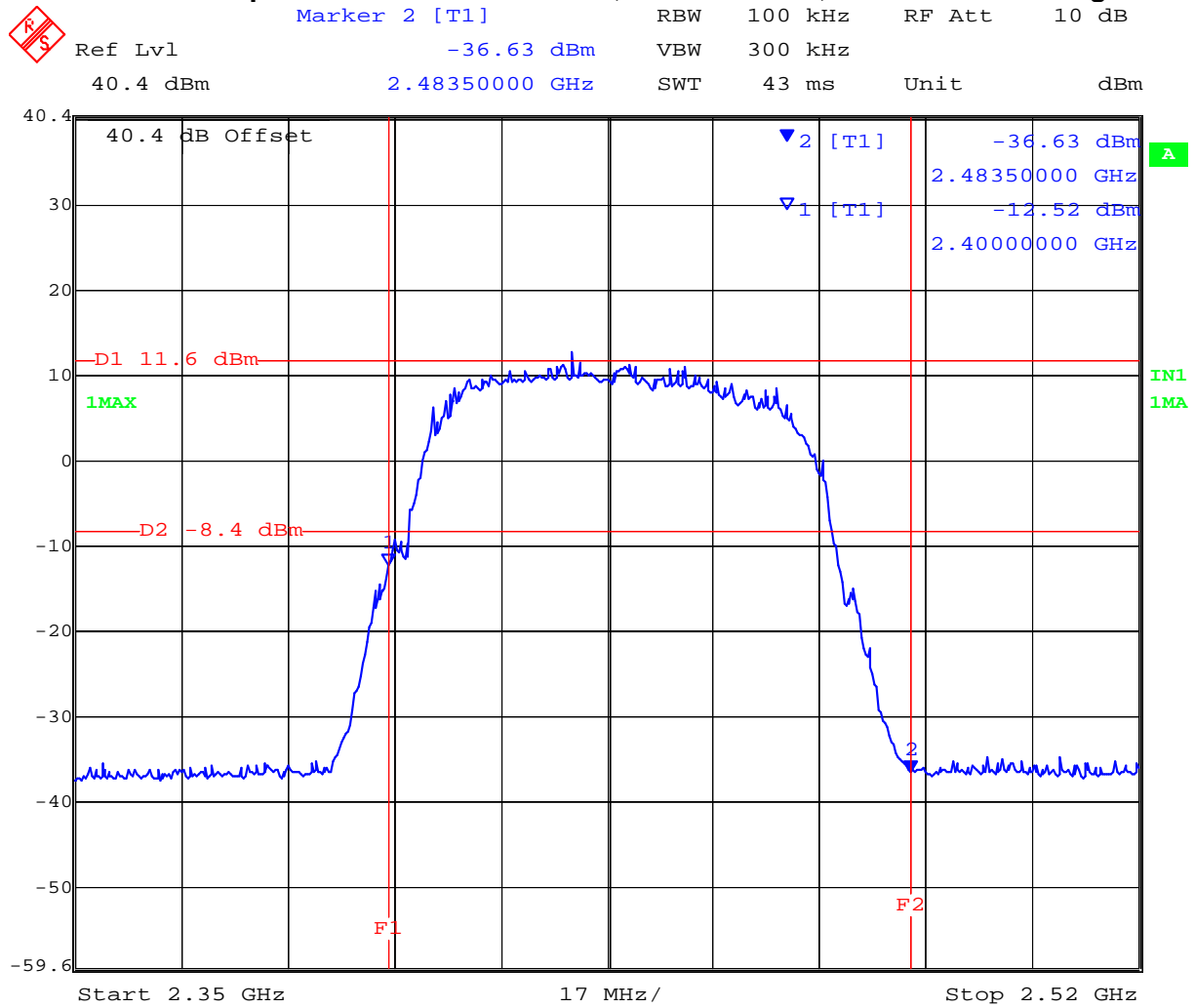

Date: 31.OCT.2005 15:10:32

This test report may be reproduced in full only. The document may only be updated by MiCOM Labs personnel. Any changes will be noted in the Document History section of the report.



Title: Exalt EX-2.4i-16 Fixed Link Radio
To: FCC 47 CFR Part15.247 & IC RSS-210
Serial #: EXLT19-A1 Rev A
Issue Date: 28th Feb 2007
Page: 97 of 248

Conducted Spurious Emissions (1-26 GHz)

Conducted spurious emissions (1-26 GHz) are provided indicated by the following matrix. Measurements were performed with the transmitter tuned to the channel closest to the band-edge being measured. All emissions were maximized during measurement. Limits which were derived from the band-edge measurements provided below are drawn on each plot.

Conducted Spurious Emissions were measured for each modulation scheme, QPSK, 16QAM and 64QAM for each bandwidth.

This test report may be reproduced in full only. The document may only be updated by MiCOM Labs personnel. Any changes will be noted in the Document History section of the report.



Title: Exalt EX-2.4i-16 Fixed Link Radio
To: FCC 47 CFR Part15.247 & IC RSS-210
Serial #: EXLT19-A1 Rev A
Issue Date: 28th Feb 2007
Page: 98 of 248

TABLE OF RESULTS – 9 MHz Bandwidth QPSK Modulation

Channel Centre Frequency	Start Frequency (MHz)	Stop Frequency (MHz)	Maximum Emission Observed (dBm)	Limit (dBm)	Plot #	Margin (dB)
2,437	30	2400	-4.20	1.4	70	-5.60
2,437	2483.5	7000	-34.7	1.9	71	-36.6
2,437	7000	26000	-26.83	1.9	72	-28.73

Plot 70
9 MHz Bandwidth QPSK Modulation
Conducted Spurious Emissions 30 MHz to 2400 MHz

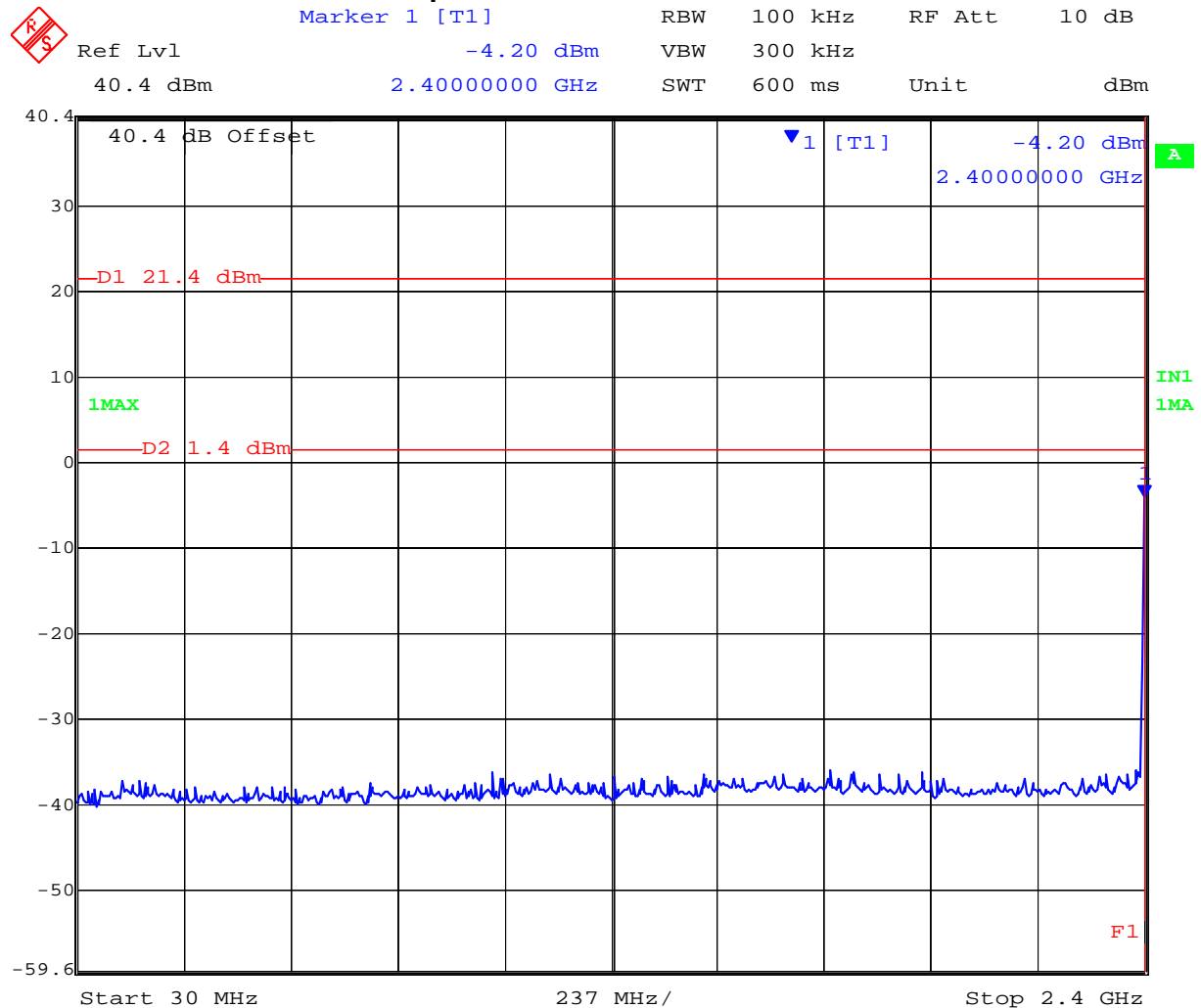

Date: 31.OCT.2005 13:10:50

This test report may be reproduced in full only. The document may only be updated by MiCOM Labs personnel. Any changes will be noted in the Document History section of the report.



Title: Exalt EX-2.4i-16 Fixed Link Radio
To: FCC 47 CFR Part15.247 & IC RSS-210
Serial #: EXLT19-A1 Rev A
Issue Date: 28th Feb 2007
Page: 99 of 248

Plot 71
9 MHz Bandwidth QPSK Modulation
Conducted Spurious Emissions 2483.5 MHz to 7000 MHz

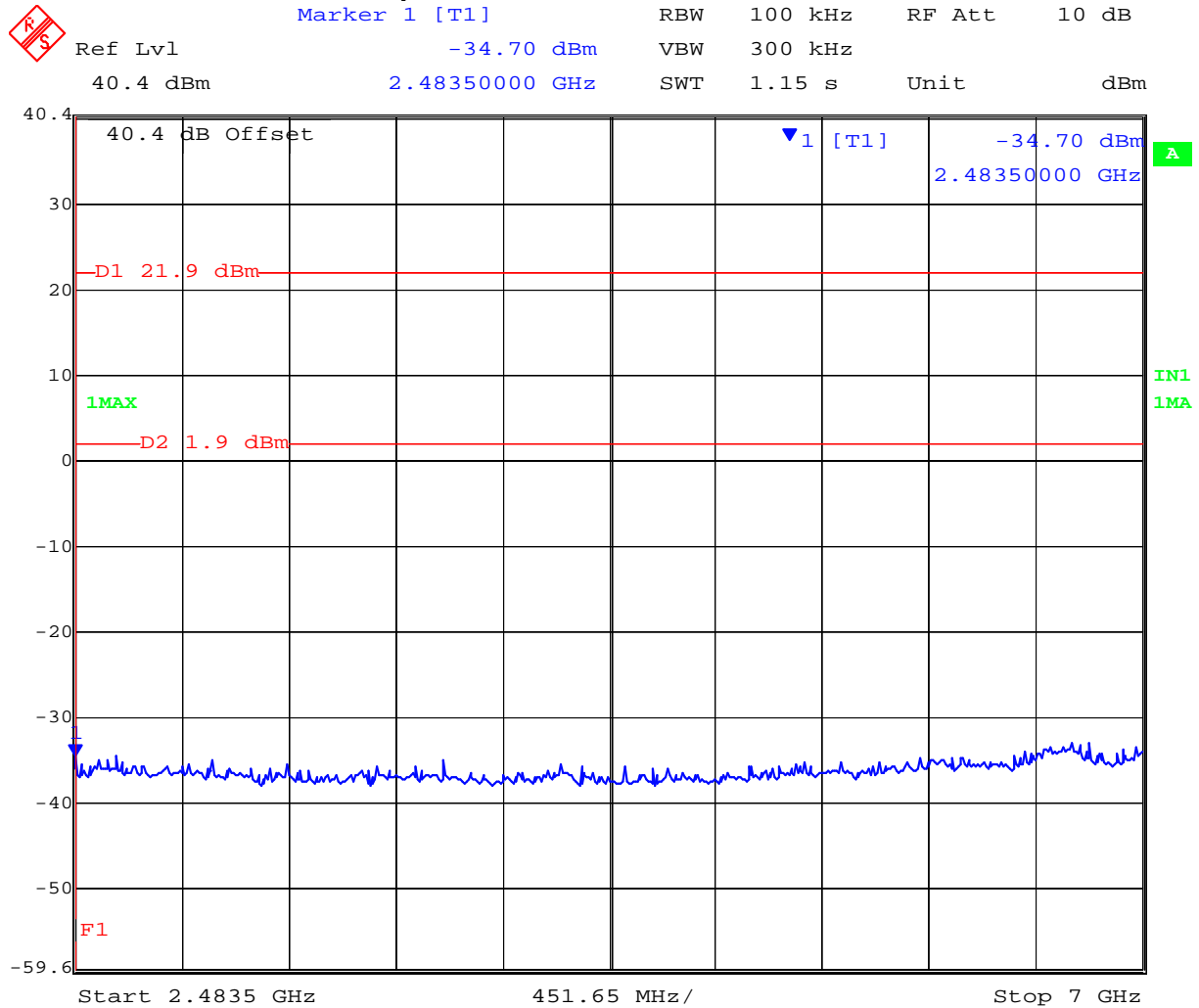

Date: 31.OCT.2005 13:15:39

This test report may be reproduced in full only. The document may only be updated by MiCOM Labs personnel. Any changes will be noted in the Document History section of the report.



Title: Exalt EX-2.4i-16 Fixed Link Radio
To: FCC 47 CFR Part15.247 & IC RSS-210
Serial #: EXLT19-A1 Rev A
Issue Date: 28th Feb 2007
Page: 100 of 248

Plot 72
9 MHz Bandwidth QPSK Modulation
Conducted Spurious Emissions 7000 MHz to 26000 MHz

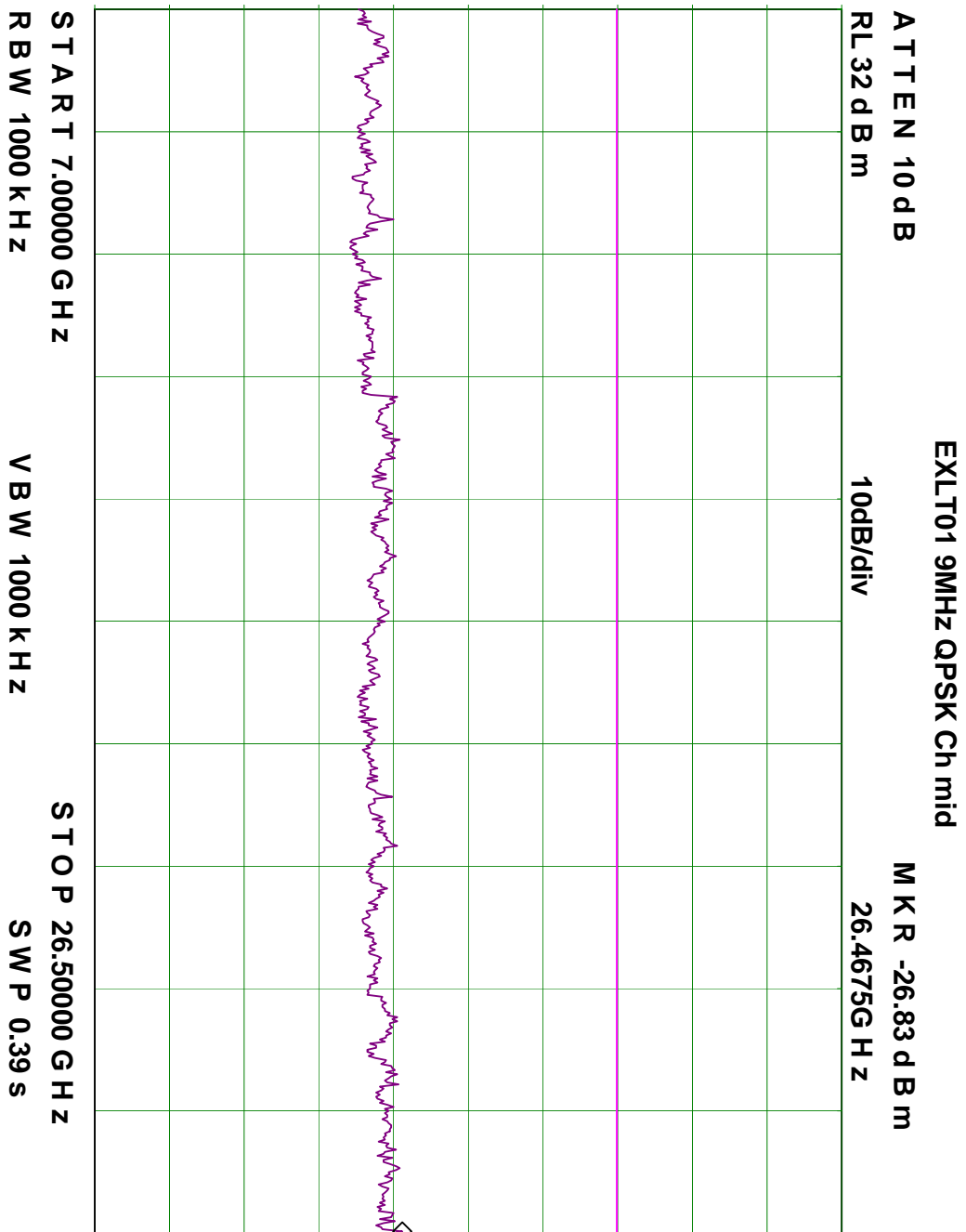

This test report may be reproduced in full only. The document may only be updated by MiCOM Labs personnel. Any changes will be noted in the Document History section of the report.



TABLE OF RESULTS – 9 MHz Bandwidth 16QAM Modulation

Channel Centre Frequency	Start Frequency (MHz)	Stop Frequency (MHz)	Maximum Emission Observed (dBm)	Limit (dBm)	Plot #	Margin (dB)
2,437	30	2400	-5.56	1.4	73	-6.96
2,437	2483.5	7000	-36.91	-2.5	74	-34.41
2,437	7000	26000	-25.66	-2.5	75	-23.16

Plot 73
9 MHz Bandwidth 16QAM Modulation
Conducted Spurious Emissions 30 MHz to 2400 MHz

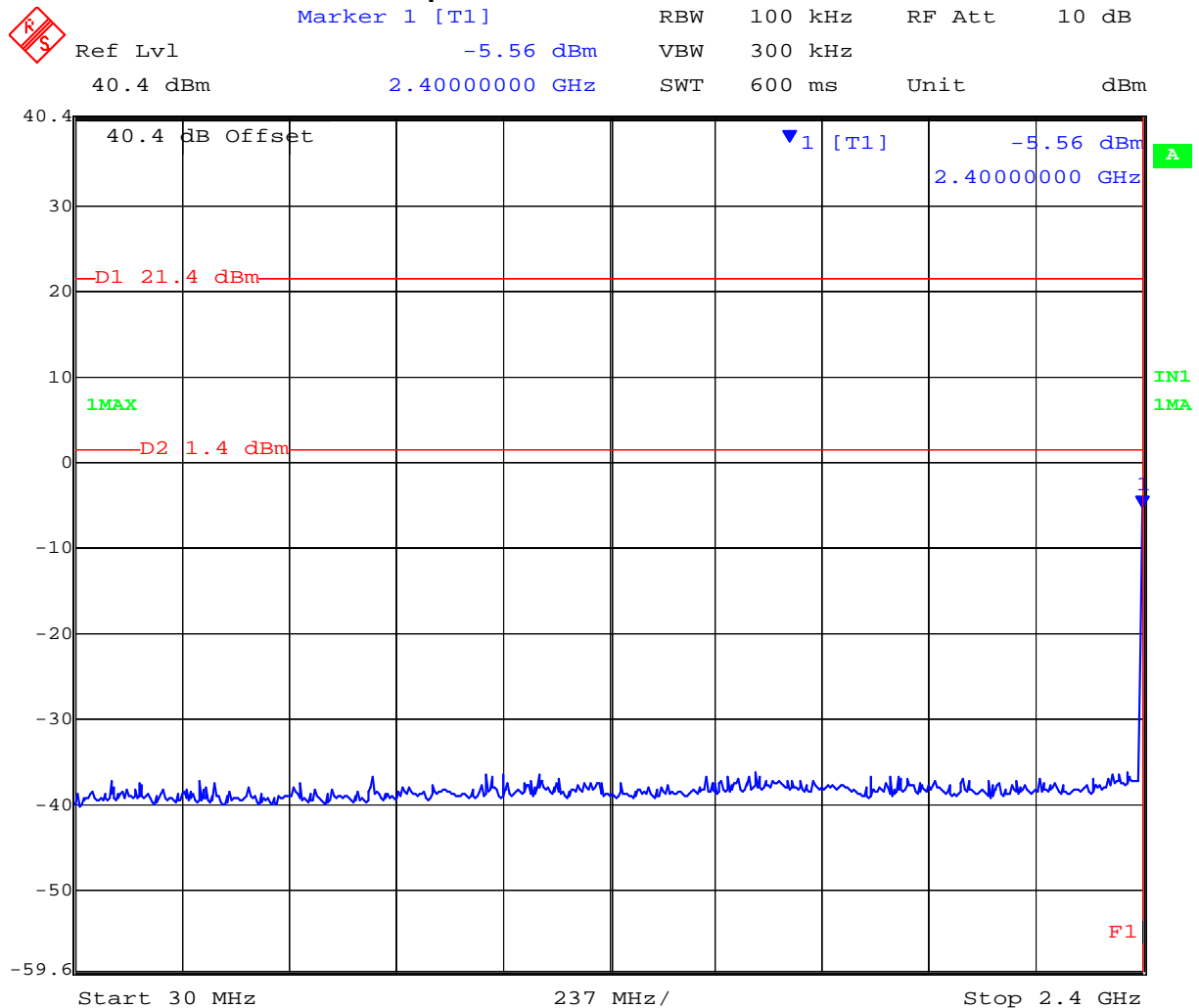

Date: 31.OCT.2005 13:08:55

This test report may be reproduced in full only. The document may only be updated by MiCOM Labs personnel. Any changes will be noted in the Document History section of the report.



Title: Exalt EX-2.4i-16 Fixed Link Radio
To: FCC 47 CFR Part15.247 & IC RSS-210
Serial #: EXLT19-A1 Rev A
Issue Date: 28th Feb 2007
Page: 102 of 248

Plot 74
9 MHz Bandwidth 16QAM Modulation
Conducted Spurious Emissions 2483.5 MHz to 7000 MHz

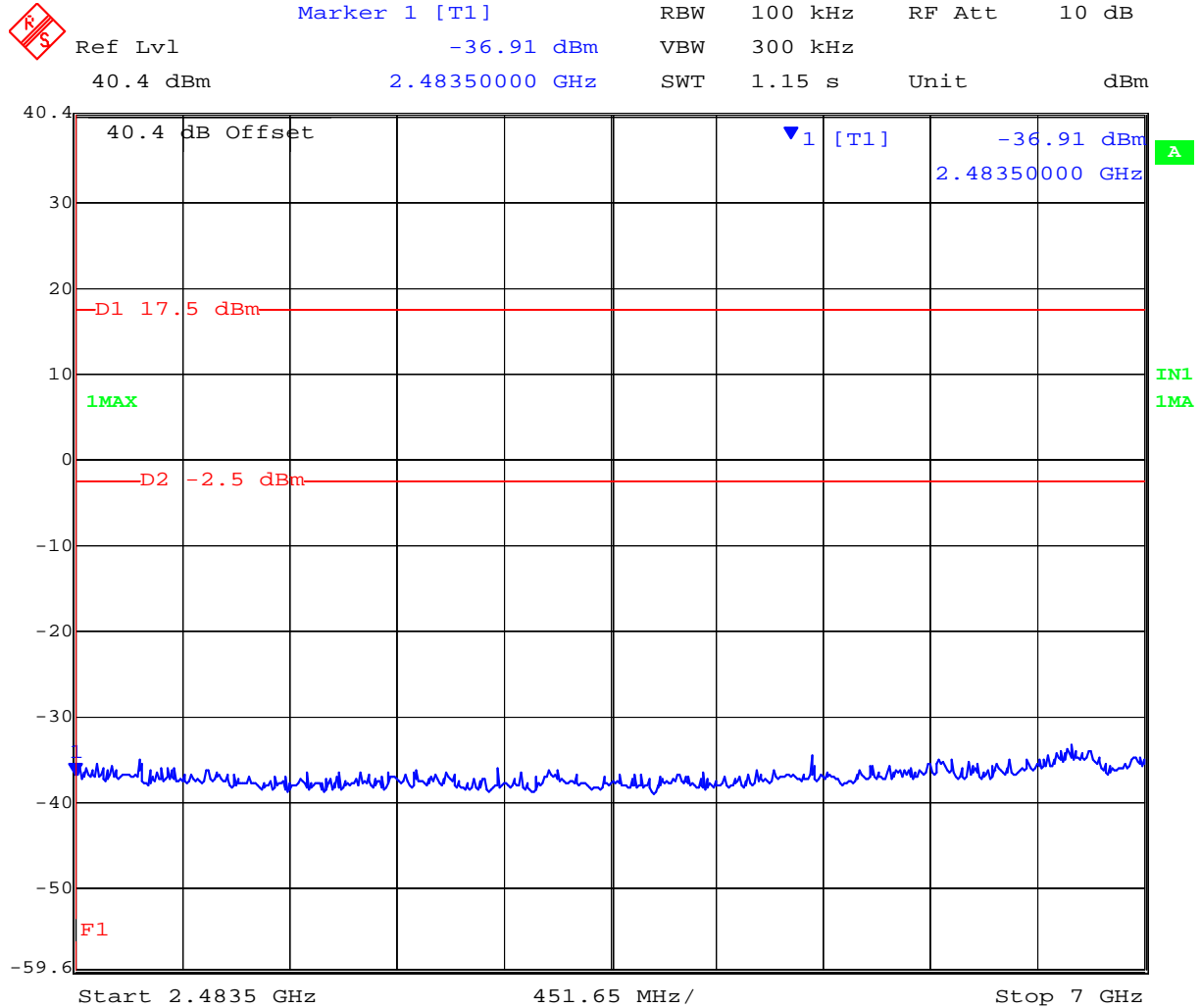

Date: 31.OCT.2005 13:37:28

This test report may be reproduced in full only. The document may only be updated by MiCOM Labs personnel. Any changes will be noted in the Document History section of the report.



Title: Exalt EX-2.4i-16 Fixed Link Radio
To: FCC 47 CFR Part15.247 & IC RSS-210
Serial #: EXLT19-A1 Rev A
Issue Date: 28th Feb 2007
Page: 103 of 248

Plot 75
9 MHz Bandwidth 16QAM Modulation
Conducted Spurious Emissions 7000 MHz to 26000 MHz

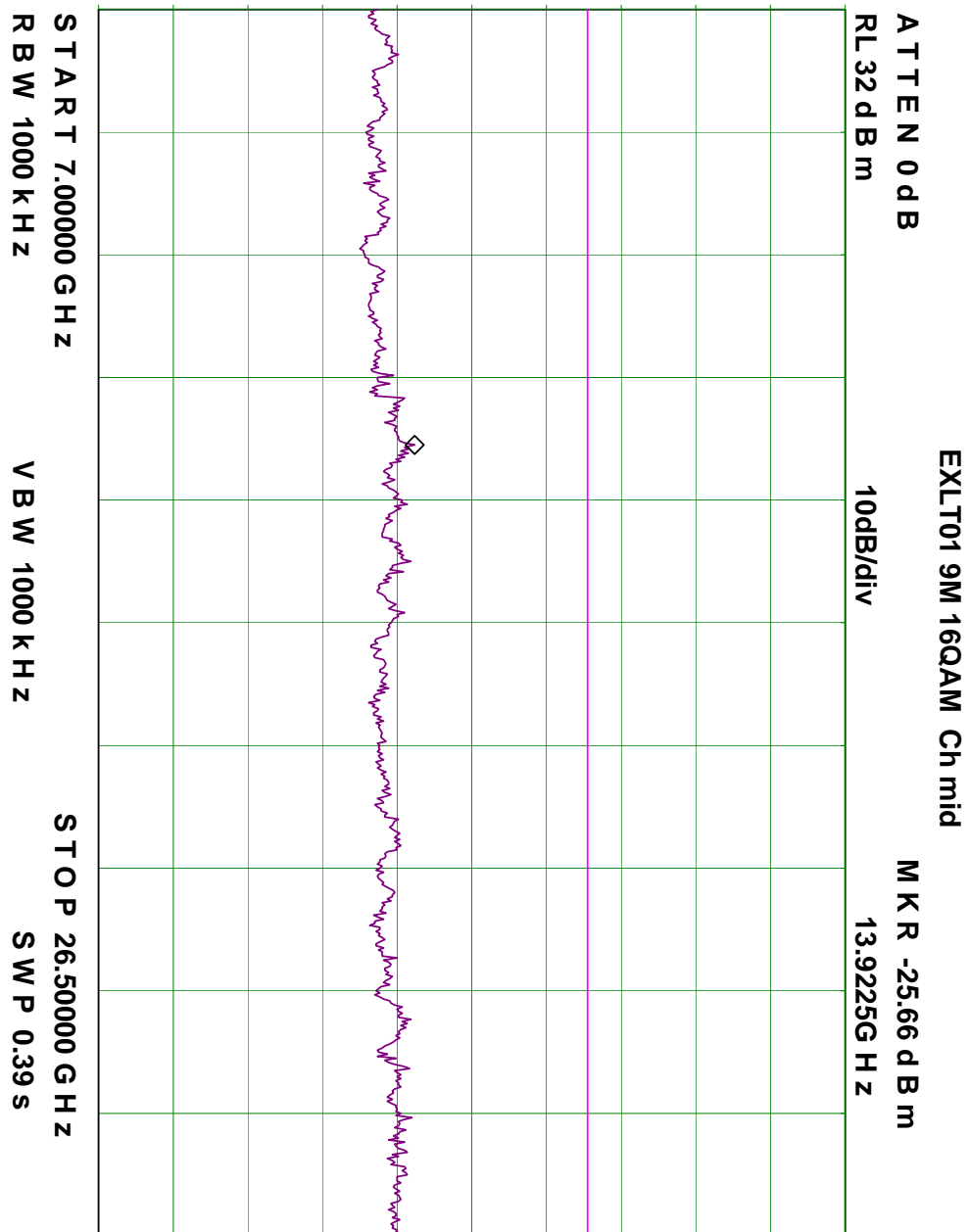

This test report may be reproduced in full only. The document may only be updated by MiCOM Labs personnel. Any changes will be noted in the Document History section of the report.



TABLE OF RESULTS – 9 MHz Bandwidth 64QAM Modulation

Channel Centre Frequency	Start Frequency (MHz)	Stop Frequency (MHz)	Maximum Emission Observed (dBm)	Limit (dBm)	Plot #	Margin (dB)
2,437	30	2400	-4.20	1.4	76	-5.6
2,437	2483.5	7000	-36.62	1.3	77	-37.92
2,437	7000	26000	-26.33	1.3	78	-27.63

Plot 76
9 MHz Bandwidth 64QAM Modulation
Conducted Spurious Emissions 30 MHz to 2400 MHz

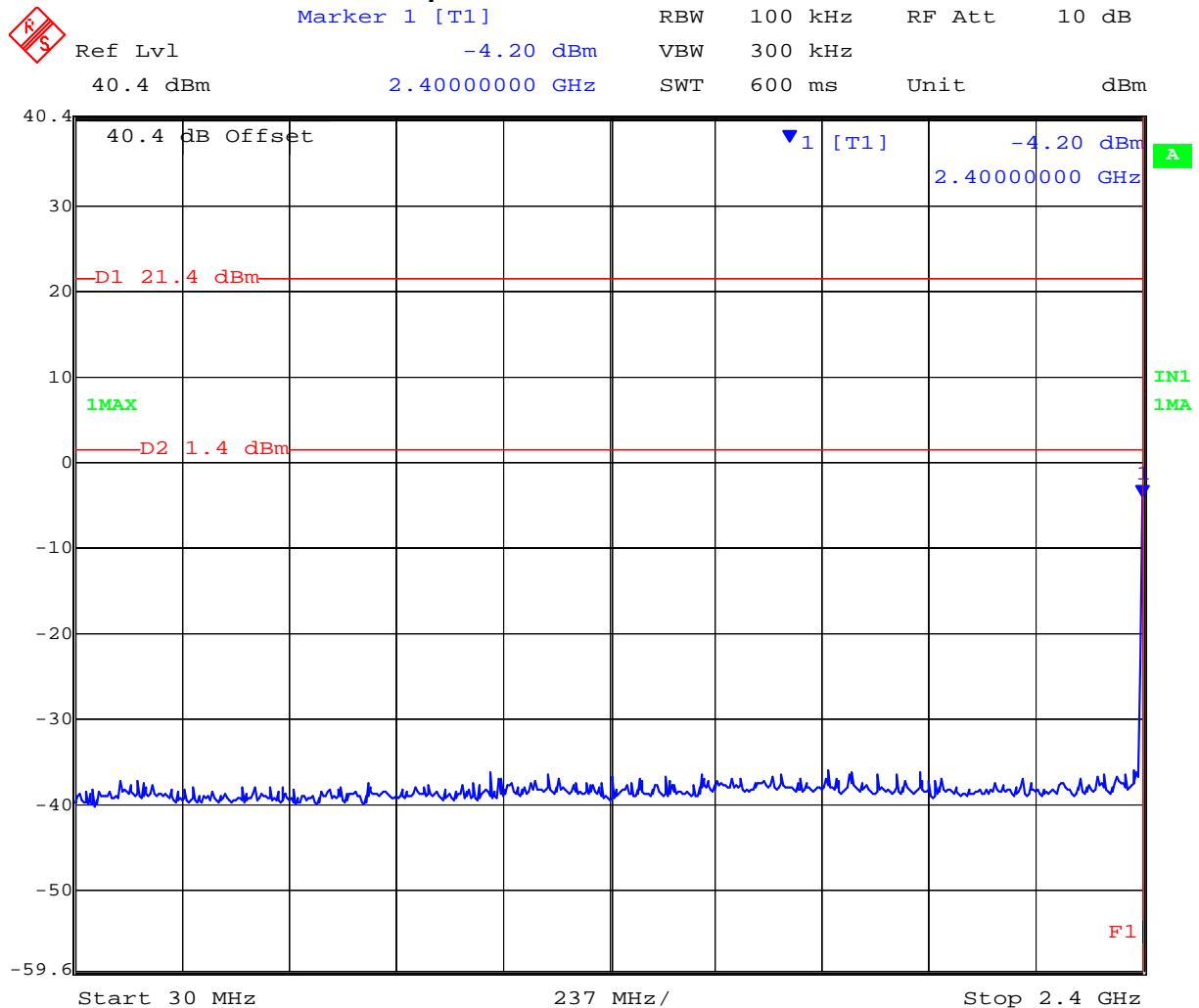

Date: 31.OCT.2005 13:10:50

This test report may be reproduced in full only. The document may only be updated by MiCOM Labs personnel. Any changes will be noted in the Document History section of the report.



Title: Exalt EX-2.4i-16 Fixed Link Radio
To: FCC 47 CFR Part15.247 & IC RSS-210
Serial #: EXLT19-A1 Rev A
Issue Date: 28th Feb 2007
Page: 105 of 248

Plot 77
9 MHz Bandwidth 64QAM Modulation
Conducted Spurious Emissions 2483.5 MHz to 7000 MHz

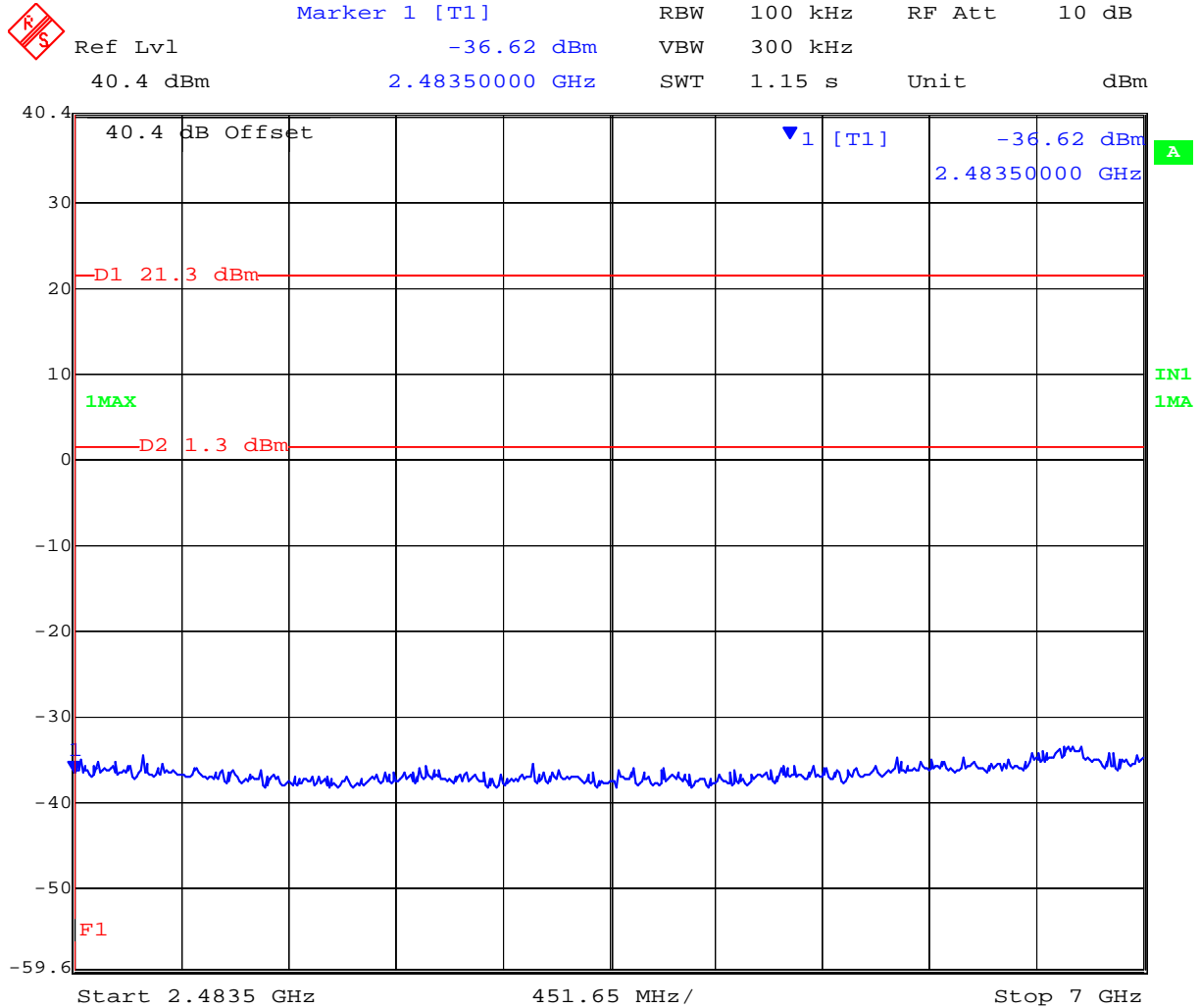

Date: 31.OCT.2005 14:04:18

This test report may be reproduced in full only. The document may only be updated by MiCOM Labs personnel. Any changes will be noted in the Document History section of the report.



Title: Exalt EX-2.4i-16 Fixed Link Radio
To: FCC 47 CFR Part15.247 & IC RSS-210
Serial #: EXLT19-A1 Rev A
Issue Date: 28th Feb 2007
Page: 106 of 248

Plot 78
9 MHz Bandwidth 64QAM Modulation
Conducted Spurious Emissions 7000 MHz to 26000 MHz

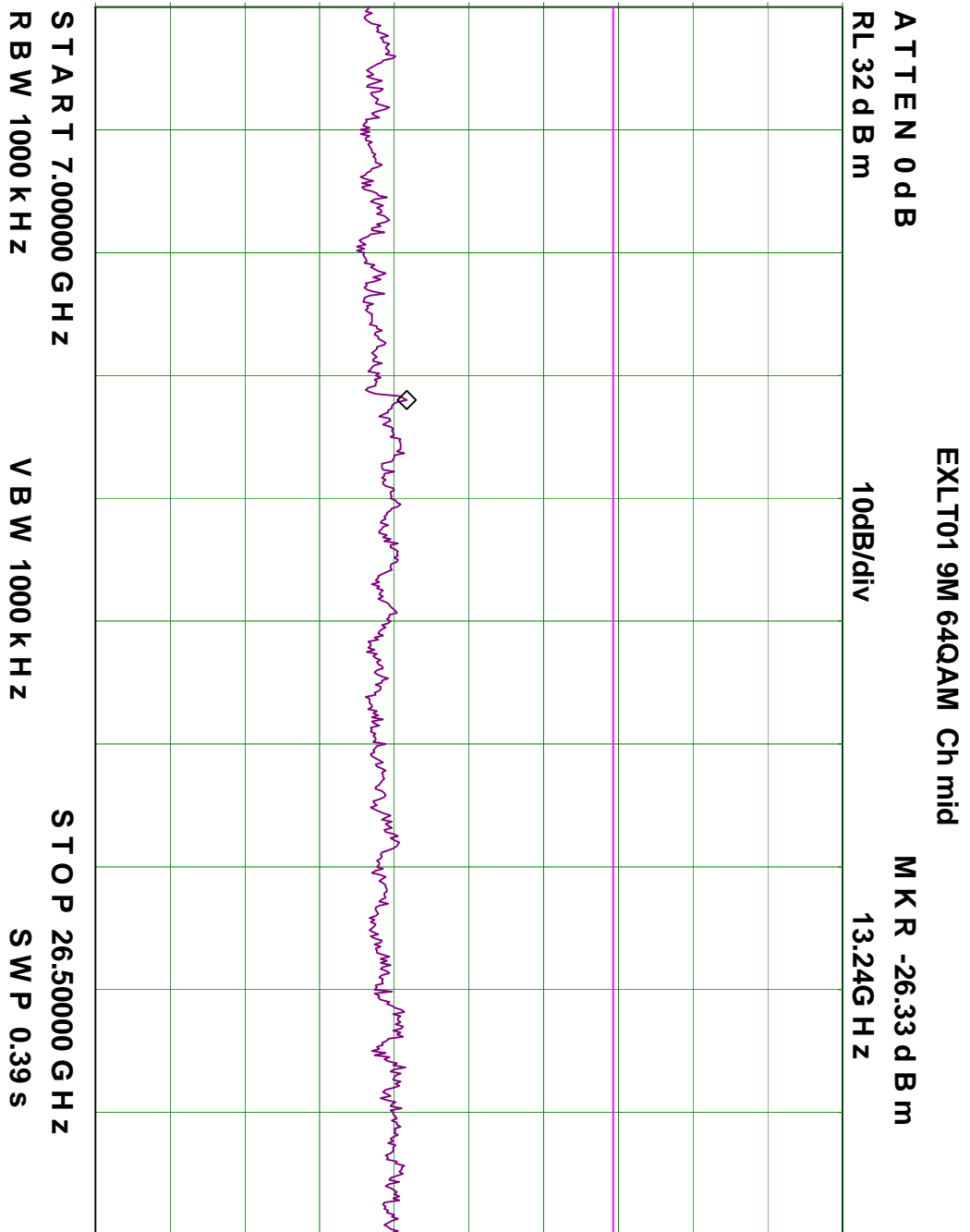

This test report may be reproduced in full only. The document may only be updated by MiCOM Labs personnel. Any changes will be noted in the Document History section of the report.



TABLE OF RESULTS – 18 MHz Bandwidth QPSK Modulation

Channel Centre Frequency	Start Frequency (MHz)	Stop Frequency (MHz)	Maximum Emission Observed (dBm)	Limit (dBm)	Plot #	Margin (dB)
2,437	30	2400	-14.93	-0.6	79	-14.33
2,437	2483.5	7000	-36.39	-2.5	80	-33.89
2,437	7000	26000	-26.66	-2.5	81	-24.16

Plot 79
18 MHz Bandwidth QPSK Modulation
Conducted Spurious Emissions 30 MHz to 2400 MHz

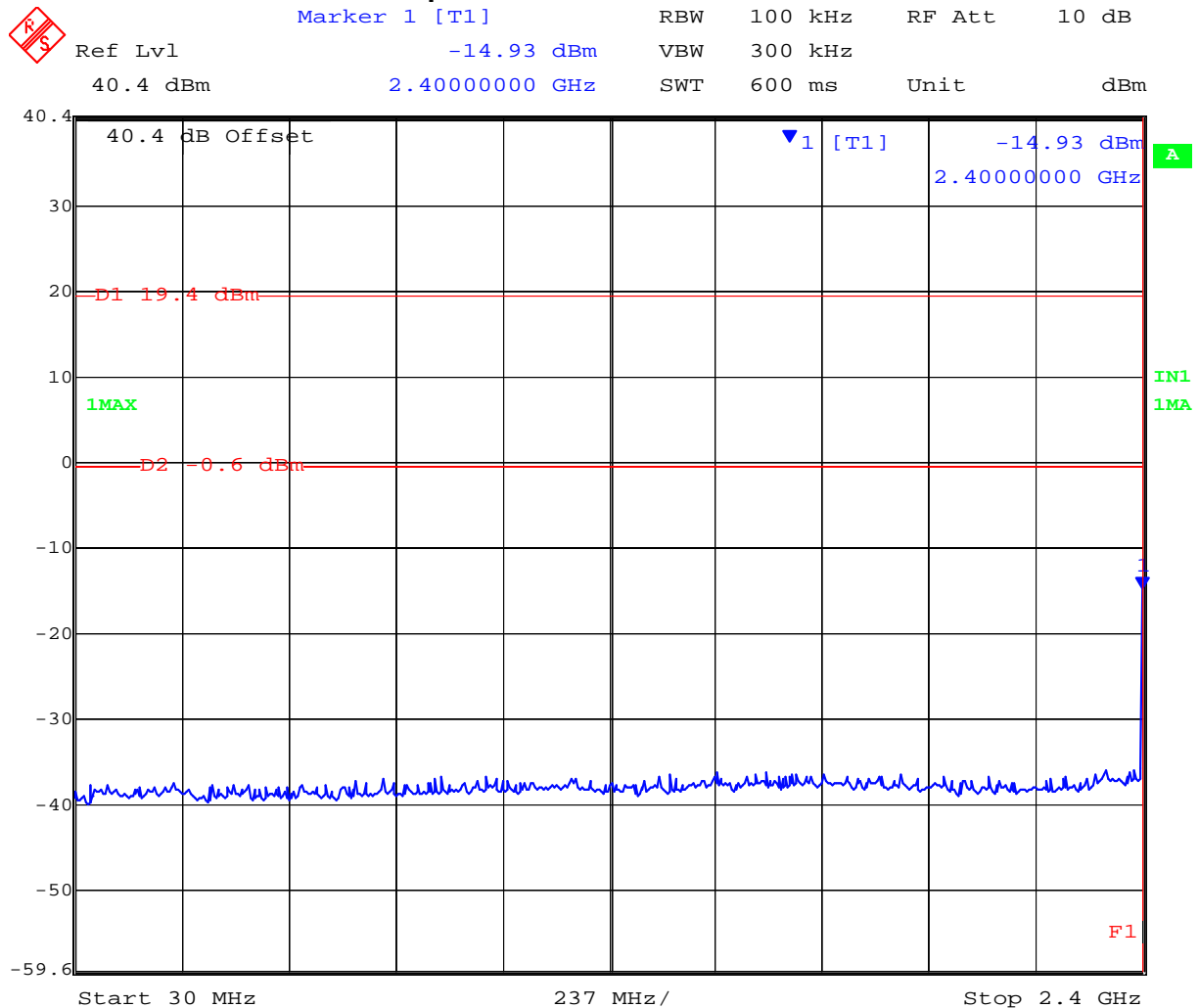

Date: 31.OCT.2005 13:25:59

This test report may be reproduced in full only. The document may only be updated by MiCOM Labs personnel. Any changes will be noted in the Document History section of the report.



Title: Exalt EX-2.4i-16 Fixed Link Radio
To: FCC 47 CFR Part15.247 & IC RSS-210
Serial #: EXLT19-A1 Rev A
Issue Date: 28th Feb 2007
Page: 108 of 248

Plot 80
18 MHz Bandwidth QPSK Modulation
Conducted Spurious Emissions 2483.5 MHz to 7000 MHz



Date: 31.OCT.2005 13:35:26

This test report may be reproduced in full only. The document may only be updated by MiCOM Labs personnel. Any changes will be noted in the Document History section of the report.



Title: Exalt EX-2.4i-16 Fixed Link Radio
To: FCC 47 CFR Part15.247 & IC RSS-210
Serial #: EXLT19-A1 Rev A
Issue Date: 28th Feb 2007
Page: 109 of 248

Plot 81
18 MHz Bandwidth QPSK Modulation
Conducted Spurious Emissions 7000 MHz to 26000 MHz

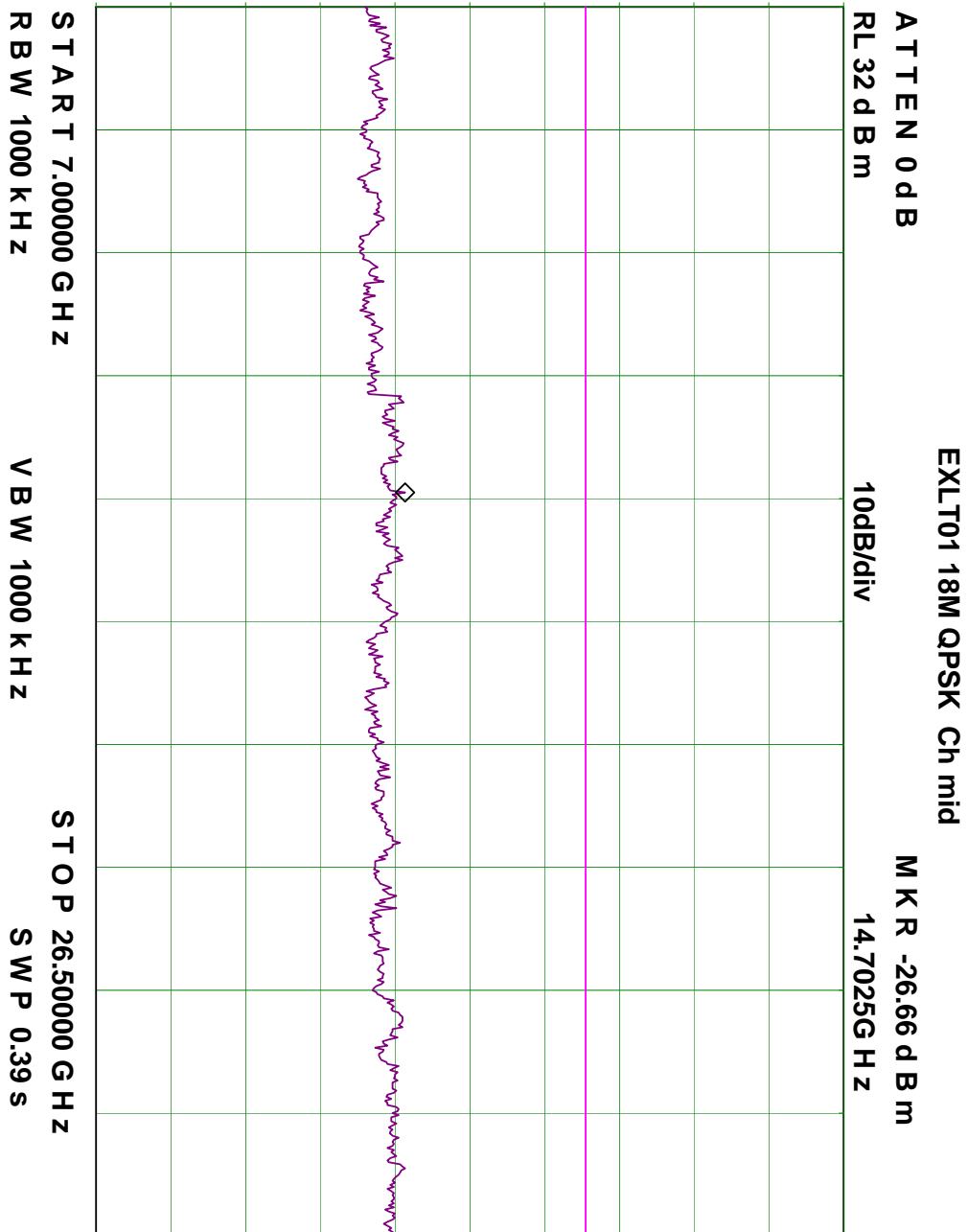

This test report may be reproduced in full only. The document may only be updated by MiCOM Labs personnel. Any changes will be noted in the Document History section of the report.



TABLE OF RESULTS – 18 MHz Bandwidth 16QAM Modulation

Channel Centre Frequency	Start Frequency (MHz)	Stop Frequency (MHz)	Maximum Emission Observed (dBm)	Limit (dBm)	Plot #	Margin (dB)
2,437	30	2400	-13.81	-1.6	82	-12.21
2,437	2483.5	7000	-37.53	-2.5	83	-35.03
2,437	7000	26000	-26.50	-2.5	84	-24.0

Plot 82
18 MHz Bandwidth 16QAM Modulation
Conducted Spurious Emissions 30 MHz to 2400 MHz

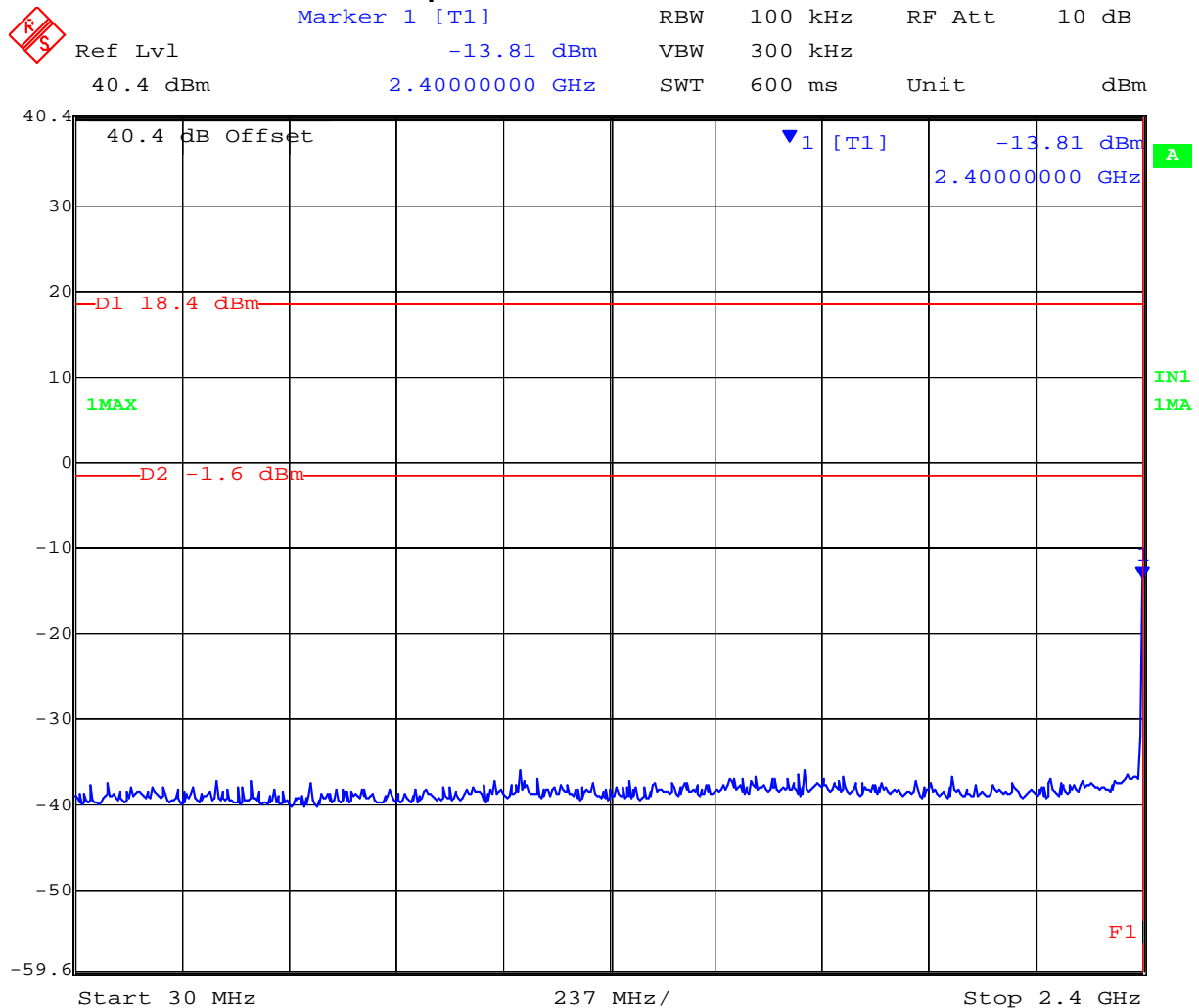

Date: 31.OCT.2005 13:28:07

This test report may be reproduced in full only. The document may only be updated by MiCOM Labs personnel. Any changes will be noted in the Document History section of the report.



Title: Exalt EX-2.4i-16 Fixed Link Radio
To: FCC 47 CFR Part15.247 & IC RSS-210
Serial #: EXLT19-A1 Rev A
Issue Date: 28th Feb 2007
Page: 111 of 248

Plot 83
18 MHz Bandwidth 16QAM Modulation
Conducted Spurious Emissions 2483.5 MHz to 7000 MHz

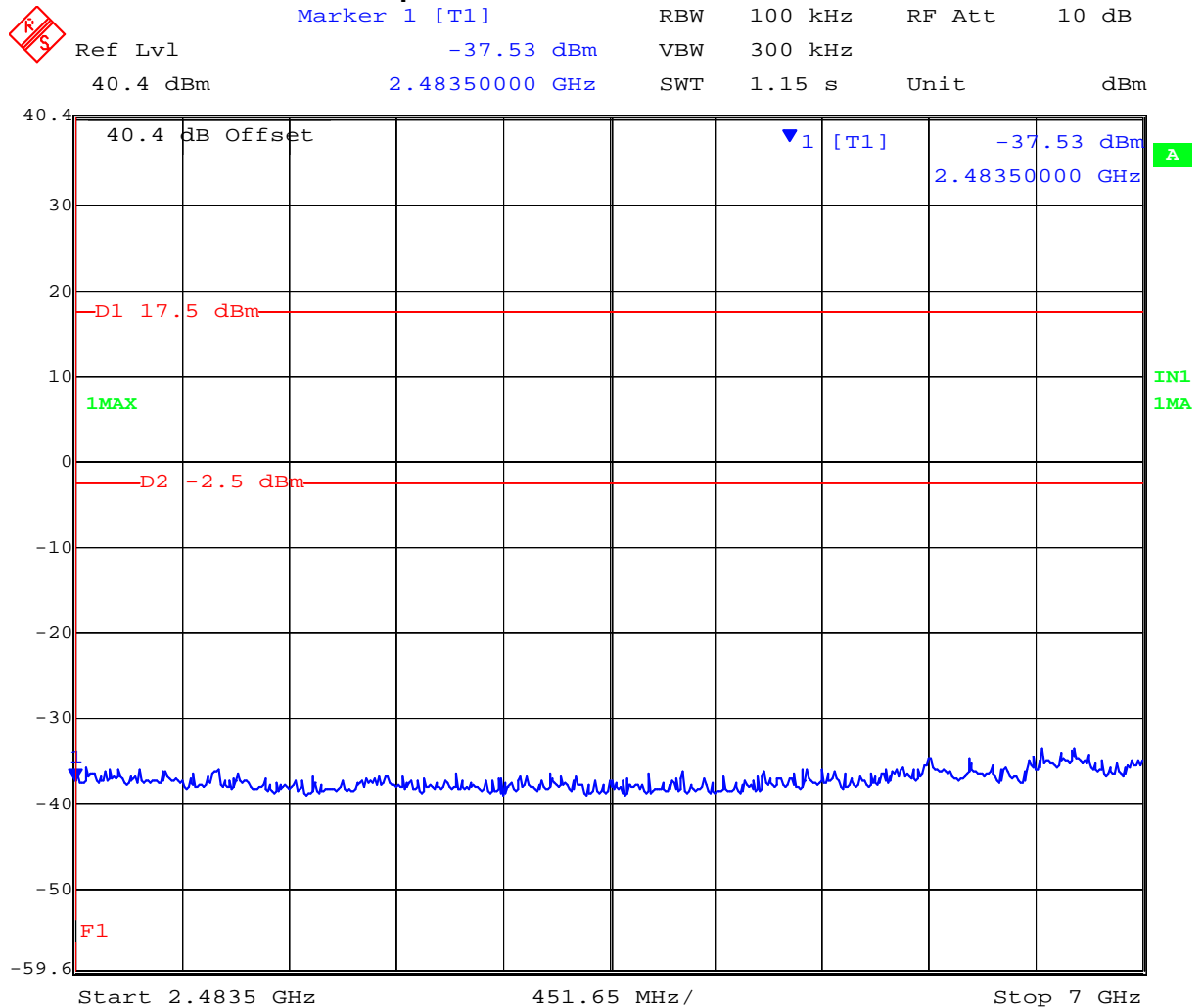

Date: 31.OCT.2005 14:05:55

This test report may be reproduced in full only. The document may only be updated by MiCOM Labs personnel. Any changes will be noted in the Document History section of the report.



Title: Exalt EX-2.4i-16 Fixed Link Radio
To: FCC 47 CFR Part15.247 & IC RSS-210
Serial #: EXLT19-A1 Rev A
Issue Date: 28th Feb 2007
Page: 112 of 248

Plot 84
18 MHz Bandwidth 16QAM Modulation
Conducted Spurious Emissions 7000 MHz to 26000 MHz

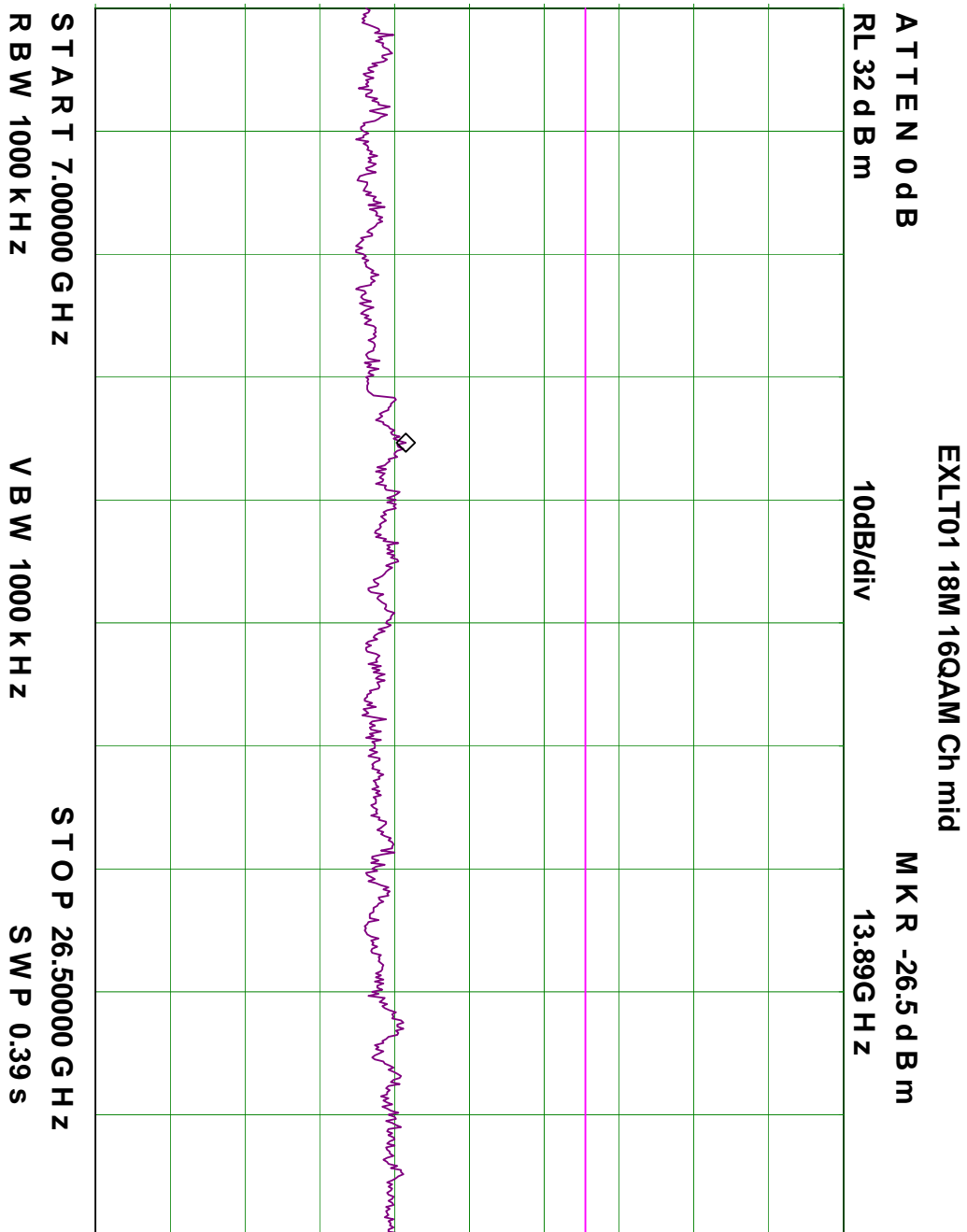

This test report may be reproduced in full only. The document may only be updated by MiCOM Labs personnel. Any changes will be noted in the Document History section of the report.



TABLE OF RESULTS – 18 MHz Bandwidth 64QAM Modulation

Channel Centre Frequency	Start Frequency (MHz)	Stop Frequency (MHz)	Maximum Emission Observed (dBm)	Limit (dBm)	Plot #	Margin (dB)
2,437	30	2400	-13.17	-2.5	85	-10.67
2,437	2483.5	7000	-33.01	-2.5	86	-30.51
2,437	7000	26000	-25.83	-2.5	87	-23.33

Plot 85
18 MHz Bandwidth 64QAM Modulation
Conducted Spurious Emissions 30 MHz to 2400 MHz

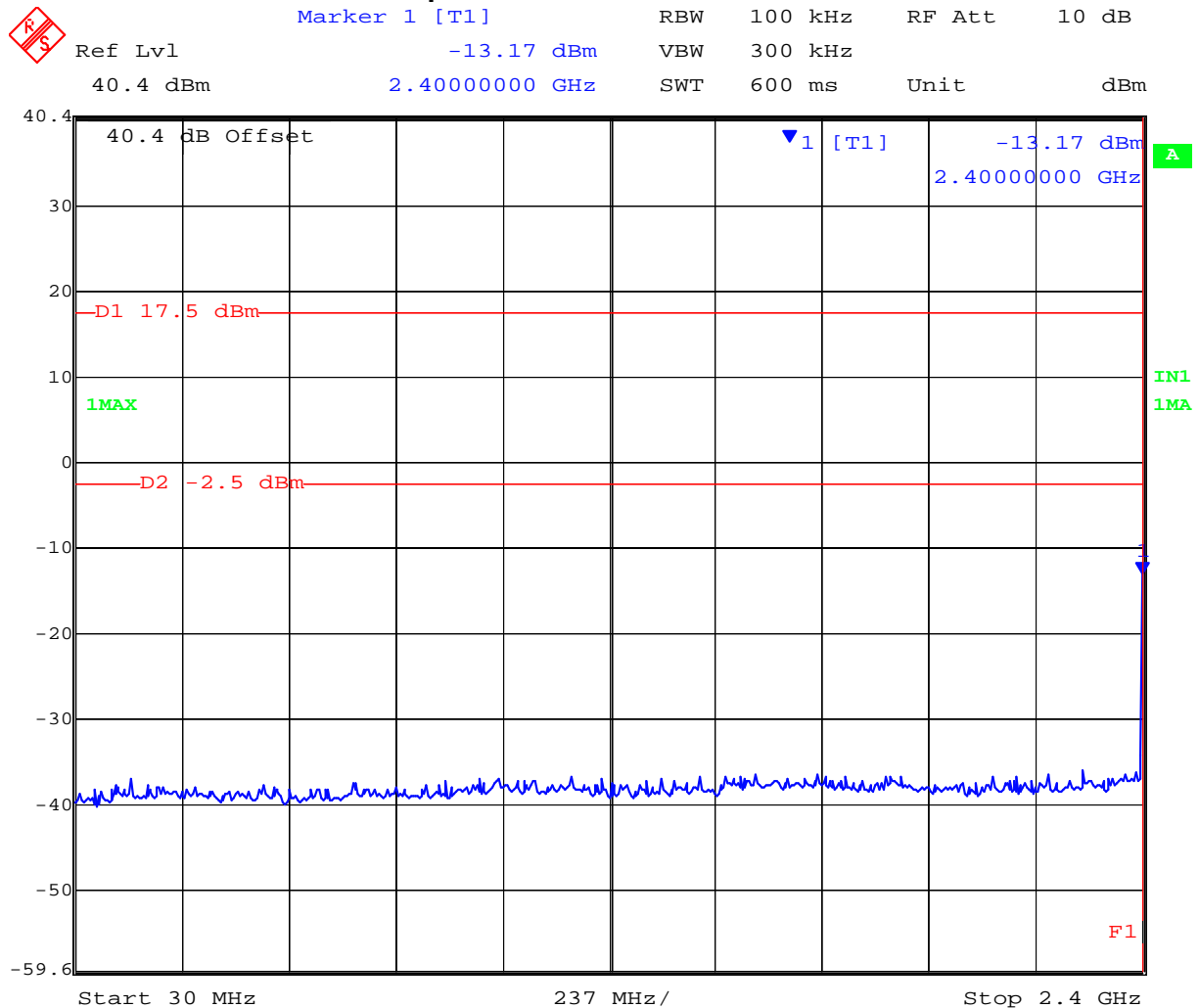

Date: 31.OCT.2005 13:31:16

This test report may be reproduced in full only. The document may only be updated by MiCOM Labs personnel. Any changes will be noted in the Document History section of the report.



Title: Exalt EX-2.4i-16 Fixed Link Radio
To: FCC 47 CFR Part15.247 & IC RSS-210
Serial #: EXLT19-A1 Rev A
Issue Date: 28th Feb 2007
Page: 114 of 248

Plot 86
18 MHz Bandwidth 64QAM Modulation
Conducted Spurious Emissions 2483.5 MHz to 7000 MHz



Date: 31.OCT.2005 14:07:08

This test report may be reproduced in full only. The document may only be updated by MiCOM Labs personnel. Any changes will be noted in the Document History section of the report.



Title: Exalt EX-2.4i-16 Fixed Link Radio
To: FCC 47 CFR Part15.247 & IC RSS-210
Serial #: EXLT19-A1 Rev A
Issue Date: 28th Feb 2007
Page: 115 of 248

Plot 87
18 MHz Bandwidth 64QAM Modulation
Conducted Spurious Emissions 7000 MHz to 26000 MHz

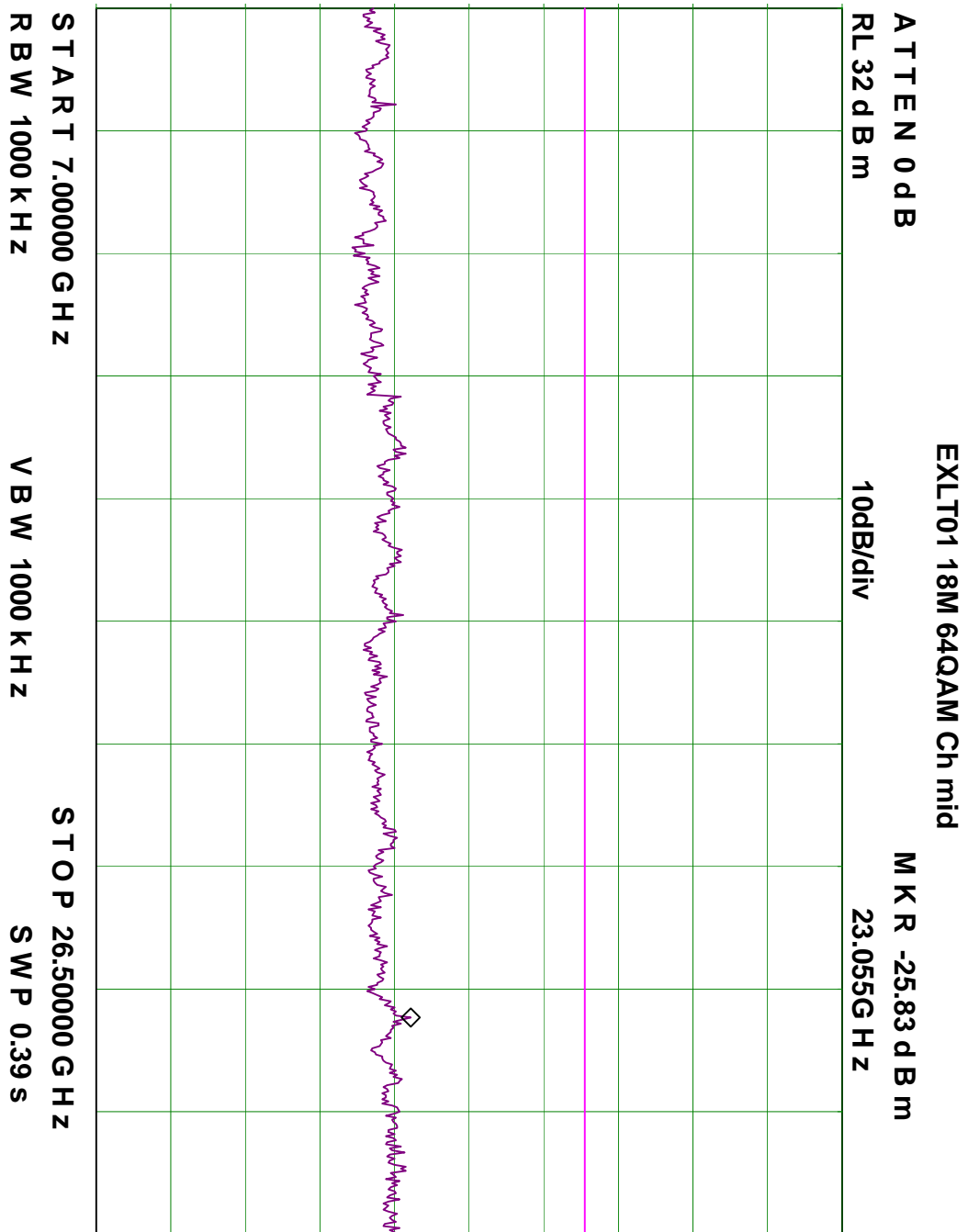

This test report may be reproduced in full only. The document may only be updated by MiCOM Labs personnel. Any changes will be noted in the Document History section of the report.



Title: Exalt EX-2.4i-16 Fixed Link Radio
To: FCC 47 CFR Part15.247 & IC RSS-210
Serial #: EXLT19-A1 Rev A
Issue Date: 28th Feb 2007
Page: 116 of 248

TABLE OF RESULTS – 36 MHz Bandwidth QPSK Modulation

Channel Centre Frequency	Start Frequency (MHz)	Stop Frequency (MHz)	Maximum Emission Observed (dBm)	Limit (dBm)	Plot #	Margin (dB)
2,437	30	2400	-11.39	-4.0	88	-7.39
2,437	2483.5	7000	-36.21	-4.9	89	-31.31
2,437	7000	26000	-25.50	-4.9	90	-20.60

Plot 88
36 MHz Bandwidth QPSK Modulation
Conducted Spurious Emissions 30 MHz to 2400 MHz

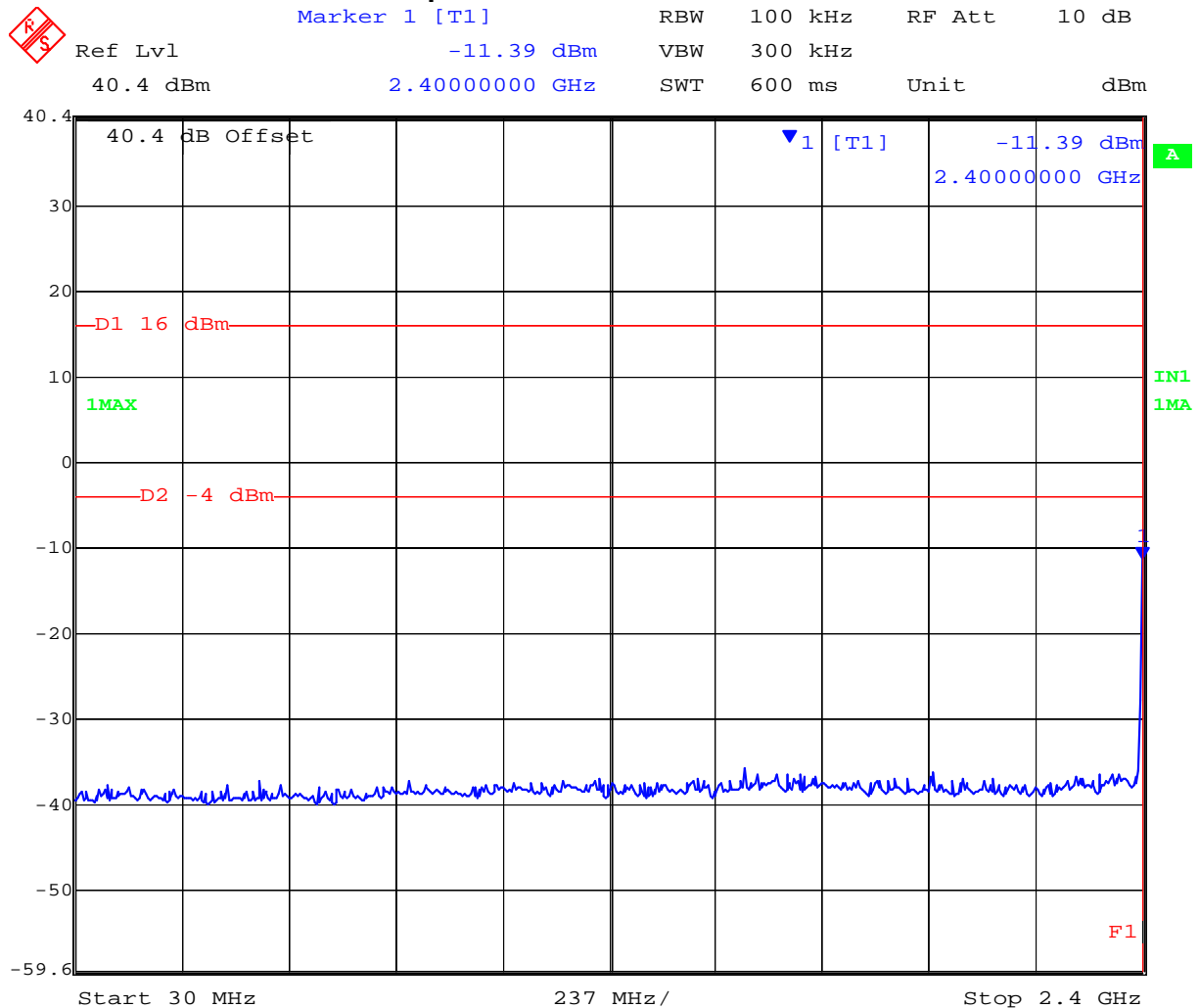

Date: 31.OCT.2005 14:10:43

This test report may be reproduced in full only. The document may only be updated by MiCOM Labs personnel. Any changes will be noted in the Document History section of the report.



Title: Exalt EX-2.4i-16 Fixed Link Radio
To: FCC 47 CFR Part15.247 & IC RSS-210
Serial #: EXLT19-A1 Rev A
Issue Date: 28th Feb 2007
Page: 117 of 248

Plot 89
36 MHz Bandwidth QPSK Modulation
Conducted Spurious Emissions 2483.5 MHz to 7000 MHz

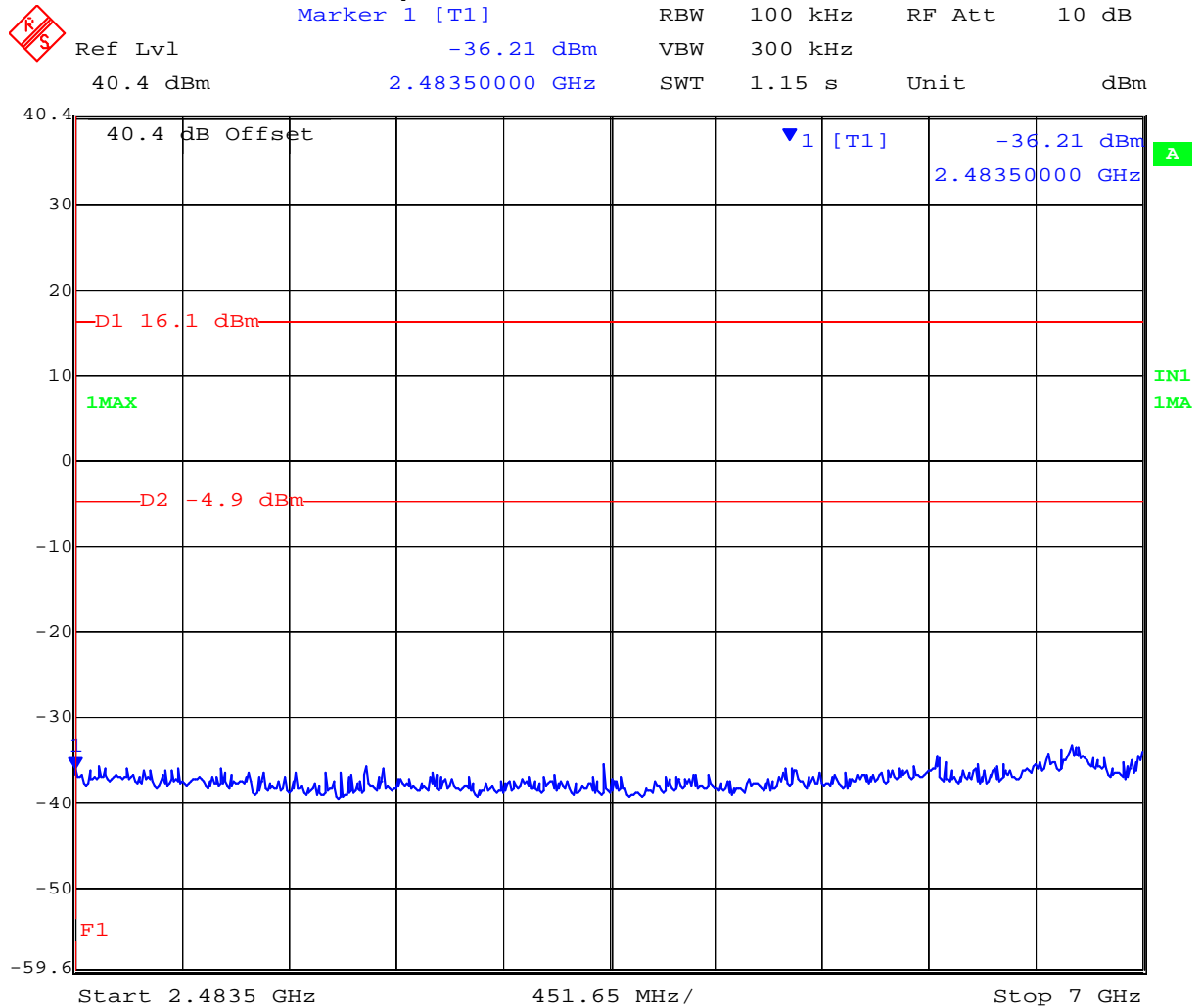

Date: 31.OCT.2005 14:33:13

This test report may be reproduced in full only. The document may only be updated by MiCOM Labs personnel. Any changes will be noted in the Document History section of the report.



Title: Exalt EX-2.4i-16 Fixed Link Radio
To: FCC 47 CFR Part15.247 & IC RSS-210
Serial #: EXLT19-A1 Rev A
Issue Date: 28th Feb 2007
Page: 118 of 248

Plot 90
36 MHz Bandwidth QPSK Modulation
Conducted Spurious Emissions 7000 MHz to 26000 MHz

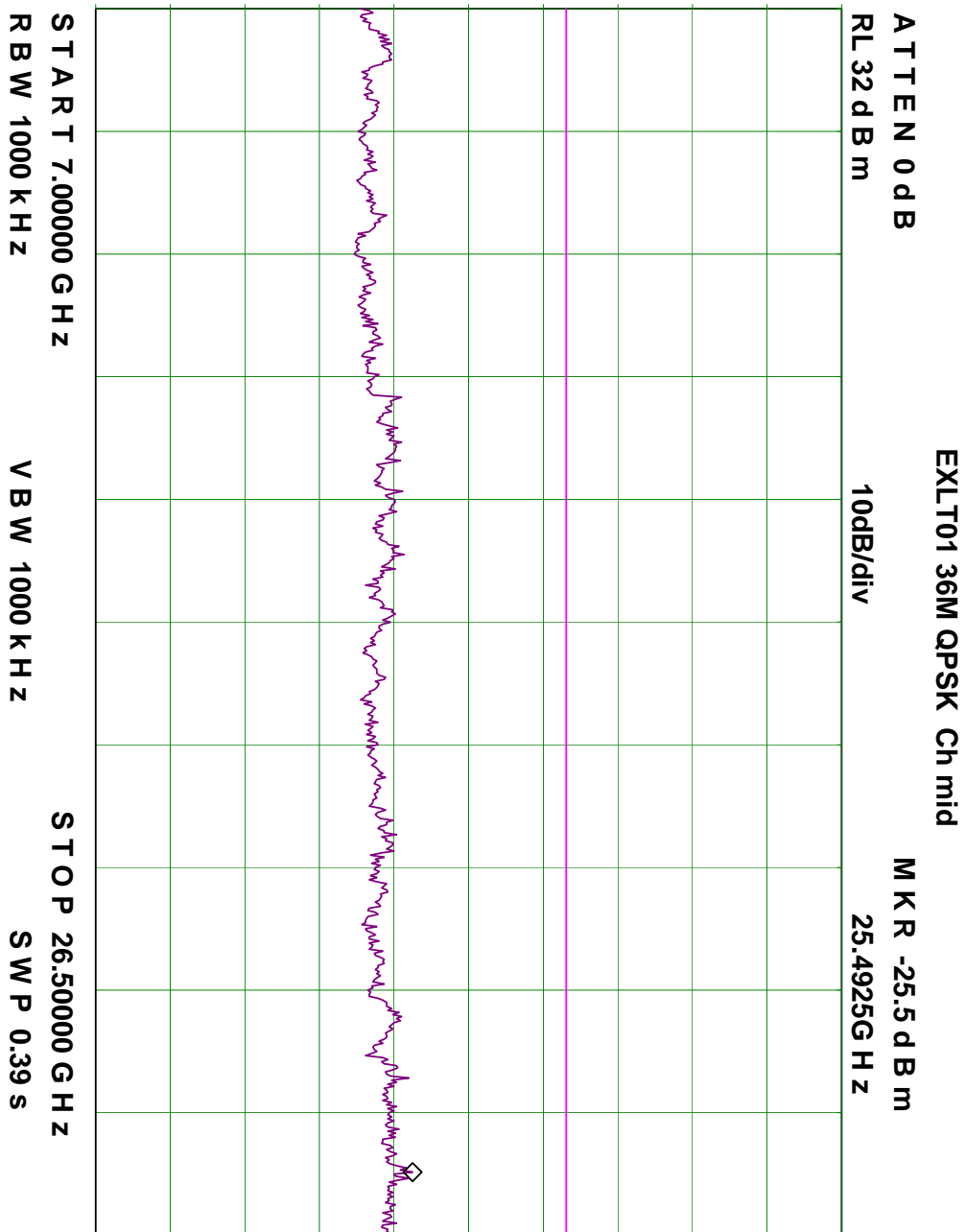

This test report may be reproduced in full only. The document may only be updated by MiCOM Labs personnel. Any changes will be noted in the Document History section of the report.



TABLE OF RESULTS – 36 MHz Bandwidth 16QAM Modulation

Channel Centre Frequency	Start Frequency (MHz)	Stop Frequency (MHz)	Maximum Emission Observed (dBm)	Limit (dBm)	Plot #	Margin (dB)
2,437	30	2400	-12.73	-4.5	91	-8.23
2,437	2483.5	7000	-33.41	-4.4	92	-29.01
2,437	7000	26000	-26.33	-4.4	93	-21.99

Plot 91
36 MHz Bandwidth 16QAM Modulation
Conducted Spurious Emissions 30 MHz to 2400 MHz

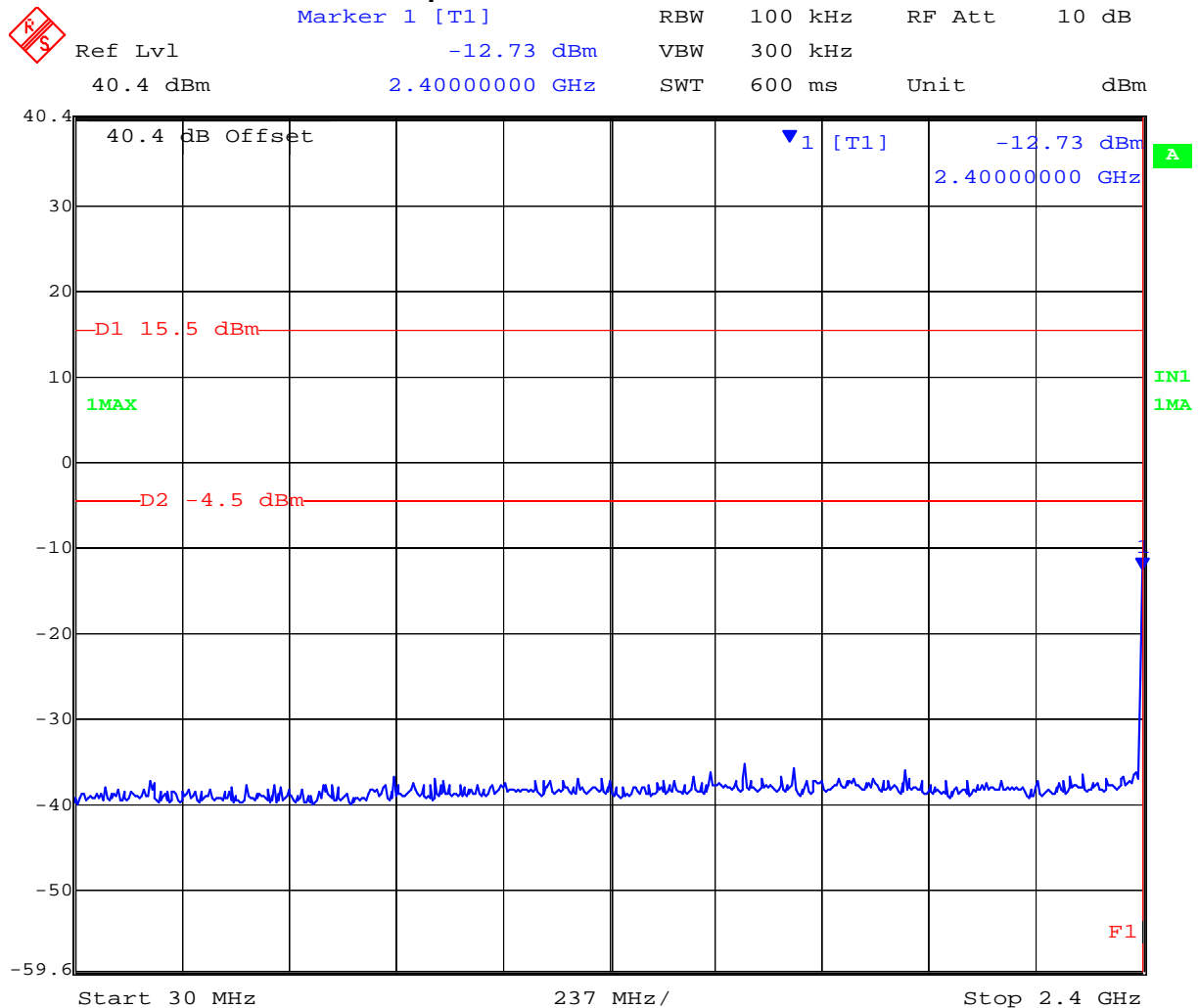

Date: 31.OCT.2005 14:22:40

This test report may be reproduced in full only. The document may only be updated by MiCOM Labs personnel. Any changes will be noted in the Document History section of the report.



Title: Exalt EX-2.4i-16 Fixed Link Radio
To: FCC 47 CFR Part15.247 & IC RSS-210
Serial #: EXLT19-A1 Rev A
Issue Date: 28th Feb 2007
Page: 120 of 248

Plot 92
36 MHz Bandwidth 16QAM Modulation
Conducted Spurious Emissions 2483.5 MHz to 7000 MHz

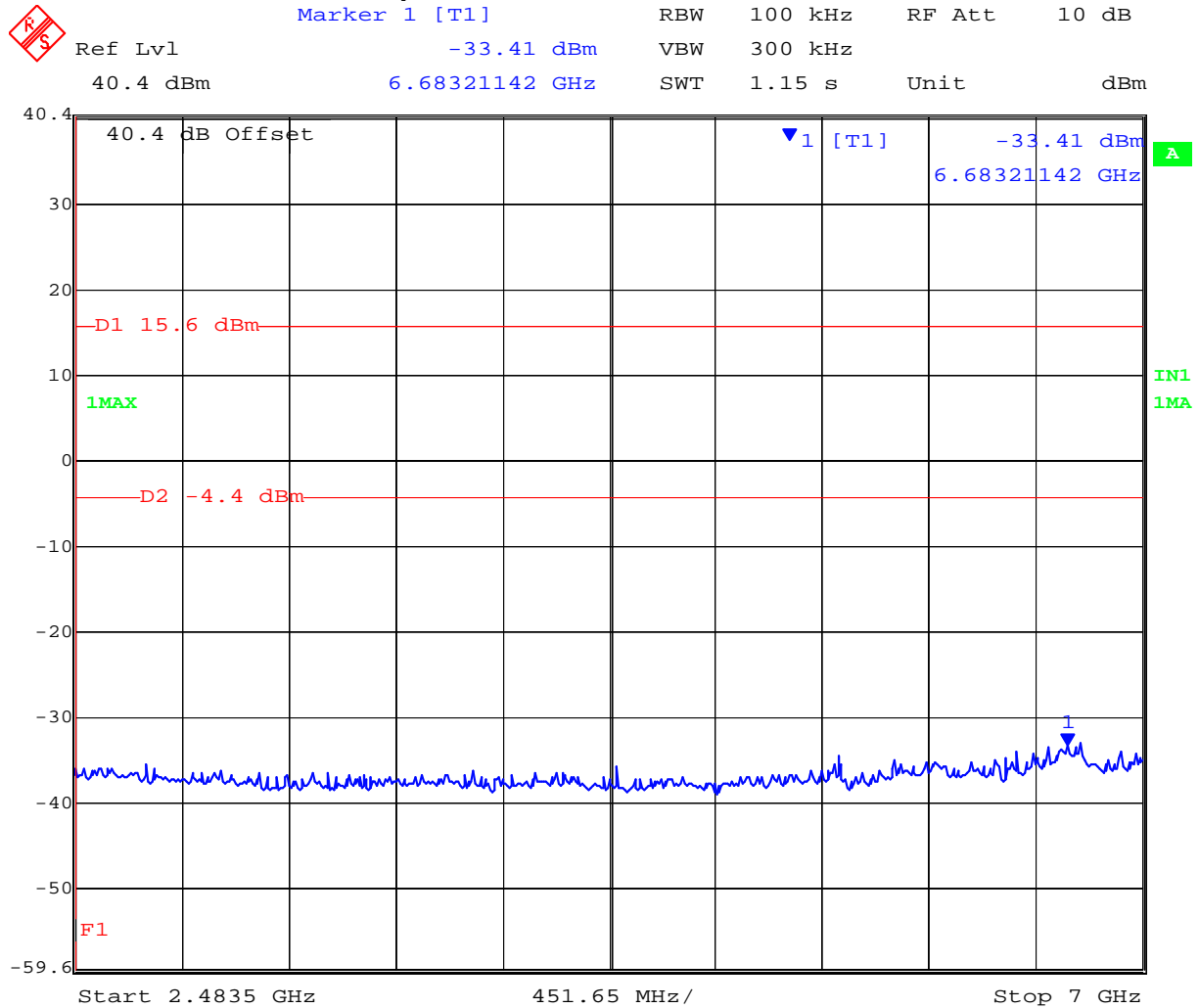

Date: 31.OCT.2005 14:35:37

This test report may be reproduced in full only. The document may only be updated by MiCOM Labs personnel. Any changes will be noted in the Document History section of the report.



Title: Exalt EX-2.4i-16 Fixed Link Radio
To: FCC 47 CFR Part15.247 & IC RSS-210
Serial #: EXLT19-A1 Rev A
Issue Date: 28th Feb 2007
Page: 121 of 248

Plot 93
36 MHz Bandwidth 16QAM Modulation
Conducted Spurious Emissions 7000 MHz to 26000 MHz

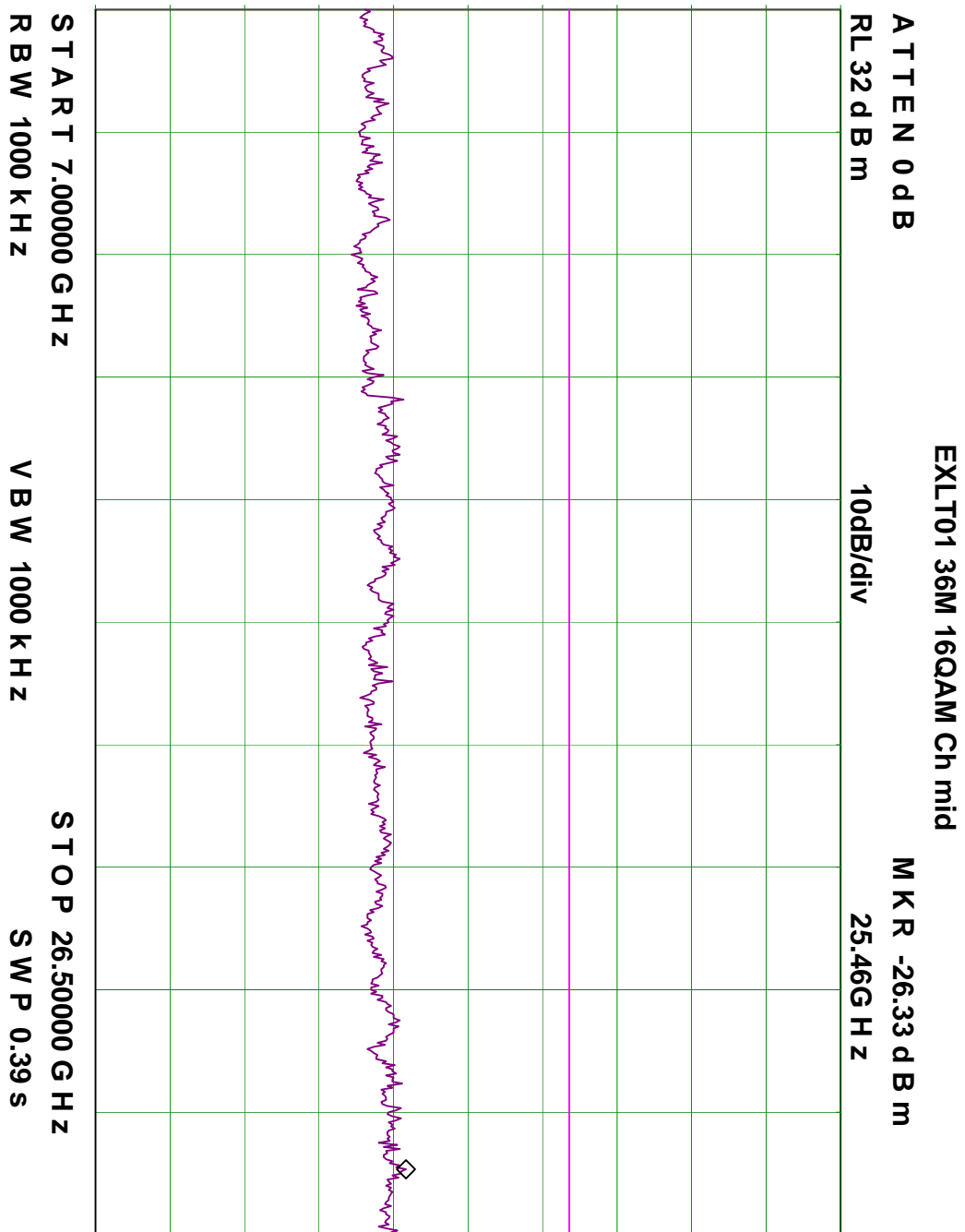

This test report may be reproduced in full only. The document may only be updated by MiCOM Labs personnel. Any changes will be noted in the Document History section of the report.



TABLE OF RESULTS – 36 MHz Bandwidth 64QAM Modulation

Channel Centre Frequency	Start Frequency (MHz)	Stop Frequency (MHz)	Maximum Emission Observed (dBm)	Limit (dBm)	Plot #	Margin (dB)
2,437	30	2400	-11.80	-5.80	94	-6.00
2,437	2483.5	7000	-33.94	-5.60	95	-28.34
2,437	7000	26000	-26.16	-5.60	96	-20.56

Plot 94
36 MHz Bandwidth 64QAM Modulation
Conducted Spurious Emissions 30 MHz to 2400 MHz

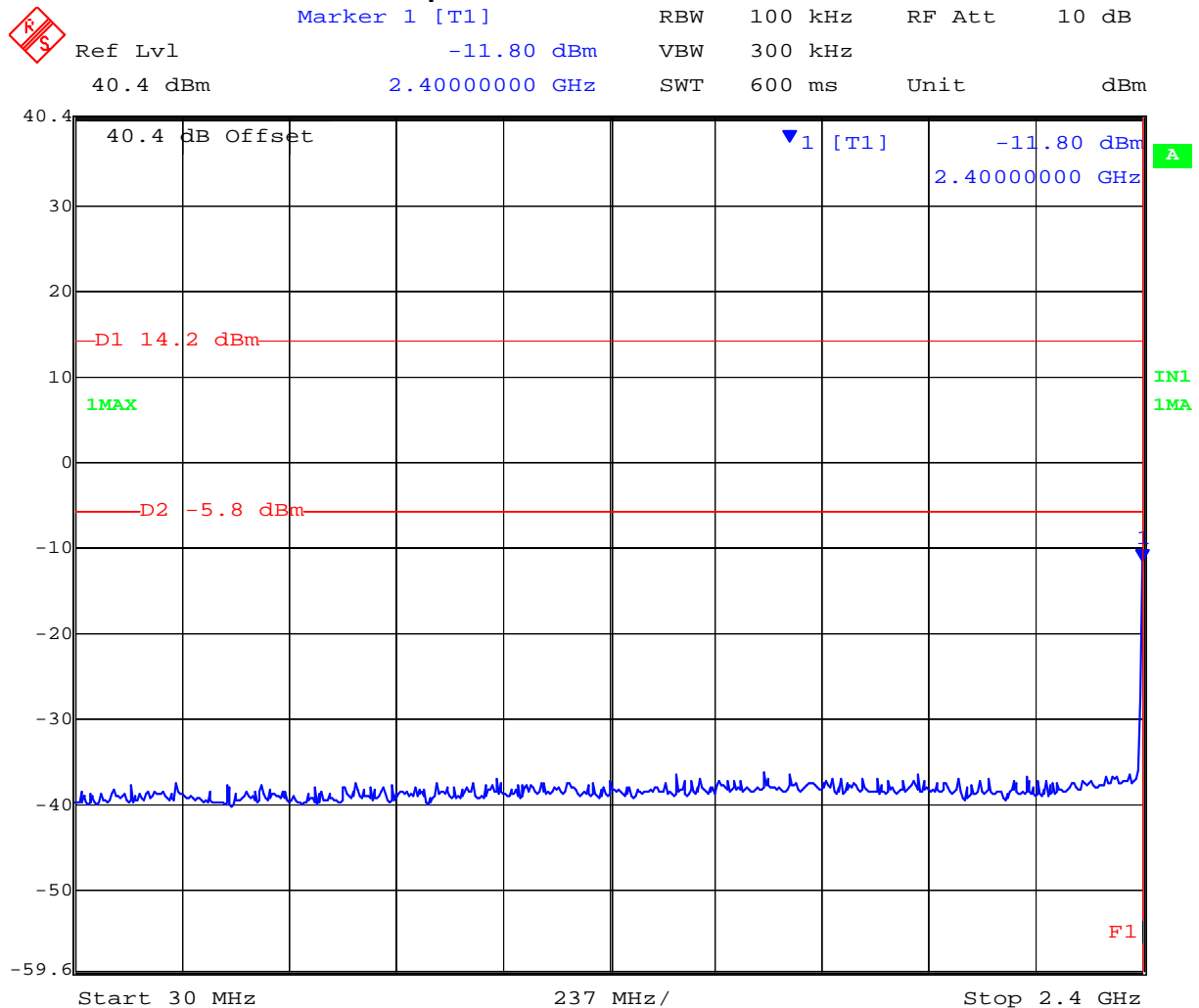

Date: 31.OCT.2005 14:30:09

This test report may be reproduced in full only. The document may only be updated by MiCOM Labs personnel. Any changes will be noted in the Document History section of the report.



Title: Exalt EX-2.4i-16 Fixed Link Radio
To: FCC 47 CFR Part15.247 & IC RSS-210
Serial #: EXLT19-A1 Rev A
Issue Date: 28th Feb 2007
Page: 123 of 248

Plot 95
36 MHz Bandwidth 64QAM Modulation
Conducted Spurious Emissions 2483.5 MHz to 7000 MHz

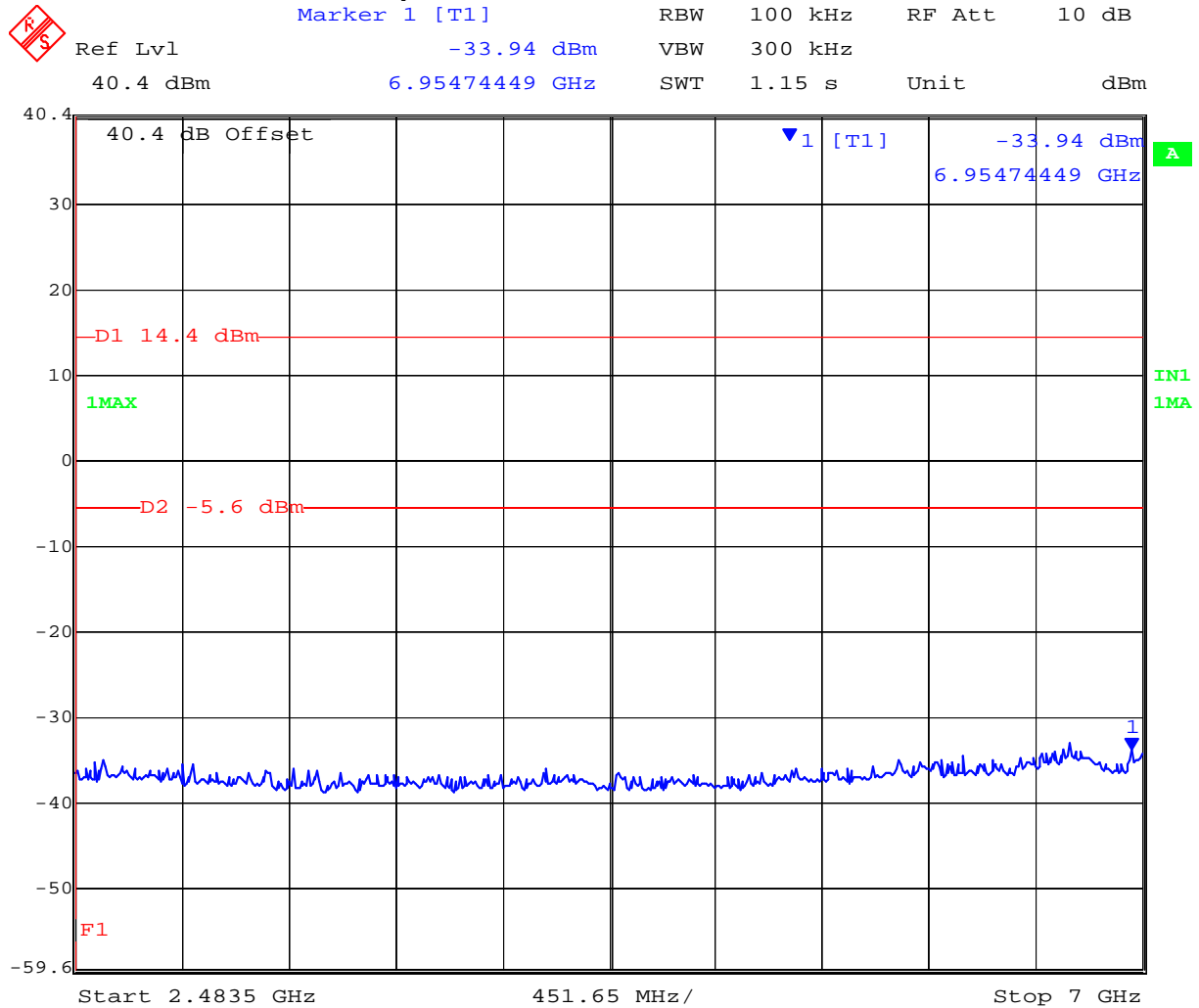

Date: 31.OCT.2005 14:37:30

This test report may be reproduced in full only. The document may only be updated by MiCOM Labs personnel. Any changes will be noted in the Document History section of the report.



Title: Exalt EX-2.4i-16 Fixed Link Radio
To: FCC 47 CFR Part15.247 & IC RSS-210
Serial #: EXLT19-A1 Rev A
Issue Date: 28th Feb 2007
Page: 124 of 248

Plot 96
36 MHz Bandwidth 64QAM Modulation
Conducted Spurious Emissions 7000 MHz to 26000 MHz

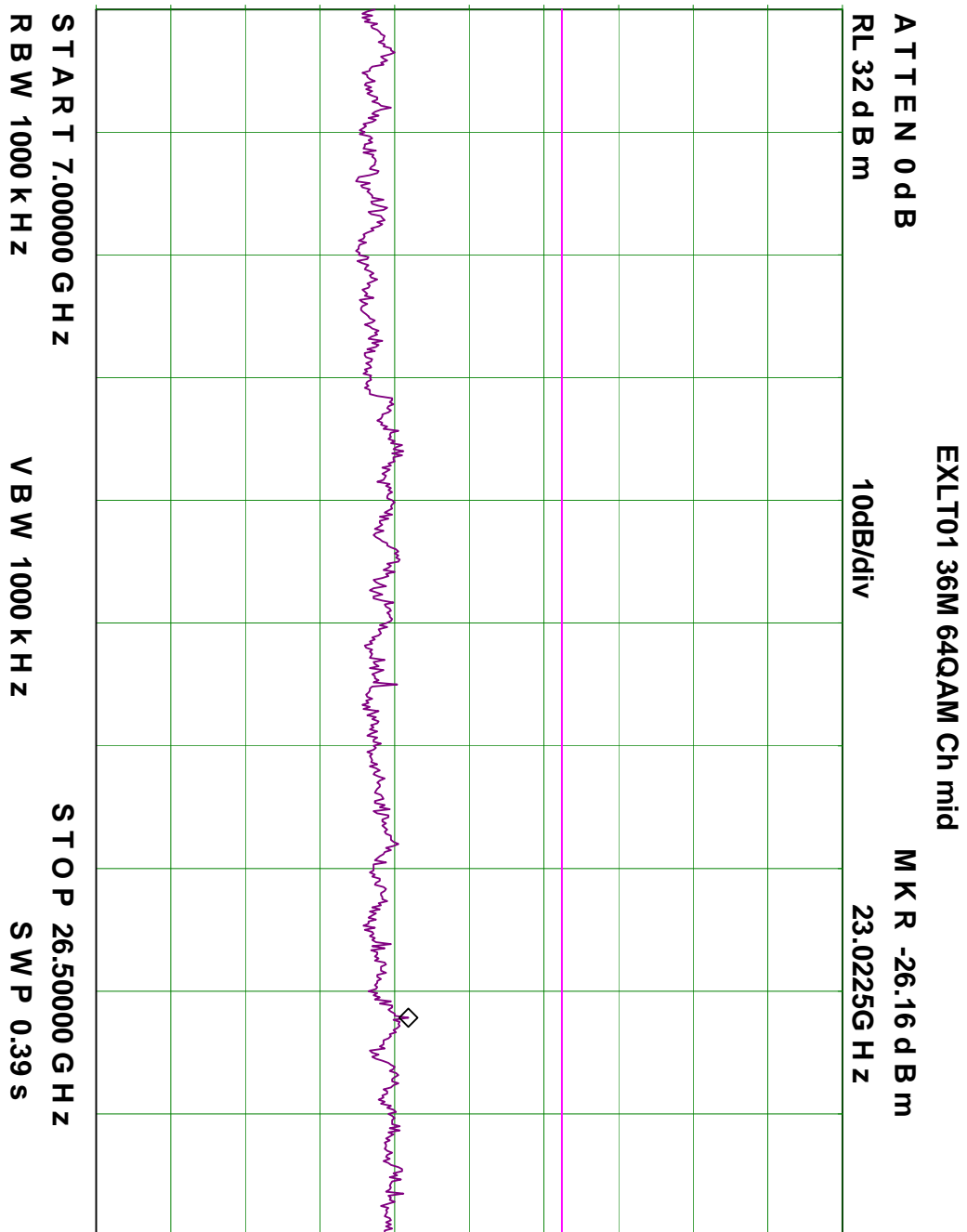

This test report may be reproduced in full only. The document may only be updated by MiCOM Labs personnel. Any changes will be noted in the Document History section of the report.



TABLE OF RESULTS – 72 MHz Bandwidth QPSK Modulation

Channel Centre Frequency	Start Frequency (MHz)	Stop Frequency (MHz)	Maximum Emission Observed (dBm)	Limit (dBm)	Plot #	Margin (dB)
2,437	30	2400	-15.51	-6.7	97	-8.81
2,437	2483.5	7000	-33.22	-6.7	98	-26.52
2,437	7000	26000	-26.16	-6.7	99	-19.46

Plot 97
72 MHz Bandwidth QPSK Modulation
Conducted Spurious Emissions 30 MHz to 2400 MHz

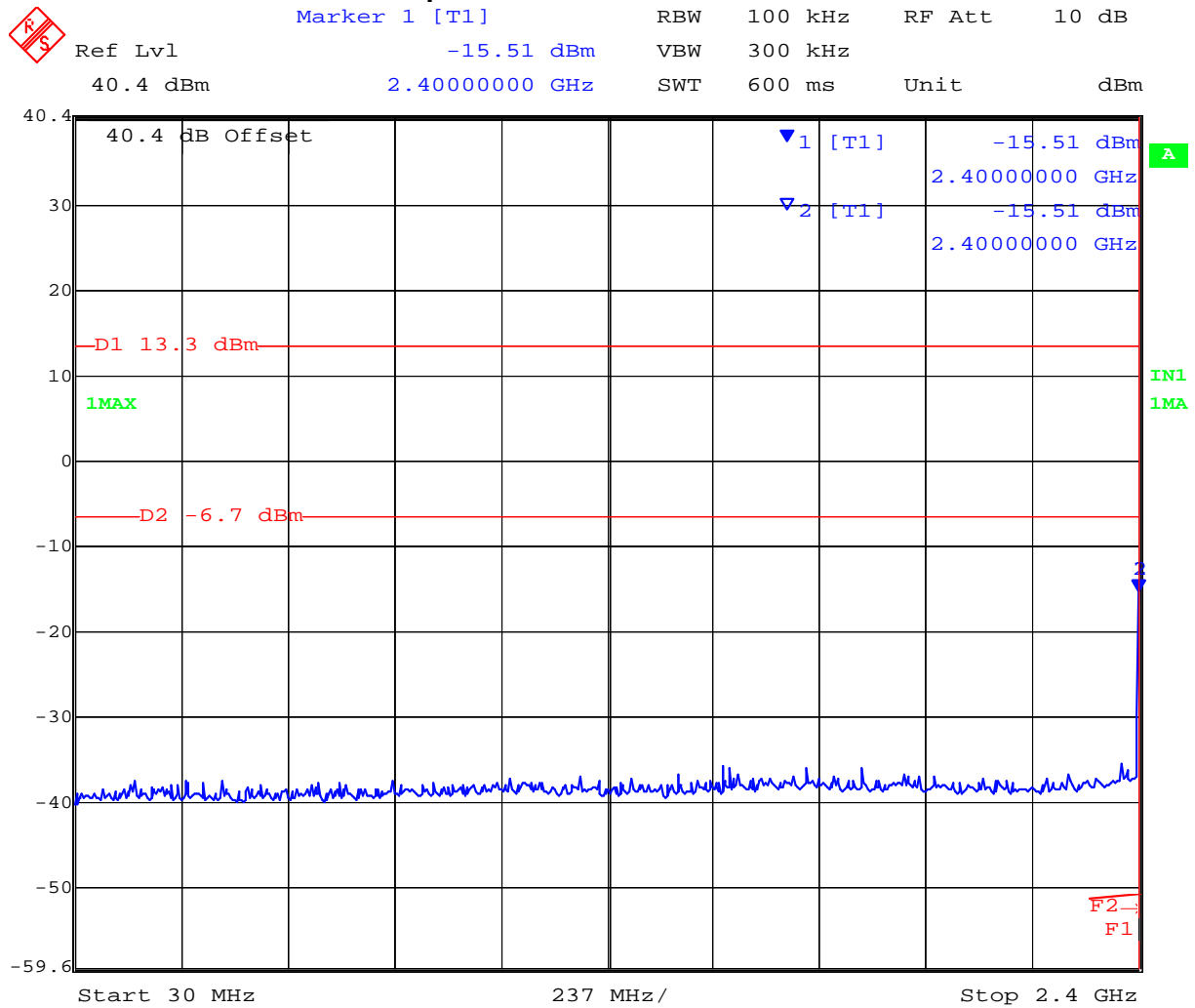

Date: 31.OCT.2005 15:03:24

This test report may be reproduced in full only. The document may only be updated by MiCOM Labs personnel. Any changes will be noted in the Document History section of the report.



Title: Exalt EX-2.4i-16 Fixed Link Radio
To: FCC 47 CFR Part15.247 & IC RSS-210
Serial #: EXLT19-A1 Rev A
Issue Date: 28th Feb 2007
Page: 126 of 248

Plot 98
72 MHz Bandwidth QPSK Modulation
Conducted Spurious Emissions 2483.5 MHz to 7000 MHz



Date: 31.OCT.2005 15:04:22

This test report may be reproduced in full only. The document may only be updated by MiCOM Labs personnel. Any changes will be noted in the Document History section of the report.



Title: Exalt EX-2.4i-16 Fixed Link Radio
To: FCC 47 CFR Part15.247 & IC RSS-210
Serial #: EXLT19-A1 Rev A
Issue Date: 28th Feb 2007
Page: 127 of 248

Plot 99
72 MHz Bandwidth QPSK Modulation
Conducted Spurious Emissions 7000 MHz to 26000 MHz

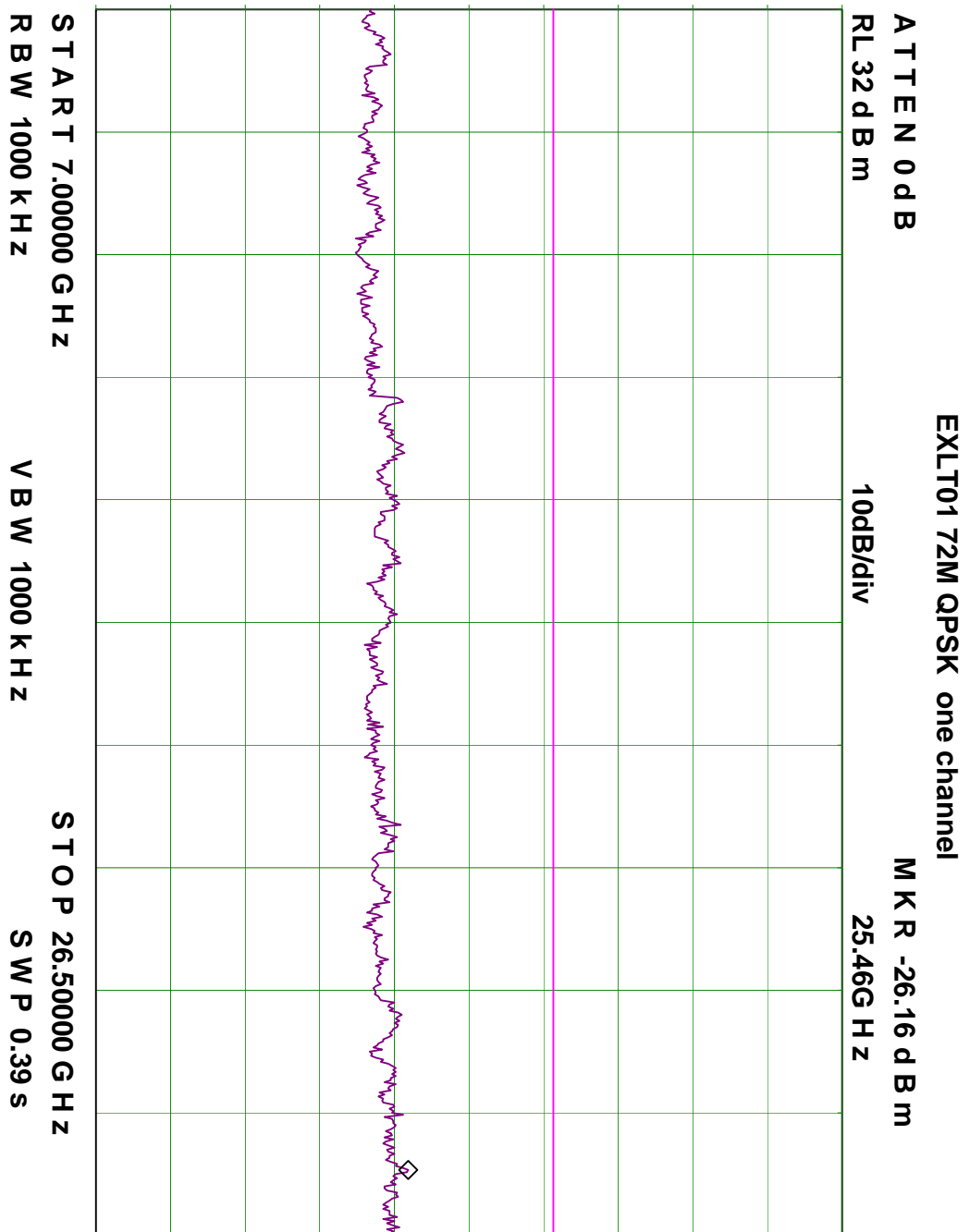

This test report may be reproduced in full only. The document may only be updated by MiCOM Labs personnel. Any changes will be noted in the Document History section of the report.



Title: Exalt EX-2.4i-16 Fixed Link Radio
To: FCC 47 CFR Part15.247 & IC RSS-210
Serial #: EXLT19-A1 Rev A
Issue Date: 28th Feb 2007
Page: 128 of 248

TABLE OF RESULTS – 72 MHz Bandwidth 16QAM Modulation

Channel Centre Frequency	Start Frequency (MHz)	Stop Frequency (MHz)	Maximum Emission Observed (dBm)	Limit (dBm)	Plot #	Margin (dB)
2,437	30	2400	-16.33	-8.5	100	-7.83
2,437	2483.5	7000	-33.29	-8.5	101	-24.79
2,437	7000	26000	-26.16	-8.5	102	-17.66

Plot 100
72 MHz Bandwidth 16QAM Modulation
Conducted Spurious Emissions 30 MHz to 2400 MHz

 Marker 1 [T1] RBW 100 kHz RF Att 10 dB
 Ref Lvl -16.33 dBm VBW 300 kHz
 40.4 dBm 2.40000000 GHz SWT 600 ms Unit dBm

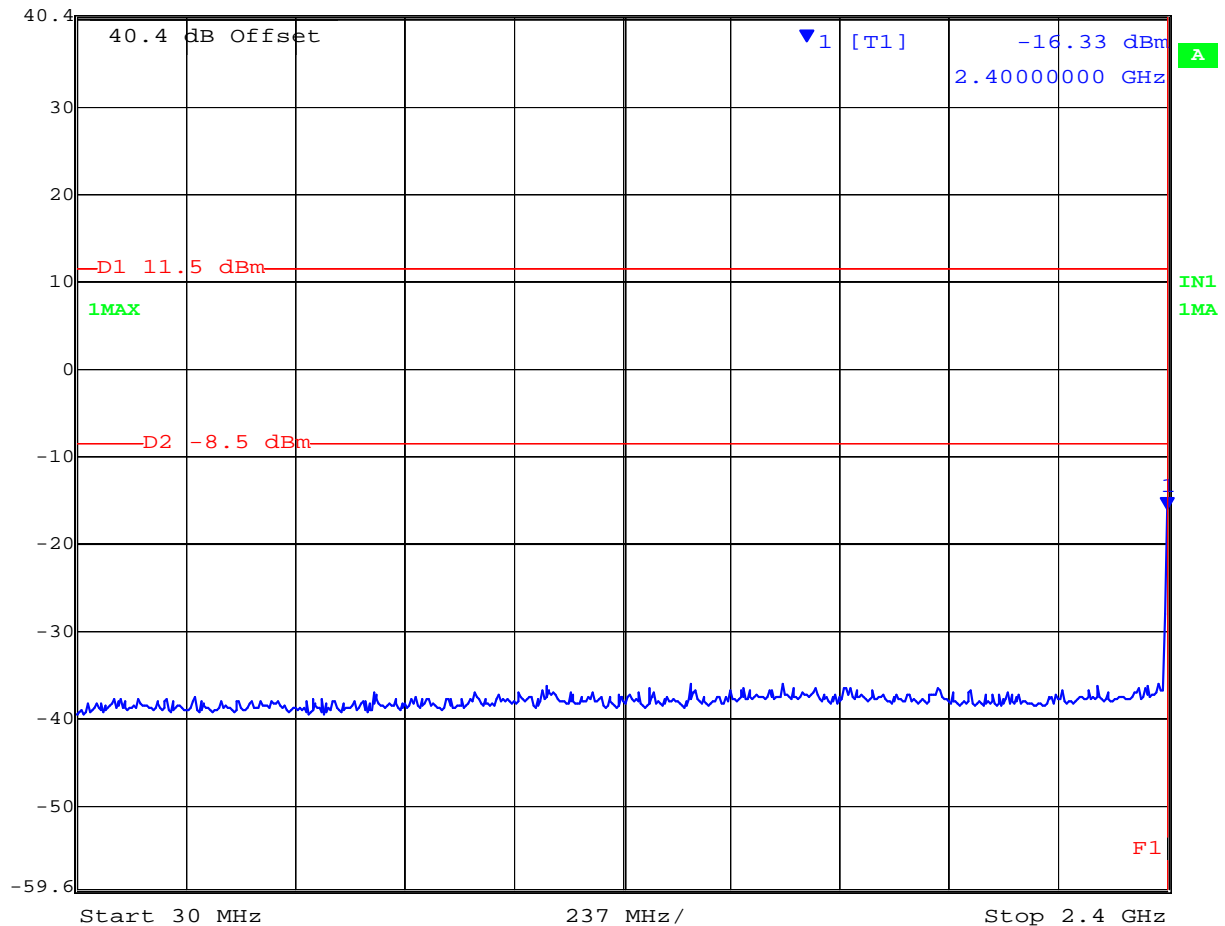

Date: 31.OCT.2005 15:08:09

This test report may be reproduced in full only. The document may only be updated by MiCOM Labs personnel. Any changes will be noted in the Document History section of the report.



Title: Exalt EX-2.4i-16 Fixed Link Radio
To: FCC 47 CFR Part15.247 & IC RSS-210
Serial #: EXLT19-A1 Rev A
Issue Date: 28th Feb 2007
Page: 129 of 248

Plot 101
72 MHz Bandwidth 16QAM Modulation
Conducted Spurious Emissions 2483.5 MHz to 7000 MHz

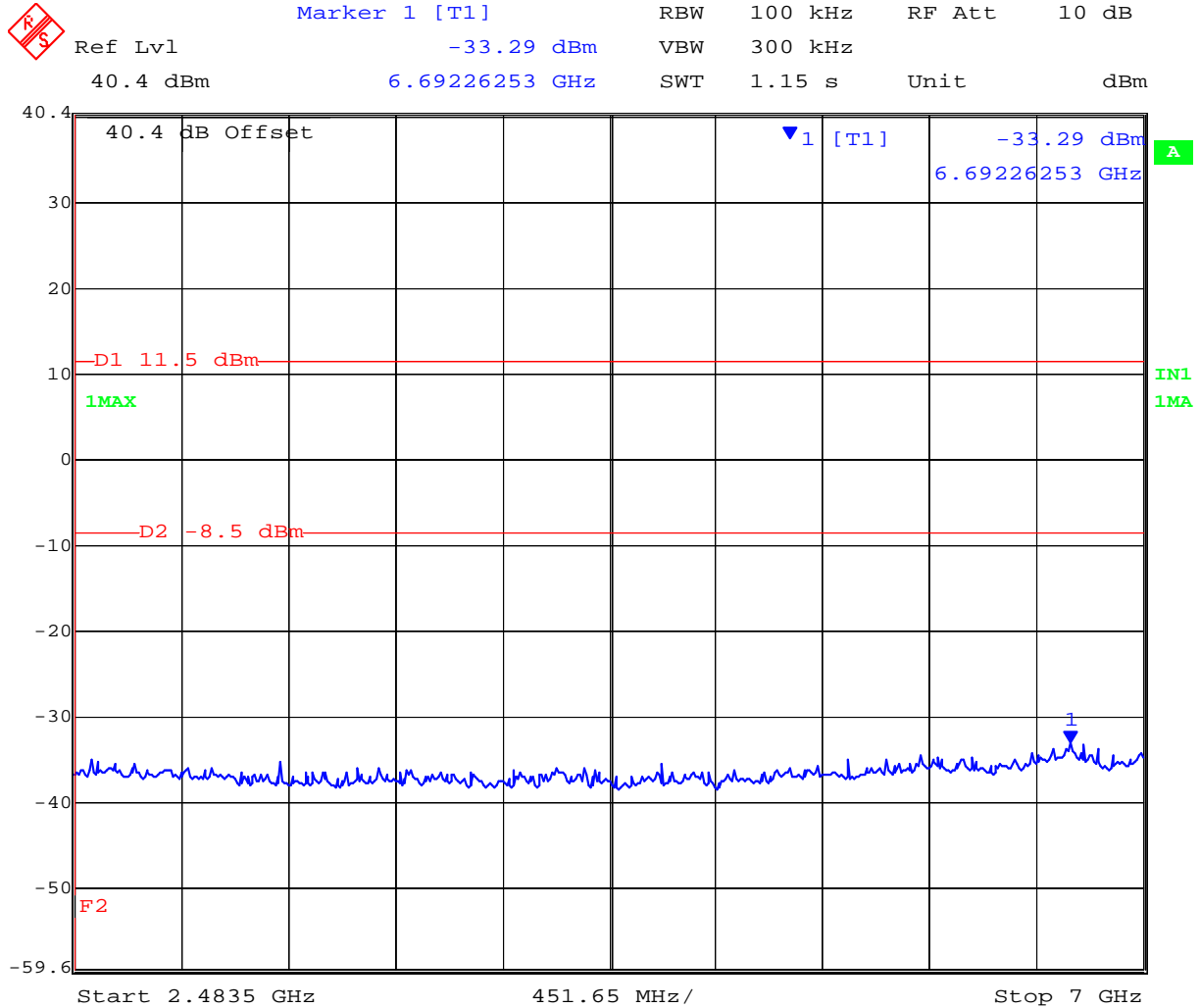

Date: 31.OCT.2005 15:09:07

This test report may be reproduced in full only. The document may only be updated by MiCOM Labs personnel. Any changes will be noted in the Document History section of the report.



Title: Exalt EX-2.4i-16 Fixed Link Radio
To: FCC 47 CFR Part15.247 & IC RSS-210
Serial #: EXLT19-A1 Rev A
Issue Date: 28th Feb 2007
Page: 130 of 248

Plot 102
72 MHz Bandwidth 16QAM Modulation
Conducted Spurious Emissions 7000 MHz to 26000 MHz

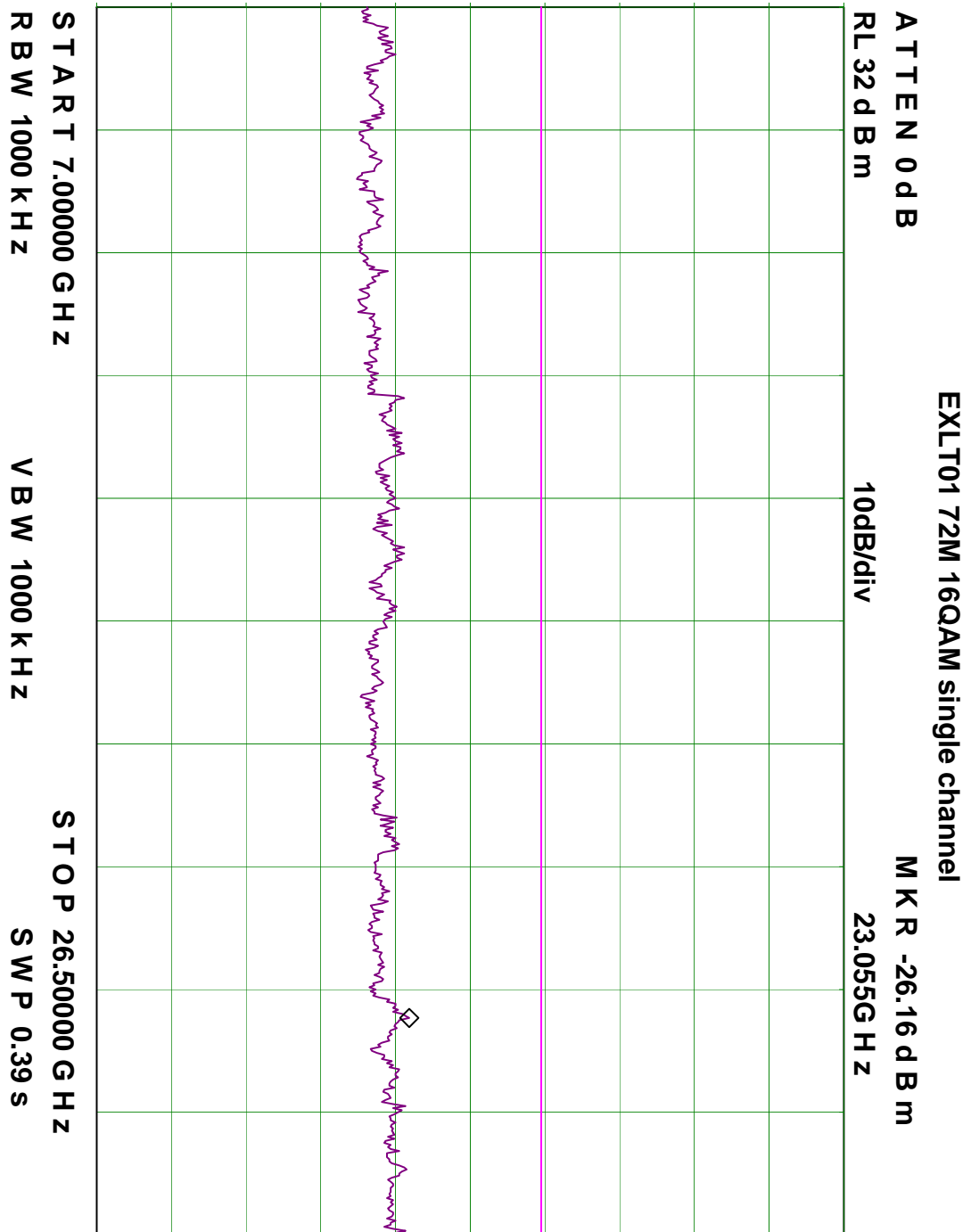

This test report may be reproduced in full only. The document may only be updated by MiCOM Labs personnel. Any changes will be noted in the Document History section of the report.



TABLE OF RESULTS – 72 MHz Bandwidth 64QAM Modulation

Channel Centre Frequency	Start Frequency (MHz)	Stop Frequency (MHz)	Maximum Emission Observed (dBm)	Limit (dBm)	Plot #	Margin (dB)
2,437	30	2400	-15.61	-8.4	103	-7.21
2,437	2483.5	7000	-33.32	-8.4	104	-25.42
2,437	7000	26000	-25.66	-8.4	105	-17.26

Plot 103
72 MHz Bandwidth 64QAM Modulation
Conducted Spurious Emissions 30 MHz to 2400 MHz

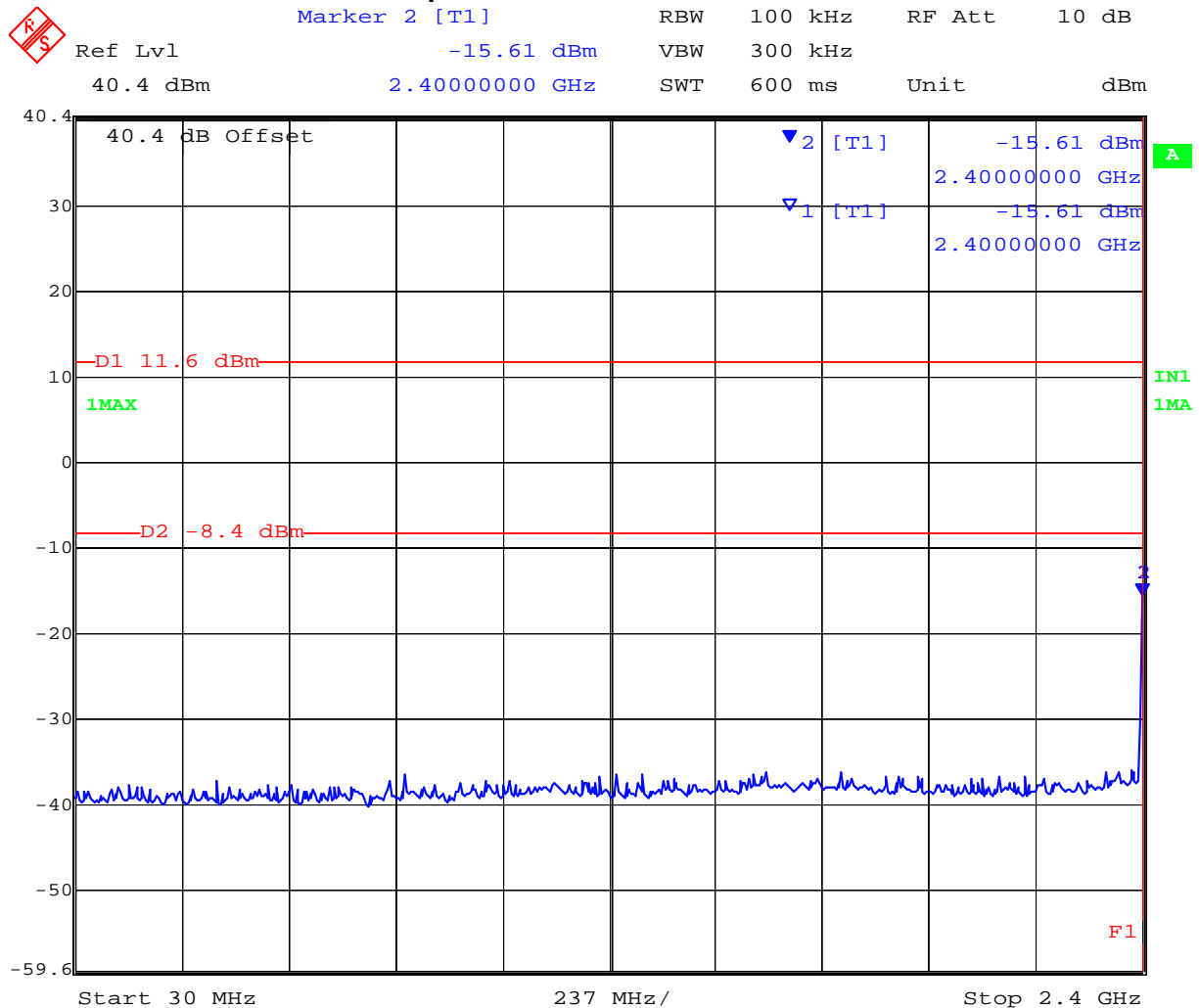

Date: 31.OCT.2005 15:11:22

This test report may be reproduced in full only. The document may only be updated by MiCOM Labs personnel. Any changes will be noted in the Document History section of the report.



Title: Exalt EX-2.4i-16 Fixed Link Radio
To: FCC 47 CFR Part15.247 & IC RSS-210
Serial #: EXLT19-A1 Rev A
Issue Date: 28th Feb 2007
Page: 132 of 248

Plot 104
72 MHz Bandwidth 64QAM Modulation
Conducted Spurious Emissions 2483.5 MHz to 7000 MHz

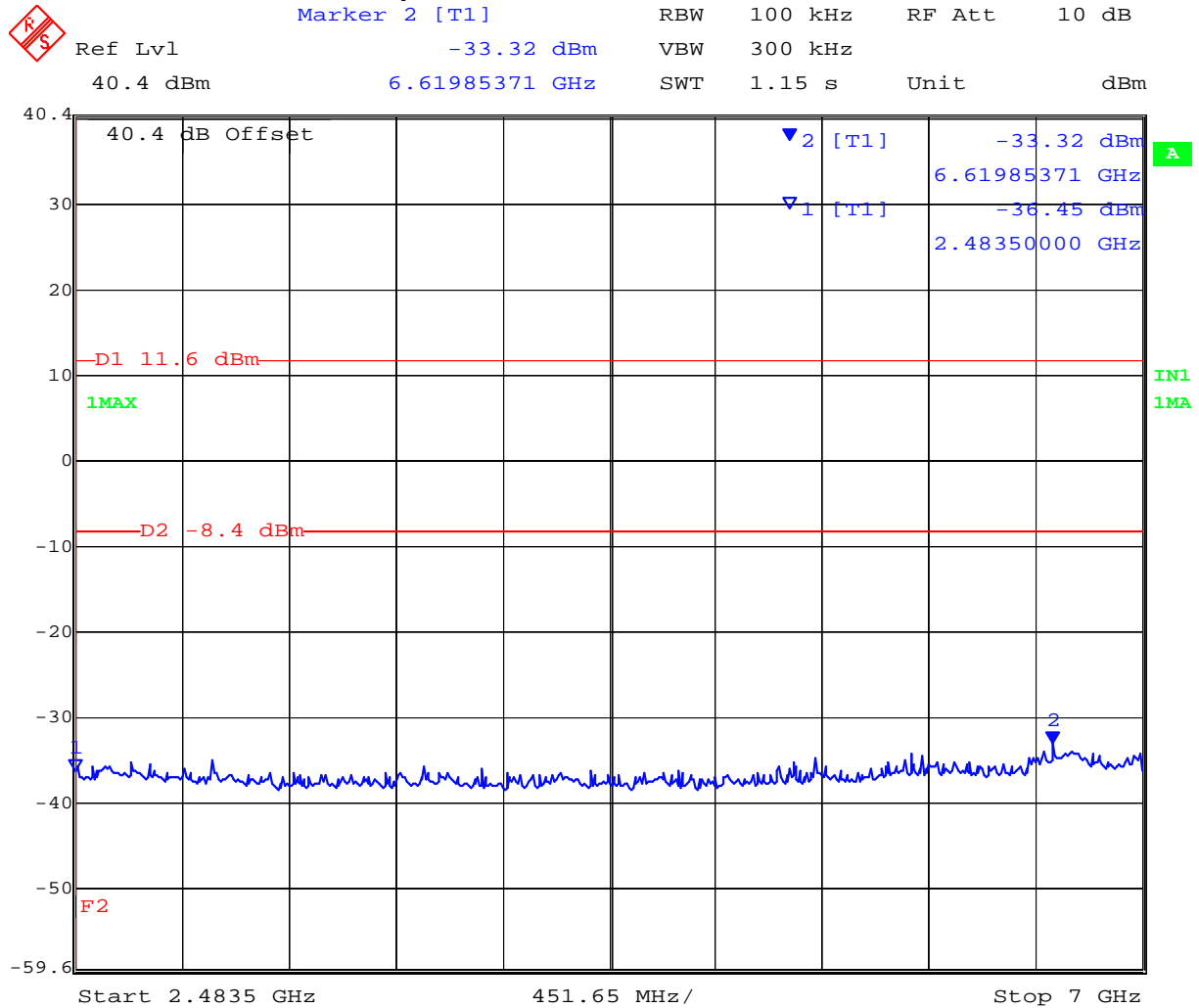

Date: 31.OCT.2005 15:12:31

This test report may be reproduced in full only. The document may only be updated by MiCOM Labs personnel. Any changes will be noted in the Document History section of the report.



Title: Exalt EX-2.4i-16 Fixed Link Radio
To: FCC 47 CFR Part15.247 & IC RSS-210
Serial #: EXLT19-A1 Rev A
Issue Date: 28th Feb 2007
Page: 133 of 248

Plot 105
72 MHz Bandwidth 64QAM Modulation
Conducted Spurious Emissions 7000 MHz to 26000 MHz

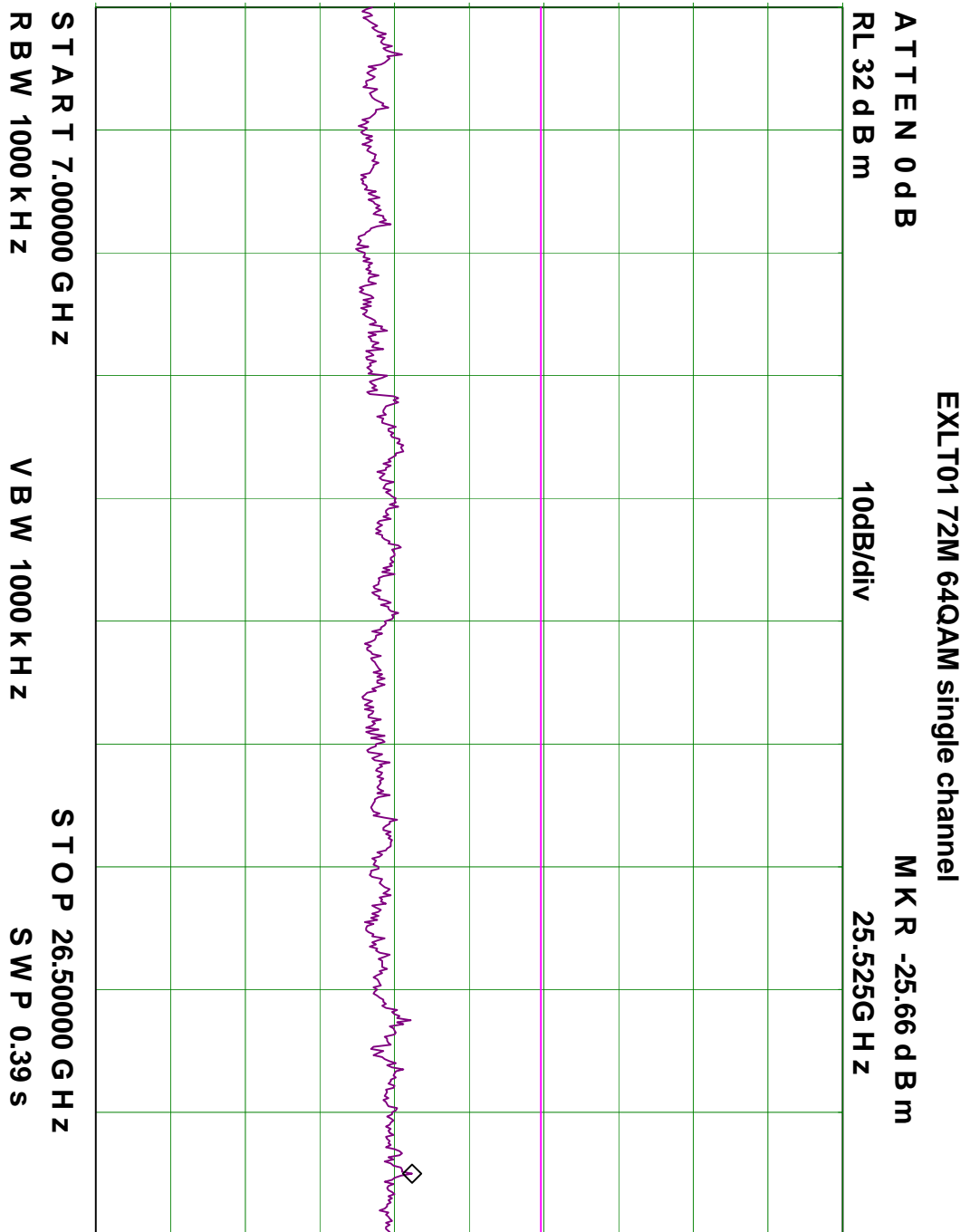

This test report may be reproduced in full only. The document may only be updated by MiCOM Labs personnel. Any changes will be noted in the Document History section of the report.



Title: Exalt EX-2.4i-16 Fixed Link Radio
To: FCC 47 CFR Part15.247 & IC RSS-210
Serial #: EXLT19-A1 Rev A
Issue Date: 28th Feb 2007
Page: 134 of 248

Specification

Limits Band-Edge

Lower Limit Band-edge	Upper Limit Band-edge	Limit below highest level of desired power
2,400 MHz	2,483.5 MHz	≥ 20 dB

§15.247(c) In any 100 kHz bandwidth outside the frequency band in which the spread spectrum intentional radiator is operating, the radio frequency power that is produced by the intentional radiator shall be at least 20 dB below that in the 100 kHz bandwidth within the band that contains the highest level of the desired power, based on either an RF conducted or radiated measurement. Attenuation below the general limits specified in **§15.209(a)** is not required.

IC RSS-210 § A8.5 In any 100 kHz bandwidth outside the operating frequency band in which the spread spectrum or digitally modulated device is operating, the radio frequency power that is produced shall be at least 20 dB below that in the 100 kHz bandwidth within the band that contains the highest level of the desired power.

IC RSS-Gen § 4.7 The search for unwanted emissions shall be from the lowest frequency internally generated or used in the device, or from 30 MHz, whichever is the lowest frequency, to the 5th harmonic of the highest frequency generated without exceeding 40 GHz.

Laboratory Measurement Uncertainty for Conducted Spurious Emissions

Measurement uncertainty	±2.37 dB
-------------------------	----------

Traceability

Method	Test Equipment Used
Measurements were made per work instruction WI-05 'Measurement of Spurious Emissions'	0158, 0088, 0193, 0252, 0314

This test report may be reproduced in full only. The document may only be updated by MiCOM Labs personnel. Any changes will be noted in the Document History section of the report.

5.1.6. Radiated Emissions

5.1.6.1. Transmitter Radiated Spurious Emissions (above 1 GHz)

FCC, Part 15 Subpart C §15.247(c), §15.205(a), §15.209(a)
Industry Canada RSS-Gen §4.7, RSS-210 §2.2, §2.6

Test Procedure

Radiated emissions above 1 GHz are measured in the anechoic chamber at a 3-meter distance on every azimuth in both horizontal and vertical polarities. The emissions are recorded and maximized as a function of azimuth by rotation through 360° with a spectrum analyzer in peak hold mode. Depending on the frequency band spanned a notch filter and waveguide filter was used to remove the fundamental frequency. The highest emissions relative to the limit are listed for each frequency spanned.

All measurements on any frequency or frequencies over 1 MHz are based on the use of measurement instrumentation employing an average detector function. All measurements above 1 GHz were performed using a minimum resolution bandwidth of 1 MHz.

Peak power at EUT was measured in Section 5.1.2 'Peak Output Power'

Peak Power delivered to 21.3 dBi antenna: +24.9 dBm

Test Measurement Set up

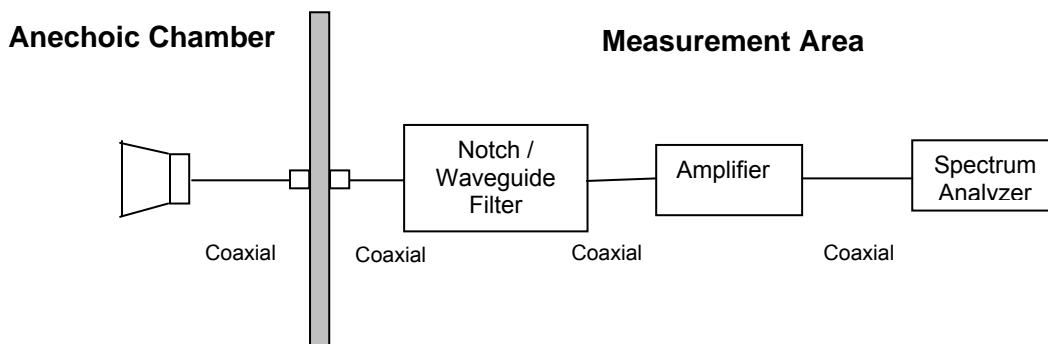

Measurement set up for Radiated Emission Test



Title: Exalt EX-2.4i-16 Fixed Link Radio
To: FCC 47 CFR Part15.247 & IC RSS-210
Serial #: EXLT19-A1 Rev A
Issue Date: 28th Feb 2007
Page: 136 of 248

Field Strength Calculation

The field strength is calculated by adding the Antenna Factor and Cable Loss, and subtracting Amplifier Gain from the measured reading. All factors are included in the reported data.

$$FS = R + AF + CORR - FO$$

where: FS = Field Strength

R = Measured Spectrum analyzer Input Amplitude

AF = Antenna Factor

CORR = Correction Factor = CL – AG + NFL

CL = Cable Loss

AG = Amplifier Gain

FO = Distance Falloff Factor

NFL = Notch Filter Loss or Waveguide Loss

This test report may be reproduced in full only. The document may only be updated by MiCOM Labs personnel. Any changes will be noted in the Document History section of the report.



Title: Exalt EX-2.4i-16 Fixed Link Radio
To: FCC 47 CFR Part15.247 & IC RSS-210
Serial #: EXLT19-A1 Rev A
Issue Date: 28th Feb 2007
Page: 137 of 248

For example:

Given receiver input reading of 51.5 dB μ V; Antenna Factor of 8.5 dB; Cable Loss of 1.3 dB; Falloff Factor of 0 dB, an Amplifier Gain of 26 dB and Notch Filter Loss of 1 dB. The Field Strength of the measured emission is:

$$FS = 51.5 + 8.5 + 1.3 - 26.0 + 1 = 36.3 \text{ dB}\mu\text{V/m}$$

Conversion between dB μ V/m (or dB μ V) and μ V/m (or μ V) are done as:

$$\text{Level (dB}\mu\text{V/m)} = 20 * \text{Log (level (\mu\text{V/m}))}$$

$$40 \text{ dB}\mu\text{V/m} = 100 \mu\text{V/m}$$

$$48 \text{ dB}\mu\text{V/m} = 250 \mu\text{V/m}$$

Measurement Results Transmitter Radiated Spurious Emissions above 1 GHz

Antenna Configuration
21.3 dBi Parabolic
30.3 dBi Parabolic
20 dBi Panel

Ambient conditions.

Temperature: 19 to 26°C

Relative humidity: 31 to 57 %

Pressure: 999 to 1009 mbar

This test report may be reproduced in full only. The document may only be updated by MiCOM Labs personnel. Any changes will be noted in the Document History section of the report.



21.3 dBi Parabolic

TABLE OF RESULTS – 9 MHz Bandwidth QPSK Modulation

CH.	Freq. (MHz)	Pol. (H/V)	Raw Reading (dB μ V/m)	Correction Factor (dB)	Corrected Field Strength (dB μ V/m)	Limit (dB μ V/m)	Margin (dB)
2,468			Note			54.00	

Note. The peak emission shown in the graph below is fundamental breaking through the notch filter. No other emissions were observed above the limit line.

Worst case plot shown for 9 MHz Bandwidth QPSK Modulation. All other results for this bandwidth and modulation are held on file.

Plot 106

2,468 MHz Radiated Spurious Emissions > 1GHz

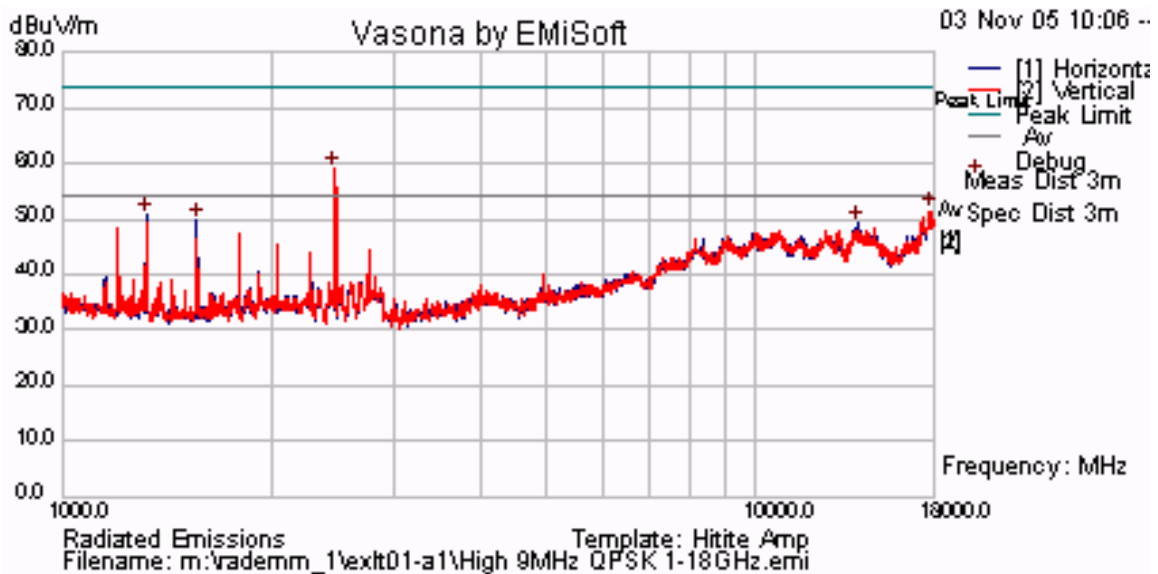

This test report may be reproduced in full only. The document may only be updated by MiCOM Labs personnel. Any changes will be noted in the Document History section of the report.



21.3 dBi Parabolic

TABLE OF RESULTS –9 MHz Bandwidth 16QAM Modulation

CH.	Freq. (MHz)	Pol. (H/V)	Raw Reading (dB μ V/m)	Correction Factor (dB)	Corrected Field Strength (dB μ V/m)	Limit (dB μ V/m)	Margin (dB)
2,468			Note			54.00	

Note. The peak emission shown in the graph below is fundamental breaking through the notch filter. No other emissions were observed above the limit line.

Worst case plot shown for 9 MHz Bandwidth 16QAM Modulation. All other results for this bandwidth and modulation are held on file.

Plot 107

2,468 MHz Radiated Spurious Emissions > 1GHz

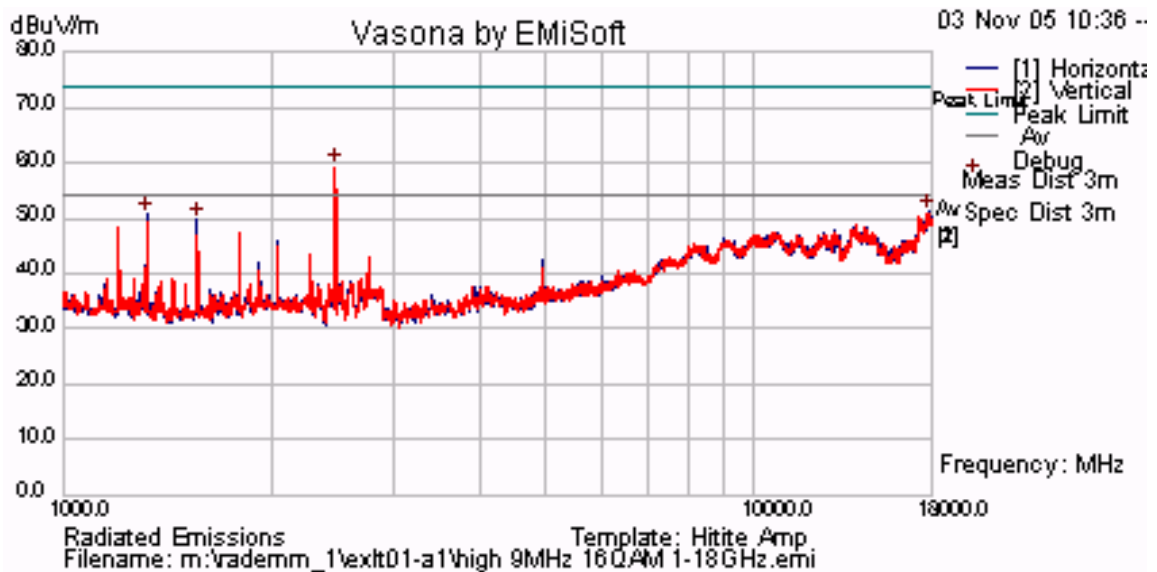

This test report may be reproduced in full only. The document may only be updated by MiCOM Labs personnel. Any changes will be noted in the Document History section of the report.



21.3 dBi Parabolic

TABLE OF RESULTS– 9 MHz Bandwidth 64QAM Modulation

CH.	Freq. (MHz)	Pol. (H/V)	Raw Reading (dB μ V/m)	Correction Factor (dB)	Corrected Field Strength (dB μ V/m)	Limit (dB μ V/m)	Margin (dB)
2,468			Note			54.00	

Note. The peak emission shown in the graph below is fundamental breaking through the notch filter. No other emissions were observed above the limit line.

Worst case plot shown for 9 MHz Bandwidth 64QAM Modulation. All other results for this bandwidth and modulation are held on file.

Plot 108

2,468 MHz Radiated Spurious Emissions > 1GHz

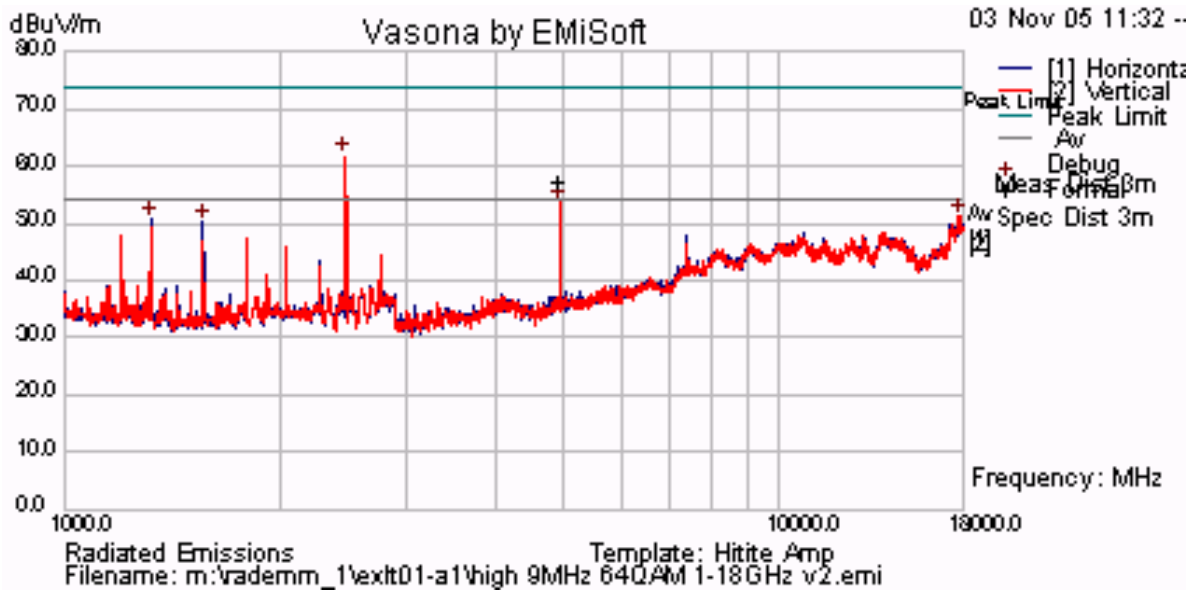

This test report may be reproduced in full only. The document may only be updated by MiCOM Labs personnel. Any changes will be noted in the Document History section of the report.



21.3 dBi Parabolic

TABLE OF RESULTS – 18 MHz Bandwidth QPSK Modulation

CH.	Freq. (MHz)	Pol. (H/V)	Raw Reading (dB μ V/m)	Correction Factor (dB)	Corrected Field Strength (dB μ V/m)	Limit (dB μ V/m)	Margin (dB)
2,465			Note			54.00	

Note. The peak emission shown in the graph below is fundamental breaking through the notch filter. No other emissions were observed above the limit line.

Worst case plot shown for 18 MHz Bandwidth QPSK Modulation. All other results for this bandwidth and modulation are held on file.

Plot 109

2,465 MHz Radiated Spurious Emissions > 1GHz

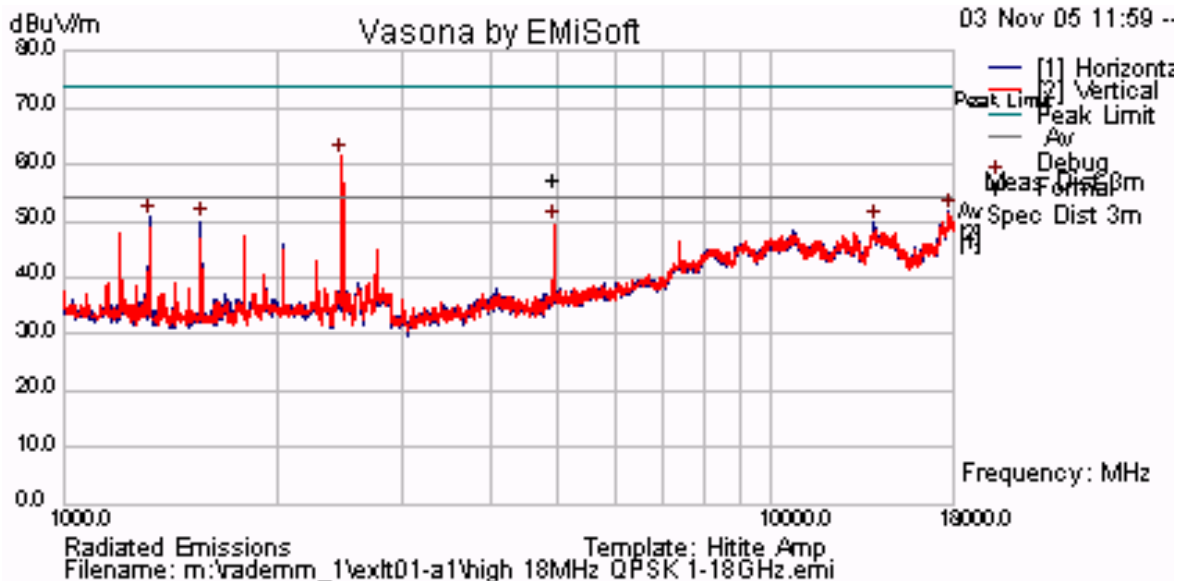

This test report may be reproduced in full only. The document may only be updated by MiCOM Labs personnel. Any changes will be noted in the Document History section of the report.



21.3 dBi Parabolic

TABLE OF RESULTS – 18 MHz Bandwidth 16QAM Modulation

CH.	Freq. (MHz)	Pol. (H/V)	Raw Reading (dBμV/m)	Correction Factor (dB)	Corrected Field Strength (dBμV/m)	Limit (dBμV/m)	Margin (dB)
2,417			Note			54.00	

Note. The peak emission shown in the graph below is fundamental breaking through the notch filter. No other emissions were observed above the limit line.

Worst case plot shown for 18 MHz Bandwidth 16QAM Modulation. All other results for this bandwidth and modulation are held on file.

Plot 110

2,417 MHz Radiated Spurious Emissions > 1GHz

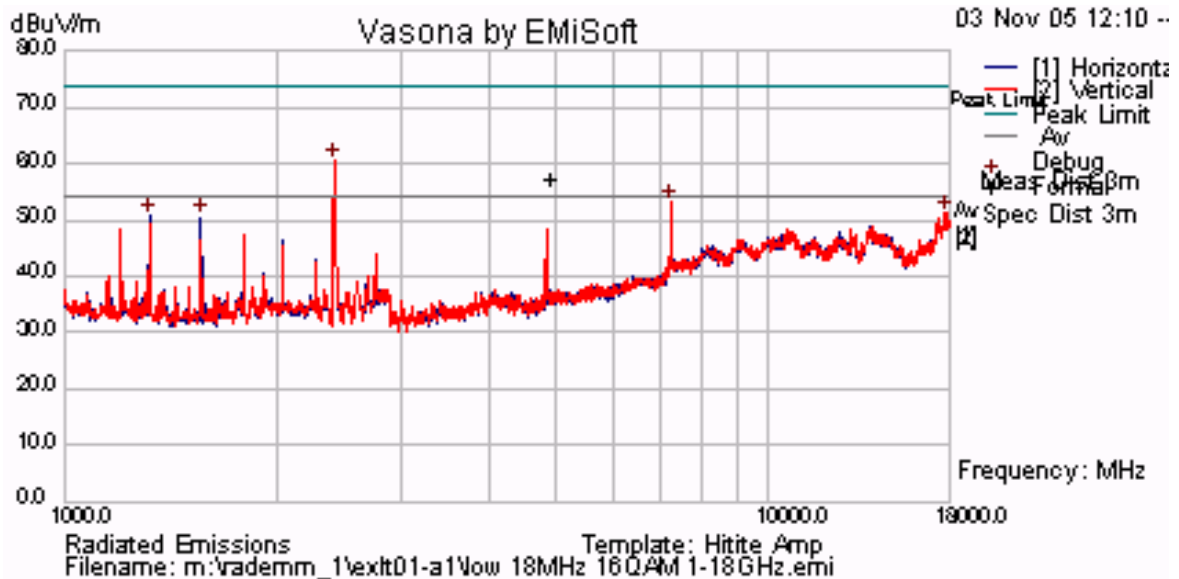

This test report may be reproduced in full only. The document may only be updated by MiCOM Labs personnel. Any changes will be noted in the Document History section of the report.



21.3 dBi Parabolic
TABLE OF RESULTS – 18 MHz Bandwidth 64QAM Modulation

CH.	Freq. (MHz)	Pol. (H/V)	Raw Reading (dB μ V/m)	Correction Factor (dB)	Corrected Field Strength (dB μ V/m)	Limit (dB μ V/m)	Margin (dB)
2,465			Note			54.00	

Note. The peak emission shown in the graph below is fundamental breaking through the notch filter. No other emissions were observed above the limit line.

Worst case plot shown for 18 MHz Bandwidth 64QAM Modulation. All other results for this bandwidth and modulation are held on file.

Plot 111

2,465 MHz Radiated Spurious Emissions > 1GHz

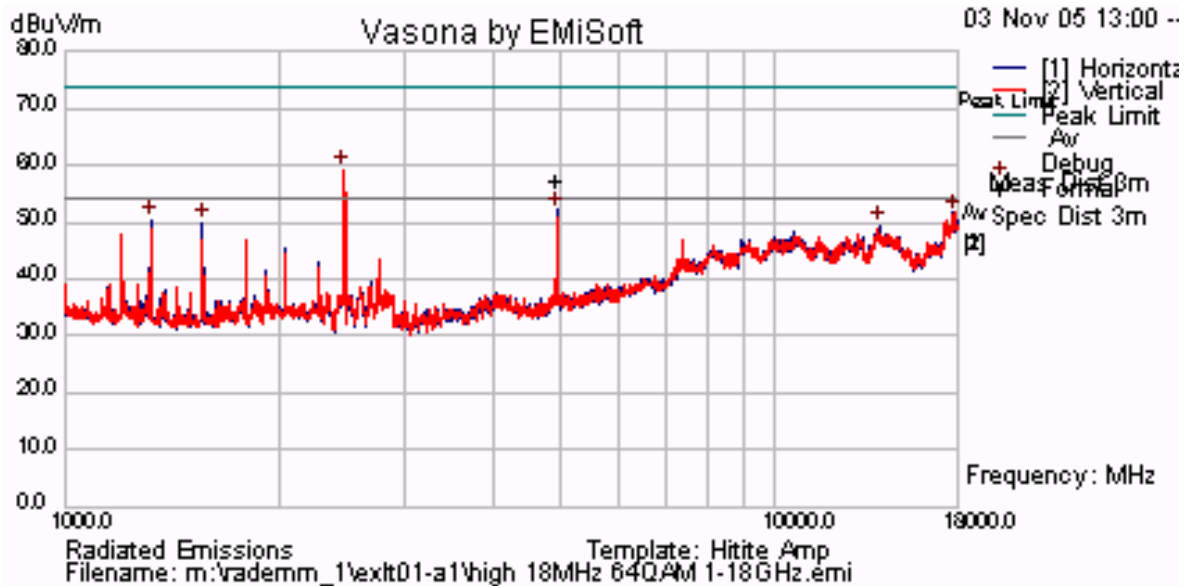

This test report may be reproduced in full only. The document may only be updated by MiCOM Labs personnel. Any changes will be noted in the Document History section of the report.



21.3 dBi Parabolic

TABLE OF RESULTS – 36 MHz Bandwidth QPSK Modulation

CH.	Freq. (MHz)	Pol. (H/V)	Raw Reading (dB μ V/m)	Correction Factor (dB)	Corrected Field Strength (dB μ V/m)	Limit (dB μ V/m)	Margin (dB)
2,426			Note			54.00	

Note. The peak emission shown in the graph below is fundamental breaking through the notch filter. No other emissions were observed above the limit line.

Worst case plot shown for 36 MHz Bandwidth QPSK Modulation. All other results for this bandwidth and modulation are held on file.

Plot 112

2,426 MHz Radiated Spurious Emissions > 1GHz

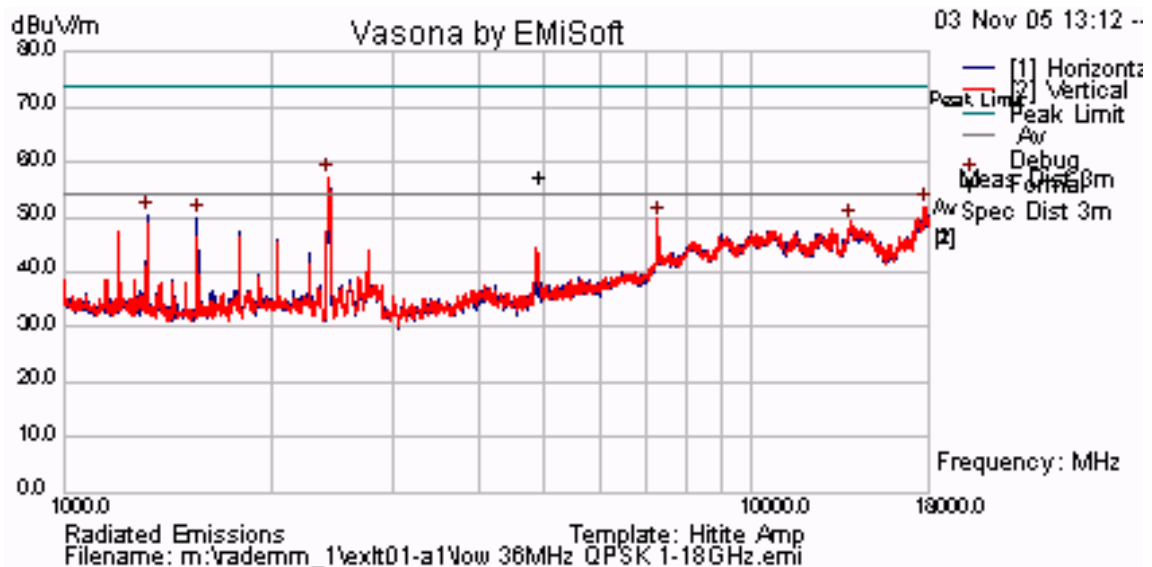

This test report may be reproduced in full only. The document may only be updated by MiCOM Labs personnel. Any changes will be noted in the Document History section of the report.



21.3 dBi Parabolic

TABLE OF RESULTS – 36 MHz Bandwidth 16QAM Modulation

CH.	Freq. (MHz)	Pol. (H/V)	Raw Reading (dB μ V/m)	Correction Factor (dB)	Corrected Field Strength (dB μ V/m)	Limit (dB μ V/m)	Margin (dB)
2,426			Note			54.00	

Note. The peak emission shown in the graph below is fundamental breaking through the notch filter. No other emissions were observed above the limit line.

Worst case plot shown for 36 MHz Bandwidth 16QAM Modulation. All other results for this bandwidth and modulation are held on file.

Plot 113

2,426 MHz Radiated Spurious Emissions > 1GHz

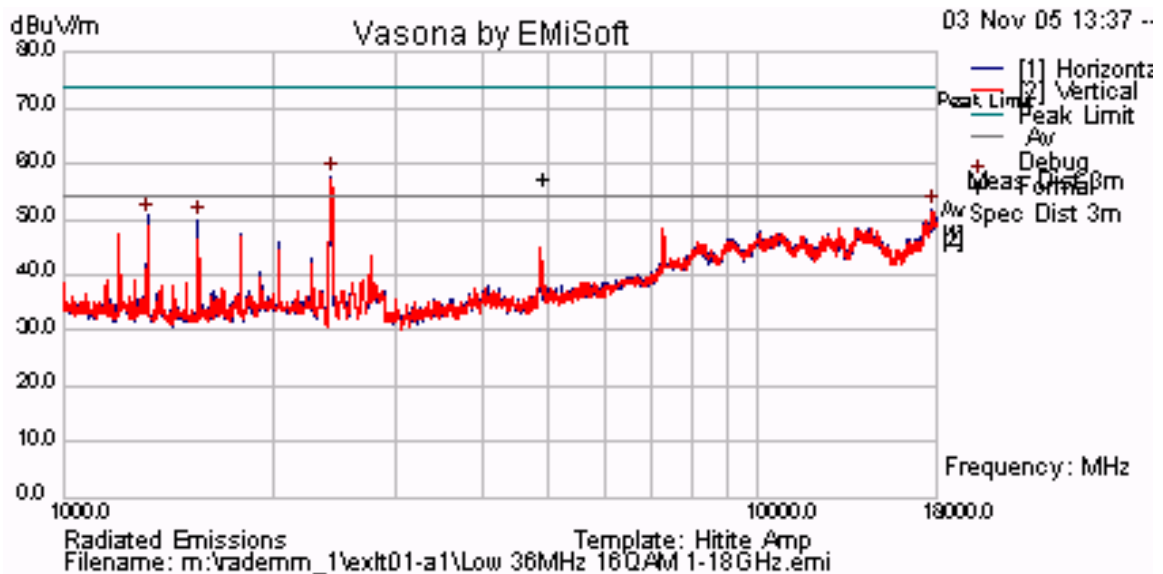

This test report may be reproduced in full only. The document may only be updated by MiCOM Labs personnel. Any changes will be noted in the Document History section of the report.



Title: Exalt EX-2.4i-16 Fixed Link Radio
To: FCC 47 CFR Part15.247 & IC RSS-210
Serial #: EXLT19-A1 Rev A
Issue Date: 28th Feb 2007
Page: 146 of 248

21.3 dBi Parabolic

TABLE OF RESULTS – 36 MHz Bandwidth 64QAM Modulation

CH.	Freq. (MHz)	Pol. (H/V)	Raw Reading (dB μ V/m)	Correction Factor (dB)	Corrected Field Strength (dB μ V/m)	Limit (dB μ V/m)	Margin (dB)
2,437			Note			54.00	

Note. The peak emission shown in the graph below is fundamental breaking through the notch filter. No other emissions were observed above the limit line.

Worst case plot shown for 36 MHz Bandwidth 64QAM Modulation. All other results for this bandwidth and modulation are held on file.

Plot 114

2,437 MHz Radiated Spurious Emissions > 1GHz

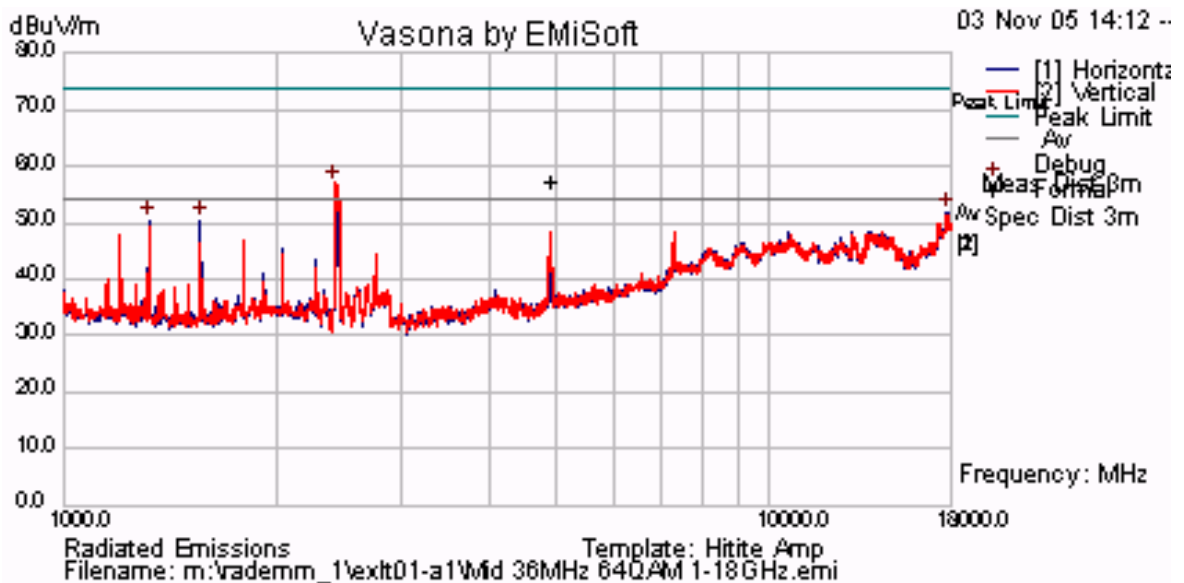

This test report may be reproduced in full only. The document may only be updated by MiCOM Labs personnel. Any changes will be noted in the Document History section of the report.



21.3 dBi Parabolic

TABLE OF RESULTS – 72 MHz Bandwidth QPSK Modulation

CH.	Freq. (MHz)	Pol. (H/V)	Raw Reading (dBμV/m)	Correction Factor (dB)	Corrected Field Strength (dBμV/m)	Limit (dBμV/m)	Margin (dB)
2,437			Note			54.00	

Note. The peak emission shown in the graph below is fundamental breaking through the notch filter. No other emissions were observed above the limit line.

Worst case plot shown for 72 MHz Bandwidth QPSK Modulation. All other results for this bandwidth and modulation are held on file.

Plot 115

2,437 MHz Radiated Spurious Emissions > 1GHz

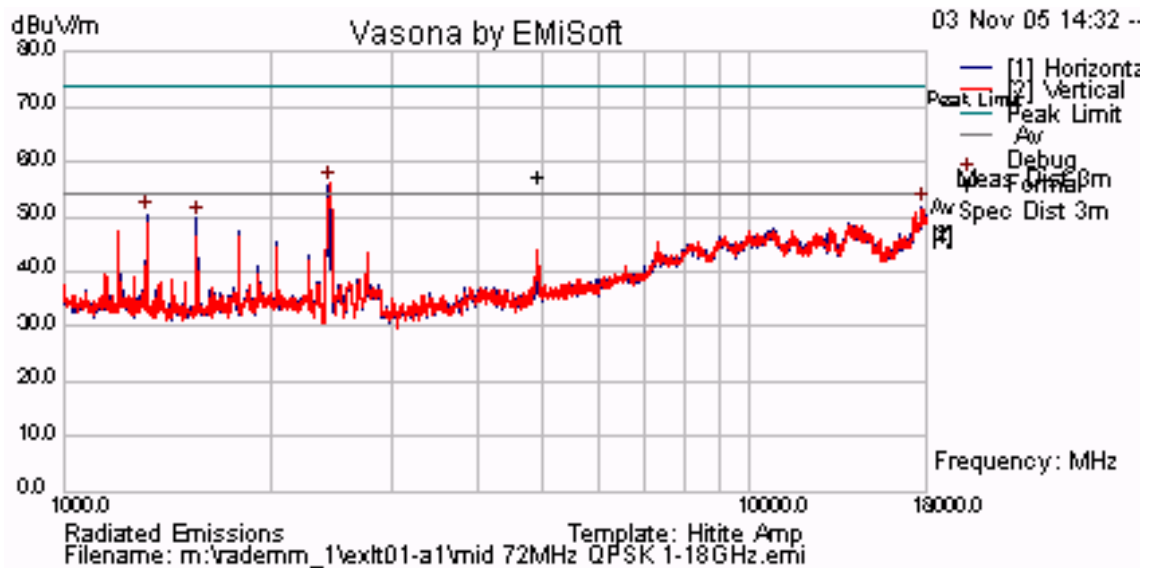

This test report may be reproduced in full only. The document may only be updated by MiCOM Labs personnel. Any changes will be noted in the Document History section of the report.



21.3 dBi Parabolic

TABLE OF RESULTS– 72 MHz Bandwidth 16QAM Modulation

CH.	Freq. (MHz)	Pol. (H/V)	Raw Reading (dBμV/m)	Correction Factor (dB)	Corrected Field Strength (dBμV/m)	Limit (dBμV/m)	Margin (dB)
2,437			Note			54.00	

Note. The peak emission shown in the graph below is fundamental breaking through the notch filter. No other emissions were observed above the limit line.

Worst case plot shown for 72 MHz Bandwidth 16QAM Modulation. All other results for this bandwidth and modulation are held on file.

Plot 116

2,437 MHz Radiated Spurious Emissions > 1GHz

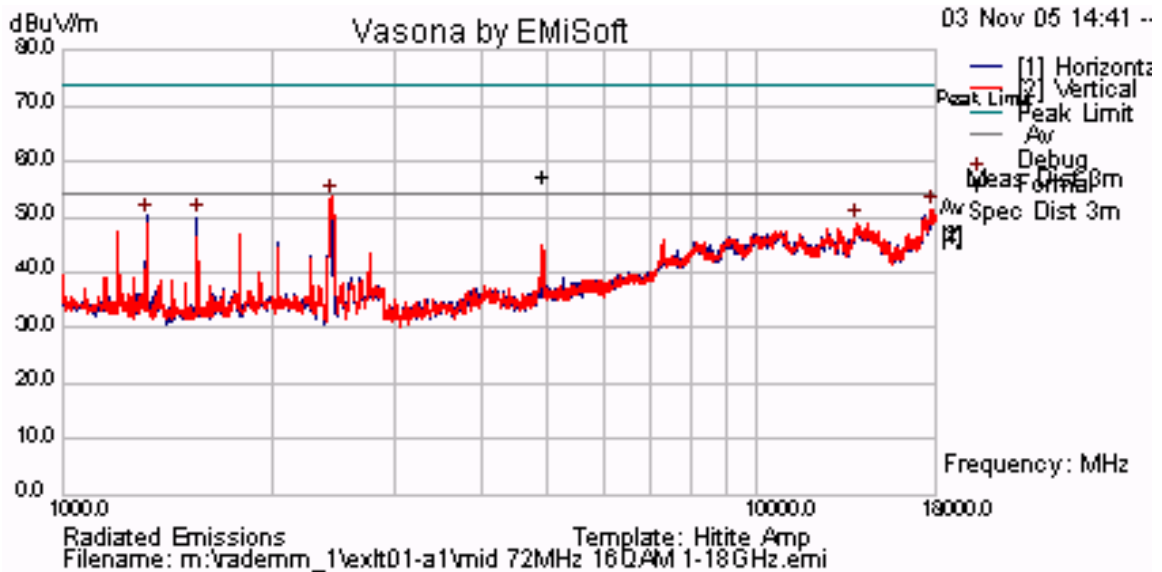

This test report may be reproduced in full only. The document may only be updated by MiCOM Labs personnel. Any changes will be noted in the Document History section of the report.



21.3 dBi Parabolic

TABLE OF RESULTS – 72 MHz Bandwidth 64QAM Modulation

CH.	Freq. (MHz)	Pol. (H/V)	Raw Reading (dB μ V/m)	Correction Factor (dB)	Corrected Field Strength (dB μ V/m)	Limit (dB μ V/m)	Margin (dB)
2,437			Note			54.00	

Note. The peak emission shown in the graph below is fundamental breaking through the notch filter. No other emissions were observed above the limit line.

Worst case plot shown for 72 MHz Bandwidth 64QAM Modulation. All other results for this bandwidth and modulation are held on file.

Plot 117

2,437 MHz Radiated Spurious Emissions > 1GHz

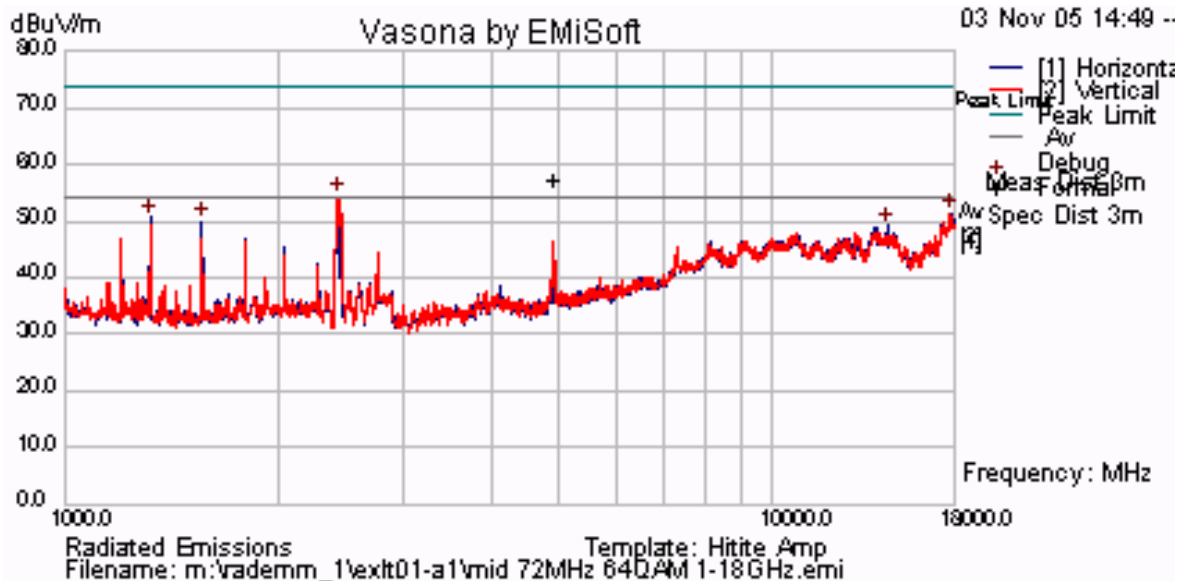

This test report may be reproduced in full only. The document may only be updated by MiCOM Labs personnel. Any changes will be noted in the Document History section of the report.



30.3 dBi Parabolic

TABLE OF RESULTS – 9 MHz Bandwidth QPSK Modulation

CH.	Freq. (MHz)	Pol. (H/V)	Raw Reading (dB μ V/m)	Correction Factor (dB)	Corrected Field Strength (dB μ V/m)	Limit (dB μ V/m)	Margin (dB)
2,468			Note			54.00	

Note. The peak emission shown in the graph below is fundamental breaking through the notch filter. No other emissions were observed above the limit line.

Worst case plot shown for 9 MHz Bandwidth QPSK Modulation. All other results for this bandwidth and modulation are held on file.

Plot 118

2,468 MHz Radiated Spurious Emissions > 1GHz

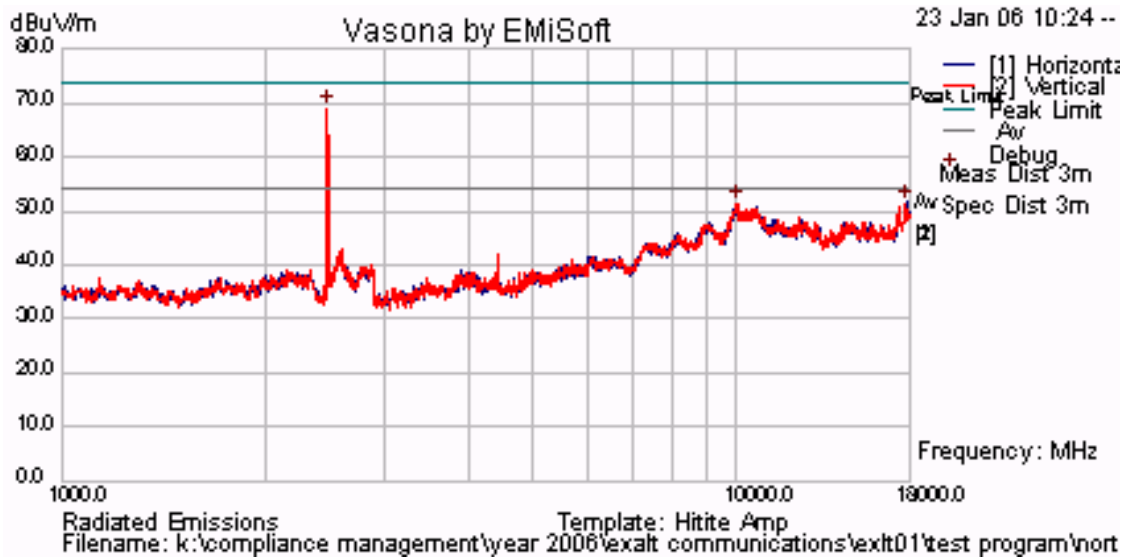

This test report may be reproduced in full only. The document may only be updated by MiCOM Labs personnel. Any changes will be noted in the Document History section of the report.



Title: Exalt EX-2.4i-16 Fixed Link Radio
To: FCC 47 CFR Part15.247 & IC RSS-210
Serial #: EXLT19-A1 Rev A
Issue Date: 28th Feb 2007
Page: 151 of 248

30.3 dBi Parabolic

TABLE OF RESULTS –9 MHz Bandwidth 16QAM Modulation

CH.	Freq. (MHz)	Pol. (H/V)	Raw Reading (dB μ V/m)	Correction Factor (dB)	Corrected Field Strength (dB μ V/m)	Limit (dB μ V/m)	Margin (dB)
2,468			Note			54.00	

Note. The peak emission shown in the graph below is fundamental breaking through the notch filter. No other emissions were observed above the limit line.

Worst case plot shown for 9 MHz Bandwidth 16QAM Modulation. All other results for this bandwidth and modulation are held on file.

Plot 119

2,468 MHz Radiated Spurious Emissions > 1GHz

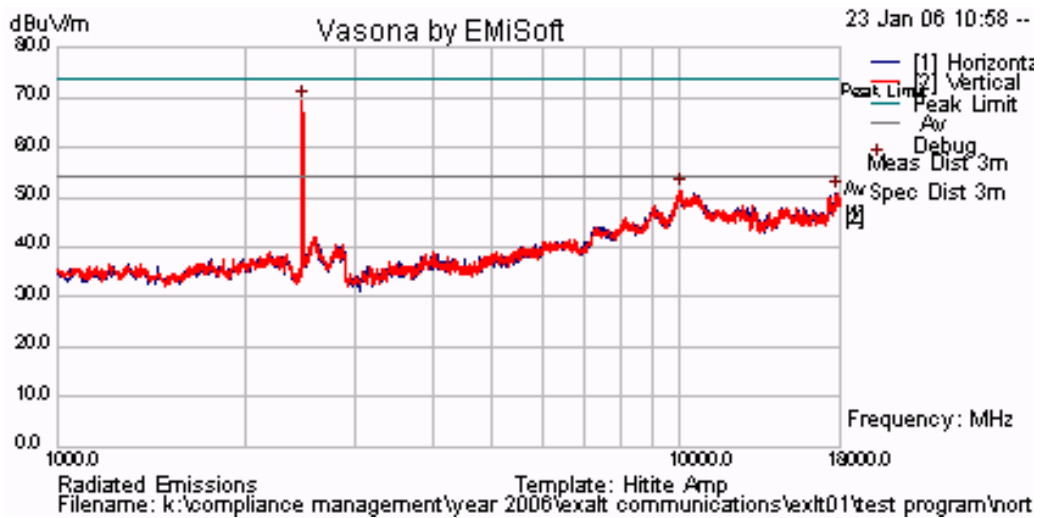

This test report may be reproduced in full only. The document may only be updated by MiCOM Labs personnel. Any changes will be noted in the Document History section of the report.



Title: Exalt EX-2.4i-16 Fixed Link Radio
To: FCC 47 CFR Part15.247 & IC RSS-210
Serial #: EXLT19-A1 Rev A
Issue Date: 28th Feb 2007
Page: 152 of 248

30.3 dBi Parabolic

TABLE OF RESULTS– 9 MHz Bandwidth 64QAM Modulation

CH.	Freq. (MHz)	Pol. (H/V)	Raw Reading (dB μ V/m)	Correction Factor (dB)	Corrected Field Strength (dB μ V/m)	Limit (dB μ V/m)	Margin (dB)
2,468			Note			54.00	

Note. The peak emission shown in the graph below is fundamental breaking through the notch filter. No other emissions were observed above the limit line.

Worst case plot shown for 9 MHz Bandwidth 64QAM Modulation. All other results for this bandwidth and modulation are held on file.

Plot 120

2,468 MHz Radiated Spurious Emissions > 1GHz

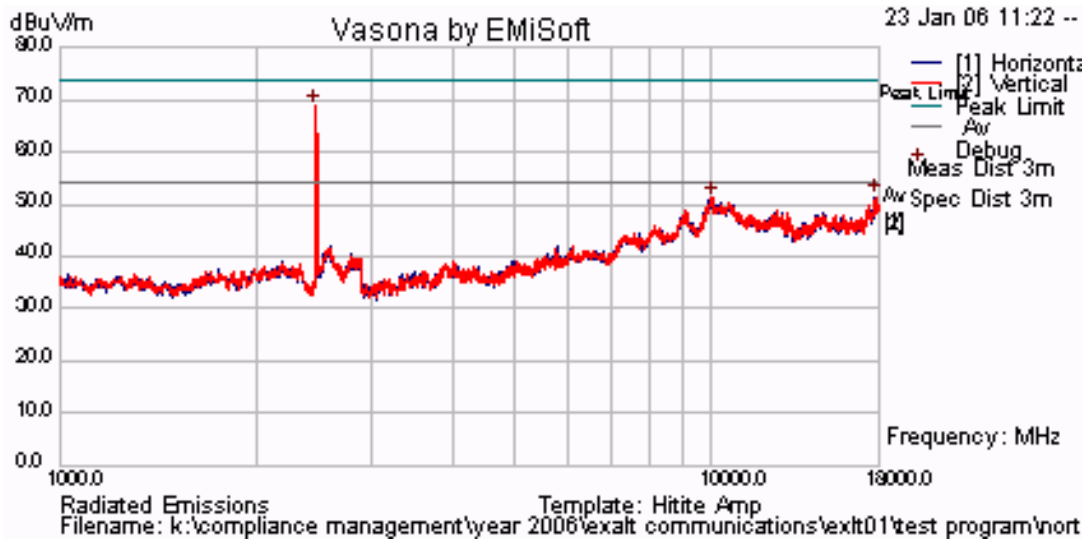

This test report may be reproduced in full only. The document may only be updated by MiCOM Labs personnel. Any changes will be noted in the Document History section of the report.



30.3 dBi Parabolic

TABLE OF RESULTS – 18 MHz Bandwidth QPSK Modulation

CH.	Freq. (MHz)	Pol. (H/V)	Raw Reading (dBµV/m)	Correction Factor (dB)	Corrected Field Strength (dBµV/m)	Limit (dBµV/m)	Margin (dB)
2,465			Note			54.00	

Note. The peak emission shown in the graph below is fundamental breaking through the notch filter. No other emissions were observed above the limit line.

Worst case plot shown for 18 MHz Bandwidth QPSK Modulation. All other results for this bandwidth and modulation are held on file.

Plot 121

2,465 MHz Radiated Spurious Emissions > 1GHz

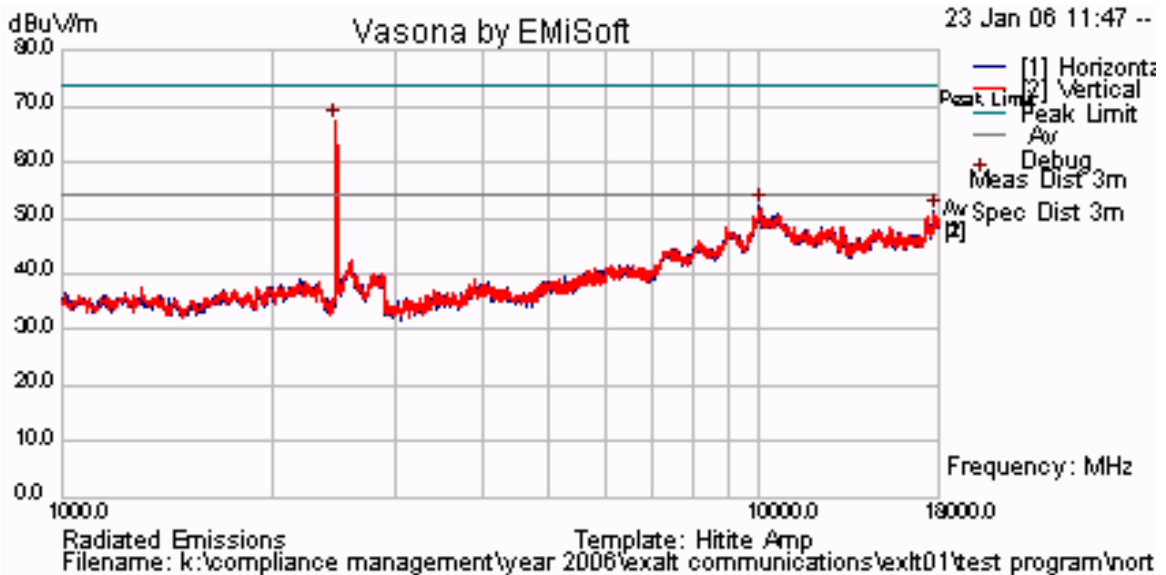

This test report may be reproduced in full only. The document may only be updated by MiCOM Labs personnel. Any changes will be noted in the Document History section of the report.



30.3 dBi Parabolic

TABLE OF RESULTS – 18 MHz Bandwidth 16QAM Modulation

CH.	Freq. (MHz)	Pol. (H/V)	Raw Reading (dB μ V/m)	Correction Factor (dB)	Corrected Field Strength (dB μ V/m)	Limit (dB μ V/m)	Margin (dB)
2,417			Note			54.00	

Note. The peak emission shown in the graph below is fundamental breaking through the notch filter. No other emissions were observed above the limit line.

Worst case plot shown for 18 MHz Bandwidth 16QAM Modulation. All other results for this bandwidth and modulation are held on file.

Plot 122

2,417 MHz Radiated Spurious Emissions > 1GHz

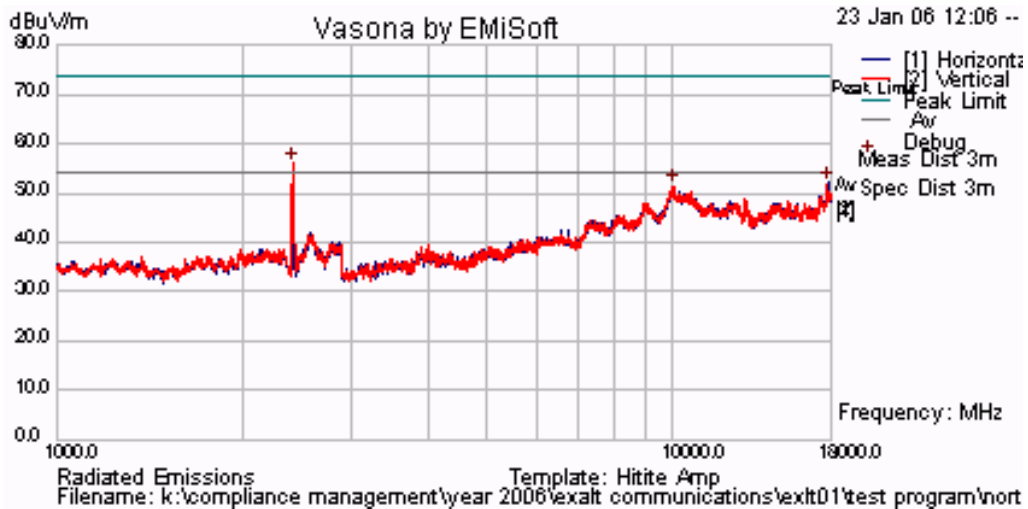

This test report may be reproduced in full only. The document may only be updated by MiCOM Labs personnel. Any changes will be noted in the Document History section of the report.



30.3 dBi Parabolic
TABLE OF RESULTS – 18 MHz Bandwidth 64QAM Modulation

CH.	Freq. (MHz)	Pol. (H/V)	Raw Reading (dB μ V/m)	Correction Factor (dB)	Corrected Field Strength (dB μ V/m)	Limit (dB μ V/m)	Margin (dB)
2,465			Note			54.00	

Note. The peak emission shown in the graph below is fundamental breaking through the notch filter. No other emissions were observed above the limit line.

Worst case plot shown for 18 MHz Bandwidth 64QAM Modulation. All other results for this bandwidth and modulation are held on file.

Plot 123

2,465 MHz Radiated Spurious Emissions > 1GHz

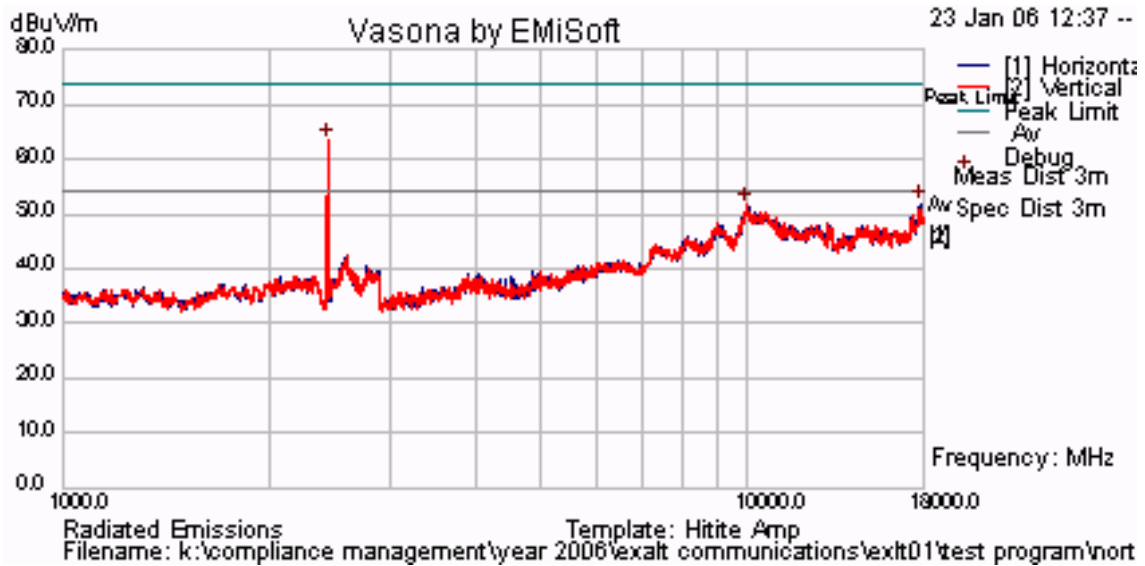

This test report may be reproduced in full only. The document may only be updated by MiCOM Labs personnel. Any changes will be noted in the Document History section of the report.



30.3 dBi Parabolic

TABLE OF RESULTS – 36 MHz Bandwidth QPSK Modulation

CH.	Freq. (MHz)	Pol. (H/V)	Raw Reading (dB μ V/m)	Correction Factor (dB)	Corrected Field Strength (dB μ V/m)	Limit (dB μ V/m)	Margin (dB)
2,426			Note			54.00	

Note. The peak emission shown in the graph below is fundamental breaking through the notch filter. No other emissions were observed above the limit line.

Worst case plot shown for 36 MHz Bandwidth QPSK Modulation. All other results for this bandwidth and modulation are held on file.

Plot 124

2,426 MHz Radiated Spurious Emissions > 1GHz

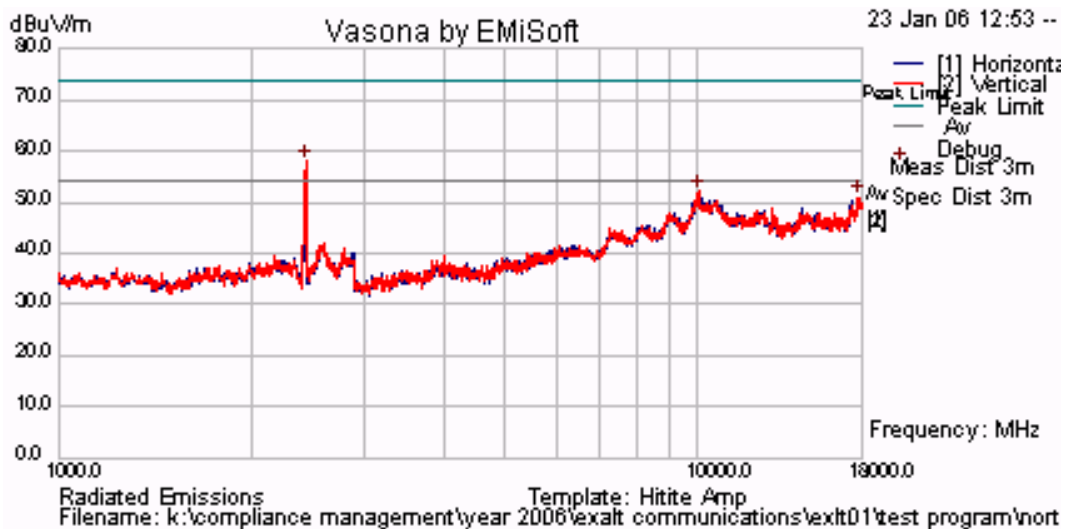

This test report may be reproduced in full only. The document may only be updated by MiCOM Labs personnel. Any changes will be noted in the Document History section of the report.



30.3 dBi Parabolic

TABLE OF RESULTS – 36 MHz Bandwidth 16QAM Modulation

CH.	Freq. (MHz)	Pol. (H/V)	Raw Reading (dB μ V/m)	Correction Factor (dB)	Corrected Field Strength (dB μ V/m)	Limit (dB μ V/m)	Margin (dB)
2,426			Note			54.00	

Note. The peak emission shown in the graph below is fundamental breaking through the notch filter. No other emissions were observed above the limit line.

Worst case plot shown for 36 MHz Bandwidth 16QAM Modulation. All other results for this bandwidth and modulation are held on file.

Plot 125

2,426 MHz Radiated Spurious Emissions > 1GHz

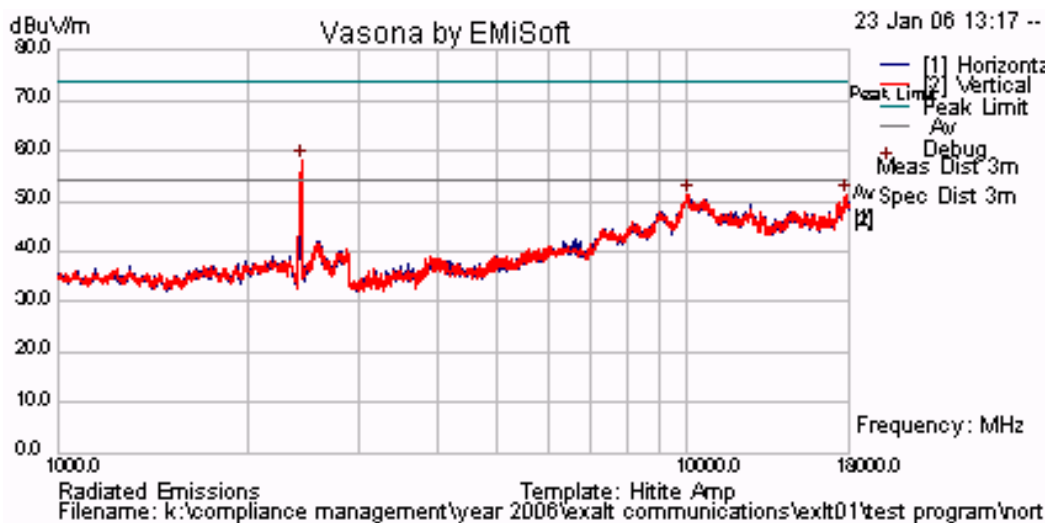

This test report may be reproduced in full only. The document may only be updated by MiCOM Labs personnel. Any changes will be noted in the Document History section of the report.



30.3 dBi Parabolic

TABLE OF RESULTS – 36 MHz Bandwidth 64QAM Modulation

CH.	Freq. (MHz)	Pol. (H/V)	Raw Reading (dB μ V/m)	Correction Factor (dB)	Corrected Field Strength (dB μ V/m)	Limit (dB μ V/m)	Margin (dB)
2,437			Note			54.00	

Note. The peak emission shown in the graph below is fundamental breaking through the notch filter. No other emissions were observed above the limit line.

Worst case plot shown for 36 MHz Bandwidth 64QAM Modulation. All other results for this bandwidth and modulation are held on file.

Plot 126

2,437 MHz Radiated Spurious Emissions > 1GHz

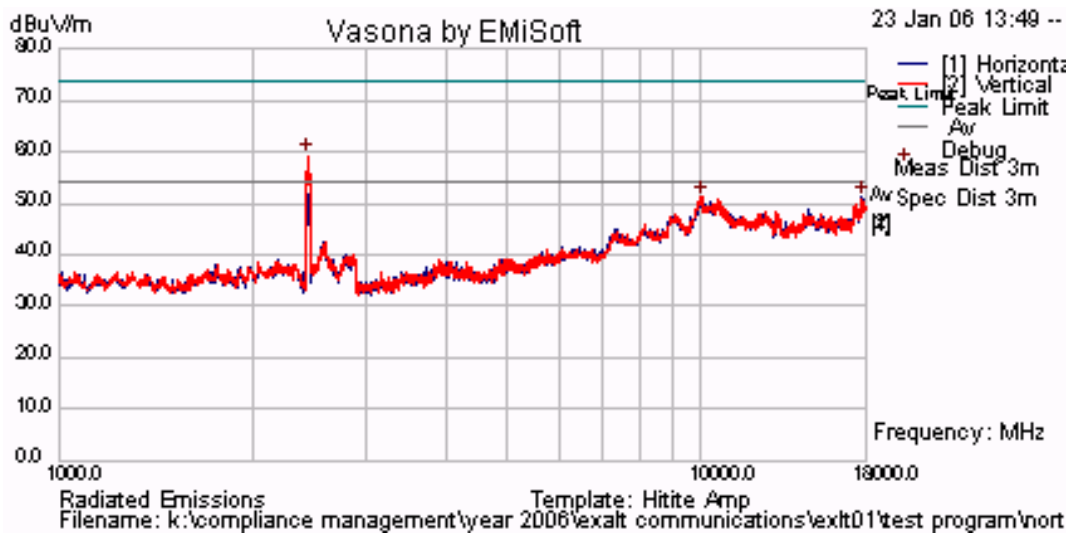

This test report may be reproduced in full only. The document may only be updated by MiCOM Labs personnel. Any changes will be noted in the Document History section of the report.



30.3 dBi Parabolic

TABLE OF RESULTS – 72 MHz Bandwidth QPSK Modulation

CH.	Freq. (MHz)	Pol. (H/V)	Raw Reading (dB μ V/m)	Correction Factor (dB)	Corrected Field Strength (dB μ V/m)	Limit (dB μ V/m)	Margin (dB)
2,437			Note			54.00	

Note. The peak emission shown in the graph below is fundamental breaking through the notch filter. No other emissions were observed above the limit line.

Worst case plot shown for 72 MHz Bandwidth QPSK Modulation. All other results for this bandwidth and modulation are held on file.

Plot 127

2,437 MHz Radiated Spurious Emissions > 1GHz

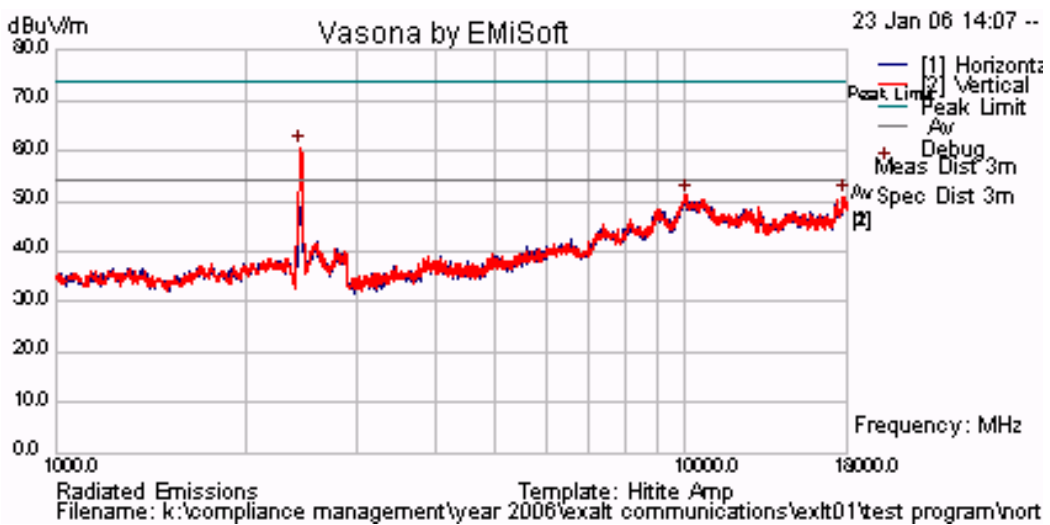

This test report may be reproduced in full only. The document may only be updated by MiCOM Labs personnel. Any changes will be noted in the Document History section of the report.



30.3 dBi Parabolic

TABLE OF RESULTS– 72 MHz Bandwidth 16QAM Modulation

CH.	Freq. (MHz)	Pol. (H/V)	Raw Reading (dB μ V/m)	Correction Factor (dB)	Corrected Field Strength (dB μ V/m)	Limit (dB μ V/m)	Margin (dB)
2,437			Note			54.00	

Note. The peak emission shown in the graph below is fundamental breaking through the notch filter. No other emissions were observed above the limit line.

Worst case plot shown for 72 MHz Bandwidth 16QAM Modulation. All other results for this bandwidth and modulation are held on file.

Plot 128

2,437 MHz Radiated Spurious Emissions > 1GHz

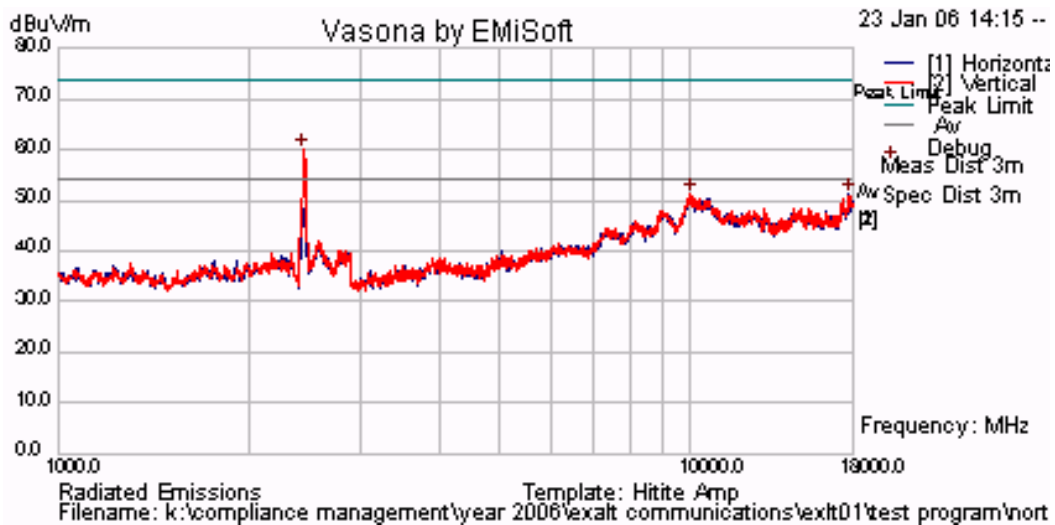

This test report may be reproduced in full only. The document may only be updated by MiCOM Labs personnel. Any changes will be noted in the Document History section of the report.



30.3 dBi Parabolic

TABLE OF RESULTS – 72 MHz Bandwidth 64QAM Modulation

CH.	Freq. (MHz)	Pol. (H/V)	Raw Reading (dB μ V/m)	Correction Factor (dB)	Corrected Field Strength (dB μ V/m)	Limit (dB μ V/m)	Margin (dB)
2,437			Note			54.00	

Note. The peak emission shown in the graph below is fundamental breaking through the notch filter. No other emissions were observed above the limit line.

Worst case plot shown for 72 MHz Bandwidth 64QAM Modulation. All other results for this bandwidth and modulation are held on file.

Plot 129

2,437 MHz Radiated Spurious Emissions > 1GHz

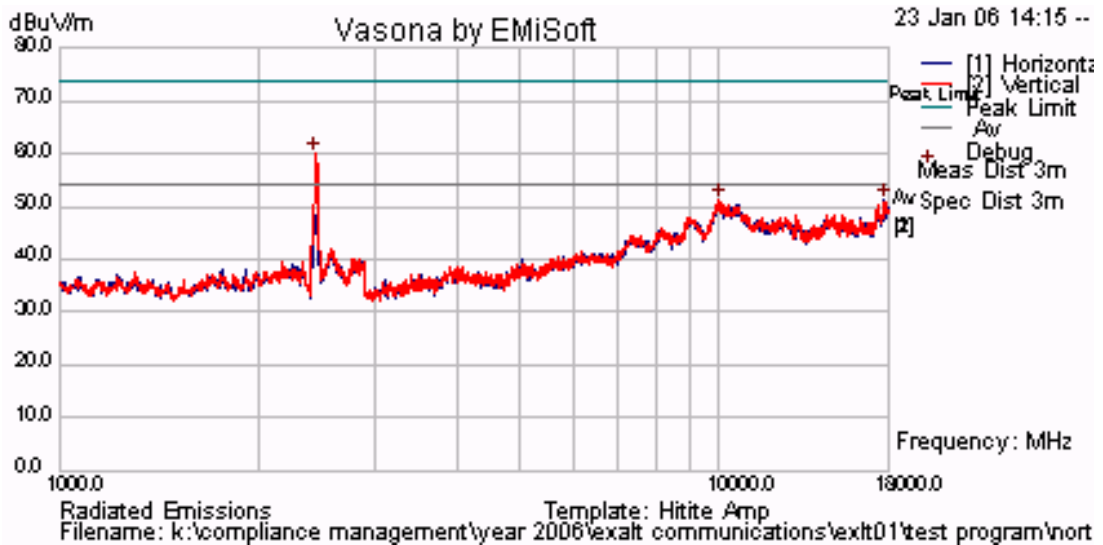

This test report may be reproduced in full only. The document may only be updated by MiCOM Labs personnel. Any changes will be noted in the Document History section of the report.



Title: Exalt EX-2.4i-16 Fixed Link Radio
To: FCC 47 CFR Part15.247 & IC RSS-210
Serial #: EXLT19-A1 Rev A
Issue Date: 28th Feb 2007
Page: 162 of 248

20 dBi Panel

TABLE OF RESULTS – 9 MHz Bandwidth QPSK Modulation

CH.	Freq. (MHz)	Pol. (H/V)	Raw Reading (dB μ V/m)	Correction Factor (dB)	Corrected Field Strength (dB μ V/m)	Limit (dB μ V/m)	Margin (dB)
2,468			Note			54.00	

Note. The peak emission shown in the graph below is fundamental breaking through the notch filter. No other emissions were observed above the limit line.

Worst case plot shown for 9 MHz Bandwidth QPSK Modulation. All other results for this bandwidth and modulation are held on file.

Plot 130

2,468 MHz Radiated Spurious Emissions > 1GHz

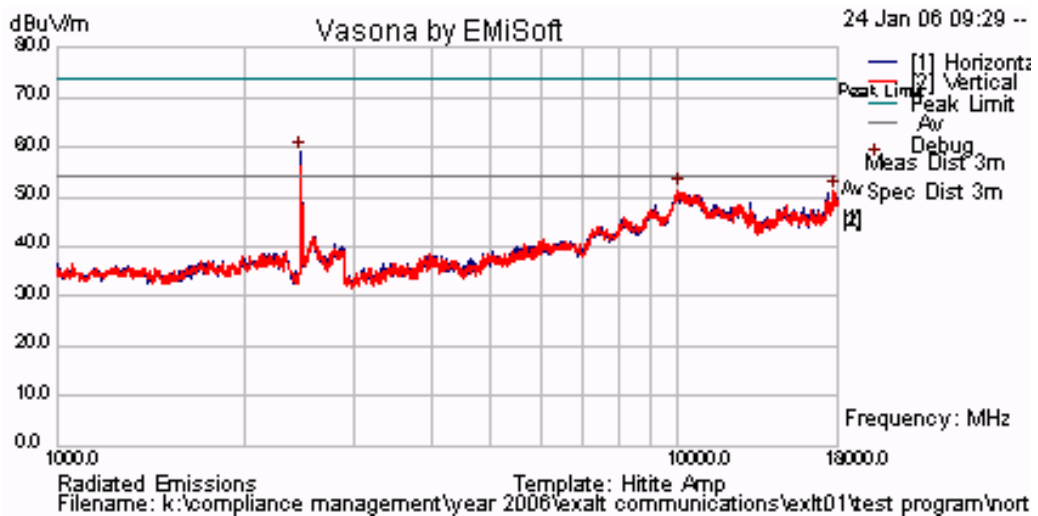

This test report may be reproduced in full only. The document may only be updated by MiCOM Labs personnel. Any changes will be noted in the Document History section of the report.



20 dBi Panel

TABLE OF RESULTS –9 MHz Bandwidth 16QAM Modulation

CH.	Freq. (MHz)	Pol. (H/V)	Raw Reading (dB μ V/m)	Correction Factor (dB)	Corrected Field Strength (dB μ V/m)	Limit (dB μ V/m)	Margin (dB)
2,468			Note			54.00	

Note. The peak emission shown in the graph below is fundamental breaking through the notch filter. No other emissions were observed above the limit line.

Worst case plot shown for 9 MHz Bandwidth 16QAM Modulation. All other results for this bandwidth and modulation are held on file.

Plot 131

2,468 MHz Radiated Spurious Emissions > 1GHz

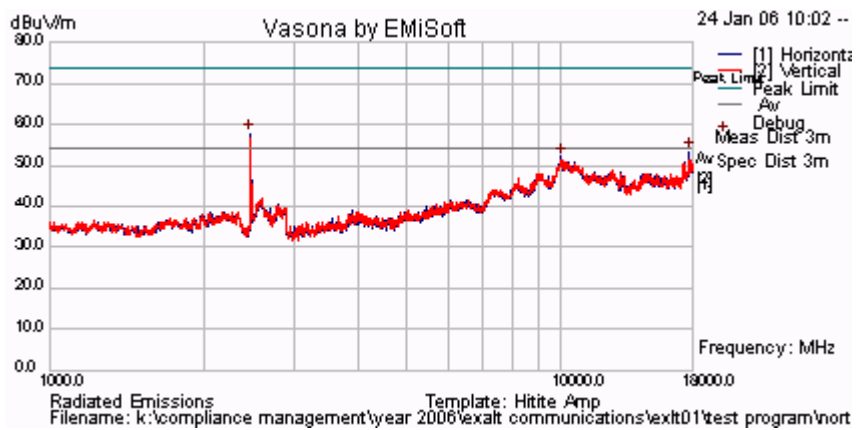

This test report may be reproduced in full only. The document may only be updated by MiCOM Labs personnel. Any changes will be noted in the Document History section of the report.



20 dBi Panel

TABLE OF RESULTS– 9 MHz Bandwidth 64QAM Modulation

CH.	Freq. (MHz)	Pol. (H/V)	Raw Reading (dB μ V/m)	Correction Factor (dB)	Corrected Field Strength (dB μ V/m)	Limit (dB μ V/m)	Margin (dB)
2,468			Note			54.00	

Note. The peak emission shown in the graph below is fundamental breaking through the notch filter. No other emissions were observed above the limit line.

Worst case plot shown for 9 MHz Bandwidth 64QAM Modulation. All other results for this bandwidth and modulation are held on file.

Plot 132

2,468 MHz Radiated Spurious Emissions > 1GHz

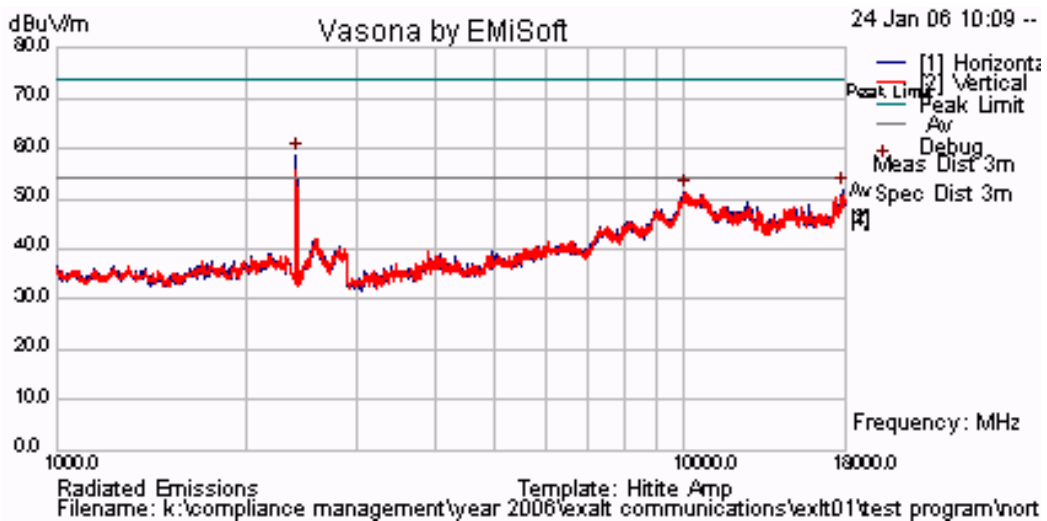

This test report may be reproduced in full only. The document may only be updated by MiCOM Labs personnel. Any changes will be noted in the Document History section of the report.



20 dBi Panel

TABLE OF RESULTS – 18 MHz Bandwidth QPSK Modulation

CH.	Freq. (MHz)	Pol. (H/V)	Raw Reading (dB μ V/m)	Correction Factor (dB)	Corrected Field Strength (dB μ V/m)	Limit (dB μ V/m)	Margin (dB)
2,465			Note			54.00	

Note. The peak emission shown in the graph below is fundamental breaking through the notch filter. No other emissions were observed above the limit line.

Worst case plot shown for 18 MHz Bandwidth QPSK Modulation. All other results for this bandwidth and modulation are held on file.

Plot 133

2,465 MHz Radiated Spurious Emissions > 1GHz

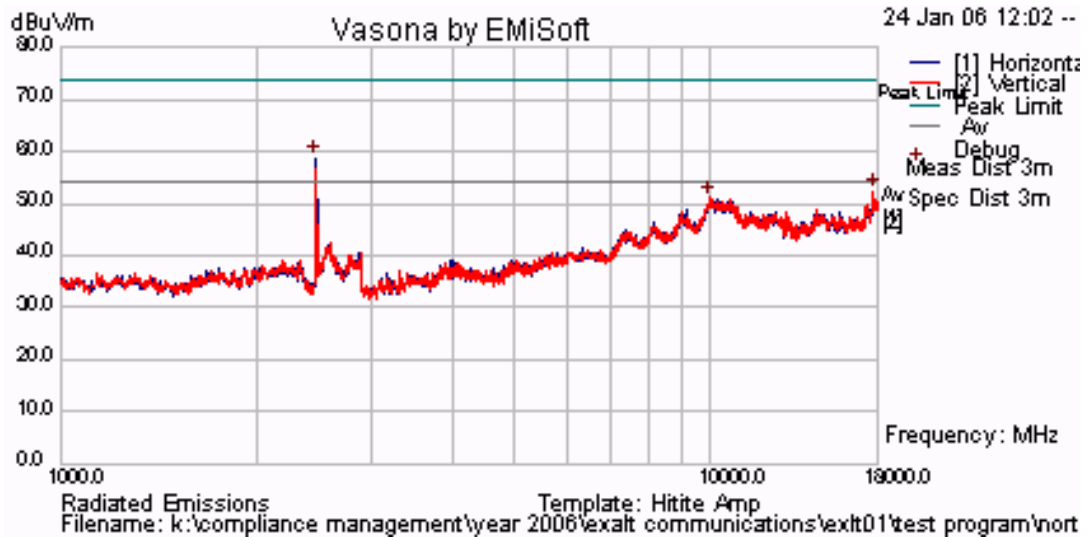

This test report may be reproduced in full only. The document may only be updated by MiCOM Labs personnel. Any changes will be noted in the Document History section of the report.



20 dBi Panel

TABLE OF RESULTS – 18 MHz Bandwidth 16QAM Modulation

CH.	Freq. (MHz)	Pol. (H/V)	Raw Reading (dB μ V/m)	Correction Factor (dB)	Corrected Field Strength (dB μ V/m)	Limit (dB μ V/m)	Margin (dB)
2,417			Note			54.00	

Note. The peak emission shown in the graph below is fundamental breaking through the notch filter. No other emissions were observed above the limit line.

Worst case plot shown for 18 MHz Bandwidth 16QAM Modulation. All other results for this bandwidth and modulation are held on file.

Plot 134

2,417 MHz Radiated Spurious Emissions > 1GHz

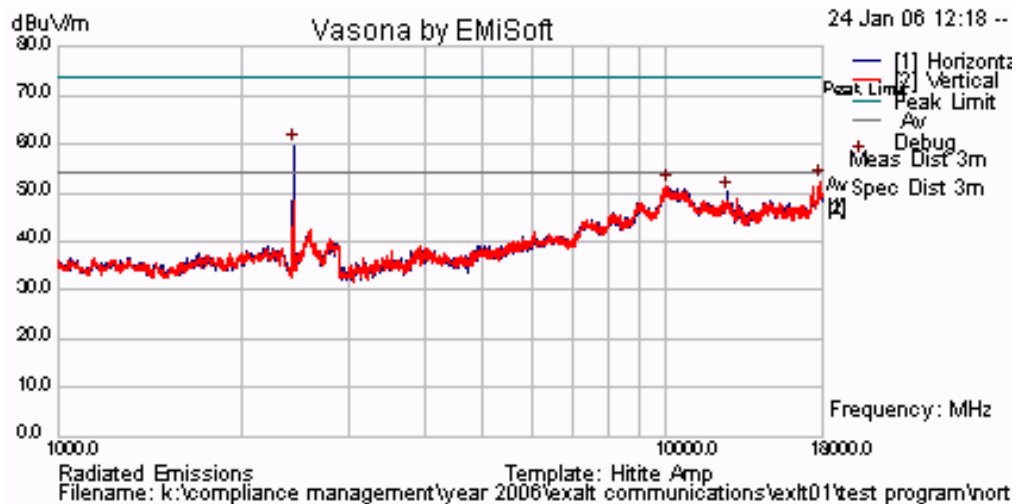

This test report may be reproduced in full only. The document may only be updated by MiCOM Labs personnel. Any changes will be noted in the Document History section of the report.



20 dBi Panel

TABLE OF RESULTS – 18 MHz Bandwidth 64QAM Modulation

CH.	Freq. (MHz)	Pol. (H/V)	Raw Reading (dB μ V/m)	Correction Factor (dB)	Corrected Field Strength (dB μ V/m)	Limit (dB μ V/m)	Margin (dB)
2,465			Note			54.00	

Note. The peak emission shown in the graph below is fundamental breaking through the notch filter. No other emissions were observed above the limit line.

Worst case plot shown for 18 MHz Bandwidth 64QAM Modulation. All other results for this bandwidth and modulation are held on file.

Plot 135

2,465 MHz Radiated Spurious Emissions > 1GHz

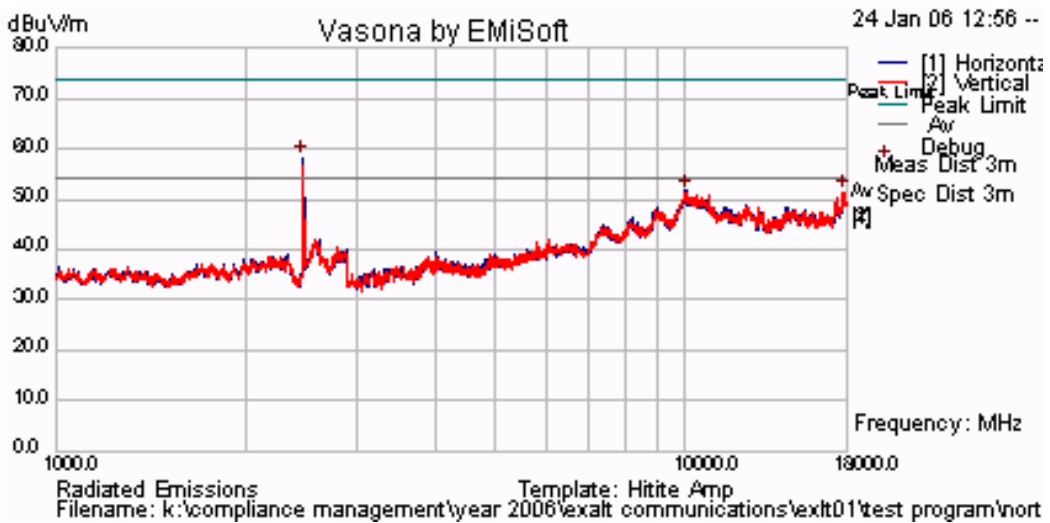

This test report may be reproduced in full only. The document may only be updated by MiCOM Labs personnel. Any changes will be noted in the Document History section of the report.



Title: Exalt EX-2.4i-16 Fixed Link Radio
To: FCC 47 CFR Part15.247 & IC RSS-210
Serial #: EXLT19-A1 Rev A
Issue Date: 28th Feb 2007
Page: 168 of 248

20 dBi Panel

TABLE OF RESULTS – 36 MHz Bandwidth QPSK Modulation

CH.	Freq. (MHz)	Pol. (H/V)	Raw Reading (dB μ V/m)	Correction Factor (dB)	Corrected Field Strength (dB μ V/m)	Limit (dB μ V/m)	Margin (dB)
2,426			Note			54.00	

Note. The peak emission shown in the graph below is fundamental breaking through the notch filter. No other emissions were observed above the limit line.

Worst case plot shown for 36 MHz Bandwidth QPSK Modulation. All other results for this bandwidth and modulation are held on file.

Plot 136

2,426 MHz Radiated Spurious Emissions > 1GHz

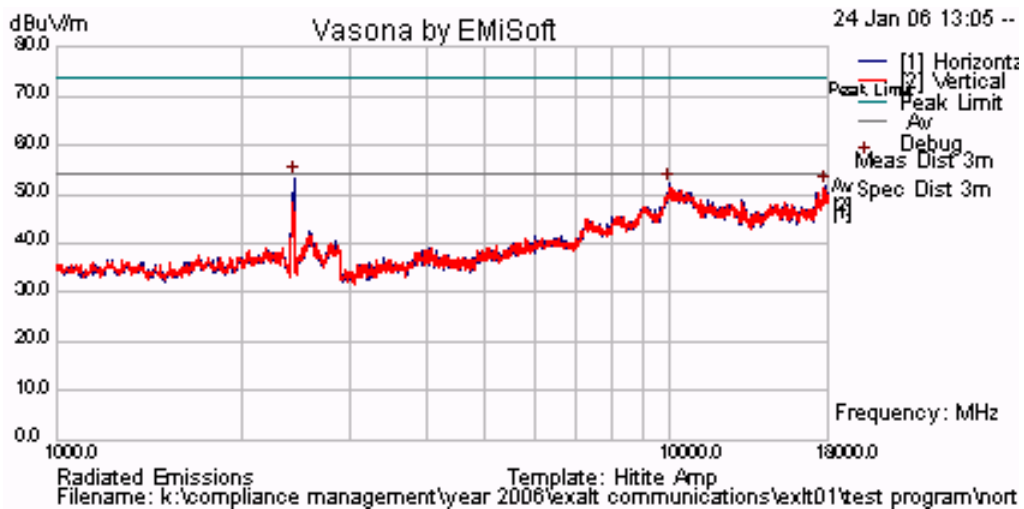

This test report may be reproduced in full only. The document may only be updated by MiCOM Labs personnel. Any changes will be noted in the Document History section of the report.



Title: Exalt EX-2.4i-16 Fixed Link Radio
To: FCC 47 CFR Part15.247 & IC RSS-210
Serial #: EXLT19-A1 Rev A
Issue Date: 28th Feb 2007
Page: 169 of 248

20 dBi Panel

TABLE OF RESULTS – 36 MHz Bandwidth 16QAM Modulation

CH.	Freq. (MHz)	Pol. (H/V)	Raw Reading (dB μ V/m)	Correction Factor (dB)	Corrected Field Strength (dB μ V/m)	Limit (dB μ V/m)	Margin (dB)
2,426			Note			54.00	

Note. The peak emission shown in the graph below is fundamental breaking through the notch filter. No other emissions were observed above the limit line.

Worst case plot shown for 36 MHz Bandwidth 16QAM Modulation. All other results for this bandwidth and modulation are held on file.

Plot 137

2,426 MHz Radiated Spurious Emissions > 1GHz

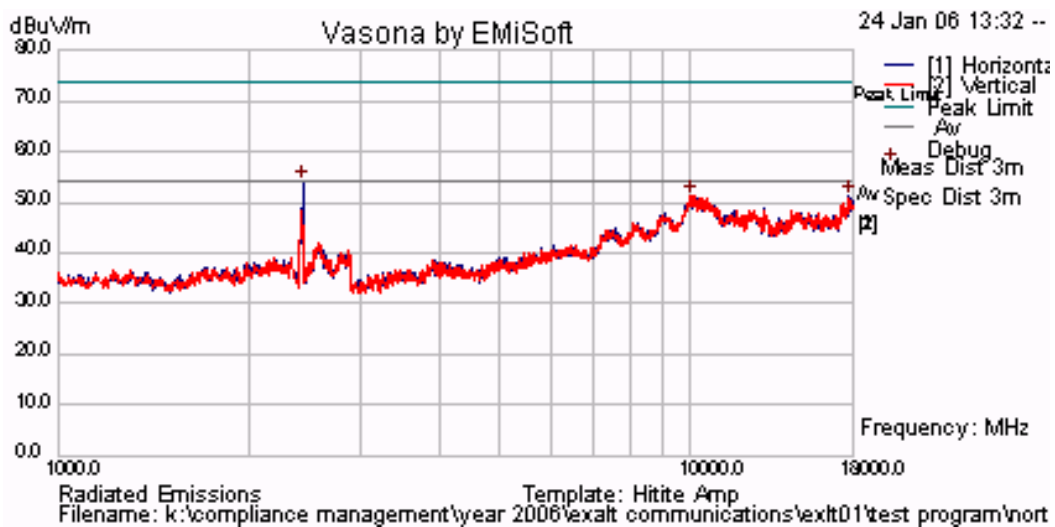

This test report may be reproduced in full only. The document may only be updated by MiCOM Labs personnel. Any changes will be noted in the Document History section of the report.



Title: Exalt EX-2.4i-16 Fixed Link Radio
To: FCC 47 CFR Part15.247 & IC RSS-210
Serial #: EXLT19-A1 Rev A
Issue Date: 28th Feb 2007
Page: 170 of 248

20 dBi Panel

TABLE OF RESULTS – 36 MHz Bandwidth 64QAM Modulation

CH.	Freq. (MHz)	Pol. (H/V)	Raw Reading (dB μ V/m)	Correction Factor (dB)	Corrected Field Strength (dB μ V/m)	Limit (dB μ V/m)	Margin (dB)
2,437			Note			54.00	

Note. The peak emission shown in the graph below is fundamental breaking through the notch filter. No other emissions were observed above the limit line.

Worst case plot shown for 36 MHz Bandwidth 64QAM Modulation. All other results for this bandwidth and modulation are held on file.

Plot 138

2,437 MHz Radiated Spurious Emissions > 1GHz

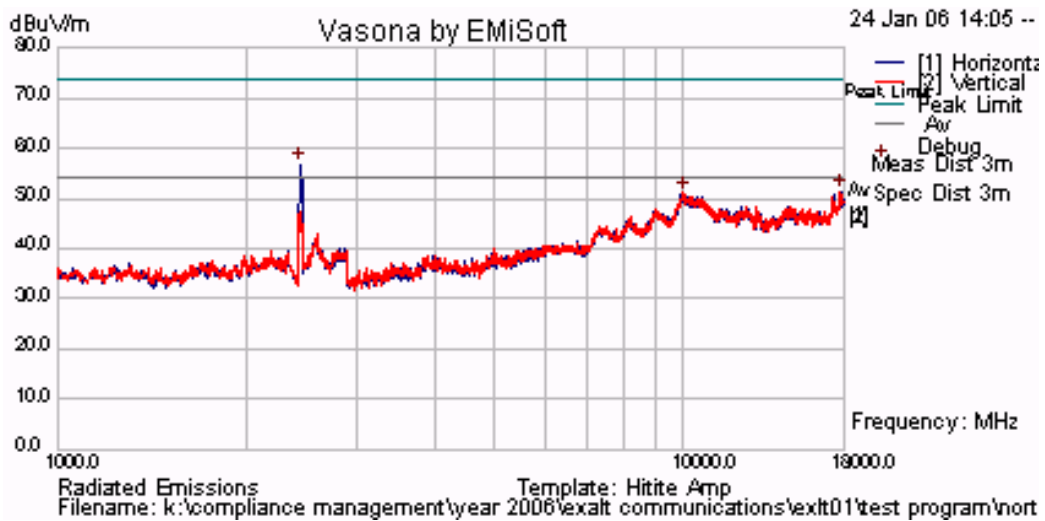

This test report may be reproduced in full only. The document may only be updated by MiCOM Labs personnel. Any changes will be noted in the Document History section of the report.



Title: Exalt EX-2.4i-16 Fixed Link Radio
To: FCC 47 CFR Part15.247 & IC RSS-210
Serial #: EXLT19-A1 Rev A
Issue Date: 28th Feb 2007
Page: 171 of 248

20 dBi Panel

TABLE OF RESULTS – 72 MHz Bandwidth QPSK Modulation

CH.	Freq. (MHz)	Pol. (H/V)	Raw Reading (dB μ V/m)	Correction Factor (dB)	Corrected Field Strength (dB μ V/m)	Limit (dB μ V/m)	Margin (dB)
2,437			Note			54.00	

Note. The peak emission shown in the graph below is fundamental breaking through the notch filter. No other emissions were observed above the limit line.

Worst case plot shown for 72 MHz Bandwidth QPSK Modulation. All other results for this bandwidth and modulation are held on file.

Plot 139

2,437 MHz Radiated Spurious Emissions > 1GHz

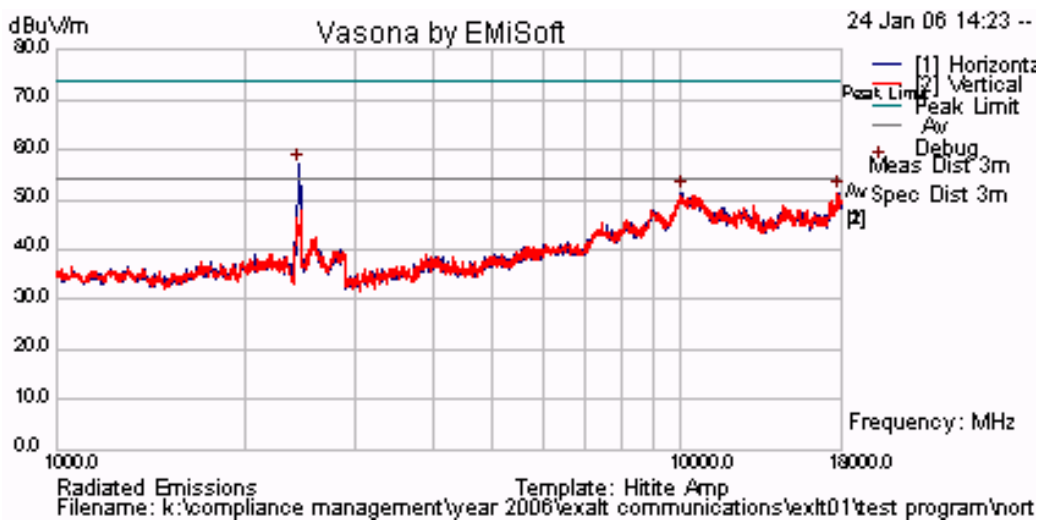

This test report may be reproduced in full only. The document may only be updated by MiCOM Labs personnel. Any changes will be noted in the Document History section of the report.



20 dBi Panel

TABLE OF RESULTS– 72 MHz Bandwidth 16QAM Modulation

CH.	Freq. (MHz)	Pol. (H/V)	Raw Reading (dB μ V/m)	Correction Factor (dB)	Corrected Field Strength (dB μ V/m)	Limit (dB μ V/m)	Margin (dB)
2,437			Note			54.00	

Note. The peak emission shown in the graph below is fundamental breaking through the notch filter. No other emissions were observed above the limit line.

Worst case plot shown for 72 MHz Bandwidth 16QAM Modulation. All other results for this bandwidth and modulation are held on file.

Plot 140

2,437 MHz Radiated Spurious Emissions > 1GHz

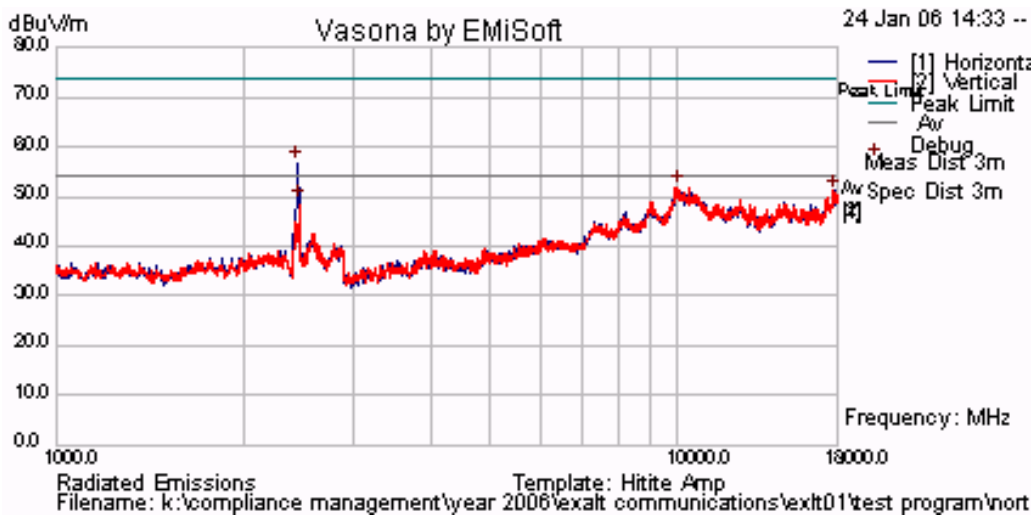

This test report may be reproduced in full only. The document may only be updated by MiCOM Labs personnel. Any changes will be noted in the Document History section of the report.



20 dBi Panel

TABLE OF RESULTS – 72 MHz Bandwidth 64QAM Modulation

CH.	Freq. (MHz)	Pol. (H/V)	Raw Reading (dB μ V/m)	Correction Factor (dB)	Corrected Field Strength (dB μ V/m)	Limit (dB μ V/m)	Margin (dB)
2,437			Note			54.00	

Note. The peak emission shown in the graph below is fundamental breaking through the notch filter. No other emissions were observed above the limit line.

Worst case plot shown for 72 MHz Bandwidth 64QAM Modulation. All other results for this bandwidth and modulation are held on file.

Plot 141

2,437 MHz Radiated Spurious Emissions > 1GHz

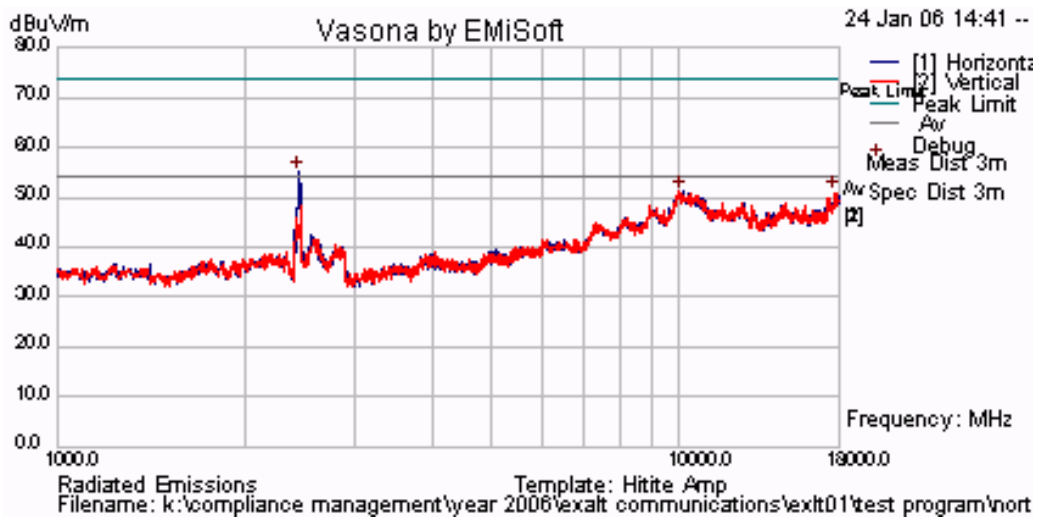

This test report may be reproduced in full only. The document may only be updated by MiCOM Labs personnel. Any changes will be noted in the Document History section of the report.



Specification

Limits

§15.205 (a) Except as shown in paragraph (d) of 15.205 (a), only spurious emissions are permitted in any of the frequency bands listed.

§15.205 (a) Except as shown in paragraphs (d) and (e) of this section, the field strength of emissions appearing within these frequency bands shall not exceed the limits shown in Section §15.209. At frequencies equal to or less than 1000 MHz, compliance with the limits in Section 15.209 shall be demonstrated using measurement instrumentation employing a CISPR quasi-peak detector. Above 1000 MHz, compliance with the emission limits in Section 15.209 shall be demonstrated based on the average value of the measured emissions. The provisions in Section 15.35 apply to these measurements.

§15.209 (a) Except as provided elsewhere in this subpart, the emissions from an intentional radiator shall not exceed the field strength levels specified in the following table.

IC RSS-Gen § 4.7 The search for unwanted emissions shall be from the lowest frequency internally generated or used in the device, or from 30 MHz, whichever is the lowest frequency, to the 5th harmonic of the highest frequency generated without exceeding 40 GHz.

Frequency (MHz)	Field Strength ($\mu\text{V/m}$)	Field Strength ($\text{dB}\mu\text{V/m}$)	Measurement Distance (meters)
30-88	100	40.0	3
88-216	150	43.5	3
216-960	200	46.0	3
Above 960	500	54.0	3

Laboratory Measurement Uncertainty for Radiated Emissions

Measurement uncertainty	+5.6/ -4.5 dB
-------------------------	---------------

Traceability

Method	Test Equipment Used
Measurements were made per work instruction WI-03 'Measurement of Radiated Emissions'	0088, 0158, 0134, 0304, 0315, 0310, 0312

This test report may be reproduced in full only. The document may only be updated by MiCOM Labs personnel. Any changes will be noted in the Document History section of the report.

5.1.6.2. Receiver Radiated Spurious Emissions (above 1 GHz)

Industry Canada RSS-Gen §4.8

Test Procedure

Radiated emissions above 1 GHz are measured in the anechoic chamber at a 3-meter distance on every azimuth in both horizontal and vertical polarities. The emissions are recorded and maximized as a function of azimuth by rotation through 360° with a spectrum analyzer in peak hold mode. Depending on the frequency band spanned a notch filter and waveguide filter was used to remove the fundamental frequency. The highest emissions relative to the limit are listed for each frequency spanned.

All measurements above 1 GHz were performed using a minimum resolution bandwidth of 1 MHz.

Test Measurement Set up

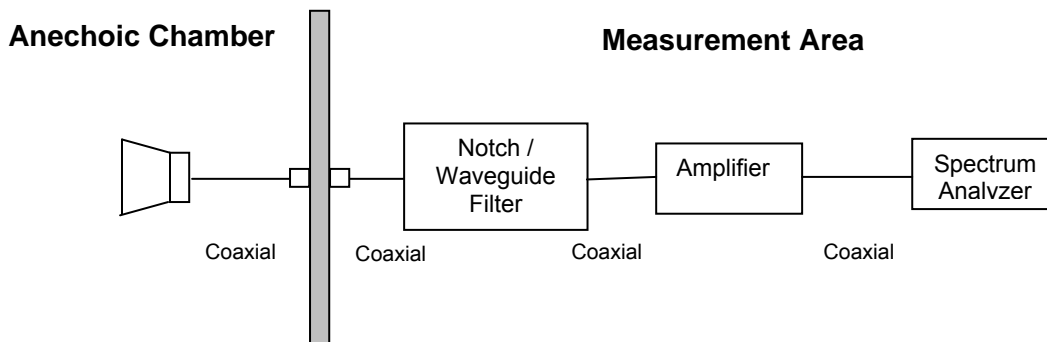

Measurement set up for Radiated Emission Test

Field Strength Calculation

The field strength is calculated by adding the Antenna Factor and Cable Loss, and subtracting Amplifier Gain from the measured reading. All factors are included in the reported data.

$$FS = R + AF + CORR - FO$$

where: FS = Field Strength

R = Measured Spectrum analyzer Input Amplitude

AF = Antenna Factor

CORR = Correction Factor = CL – AG + NFL

CL = Cable Loss

AG = Amplifier Gain

FO = Distance Falloff Factor

NFL = Notch Filter Loss or Waveguide Loss



Title: Exalt EX-2.4i-16 Fixed Link Radio
To: FCC 47 CFR Part15.247 & IC RSS-210
Serial #: EXLT19-A1 Rev A
Issue Date: 28th Feb 2007
Page: 176 of 248

For example:

Given receiver input reading of 51.5 dB μ V; Antenna Factor of 8.5 dB; Cable Loss of 1.3 dB; Falloff Factor of 0 dB, an Amplifier Gain of 26 dB and Notch Filter Loss of 1 dB. The Field Strength of the measured emission is:

$$FS = 51.5 + 8.5 + 1.3 - 26.0 + 1 = 36.3 \text{ dB}\mu\text{V/m}$$

Conversion between dB μ V/m (or dB μ V) and μ V/m (or μ V) are done as:

$$\text{Level (dB}\mu\text{V/m)} = 20 * \text{Log (level (\mu\text{V/m}))}$$

$$40 \text{ dB}\mu\text{V/m} = 100 \mu\text{V/m}$$

$$48 \text{ dB}\mu\text{V/m} = 250 \mu\text{V/m}$$

Receiver Radiated Spurious Emissions above 1 GHz

Ambient conditions.

Temperature: 19 to 26°C

Relative humidity: 31 to 57 %

Pressure: 999 to 1009 mbar

This test report may be reproduced in full only. The document may only be updated by MiCOM Labs personnel. Any changes will be noted in the Document History section of the report.



Receiver Radiated Spurious Emissions above 1 GHz

21.3 dBi Parabolic

TABLE OF RESULTS – 9 MHz Bandwidth all modulations

CH.	Freq. (MHz)	Pol. (H/V)	Raw Reading (dB μ V/m)	Correction Factor (dB)	Corrected Field Strength (dB μ V/m)	Limit (dB μ V/m)	Margin (dB)
2,437			Note			54.00	

Note. No emissions were observed above the limit.

Worst case plot is shown for 9 MHz Bandwidth QPSK Modulation. Results for other modulations in this bandwidth are held on file.

Plot 142

9 MHz BW QPSK Receiver Radiated Spurious Emissions > 1GHz

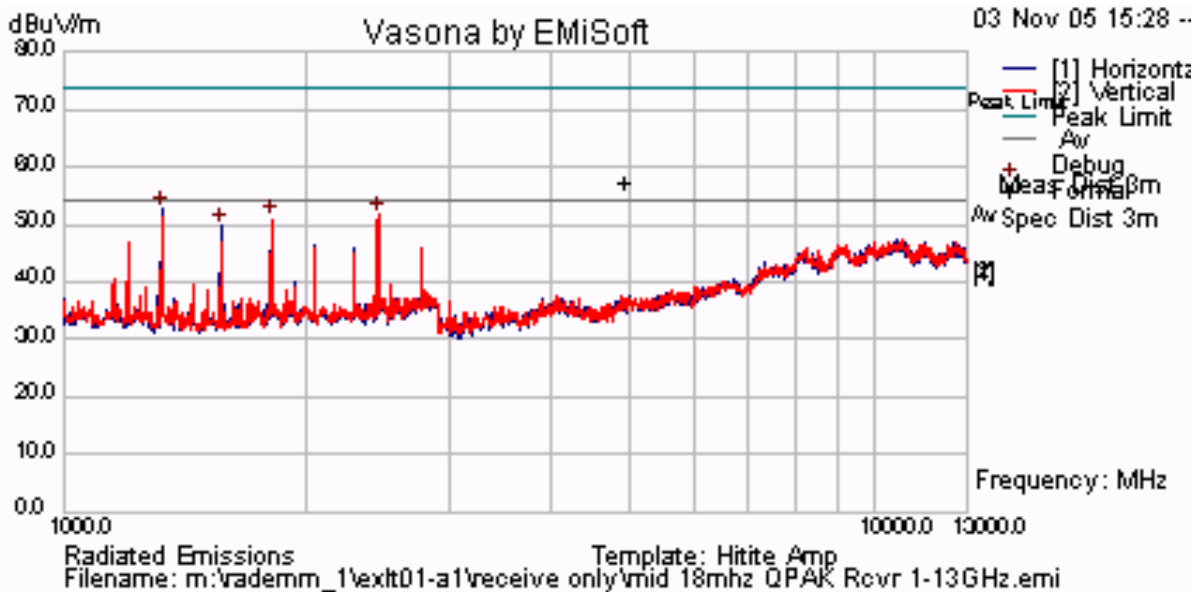

This test report may be reproduced in full only. The document may only be updated by MiCOM Labs personnel. Any changes will be noted in the Document History section of the report.



Title: Exalt EX-2.4i-16 Fixed Link Radio
To: FCC 47 CFR Part15.247 & IC RSS-210
Serial #: EXLT19-A1 Rev A
Issue Date: 28th Feb 2007
Page: 178 of 248

Receiver Radiated Spurious Emissions above 1 GHz

21.3 dBi Parabolic

TABLE OF RESULTS – 18 MHz Bandwidth all modulations

CH.	Freq. (MHz)	Pol. (H/V)	Raw Reading (dB μ V/m)	Correction Factor (dB)	Corrected Field Strength (dB μ V/m)	Limit (dB μ V/m)	Margin (dB)
2,437			Note			54.00	

Note. No emissions were observed above the limit.

Worst case plot is shown for 18 MHz Bandwidth 64QAM Modulation. Results for other modulations in this bandwidth are held on file.

Plot 143

18 MHz BW 64QAM Receiver Radiated Spurious Emissions > 1GHz

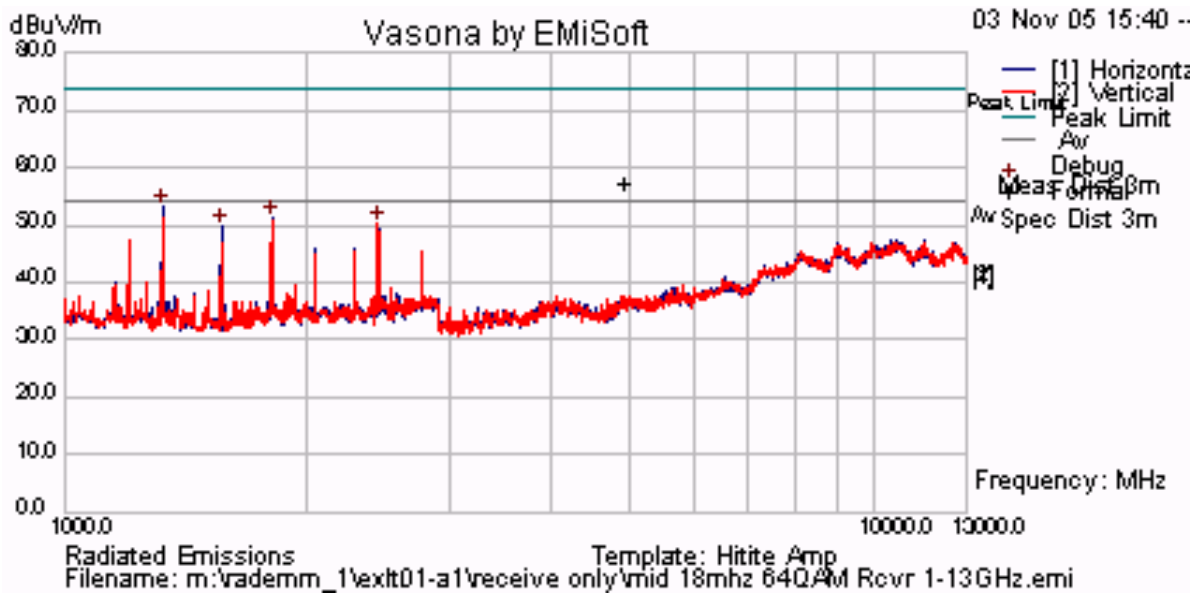

This test report may be reproduced in full only. The document may only be updated by MiCOM Labs personnel. Any changes will be noted in the Document History section of the report.



Title: Exalt EX-2.4i-16 Fixed Link Radio
To: FCC 47 CFR Part15.247 & IC RSS-210
Serial #: EXLT19-A1 Rev A
Issue Date: 28th Feb 2007
Page: 179 of 248

Receiver Radiated Spurious Emissions above 1 GHz

21.3 dBi Parabolic

TABLE OF RESULTS – 36 MHz Bandwidth all modulations

CH.	Freq. (MHz)	Pol. (H/V)	Raw Reading (dB μ V/m)	Correction Factor (dB)	Corrected Field Strength (dB μ V/m)	Limit (dB μ V/m)	Margin (dB)
2,437			Note			54.00	

Note. No emissions were observed above the limit.

Worst case plot is shown for 36 MHz Bandwidth 16QAM Modulation. Results for other modulations in this bandwidth are held on file.

Plot 144

36 MHz BW 16QAM Receiver Radiated Spurious Emissions > 1GHz

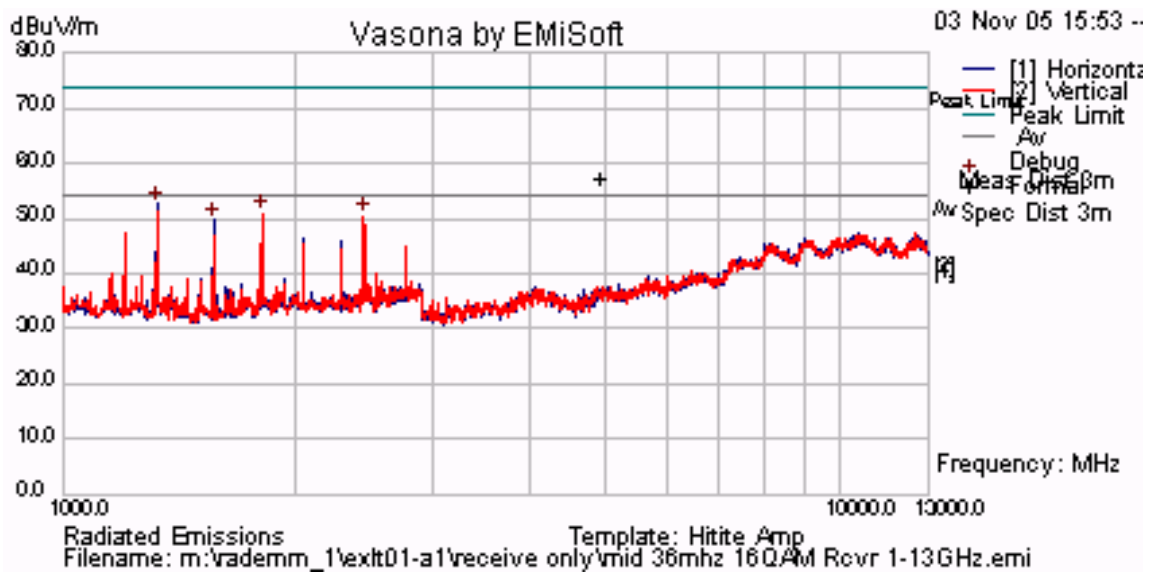

This test report may be reproduced in full only. The document may only be updated by MiCOM Labs personnel. Any changes will be noted in the Document History section of the report.



Receiver Radiated Spurious Emissions above 1 GHz

21.3 dBi Parabolic

TABLE OF RESULTS – 72 MHz Bandwidth all modulations

CH.	Freq. (MHz)	Pol. (H/V)	Raw Reading (dB μ V/m)	Correction Factor (dB)	Corrected Field Strength (dB μ V/m)	Limit (dB μ V/m)	Margin (dB)
2,437			Note			54.00	

Note. No emissions were observed above the limit.

Worst case plot is shown for 72 MHz Bandwidth 16QAM Modulation. Results for other modulations in this bandwidth are held on file.

Plot 145

72 MHz BW 16QAM Receiver Radiated Spurious Emissions > 1GHz

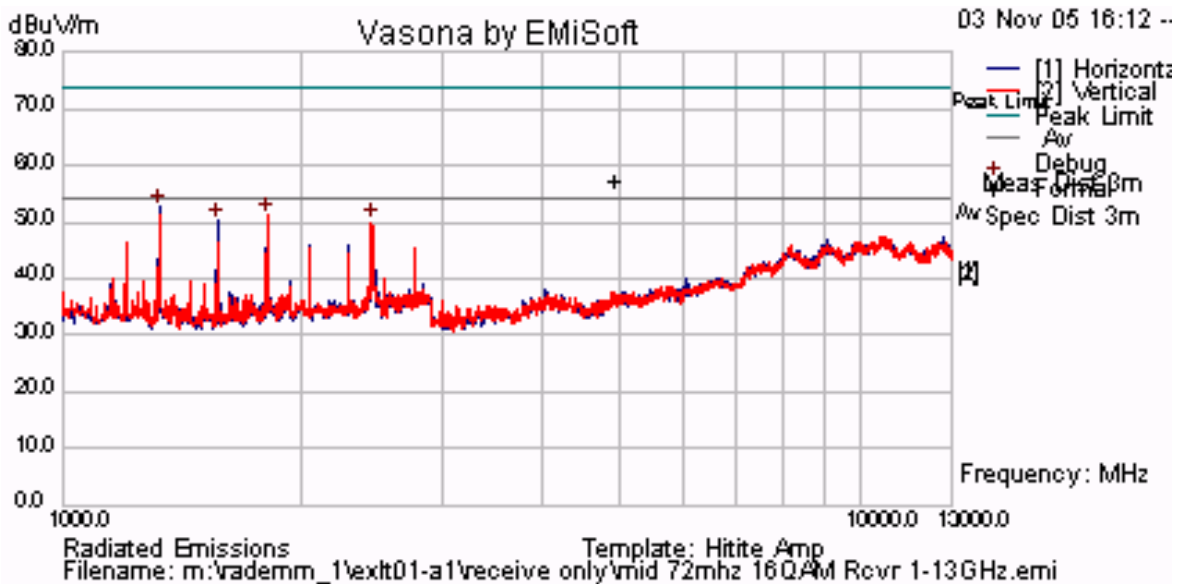

This test report may be reproduced in full only. The document may only be updated by MiCOM Labs personnel. Any changes will be noted in the Document History section of the report.



Title: Exalt EX-2.4i-16 Fixed Link Radio
To: FCC 47 CFR Part15.247 & IC RSS-210
Serial #: EXLT19-A1 Rev A
Issue Date: 28th Feb 2007
Page: 181 of 248

Receiver Radiated Spurious Emissions above 1 GHz
30.3 dBi Parabolic

TABLE OF RESULTS – 18 MHz Bandwidth QPSK

CH.	Freq. (MHz)	Pol. (H/V)	Raw Reading (dB μ V/m)	Correction Factor (dB)	Corrected Field Strength (dB μ V/m)	Limit (dB μ V/m)	Margin (dB)
2,437			Note			54.00	

Note. No emissions were observed above the limit.

Plot 146

18 MHz BW QPSK Receiver Radiated Spurious Emissions > 1GHz

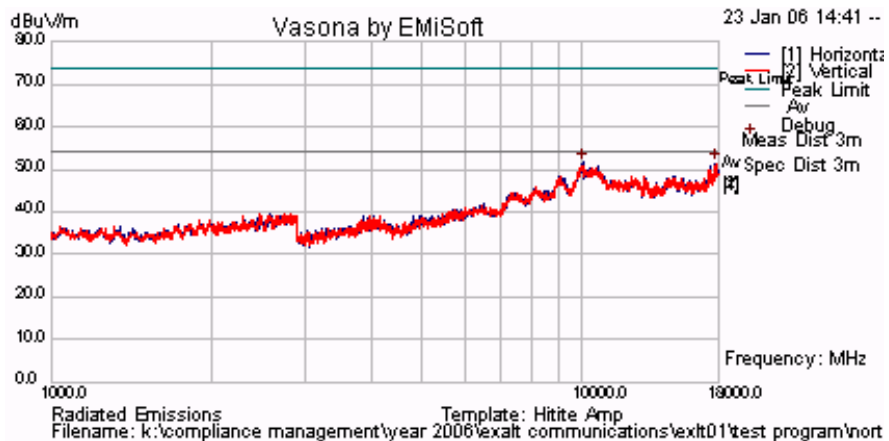

This test report may be reproduced in full only. The document may only be updated by MiCOM Labs personnel. Any changes will be noted in the Document History section of the report.



Title: Exalt EX-2.4i-16 Fixed Link Radio
To: FCC 47 CFR Part15.247 & IC RSS-210
Serial #: EXLT19-A1 Rev A
Issue Date: 28th Feb 2007
Page: 182 of 248

Receiver Radiated Spurious Emissions above 1 GHz

30.3 dBi Parabolic

TABLE OF RESULTS – 18 MHz Bandwidth 16QAM

CH.	Freq. (MHz)	Pol. (H/V)	Raw Reading (dB μ V/m)	Correction Factor (dB)	Corrected Field Strength (dB μ V/m)	Limit (dB μ V/m)	Margin (dB)
2,437			Note			54.00	

Note. No emissions were observed above the limit.

Plot 147

18 MHz BW 16QAM Receiver Radiated Spurious Emissions > 1GHz

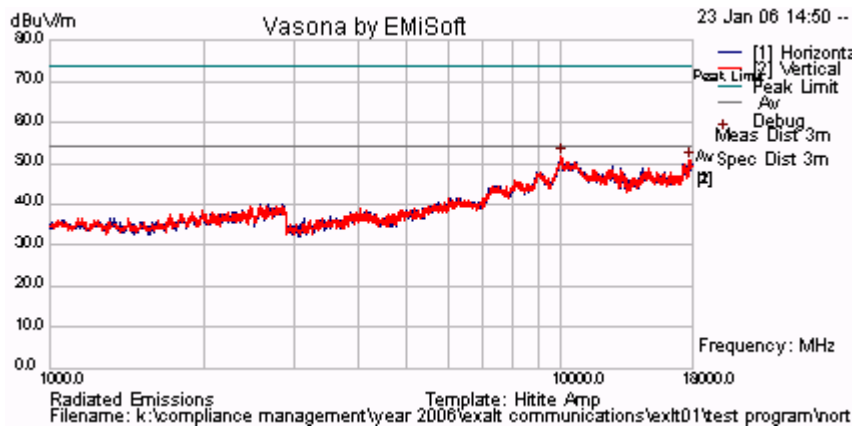

This test report may be reproduced in full only. The document may only be updated by MiCOM Labs personnel. Any changes will be noted in the Document History section of the report.



Title: Exalt EX-2.4i-16 Fixed Link Radio
To: FCC 47 CFR Part15.247 & IC RSS-210
Serial #: EXLT19-A1 Rev A
Issue Date: 28th Feb 2007
Page: 183 of 248

Receiver Radiated Spurious Emissions above 1 GHz

30.3 dBi Parabolic

TABLE OF RESULTS – 18 MHz Bandwidth 64QAM

CH.	Freq. (MHz)	Pol. (H/V)	Raw Reading (dB μ V/m)	Correction Factor (dB)	Corrected Field Strength (dB μ V/m)	Limit (dB μ V/m)	Margin (dB)
2,437			Note			54.00	

Note. No emissions were observed above the limit.

Plot 148

18 MHz BW 64QAM Receiver Radiated Spurious Emissions > 1GHz

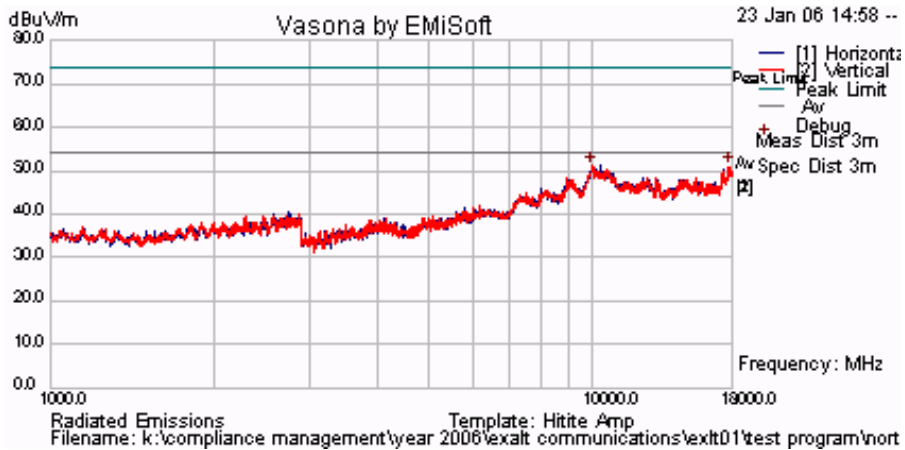

This test report may be reproduced in full only. The document may only be updated by MiCOM Labs personnel. Any changes will be noted in the Document History section of the report.



Title: Exalt EX-2.4i-16 Fixed Link Radio
To: FCC 47 CFR Part15.247 & IC RSS-210
Serial #: EXLT19-A1 Rev A
Issue Date: 28th Feb 2007
Page: 184 of 248

Receiver Radiated Spurious Emissions above 1 GHz

20 dBi Parabolic

TABLE OF RESULTS – 18 MHz Bandwidth QPSK

CH.	Freq. (MHz)	Pol. (H/V)	Raw Reading (dB μ V/m)	Correction Factor (dB)	Corrected Field Strength (dB μ V/m)	Limit (dB μ V/m)	Margin (dB)
2,437			Note			54.00	

Note. No emissions were observed above the limit.

Plot 149

18 MHz BW QPSK Receiver Radiated Spurious Emissions > 1GHz

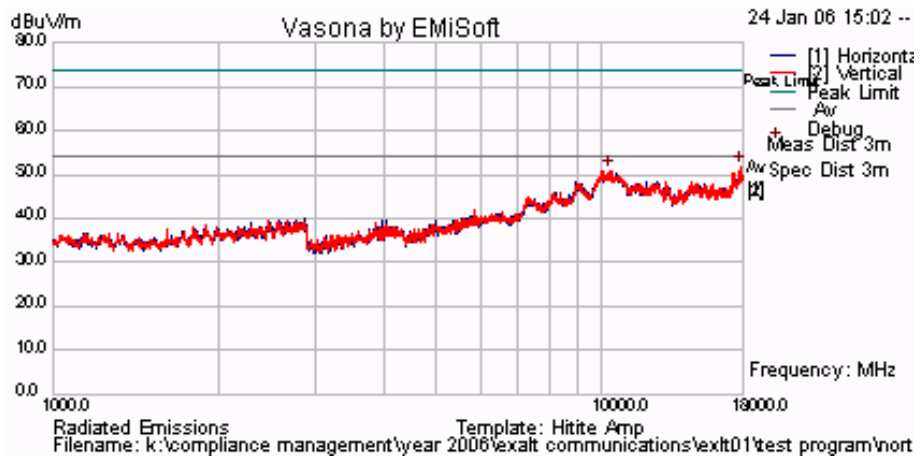

This test report may be reproduced in full only. The document may only be updated by MiCOM Labs personnel. Any changes will be noted in the Document History section of the report.



Title: Exalt EX-2.4i-16 Fixed Link Radio
To: FCC 47 CFR Part15.247 & IC RSS-210
Serial #: EXLT19-A1 Rev A
Issue Date: 28th Feb 2007
Page: 185 of 248

Receiver Radiated Spurious Emissions above 1 GHz
20 dBi Panel

TABLE OF RESULTS – 18 MHz Bandwidth 16QAM

CH.	Freq. (MHz)	Pol. (H/V)	Raw Reading (dB μ V/m)	Correction Factor (dB)	Corrected Field Strength (dB μ V/m)	Limit (dB μ V/m)	Margin (dB)
2,437			Note			54.00	

Note. No emissions were observed above the limit.

Plot 150

18 MHz BW 16QAM Receiver Radiated Spurious Emissions > 1GHz

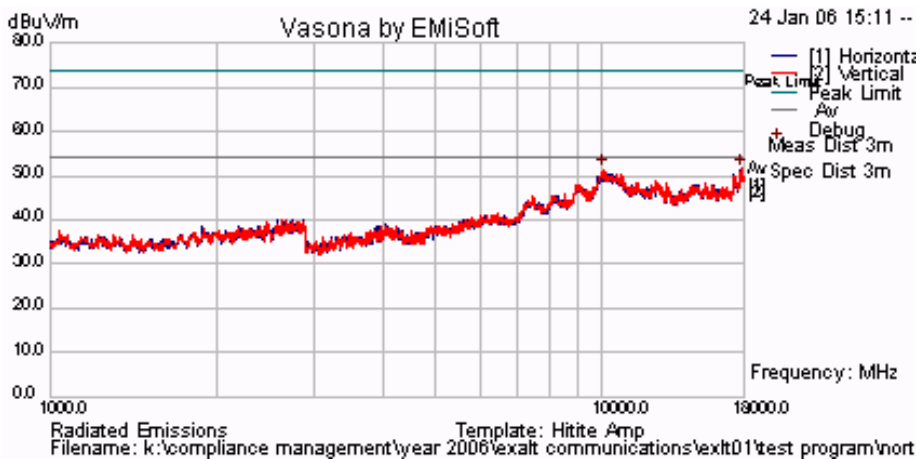

This test report may be reproduced in full only. The document may only be updated by MiCOM Labs personnel. Any changes will be noted in the Document History section of the report.



Title: Exalt EX-2.4i-16 Fixed Link Radio
To: FCC 47 CFR Part15.247 & IC RSS-210
Serial #: EXLT19-A1 Rev A
Issue Date: 28th Feb 2007
Page: 186 of 248

Receiver Radiated Spurious Emissions above 1 GHz

20 dBi Panel

TABLE OF RESULTS – 18 MHz Bandwidth 64QAM

CH.	Freq. (MHz)	Pol. (H/V)	Raw Reading (dB μ V/m)	Correction Factor (dB)	Corrected Field Strength (dB μ V/m)	Limit (dB μ V/m)	Margin (dB)
2,437			Note			54.00	

Note. No emissions were observed above the limit.

Plot 151

18 MHz BW 64QAM Receiver Radiated Spurious Emissions > 1GHz

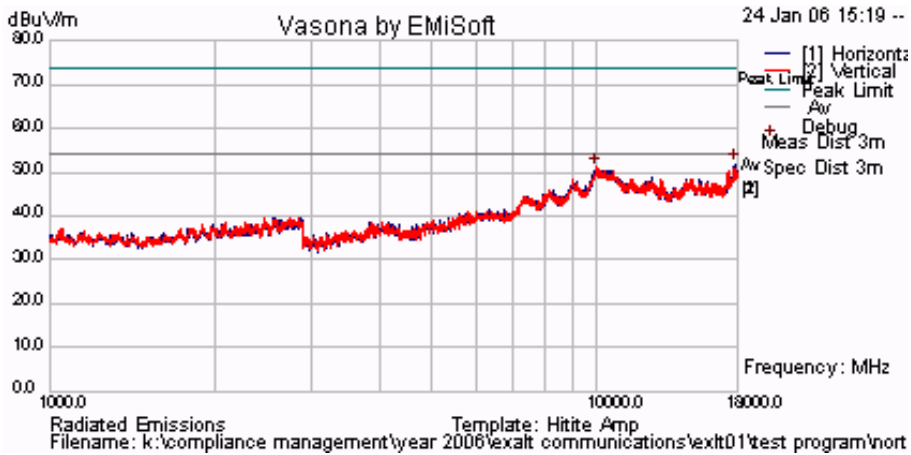

This test report may be reproduced in full only. The document may only be updated by MiCOM Labs personnel. Any changes will be noted in the Document History section of the report.



5.1.6.3. Peak Field Strength Measurements

Peak Field Strength for 2.4 GHz 21.3 dBi Antenna

TABLE OF RESULTS – 9 MHZ BANDWIDTH QPSK MODULATION

NOTE:

As a result of the higher power levels and to protect the test equipment a 16.0 dB attenuator was inserted between the transmit port and the antenna under test for the 21.3 dBi antenna. 16 dB was added to the value identified in all peak plots.

Power output power was fixed at the highest permissible power level for the 21.3 dBi antenna = +24.9 dBm, see Section 5.1.2 Peak Output Power

Plot 152 2,406 MHz

Peak Emission = 111.46 + 16.0 = 127.46 dB μ V/m

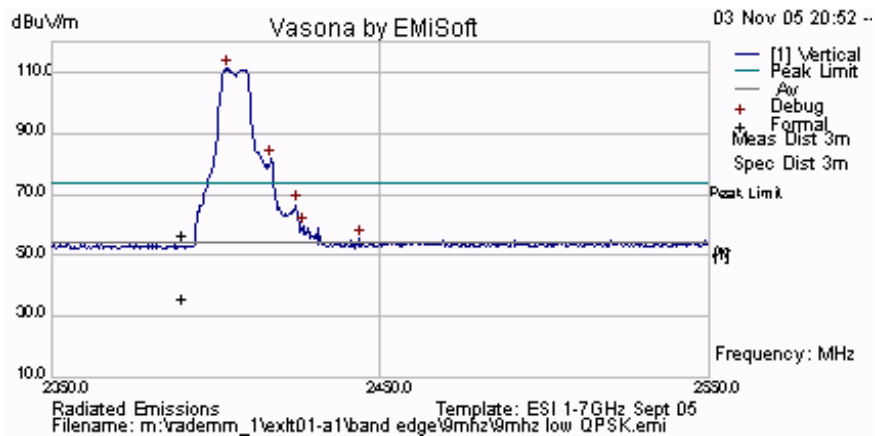

Plot 153 2,468 MHz

Peak Emission = 108.85 + 16 = 124.85 dB μ V/m

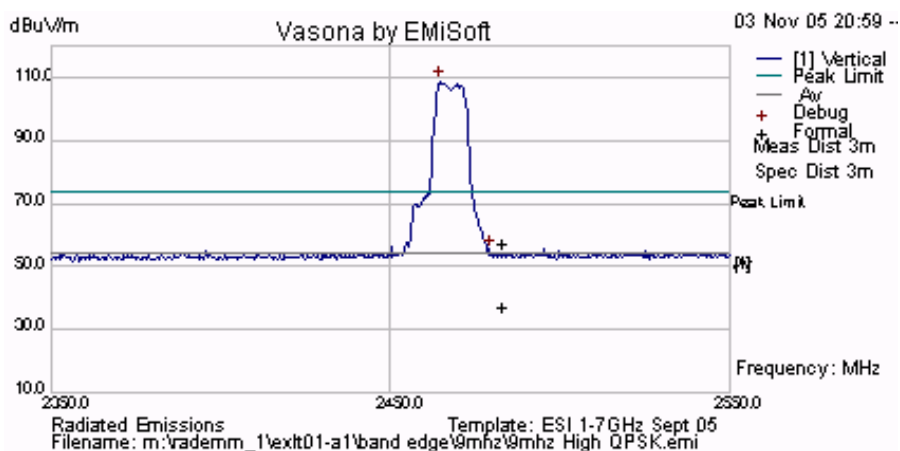

This test report may be reproduced in full only. The document may only be updated by MiCOM Labs personnel. Any changes will be noted in the Document History section of the report.



Title: Exalt EX-2.4i-16 Fixed Link Radio
To: FCC 47 CFR Part15.247 & IC RSS-210
Serial #: EXLT19-A1 Rev A
Issue Date: 28th Feb 2007
Page: 188 of 248

Peak Field Strength Test Results for 2.4 GHz 21.3 dBi Antenna
TABLE OF RESULTS – 9 MHZ BANDWIDTH 16QAM MODULATION

Plot 154 2,406 MHz

Peak Emission = 111.64 + 16 = 127.64 dB μ V/m

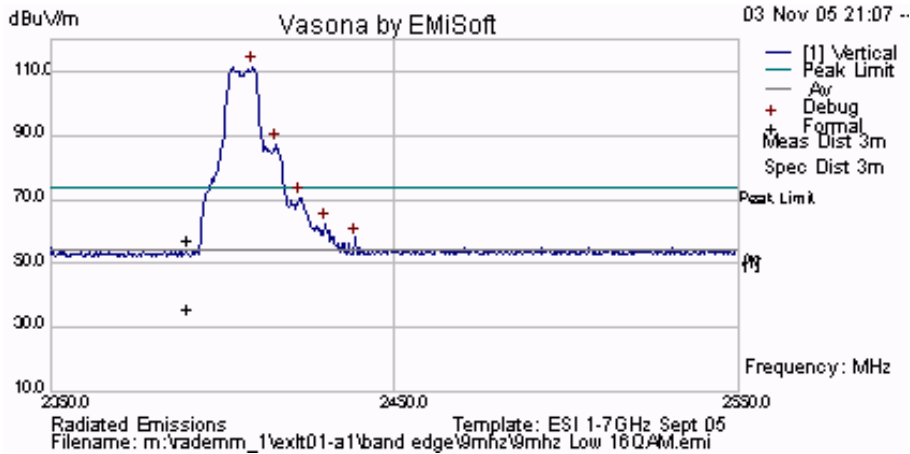

Plot 155 2,468 MHz

Peak Emission = 108.59 + 16 = 124.59 dB μ V/m

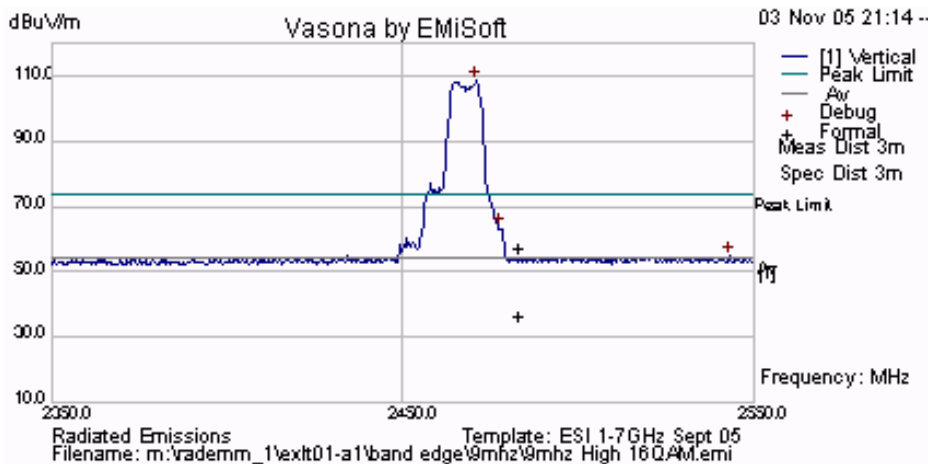

This test report may be reproduced in full only. The document may only be updated by MiCOM Labs personnel. Any changes will be noted in the Document History section of the report.



Peak Field Strength Test Results for 2.4 GHz 21.3 dBi Antenna
TABLE OF RESULTS – 9 MHZ BANDWIDTH 64QAM MODULATION

Plot 156 2,406 MHz

Peak Emission = 111.91 + 16 = 127.91 dBµV/m

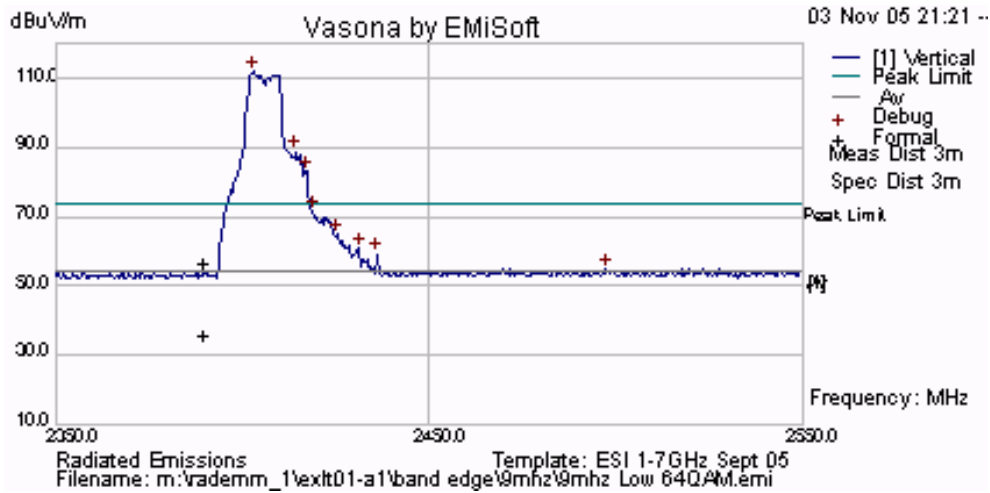

Plot 157 2,468 MHz

Peak Emission = 108.93 + 16 = 124.93 dBµV/m

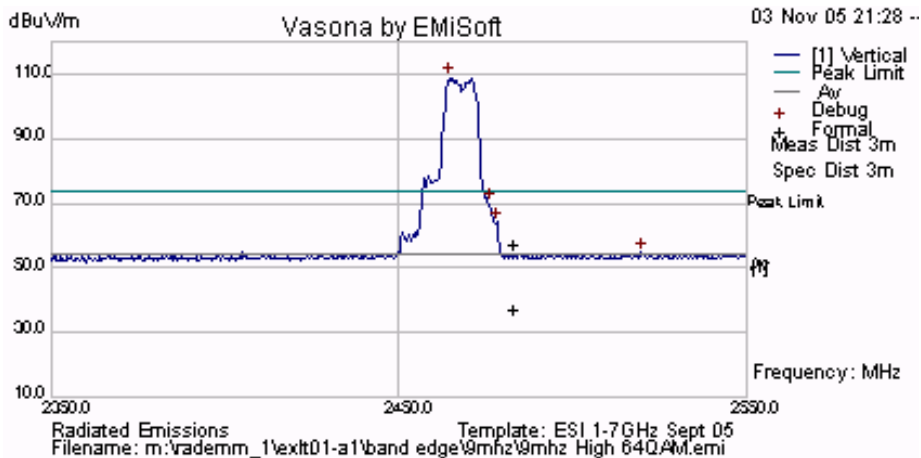

This test report may be reproduced in full only. The document may only be updated by MiCOM Labs personnel. Any changes will be noted in the Document History section of the report.



Peak Field Strength Test Results for 2.4 GHz 21.3 dBi Antenna
TABLE OF RESULTS – 18 MHZ BANDWIDTH QPSK MODULATION

Plot 158 2,417 MHz

Peak Emission = 110.35 + 16 = 126.35 dB μ V/m

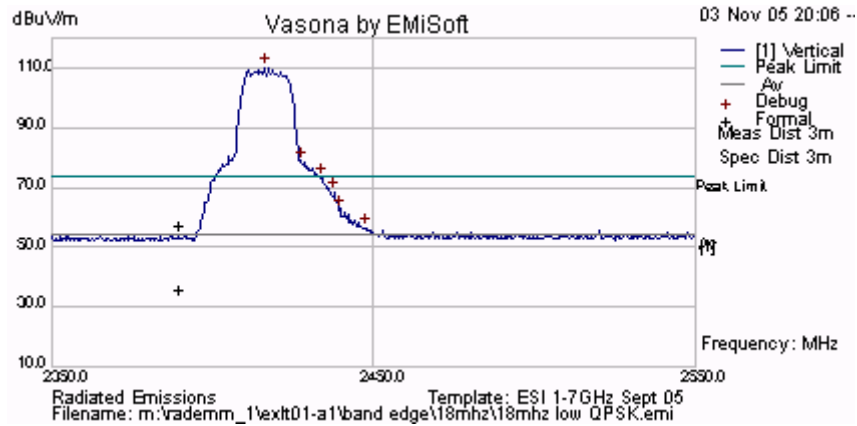

Plot 159 2,465 MHz

Peak Emission = 108.39 + 16 = 124.39 dB μ V/m

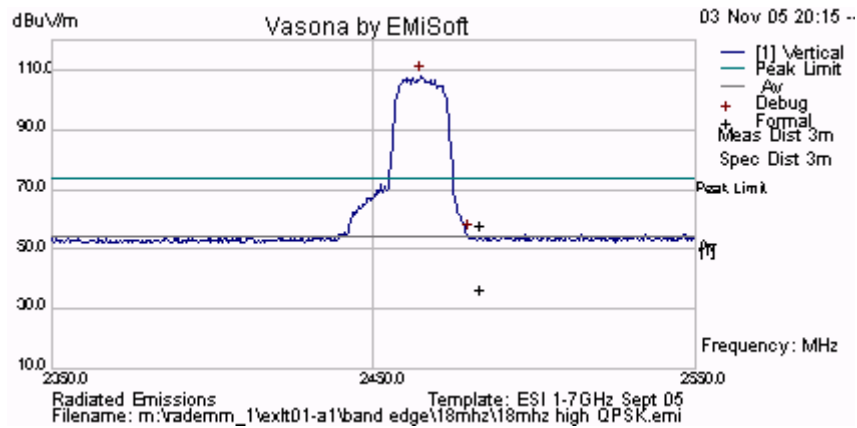

This test report may be reproduced in full only. The document may only be updated by MiCOM Labs personnel. Any changes will be noted in the Document History section of the report.



Peak Field Strength Test Results for 2.4 GHz 21.3 dBi Antenna
TABLE OF RESULTS – 18 MHZ BANDWIDTH 16QAM MODULATION

Plot 160 2,417 MHz

Peak Emission = 109.59 + 16 = 125.59 dB μ V/m

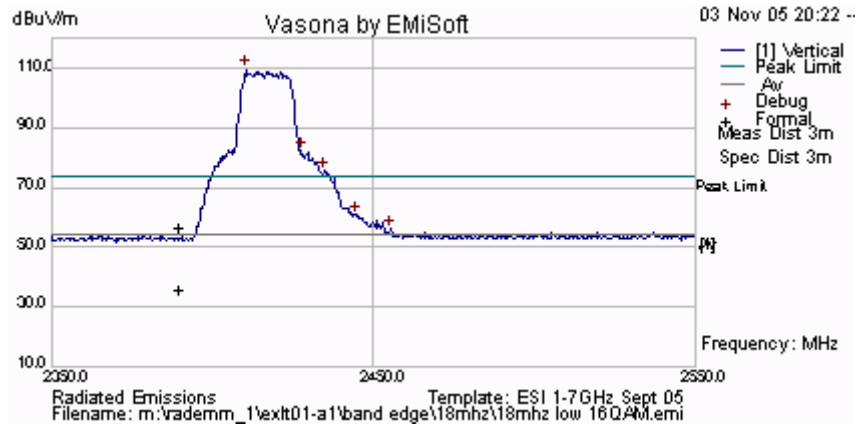

Plot 161 2,465 MHz

Peak Emission = 106.55 + 16 = 122.55 dB μ V/m

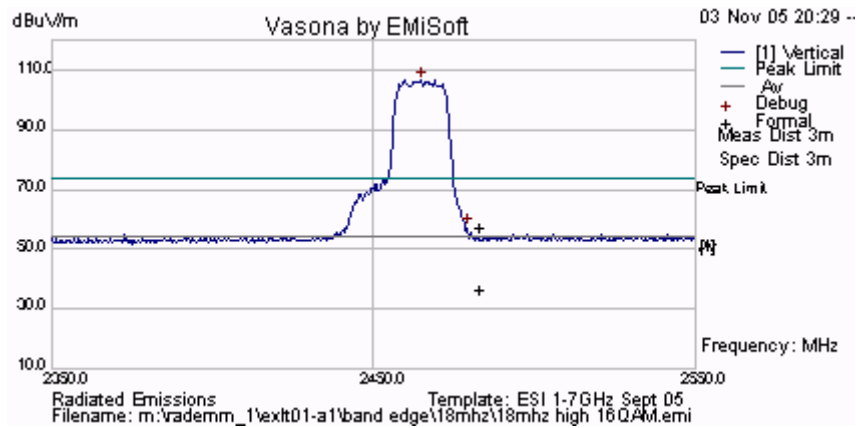

This test report may be reproduced in full only. The document may only be updated by MiCOM Labs personnel. Any changes will be noted in the Document History section of the report.



Peak Field Strength Test Results for 2.4 GHz 21.3 dBi Antenna
TABLE OF RESULTS – 18 MHZ BANDWIDTH 64QAM MODULATION

Plot 162 2,417 MHz

Peak Emission = 110.61 + 16 = 126.61 dB μ V/m

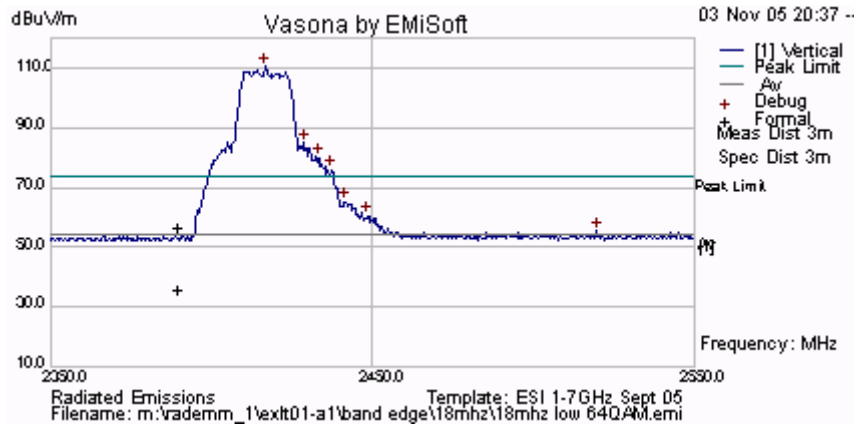

Plot 163 2,465 MHz

Peak Emission = 107.06 + 16 = 123.06 dB μ V/m

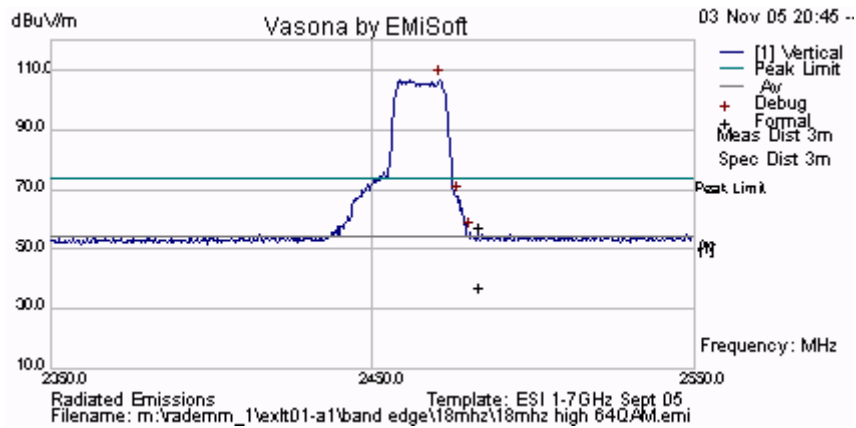

This test report may be reproduced in full only. The document may only be updated by MiCOM Labs personnel. Any changes will be noted in the Document History section of the report.



Peak Field Strength Test Results for 2.4 GHz 21.3 dBi Antenna
TABLE OF RESULTS – 36 MHZ BANDWIDTH QPSK MODULATION

Plot 164 2,426 MHz

Peak Emission = $106.37 + 16 = 122.37$ dB μ V/m

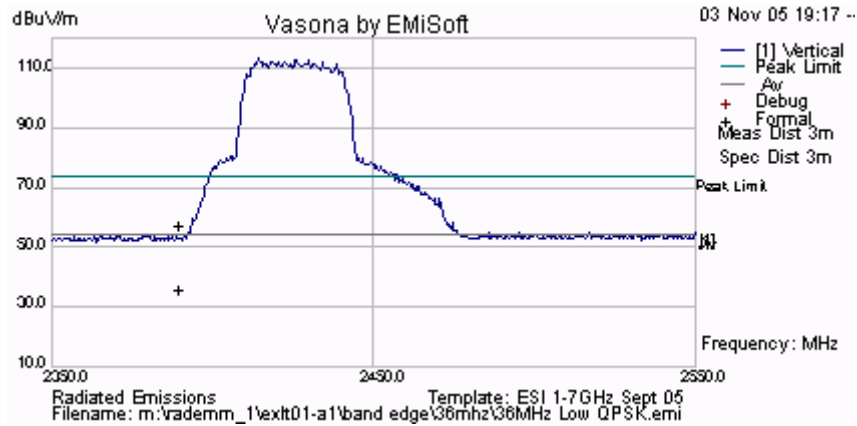

Plot 165 2,455 MHz

Peak Emission = $105.96 + 16 = 121.96$ dB μ V/m

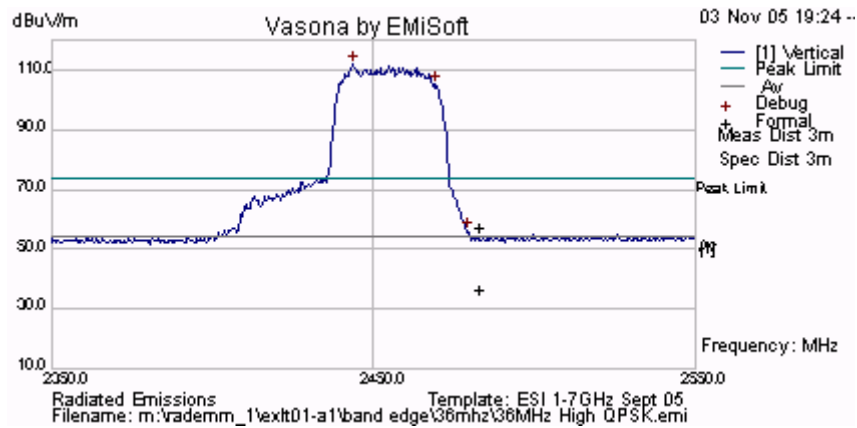

This test report may be reproduced in full only. The document may only be updated by MiCOM Labs personnel. Any changes will be noted in the Document History section of the report.



Peak Field Strength Test Results for 2.4 GHz 21.3 dBi Antenna
TABLE OF RESULTS – 36 MHZ BANDWIDTH 16QAM MODULATION

Plot 166 2,426 MHz

Peak Emission = 106.20 + 16 = 122.20 dBµV/m

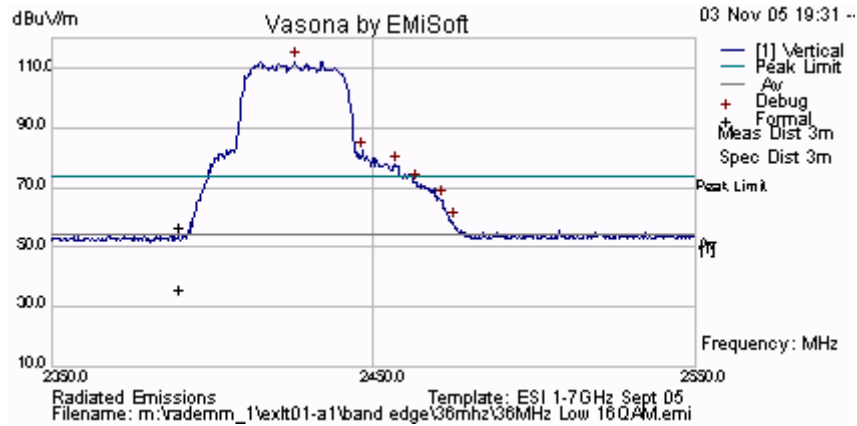

Plot 167 2,455 MHz

Peak Emission = 105.86 + 16 = 121.86 dBµV/m

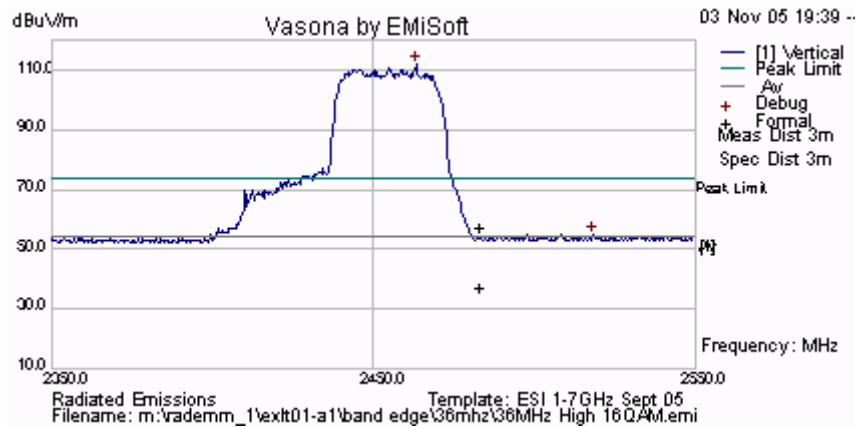

This test report may be reproduced in full only. The document may only be updated by MiCOM Labs personnel. Any changes will be noted in the Document History section of the report.



**Peak Field Strength Test Results for 2.4 GHz 21.3 dBi Antenna
TABLE OF RESULTS – 36 MHZ BANDWIDTH 64QAM MODULATION**

Plot 168 2,426 MHz

Peak Emission = $107.12 + 16 = 123.12$ dB μ V/m

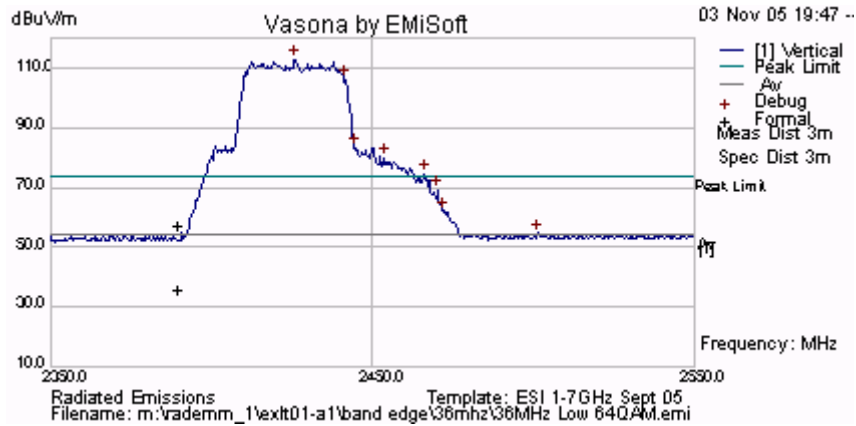

Plot 169 2,455 MHz

Peak Emission = $105.18 + 16 = 121.18$ dB μ V/m

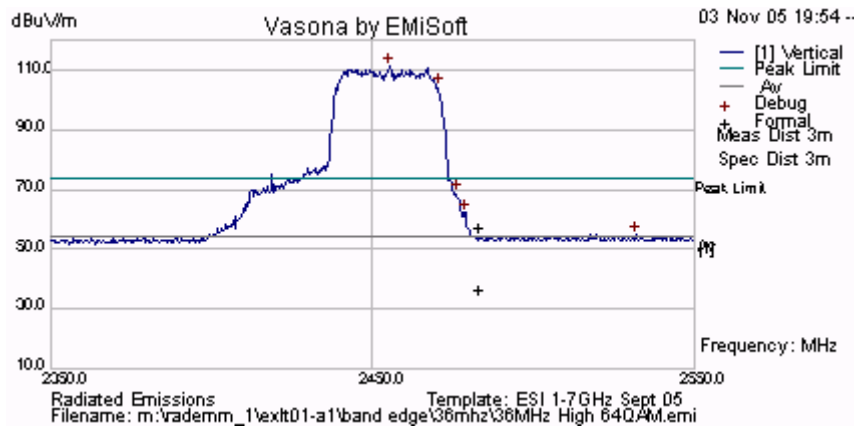

This test report may be reproduced in full only. The document may only be updated by MiCOM Labs personnel. Any changes will be noted in the Document History section of the report.



Peak Field Strength Test Results for 2.4 GHz 21.3 dBi Antenna
TABLE OF RESULTS – 72 MHZ BANDWIDTH QPSK MODULATION

Plot 170 2,437 MHz

Peak Emission = $108.45 + 16 = 124.45$ dB μ V/m

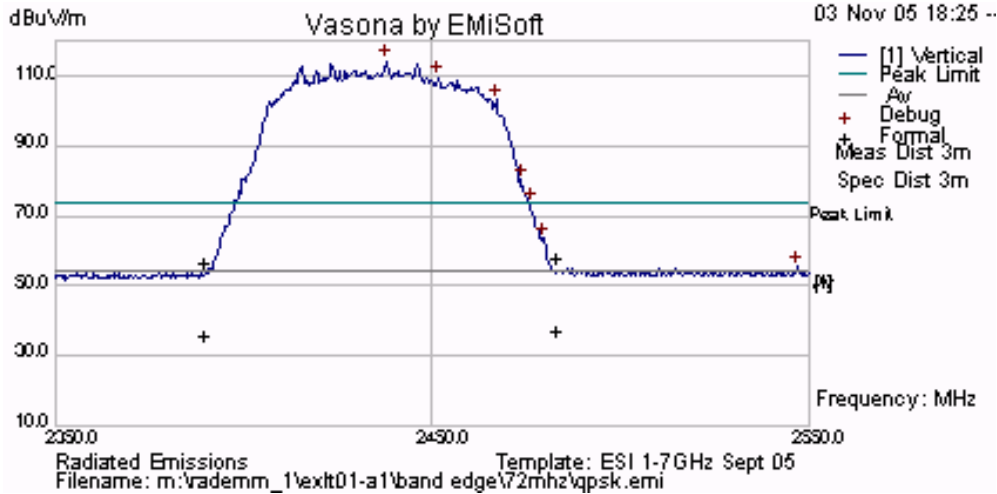

This test report may be reproduced in full only. The document may only be updated by MiCOM Labs personnel. Any changes will be noted in the Document History section of the report.



Title: Exalt EX-2.4i-16 Fixed Link Radio
To: FCC 47 CFR Part15.247 & IC RSS-210
Serial #: EXLT19-A1 Rev A
Issue Date: 28th Feb 2007
Page: 197 of 248

Peak Field Strength Test Results for 2.4 GHz 21.3 dBi Antenna
TABLE OF RESULTS – 72 MHZ BANDWIDTH 16QAM MODULATION

Plot 171 2,437 MHz

Peak Emission = $107.28 + 16 = 123.28$ dB μ V/m

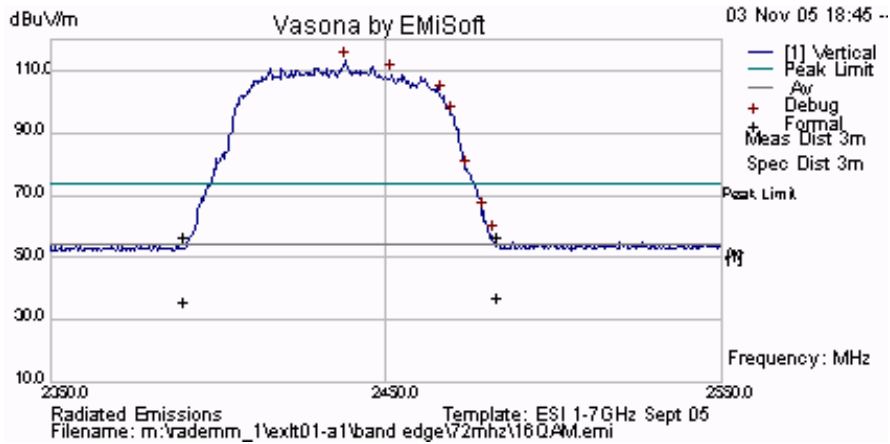

This test report may be reproduced in full only. The document may only be updated by MiCOM Labs personnel. Any changes will be noted in the Document History section of the report.



Peak Field Strength Test Results for 2.4 GHz 21.3 dBi Antenna
TABLE OF RESULTS – 72 MHZ BANDWIDTH 64QAM MODULATION

Plot 172 2,437 MHz

Peak Emission = 106.58 + 16 = 122.58 dB μ V/m

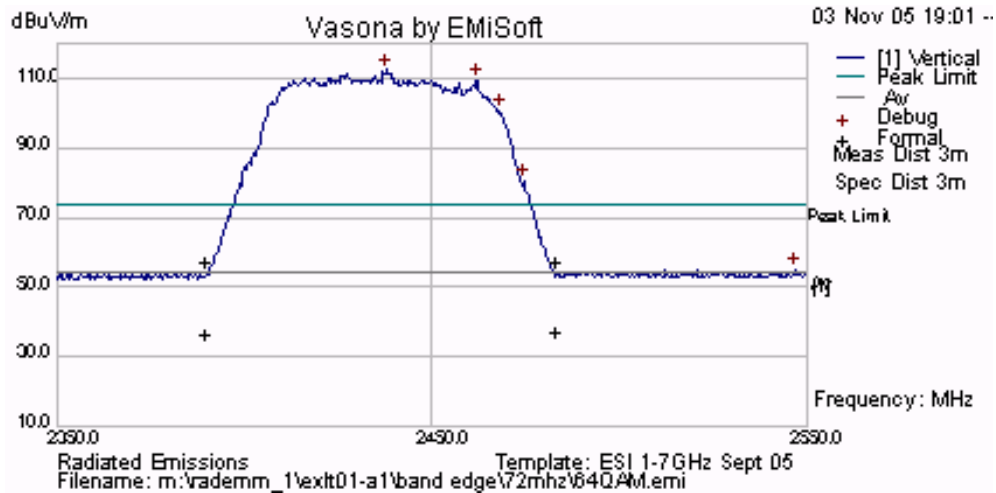

This test report may be reproduced in full only. The document may only be updated by MiCOM Labs personnel. Any changes will be noted in the Document History section of the report.



Peak Field Strength Test Results for 2.4 GHz 30.3 dBi Antenna

TABLE OF RESULTS – 9 MHZ BANDWIDTH QPSK MODULATION

NOTE:

As a result of the output power level and the antenna gain (30.3 dBi) protection of the test equipment was a priority and additional front end attenuation (30dB) was added to the spectrum analyzer. System noise floor is a function of front end analyzer attenuation and not a limiting factor of the EUT.

Power output power was fixed at the highest permissible power level for the 30.3 dBi antenna = +21.9 dBm, see Section 5.1.2 Peak Output Power

Plot 173 2,406 MHz Peak Emission = 125.5 dB μ V/m

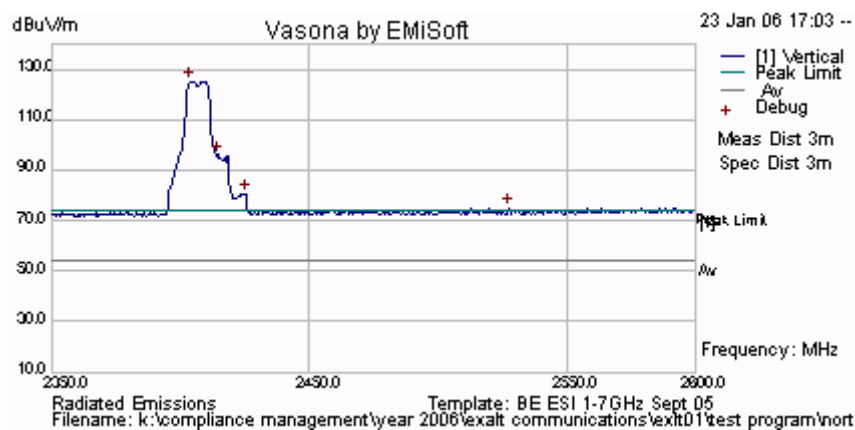

Plot 174 2,468 MHz Peak Emission = 122.57 dB μ V/m

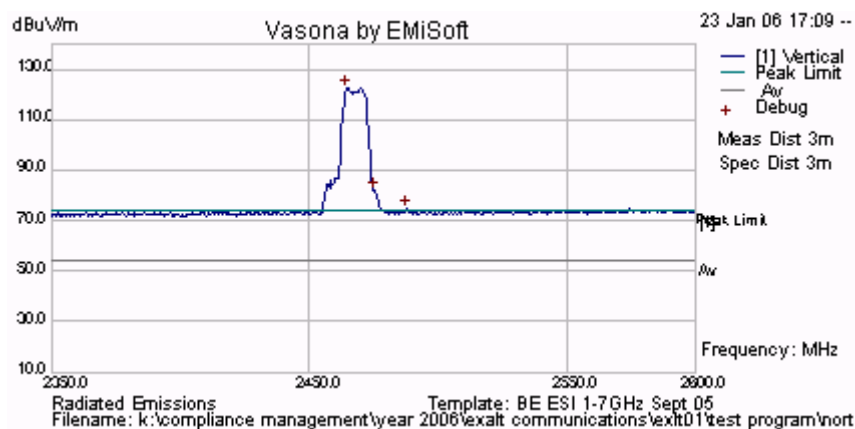

This test report may be reproduced in full only. The document may only be updated by MiCOM Labs personnel. Any changes will be noted in the Document History section of the report.



Title: Exalt EX-2.4i-16 Fixed Link Radio
To: FCC 47 CFR Part15.247 & IC RSS-210
Serial #: EXLT19-A1 Rev A
Issue Date: 28th Feb 2007
Page: 200 of 248

**Peak Field Strength Test Results for 2.4 GHz 30.3 dBi Antenna
TABLE OF RESULTS – 9 MHZ BANDWIDTH 16QAM MODULATION**

Plot 175 2,406 MHz Peak Emission = 125.88 dB μ V/m

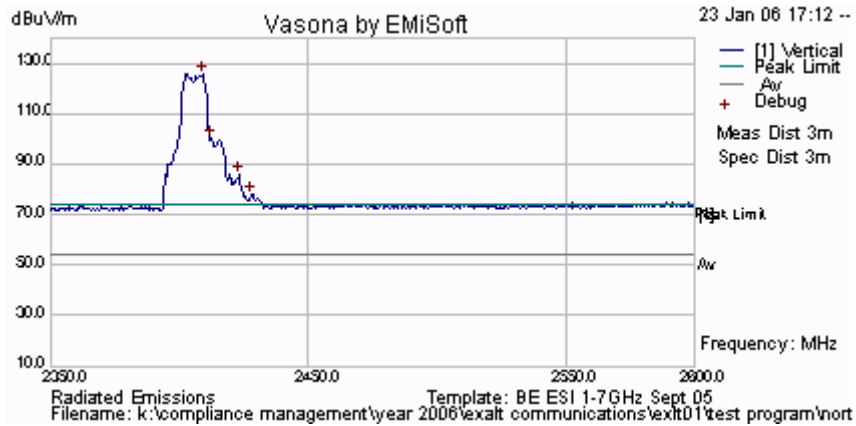

Plot 176 2,468 MHz Peak Emission =122.91 dB μ V/m

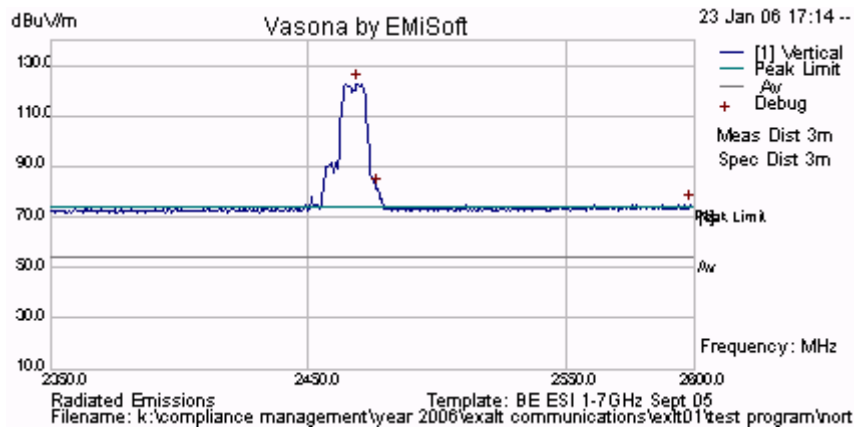

This test report may be reproduced in full only. The document may only be updated by MiCOM Labs personnel. Any changes will be noted in the Document History section of the report.



Title: Exalt EX-2.4i-16 Fixed Link Radio
To: FCC 47 CFR Part15.247 & IC RSS-210
Serial #: EXLT19-A1 Rev A
Issue Date: 28th Feb 2007
Page: 201 of 248

**Peak Field Strength Test Results for 2.4 GHz 30.3 dBi Antenna
TABLE OF RESULTS – 9 MHZ BANDWIDTH 64QAM MODULATION**

Plot 177 2,406 MHz Peak Emission = 126.96 dB μ V/m

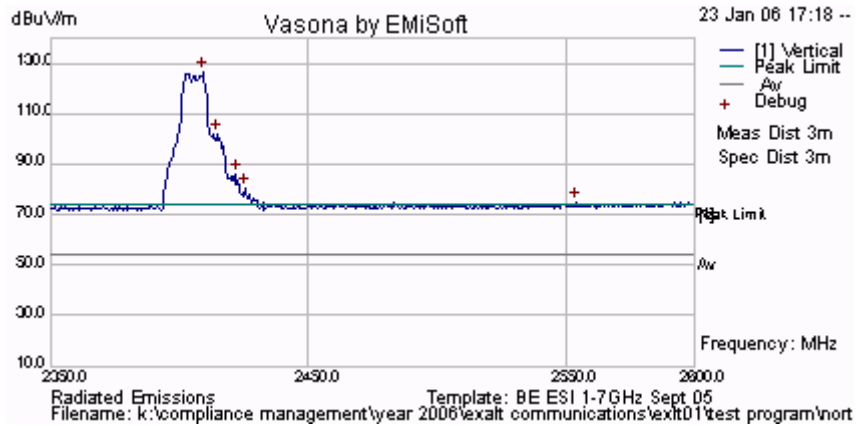

Plot 178 2,468 MHz Peak Emission =124.47 dB μ V/m

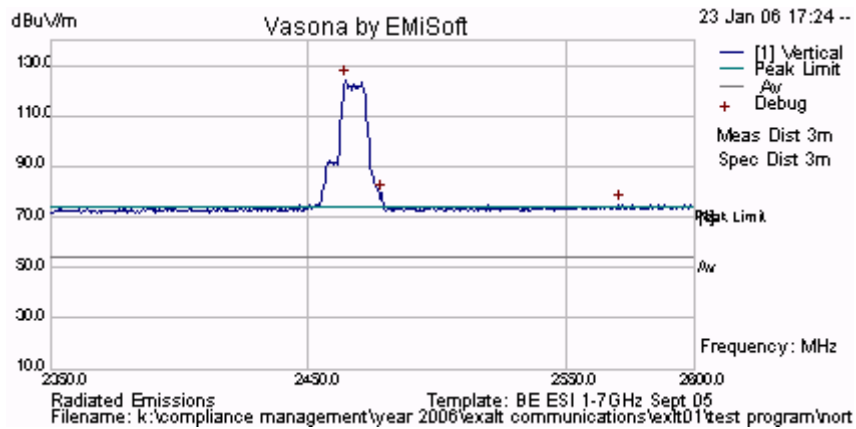

This test report may be reproduced in full only. The document may only be updated by MiCOM Labs personnel. Any changes will be noted in the Document History section of the report.



Peak Field Strength Test Results for 2.4 GHz 30.3 dBi Antenna
TABLE OF RESULTS – 18 MHZ BANDWIDTH QPSK MODULATION

Plot 179 2,417 MHz Peak Emission = 124.76 dB μ V/m

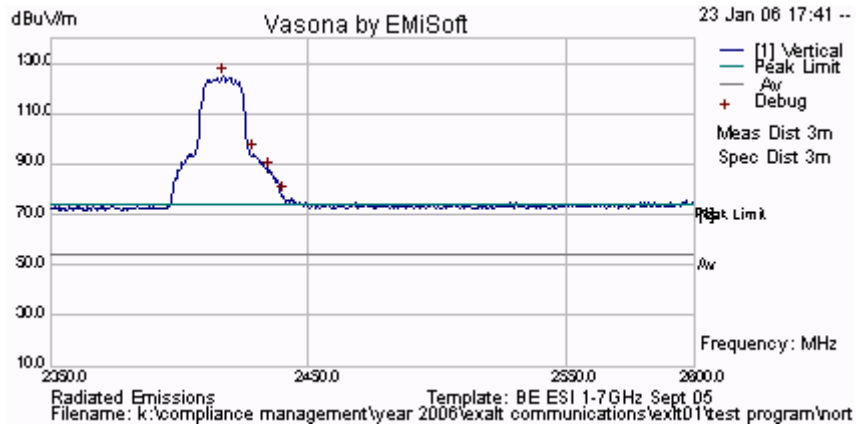

Plot 180 2,465 MHz Peak Emission = 122.99 dB μ V/m

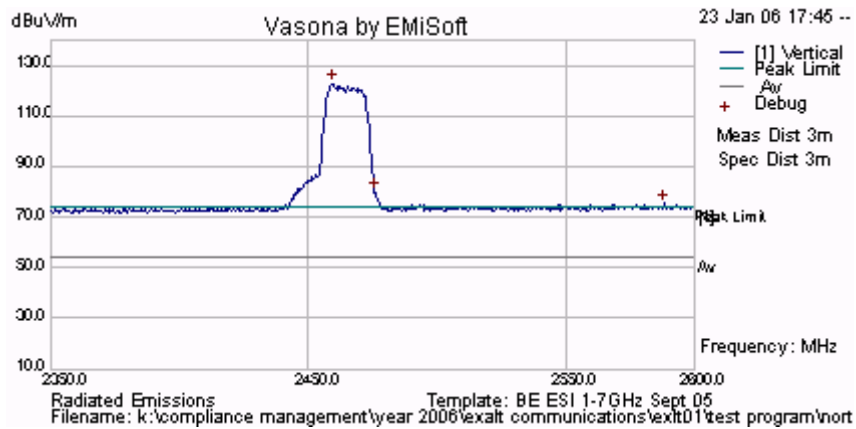

This test report may be reproduced in full only. The document may only be updated by MiCOM Labs personnel. Any changes will be noted in the Document History section of the report.



Peak Field Strength Test Results for 2.4 GHz 30.3 dBi Antenna
TABLE OF RESULTS – 18 MHZ BANDWIDTH 16QAM MODULATION

Plot 181 2,417 MHz Peak Emission = 124.32 dB μ V/m

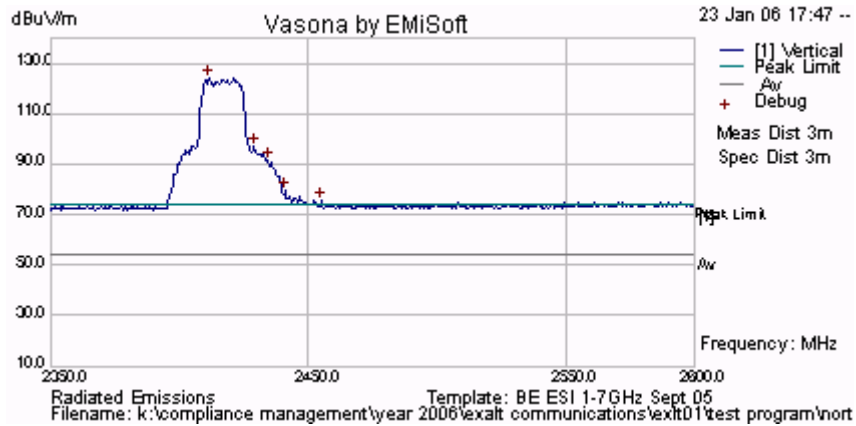

Plot 182 2,465 MHz Peak Emission =121.70 dB μ V/m

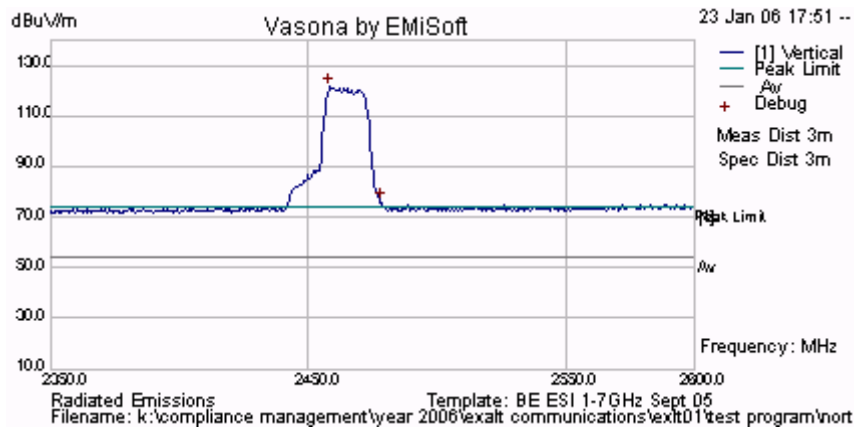

This test report may be reproduced in full only. The document may only be updated by MiCOM Labs personnel. Any changes will be noted in the Document History section of the report.



Peak Field Strength Test Results for 2.4 GHz 30.3 dBi Antenna
TABLE OF RESULTS – 18 MHZ BANDWIDTH 64QAM MODULATION

Plot 183 2,417 MHz Peak Emission = 124.63 dB μ V/m

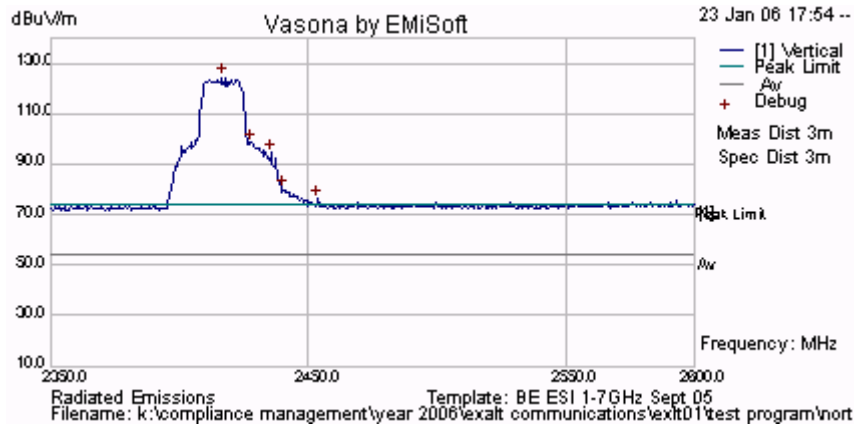

Plot 184 2,465 MHz Peak Emission =122.48 dB μ V/m

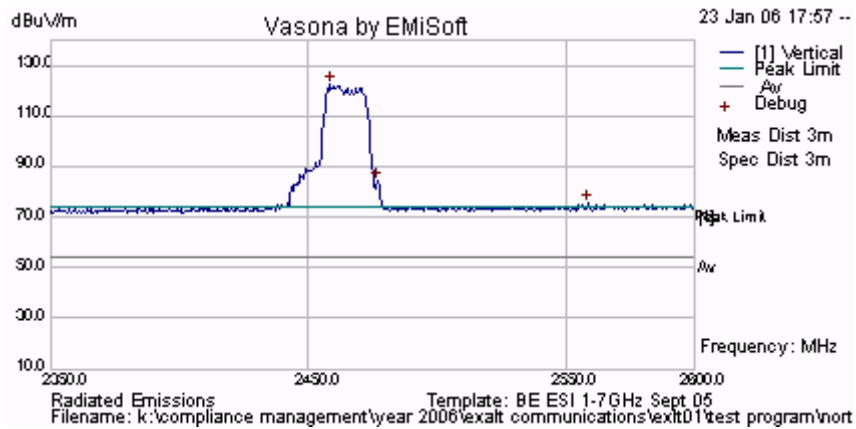

This test report may be reproduced in full only. The document may only be updated by MiCOM Labs personnel. Any changes will be noted in the Document History section of the report.



Peak Field Strength Test Results for 2.4 GHz 30.3 dBi Antenna
TABLE OF RESULTS – 36 MHZ BANDWIDTH QPSK MODULATION

Plot 185 2,426 MHz Peak Emission = 122.29 dB μ V/m

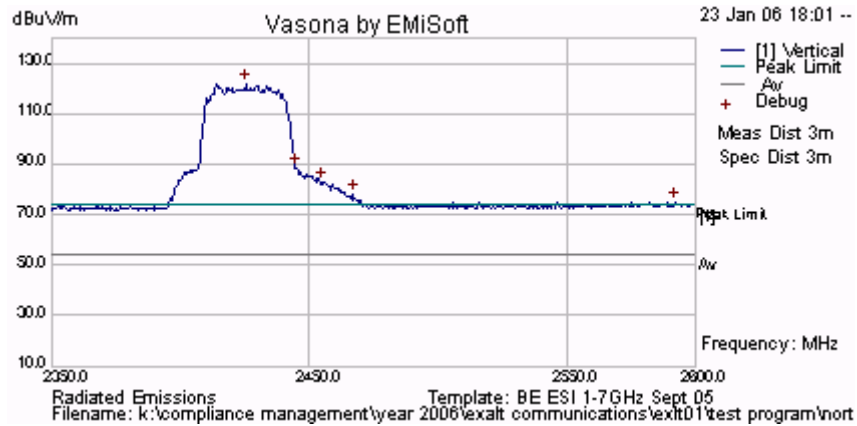

Plot 186 2,455 MHz Peak Emission = 122.54 dB μ V/m

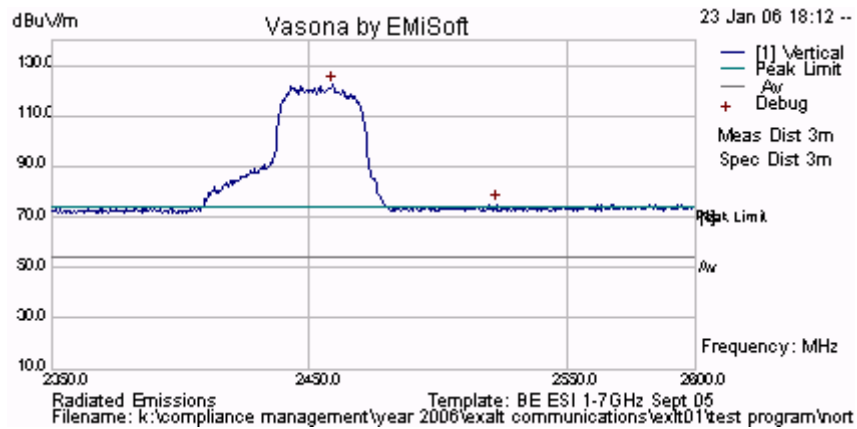

This test report may be reproduced in full only. The document may only be updated by MiCOM Labs personnel. Any changes will be noted in the Document History section of the report.



Peak Field Strength Test Results for 2.4 GHz 30.3 dBi Antenna
TABLE OF RESULTS – 36 MHZ BANDWIDTH 16QAM MODULATION

Plot 187 2,426 MHz Peak Emission = 124.04 dBμV/m

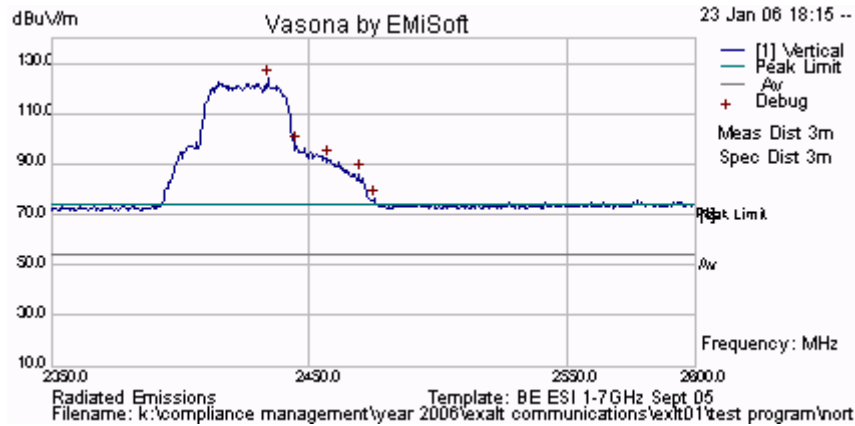

Plot 188 2,455 MHz Peak Emission = 122.49 dBμV/m

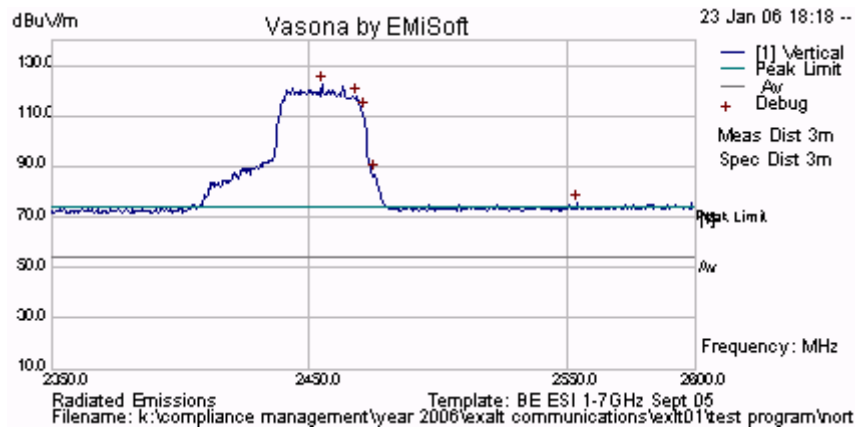

This test report may be reproduced in full only. The document may only be updated by MiCOM Labs personnel. Any changes will be noted in the Document History section of the report.



Title: Exalt EX-2.4i-16 Fixed Link Radio
To: FCC 47 CFR Part15.247 & IC RSS-210
Serial #: EXLT19-A1 Rev A
Issue Date: 28th Feb 2007
Page: 207 of 248

Peak Field Strength Test Results for 2.4 GHz 30.3 dBi Antenna
TABLE OF RESULTS – 36 MHZ BANDWIDTH 64QAM MODULATION

Plot 189 2,426 MHz Peak Emission = 123.03 dB μ V/m

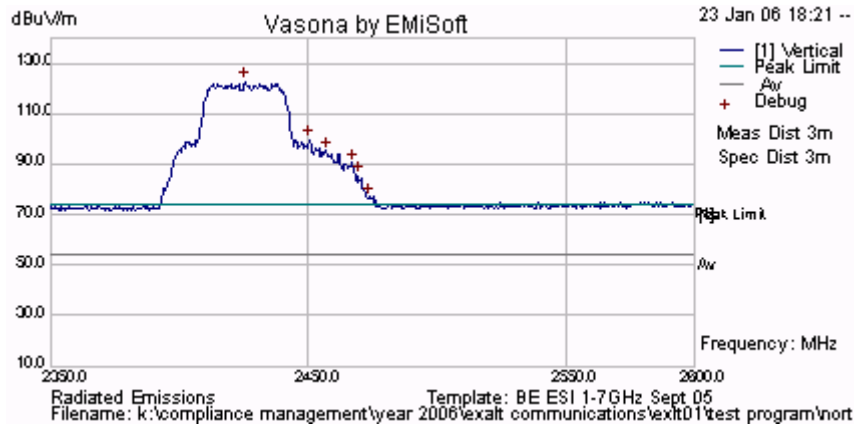

Plot 190 2,455 MHz Peak Emission = 122.05 dB μ V/m

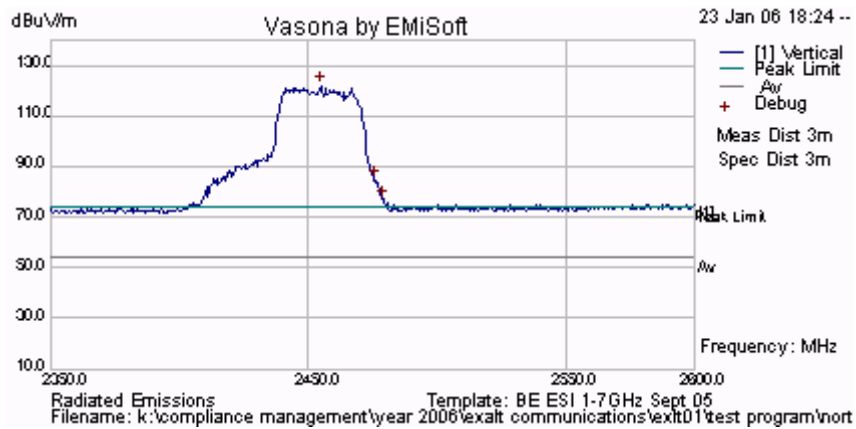

This test report may be reproduced in full only. The document may only be updated by MiCOM Labs personnel. Any changes will be noted in the Document History section of the report.



Title: Exalt EX-2.4i-16 Fixed Link Radio
To: FCC 47 CFR Part15.247 & IC RSS-210
Serial #: EXLT19-A1 Rev A
Issue Date: 28th Feb 2007
Page: 208 of 248

Peak Field Strength Test Results for 2.4 GHz 30.3 dBi Antenna
TABLE OF RESULTS – 72 MHZ BANDWIDTH QPSK MODULATION

Plot 191 2,437 MHz - Peak Emission = 120.16 dB μ V/m

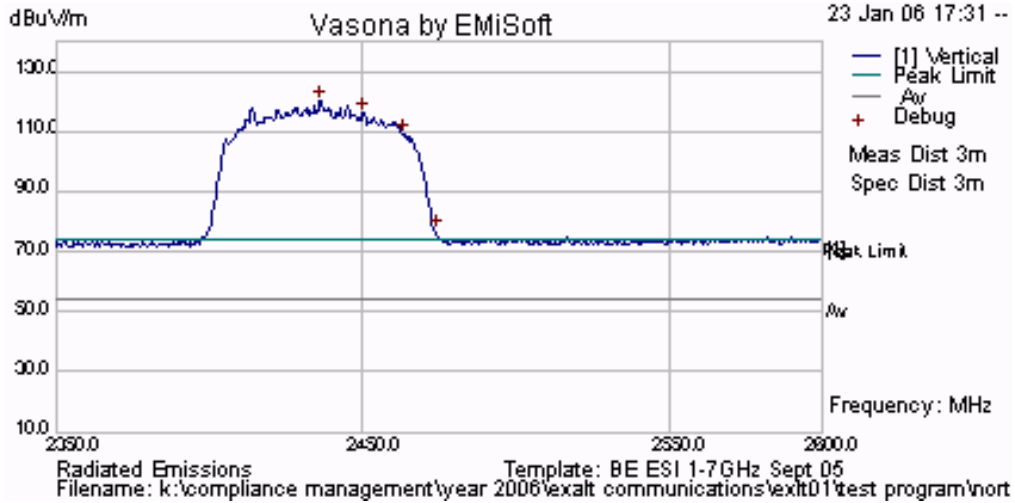

This test report may be reproduced in full only. The document may only be updated by MiCOM Labs personnel. Any changes will be noted in the Document History section of the report.



Title: Exalt EX-2.4i-16 Fixed Link Radio
To: FCC 47 CFR Part15.247 & IC RSS-210
Serial #: EXLT19-A1 Rev A
Issue Date: 28th Feb 2007
Page: 209 of 248

Peak Field Strength Test Results for 2.4 GHz 30.3 dBi Antenna
TABLE OF RESULTS – 72 MHZ BANDWIDTH 16QAM MODULATION

Plot 192 2,437 MHz - Peak Emission = 119.16 dB μ V/m

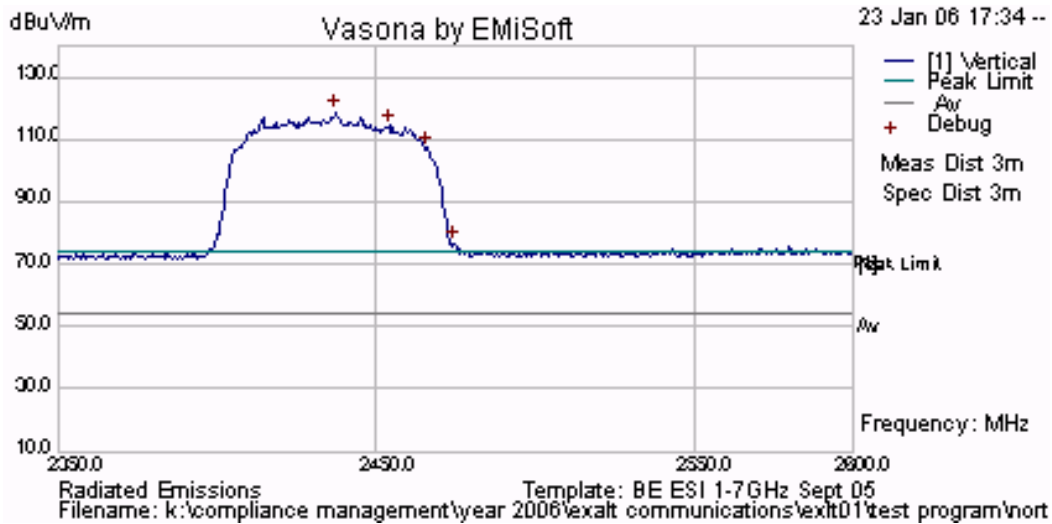

This test report may be reproduced in full only. The document may only be updated by MiCOM Labs personnel. Any changes will be noted in the Document History section of the report.



Title: Exalt EX-2.4i-16 Fixed Link Radio
To: FCC 47 CFR Part15.247 & IC RSS-210
Serial #: EXLT19-A1 Rev A
Issue Date: 28th Feb 2007
Page: 210 of 248

Peak Field Strength Test Results for 2.4 GHz 30.3 dBi Antenna
TABLE OF RESULTS – 72 MHZ BANDWIDTH 64QAM MODULATION

Plot 193 2,437 MHz - Peak Emission = 119.33 dB μ V/m

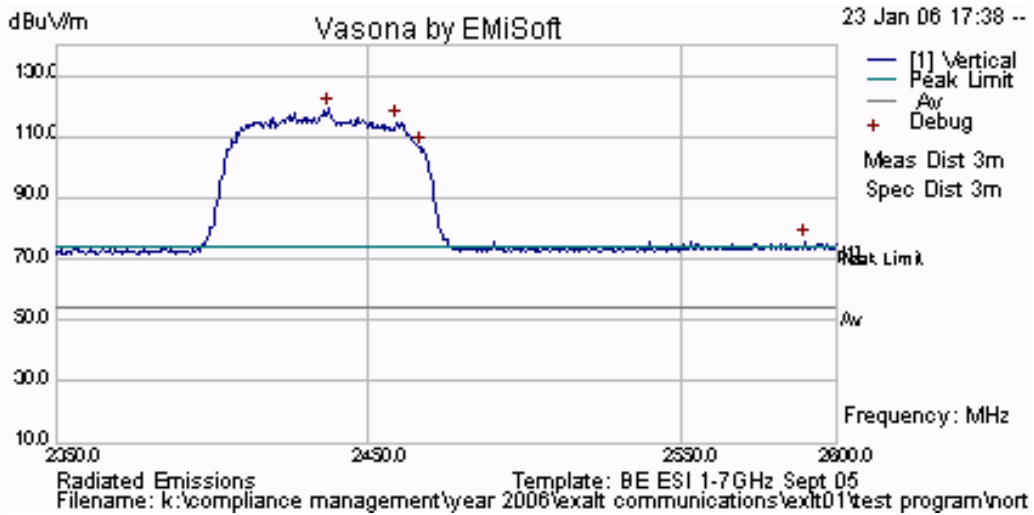

This test report may be reproduced in full only. The document may only be updated by MiCOM Labs personnel. Any changes will be noted in the Document History section of the report.



Peak Field Strength Test Results for 2.4 GHz 20 dBi Antenna

NOTE:

As a result of the output power level and the antenna gain (20 dBi) protection of the test equipment was a priority and additional front end attenuation (30dB) was added to the spectrum analyzer. System noise floor is a function of front end analyzer attenuation and not a limiting factor of the EUT.

Power output power was fixed at the highest permissible power level for the 20 dBi antenna = +25.3 dBm, see Section 5.1.2 Peak Output Power

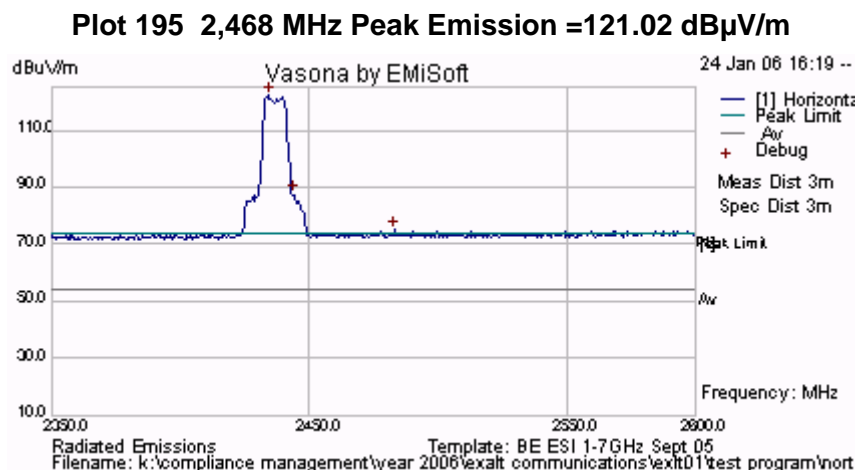
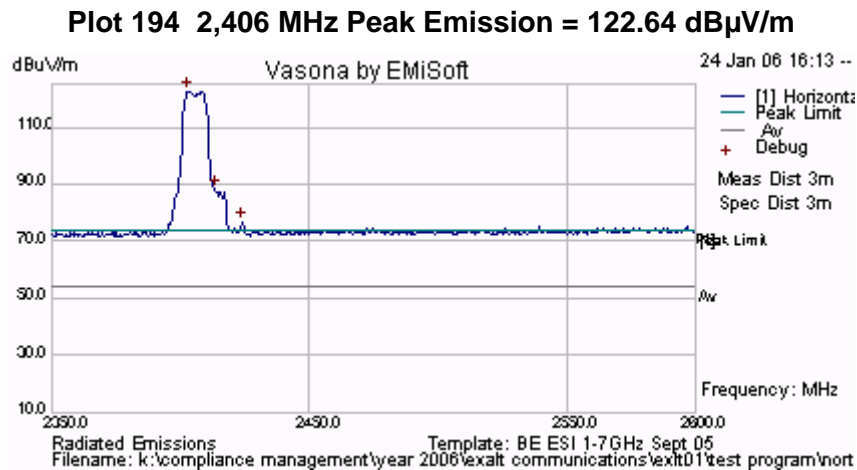

This test report may be reproduced in full only. The document may only be updated by MiCOM Labs personnel. Any changes will be noted in the Document History section of the report.



Title: Exalt EX-2.4i-16 Fixed Link Radio
To: FCC 47 CFR Part15.247 & IC RSS-210
Serial #: EXLT19-A1 Rev A
Issue Date: 28th Feb 2007
Page: 212 of 248

Peak Field Strength Test Results for 2.4 GHz 20 dBi Antenna

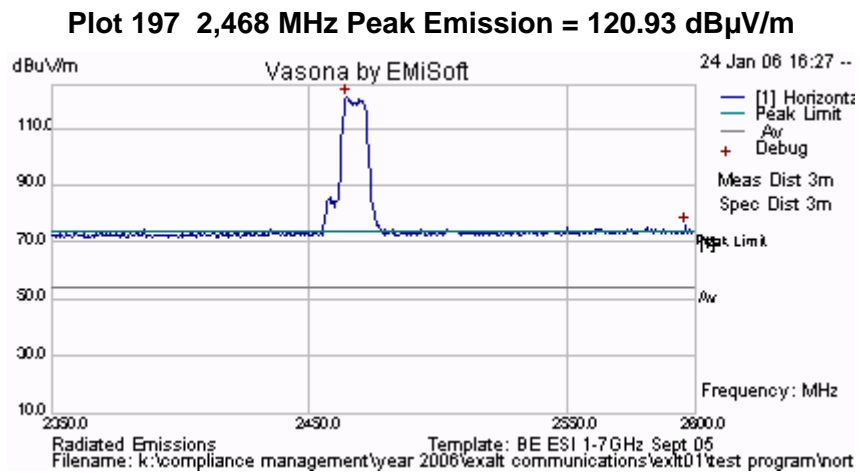
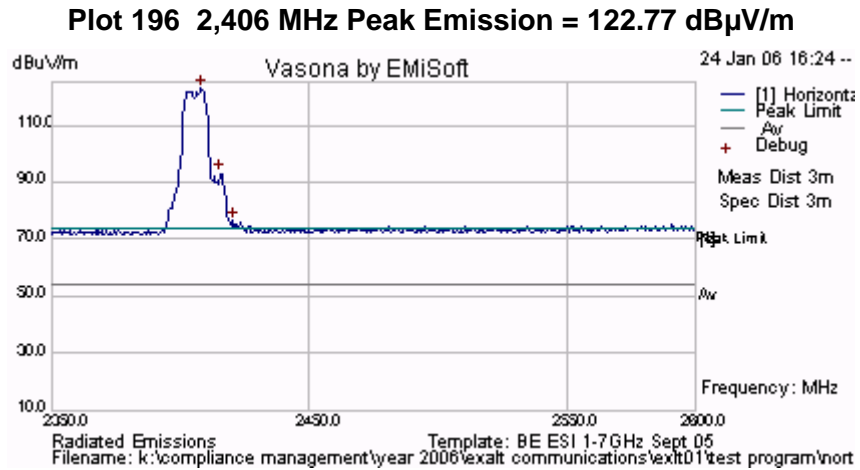

This test report may be reproduced in full only. The document may only be updated by MiCOM Labs personnel. Any changes will be noted in the Document History section of the report.



Title: Exalt EX-2.4i-16 Fixed Link Radio
To: FCC 47 CFR Part15.247 & IC RSS-210
Serial #: EXLT19-A1 Rev A
Issue Date: 28th Feb 2007
Page: 213 of 248

Peak Field Strength Test Results for 2.4 GHz 20 dBi Antenna

Plot 198 2,406 MHz Peak Emission = 123.09 dB μ V/m

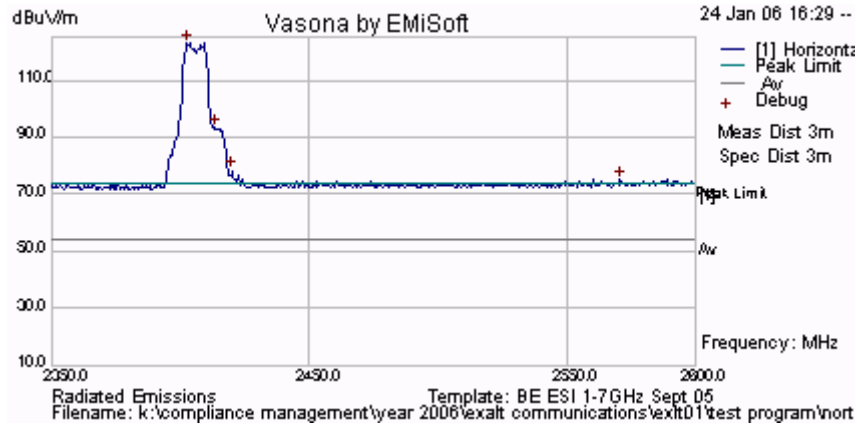

Plot 199 2,468 MHz Peak Emission = 121.76 dB μ V/m

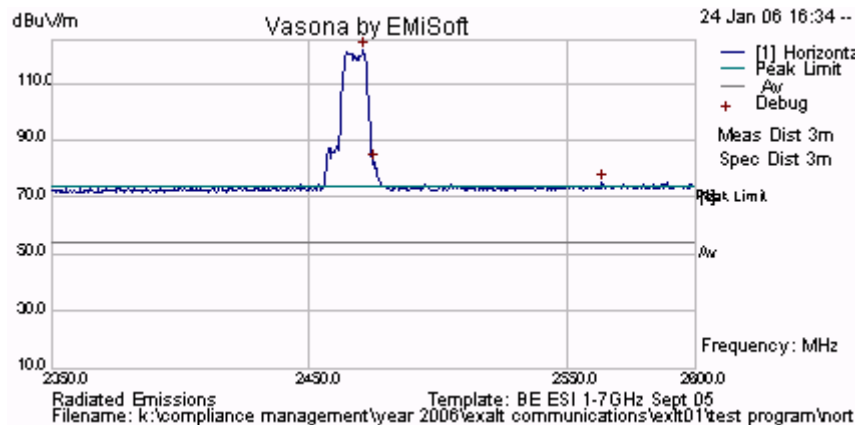

This test report may be reproduced in full only. The document may only be updated by MiCOM Labs personnel. Any changes will be noted in the Document History section of the report.



Title: Exalt EX-2.4i-16 Fixed Link Radio
To: FCC 47 CFR Part15.247 & IC RSS-210
Serial #: EXLT19-A1 Rev A
Issue Date: 28th Feb 2007
Page: 214 of 248

Peak Field Strength Test Results for 2.4 GHz 20 dBi Antenna

Plot 200 2,417 MHz Peak Emission = 121.41 dB μ V/m

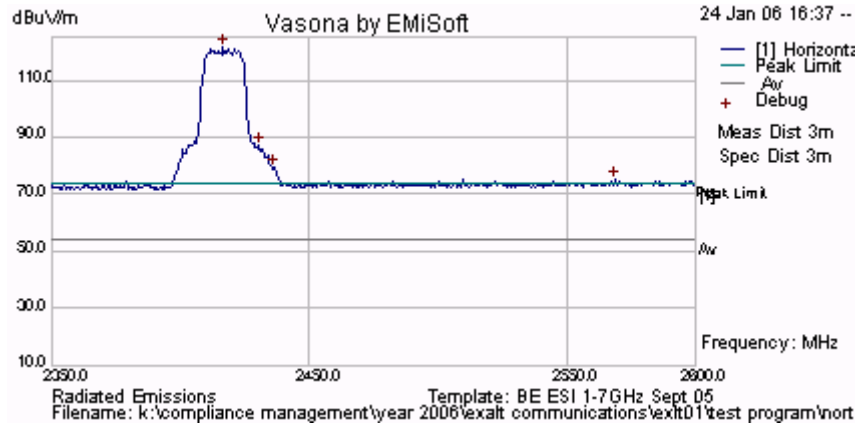

Plot 201 2,465 MHz Peak Emission = 119.54 dB μ V/m

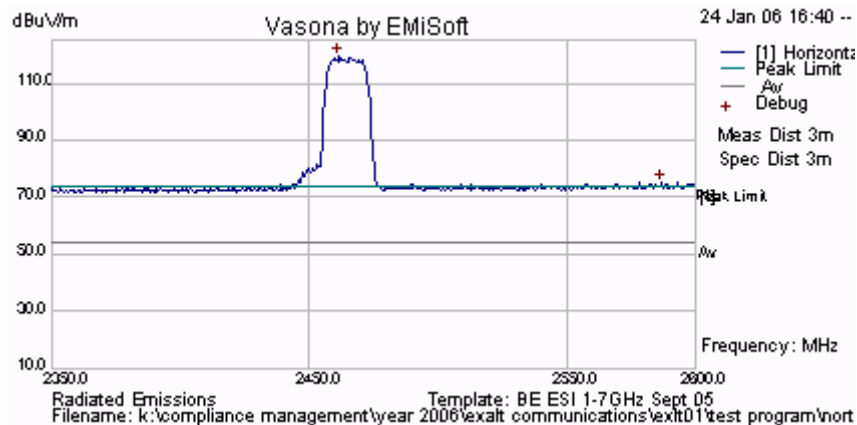

This test report may be reproduced in full only. The document may only be updated by MiCOM Labs personnel. Any changes will be noted in the Document History section of the report.



Title: Exalt EX-2.4i-16 Fixed Link Radio
To: FCC 47 CFR Part15.247 & IC RSS-210
Serial #: EXLT19-A1 Rev A
Issue Date: 28th Feb 2007
Page: 215 of 248

Peak Field Strength Test Results for 2.4 GHz 20 dBi Antenna

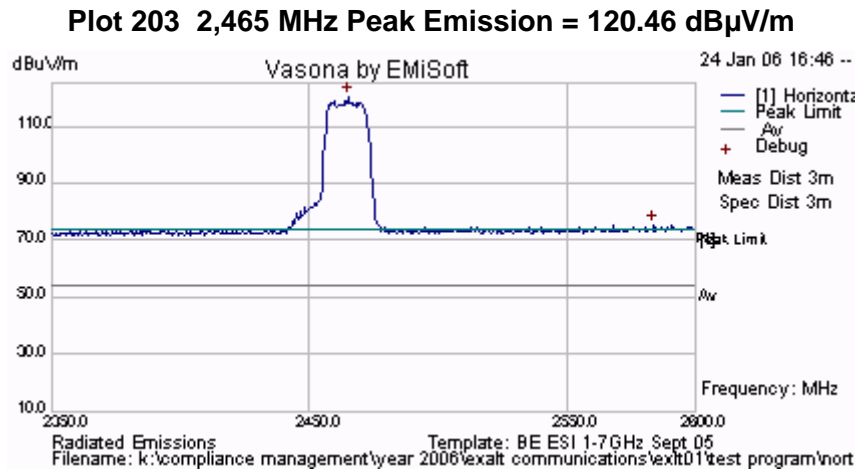
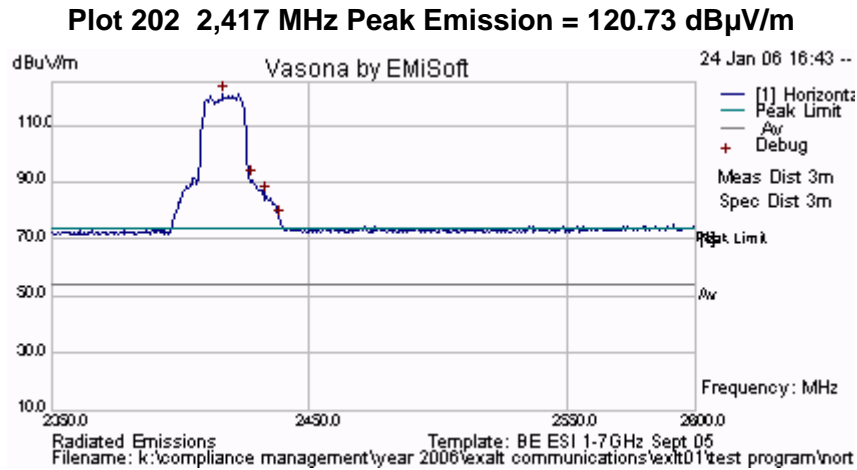

This test report may be reproduced in full only. The document may only be updated by MiCOM Labs personnel. Any changes will be noted in the Document History section of the report.



Title: Exalt EX-2.4i-16 Fixed Link Radio
To: FCC 47 CFR Part15.247 & IC RSS-210
Serial #: EXLT19-A1 Rev A
Issue Date: 28th Feb 2007
Page: 216 of 248

Peak Field Strength Test Results for 2.4 GHz 20 dBi Antenna

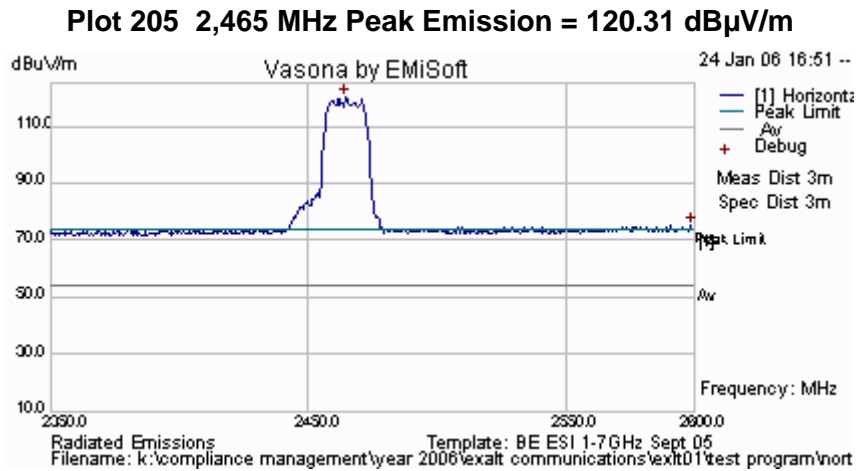
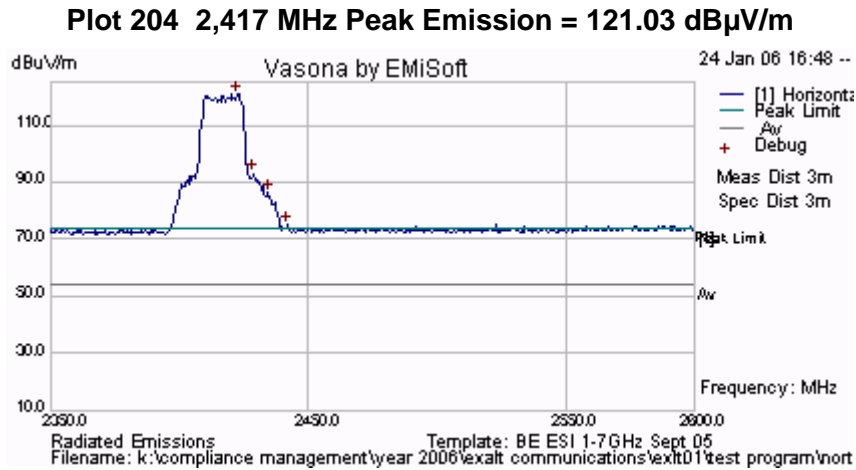

This test report may be reproduced in full only. The document may only be updated by MiCOM Labs personnel. Any changes will be noted in the Document History section of the report.



Peak Field Strength Test Results for 2.4 GHz 20 dBi Antenna

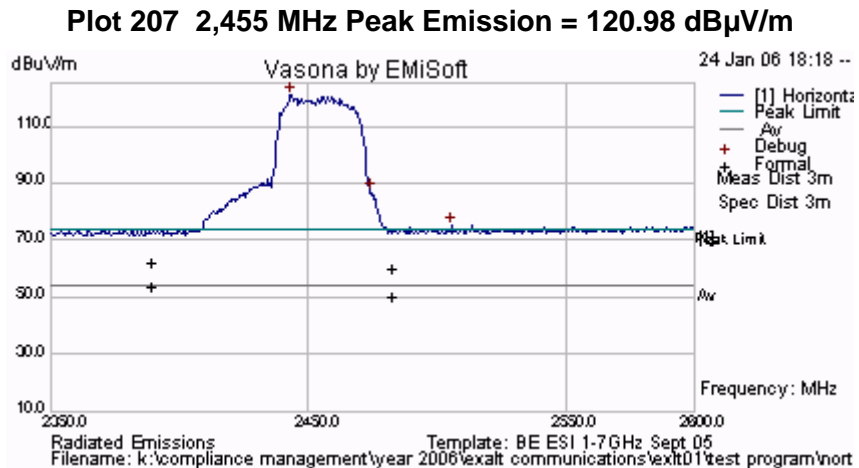
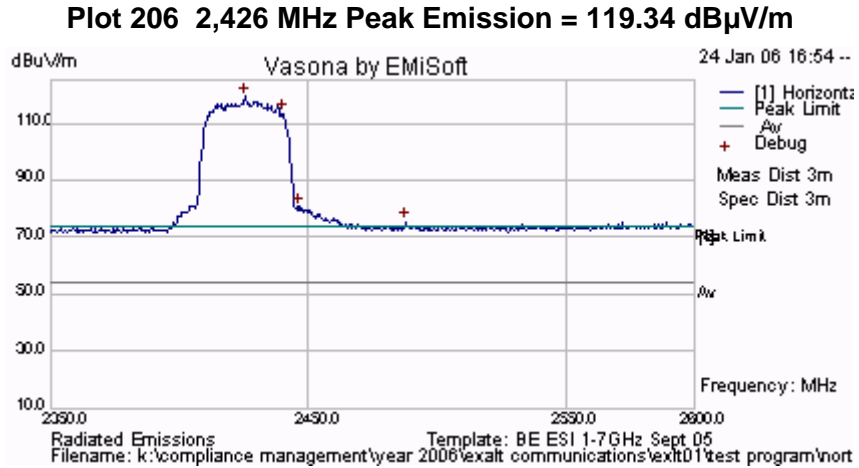

This test report may be reproduced in full only. The document may only be updated by MiCOM Labs personnel. Any changes will be noted in the Document History section of the report.



Title: Exalt EX-2.4i-16 Fixed Link Radio
To: FCC 47 CFR Part15.247 & IC RSS-210
Serial #: EXLT19-A1 Rev A
Issue Date: 28th Feb 2007
Page: 218 of 248

Peak Field Strength Test Results for 2.4 GHz 20 dBi Antenna

Plot 208 2,426 MHz Peak Emission = 122.78 dB μ V/m

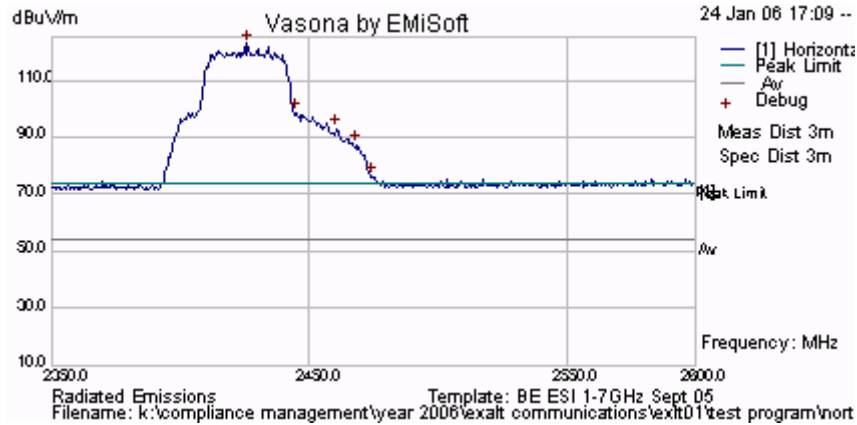

Plot 209 2,455 MHz Peak Emission = 121.12 dB μ V/m

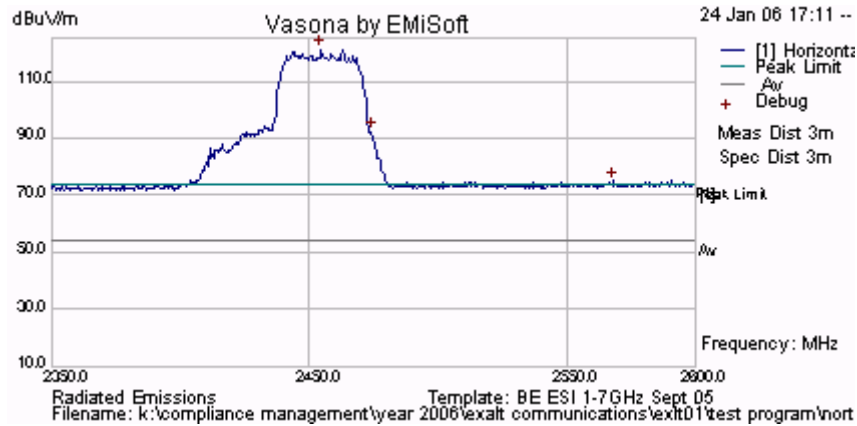

This test report may be reproduced in full only. The document may only be updated by MiCOM Labs personnel. Any changes will be noted in the Document History section of the report.



Title: Exalt EX-2.4i-16 Fixed Link Radio
To: FCC 47 CFR Part15.247 & IC RSS-210
Serial #: EXLT19-A1 Rev A
Issue Date: 28th Feb 2007
Page: 219 of 248

Peak Field Strength Test Results for 2.4 GHz 20 dBi Antenna

Plot 210 2,426 MHz Peak Emission = 122.58 dB μ V/m

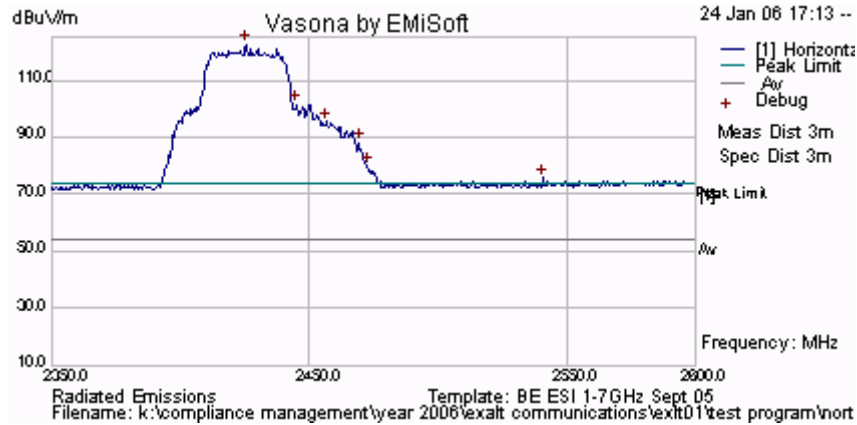

Plot 211 2,455 MHz Peak Emission = 120.67 dB μ V/m

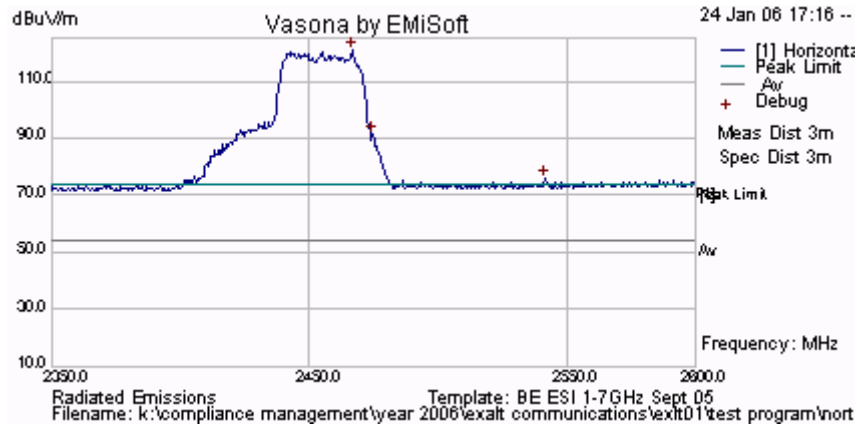

This test report may be reproduced in full only. The document may only be updated by MiCOM Labs personnel. Any changes will be noted in the Document History section of the report.



Title: Exalt EX-2.4i-16 Fixed Link Radio
To: FCC 47 CFR Part15.247 & IC RSS-210
Serial #: EXLT19-A1 Rev A
Issue Date: 28th Feb 2007
Page: 220 of 248

Peak Field Strength Test Results for 2.4 GHz 20 dBi Antenna

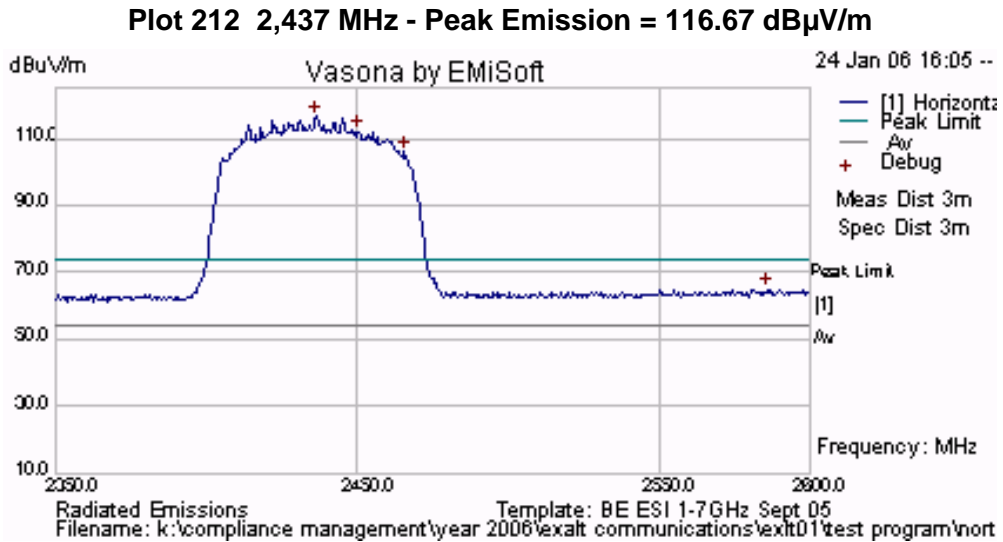

This test report may be reproduced in full only. The document may only be updated by MiCOM Labs personnel. Any changes will be noted in the Document History section of the report.



Title: Exalt EX-2.4i-16 Fixed Link Radio
To: FCC 47 CFR Part15.247 & IC RSS-210
Serial #: EXLT19-A1 Rev A
Issue Date: 28th Feb 2007
Page: 221 of 248

Peak Field Strength Test Results for 2.4 GHz 20 dBi Antenna

Plot 213 2,437 MHz - Peak Emission = 115.97 dB μ V/m

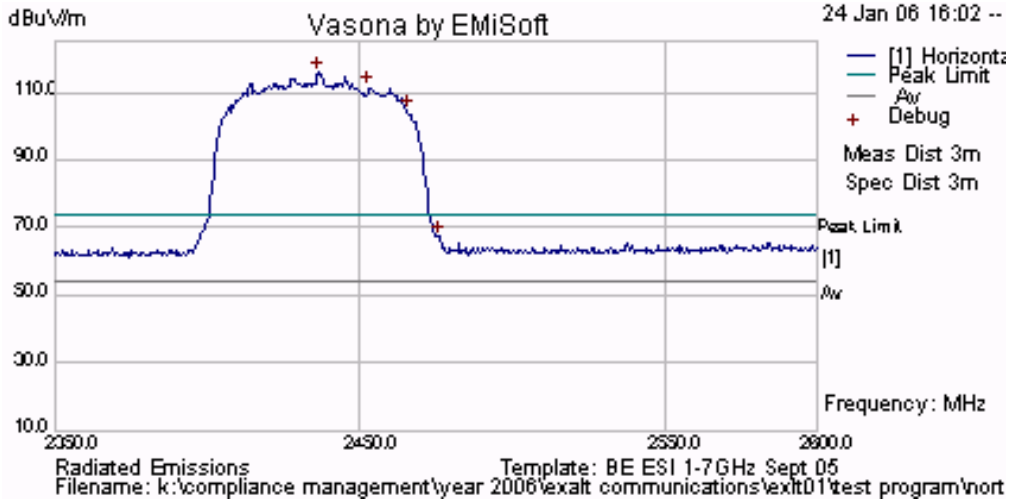

This test report may be reproduced in full only. The document may only be updated by MiCOM Labs personnel. Any changes will be noted in the Document History section of the report.



Title: Exalt EX-2.4i-16 Fixed Link Radio
To: FCC 47 CFR Part15.247 & IC RSS-210
Serial #: EXLT19-A1 Rev A
Issue Date: 28th Feb 2007
Page: 222 of 248

Peak Field Strength Test Results for 2.4 GHz 20 dBi Antenna

Plot 214 2,437 MHz - Peak Emission = 115.04 dB μ V/m

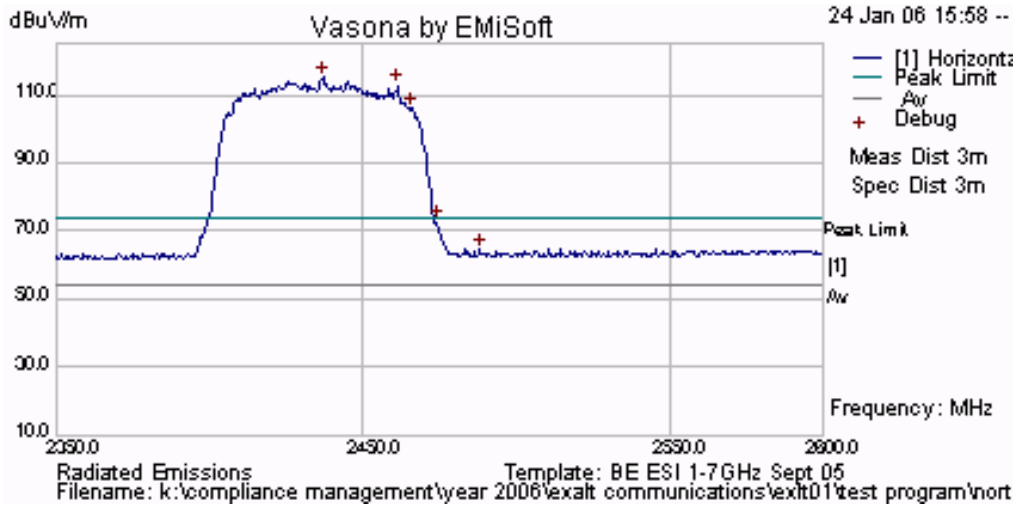

This test report may be reproduced in full only. The document may only be updated by MiCOM Labs personnel. Any changes will be noted in the Document History section of the report.



5.1.6.4. Radiated Band-Edge – Restricted Bands

Radiated Band Edge Test Results for 2.4 GHz 21.3 dBi Antenna

TABLE OF RESULTS – 9 MHZ BANDWIDTH QPSK MODULATION

Tx Pwr (dBm)	Tx Freq. (MHz)	Restricted Band Edge Frequency (MHz)	Measured (dBuV/m)	Limit (dBuV/m)	Margin (dB)
+24.9	2,406 _{PEAK}	2,390	69.46	74	-4.54
	2,406 _{AVE}	2,390	48.42	54	-5.58
	2,468 _{PEAK}	2,483.5	69.90	74	-4.10
	2,468 _{AVE}	2,483.5	49.37	54	-4.63

TABLE OF RESULTS – 9 MHZ BANDWIDTH 16QAM MODULATION

Tx Pwr (dBm)	Tx Freq. (MHz)	Restricted Band Edge Frequency (MHz)	Measured (dBuV/m)	Limit (dBuV/m)	Margin (dB)
+24.9	2,406 _{PEAK}	2,390	70.13	74	-3.87
	2,406 _{AVE}	2,390	48.42	54	-5.58
	2,468 _{PEAK}	2,483.5	69.76	74	-4.24
	2,468 _{AVE}	2,483.5	49.27	54	-4.73

TABLE OF RESULTS – 9 MHZ BANDWIDTH 64QAM MODULATION

Tx Pwr (dBm)	Tx Freq. (MHz)	Restricted Band Edge Frequency (MHz)	Measured (dBuV/m)	Limit (dBuV/m)	Margin (dB)
+24.9	2,406 _{PEAK}	2,390	69.33	74	-4.67
	2,406 _{AVE}	2,390	48.42	54	-5.58
	2,468 _{PEAK}	2,483.5	70.17	74	-3.83
	2,468 _{AVE}	2,483.5	49.37	54	-4.63

This test report may be reproduced in full only. The document may only be updated by MiCOM Labs personnel. Any changes will be noted in the Document History section of the report.



Radiated Band Edge Test Results for 2.4 GHz 21.3 dBi Antenna

TABLE OF RESULTS – 18 MHZ BANDWIDTH QPSK MODULATION

Tx Pwr (dBm)	Tx Freq. (MHz)	Restricted Band Edge Frequency (MHz)	Measured (dBuV/m)	Limit (dBuV/m)	Margin (dB)
+24.9	2,417 _{PEAK}	2,390	69.73	74	-4.27
	2,417 _{AVE}	2,390	48.42	54	-5.58
	2,465 _{PEAK}	2,483.5	70.30	74	-3.70
	2,465 _{AVE}	2,483.5	49.27	54	-4.73

TABLE OF RESULTS – 18 MHZ BANDWIDTH 16QAM MODULATION

Tx Pwr (dBm)	Tx Freq. (MHz)	Restricted Band Edge Frequency (MHz)	Measured (dBuV/m)	Limit (dBuV/m)	Margin (dB)
+24.9	2,417 _{PEAK}	2,390	69.07	74	-4.93
	2,417 _{AVE}	2,390	48.42	54	-5.58
	2,465 _{PEAK}	2,483.5	69.76	74	-4.24
	2,465 _{AVE}	2,483.5	49.27	54	-4.73

TABLE OF RESULTS – 18 MHZ BANDWIDTH 64QAM MODULATION

Tx Pwr (dBm)	Tx Freq. (MHz)	Restricted Band Edge Frequency (MHz)	Measured (dBuV/m)	Limit (dBuV/m)	Margin (dB)
+24.9	2,417 _{PEAK}	2,390	69.07	74	-4.93
	2,417 _{AVE}	2,390	48.42	54	-5.58
	2,465 _{PEAK}	2,483.5	60.03	74	-3.97
	2,465 _{AVE}	2,483.5	49.37	54	-4.63

This test report may be reproduced in full only. The document may only be updated by MiCOM Labs personnel. Any changes will be noted in the Document History section of the report.



Radiated Band Edge Test Results for 2.4 GHz 21.3 dBi Antenna
TABLE OF RESULTS – 36 MHZ BANDWIDTH QPSK MODULATION

Tx Pwr (dBm)	Tx Freq. (MHz)	Restricted Band Edge Frequency (MHz)	Measured (dBuV/m)	Limit (dBuV/m)	Margin (dB)
+24.9	2,426 _{PEAK}	2,390	63.73	74	-10.27
	2,426 _{AVE}	2,390	42.42	54	-11.58
	2,455 _{PEAK}	2,483.5	63.76	74	-10.24
	2,455 _{AVE}	2,483.5	43.27	54	-10.73

TABLE OF RESULTS – 36 MHZ BANDWIDTH 16QAM MODULATION

Tx Pwr (dBm)	Tx Freq. (MHz)	Restricted Band Edge Frequency (MHz)	Measured (dBuV/m)	Limit (dBuV/m)	Margin (dB)
+24.9	2,426 _{PEAK}	2,390	63.07	74	-10.93
	2,426 _{AVE}	2,390	42.42	54	-11.58
	2,455 _{PEAK}	2,483.5	64.03	74	-9.97
	2,455 _{AVE}	2,483.5	43.37	54	-10.63

TABLE OF RESULTS – 36 MHZ BANDWIDTH 64QAM MODULATION

Tx Pwr (dBm)	Tx Freq. (MHz)	Restricted Band Edge Frequency (MHz)	Measured (dBuV/m)	Limit (dBuV/m)	Margin (dB)
+24.9	2,426 _{PEAK}	2,390	63.59	74	-10.41
	2,426 _{AVE}	2,390	42.42	54	-11.58
	2,455 _{PEAK}	2,483.5	64.03	74	-9.97
	2,455 _{AVE}	2,483.5	43.27	54	-10.73

This test report may be reproduced in full only. The document may only be updated by MiCOM Labs personnel. Any changes will be noted in the Document History section of the report.



Radiated Band Edge Test Results for 2.4 GHz 21.3 dBi Antenna

TABLE OF RESULTS – 72 MHZ BANDWIDTH QPSK MODULATION

Tx Pwr (dBm)	Tx Freq. (MHz)	Restricted Band Edge Frequency (MHz)	Measured (dBuV/m)	Limit (dBuV/m)	Margin (dB)
+24.9	2,437 _{PEAK}	2,390	63.46	74	-10.54
	2,437 _{AVE}	2,390	42.42	54	-11.58
	2,437 _{PEAK}	2,483.5	64.44	74	-9.56
	2,437 _{AVE}	2,483.5	43.37	54	-10.63

TABLE OF RESULTS – 72 MHZ BANDWIDTH 16QAM MODULATION

Tx Pwr (dBm)	Tx Freq. (MHz)	Restricted Band Edge Frequency (MHz)	Measured (dBuV/m)	Limit (dBuV/m)	Margin (dB)
+24.9	2,437 _{PEAK}	2,390	63.07	74	-10.93
	2,437 _{AVE}	2,390	42.42	54	-11.58
	2,437 _{PEAK}	2,483.5	63.50	74	-10.50
	2,437 _{AVE}	2,483.5	43.37	54	-10.63

TABLE OF RESULTS – 72 MHZ BANDWIDTH 64QAM MODULATION

Tx Pwr (dBm)	Tx Freq. (MHz)	Restricted Band Edge Frequency (MHz)	Measured (dBuV/m)	Limit (dBuV/m)	Margin (dB)
+24.9	2,437 _{PEAK}	2,390	63.86	74	-10.14
	2,437 _{AVE}	2,390	42.99	54	-11.01
	2,437 _{PEAK}	2,483.5	63.90	74	-10.10
	2,437 _{AVE}	2,483.5	43.48	54	-10.52

This test report may be reproduced in full only. The document may only be updated by MiCOM Labs personnel. Any changes will be noted in the Document History section of the report.



Radiated Band Edge Test Results for 2.4 GHz 30.3 dBi Antenna

TABLE OF RESULTS – 9 MHZ BANDWIDTH QPSK MODULATION

Tx Pwr (dBm)	Tx Freq. (MHz)	Restricted Band Edge Frequency (MHz)	Measured (dBuV/m)	Limit (dBuV/m)	Margin (dB)
+21.9	2,406 _{PEAK}	2,390	53.24	74	-20.76
	2,406 _{AVE}	2,390	44.23	54	-9.77
	2,468 _{PEAK}	2,483.5	52.13	74	-21.87
	2,468 _{AVE}	2,483.5	41.83	54	-12.17

TABLE OF RESULTS – 9 MHZ BANDWIDTH 16QAM MODULATION

Tx Pwr (dBm)	Tx Freq. (MHz)	Restricted Band Edge Frequency (MHz)	Measured (dBuV/m)	Limit (dBuV/m)	Margin (dB)
+21.9	2,406 _{PEAK}	2,390	56.51	74	-17.49
	2,406 _{AVE}	2,390	45.62	54	-8.38
	2,468 _{PEAK}	2,483.5	51.93	74	-22.07
	2,468 _{AVE}	2,483.5	43.67	54	-10.33

TABLE OF RESULTS – 9 MHZ BANDWIDTH 64QAM MODULATION

Tx Pwr (dBm)	Tx Freq. (MHz)	Restricted Band Edge Frequency (MHz)	Measured (dBuV/m)	Limit (dBuV/m)	Margin (dB)
+21.9	2,406 _{PEAK}	2,390	62.51	74	-11.49
	2,406 _{AVE}	2,390	48.12	54	-5.88
	2,468 _{PEAK}	2,483.5	52.07	74	-21.93
	2,468 _{AVE}	2,483.5	43.67	54	-10.33

This test report may be reproduced in full only. The document may only be updated by MiCOM Labs personnel. Any changes will be noted in the Document History section of the report.



Radiated Band Edge Test Results for 2.4 GHz 30.3 dBi Antenna

TABLE OF RESULTS – 18 MHZ BANDWIDTH QPSK MODULATION

Tx Pwr (dBm)	Tx Freq. (MHz)	Restricted Band Edge Frequency (MHz)	Measured (dBuV/m)	Limit (dBuV/m)	Margin (dB)
+21.9	2,417 _{PEAK}	2,390	55.25	74	18.75
	2,417 _{AVE}	2,390	45.29	54	-8.71
	2,465 _{PEAK}	2,483.5	57.05	74	-16.95
	2,465 _{AVE}	2,483.5	47.85	54	-6.15

TABLE OF RESULTS – 18 MHZ BANDWIDTH 16QAM MODULATION

Tx Pwr (dBm)	Tx Freq. (MHz)	Restricted Band Edge Frequency (MHz)	Measured (dBuV/m)	Limit (dBuV/m)	Margin (dB)
+21.9	2,417 _{PEAK}	2,390	57.28	74	-16.72
	2,417 _{AVE}	2,390	46.24	54	-7.76
	2,465 _{PEAK}	2,483.5	58.98	74	-15.02
	2,465 _{AVE}	2,483.5	48.11	54	-5.89

TABLE OF RESULTS – 18 MHZ BANDWIDTH 64QAM MODULATION

Tx Pwr (dBm)	Tx Freq. (MHz)	Restricted Band Edge Frequency (MHz)	Measured (dBuV/m)	Limit (dBuV/m)	Margin (dB)
+21.9	2,417 _{PEAK}	2,390	58.48	74	-15.52
	2,417 _{AVE}	2,390	46.54	54	-7.46
	2,465 _{PEAK}	2,483.5	58.35	74	-15.65
	2,465 _{AVE}	2,483.5	49.05	54	-4.95

This test report may be reproduced in full only. The document may only be updated by MiCOM Labs personnel. Any changes will be noted in the Document History section of the report.



Radiated Band Edge Test Results for 2.4 GHz 30.3 dBi Antenna

TABLE OF RESULTS – 36 MHZ BANDWIDTH QPSK MODULATION

Tx Pwr (dBm)	Tx Freq. (MHz)	Restricted Band Edge Frequency (MHz)	Measured (dBuV/m)	Limit (dBuV/m)	Margin (dB)
+21.9	2,426 _{PEAK}	2,390	60.86	74	-13.14
	2,426 _{AVE}	2,390	51.8	54	-2.20
	2,455 _{PEAK}	2,483.5	55.31	74	-18.69
	2,455 _{AVE}	2,483.5	47.05	54	-6.95

TABLE OF RESULTS – 36 MHZ BANDWIDTH 16QAM MODULATION

Tx Pwr (dBm)	Tx Freq. (MHz)	Restricted Band Edge Frequency (MHz)	Measured (dBuV/m)	Limit (dBuV/m)	Margin (dB)
+21.9	2,426 _{PEAK}	2,390	55.05	74	-18.95
	2,426 _{AVE}	2,390	48.59	54	-5.41
	2,455 _{PEAK}	2,483.5	53.48	74	-20.52
	2,455 _{AVE}	2,483.5	44.83	54	-9.17

TABLE OF RESULTS – 36 MHZ BANDWIDTH 64QAM MODULATION

Tx Pwr (dBm)	Tx Freq. (MHz)	Restricted Band Edge Frequency (MHz)	Measured (dBuV/m)	Limit (dBuV/m)	Margin (dB)
+21.9	2,426 _{PEAK}	2,390	58.08	74	-15.92
	2,426 _{AVE}	2,390	48.59	54	-5.41
	2,455 _{PEAK}	2,483.5	55.02	74	-18.98
	2,455 _{AVE}	2,483.5	46.17	54	-7.83

This test report may be reproduced in full only. The document may only be updated by MiCOM Labs personnel. Any changes will be noted in the Document History section of the report.



Radiated Band Edge Test Results for 2.4 GHz 30.3 dBi Antenna

TABLE OF RESULTS – 72 MHZ BANDWIDTH QPSK MODULATION

Tx Pwr (dBm)	Tx Freq. (MHz)	Restricted Band Edge Frequency (MHz)	Measured (dBuV/m)	Limit (dBuV/m)	Margin (dB)
+21.9	2,437 _{PEAK}	2,390	56	74	-18.00
	2,437 _{AVE}	2,390	46.24	54	-7.76
	2,437 _{PEAK}	2,483.5	54.81	74	-19.19
	2,437 _{AVE}	2,483.5	46.47	54	-7.53

TABLE OF RESULTS – 72 MHZ BANDWIDTH 16QAM MODULATION

Tx Pwr (dBm)	Tx Freq. (MHz)	Restricted Band Edge Frequency (MHz)	Measured (dBuV/m)	Limit (dBuV/m)	Margin (dB)
+21.9	2,437 _{PEAK}	2,390	53.82	74	-20.18
	2,437 _{AVE}	2,390	47.36	54	-6.64
	2,437 _{PEAK}	2,483.5	53.65	74	-20.35
	2,437 _{AVE}	2,483.5	46.17	54	-7.83

TABLE OF RESULTS – 72 MHZ BANDWIDTH 64QAM MODULATION

Tx Pwr (dBm)	Tx Freq. (MHz)	Restricted Band Edge Frequency (MHz)	Measured (dBuV/m)	Limit (dBuV/m)	Margin (dB)
+21.9	2,437 _{PEAK}	2,390	56.38	74	-17.62
	2,437 _{AVE}	2,390	47.36	54	-6.64
	2,437 _{PEAK}	2,483.5	56.69	74	-17.31
	2,437 _{AVE}	2,483.5	46.17	54	-7.83

This test report may be reproduced in full only. The document may only be updated by MiCOM Labs personnel. Any changes will be noted in the Document History section of the report.



Radiated Band Edge Test Results for 2.4 GHz 20 dBi Antenna

TABLE OF RESULTS – 9 MHZ BANDWIDTH QPSK MODULATION

Tx Pwr (dBm)	Tx Freq. (MHz)	Restricted Band Edge Frequency (MHz)	Measured (dBuV/m)	Limit (dBuV/m)	Margin (dB)
+25.3	2,406 _{PEAK}	2,390	54.56	74	-19.44
	2,406 _{AVE}	2,390	43.84	54	-10.16
	2,468 _{PEAK}	2,483.5	52.53	74	-21.47
	2,468 _{AVE}	2,483.5	43.25	54	-10.75

TABLE OF RESULTS – 9 MHZ BANDWIDTH 16QAM MODULATION

Tx Pwr (dBm)	Tx Freq. (MHz)	Restricted Band Edge Frequency (MHz)	Measured (dBuV/m)	Limit (dBuV/m)	Margin (dB)
+25.3	2,406 _{PEAK}	2,390	57.55	74	-16.45
	2,406 _{AVE}	2,390	45.29	54	-8.71
	2,468 _{PEAK}	2,483.5	52.00	74	-20.00
	2,468 _{AVE}	2,483.5	43.25	54	-10.75

TABLE OF RESULTS – 9 MHZ BANDWIDTH 64QAM MODULATION

Tx Pwr (dBm)	Tx Freq. (MHz)	Restricted Band Edge Frequency (MHz)	Measured (dBuV/m)	Limit (dBuV/m)	Margin (dB)
+25.3	2,406 _{PEAK}	2,390	56.5	74	-17.5
	2,406 _{AVE}	2,390	45.62	54	-8.38
	2,468 _{PEAK}	2,483.5	52.77	74	-21.23
	2,468 _{AVE}	2,483.5	42.8	54	-11.2

This test report may be reproduced in full only. The document may only be updated by MiCOM Labs personnel. Any changes will be noted in the Document History section of the report.



Radiated Band Edge Test Results for 2.4 GHz 20 dBi Antenna

TABLE OF RESULTS – 18 MHZ BANDWIDTH QPSK MODULATION

Tx Pwr (dBm)	Tx Freq. (MHz)	Restricted Band Edge Frequency (MHz)	Measured (dBuV/m)	Limit (dBuV/m)	Margin (dB)
+25.3	2,417 _{PEAK}	2,390	52.35	74	-21.65
	2,417 _{AVE}	2,390	43.02	54	-10.98
	2,465 _{PEAK}	2,483.5	55.1	74	-18.90
	2,465 _{AVE}	2,483.5	46.17	54	-7.83

TABLE OF RESULTS – 18 MHZ BANDWIDTH 16QAM MODULATION

Tx Pwr (dBm)	Tx Freq. (MHz)	Restricted Band Edge Frequency (MHz)	Measured (dBuV/m)	Limit (dBuV/m)	Margin (dB)
+25.3	2,417 _{PEAK}	2,390	54.11	74	-19.89
	2,417 _{AVE}	2,390	44.23	54	-9.77
	2,465 _{PEAK}	2,483.5	58.17	74	-15.83
	2,465 _{AVE}	2,483.5	47.33	54	-6.67

TABLE OF RESULTS – 18 MHZ BANDWIDTH 64QAM MODULATION

Tx Pwr (dBm)	Tx Freq. (MHz)	Restricted Band Edge Frequency (MHz)	Measured (dBuV/m)	Limit (dBuV/m)	Margin (dB)
+25.3	2,417 _{PEAK}	2,390	54.63	74	-19.37
	2,417 _{AVE}	2,390	44.23	54	-9.77
	2,465 _{PEAK}	2,483.5	58.96	74	-15.04
	2,465 _{AVE}	2,483.5	47.85	54	-6.15

This test report may be reproduced in full only. The document may only be updated by MiCOM Labs personnel. Any changes will be noted in the Document History section of the report.



Radiated Band Edge Test Results for 2.4 GHz 20 dBi Antenna

TABLE OF RESULTS – 36 MHZ BANDWIDTH QPSK MODULATION

Tx Pwr (dBm)	Tx Freq. (MHz)	Restricted Band Edge Frequency (MHz)	Measured (dBuV/m)	Limit (dBuV/m)	Margin (dB)
+25.3	2,426 _{PEAK}	2,390	55.32	74	-18.68
	2,426 _{AVE}	2,390	48.59	54	-5.41
	2,455 _{PEAK}	2,483.5	52.15	74	-21.85
	2,455 _{AVE}	2,483.5	45.18	54	-8.82

TABLE OF RESULTS – 36 MHZ BANDWIDTH 16QAM MODULATION

Tx Pwr (dBm)	Tx Freq. (MHz)	Restricted Band Edge Frequency (MHz)	Measured (dBuV/m)	Limit (dBuV/m)	Margin (dB)
+25.3	2,426 _{PEAK}	2,390	58.83	74	-15.17
	2,426 _{AVE}	2,390	50.8	54	-3.20
	2,455 _{PEAK}	2,483.5	55.57	74	-18.43
	2,455 _{AVE}	2,483.5	45.52	54	-8.48

TABLE OF RESULTS – 36 MHZ BANDWIDTH 64QAM MODULATION

Tx Pwr (dBm)	Tx Freq. (MHz)	Restricted Band Edge Frequency (MHz)	Measured (dBuV/m)	Limit (dBuV/m)	Margin (dB)
+25.3	2,426 _{PEAK}	2,390	58.68	74	-15.32
	2,426 _{AVE}	2,390	50.25	54	-3.75
	2,455 _{PEAK}	2,483.5	56.95	74	-17.05
	2,455 _{AVE}	2,483.5	46.47	54	-7.53

This test report may be reproduced in full only. The document may only be updated by MiCOM Labs personnel. Any changes will be noted in the Document History section of the report.



Radiated Band Edge Test Results for 2.4 GHz 20 dBi Antenna

TABLE OF RESULTS – 72 MHZ BANDWIDTH QPSK MODULATION

Tx Pwr (dBm)	Tx Freq. (MHz)	Restricted Band Edge Frequency (MHz)	Measured (dBuV/m)	Limit (dBuV/m)	Margin (dB)
+25.3	2,437 _{PEAK}	2,390	56.56	74	-17.44
	2,437 _{Ave}	2,390	47.10	54	-6.90
	2,437 _{PEAK}	2,483.5	54.11	74	-19.89
	2,437 _{Ave}	2,483.5	45.85	54	-8.15

TABLE OF RESULTS – 72 MHZ BANDWIDTH 16QAM MODULATION

Tx Pwr (dBm)	Tx Freq. (MHz)	Restricted Band Edge Frequency (MHz)	Measured (dBuV/m)	Limit (dBuV/m)	Margin (dB)
+25.3	2,437 _{PEAK}	2,390	55.30	74	-18.70
	2,437 _{Ave}	2,390	47.36	54	-6.64
	2,437 _{PEAK}	2,483.5	52.76	74	-21.24
	2,437 _{Ave}	2,483.5	45.52	54	-8.48

TABLE OF RESULTS – 72 MHZ BANDWIDTH 64QAM MODULATION

Tx Pwr (dBm)	Tx Freq. (MHz)	Restricted Band Edge Frequency (MHz)	Measured (dBuV/m)	Limit (dBuV/m)	Margin (dB)
+25.3	2,437 _{PEAK}	2,390	56.66	74	-17.34
	2,437 _{Ave}	2,390	47.88	54	-6.12
	2,437 _{PEAK}	2,483.5	54.47	74	-19.53
	2,437 _{Ave}	2,483.5	44.83	54	-9.17

This test report may be reproduced in full only. The document may only be updated by MiCOM Labs personnel. Any changes will be noted in the Document History section of the report.



Specification

Limits

§15.205 (a) Except as shown in paragraph (d) of 15.205 (a), only spurious emissions are permitted in any of the frequency bands listed.

§15.205 (a) Except as shown in paragraphs (d) and (e) of this section, the field strength of emissions appearing within these frequency bands shall not exceed the limits shown in Section §15.209. At frequencies equal to or less than 1000 MHz, compliance with the limits in Section 15.209 shall be demonstrated using measurement instrumentation employing a CISPR quasi-peak detector. Above 1000 MHz, compliance with the emission limits in Section 15.209 shall be demonstrated based on the average value of the measured emissions. The provisions in Section 15.35 apply to these measurements.

§15.209 (a) Except as provided elsewhere in this subpart, the emissions from an intentional radiator shall not exceed the field strength levels specified in the following table.

IC RSS-Gen § 4.7 The search for unwanted emissions shall be from the lowest frequency internally generated or used in the device, or from 30 MHz, whichever is the lowest frequency, to the 5th harmonic of the highest frequency generated without exceeding 40 GHz.

Frequency (MHz)	Field Strength ($\mu\text{V/m}$)	Field Strength ($\text{dB}\mu\text{V/m}$)	Measurement Distance (meters)
30-88	100	40.0	3
88-216	150	43.5	3
216-960	200	46.0	3
Above 960	500	54.0	3

Laboratory Measurement Uncertainty for Radiated Emissions

Measurement uncertainty	+5.6/ -4.5 dB
-------------------------	---------------

Traceability

Method	Test Equipment Used
Measurements were made per work instruction WI-03 'Measurement of Radiated Emissions'	0088, 0158, 0134, 0304, 0315, 0310, 0312

This test report may be reproduced in full only. The document may only be updated by MiCOM Labs personnel. Any changes will be noted in the Document History section of the report.

5.1.6.5. Radiated Spurious Emissions (30M-1 GHz)

FCC, Part 15 Subpart C §15.247(c)/ §15.209
Industry Canada RSS-210 §2.2

Test Procedure

Testing 30M-1 GHz was subcontracted to the company identified in Section 3.9 Subcontracted Testing. Preliminary radiated emissions are measured in the anechoic chamber at a 3-meter distance on every azimuth in both horizontal and vertical polarity. The emissions are recorded with a spectrum analyzer in peak hold mode. Emissions closest to the limits are measured in the quasi-peak mode with the tuned receiver using a bandwidth of 120 kHz. Only the highest emissions relative to the limit are listed. The anechoic chamber test set-up is identified in Section 6 Test Set-Up Photographs.

Test Measurement Set up

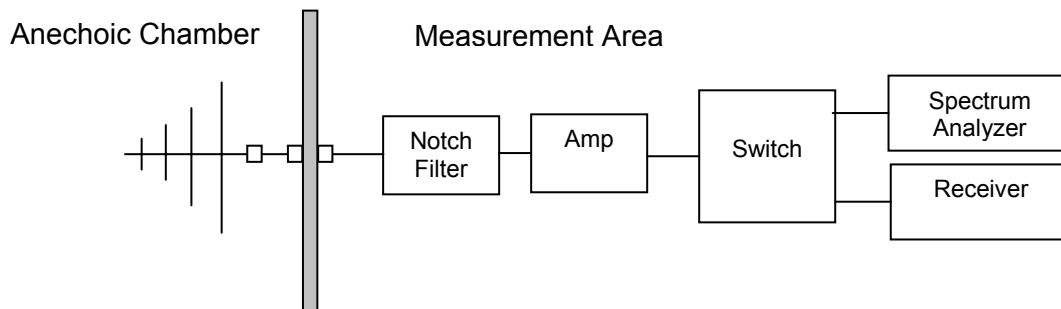

Field Strength Calculation

The field strength is calculated by adding the Antenna Factor and Cable Loss, and subtracting Amplifier Gain from the measured reading. In this test facility, the Antenna Factor, Cable Loss, and Amplifier Gains are loaded into the Rohde & Schwarz Receiver and the corrected field strength can be read directly on the receiver.

$$FS = R + AF + CORR$$

where:

FS = Field Strength
R = Measured Receiver Input Amplitude
AF = Antenna Factor
CORR = Correction Factor = CL – AG + NFL
CL = Cable Loss
AG = Amplifier Gain



Title: Exalt EX-2.4i-16 Fixed Link Radio
To: FCC 47 CFR Part15.247 & IC RSS-210
Serial #: EXLT19-A1 Rev A
Issue Date: 28th Feb 2007
Page: 237 of 248

For example:

Given a Receiver input reading of 51.5dB μ V; Antenna Factor of 8.5dB; Cable Loss of 1.3dB; Falloff Factor of 0dB, an Amplifier Gain of 26dB and Notch Filter Loss of 1dB. The Field Strength of the measured emission is:

$$FS = 51.5 + 8.5 + 1.3 - 26.0 + 1 = 36.3\text{dB}\mu\text{V/m}$$

Conversion between dB μ V/m (or dB μ V) and μ V/m (or μ V) are done as:

$$\text{Level (dB}\mu\text{V/m)} = 20 * \text{Log (level (\mu\text{V/m}))}$$

$$40 \text{ dB}\mu\text{V/m} = 100\mu\text{V/m}$$

$$48 \text{ dB}\mu\text{V/m} = 250\mu\text{V/m}$$

Measurement Results for Spurious Emissions (30 MHz – 1 GHz)

Ambient conditions.

Temperature: 19 to 26 °C Relative humidity: 31 to 57 % Pressure: 999 to 1009 mbar

Radio parameters.

Antenna Type: Super Pass Panel 20 dBi

Transmission: Mid channel, 100% duty cycle, full power

This test report may be reproduced in full only. The document may only be updated by MiCOM Labs personnel. Any changes will be noted in the Document History section of the report.



TABLE OF RESULTS

Freq. (MHz)	Peak (dBuV/m)	QP (dBuV/m)	QP Lmt (dBuV/m)	QP Margin (dB)	Angle (deg)	Height (cm)	Pol	Total Correction Factor
36.088766	36.51	26.83*	40.00	-13.17	99	194	Vert	-9.76
359.993123	33.28	32.83	46.00	-13.17	2	102	Horz	-8.46
436.903156	38.56	38.21	46.00	-7.79	86	104	Horz	-7.10
599.996152	39.02	37.81	46.00	-8.19	330	128	Horz	-5.48
720.002176	37.50	37.22	46.00	-8.78	205	103	Horz	-4.47
840.002687	39.76	39.36	46.00	-6.64	203	103	Horz	-3.52
931.862720	33.86	28.16	46.00	-17.84	242	102	Vert	-2.42
959.993707	21.81	17.67	46.00	-28.33	261	118	Horz	-1.36

Plot 215 Radiated Spurious Emissions 30 MHz to 1 GHz

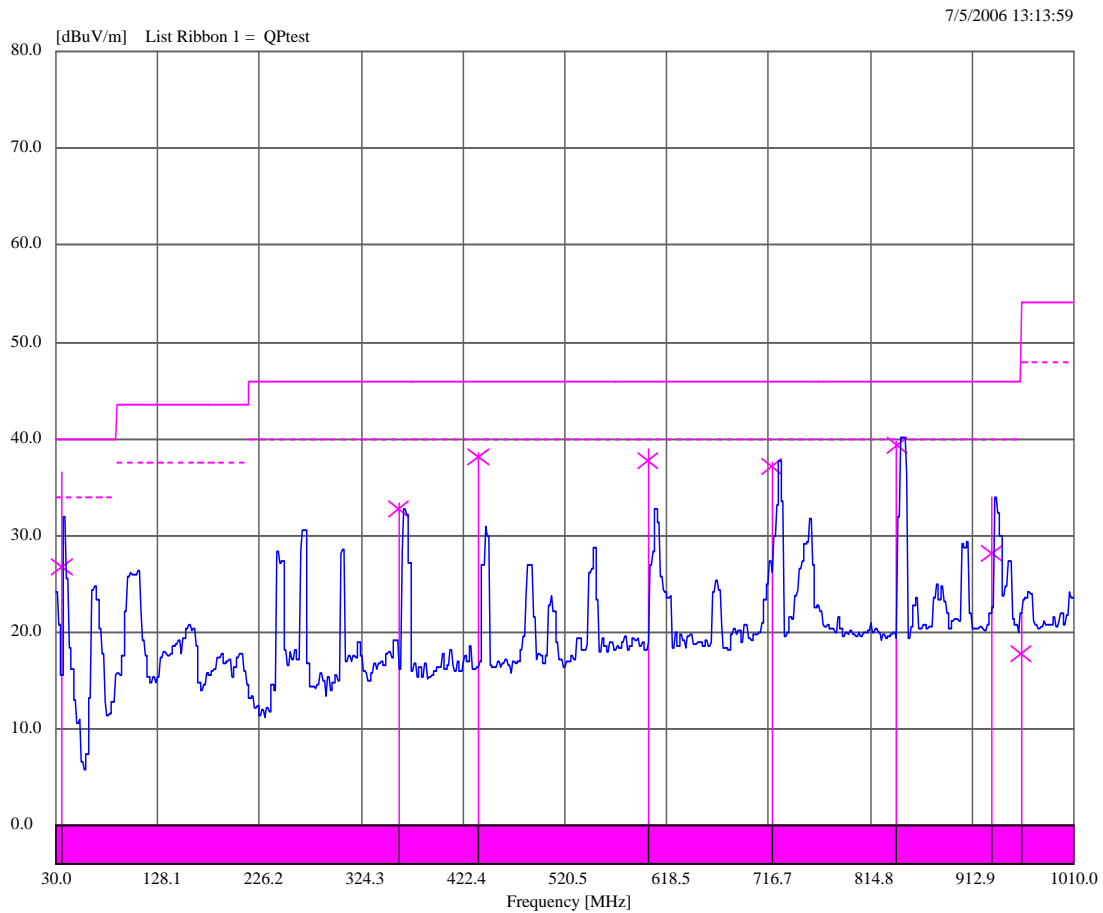

This test report may be reproduced in full only. The document may only be updated by MiCOM Labs personnel. Any changes will be noted in the Document History section of the report.



Title: Exalt EX-2.4i-16 Fixed Link Radio
To: FCC 47 CFR Part15.247 & IC RSS-210
Serial #: EXLT19-A1 Rev A
Issue Date: 28th Feb 2007
Page: 239 of 248

Specification

Limits

§15.205 (a) Except as shown in paragraph (d) of 15.205 (a), only spurious emissions are permitted in any of the frequency bands listed.

§15.205 (a) Except as shown in paragraphs (d) and (e) of this section, the field strength of emissions appearing within these frequency bands shall not exceed the limits shown in Section §15.209. At frequencies equal to or less than 1000 MHz, compliance with the limits in Section 15.209 shall be demonstrated using measurement instrumentation employing a CISPR quasi-peak detector. Above 1000 MHz, compliance with the emission limits in Section 15.209 shall be demonstrated based on the average value of the measured emissions. The provisions in Section 15.35 apply to these measurements.

§15.209 (a) Except as provided elsewhere in this subpart, the emissions from an intentional radiator shall not exceed the field strength levels specified in the following table.

Frequency(MHz)	Field Strength ($\mu\text{V}/\text{m}$)	Field Strength ($\text{dB}\mu\text{V}/\text{m}$)	Measurement Distance (meters)
30-88	100	40.0	3
88-216	150	43.5	3
216-960	200	46.0	3
Above 960	500	54.0	3

Laboratory Measurement Uncertainty for Radiated Emissions

Measurement uncertainty	+5.6/ -4.5 dB
-------------------------	---------------

Traceability

Method	Test Equipment Used
Measurements were made per TUV Rheinland of North America work instruction	8546A HP Receiver and RF Filter, HP Pre-amp, Antenna EMCO Biconilog

This test report may be reproduced in full only. The document may only be updated by MiCOM Labs personnel. Any changes will be noted in the Document History section of the report.

5.1.7. AC Wireline Conducted Emissions (150 kHz – 30 MHz)

FCC, Part 15 Subpart C §15.207
Industry Canada RSS-Gen §7.2.2

Test Procedure

The EUT is configured in accordance with ANSI C63.4. The conducted emissions are measured in a shielded room with a spectrum analyzer in peak hold in the first instance. Emissions closest to the limit are measured in the quasi-peak mode (QP) with the tuned receiver using a bandwidth of 9 kHz. The emissions are maximized further by cable manipulation. The highest emissions relative to the limit are listed.

Test Measurement Set up

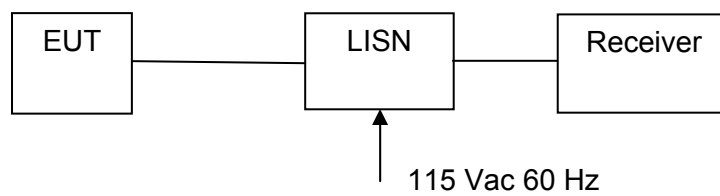

Measurement set up for AC Wireline Conducted Emissions Test

Measurement Results for AC Wireline Conducted Emissions (150 kHz – 30 MHz)

Ambient conditions.

Temperature: 19 to 26 °C Relative humidity: 31 to 57 % Pressure: 999 to 1009 mbar

Radio parameters.

Transmission: Mid channel, 100% duty cycle, full power



TABLE OF RESULTS

LINE - LIVE

Frequency (MHz)	Peak (dBμV)	QP (dBμV)	QP Limit (dBμV)	QP Margin (dB)	Ave. (dBμV)	Ave. Limit (dBμV)	Ave. Margin (dB)
--.--	Note	--.--	--.--	--.--	--.--	--.--	--.--

LINE - NEUTRAL

Frequency (MHz)	Peak (dBμV)	QP (dBμV)	QP Limit (dBμV)	QP Margin (dB)	Ave. (dBμV)	Ave. Limit (dBμV)	Ave. Margin (dB)
--.--	Note	--.--	--.--	--.--	--.--	--.--	--.--

Note. No emissions were observed above the limit.

Plot 216 AC Wireline Conducted Emissions (150 kHz – 30 MHz)

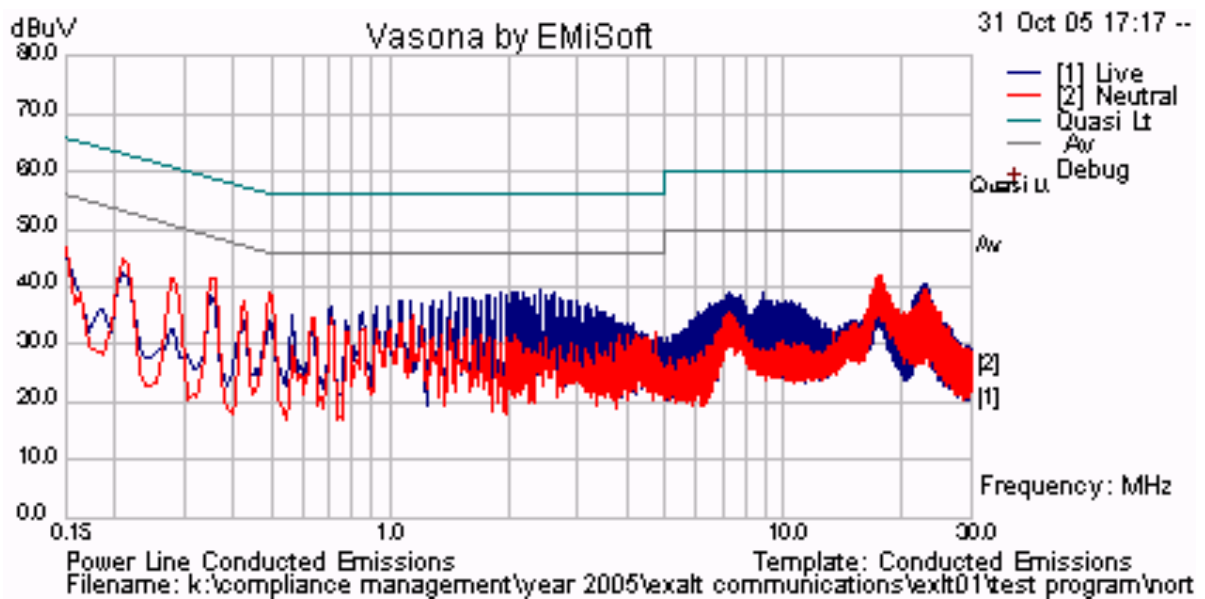

This test report may be reproduced in full only. The document may only be updated by MiCOM Labs personnel. Any changes will be noted in the Document History section of the report.



Specification

Limit

§15.207 (a) Except as shown in paragraphs (b) and (c) of this section, for an intentional radiator that is designed to be connected to the public utility (AC) power line, the radio frequency voltage that is conducted back onto the AC power line on any frequency or frequencies within the band 150 kHz to 30 MHz shall not exceed the limits in the following table, as measured using a 50 $\mu\Omega$ line impedance stabilization network (LISN), see §15.207 (a) matrix below. Compliance with the provisions of this paragraph shall be based on the measurement of the radio frequency voltage between each power line and ground at the power terminal.

IC RSS-Gen §7.2.2 Except when the requirements applicable to a given device state otherwise, for any license-exempt radio communication device equipped to operate from the public utility AC power supply, either directly or indirectly, the radio frequency voltage that is conducted back into the AC power lines in the frequency range of 0.15 MHz to 30 MHz shall not exceed the limits shown in the table below.

§15.207 (a) & IC RSS-Gen Limit Matrix

The lower limit applies at the boundary between frequency ranges

Frequency of Emission (MHz)	Conducted Limit (dB μ V)	
	Quasi-peak	Average
0.15-0.5	66 to 56*	56 to 46*
0.5-5	56	46
5-30	60	50

* Decreases with the logarithm of the frequency

Laboratory Measurement Uncertainty for Conducted Emissions

Measurement uncertainty	± 2.64 dB
-------------------------	---------------

Traceability

Method	Test Equipment Used
Measurements were made per work instruction WI-EMC-01 'Measurement of Conducted Emissions'	0158, 0184, 0193, 0190, 0293, 0307

This test report may be reproduced in full only. The document may only be updated by MiCOM Labs personnel. Any changes will be noted in the Document History section of the report.

6. PHOTOGRAPHS

6.1. Radiated Emissions (30 MHz-1 GHz)

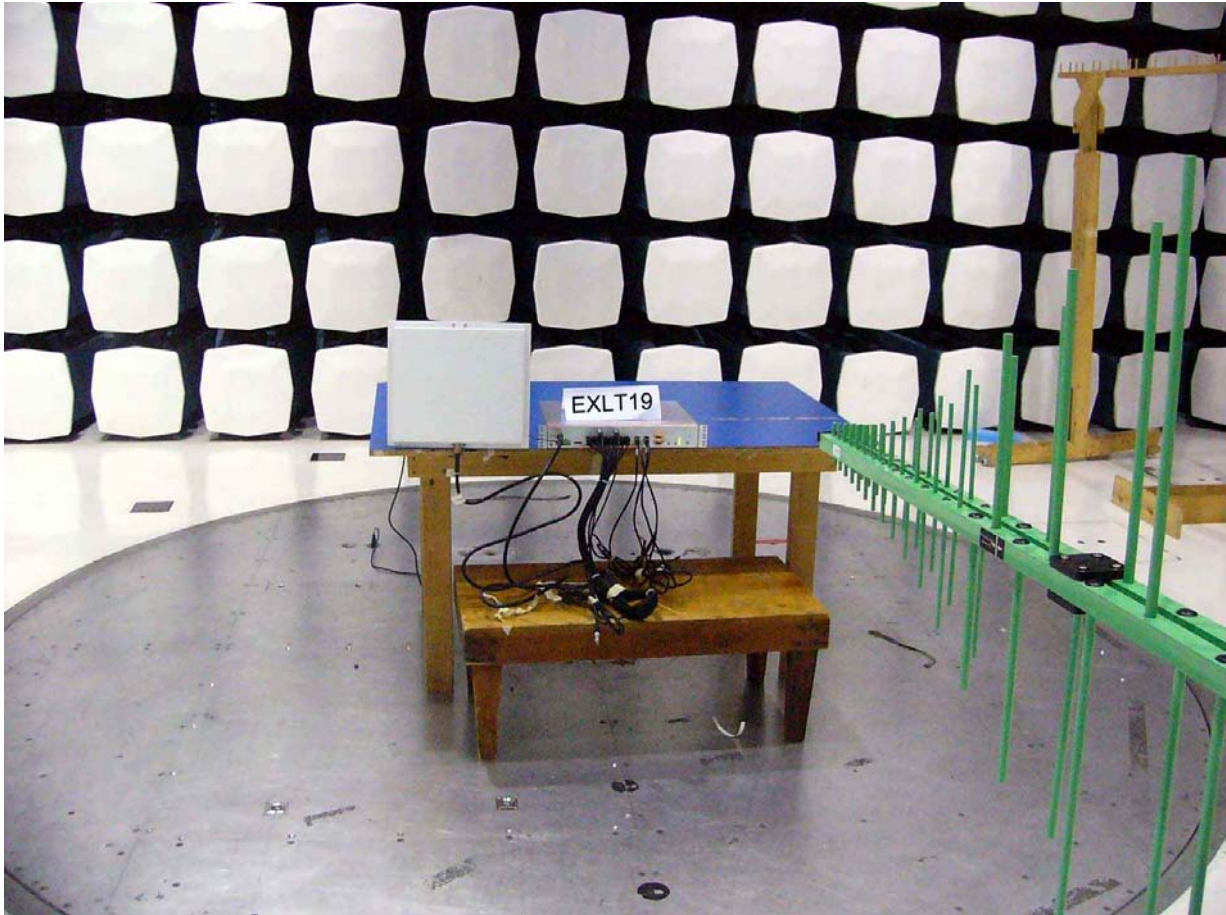

This test report may be reproduced in full only. The document may only be updated by MiCOM Labs personnel. Any changes will be noted in the Document History section of the report.

6.2. Radiated Emissions >1 GHz



This test report may be reproduced in full only. The document may only be updated by MiCOM Labs personnel. Any changes will be noted in the Document History section of the report.

6.3. Conducted Emissions (150 kHz - 30 MHz)



This test report may be reproduced in full only. The document may only be updated by MiCOM Labs personnel. Any changes will be noted in the Document History section of the report.

6.4. General Measurement Test Set-Up

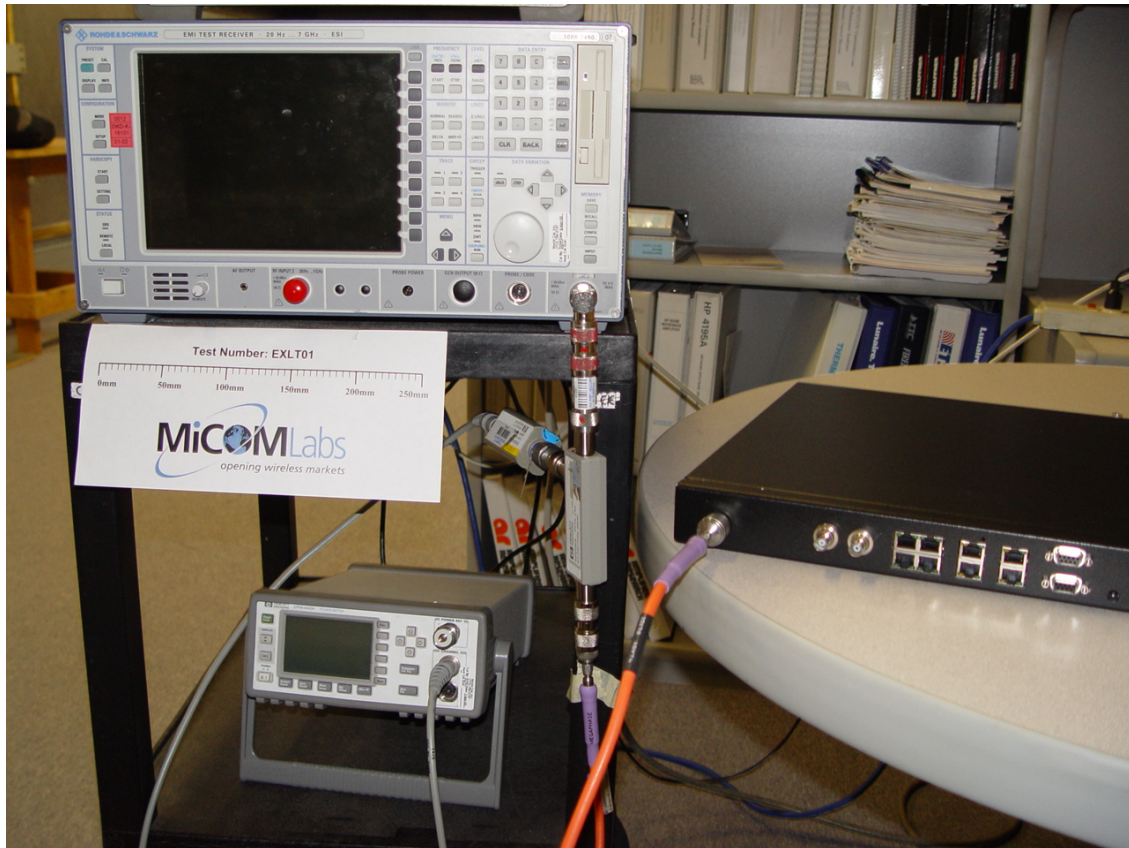

This test report may be reproduced in full only. The document may only be updated by MiCOM Labs personnel. Any changes will be noted in the Document History section of the report.



Title: Exalt EX-2.4i-16 Fixed Link Radio
To: FCC 47 CFR Part15.247 & IC RSS-210
Serial #: EXLT19-A1 Rev A
Issue Date: 28th Feb 2007
Page: 247 of 248

7. TEST EQUIPMENT DETAILS

Asset #	Instrument	Manufacturer	Part #	Serial #
0088	Spectrum Analyzer	Hewlett Packard	8564E	3410A00141
0104	1-18GHz Horn Antenna	The Electro-Mechanics Company	3115	9205-3882
0134	Amplifier	Com Power	PA 122	181910
0158	Barometer /Thermometer	Control Co.	4196	E2846
0193	EMI Receiver	Rhode & Schwartz	ESI 7	838496/007
0252	SMA Cable	Megaphase	Sucoflex 104	None
0304	2.4GHzHz Notch Filter	Micro-Tronics	--	001
0310	2m SMA Cable	Micro-Coax	UFA210A-0-0787-3G03G0	209089-001
0312	3m SMA Cable	Micro-Coax	UFA210A-1-1181-3G0300	209092-001
0313	Coupler	Hewlett Packard	86205A	3140A01285
0314	30dB N-Type Attenuator	ARRA	N9444-30	1623
0070	Power Meter	Hewlett Packard	437B	3125U11552
0116	Power Sensor	Hewlett Packard	8485A	3318A19694
0117	Power Sensor	Hewlett Packard	8487D	3318A00371
0184	Pulse Limiter	Rhode & Schwartz	ESH3Z2	357.8810.52
0190	LISN	Rhode & Schwartz	ESH3Z5	836679/006
0293	BNC Cable	Megaphase	1689 1GVT4	15F50B001
0307	BNC Cable	Megaphase	1689 1GVT4	15F50B002

This test report may be reproduced in full only. The document may only be updated by MiCOM Labs personnel. Any changes will be noted in the Document History section of the report.



440 Boulder Court, Suite 200
Pleasanton, CA 94566, USA
Tel: 1.925.462.0304
Fax: 1.925.462.0306
www.micomlabs.com