



# *FCC COMPLIANCE TEST REPORT*

Technical Statement of Conformity  
in accordance with 47 CFR Part 15 Subpart C

## The product

<b>Equipment Under Test</b>	: Control Box
<b>Model Number</b>	: FAB-100C
<b>Product Series</b>	: N/A
<b>Report Number</b>	: HA170599-RA
<b>Issue Date</b>	: 20-June-2017
<b>Test Result</b>	: Compliance

is produced by

**Ruoey Lung Enterprise Corp.**

No.17, Lu-Kung South 2 Road, Chang-Pin Industrial Park, Lu-Kang, Changhua, Taiwan



**HongAn TECHNOLOGY CO., LTD.**

NO.15-1, CWEISHUH KENG, CWEIPIN VILLAGE,  
LINKOU, TAIPEI COUNTY,  
TAIWAN, R. O. C.

**TEL:** +886-2-26030362

**FAX:** +886-2-26019259

**E-mail:** hatlab@ms19.hinet.net

**BSMI Registration No.:** SL2-IN-E-0023, SL2-A1-E-0023,  
SL2-IS-E-0023, SL2-R1-E-0023,  
SL2-R2-E-0023, SL2-L1-E-0023

**FCC Designation No.:** TW1071

**TAF Accreditation No.:** 1163

**VCCI Registration No.:** R-2156, C-2329, T-219

# Contents

<b>1</b>	<b>General Description</b>	<b>6</b>
1.1	Description of EUT	6
1.2	Test Instruments	7
1.3	Auxiliary Equipments	8
1.4	EUT SETUP	8
1.5	Identifying the Final Test Mode	8
1.6	Final Test Mode	9
1.7	Condition of Power Supply	9
1.8	EUT Configuration	9
1.9	Test Methodology	9
1.10	General Test Procedures	9
1.11	Modification	9
1.12	FCC Part 15.205 restricted bands of operations	10
1.13	Qualification of Test Facility	11
<b>2</b>	<b>Power line Conducted Emission Measurement</b>	<b>12</b>
2.1	Test Instruments	12
2.2	Test Arrangement and Procedure	12
2.3	Limit (§ 15.207)	12
2.4	Test Result	12
<b>3</b>	<b>Radiated Emission Test</b>	<b>15</b>
3.1	Test Instruments	15
3.2	Test Arrangement and Procedure	15
3.3	Limit (§ 15.205 & § 15.209)	16
3.4	Test Result	17
<b>4</b>	<b>Out of Band Emission Test</b>	<b>28</b>
4.1	Test Instruments	28
4.2	Test Arrangement and Procedure	28
4.3	Limit of Field Strength of Fundamental (§ 15.249(d))	28
4.4	Test Result	28
<b>5</b>	<b>20 dB Bandwidth</b>	<b>33</b>
5.1	Test Instruments	33
5.2	Test Arrangement and Procedure	33
5.3	Limit	33
5.4	Test Result	33



---

<b>6</b>	<b>Antenna requirement</b>	<b>37</b>
6.1	Limit (§ 15.203)	37
6.2	Test Result	37
<b>7</b>	<b>Information about the FHSS characteristics</b>	<b>38</b>
7.1	Pseudorandom Frequency Hopping Sequence	38
7.2	Example of a 79 hopping sequence in data mode:	38
7.3	Equal Hopping Frequency Use	38
<b>8</b>	<b>Photographs of the Tests</b>	<b>39</b>
8.1	Radiated Disturbances Emission Test	39
8.2	Conducted Disturbances Emission Test	40
<b>9</b>	<b>Photographs of the EUT</b>	<b>41</b>

# Test Result Certification

**Applicant** : Ruoei Lung Enterprise Corp.

**Address of Applicant** : No.17, Lu-Kung South 2 Road, Chang-Pin Industrial Park, Lu-Kang, Changhua, Taiwan

**Manufacturer** : Ruoei Lung Enterprise Corp.

**Address of Manufacturer** : No.17, Lu-Kung South 2 Road, Chang-Pin Industrial Park, Lu-Kang, Changhua, Taiwan

**Trade Name** : 

**Equipment Under Test** : Control Box

**Model Number** : FAB-100C

**Product Series** : N/A

**FCC ID** : TRUAQUARIUS

**Filing Type** : Certification

**Sample Received Date** : 06-June-2017

**Test Standard** :

FCC Part 15 Subpart C §15.249

**Deviations from standard test methods & any other specifications : NONE**

**Remark:**

1. This report details the results of the test carried out on one sample.
2. The test data, data evaluation, test procedures, and equipment configurations shown in this report were made in accordance with the procedures given in both ANSI C63.10 (2013) and the energy emitted by the sample EUT tested as described in this report is in compliance with the requirements of FCC Rules Part 15.203, 15.207, 15.209, 15.249.
3. This report applies to the above sample only and shall not be reproduced in part without written approval of HongAn Technology Co., Ltd.

*Kay Wang*

**Documented by:** \_\_\_\_\_ 2017-06-20

**Kay Wang/ ADM. Dept Staff**

*Eason Hsieh*

**Tested by:** \_\_\_\_\_ 2017-06-13

**Eason Hsieh / ENG. Dept. Staff**

*Peter Chin*

**Approved by:** \_\_\_\_\_ **Date:** 2017-06-20

**Peter Chin / Section Manager**

## Summary of Test Result

	<b>Test Item</b>	<b>Applicable Standard</b>	<b>Test Result</b>
1	Antenna Requirement	FCC part 15 subpart C §203	Compliance
2	Conducted Emission	FCC part 15 subpart C §207	Compliance
3	Restricted Band of Operation	FCC part 15 subpart C §205	Compliance
4	Radiated Emission	FCC part 15 subpart C §209	Compliance
5	Field Strength	FCC part 15 subpart C §249(a)	Compliance
6	Out of Band Emission	FCC part 15 subpart C §249(d)	Compliance
7	20dB Bandwidth	FCC part 15 subpart C §215(c)	Compliance

# 1 General Description

## 1.1 Description of EUT

<b>Equipment Under Test</b>	:	Control Box							
<b>Model Number of EUT</b>	:	FAB-100C							
<b>Product Series</b>	:	N/A							
<b>Power Supply</b>	:	AC-DC power adaptor Manufacturer: DELTA ELECTRONICS INC. Model Number: ADP-73AR B Input: 110-120Vac, 50/60Hz, 2A; Output: 29Vdc, 2.5A Power Cord: 3 Pin <input type="checkbox"/> Shielded <input checked="" type="checkbox"/> Non-Shielded <input type="checkbox"/> Detachable, m <input checked="" type="checkbox"/> Un-Detachable, 1.8m <input checked="" type="checkbox"/> w Ferrite Core <input type="checkbox"/> w/o Ferrite Core							
<b>Frequency Range</b>	:	2402~2480 MHz							
<b>Number of Channels</b>	:	40 Channels							
<b>Carrier Frequency of Each Channel</b>	:	00	2402	10	2422	20	2442	30	2462
		01	2404	11	2424	21	2444	31	2464
		02	2406	12	2426	22	2446	32	2466
		03	2408	13	2428	23	2448	33	2468
		04	2410	14	2430	24	2450	34	2470
		05	2412	15	2432	25	2452	35	2472
		06	2414	16	2434	26	2454	36	2474
		07	2416	17	2436	27	2456	37	2476
		08	2418	18	2438	28	2458	38	2478
		09	2420	19	2440	29	2460	39	2480
<b>Antenna Specification</b>	:	PCB Antenna/ Gain: 0.4 dBi							
<b>Modulation Technique</b>	:	Bluetooth 4.0 BLE FHSS Bluetooth : GFSK							
<b>Transmit Data Rate</b>	:	Bluetooth : 1Mbps							
<b>Specification</b>	:	<b>Dimensions</b> : 325 mm (L) X 90 mm (W) X 43 mm (H) <b>Weight</b> : 450g <b>Function</b> : The EUT is a control box incorporated Bluetooth module to control actuator operation, massage operation and LED lighting. ※For more detail specification, please refer to the User Manual.							

## 1.2 Test Instruments

HA2

Instrument Name	Manufacture Mode	Model Number	Serial Number	Last Cal. Date	Next Cal. Date
RF Amplifier	Schaffner	CPA9231A	0405	01-JUN-2017	31-MAY-2018
EMI Receiver	R&S	ESCI	100931	25-JUL-2016	24-JUL-2017
Spectrum Analyzer	R&S	FSV	101629	27-JAN-2017	26-JAN-2018
Preamplifier	HD	HD17187	004	01-JUN-2017	31-MAY-2018
Bilog Antenna	TESEQ	CBL6111D	38521	04-JUN-2017	03-JUN-2018
Double-Ridged Waveguide Horn	EMCO	3115	9912-5992	01-JUN-2017	31-MAY-2018
Temp. & Humidity Chamber	MALLIER	MCT-2X-M	13490413-001	15-DEC-2016	14-DEC-2017
Horn Antenna (18-40GHz)	Com-Power	AH-840	101042	02-JUN-2017	01-JUN-2018
Microwave Preamplifier	Com-Power	PAM-840	461269	04-JUN-2017	03-JUN-2018
L.I.S.N.	Mess Tec	NNB-2/16Z	03/1006	22-FEB-2017	21-FEB-2018
L.I.S.N.	EMCIS	3810/2NM	9702-1820	16-JUL-2016	15-JUL-2017
WIDEBAND RADIO COMMUNICATION TESTER	ROHDE&SCH WARZ	CMW-500	141958	05-NOV-2016	04-NOV-2017

※ The test equipments used are calibrated and can be traced to National ITRI and International Standards.

### 1.3 Auxiliary Equipments

1.3.1. Provided by HongAn Technology Co., Ltd. for RF Test.

No.	Equipment	Model No.	Serial No.	EMC Approved	Brand	Description	
						Data Cable	Power Cable
--	--	--	--	--	--	--	--

1.3.2. Provided by the Manufacturer

No.	Equipment	Model No.	Serial No.	EMC Approved	Brand	Description	
						Data Cable	Power Cable
--	--	--	--	--	--	--	--

### 1.4 EUT SETUP

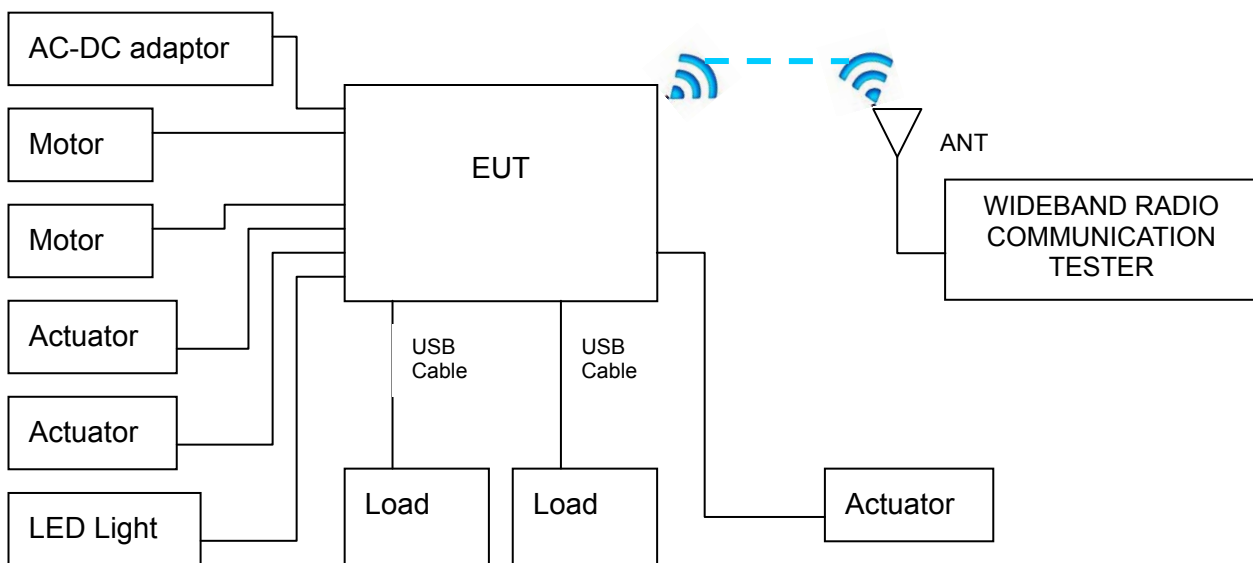

Note: Main Test Sample: FAB-100C

### 1.5 Identifying the Final Test Mode

1. Mode 1: TX BT BLE mode (1Mbps) CH 00.
2. Mode 2: TX BT BLE mode (1Mbps) CH 20.
3. Mode 3: TX BT BLE mode (1Mbps) CH 39.

Note :

1. After pre-test, we identified that the TX (Packet type DH5 and X axis) was most likely to cause maximum disturbance. Therefore, the Final Assessment was performed for the worst case.
2. The EUT was operated in the engineering mode to fix the TX frequency that was for the purpose of the measurements.
3. Channel Low (2402 MHz), Mid (2442 MHz) and High (2480 MHz) were chosen for full testing.
4. According to its specifications, the EUT must comply with the requirements of the Section 15.203, 15.207, 15.209 and 15.249 under the FCC Rules Part 15 Subpart C.



## 1.6 Final Test Mode

Conducted Emission: Mode 3.

Field Strength: All Mode.

Radiated Emission (30~1000 MHz): Mode 3.

Radiated Emission (1~26.5GHz): All Mode.

## 1.7 Condition of Power Supply

120V AC

## 1.8 EUT Configuration

1. Setup the EUT as shown in Sec.1.4 Block Diagram.
2. Turn on the power of all equipments.
3. Activate the selected Final Test Mode.

## 1.9 Test Methodology

The tests documented in this report were performed in accordance with ANSI C63.10 (2013) and FCC CFR 47 2.1046, 2.1047, 2.1049, 2.1051, 2.1053, 2.1055, 2.1057, 15.203, 15.207, 15.209 and 15.249.

## 1.10 General Test Procedures

### Conducted Emissions

The EUT is set according to the requirements in Section 6.2 of ANSI C63.10 (2013).

### Radiated Emissions

The EUT is set according to the requirements in Section 6.3 of ANSI C63.10 (2013).

## 1.11 Modification

N/A

**1.12 FCC Part 15.205 restricted bands of operations**

(a) Except as shown in paragraph (d) of this section, only spurious emissions are permitted in any of the frequency bands listed below:

MHz	MHz	MHz	GHz
0.090-0.110	16.42-16.423	399.9-410	4.5-5.15
<sup>1</sup> 0.495-0.505	16.69475-16.69525	608-614	5.35-5.46
2.1735-2.1905	16.80425-16.80475	960-1240	7.25-7.75
4.125-4.128	25.5-25.67	1300-1427	8.025-8.5
4.17725-4.17775	37.5-38.25	1435-1626.5	9.0-9.2
4.20725-4.20775	73-74.6	1645.5-1646.5	9.3-9.5
6.215-6.218	74.8-75.2	1660-1710	10.6-12.7
6.26775-6.26825	108-121.94	1718.8-1722.2	13.25-13.4
6.31175-6.31225	123-138	2200-2300	14.47-14.5
8.291-8.294	149.9-150.05	2310-2390	15.35-16.2
8.362-8.366	156.52475-156.52525	2483.5-2500	17.7-21.4
8.37635-8.38675	156.7-156.9	2690-2900	22.01-23.12
8.41425-8.41475	162.0125-167.17	3260-3267	23.6-24.0
12.29-12.293	167.72-173.2	3332-3339	31.2-31.8
12.51975-12.52025	240-285	3345.8-3358	36.43-36.5
12.57675-12.57725	322-335.4	3600-4400	( <sup>2</sup> )
13.36-13.41			

<sup>1</sup> Until February 1, 1999, this restricted band shall be 0.490-0.510 MHz

<sup>2</sup> Above 38.6

(b) Except as provided in paragraphs (d) and (e), the field strength of emissions appearing within these frequency bands shall not exceed the limits shown in Section 15.209. At frequencies equal to or less than 1000 MHz, compliance with the limits in Section 15.209 shall be demonstrated using measurement instrumentation employing a CISPR quasi-peak detector. Above 1000 MHz, compliance with the emission limits in Section 15.209 shall be demonstrated based on the average value of the measured emissions. The provisions in Section 15.35 apply to these measurements.



### 1.13 Qualification of Test Facility

**BSMI Certificate No.** : SL2-IS-E-0023, SL2-IN-E-0023, SL2-R1-E-0023, SL2-R2-E-0023,  
SL2-A1-E-0023, SL2-L1-E-0023.

**FCC Designation No.** : TW1071

**TAF Accreditation No.** : 1163

**VCCI Certificate No.** : R-2156, C-2329, T-219

## 2 Power line Conducted Emission Measurement

### 2.1 Test Instruments

Refer to Sec. 1.2 Test Instruments.

### 2.2 Test Arrangement and Procedure

1. The EUT was placed on a table, which is 0.8m above ground plane.
2. Maximum procedure was performed on the six highest emissions to ensure EUT compliance.
3. Repeat above procedures until all frequency measured were complete.

### 2.3 Limit (§ 15.207)

For an intentional radiator which is designed to be connected to the public utility (AC) power line, the radio frequency voltage that is conducted back onto the AC power line on any frequency or frequencies within the band 150 kHz to 30 MHz shall not exceed 250 microvolts (The limit decreases linearly with the logarithm of the frequency in the range 0.15 MHz to 0.50 MHz). The limits at specific frequency range is listed as follows:

Frequency (MHz)	Limits (dBuV)	
	Q.P. (Quasi-Peak)	A.V. (Average)
0.15 to 0.50	66 to 56	56 to 46
0.50 to 5.0	56	46
5.0 to 30	60	50

Compliance with this provision shall be based on the measurement of the radio frequency voltage between each power line (LINE and NEUTRAL) and ground at the power terminals.

### 2.4 Test Result

#### Compliance

The final test data are shown on the following page(s).

**Conducted Emission Test Data**

Test Date : 2017-06-13 Power Line : Line  
 Temperature : 27.5°C Humidity : 47%

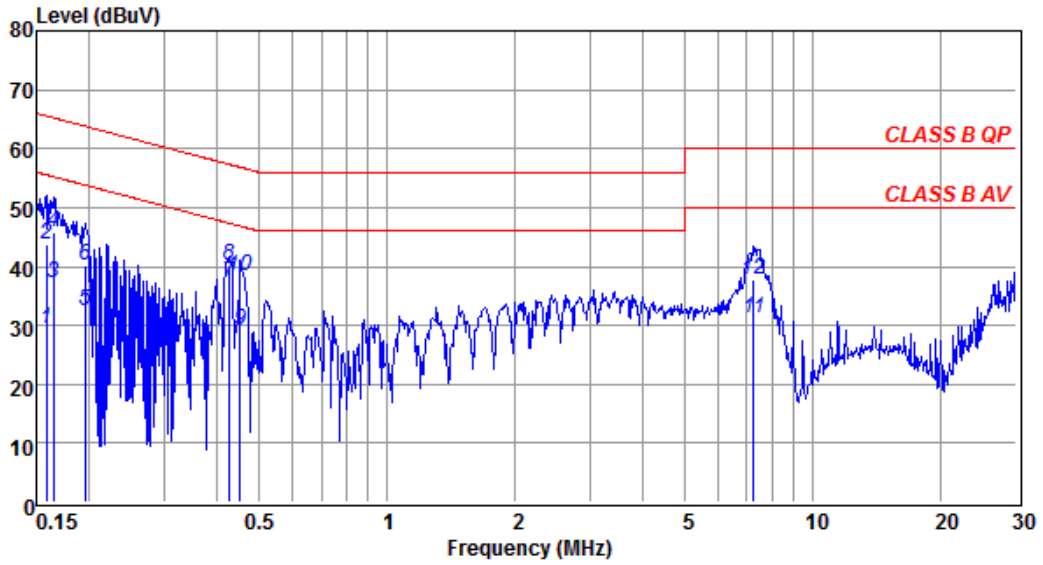

Freq MHz	Read QP dBuV	Read AV dBuV	C.F dB	Result QP dBuV	Result AV dBuV	Limit QP dBuV	Limit AV dBuV	Margin QP dB	Margin AV dB
0.158	43.69	29.33	0.16	43.85	29.49	65.56	55.56	-21.71	-26.07
0.164	45.75	37.10	0.15	45.90	37.25	65.25	55.25	-19.35	-18.00
0.195	40.15	32.30	0.13	40.28	32.43	63.80	53.80	-23.52	-21.37
0.424	40.05	36.90	0.15	40.20	37.05	57.37	47.37	-17.17	-10.32
0.452	38.25	28.92	0.15	38.40	29.07	56.85	46.85	-18.45	-17.78
7.252	37.01	30.57	0.61	37.62	31.18	60.00	50.00	-22.38	-18.82

Note1: C.F (Correction Factor) = Insertion loss + Cable loss + Pulse limiter  
 Note2: Margin = Result - Limit

### Conducted Emission Test Data

Test Date : 2017-06-13 Power Line : Neutral  
 Temperature : 27.5°C Humidity : 47%

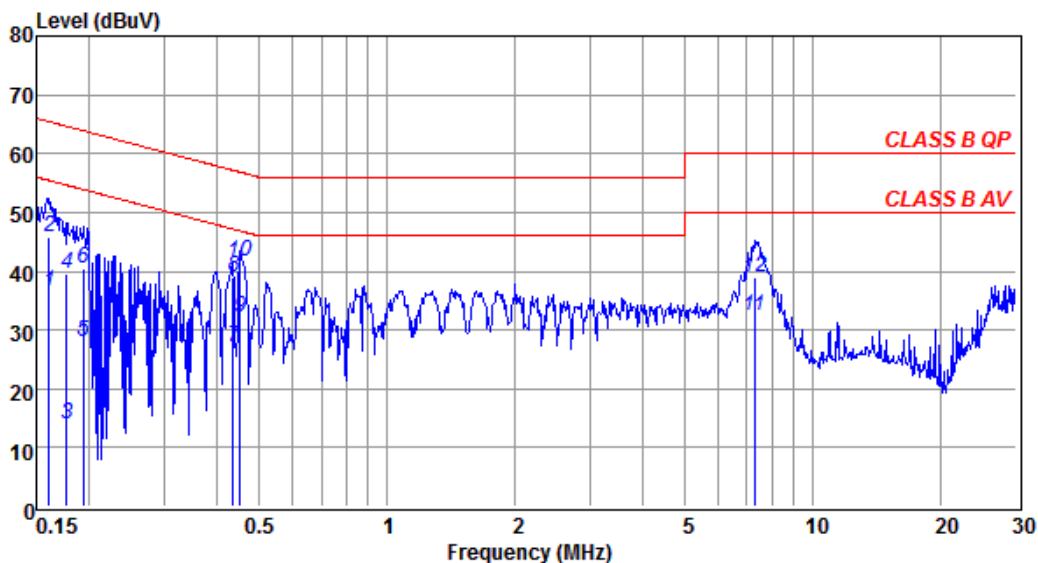

Freq MHz	Read QP dBuV	Read AV dBuV	C.F dB	Result QP dBuV	Result AV dBuV	Limit QP dBuV	Limit AV dBuV	Margin QP dB	Margin AV dB
0.161	45.66	36.55	0.12	45.78	36.67	65.43	55.43	-19.65	-18.76
0.177	39.56	13.99	0.12	39.68	14.11	64.64	54.64	-24.96	-40.53
0.193	40.31	27.85	0.12	40.43	27.97	63.89	53.89	-23.46	-25.92
0.435	38.70	26.81	0.17	38.87	26.98	57.15	47.15	-18.28	-20.17
0.452	41.43	32.06	0.17	41.60	32.23	56.85	46.85	-15.25	-14.62
7.290	38.49	31.83	0.55	39.04	32.38	60.00	50.00	-20.96	-17.62

Note1: C.F (Correction Factor) = Insertion loss + Cable loss + Pulse limiter  
 Note2: Margin = Result - Limit

### 3 Radiated Emission Test

#### 3.1 Test Instruments

Refer to Sec. 1.2 Test Instruments.

#### 3.2 Test Arrangement and Procedure

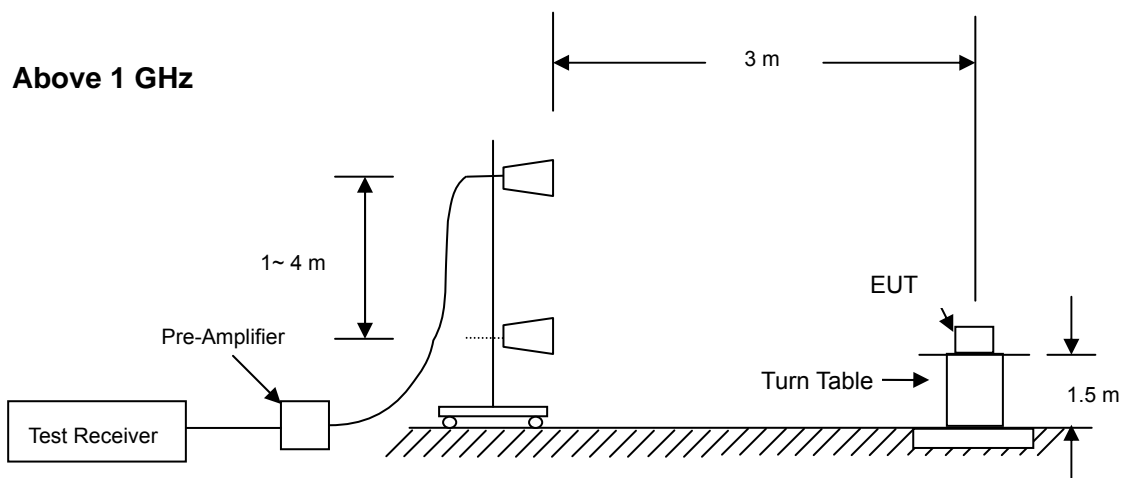
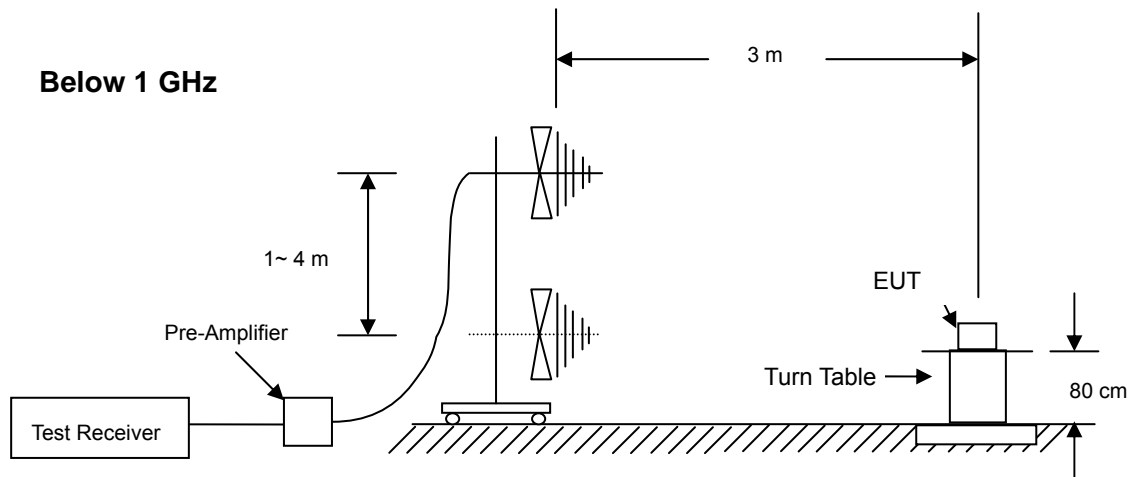

1. The EUT is placed on a turntable, which is 0.8 m (below 1GHz) and 1.5m (above 1GHz) above ground plane.
2. The turntable shall be rotated for 360 degrees to determine the position of maximum emission level.
3. EUT is set 3 m away from the receiving antenna, which is varied from 1 m to 4 m to find out the highest emissions.
4. Maximum procedure was performed on the six highest emissions to ensure EUT compliance.
5. And also, each emission was to be maximized by changing the polarization of receiving antenna both horizontal and vertical.
6. Set the spectrum analyzer in the following setting as:
  - (a) Below 1 GHz: RBW =100 kHz/ VBW = 1 MHz/ Sweep = AUTO.

(b) Above 1 GHz: Peak: RBW = VBW = 1MHz/ Sweep = AUTO; Average: RBW = 1MHz/ VBW = 10Hz/ Sweep = AUTO.

7. Repeat above procedures until the measurements for all frequencies are complete.

**3.3 Limit (§ 15.205 & § 15.209)**

3.3.1 Limit of Restricted Band of Operation (§ 15.205)

(a) Except as shown in paragraph (d) of this section, only spurious emissions are permitted in any of the frequency bands listed below:

Frequency Band			
MHz	MHz	MHz	GHz
0.090-0.110	16.42-16.423	399.9-410	4.5-5.15
<sup>1</sup> 0.495-0.505	16.69475-16.69525	608-614	5.35-5.46
2.1735-2.1905	16.80425-16.80475	960-1240	7.25-7.75
4.125-4.128	25.5-25.67	1300-1427	8.025-8.5
4.17725-4.17775	37.5-38.25	1435-1626.5	9.0-9.2
4.20725-4.20775	73-74.6	1645.5-1646.5	9.3-9.5
6.215-6.218	74.8-75.2	1660-1710	10.6-12.7
6.26775-6.26825	108-121.94	1718.8-1722.2	13.25-13.4
6.31175-6.31225	123-138	2200-2300	14.47-14.5
8.291-8.294	149.9-150.05	2310-2390	15.35-16.2
8.362-8.366	156.52475-156.52525	2483.5-2500	17.7-21.4
8.37625-8.38675	156.7-156.9	2690-2900	22.01-23.12
8.41425-8.41475	162.0125-167.17	3260-3267	23.6-24.0
12.29-12.293	167.72-173.2	3332-3339	31.2-31.8
12.51975-12.52025	240-285	3345.8-3358	36.43-36.5
12.57675-12.57725	322-335.4	3600-4400	
13.36-13.41			



**3.3.2 Limit of Spurious Emission (§ 15.209)**

Emissions radiated outside of the specified frequency bands, except for harmonics, shall be attenuated by at least 50 dB below the level of the fundamental or to the general radiated emission limits in § 15.209, whichever is lesser attenuation.

Frequency (MHz)	Field strength (microvolts/ meter)	Measurement distance (meters)
0.009-0.490	2400/F(kHz)	300
0.490-1.705	24000/F(kHz)	30
1.705-30.0	30	30
30-88	100**	3
88-216	150**	3
216-960	200**	3
Above 960	500	3

\*\* Except as provided in paragraph (g), fundamental emissions from intentional radiators operating under this section shall not be located in the frequency bands 54-72 MHz, 76-88 MHz, 174-216 MHz or 470-806 MHz. However, operation within these frequency bands is permitted under other sections of this part, e.g.§§ 15.231 and 15.241.

**3.4 Test Result**

**Compliance**

The final test data are shown on the following page(s).

**Radiated Emission Test Data (Field Strength of Fundamental)**

Temperature : 27.5°C Humidity : 47%  
 Test Date : 13-June-2017 Tested by : Eason Hsieh  
 Polarization : Vertical Channel : CH00, 20, 39  
 EUT Position : Horizontal

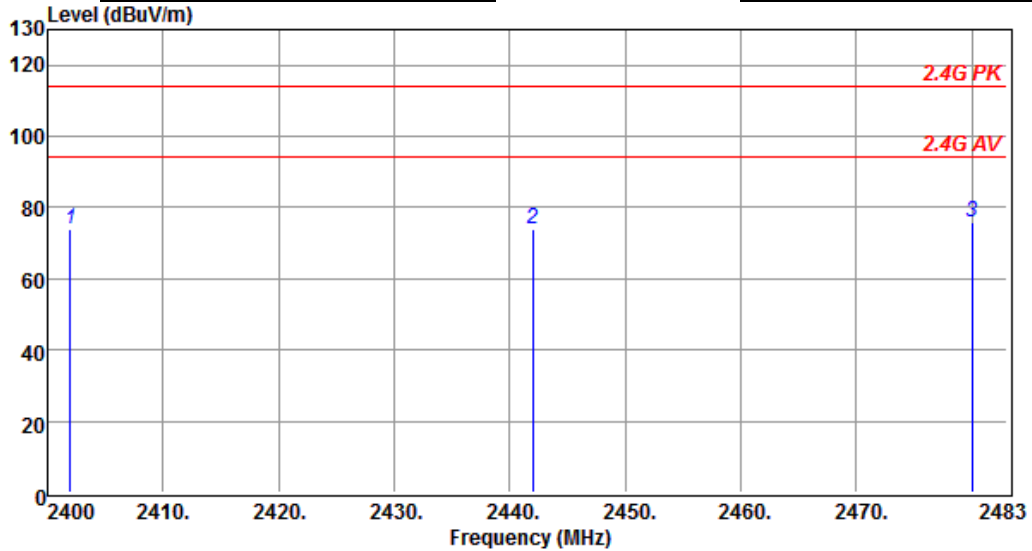

Freq	Reading	C.F	Result	Limit	Margin	A/H	T/P	Polarity	Remark
MHz	dBuV	dB	dBuV/m	dBuV/m	dB	cm	deg		
2402.000	81.01	-7.04	73.97	94.00	-20.03			VERTICAL	Peak
2442.000	80.94	-6.89	74.05	94.00	-19.95			VERTICAL	Peak
2480.000	82.72	-6.79	75.93	94.00	-18.07			VERTICAL	Peak

Note1: C.F (Correction Factor) = Antenna factor + Cable loss - Preamp gain  
 Note2: Margin = Result - Limit

Remark :

1. Measuring frequencies from 1 GHz to the 10<sup>th</sup> harmonic of highest fundamental frequency.
2. Measurements above show only up to 6 maximum emissions noted, or would be lesser if no specific emissions from the EUT are recorded (ie: margin > 20dB from the applicable limit) and considered that's already beyond the background noise floor.
3. Radiated emissions measured in frequency above 1000 MHz were made with an instrument using Peak detector mode and average detector mode of the emission shown in Actual FS column.
4. All readings are Peak values. None of the peak value reading exceeds the A.V. limit. Hence, A.V. reading was not measured.
5. Spectrum setting:  
 Peak Setting 1GHz to 10<sup>th</sup> harmonics of fundamental, RBW = 3MHz, VBW =10MHz, Sweep = AUTO.  
 Note: Because the 20 dB Bandwidth is over 1MHz, the RBW setting of measuring Field strength of Fundamental should be 3MHz, and VBW should be at 10 MHz.

**Radiated Emission Test Data (Field Strength of Fundamental)**

Temperature : 27.5°C Humidity : 47%  
 Test Date : 13-June-2017 Tested by : Eason Hsieh  
 Polarization : Horizontal Channel : CH00, 20, 39  
 EUT Position : Horizontal

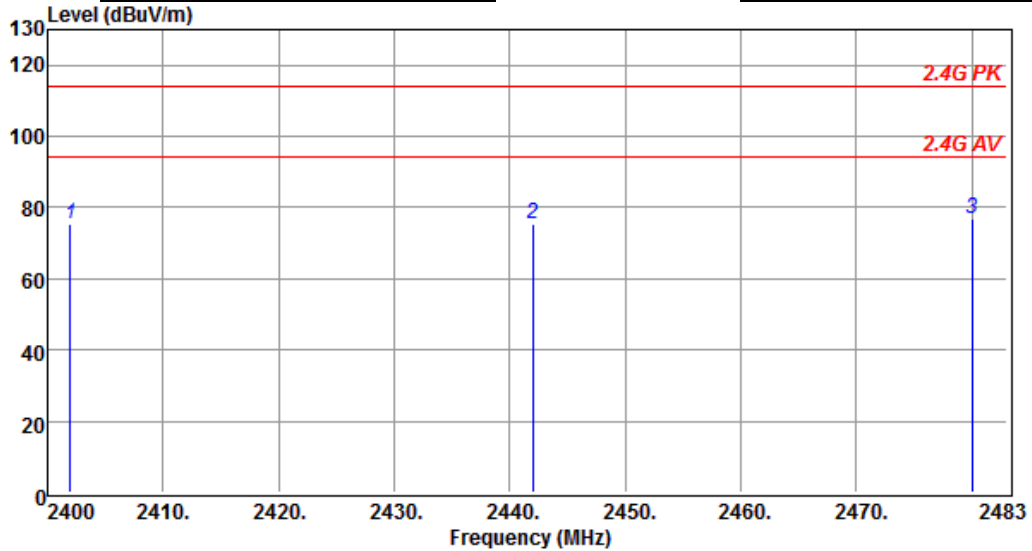

Freq	Reading	C.F	Result	Limit	Margin	A/H	T/P	Polarity	Remark
MHz	dBuV	dB	dBuV/m	dBuV/m	dB	cm	deg		
2402.000	82.31	-7.04	75.27	94.00	-18.73			HORIZONTAL	Peak
2442.000	82.36	-6.89	75.47	94.00	-18.53			HORIZONTAL	Peak
2480.000	83.47	-6.79	76.68	94.00	-17.32			HORIZONTAL	Peak

Note1: C.F (Correction Factor) = Antenna factor + Cable loss - Preamp gain  
 Note2: Margin = Result - Limit

Remark :

1. Measuring frequencies from 1 GHz to the 10<sup>th</sup> harmonic of highest fundamental frequency.
2. Measurements above show only up to 6 maximum emissions noted, or would be lesser if no specific emissions from the EUT are recorded (ie: margin > 20dB from the applicable limit) and considered that's already beyond the background noise floor.
3. Radiated emissions measured in frequency above 1000 MHz were made with an instrument using Peak detector mode and average detector mode of the emission shown in Actual FS column.
4. All readings are Peak values. None of the peak value reading exceeds the A.V. limit. Hence, A.V. reading was not measured.
5. Spectrum setting:  
 Peak Setting 1GHz to 10<sup>th</sup> harmonics of fundamental, RBW = 3MHz, VBW =10MHz, Sweep = AUTO.  
 Note: Because the 20 dB Bandwidth is over 1MHz, the RBW setting of measuring Field strength of Fundamental should be 3MHz, and VBW should be at 10 MHz.

**Radiated Emission Test Data (Below 1 GHz)**

Temperature	: 27.5°C	Humidity	: 47%
Test Date	: 13-June-2017	Tested by	: Eason Hsieh
Polarization	: Vertical	Channel	: CH00
EUT Position	: Horizontal		

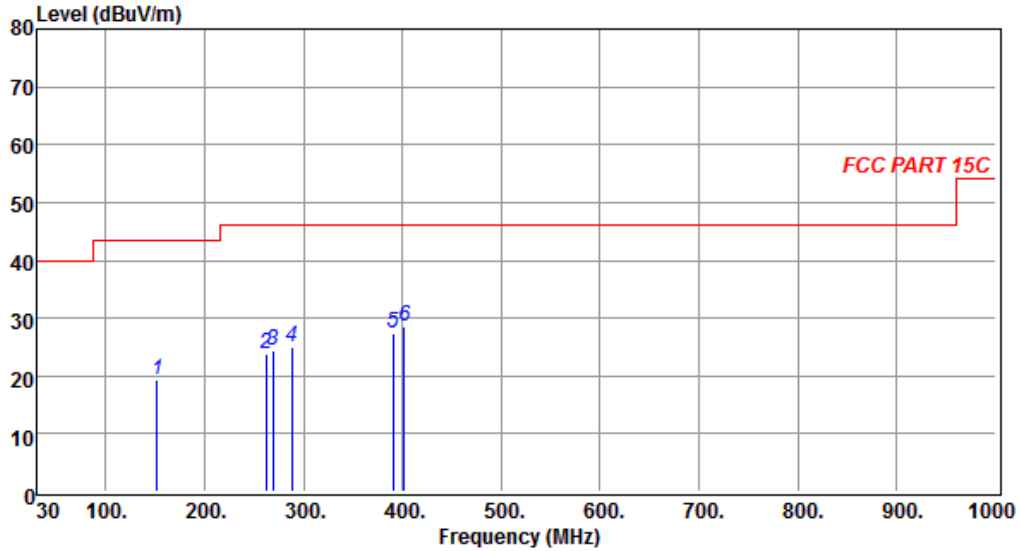

Freq	Reading	C.F	Result	Limit	Margin	A/H	T/P	Polarity	Remark
MHz	dBuV	dB	dBuV/m	dBuV/m	dB	cm	deg		
152.220	31.09	-11.86	19.23	43.50	-24.27	---	---	VERTICAL	Peak
261.830	32.25	-8.46	23.79	46.00	-22.21	---	---	VERTICAL	Peak
268.620	33.53	-9.21	24.32	46.00	-21.68	---	---	VERTICAL	Peak
288.020	34.10	-9.22	24.88	46.00	-21.12	---	---	VERTICAL	Peak
390.840	33.71	-6.36	27.35	46.00	-18.65	---	---	VERTICAL	Peak
401.510	34.45	-6.01	28.44	46.00	-17.56	---	---	VERTICAL	Peak

Note1: C.F (Correction Factor) = Antenna factor + Cable loss - Preamp gain  
 Note2: Margin = Result - Limit

Remark :

1. Measuring frequencies from 30 MHz to 1 GHz.
2. Radiated emissions measured in frequency range from 30 MHz to 1000 MHz were made with an instrument using Peak detector mode.
3. Data of measurement within this frequency range shown "---" in the table above means the reading of emissions are attenuated more than 20 dB below the permissible limits or the field strength is too small to be measured.
4. All readings are Peak values. None of the peak value reading exceeds the Q.P. limit. Hence, Q.P. reading was not measured.
5. The IF bandwidth of SPA between 30 MHz to 1 GHz was 100 kHz.

**Radiated Emission Test Data (Below 1 GHz)**

Temperature	: 27.5°C	Humidity	: 47%
Test Date	: 13-June-2017	Tested by	: Eason Hsieh
Polarization	: Horizontal	Channel	: CH00
EUT Position	: Horizontal		

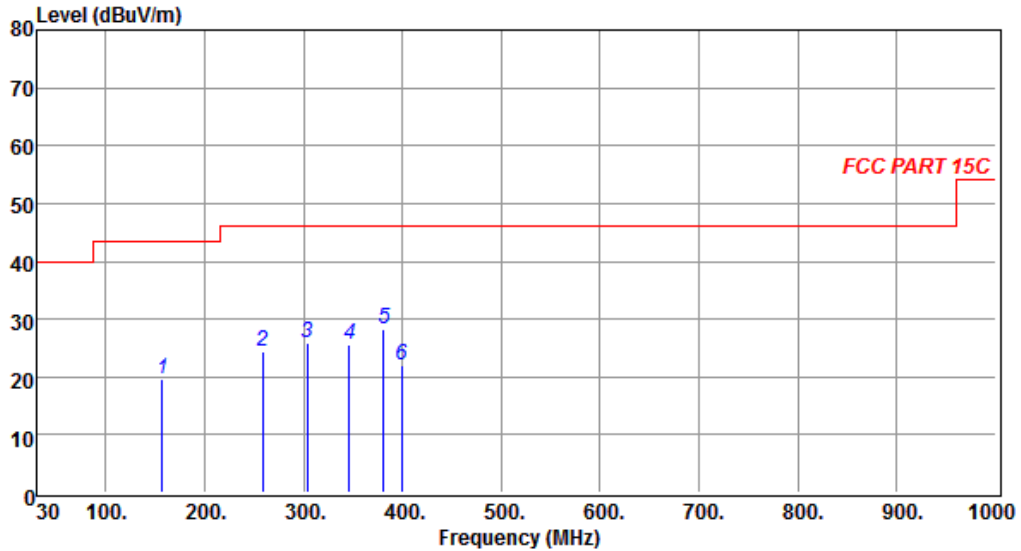

Freq	Reading	C.F	Result	Limit	Margin	A/H	T/P	Polarity	Remark
MHz	dBuV	dB	dBuV/m	dBuV/m	dB	cm	deg		
157.070	31.63	-12.08	19.55	43.50	-23.95	---	---	HORIZONTAL	Peak
258.920	32.81	-8.41	24.40	46.00	-21.60	---	---	HORIZONTAL	Peak
303.540	34.89	-8.92	25.97	46.00	-20.03	---	---	HORIZONTAL	Peak
346.220	33.49	-7.84	25.65	46.00	-20.35	---	---	HORIZONTAL	Peak
381.140	34.88	-6.70	28.18	46.00	-17.82	---	---	HORIZONTAL	Peak
399.570	28.15	-6.07	22.08	46.00	-23.92	---	---	HORIZONTAL	Peak

Note1: C.F (Correction Factor) = Antenna factor + Cable loss - Preamp gain  
 Note2: Margin = Result - Limit

Remark :

1. Measuring frequencies from 30 MHz to 1 GHz.
2. Radiated emissions measured in frequency range from 30 MHz to 1000 MHz were made with an instrument using Peak detector mode.
3. Data of measurement within this frequency range shown “---” in the table above means the reading of emissions are attenuated more than 20 dB below the permissible limits or the field strength is too small to be measured.
4. All readings are Peak values. None of the peak value reading exceeds the Q.P. limit. Hence, Q.P. reading was not measured.
5. The IF bandwidth of SPA between 30 MHz to 1 GHz was 100 kHz.

**Radiated Emission Test Data (Above 1G and Field Strength to 10th Harmonic)**

Temperature	: 27.5°C	Humidity	: 47%
Test Date	: 13-June-2017	Tested by	: Eason Hsieh
Polarization	: Vertical	Channel	: CH00 (2402MHz)
EUT Position	: Horizontal		

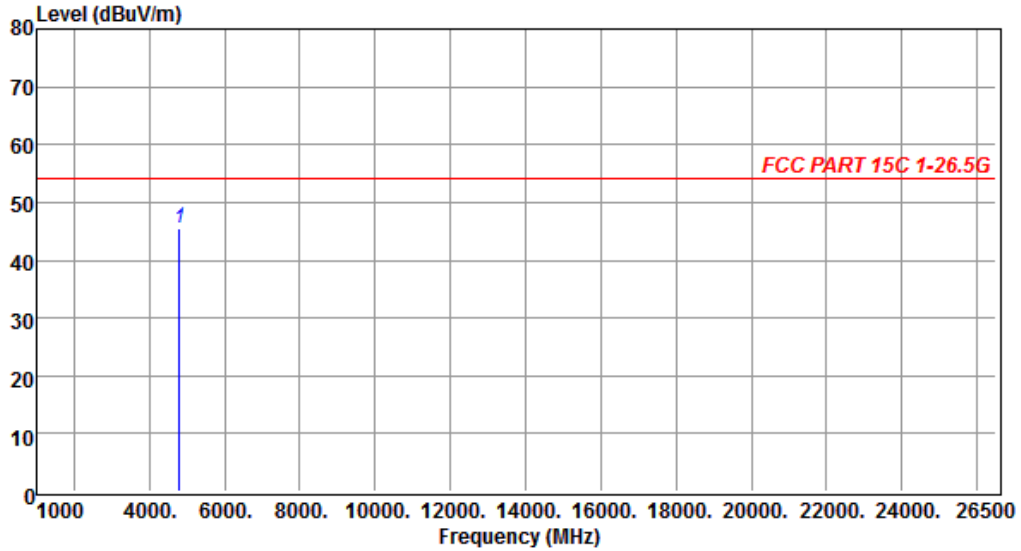

Freq	Reading	C.F	Result	Limit	Margin	A/H	T/P	Polarity	Remark
MHz	dBuV	dB	dBuV/m	dBuV/m	dB	cm	deg		
4804.000	42.71	2.77	45.48	54.00	-8.52			VERTICAL	Peak

Note1: C.F (Correction Factor) = Antenna factor + Cable loss - Preamp gain  
 Note2: Margin = Result - Limit

Remark :

1. Measuring frequencies from 1 GHz to the 10<sup>th</sup> harmonic of highest fundamental frequency.
2. Measurements above show only up to 6 maximum emissions noted, or would be lesser if no specific emissions from the EUT are recorded (ie: margin > 20dB from the applicable limit) and considered that's already beyond the background noise floor.
3. Radiated emissions measured in frequency above 1000 MHz were made with an instrument using Peak detector mode.
4. All readings are Peak values. None of the peak value reading exceeds the A.V. limit. Hence, A.V. reading was not measured.
5. Spectrum setting:
  - (a) Peak Setting 1GHz to 10<sup>th</sup> harmonics of fundamental, RBW = VBW = 1MHz, Sweep = AUTO.

**Radiated Emission Test Data (Above 1G and Field Strength to 10th Harmonic)**

Temperature	: 27.5°C	Humidity	: 47%
Test Date	: 13-June-2017	Tested by	: Eason Hsieh
Polarization	: Horizontal	Channel	: CH00 (2402MHz)
EUT Position	: Horizontal		

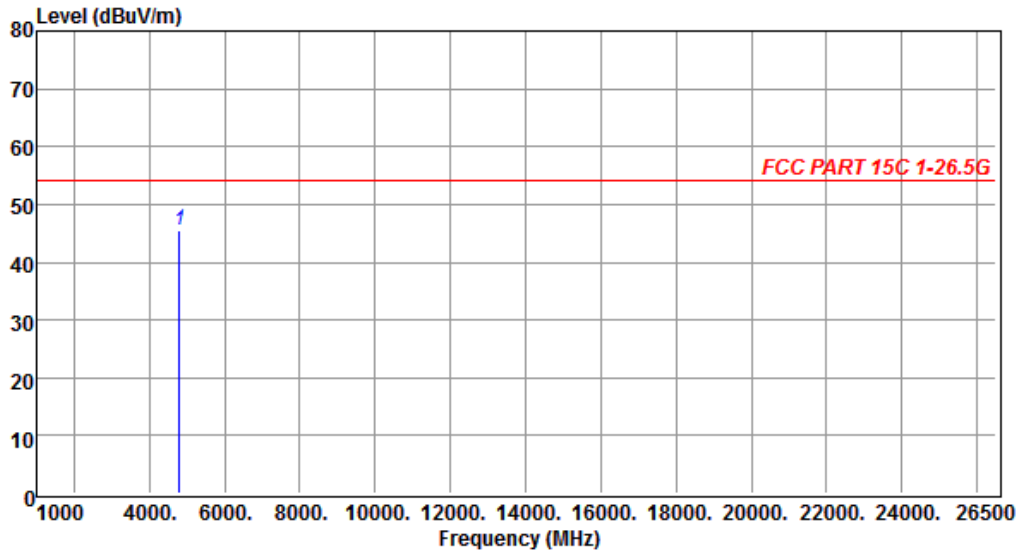

Freq	Reading	C.F	Result	Limit	Margin	A/H	T/P	Polarity	Remark
MHz	dBuV	dB	dBuV/m	dBuV/m	dB	cm	deg		
4804.000	42.82	2.77	45.59	54.00	-8.41			HORIZONTAL	Peak

Note1: C.F (Correction Factor) = Antenna factor + Cable loss - Preamp gain  
 Note2: Margin = Result - Limit

Remark :

1. Measuring frequencies from 1 GHz to the 10<sup>th</sup> harmonic of highest fundamental frequency.
2. Measurements above show only up to 6 maximum emissions noted, or would be lesser if no specific emissions from the EUT are recorded (ie: margin > 20dB from the applicable limit) and considered that's already beyond the background noise floor.
3. Radiated emissions measured in frequency above 1000 MHz were made with an instrument using Peak detector mode.
4. All readings are Peak values. None of the peak value reading exceeds the A.V. limit. Hence, A.V. reading was not measured.
5. Spectrum setting:
  - (a) Peak Setting 1GHz to 10<sup>th</sup> harmonics of fundamental, RBW = VBW = 1MHz, Sweep = AUTO.

**Radiated Emission Test Data (Above 1G and Field Strength to 10th Harmonic)**

Temperature	: 27.5°C	Humidity	: 47%
Test Date	: 13-June-2017	Tested by	: Eason Hsieh
Polarization	: Vertical	Channel	: CH20 (2442MHz)
EUT Position	: Horizontal		

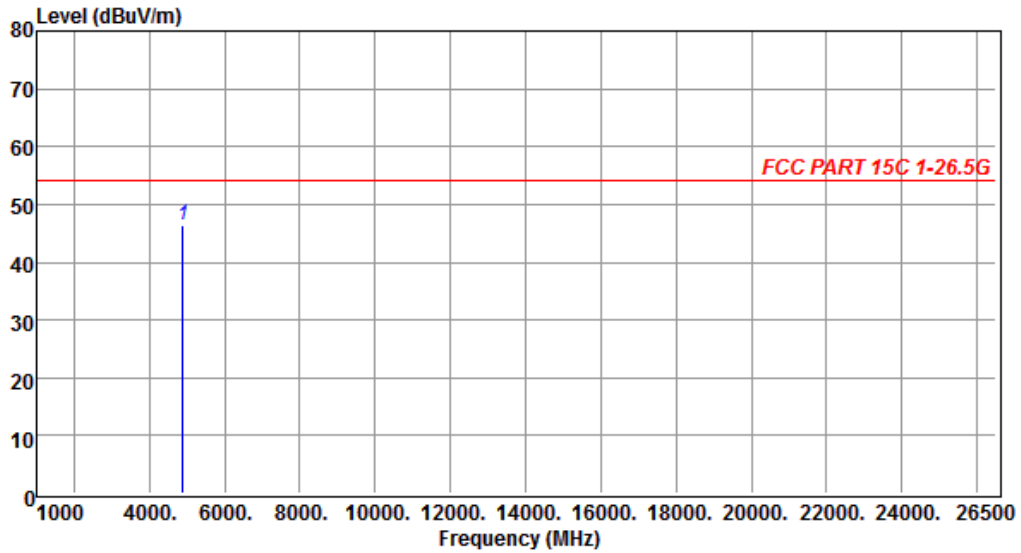

Freq	Reading	C.F	Result	Limit	Margin	A/H	T/P	Polarity	Remark
MHz	dBuV	dB	dBuV/m	dBuV/m	dB	cm	deg		
4884.000	43.54	2.94	46.48	54.00	-7.52			VERTICAL	Peak

Note1: C.F (Correction Factor) = Antenna factor + Cable loss - Preamp gain  
 Note2: Margin = Result - Limit

Remark :

1. Measuring frequencies from 1 GHz to the 10<sup>th</sup> harmonic of highest fundamental frequency.
2. Measurements above show only up to 6 maximum emissions noted, or would be lesser if no specific emissions from the EUT are recorded (ie: margin > 20dB from the applicable limit) and considered that's already beyond the background noise floor.
3. Radiated emissions measured in frequency above 1000 MHz were made with an instrument using Peak detector mode.
4. All readings are Peak values. None of the peak value reading exceeds the A.V. limit. Hence, A.V. reading was not measured.
5. Spectrum setting:
  - (a) Peak Setting 1GHz to 10<sup>th</sup> harmonics of fundamental, RBW = VBW = 1MHz, Sweep = AUTO.



**Radiated Emission Test Data (Above 1G and Field Strength to 10th Harmonic)**

Temperature	: 27.5°C	Humidity	: 47%
Test Date	: 13-June-2017	Tested by	: Eason Hsieh
Polarization	: Horizontal	Channel	: CH20 (2442MHz)
EUT Position	: Horizontal		

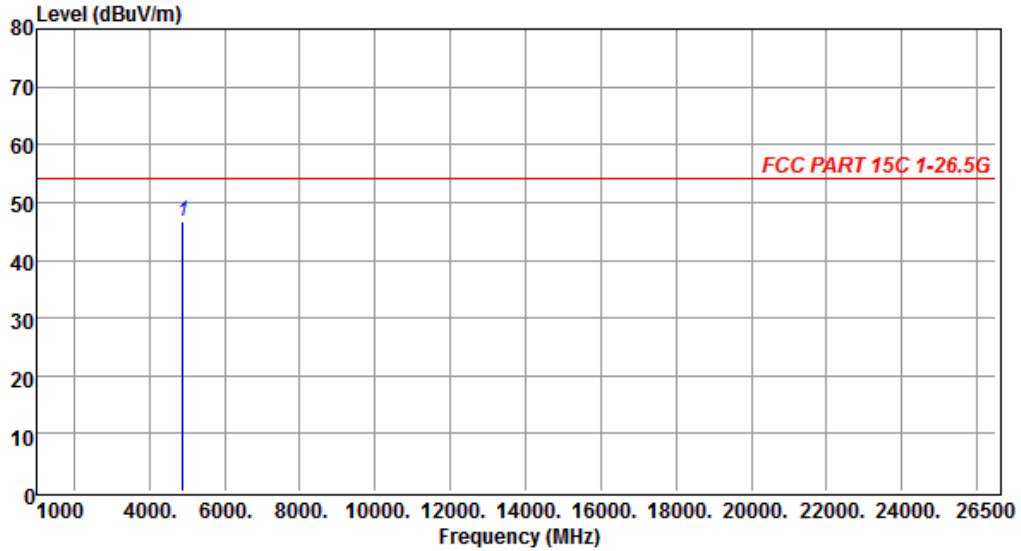

Freq	Reading	C.F	Result	Limit	Margin	A/H	T/P	Polarity	Remark
MHz	dBuV	dB	dBuV/m	dBuV/m	dB	cm	deg		
4884.000	43.88	2.94	46.82	54.00	-7.18			HORIZONTAL	Peak

Note1: C.F (Correction Factor) = Antenna factor + Cable loss - Preamp gain  
 Note2: Margin = Result - Limit

Remark :

1. Measuring frequencies from 1 GHz to the 10<sup>th</sup> harmonic of highest fundamental frequency.
2. Measurements above show only up to 6 maximum emissions noted, or would be lesser if no specific emissions from the EUT are recorded (ie: margin > 20dB from the applicable limit) and considered that's already beyond the background noise floor.
3. Radiated emissions measured in frequency above 1000 MHz were made with an instrument using Peak detector mode.
4. All readings are Peak values. None of the peak value reading exceeds the A.V. limit. Hence, A.V. reading was not measured.
5. Spectrum setting:
  - (a) Peak Setting 1GHz to 10<sup>th</sup> harmonics of fundamental, RBW = VBW = 1MHz, Sweep = AUTO.

**Radiated Emission Test Data (Above 1G and Field Strength to 10th Harmonic)**

Temperature	: 27.5°C	Humidity	: 47%
Test Date	: 13-June-2017	Tested by	: Eason Hsieh
Polarization	: Vertical	Channel	: CH39 (2480MHz)
EUT Position	: Horizontal		

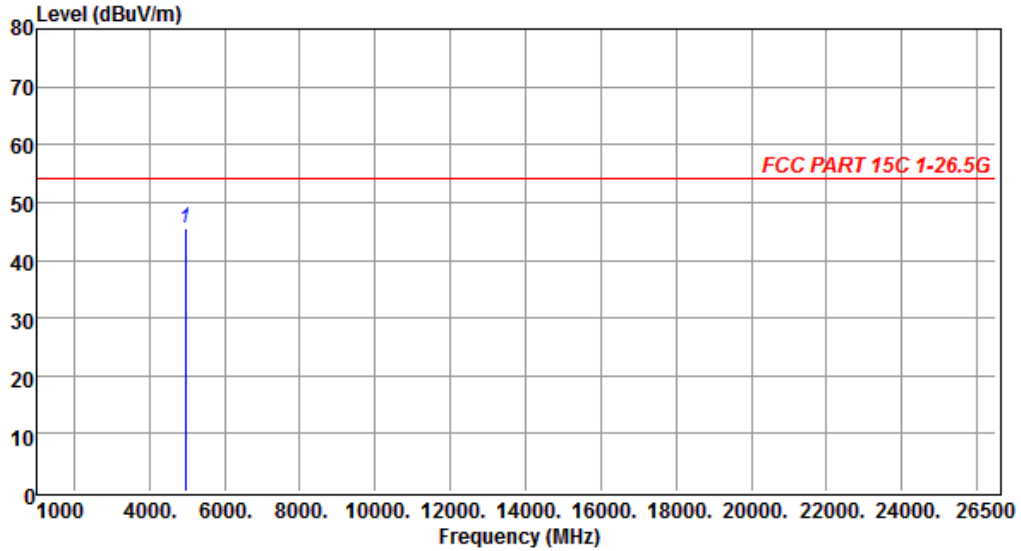

Freq	Reading	C.F	Result	Limit	Margin	A/H	T/P	Polarity	Remark
MHz	dBuV	dB	dBuV/m	dBuV/m	dB	cm	deg		
4960.000	42.34	3.15	45.49	54.00	-8.51			VERTICAL	Peak

Note1: C.F (Correction Factor) = Antenna factor + Cable loss - Preamp gain  
 Note2: Margin = Result - Limit

Remark :

1. Measuring frequencies from 1 GHz to the 10<sup>th</sup> harmonic of highest fundamental frequency.
2. Measurements above show only up to 6 maximum emissions noted, or would be lesser if no specific emissions from the EUT are recorded (ie: margin > 20dB from the applicable limit) and considered that's already beyond the background noise floor.
3. Radiated emissions measured in frequency above 1000 MHz were made with an instrument using Peak detector mode.
4. All readings are Peak values. None of the peak value reading exceeds the A.V. limit. Hence, A.V. reading was not measured.
5. Spectrum setting:
  - (a) Peak Setting 1GHz to 10<sup>th</sup> harmonics of fundamental, RBW = VBW = 1MHz, Sweep = AUTO.

**Radiated Emission Test Data (Above 1G and Field Strength to 10th Harmonic)**

Temperature	: 27.5°C	Humidity	: 47%
Test Date	: 13-June-2017	Tested by	: Eason Hsieh
Polarization	: Horizontal	Channel	: CH39 (2480MHz)
EUT Position	: Horizontal		

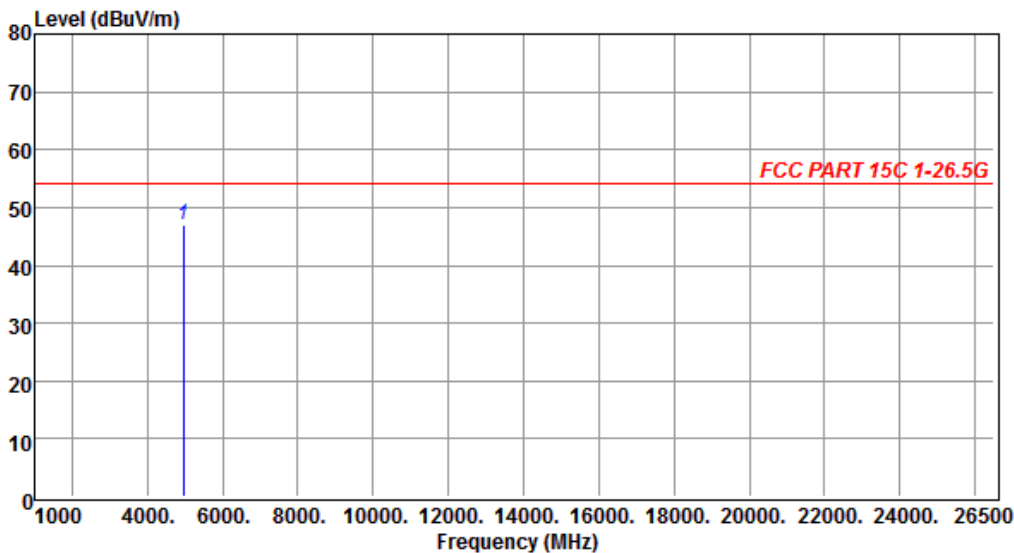

Freq	Reading	C.F	Result	Limit	Margin	A/H	T/P	Polarity	Remark
MHz	dBuV	dB	dBuV/m	dBuV/m	dB	cm	deg		
4960.000	43.74	3.15	46.89	54.00	-7.11			HORIZONTAL	Peak

Note1: C.F (Correction Factor) = Antenna factor + Cable loss - Preamp gain  
 Note2: Margin = Result - Limit

Remark :

1. Measuring frequencies from 1 GHz to the 10<sup>th</sup> harmonic of highest fundamental frequency.
2. Measurements above show only up to 6 maximum emissions noted, or would be lesser if no specific emissions from the EUT are recorded (ie: margin > 20dB from the applicable limit) and considered that's already beyond the background noise floor.
3. Radiated emissions measured in frequency above 1000 MHz were made with an instrument using Peak detector mode.
4. All readings are Peak values. None of the peak value reading exceeds the A.V. limit. Hence, A.V. reading was not measured.
5. Spectrum setting:
  - (a) Peak Setting 1GHz to 10<sup>th</sup> harmonics of fundamental, RBW = VBW = 1MHz, Sweep = AUTO.

## **4 Out of Band Emission Test**

### **4.1 Test Instruments**

Refer to Sec. 1.2 Test Instruments.

### **4.2 Test Arrangement and Procedure**

Refer to Sec. 3.2.

### **4.3 Limit of Field Strength of Fundamental (§ 15.249(d))**

Emissions radiated outside of the specified frequency bands, except for harmonics, shall be attenuated by at least 50 dB below the level of the fundamental or to the general radiated emission limits in § 15.209, whichever is the lesser attenuation.

### **4.4 Test Result**

#### **Compliance**

The final test data are shown on the following page(s).

**Band-Edge Test Data (Lower Edge)**

Temperature	: 27.5°C	Humidity	: 47%
Test Date	: 13-June-2017	Tested by	: Eason Hsieh
Polarization	: Vertical	Channel	: CH00
EUT Position	: Horizontal		

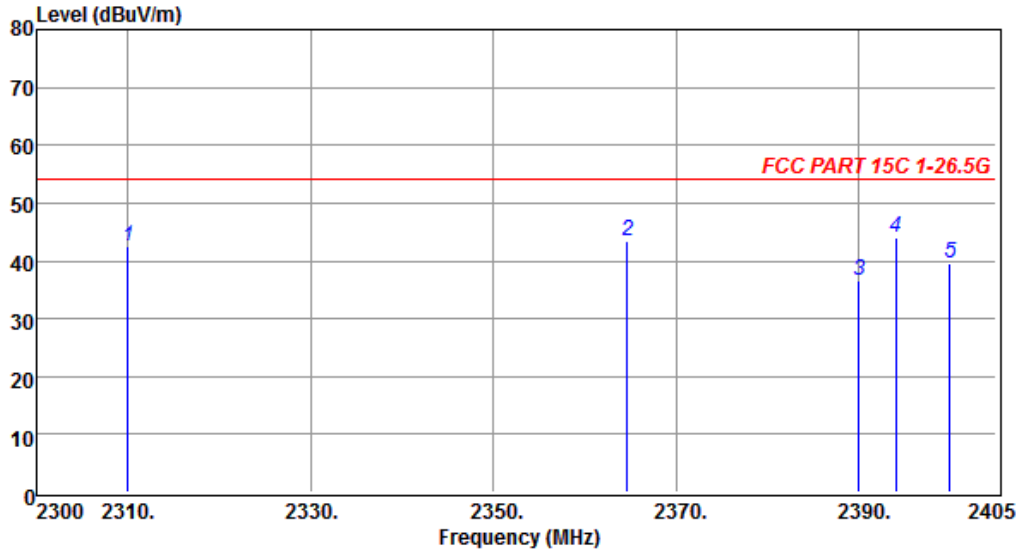

Freq	Reading	C.F	Result	Limit	Margin	A/H	T/P	Polarity	Remark
MHz	dBuV	dB	dBuV/m	dBuV/m	dB	cm	deg		
2310.000	48.51	-6.13	42.38	54.00	-11.62			VERTICAL	Peak
2364.680	49.52	-5.96	43.56	54.00	-10.44			VERTICAL	Peak
2390.000	42.35	-5.85	36.50	54.00	-17.50			VERTICAL	Peak
2394.080	49.73	-5.85	43.88	54.00	-10.12			VERTICAL	Peak
2400.000	45.47	-5.85	39.62	54.00	-14.38			VERTICAL	Peak

Note1: C.F (Correction Factor) = Antenna factor + Cable loss - Preamp gain  
 Note2: Margin = Result - Limit

Remark :

1. Measuring frequencies from 1 GHz to the 10<sup>th</sup> harmonic of highest fundamental frequency.
2. Measurements above show only up to 6 maximum emissions noted, or would be lesser if no specific emissions from the EUT are recorded (ie: margin > 20dB from the applicable limit) and considered that's already beyond the background noise floor.
3. Radiated emissions measured in frequency above 1000 MHz were made with an instrument using Peak detector mode and average detector mode of the emission shown in Actual FS column.
4. All readings are Peak values. None of the peak value reading exceeds the A.V. limit. Hence, A.V. reading was not measured.
5. Spectrum setting:
  - (a) Peak Setting 1GHz to 10<sup>th</sup> harmonics of fundamental, RBW = VBW = 1MHz, Sweep = AUTO.
  - (b) Average Setting 1GHz to 10<sup>th</sup> harmonics of fundamental, RBW = 1MHz, VBW = 10Hz, Sweep = AUTO.

**Band-Edge Test Data (Lower Edge)**

Temperature : 27.5°C Humidity : 47%  
 Test Date : 13-June-2017 Tested by : Eason Hsieh  
 Polarization : Horizontal Channel : CH00  
 EUT Position : Horizontal

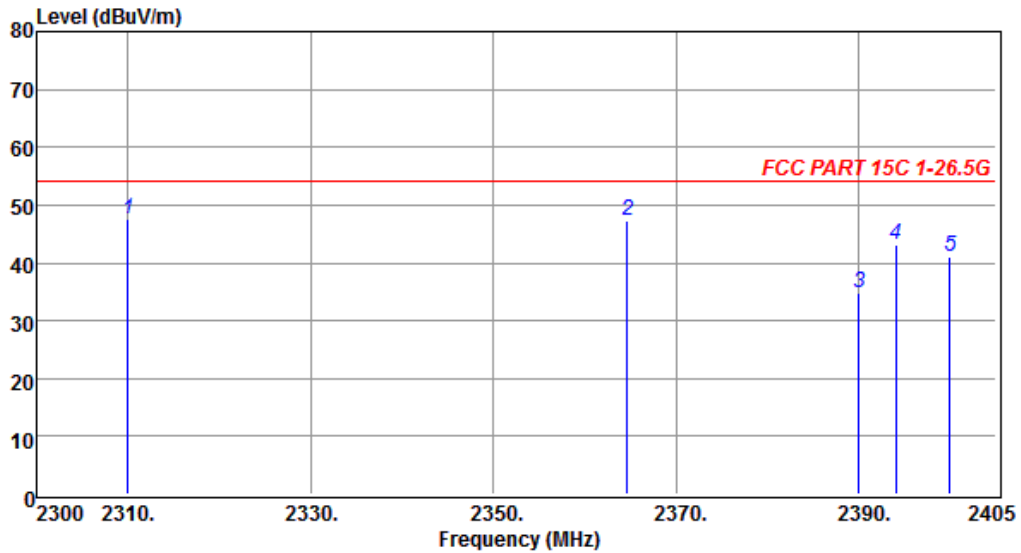

Freq	Reading	C.F	Result	Limit	Margin	A/H	T/P	Polarity	Remark
MHz	dBuV	dB	dBuV/m	dBuV/m	dB	cm	deg		
2310.000	53.70	-6.13	47.57	54.00	-6.43			HORIZONTAL	Peak
2364.680	53.13	-5.96	47.17	54.00	-6.83			HORIZONTAL	Peak
2390.000	40.54	-5.85	34.69	54.00	-19.31			HORIZONTAL	Peak
2394.080	48.94	-5.85	43.09	54.00	-10.91			HORIZONTAL	Peak
2400.000	46.91	-5.85	41.06	54.00	-12.94			HORIZONTAL	Peak

Note1: C.F (Correction Factor) = Antenna factor + Cable loss - Preamp gain  
 Note2: Margin = Result - Limit

Remark :

- Measuring frequencies from 1 GHz to the 10<sup>th</sup> harmonic of highest fundamental frequency.
- Measurements above show only up to 6 maximum emissions noted, or would be lesser if no specific emissions from the EUT are recorded (ie: margin > 20dB from the applicable limit) and considered that's already beyond the background noise floor.
- Radiated emissions measured in frequency above 1000 MHz were made with an instrument using Peak detector mode and average detector mode of the emission shown in Actual FS column.
- All readings are Peak values. None of the peak value reading exceeds the A.V. limit. Hence, A.V. reading was not measured.
- Spectrum setting:
  - Peak Setting 1GHz to 10<sup>th</sup> harmonics of fundamental, RBW = VBW = 1MHz, Sweep = AUTO.
  - Average Setting 1GHz to 10<sup>th</sup> harmonics of fundamental,; RBW = 1MHz, VBW = 10Hz, Sweep = AUTO.

### Band-Edge Test Data (Upper Edge)

Temperature	: 27.5°C	Humidity	: 47%
Test Date	: 13-June-2017	Tested by	: Eason Hsieh
Polarization	: Vertical	Channel	: CH39
EUT Position	: Horizontal		

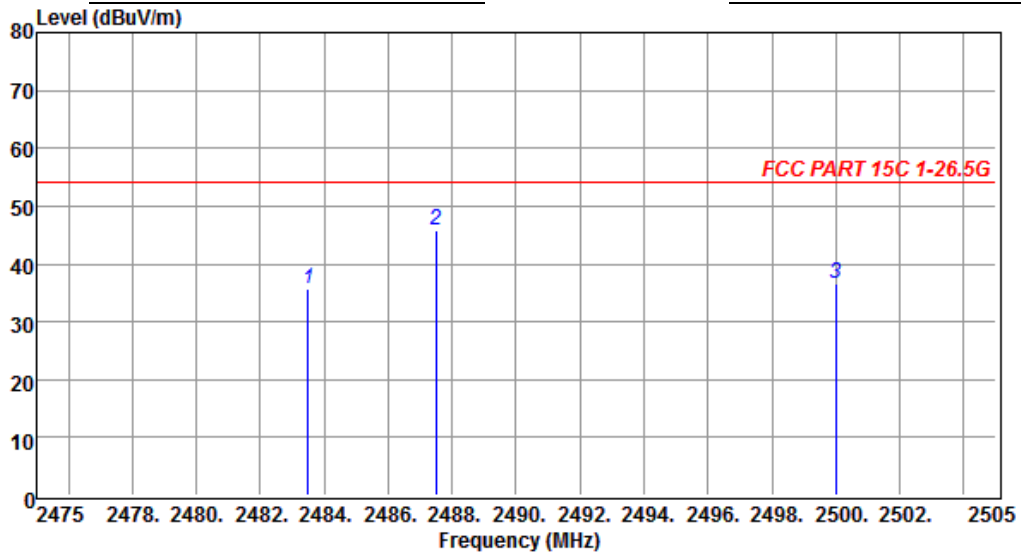

Freq	Reading	C.F	Result	Limit	Margin	A/H	T/P	Polarity	Remark
MHz	dBuV	dB	dBuV/m	dBuV/m	dB	cm	deg		
2483.500	41.14	-5.58	35.56	54.00	-18.44			VERTICAL	Peak
2487.500	51.30	-5.53	45.77	54.00	-8.23			VERTICAL	Peak
2500.000	42.18	-5.53	36.65	54.00	-17.35			VERTICAL	Peak

Note1: C.F (Correction Factor) = Antenna factor + Cable loss - Preamp gain  
 Note2: Margin = Result - Limit

Remark :

- Measuring frequencies from 1 GHz to the 10<sup>th</sup> harmonic of highest fundamental frequency.
- Measurements above show only up to 6 maximum emissions noted, or would be lesser if no specific emissions from the EUT are recorded (ie: margin > 20dB from the applicable limit) and considered that's already beyond the background noise floor.
- Radiated emissions measured in frequency above 1000 MHz were made with an instrument using Peak detector mode and average detector mode of the emission shown in Actual FS column.
- All readings are Peak values. None of the peak value reading exceeds the A.V. limit. Hence, A.V. reading was not measured.
- Spectrum setting:
  - Peak Setting 1GHz to 10<sup>th</sup> harmonics of fundamental, RBW = VBW = 1MHz, Sweep = AUTO.
  - Average Setting 1GHz to 10<sup>th</sup> harmonics of fundamental, RBW = 1MHz, VBW = 10Hz, Sweep = AUTO.

### Band-Edge Test Data (Upper Edge)

Temperature	: 27.5°C	Humidity	: 47%
Test Date	: 13-June-2017	Tested by	: Eason Hsieh
Polarization	: Horizontal	Channel	: CH39
EUT Position	: Horizontal		

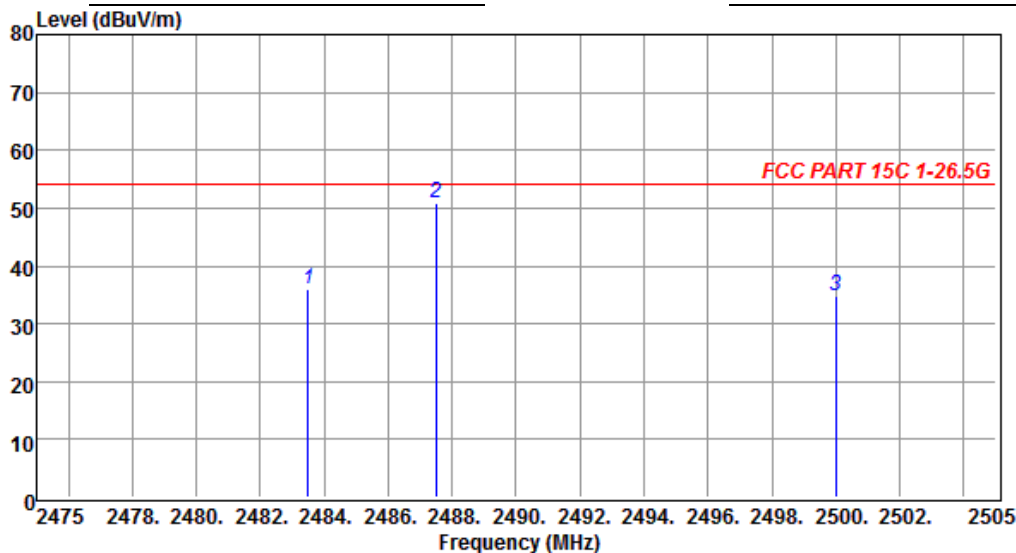

Freq	Reading	C.F	Result	Limit	Margin	A/H	T/P	Polarity	Remark
MHz	dBuV	dB	dBuV/m	dBuV/m	dB	cm	deg		
2483.500	41.47	-5.58	35.89	54.00	-18.11			HORIZONTAL	Peak
2487.500	56.35	-5.53	50.82	54.00	-3.18			HORIZONTAL	Peak
2500.000	40.38	-5.53	34.85	54.00	-19.15			HORIZONTAL	Peak

Note1: C.F (Correction Factor) = Antenna factor + Cable loss - Preamp gain  
 Note2: Margin = Result - Limit

Remark :

1. Measuring frequencies from 1 GHz to the 10<sup>th</sup> harmonic of highest fundamental frequency.
2. Measurements above show only up to 6 maximum emissions noted, or would be lesser if no specific emissions from the EUT are recorded (ie: margin > 20dB from the applicable limit) and considered that's already beyond the background noise floor.
3. Radiated emissions measured in frequency above 1000 MHz were made with an instrument using Peak detector mode and average detector mode of the emission shown in Actual FS column.
4. All readings are Peak values. None of the peak value reading exceeds the A.V. limit. Hence, A.V. reading was not measured.
5. Spectrum setting:
  - (a) Peak Setting 1GHz to 10<sup>th</sup> harmonics of fundamental, RBW = VBW = 1MHz, Sweep = AUTO.
  - (b) Average Setting 1GHz to 10<sup>th</sup> harmonics of fundamental, RBW = 1MHz, VBW = 10Hz, Sweep = AUTO.



## 5 20 dB Bandwidth

### 5.1 Test Instruments

Refer to Sec. 1.2 Test Instruments.

### 5.2 Test Arrangement and Procedure



1. The transmitter output was connected to a spectrum analyzer (through an attenuator, if it's necessary).
2. The bandwidth of the fundamental frequency was measured by spectrum analyzer with 30kHz RBW and 100kHz VBW. Measured the -20 dB bandwidth and plotted the graph.

### 5.3 Limit

None; For report purpose only.

### 5.4 Test Result

**No non-compliance noted.**

The final test data are shown on the following page(s).

Bluetooth 1 Mbps (DH5)		
Channel	Frequency (MHz)	20dB Bandwidth (MHz)
Low	2402	1.2243
Middle	2442	1.233
High	2480	1.233

Temperature	: 27.5°C	Humidity	: 47%
Test Date	: 13-June-2017	Tested by	: Eason Hsieh
Test Mode	: BT (1 Mbps) DH5	Channel	: 00

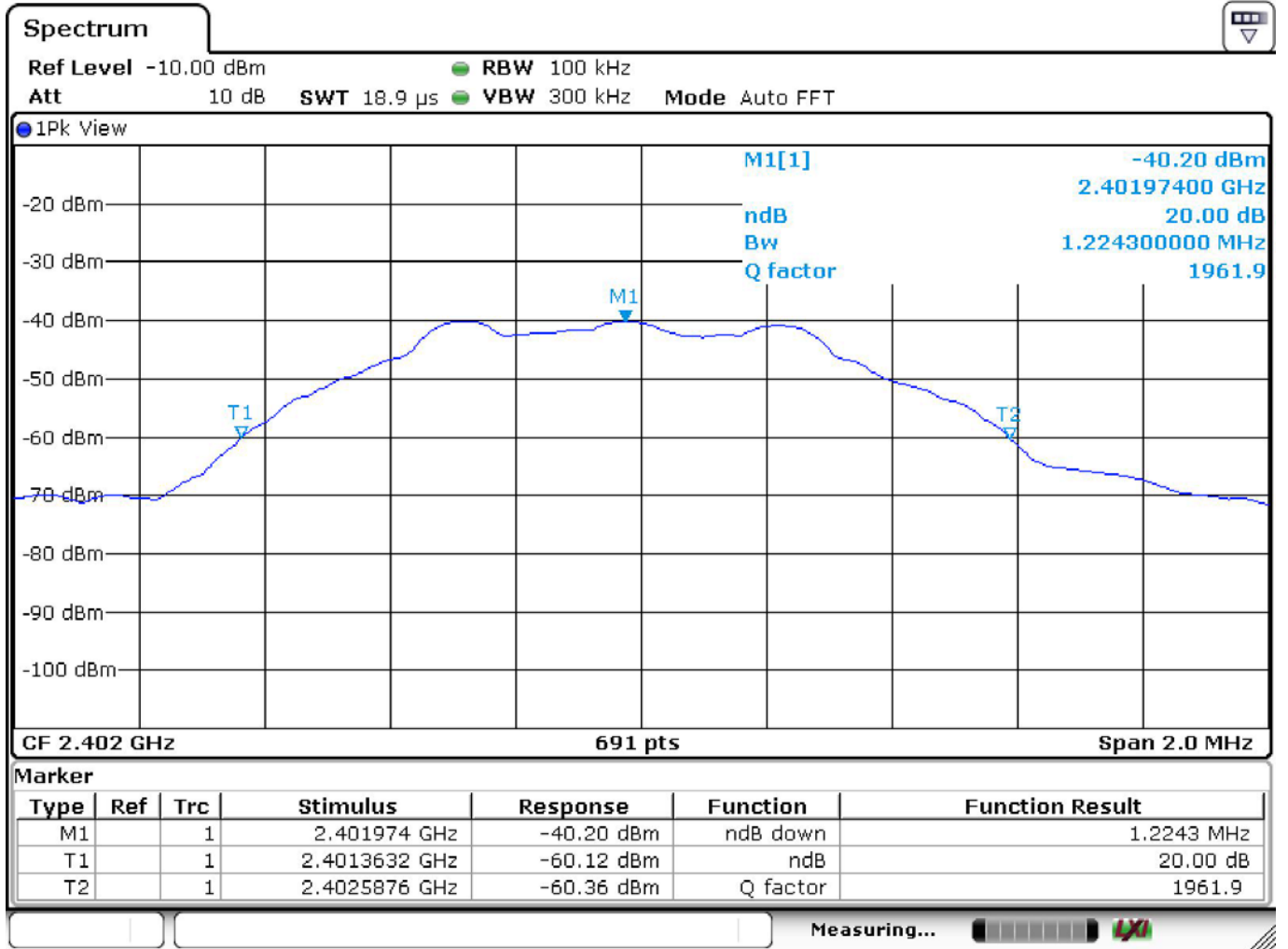

Test Mode : BT (1 Mbps) DH5 Channel : 20

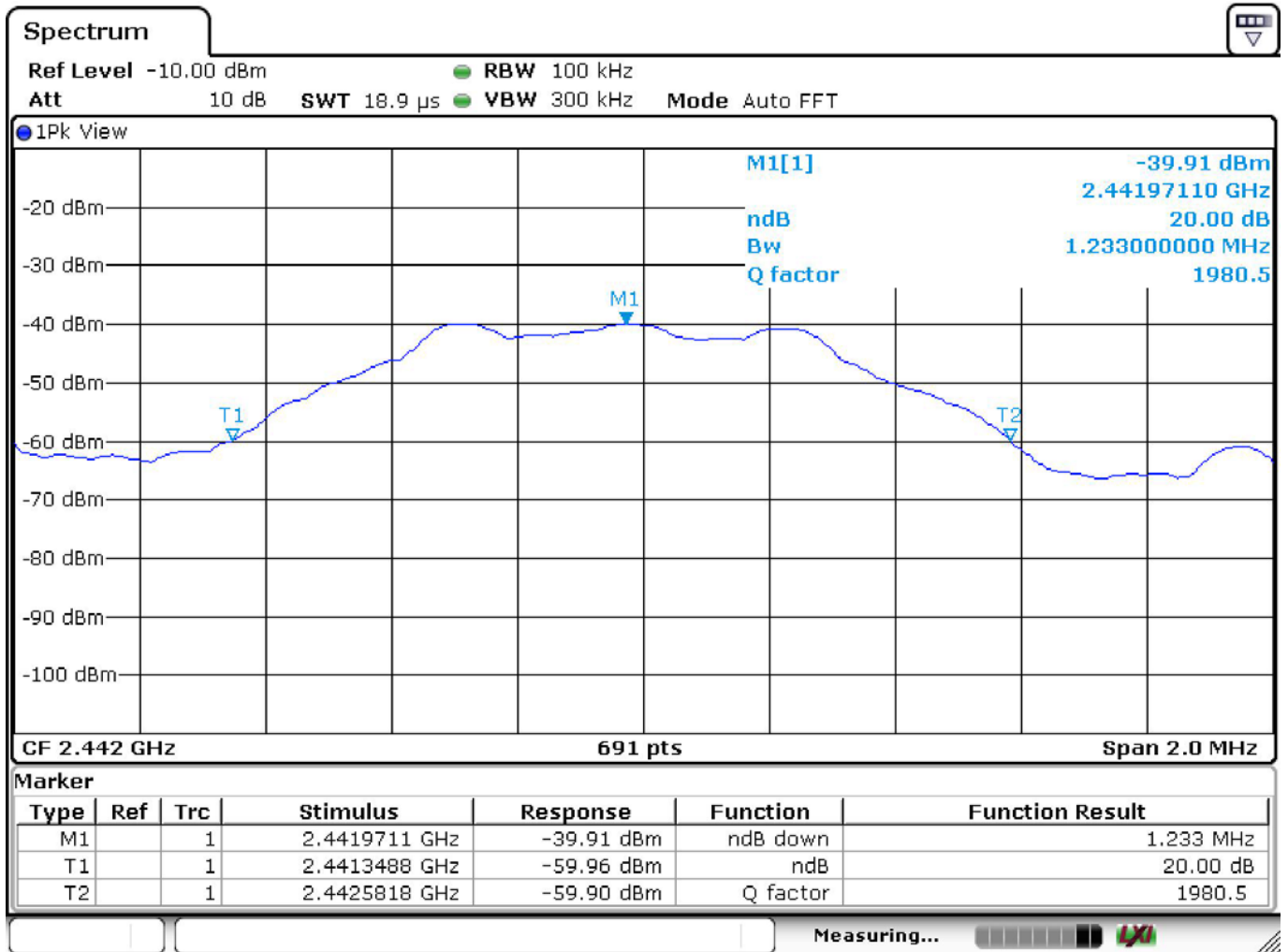

Test Mode : BT (1 Mbps) DH5 Channel : 39

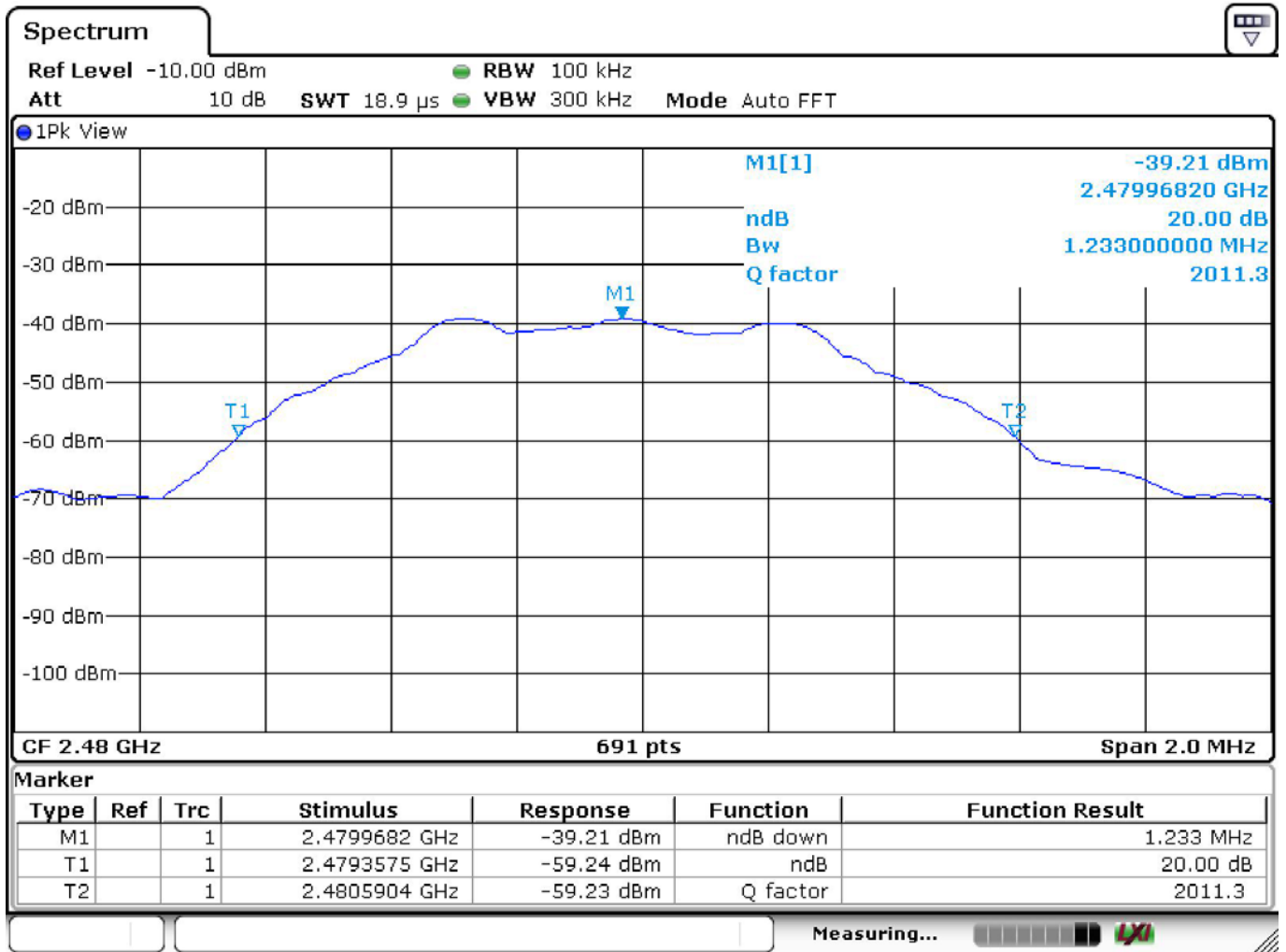

## 6 Antenna requirement

### 6.1 Limit (§ 15.203)

An intentional radiator shall be designed to ensure that no antenna other than that furnished by the responsible party shall be used with the device. The use of a permanently attached antenna or of an antenna that uses a unique coupling to the intentional radiator shall be considered sufficient to comply with the provisions of this section. The manufacturer may design the unit so that a broken antenna can be replaced by the user, but the use of a standard antenna jack or electrical connector is prohibited. This requirement does not apply to carrier current devices or to devices operated under the provisions of § 15.211, § 15.213, § 15.217, § 15.219, or § 15.221. Further, this requirement does not apply to intentional radiators that must be professionally installed, such as perimeter protection systems and some field disturbance sensors, or to other intentional radiators which, in accordance with § 15.31(d), must be measured at the installation site. However, the installer shall be responsible for ensuring that the proper antenna is employed so that the limits in this part are not exceeded.

### 6.2 Test Result

#### **Compliance.**

The EUT applies a PCB antenna.

## 7 Information about the FHSS characteristics

### 7.1 Pseudorandom Frequency Hopping Sequence

The channel is represented by a pseudo-random hopping sequence hopping through the 79 RF channels.

The hopping sequence is unique for the piconet and is determined by the Bluetooth device address of the master; the phase in the hopping sequence is determined by the Bluetooth clock of the master.

The channel is divided into time slots where each slot corresponds to an RF hop frequency. Consecutive hops correspond to different RF hop frequencies. The nominal hop rate is 1600 hops/s.

### 7.2 Example of a 79 hopping sequence in data mode:

02, 05, 31, 24, 20, 10, 43, 36, 30, 23, 40, 06, 21, 50, 44, 09, 71, 78, 01, 13, 73, 07, 70, 72, 35, 62, 42, 11, 41, 08, 16, 29, 60, 15, 34, 61, 58, 04, 67, 12, 22, 53, 57, 18, 27, 76, 39, 32, 17, 77, 52, 33, 56, 46, 37, 47, 64, 49, 45, 38, 69, 14, 51, 26, 79, 19, 28, 65, 75, 54, 48, 03, 25, 66, 05, 16, 68, 74, 59, 63, 55

### 7.3 Equal Hopping Frequency Use

Due to each the GFSK,  $\pi/4$ -DQPSK and 8-DPSK modulation of hopping frequency will be transmitted in accordance to the frequency tables described above, there is no any frequency will be able to hop more times than other. Therefore each frequency will be used equally.

— End of Test Report —