

# TEST REPORT

of

FCC Part 15 Subpart E §15.407

FCC ID: TQ8-DA333SXIG

Equipment Under Test : DISPLAY CAR SYSTEM  
Model Name : DA333SXIG  
Variant Model Names : Refer to page 4  
Applicant : Hyundai Mobis Co., Ltd.  
Manufacturer : Hyundai Mobis Co., Ltd.  
Date of Receipt : 2020.01.03  
Date of Test(s) : 2020.01.26 ~ 2020.02.17  
Date of Issue : 2020.02.27

In the configuration tested, the EUT complied with the standards specified above.

Tested By:



Jinhyoung Cho

Date:

2020.02.27

Technical  
Manager:



Jungmin Yang

Date:

2020.02.27

*The results of this test report are effective only to the items tested. The SGS Korea is not responsible for the sampling, the results of this test report apply to the sample as received. This test report cannot be reproduced, except in full, without prior written permission of the Company. This test report does not assure KOLAS accreditation.*

SGS Korea Co., Ltd. (Gunpo Laboratory) 4, LS-ro 182beon-gil, Gunpo-si, Gyeonggi-do, Korea, 15807 <http://www.sgsgroup.kr>

# INDEX

## Table of contents

|   |   |
|---|---|
| 1. General Information .....              | 3 |
| 2. DFS (Dynamic Frequency Selection)..... | 7 |

---

*The results of this test report are effective only to the items tested. The SGS Korea is not responsible for the sampling, the results of this test report apply to the sample as received. This test report cannot be reproduced, except in full, without prior written permission of the Company. This test report does not assure KOLAS accreditation.*

**SGS Korea Co., Ltd. (Gunpo Laboratory)** 4, LS-ro 182beon-gil, Gunpo-si, Gyeonggi-do, Korea, 15807 <http://www.sgsgroup.kr>

## 1. General Information

### 1.1. Testing Laboratory

SGS Korea Co., Ltd. (Gunpo Laboratory)

- 10-2, LS-ro 182beon-gil, Gunpo-si, Gyeonggi-do, Korea, 15807
- 4, LS-ro 182beon-gil, Gunpo-si, Gyeonggi-do, Korea, 15807
- Designation number: KR0150

All SGS services are rendered in accordance with the applicable SGS conditions of service available on request and accessible at <http://www.sgs.com/en/Terms-and-Conditions.aspx>.

Phone No. : +82 31 688 0901

Fax No. : +82 31 688 0921

### 1.2. Details of Applicant

Applicant : Hyundai Mobis Co., Ltd.

Address : 203, Teheran-ro, Gangnam-gu, Seoul, South Korea, 135-977

Contact Person : Choe, Seung-hoon

Phone No. : +82 31 260 0098

### 1.3. Details of Manufacturer

Company : Same as applicant

Address : Same as applicant

---

*The results of this test report are effective only to the items tested. The SGS Korea is not responsible for the sampling, the results of this test report apply to the sample as received. This test report cannot be reproduced, except in full, without prior written permission of the Company. This test report does not assure KOLAS accreditation.*

**SGS Korea Co., Ltd. (Gunpo Laboratory)** 4, LS-ro 182beon-gil, Gunpo-si, Gyeonggi-do, Korea, 15807 <http://www.sgsgroup.kr>

#### 1.4. Description of EUT

|                             |  |
|-----------------------------|--|
| <b>Kind of Product</b>      | DISPLAY CAR SYSTEM   |
| <b>Model Name</b>           | DA333SXIG  |
| <b>Variant Model Names</b>  | ADB10SXIG, ADB12SXIG, DA330SXIG, DA331SXIG, ADB11SXIG, ADB13SXIG, DA332SXIG, ADB10SXGG, ADB10SXGN, ADB10SXGL, ADB11SXGG, DA330SXGG, ADB10SXMG, ADB10SXFN, DA332SXGG, DA333SXGG, ADB12SXGG, ADB13SXGG   |
| <b>Power Supply</b>         | DC 14.4 V  |
| <b>Frequency Range</b>      | 5 180 MHz ~ 5 240 MHz (Band 1: 11a/n_HT20, 11ac_VHT20)<br>5 190 MHz ~ 5 230 MHz (Band 1: 11n_HT40, 11ac_VHT40)<br>5 210 MHz (Band 1: 11ac_VHT80)<br>5 260 MHz ~ 5 320 MHz (Band 2A: 11a/n_HT20, 11ac_VHT20)<br>5 270 MHz ~ 5 310 MHz (Band 2A: 11n_HT40, 11ac_VHT40)<br>5 290 MHz (Band 2A: 11ac_VHT80)<br>5 500 MHz ~ 5 720 MHz (Band 2C: 11a/n_HT20, 11ac_VHT20)<br>5 510 MHz ~ 5 710 MHz (Band 2C: 11n_HT40, 11ac_VHT40)<br>5 530 MHz ~ 5 690 MHz (Band 2C: 11ac_VHT80)<br>5 745 MHz ~ 5 825 MHz (Band 3: 11a/n_HT20, 11ac_VHT20)<br>5 755 MHz ~ 5 795 MHz (Band 3: 11n_HT40, 11ac_VHT40)<br>5 775 MHz (Band 3: 11ac_VHT80) |
| <b>Modulation Technique</b> | OFDM   |
| <b>Number of Channels</b>   | 4 channels (Band 1: 11a/n_HT20, 11ac_VHT20)<br>2 channels (Band 1: 11n_HT40, 11ac_VHT40)<br>1 channel (Band 1: 11ac_VHT80)<br>4 channels (Band 2A: 11a/n_HT20, 11ac_VHT20)<br>2 channels (Band 2A: 11n_HT40, 11ac_VHT40)<br>1 channel (Band 2A: 11ac_VHT80)<br>9 channels (Band 2C: 11a/n_HT20, 11ac_VHT20)<br>4 channels (Band 2C: 11n_HT40, 11ac_VHT40)<br>2 channels (Band 2C: 11ac_VHT80)<br>5 channels (Band 3: 11a/n_HT20, 11ac_VHT20)<br>2 channels (Band 3: 11n_HT40, 11ac_VHT40)<br>1 channel (Band 3: 11ac_VHT80)  |
| <b>Antenna Type</b>         | Pattern antenna  |
| <b>Antenna Gain</b>         | 5 150 MHz ~ 5 250 MHz: -0.61 dB i<br>5 250 MHz ~ 5 350 MHz: -0.18 dB i<br>5 470 MHz ~ 5 725 MHz: -0.77 dB i<br>5 725 MHz ~ 5 850 MHz: -0.18 dB i   |

#### 1.5. Declaration by the Manufacturer

- The EUT is a slave without radar detection and TPC.
- The EUT is not supported TDWR(5.6 - 5.65 GHz) band.

*The results of this test report are effective only to the items tested. The SGS Korea is not responsible for the sampling, the results of this test report apply to the sample as received. This test report cannot be reproduced, except in full, without prior written permission of the Company. This test report does not assure KOLAS accreditation.*

**SGS Korea Co., Ltd. (Gunpo Laboratory)** 4, LS-ro 182beon-gil, Gunpo-si, Gyeonggi-do, Korea, 15807 <http://www.sgsgroup.kr>

## 1.6. Test Equipment List

| Equipment         | Manufacturer     | Model      | S/N       | Cal. Date     | Cal. Interval | Cal. Due      |
|-------------------|------------------|------------|-----------|---------------|---------------|---------------|
| Signal Generator  | R&S              | SMBV100A   | 255834    | Jun. 10, 2019 | Annual        | Jun. 10, 2020 |
| Spectrum Analyzer | R&S              | FSV30      | 103453    | Nov. 06, 2019 | Annual        | Nov. 06, 2020 |
| Attenuator        | AEROFLEX / INMET | 18N-20dB   | 3         | Feb. 19, 2019 | Annual        | Feb. 19, 2020 |
| Power Splitter    | Mini-Circuits    | ZFSC-2-10G | 001       | Jun. 07, 2019 | Annual        | Jun. 07, 2020 |
| Power Splitter    | Mini-Circuits    | ZFSC-2-10G | 002       | Jun. 07, 2019 | Annual        | Jun. 07, 2020 |
| DC Power Supply   | R&S              | HMP2020    | 020089489 | May 21, 2019  | Annual        | May 21, 2020  |

### ► Support Equipment

| Description  | Manufacturer           | Model       | FCC ID     |
|--------------|------------------------|-------------|------------|
| Access Point | Aerohive networks Inc. | AP650X      | WBV-AP650X |
| Notebook     | LG Electronics Inc.    | LGE-DMLGA51 | -          |

## 1.7. Summary of Test Result

The EUT has been tested according to the following specifications:

| APPLIED STANDARD: FCC Part 15 Subpart E |   |          |
|---|---|----------|
| Section                                 | Test Item   | Result   |
| 15.407(h)                               | DFS<br>-Channel closing transmission time<br>-Channel move time<br>-Non occupied period | Complied |

## 1.8. Test Report Revision

| Revision | Report Number        | Date of Issue | Description |
|----------|----------------------|---------------|-------------|
| 0        | F690501-RF-RTL000330 | 2020.02.27    | Initial     |

*The results of this test report are effective only to the items tested. The SGS Korea is not responsible for the sampling, the results of this test report apply to the sample as received. This test report cannot be reproduced, except in full, without prior written permission of the Company. This test report does not assure KOLAS accreditation.*

**SGS Korea Co., Ltd. (Gunpo Laboratory) 4, LS-ro 182beon-gil, Gunpo-si, Gyeonggi-do, Korea, 15807** <http://www.sgsgroup.kr>

### 1.9. Information of Variant Models

|                | Model Name | BT/WIFI | Broadcast Freq. | DRM | Arkamys | HD | Ecall | RDS | RBDS | MIC type   |
|----------------|------------|---------|-----------------|-----|---------|----|-------|-----|------|------------|
| Basic Model    | DA333SXIG  | BT/WIFI | General         | O   | O       | -  | -     | -   | -    | OHCL       |
| Variant Models | ADB10SXIG  | BT      | General         | -   | O       | -  | -     | -   | -    | Headlining |
|                | ADB12SXIG  | BT      | General         | O   | O       | -  | -     | -   | -    | Headlining |
|                | DA330SXIG  | BT/WIFI | General         | -   | O       | -  | -     | -   | -    | Headlining |
|                | DA331SXIG  | BT/WIFI | General         | O   | O       | -  | -     | -   | -    | Headlining |
|                | ADB11SXIG  | BT      | General         | -   | O       | -  | -     | -   | -    | OHCL       |
|                | ADB13SXIG  | BT      | General         | O   | O       | -  | -     | -   | -    | OHCL       |
|                | DA332SXIG  | BT/WIFI | General         | -   | O       | -  | -     | -   | -    | OHCL       |
|                | ADB10SXGG  | BT/WIFI | General         | -   | -       | -  | -     | -   | -    | OHCL       |
|                | ADB10SXGN  | BT/WIFI | NA              | -   | -       | -  | -     | -   | -    | OHCL       |
|                | ADB10SXGL  | BT/WIFI | Columbia        | -   | -       | -  | -     | -   | -    | OHCL       |
|                | ADB11SXGG  | BT/WIFI | General         | -   | -       | -  | -     | O   | -    | OHCL       |
|                | DA330SXGG  | BT      | General         | -   | -       | -  | -     | O   | -    | OHCL       |
|                | ADB10SXMG  | BT      | General         | -   | -       | -  | O     | O   | -    | OHCL       |
|                | ADB10SXFN  | BT/WIFI | NA              | -   | -       | O  | -     | -   | O    | OHCL       |
|                | DA332SXGG  | BT/WIFI | General         | -   | -       | -  | -     | -   | -    | OHCL       |
|                | DA333SXGG  | BT/WIFI | General         | -   | -       | -  | -     | O   | -    | OHCL       |
|                | ADB12SXGG  | BT/WIFI | General         | -   | -       | -  | -     | -   | -    | Headlining |
| ADB13SXGG      | BT/WIFI    | General | -               | -   | -       | -  | -     | -   | OHCL |            |

The results of this test report are effective only to the items tested. The SGS Korea is not responsible for the sampling, the results of this test report apply to the sample as received. This test report cannot be reproduced, except in full, without prior written permission of the Company. This test report does not assure KOLAS accreditation.

SGS Korea Co., Ltd. (Gunpo Laboratory) 4, LS-ro 182beon-gil, Gunpo-si, Gyeonggi-do, Korea, 15807 <http://www.sgsgroup.kr>

## 2. DFS (Dynamic Frequency Selection)

### 2.1. System Overview

#### 2.1.1. Set up of EUT

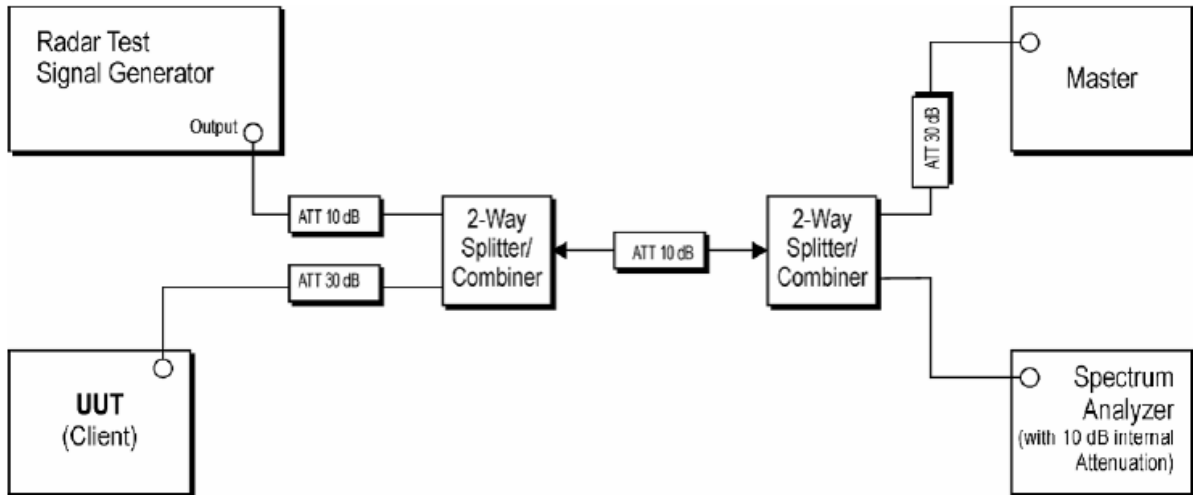

The radar signal generation equipment consists of a vector signal generator

The signal monitoring equipment consists of a spectrum analyzer set to display 8 001 bins on the horizontal axis. The time domain resolution is 2 msec/bin with a 16 second sweep time, meeting the 10 second short pulse reporting criteria. The aggregate ON time is calculated by multiplying the number of bins above a threshold during a particular observation period by the dwell time per bin, with the analyzer set to peak detection and max hold.

The Slave is tested separately for compliance with the Channel Shutdown requirements, for the situation when the Slave device vacates the channel in response to detection of a radar by the Master.

All tests were performed at a channel center frequency of 5 290 MHz and 5 530 MHz. Measurements were performed using conducted test methods.

*The results of this test report are effective only to the items tested. The SGS Korea is not responsible for the sampling, the results of this test report apply to the sample as received. This test report cannot be reproduced, except in full, without prior written permission of the Company. This test report does not assure KOLAS accreditation.*

**SGS Korea Co., Ltd. (Gunpo Laboratory)** 4, LS-ro 182beon-gil, Gunpo-si, Gyeonggi-do, Korea, 15807 <http://www.sgsgroup.kr>

RTT5041-19(2019.04.24)(1)

Tel. +82 31 428 5700 / Fax. +82 31 427 2370

A4(210 mm x 297 mm)

## 2.2 Limit

§15.407(h) and FCC 06-96 APPENDIX “COMPLIANCE MEASUREMENT PROCEDURES FOR UNLICENSED-NATIONAL INFORMATION INFRASTRUCTURE DEVICES OPERATING IN THE 5 250-5 350 MHz AND 5 470-5 725 MHz BANDS INCORPORATING DYNAMIC FREQUENCY SELECTION

**Table 1: Applicability of DFS Requirements Prior to Use of a Channel**

| Requirement                     | Operational Mode |                                |                             |
|---------------------------------|------------------|--------------------------------|-----------------------------|
|                                 | Master           | Client Without Radar Detection | Client With Radar Detection |
| Non-Occupancy Period            | Yes              | Not required                   | Yes                         |
| DFS Detection Threshold         | Yes              | Not required                   | Yes                         |
| Channel Availability Check Time | Yes              | Not required                   | Not required                |
| U-NII Detection Bandwidth       | Yes              | Not required                   | Yes                         |

**Table 2: Applicability of DFS requirements during normal operation**

| Requirement                       | Operational Mode                             |                                |
|-----------------------------------|--|--------------------------------|
|                                   | Master Device or Client with Radar Detection | Client Without Radar Detection |
| DFS Detection Threshold           | Yes  | Not required                   |
| Channel Closing Transmission Time | Yes  | Yes                            |
| Channel Move Time                 | Yes  | Yes                            |
| U-NII Detection Bandwidth         | Yes  | Not required                   |

*The results of this test report are effective only to the items tested. The SGS Korea is not responsible for the sampling, the results of this test report apply to the sample as received. This test report cannot be reproduced, except in full, without prior written permission of the Company. This test report does not assure KOLAS accreditation.*



| Additional requirement for devices with multiple bandwidth modes   | Master Device or Client with Radar Detection | Client Without Radar Detection                       |
|--|--|--|
| U-NII Detection Bandwidth and Statistical Performance Check  | All BT modes must be tested                  | Not required   |
| Channel Move Time and Channel Closing Transmission Time  | Test using widest BT mode available          | Test using the widest BW mode available for the link |
| All other tests  | Any single BW mode                           | Not required   |
| <b>Note:</b> Frequencies selected for statistical performance check (Section 7.8.4) should include several frequencies within the radar detection bandwidth and frequencies near the edge of the radar detection bandwidth. For 802.11 devices it is suggested to select frequencies in each of the bonded 20 MHz channels and the channel center frequency. |  |  |

**Table 3: DFS Detection Thresholds for Master Devices and Client Devices with Radar Detection**

| Maximum Transmit Power   | Value<br>(See Note 1, 2, and 3) |
|--|---------------------------------|
| EIRP $\geq$ 200 milliwatt  | -64 dB m                        |
| EIRP < 200 milliwatt and power spectral density < 10 dB m/MHz  | -62 dB m                        |
| EIRP < 200 milliwatt that do not meet the power spectral density requirement   | -64 dB m                        |
| <b>Note 1:</b> This is the level at the input of the receiver assuming a 0 dB i receive antenna.<br><b>Note 2:</b> Throughout these test procedures an additional 1 dB has been added to the amplitude of the test transmission waveforms to account for variations in measurement equipment. This will ensure that the test signal is at or above the detection threshold level to trigger a DFS response.<br><b>Note 3:</b> EIRP is based on the highest antenna gain. For MIMO devices refer to KDB Publication 662911 D01. |                                 |

**KDB 905462 D03 Client without DFS New Rules v01r02: UNII client devices without radar detection**

- The guidance provided in Section 8 (DFS Test Report Guidelines) in the appropriate DFS Test Procedure specified in KDB Publication 905462 D02.
- Test results demonstrating an associated client link is established with the master on a test frequency; if a client device operates in a “listen only” mode to a master without formally “associating” with it the test report must include tests for such modes.
- The devices must be tested with a master device operating in the same band and operation modes.
- If two client devices can communicate directly with each other while maintaining an association with a master or if the client operates on a frequency band while “listening” to a master, such modes must be tested with the master device active.
- The client and DFS-certified master device are associated, and a movie can be streamed as specified in the DFS Order for a non-occupancy period test.
- The test frequency has been monitored to ensure no transmission of any type has occurred for 30 minutes. Note: If the client moves with the master, the device is considered compliant if nothing appears in the client non-occupancy period test. For devices that shut down (rather than moving channels), no beacons should appear.
- An analyzer plot that contains a single 30-minute sweep on the original channel.

*The results of this test report are effective only to the items tested. The SGS Korea is not responsible for the sampling, the results of this test report apply to the sample as received. This test report cannot be reproduced, except in full, without prior written permission of the Company. This test report does not assure KOLAS accreditation.*

**Table 4: DFS Response Requirement Values**

| Parameter                         | Value  |
|-----------------------------------|--|
| Non-occupancy period              | Minimum 30 minutes   |
| Channel Availability Check Time   | 60 seconds   |
| Channel Move Time                 | 10 seconds See Note 1.   |
| Channel Closing Transmission Time | 200 milliseconds + an aggregate of 60 milliseconds over remaining 10 second period. See Notes 1 and 2. |
| U-NII Detection Bandwidth         | Minimum 100 % of the U-NII 99 % transmission power bandwidth. See Note 3.                              |

**Note 1:** Channel Move Time and the Channel Closing Transmission Time should be performed with Radar Type 0. The measurement timing begins at the end of the Radar Type 0 burst.

**Note 2:** The Channel Closing Transmission Time is comprised of 200 milliseconds starting at the beginning of the Channel Move Time plus any additional intermittent control signals required to facilitate a Channel move (an aggregate of 60 milliseconds) during the remainder of the 10 second period. The aggregate duration of control signals will not count quiet periods in between transmissions.

**Note 3:** During the U-NII Detection Bandwidth detection test, radar type 0 should be used. For each frequency step the minimum percentage of detection is 90 percent. Measurements are performed with no data traffic.

*The results of this test report are effective only to the items tested. The SGS Korea is not responsible for the sampling, the results of this test report apply to the sample as received. This test report cannot be reproduced, except in full, without prior written permission of the Company. This test report does not assure KOLAS accreditation.*

**SGS Korea Co., Ltd. (Gunpo Laboratory)** 4, LS-ro 182beon-gil, Gunpo-si, Gyeonggi-do, Korea, 15807 <http://www.sgsgroup.kr>

**Table 5 – Short Pulse Radar Test Waveforms**

| Radar Type  | Pulse Width (μsec) | PRI (μsec)   | Number of Pulses  | Minimum Percentage of Successful Detection | Minimum Number of Trials |
|---|--------------------|--|---|--|--------------------------|
| 0   | 1                  | 1 428  | 18  | See Note 1                                 | See Note 1               |
| 1   | 1                  | Test A: 15 unique PRI values randomly selected from the list of 23 PRI values in Table 5a  | Roundup $\left\{ \begin{array}{l} \left( \frac{1}{360} \right) \cdot \\ \left( \frac{19 \cdot 10^6}{\text{PRI}_{\mu\text{sec}}} \right) \end{array} \right\}$ | 60 %                                       | 30                       |
|   |                    | Test B: 15 unique PRI values randomly selected within the range of 518-3 066 μsec, with a minimum increment of 1 μsec, excluding PRI values selected in Test A |   |  |                          |
| 2   | 1-5                | 150-230  | 23-29   | 60 %                                       | 30                       |
| 3   | 6-10               | 200-500  | 16-18   | 60 %                                       | 30                       |
| 4   | 11-20              | 200-500  | 12-16   | 60 %                                       | 30                       |
| Aggregate (Radar Types 1-4)   |                    |  |   | 80 %                                       | 120                      |
| <b>Note 1:</b> Short Pulse Radar Type 0 should be used for the detection bandwidth test, channel move time, and channel closing time tests. |                    |  |   |  |                          |

**Table 6 – Long Pulse Radar Test Waveform**

| Radar Type | Pulse Width (μsec) | Chirp Width (MHz) | PRI (μsec)  | Number of Pulses per Burst | Number of Burst | Minimum Percentage of Successful Detection | Minimum Number of Trials |
|------------|--------------------|-------------------|-------------|----------------------------|-----------------|--|--------------------------|
| 5          | 50-100             | 5-20              | 1 000-2 000 | 1-3                        | 8-20            | 80 %                                       | 30                       |

**Table 7 – Frequency Hopping Radar Test Waveform**

| Radar Type | Pulse Width (μsec) | PRI (μsec) | Pulses per Hop | Hopping Rate (kHz) | Hopping Sequence Length (msec) | Minimum Percentage of Successful Detection | Minimum Number of Trials |
|------------|--------------------|------------|----------------|--------------------|--------------------------------|--|--------------------------|
| 6          | 1                  | 333        | 9              | 0.333              | 300                            | 70 %                                       | 30                       |

The results of this test report are effective only to the items tested. The SGS Korea is not responsible for the sampling, the results of this test report apply to the sample as received. This test report cannot be reproduced, except in full, without prior written permission of the Company. This test report does not assure KOLAS accreditation.

### 2.3. Description of EUT

The EUT operates over the band 2A “5 260 MHz ~ 5 320 MHz (11a/n\_HT20, 11ac\_VHT20), 5 270 MHz ~ 5 310 MHz (11n\_HT40, 11ac\_VHT40), 5 290 MHz (11ac\_VHT80)” and band 2C “5 500 MHz ~ 5 720 MHz (11a/n\_HT20, 11ac\_VHT20), 5 510 MHz ~ 5 710 MHz (11n\_HT40, 11ac\_VHT40), 5 530 MHz ~ 5 690 MHz (11ac\_VHT80)” ranges.

The rated output power of the client unit is < 200 milliwatt.

Therefore the required interference threshold level is -62 dB m.

---

*The results of this test report are effective only to the items tested. The SGS Korea is not responsible for the sampling, the results of this test report apply to the sample as received. This test report cannot be reproduced, except in full, without prior written permission of the Company. This test report does not assure KOLAS accreditation.*

**SGS Korea Co., Ltd. (Gunpo Laboratory)** 4, LS-ro 182beon-gil, Gunpo-si, Gyeonggi-do, Korea, 15807 <http://www.sgsgroup.kr>

**Plot of radar waveform type 0**

11ac\_VHT80

5 290 MHz

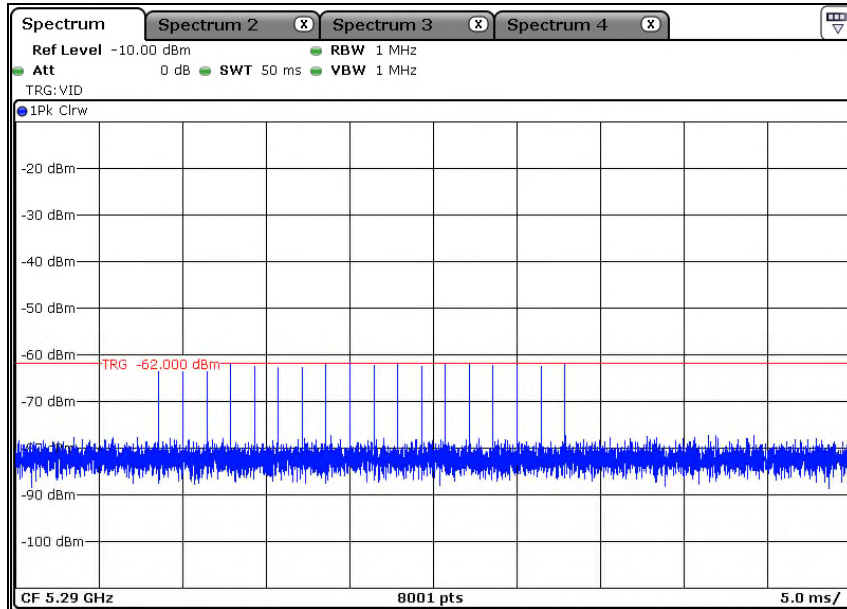

5 530 MHz

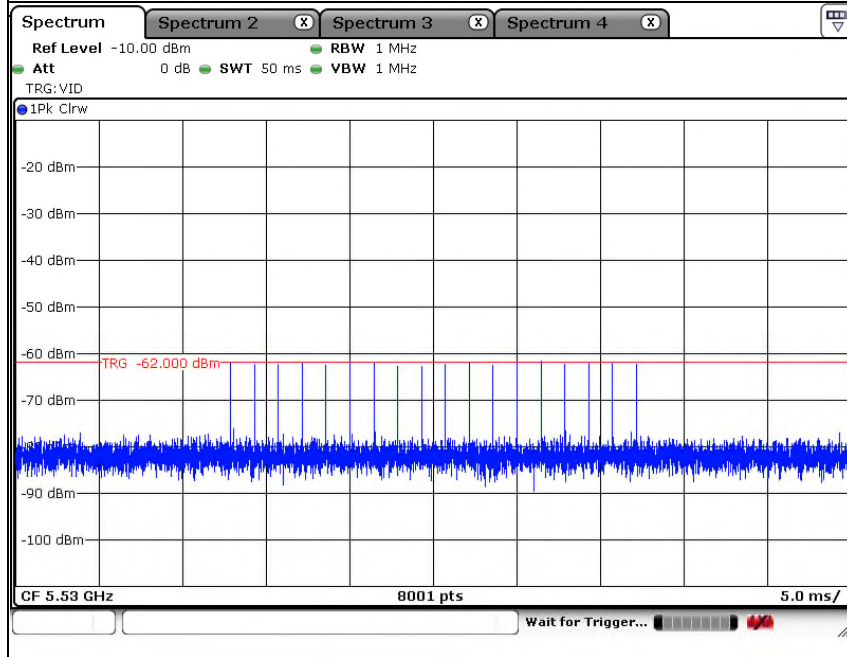

The results of this test report are effective only to the items tested. The SGS Korea is not responsible for the sampling, the results of this test report apply to the sample as received. This test report cannot be reproduced, except in full, without prior written permission of the Company. This test report does not assure KOLAS accreditation.

SGS Korea Co., Ltd. (Gunpo Laboratory) 4, LS-ro 182beon-gil, Gunpo-si, Gyeonggi-do, Korea, 15807 <http://www.sgsgroup.kr>

**Plot of LAN traffic**

11ac\_VHT80

5 290 MHz

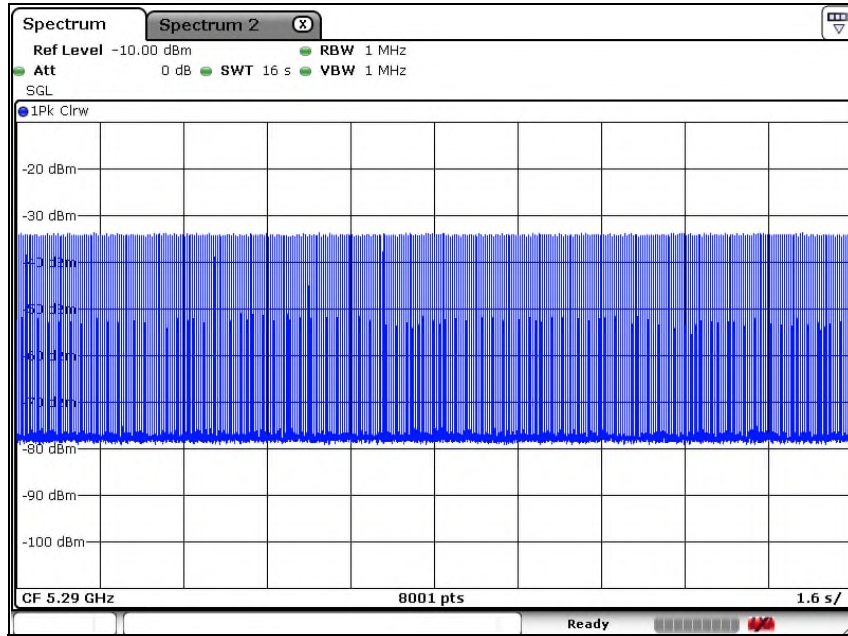

5 530 MHz

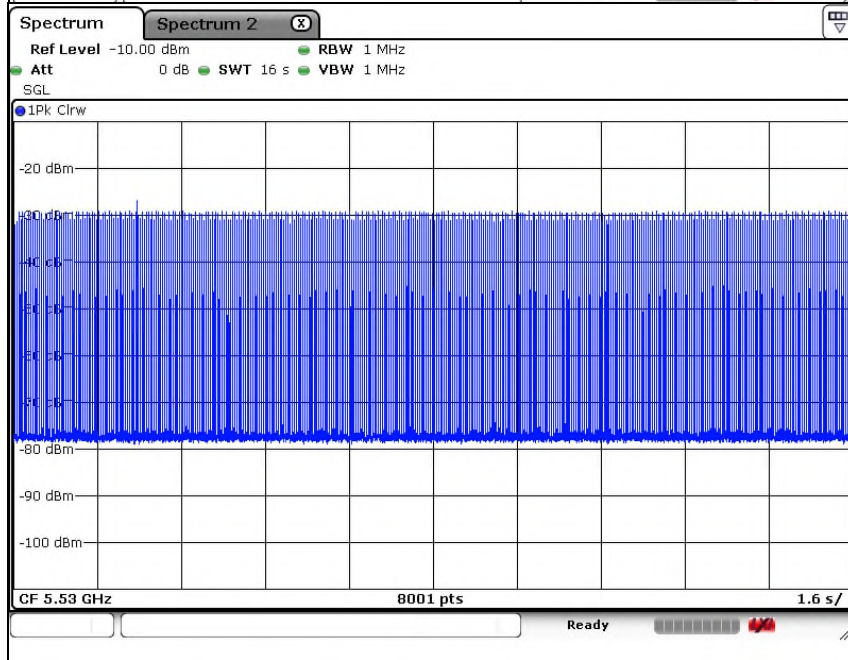

The results of this test report are effective only to the items tested. The SGS Korea is not responsible for the sampling, the results of this test report apply to the sample as received. This test report cannot be reproduced, except in full, without prior written permission of the Company. This test report does not assure KOLAS accreditation.

SGS Korea Co., Ltd. (Gunpo Laboratory) 4, LS-ro 182beon-gil, Gunpo-si, Gyeonggi-do, Korea, 15807 <http://www.sgsgroup.kr>

The reference maker is set after 200 ms from the end of Last radar pulse.

The delta is set at the end of the last WLAN transmission following the radar pulse. This delta is the channel move time within the 10 sec form the end of Last radar pulse.

The aggregate channel closing transmission time is calculated as follows:

Aggregate Transmission Time = (Number of analyzer bins showing transmission)\*(dwell time per bin)

The observation period over which the aggregated time is calculated begins at (Reference Maker) and ends no earlier than (Reference Maker +10 sec)

## 2.4. Test Result

| Frequency (MHz) | Channel Move Time (sec)                            | Limit              |
|-----------------|--|--------------------|
| 5 290           | 0.758  | Not exceed 10 sec  |
| 5 530           | 0.864  |                    |
| Frequency (MHz) | Aggregate channel closing transmission time (msec) | Limit              |
| 5 290           | 12   | Not exceed 60 msec |
| 5 530           | 14   |                    |

Aggregate channel closing transmission time

[16s (sweep time) / 8 001 (sweep point)] × The number of channel bin from 200 ms at the end of radar pulse.

5 290 MHz: (16 / 8 001) × 6 = 12 ms

5 530 MHz: (16 / 8 001) × 7 = 14 ms

| Frequency (MHz) | Non-occupancy period (min) | Limit                      |
|-----------------|----------------------------|----------------------------|
| 5 290           | Above 30                   | Not be less than 30 minute |
| 5 530           | Above 30                   |                            |

*The results of this test report are effective only to the items tested. The SGS Korea is not responsible for the sampling, the results of this test report apply to the sample as received. This test report cannot be reproduced, except in full, without prior written permission of the Company. This test report does not assure KOLAS accreditation.*

**SGS Korea Co., Ltd. (Gunpo Laboratory)** 4, LS-ro 182beon-gil, Gunpo-si, Gyeonggi-do, Korea, 15807 <http://www.sgsgroup.kr>

**Plot of channel move time & aggregate channel closing transmission time**

11ac\_VHT80

5 290 MHz

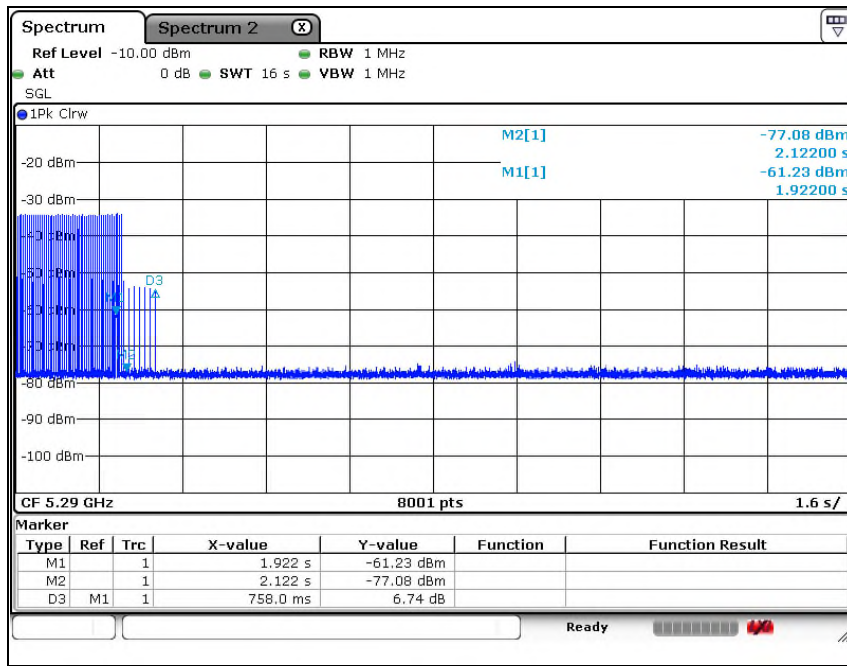

5 530 MHz

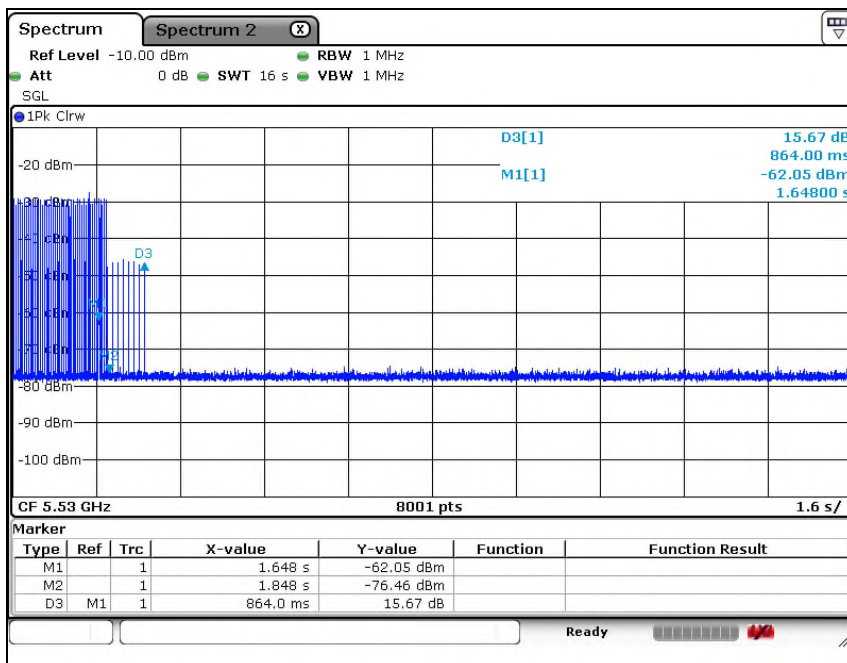

The results of this test report are effective only to the items tested. The SGS Korea is not responsible for the sampling, the results of this test report apply to the sample as received. This test report cannot be reproduced, except in full, without prior written permission of the Company. This test report does not assure KOLAS accreditation.

SGS Korea Co., Ltd. (Gunpo Laboratory) 4, LS-ro 182beon-gil, Gunpo-si, Gyeonggi-do, Korea, 15807 <http://www.sgsgroup.kr>



**Plot of Non-occupancy period**

11ac\_VHT80

5 290 MHz

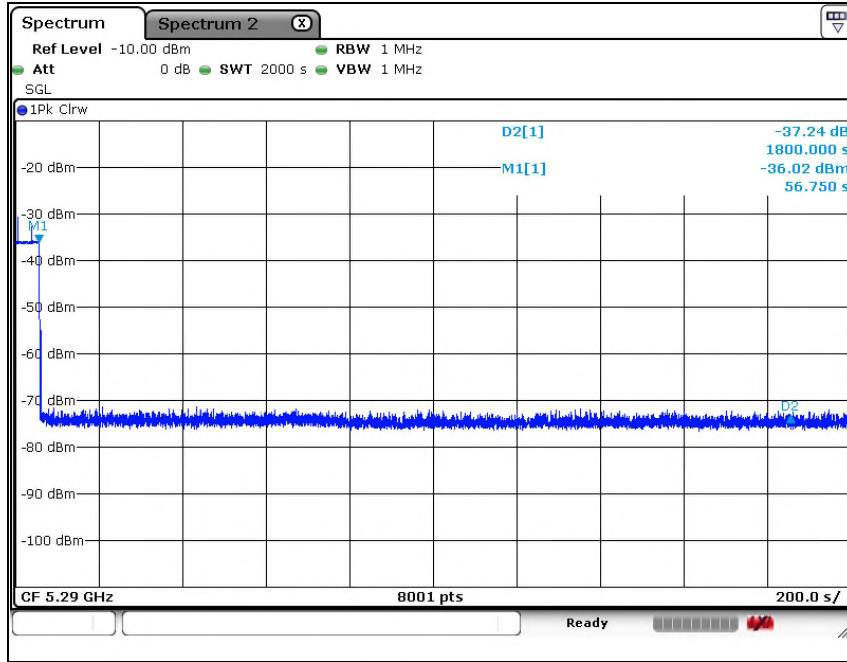

5 530 MHz

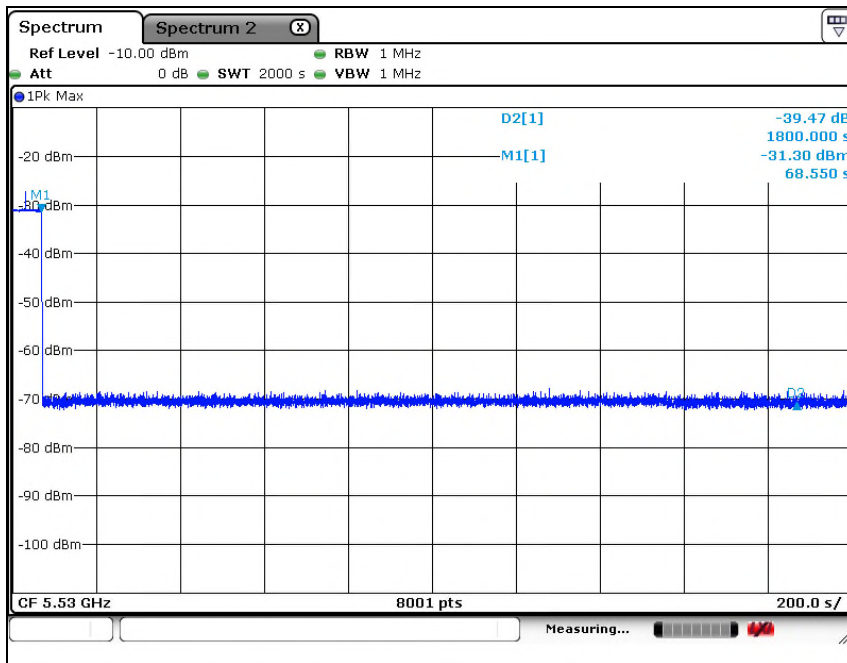

**- End of the Test Report -**

The results of this test report are effective only to the items tested. The SGS Korea is not responsible for the sampling, the results of this test report apply to the sample as received. This test report cannot be reproduced, except in full, without prior written permission of the Company. This test report does not assure KOLAS accreditation.

SGS Korea Co., Ltd. (Gunpo Laboratory) 4, LS-ro 182beon-gil, Gunpo-si, Gyeonggi-do, Korea, 15807 <http://www.sgsgroup.kr>