

9.4.2. Unwanted Emissions(Conducted)

Low Band-edge

**Lowest Channel & Modulation : GFSK**

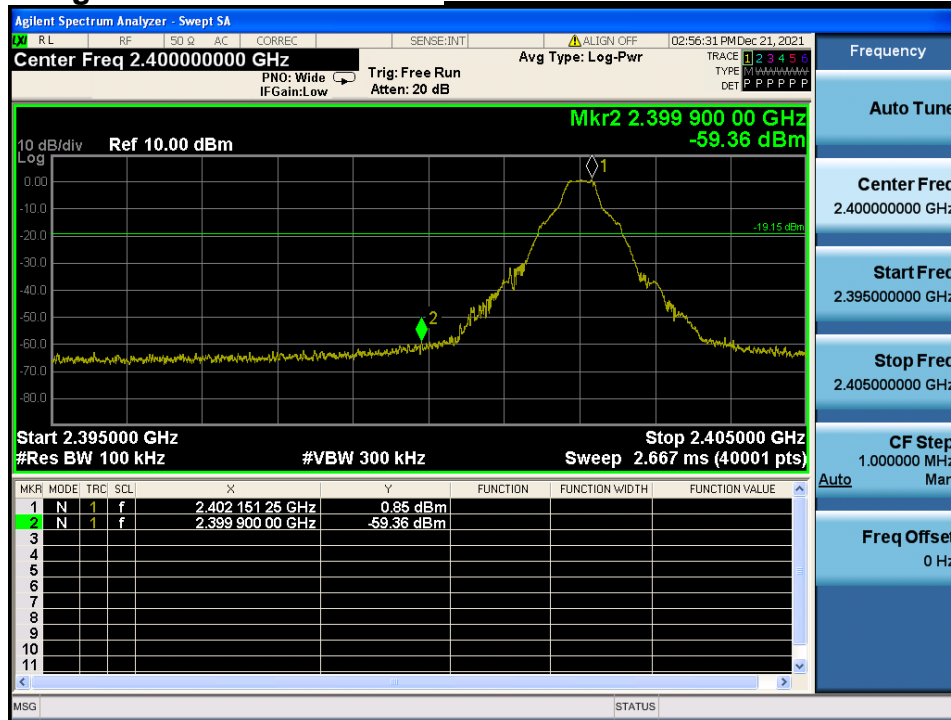

Low Band-edge

**Hopping mode & Modulation : GFSK**



Conducted Spurious Emissions **Lowest Channel & Modulation : GFSK**

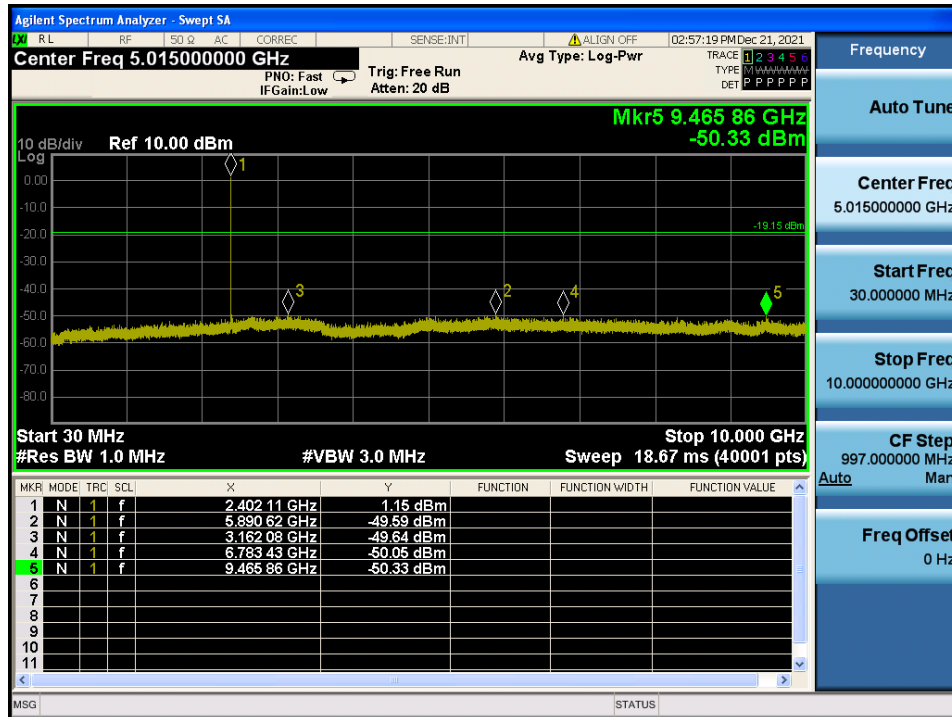
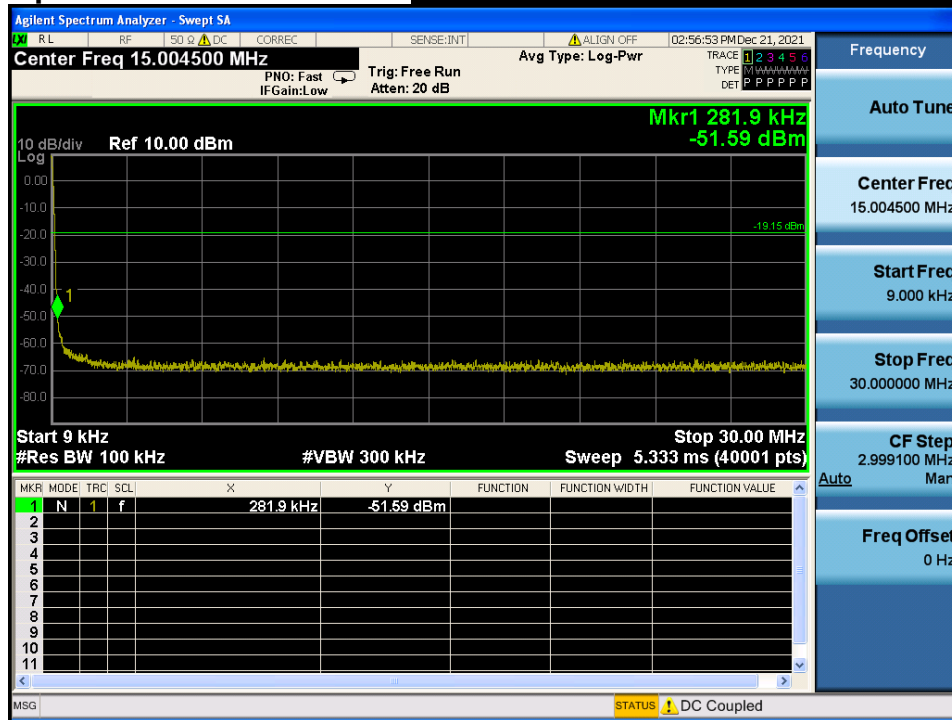

**Conducted Spurious Emissions** *Lowest Channel & Modulation : GFSK*

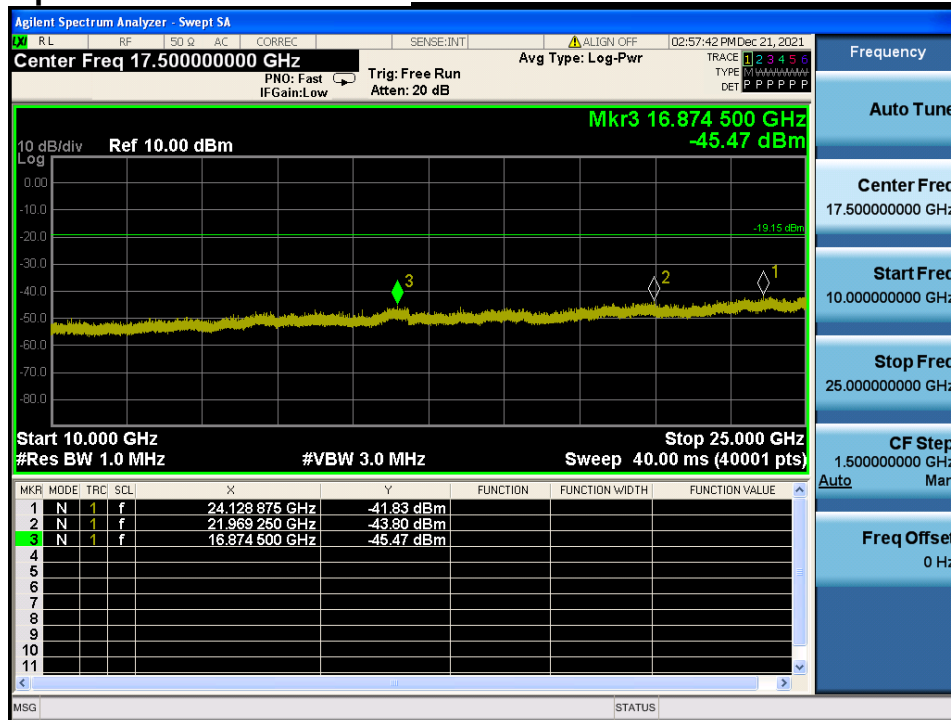

Reference for limit

Middle Channel & Modulation : GFSK

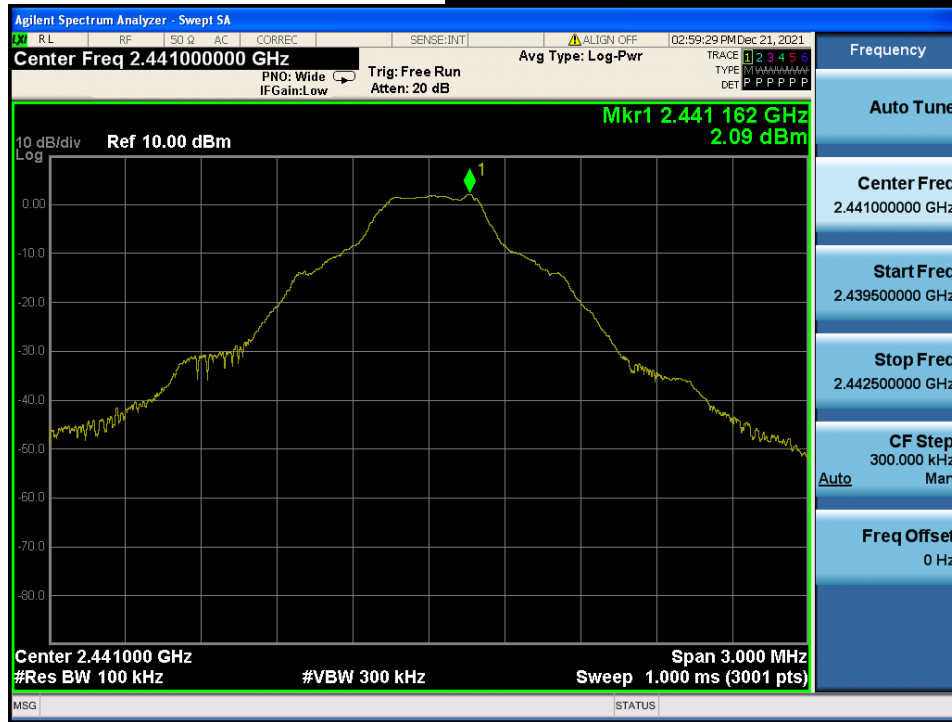

Conducted Spurious Emissions

Middle Channel & Modulation : GFSK

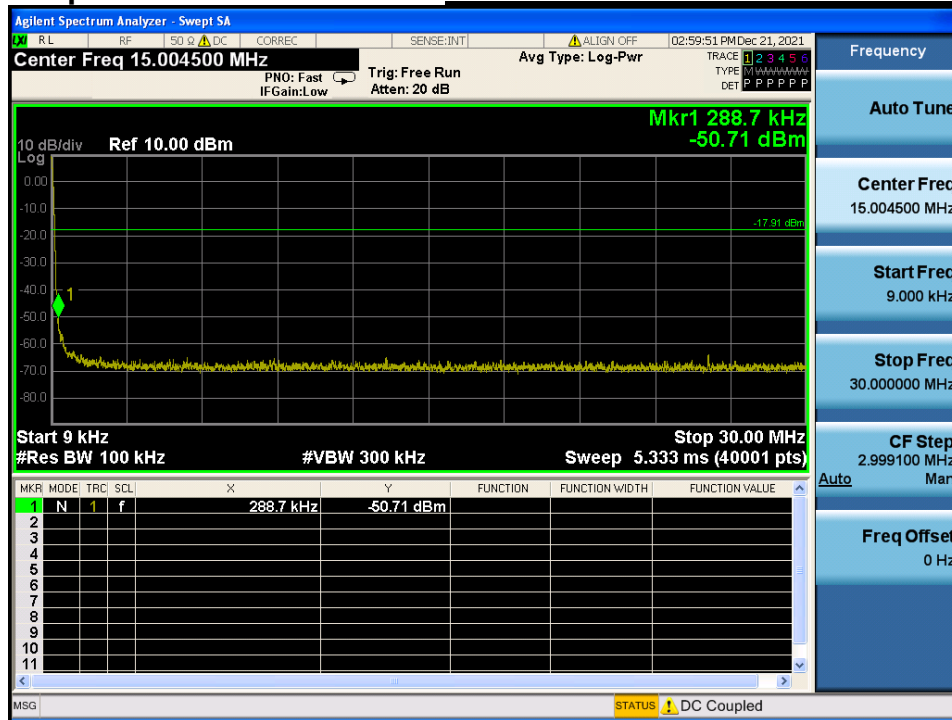

Conducted Spurious Emissions *Middle Channel & Modulation : GFSK*

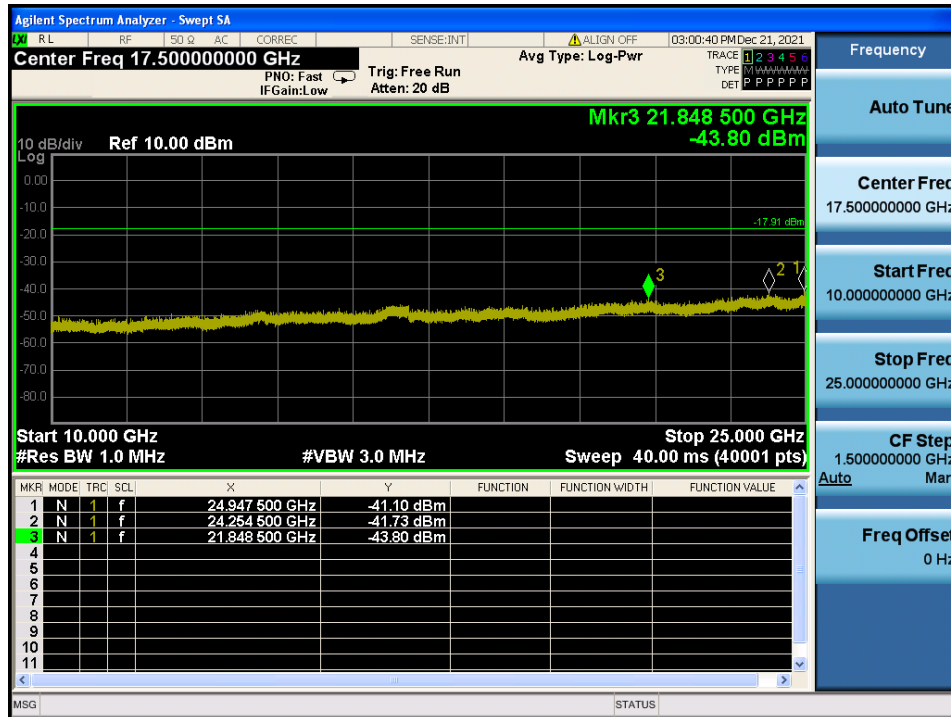
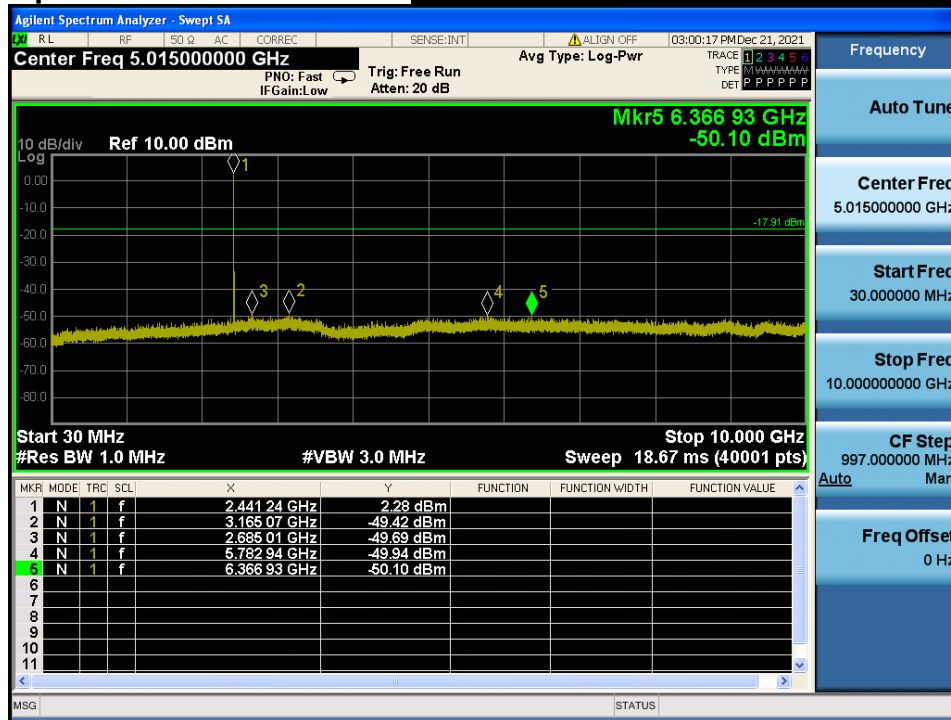

High Band-edge

Highest Channel & Modulation : GFSK

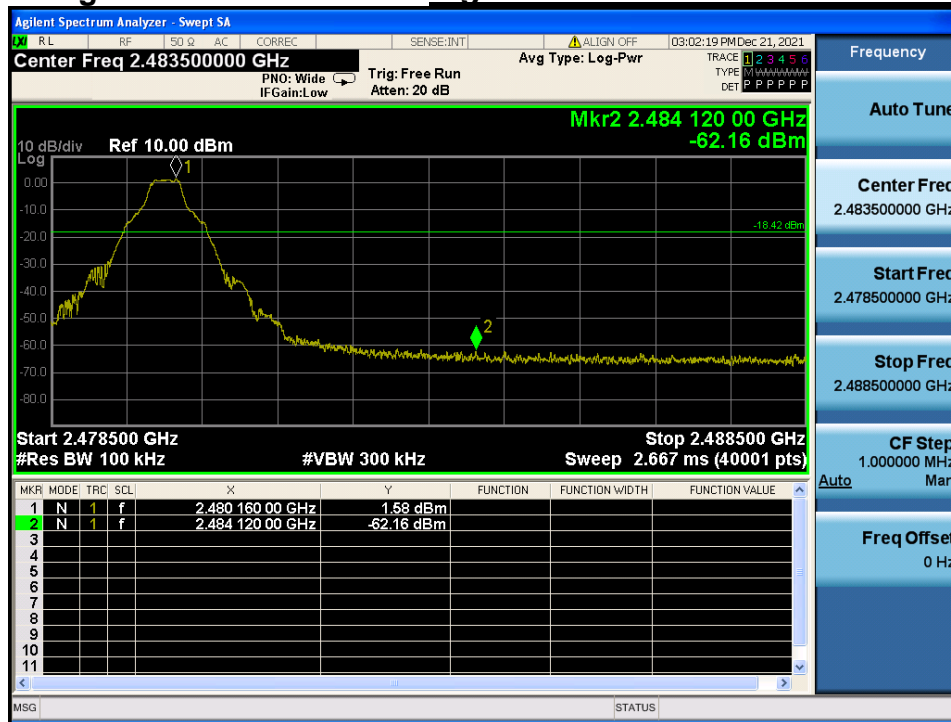

High Band-edge

Hopping mode & Modulation : GFSK

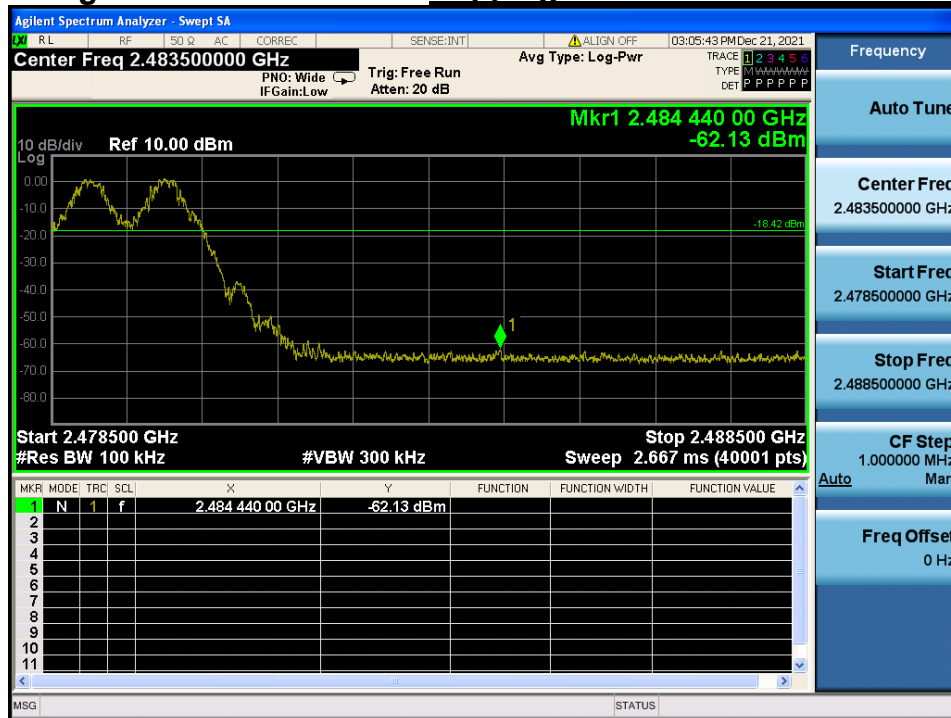

Conducted Spurious Emissions **Highest Channel & Modulation : GFSK**

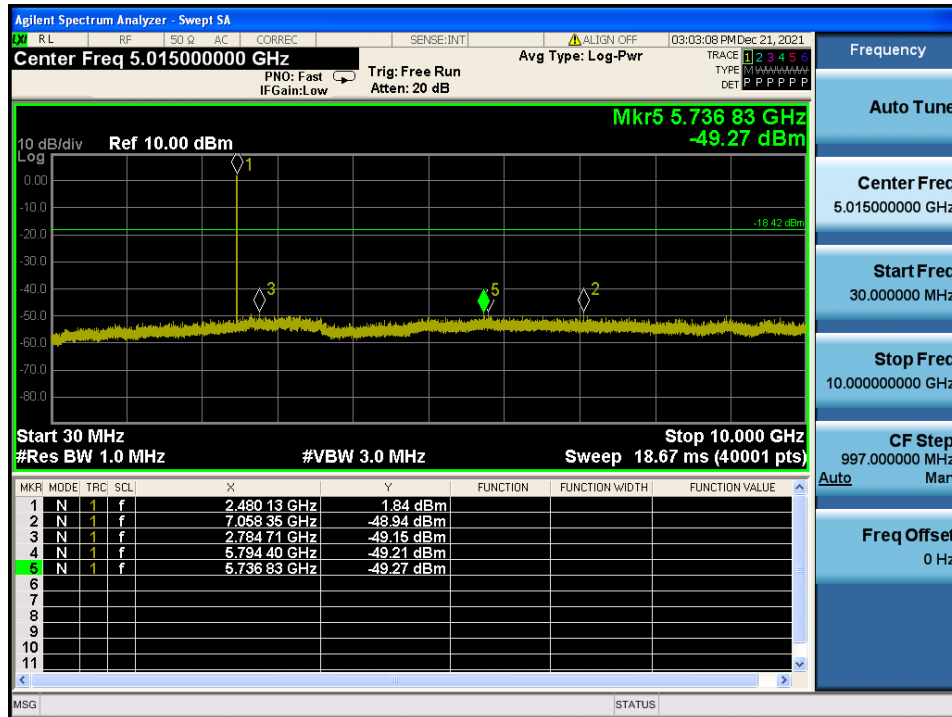
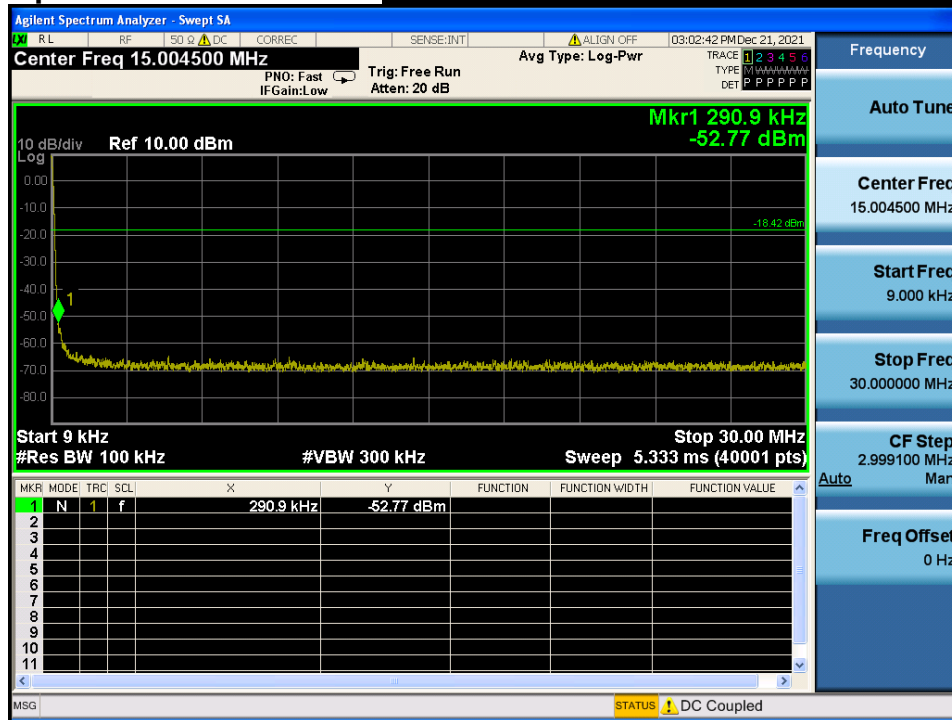

Conducted Spurious Emissions **Highest Channel & Modulation : GFSK**

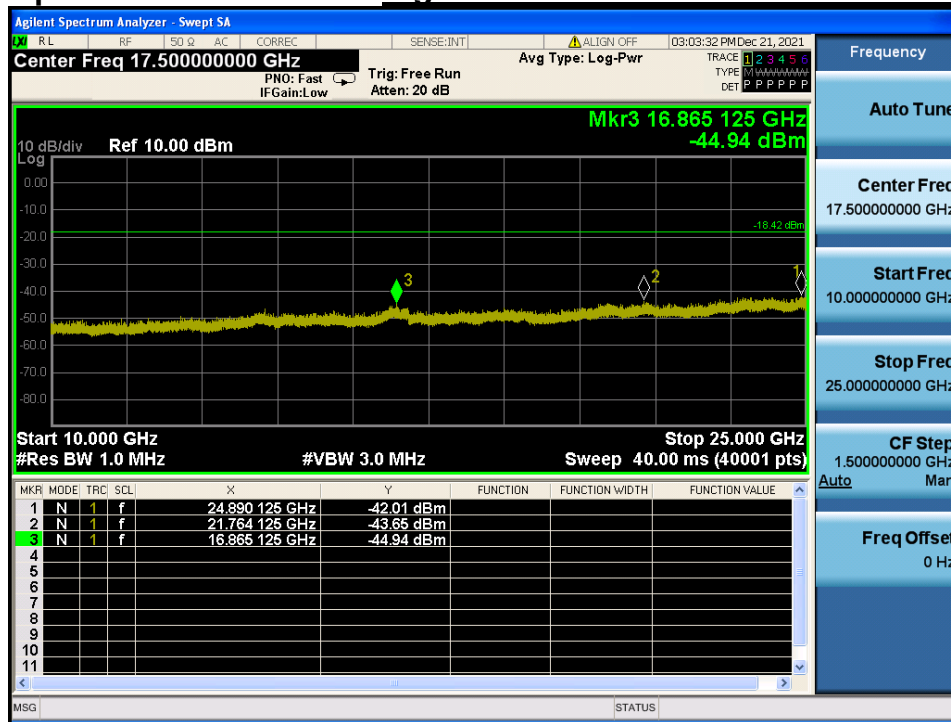



Low Band-edge

Lowest Channel & Modulation :  $\pi/4$ DQPSK

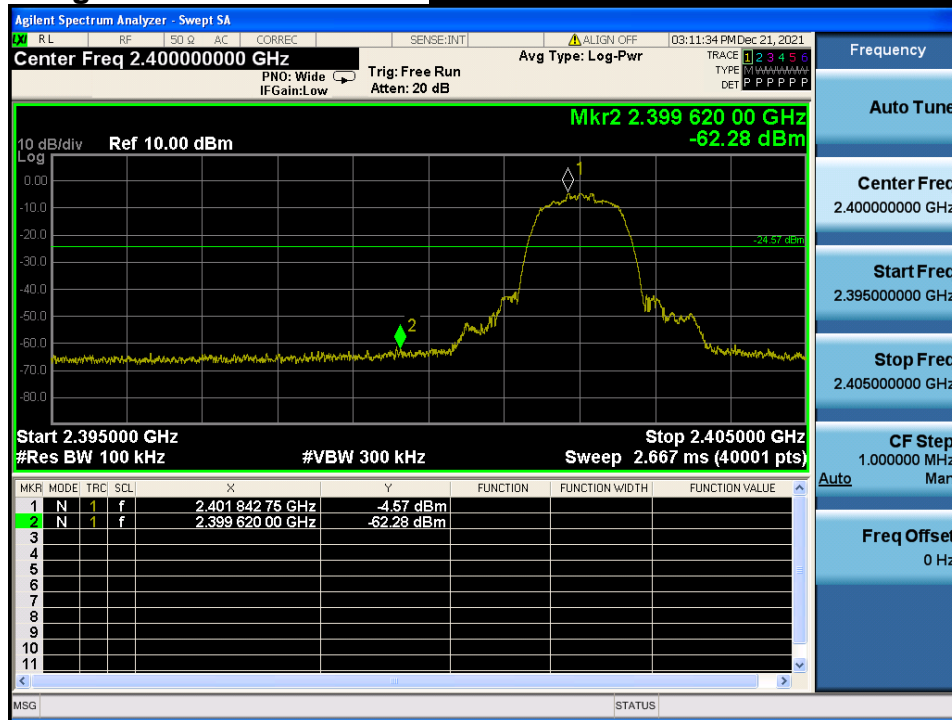

Low Band-edge

Hopping mode & Modulation :  $\pi/4$ DQPSK

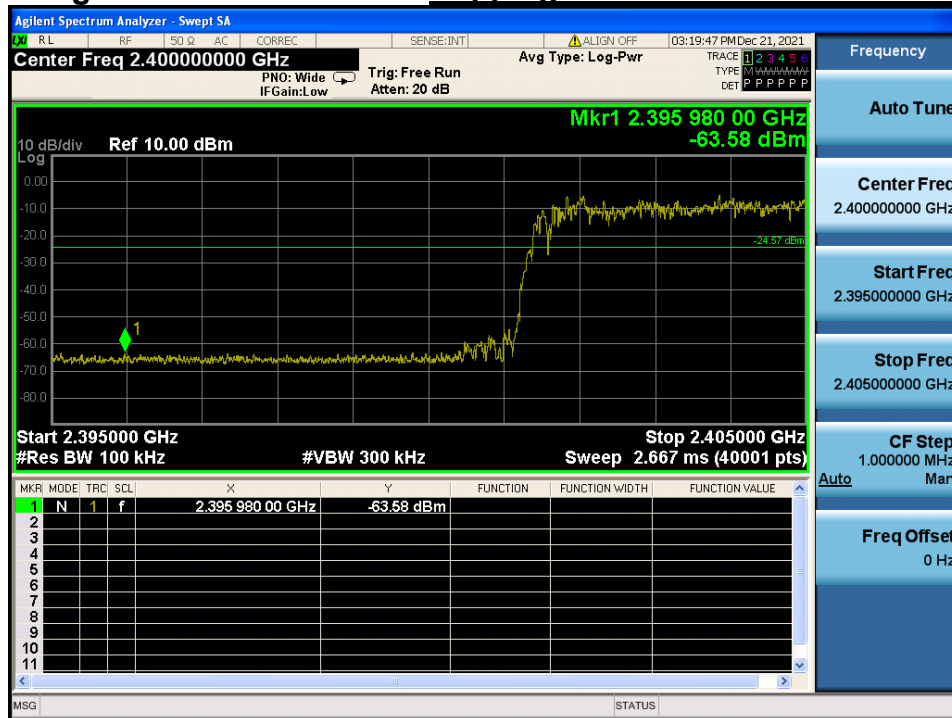

Conducted Spurious Emissions **Lowest Channel & Modulation :  $\pi/4$ DQPSK**

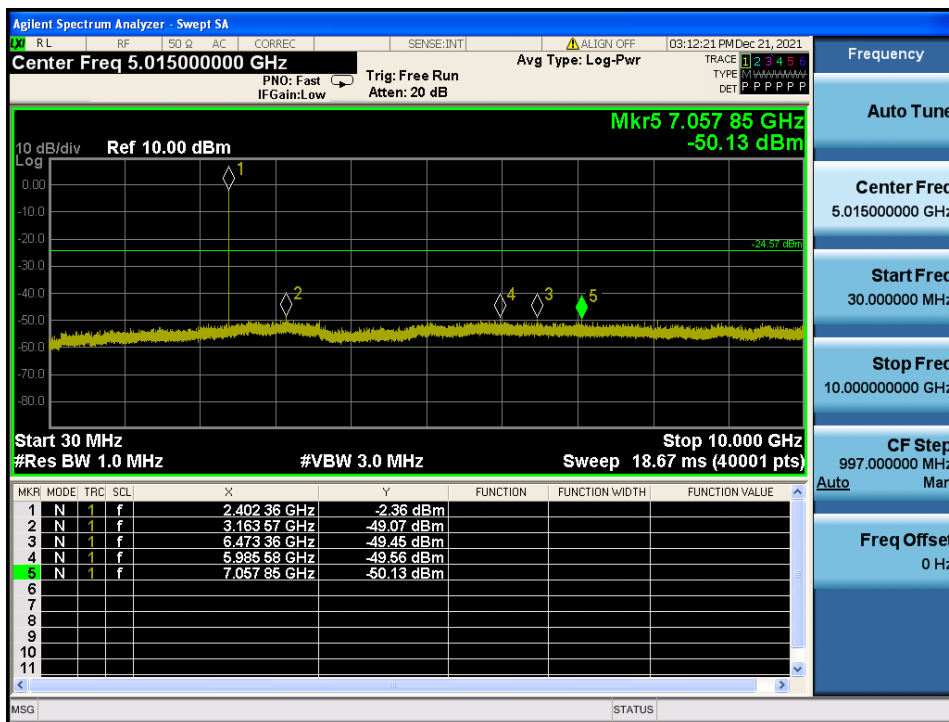
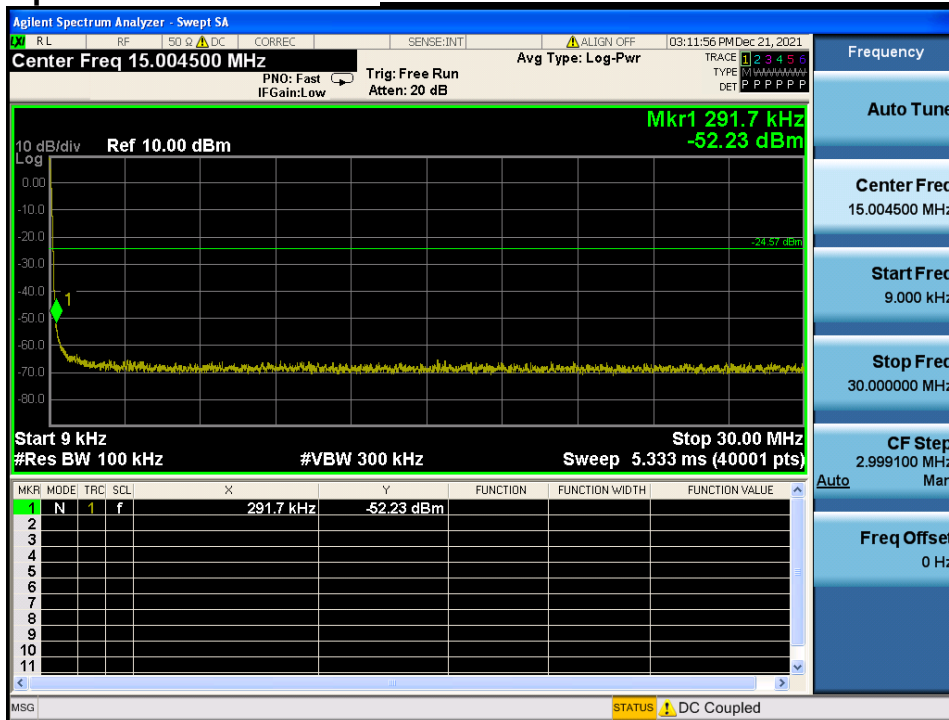

Conducted Spurious Emissions **Lowest Channel & Modulation :  $\pi/4$ DQPSK**

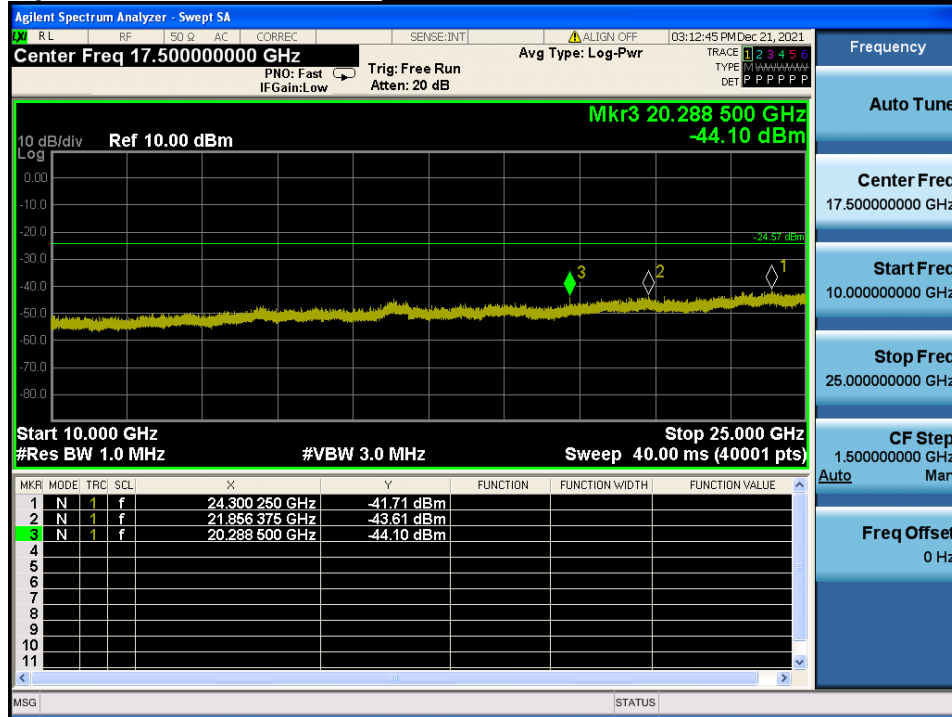

Reference for limit

Middle Channel & Modulation :  $\pi/4$ DQPSK

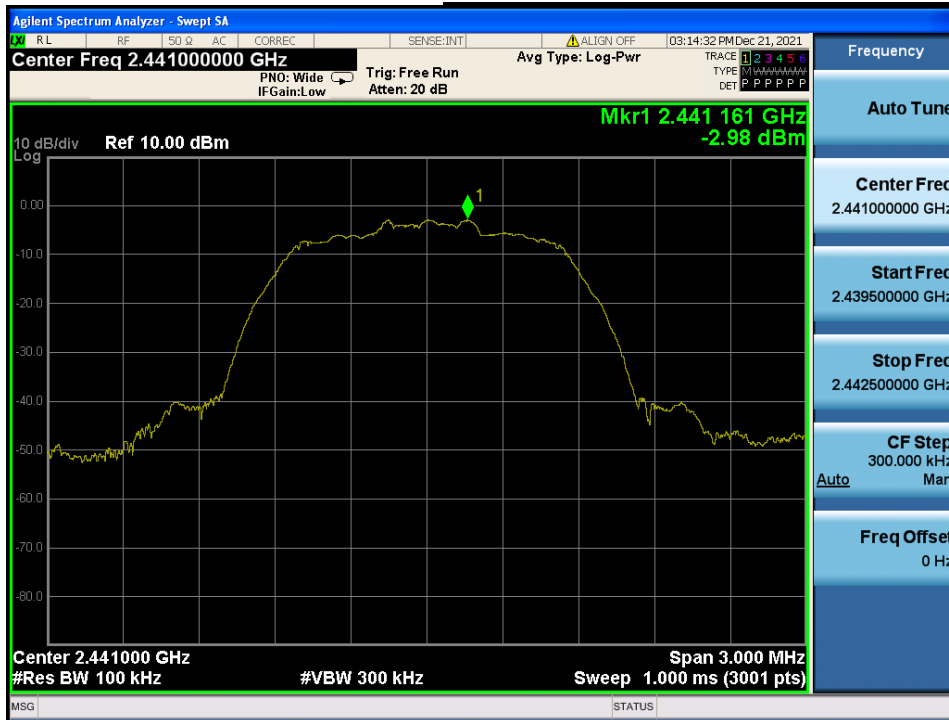

Conducted Spurious Emissions

Middle Channel & Modulation :  $\pi/4$ DQPSK

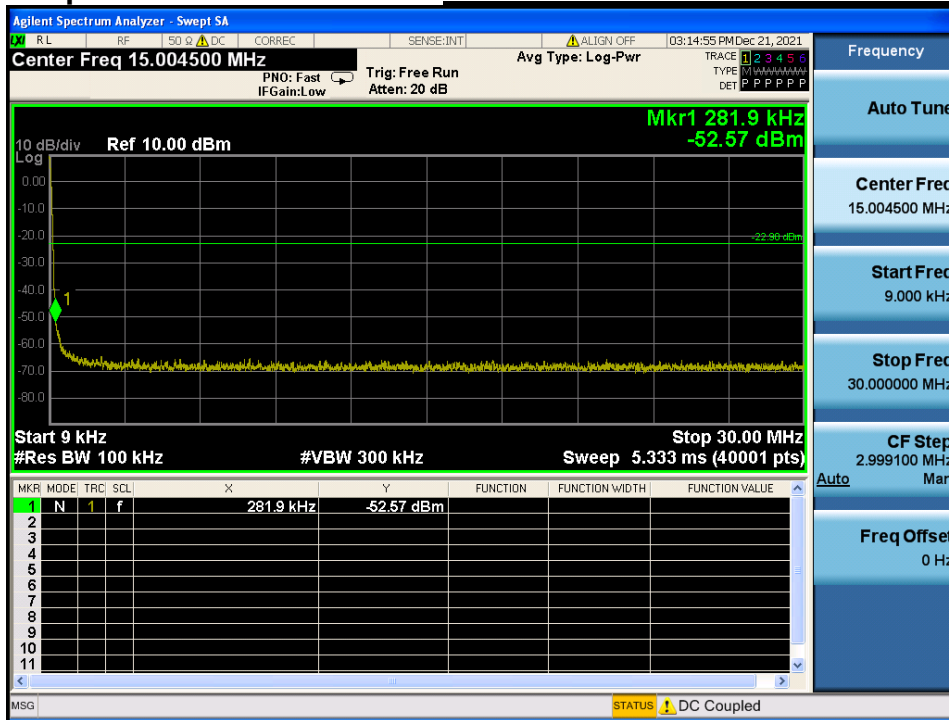

Conducted Spurious Emissions *Middle Channel & Modulation :  $\pi/4$ DQPSK*

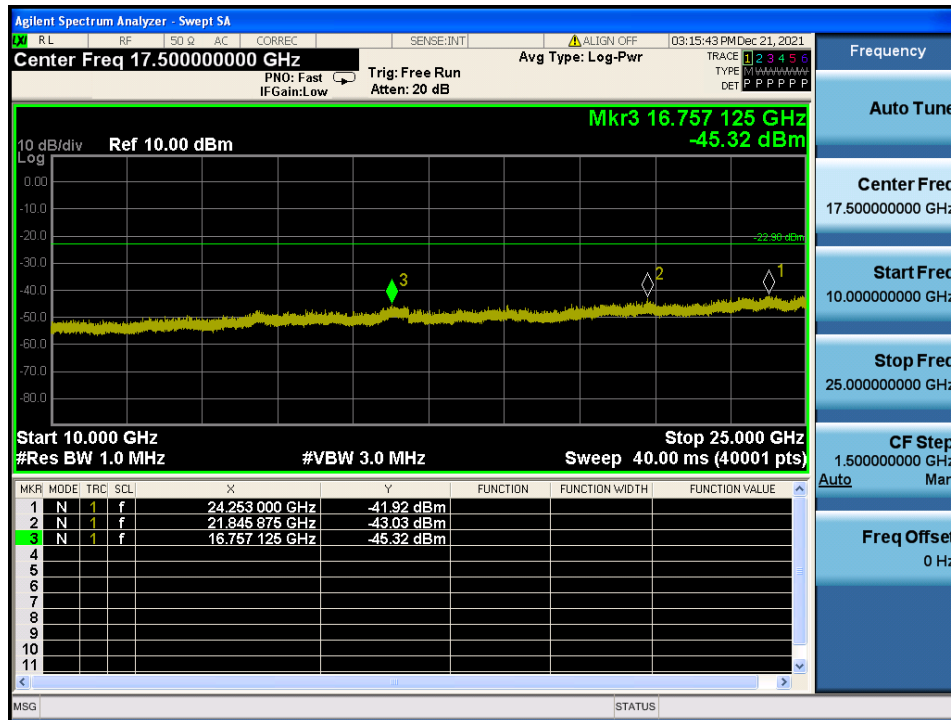
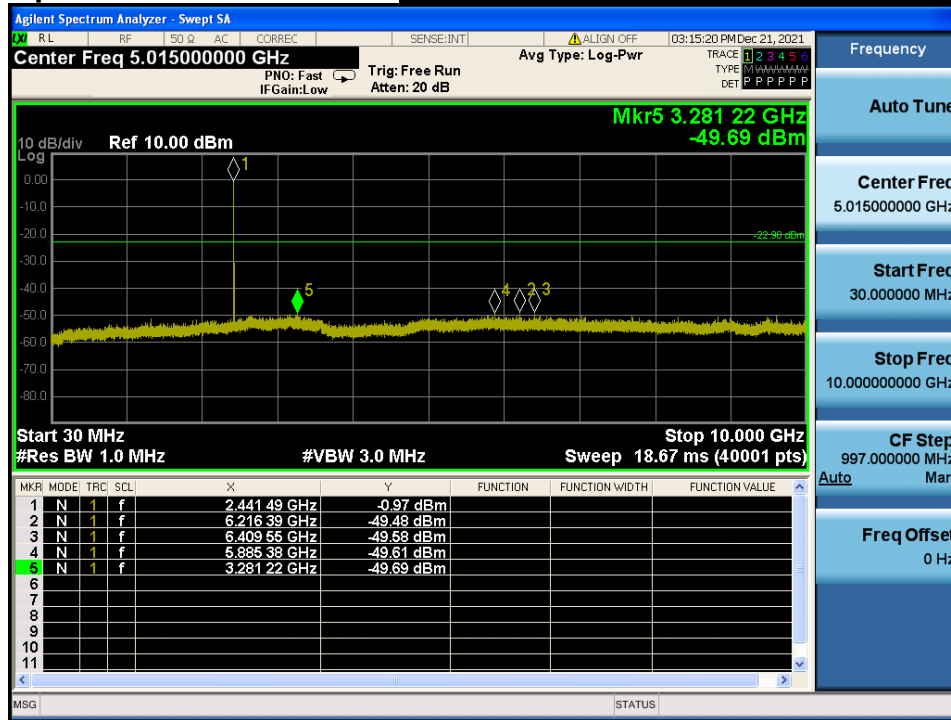

High Band-edge

**Highest Channel & Modulation :  $\pi/4$ DQPSK**

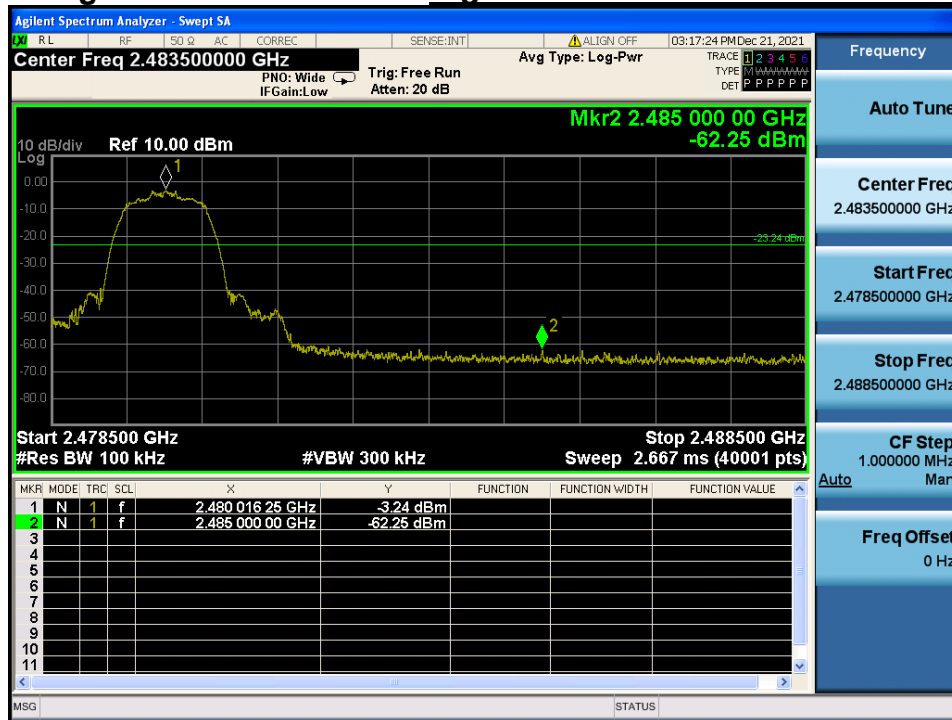

High Band-edge

**Hopping mode & Modulation :  $\pi/4$ DQPSK**

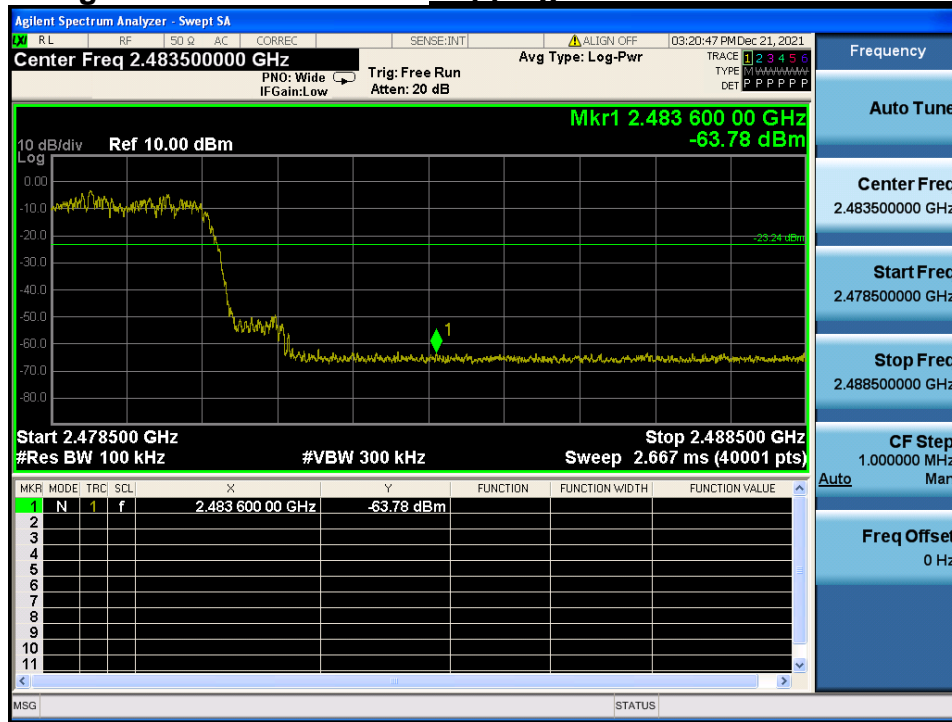

Conducted Spurious Emissions

Highest Channel & Modulation :  $\pi/4$ DQPSK

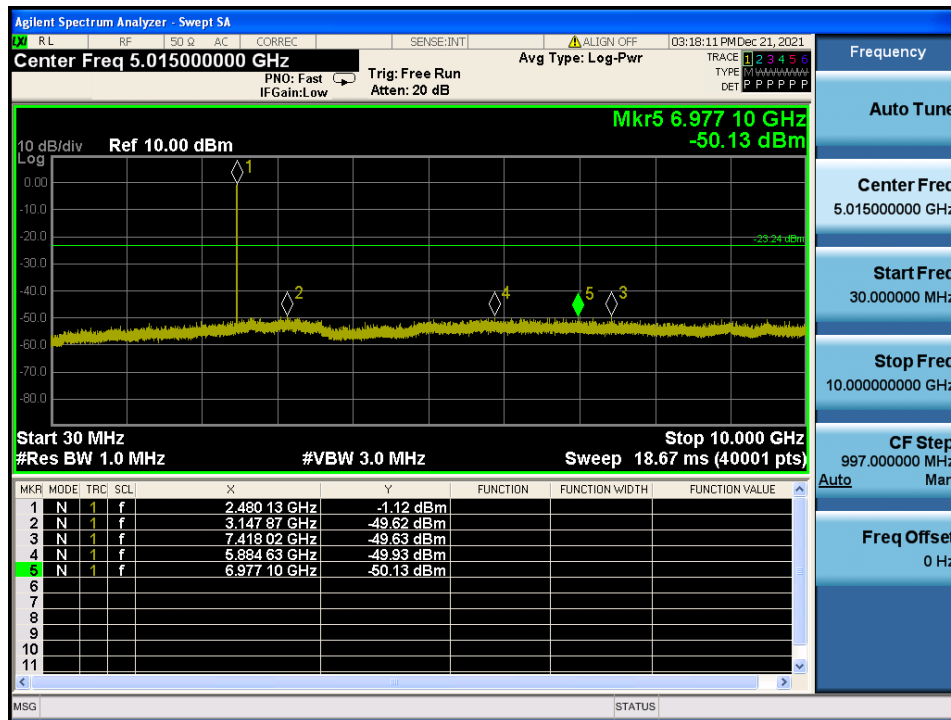
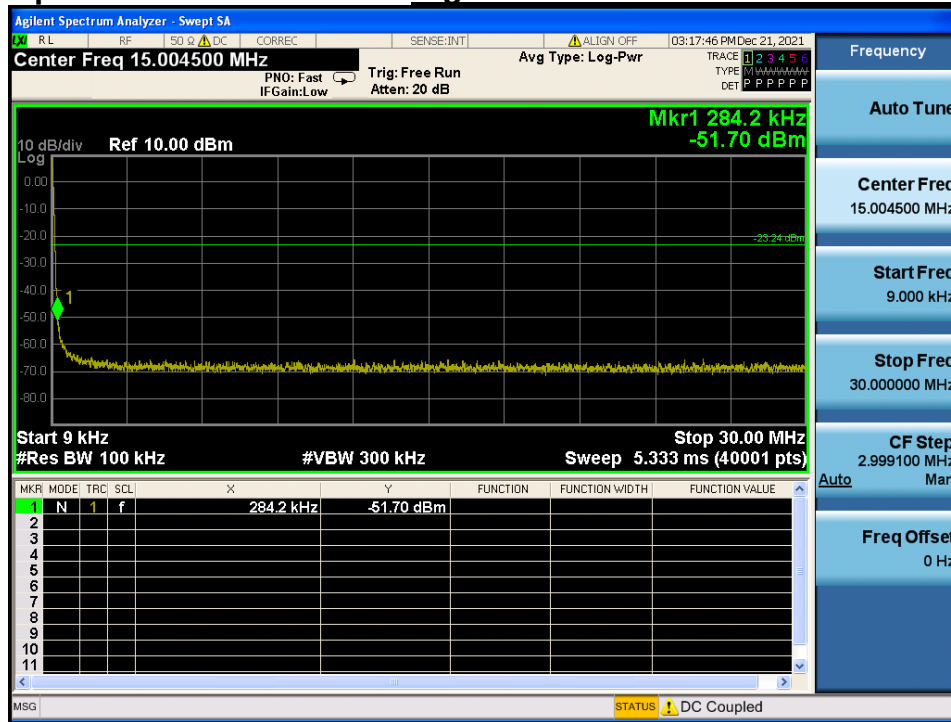

Conducted Spurious Emissions

Highest Channel & Modulation :  $\pi/4$ DQPSK

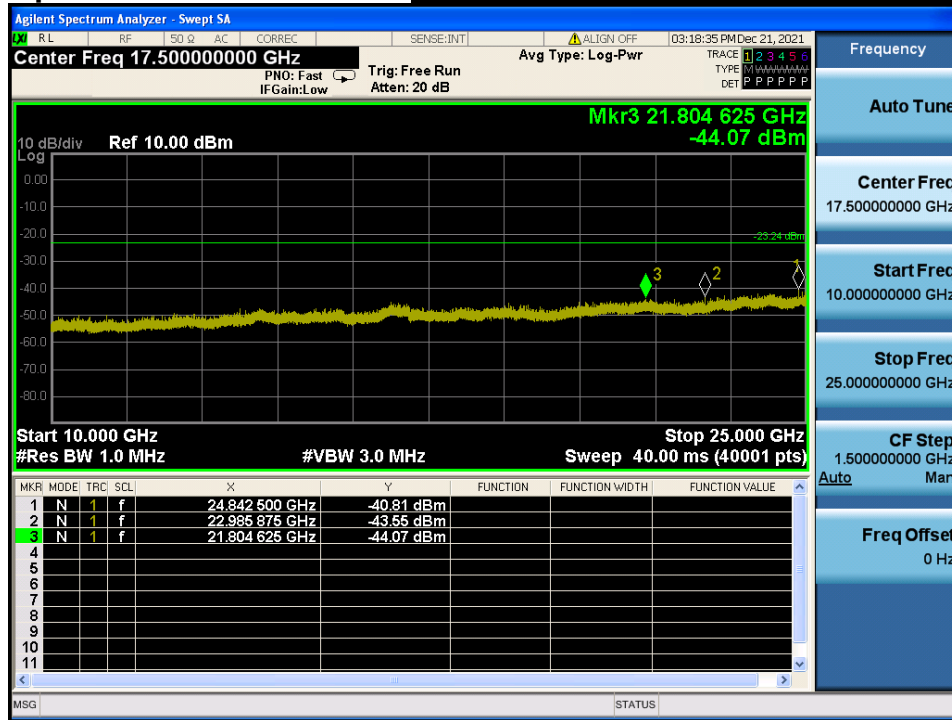



Low Band-edge

***Lowest Channel & Modulation : 8DPSK***

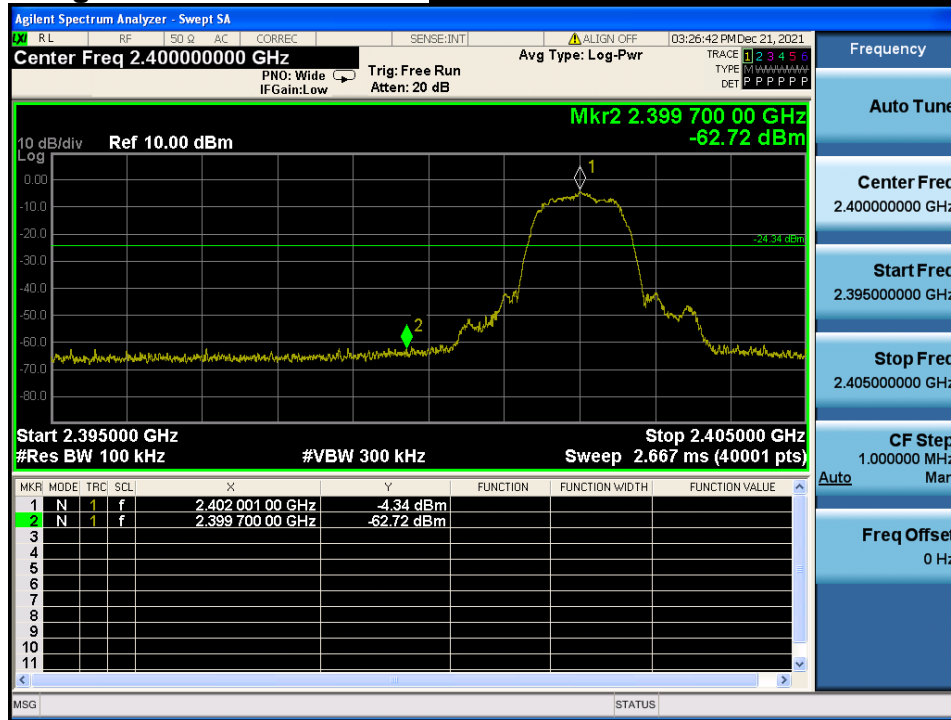

Low Band-edge

***Hopping mode & Modulation : 8DPSK***

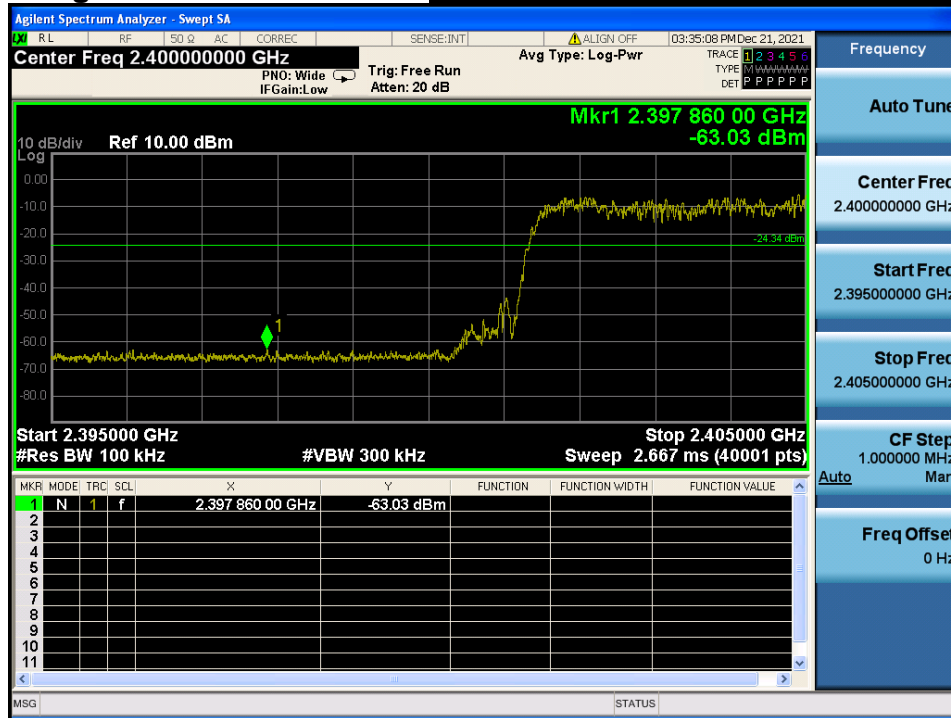

Conducted Spurious Emissions **Lowest Channel & Modulation : 8DPSK**

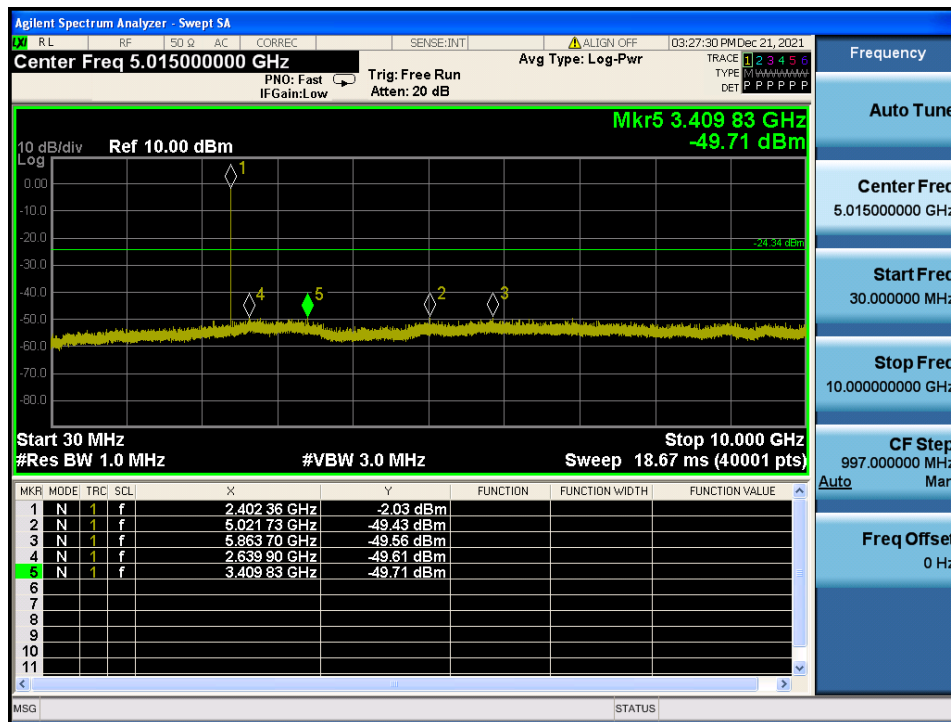
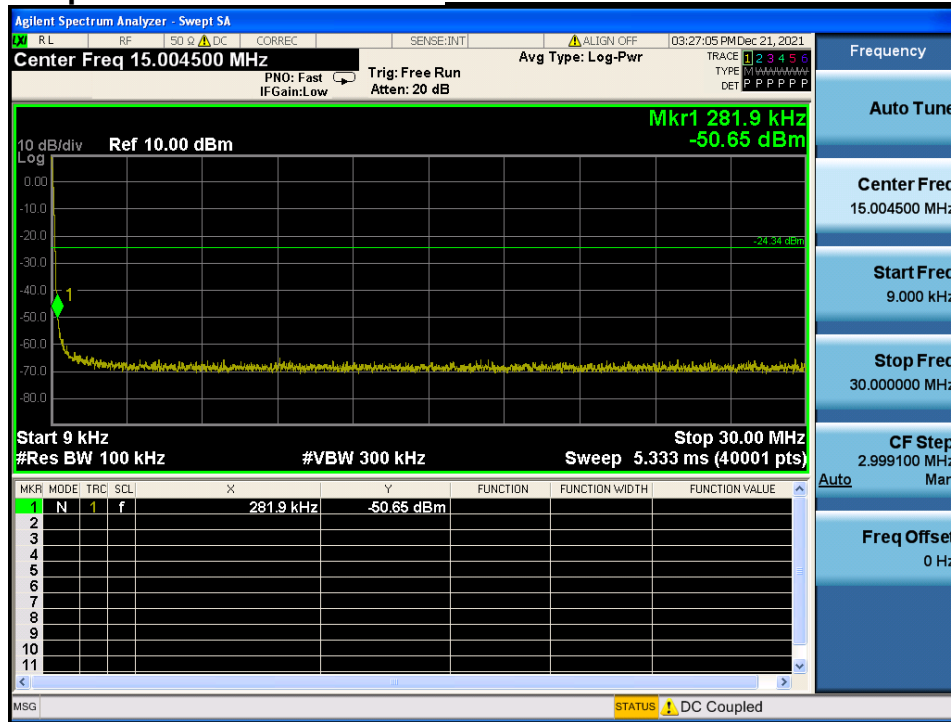

**Conducted Spurious Emissions** *Lowest Channel & Modulation : 8DPSK*

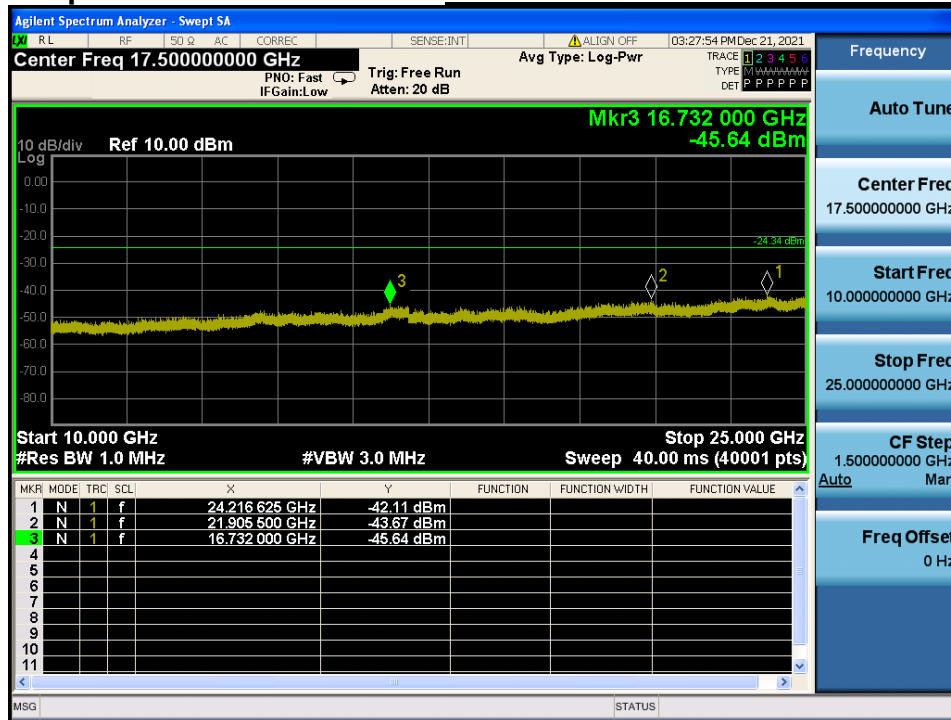

Reference for limit

Middle Channel & Modulation : 8DPSK

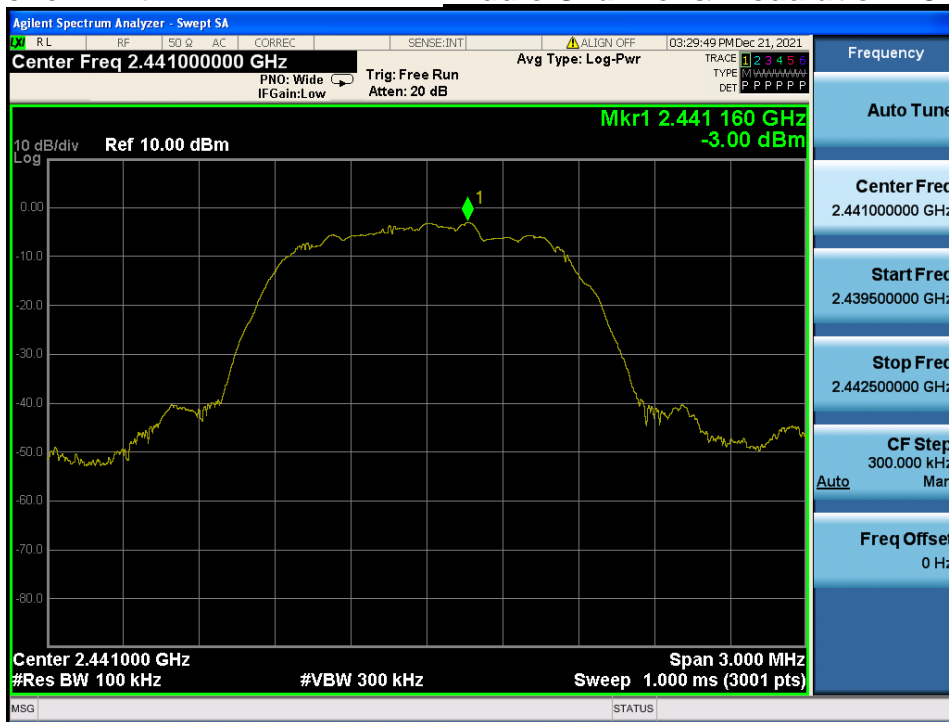

Conducted Spurious Emissions

Middle Channel & Modulation : 8DPSK

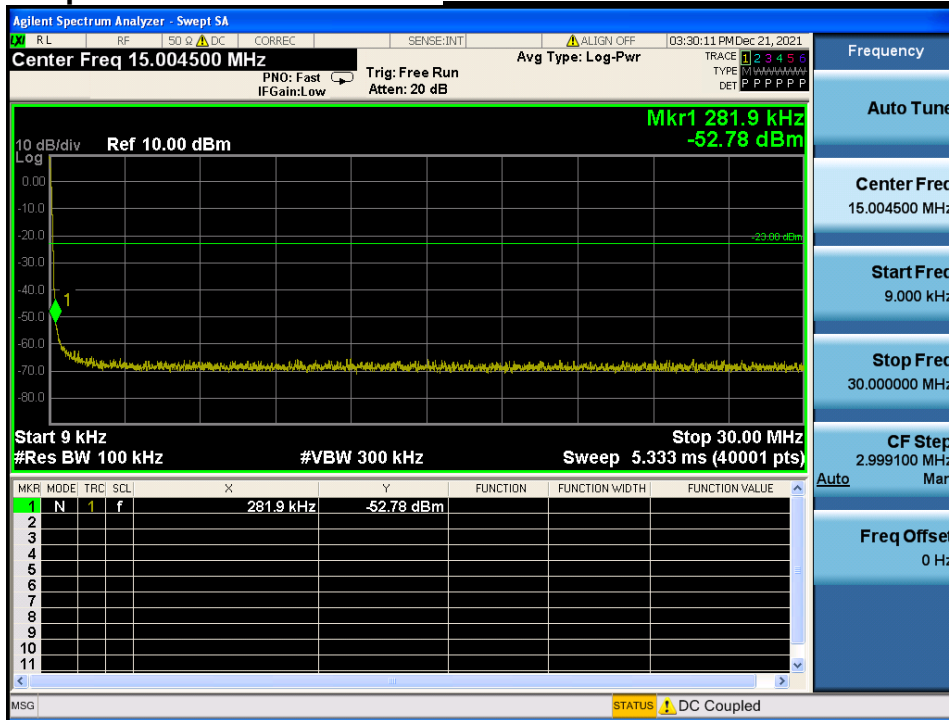

Conducted Spurious Emissions *Middle Channel & Modulation : 8DPSK*

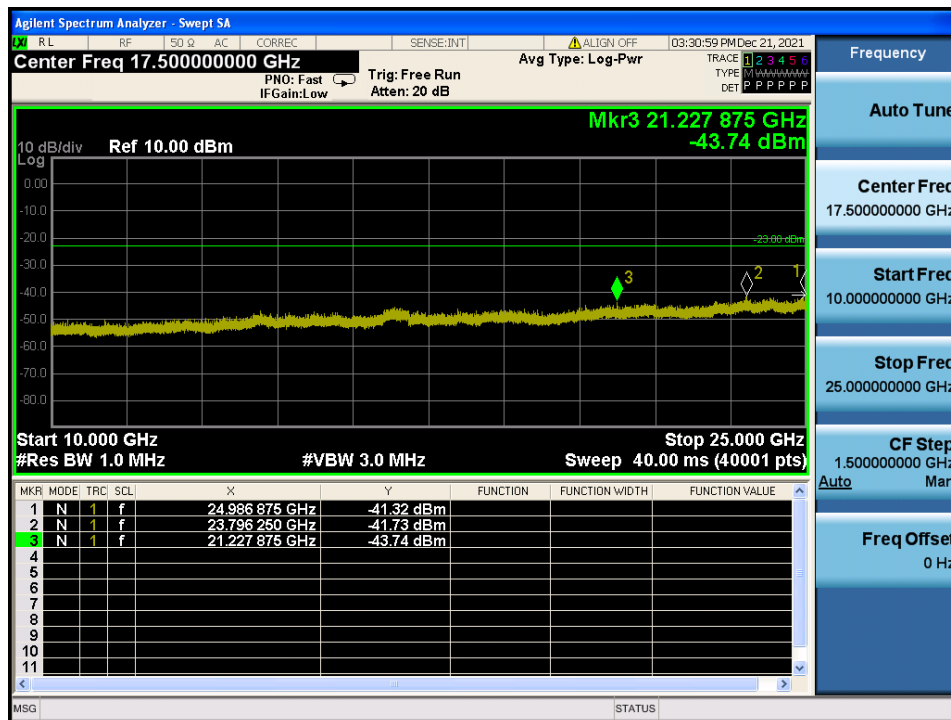
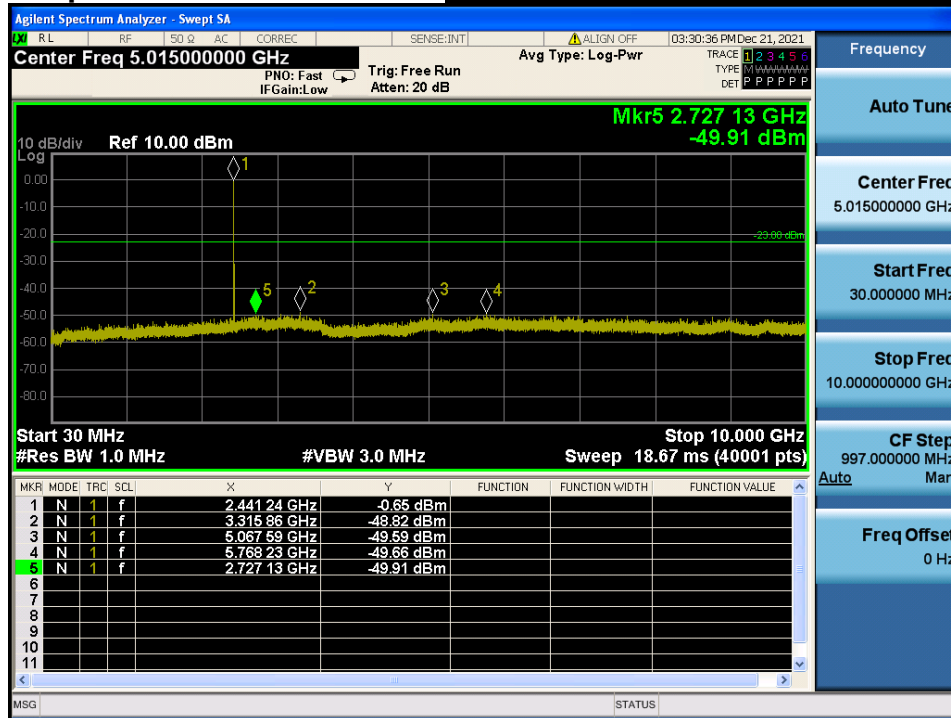

High Band-edge

Highest Channel & Modulation : 8DPSK

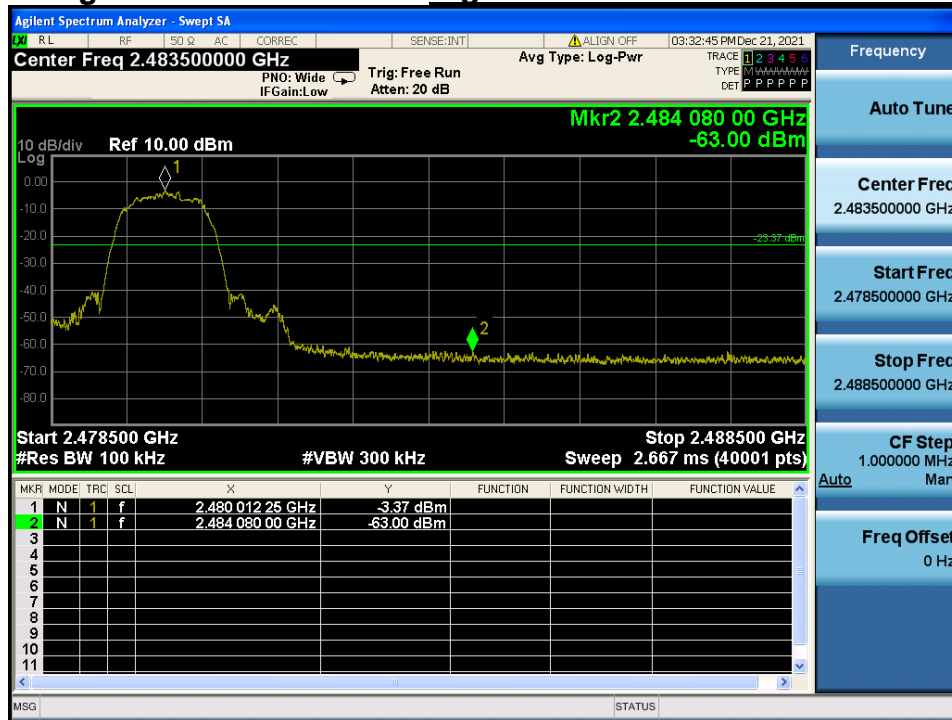

High Band-edge

Hopping mode & Modulation : 8DPSK

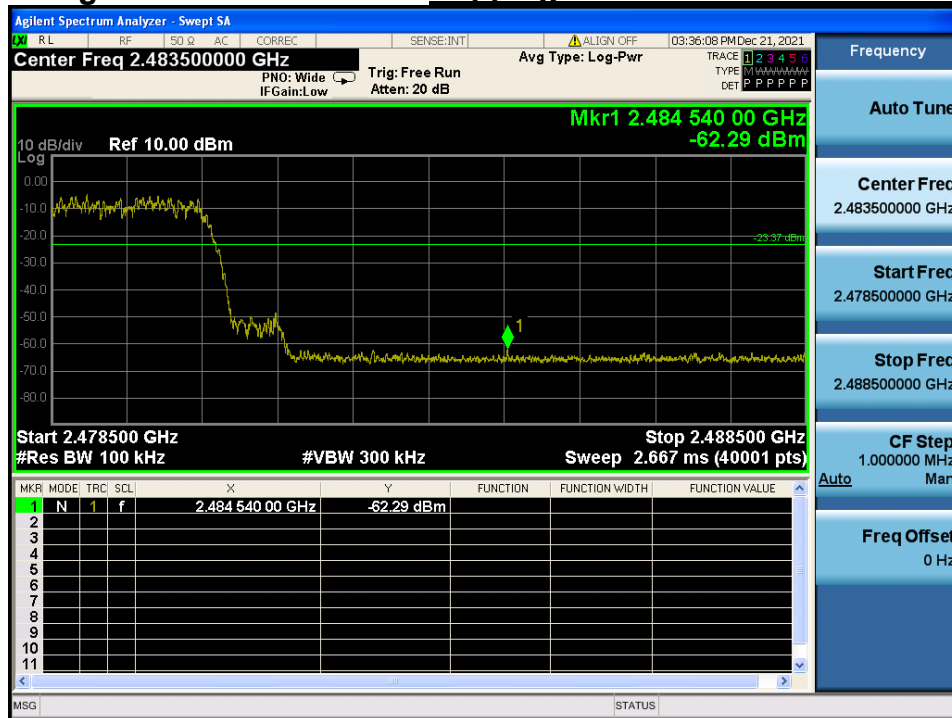

Conducted Spurious Emissions **Highest Channel & Modulation : 8DPSK**

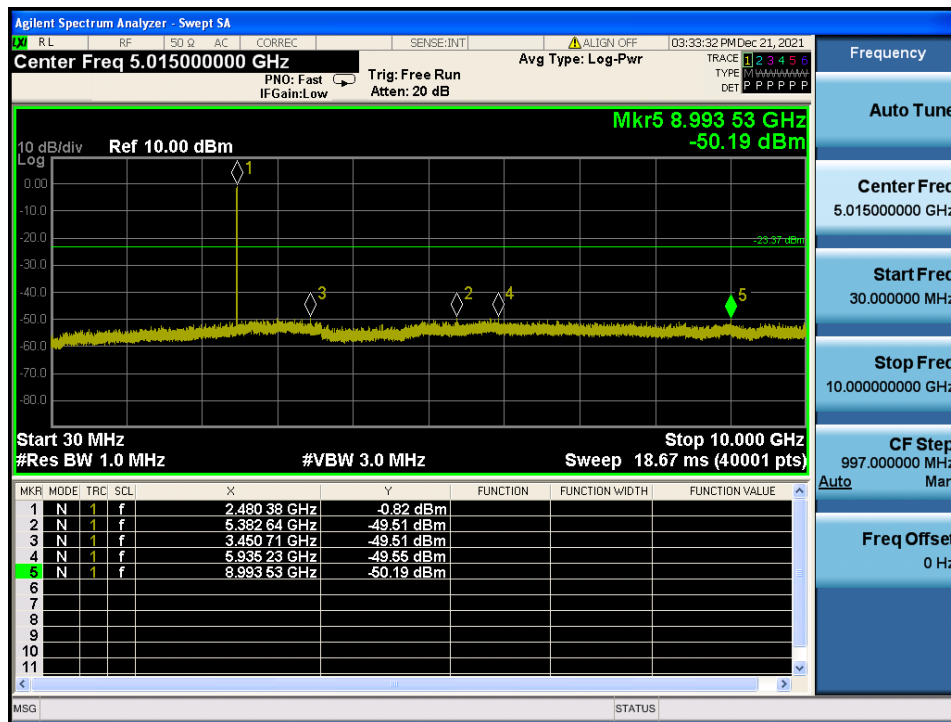
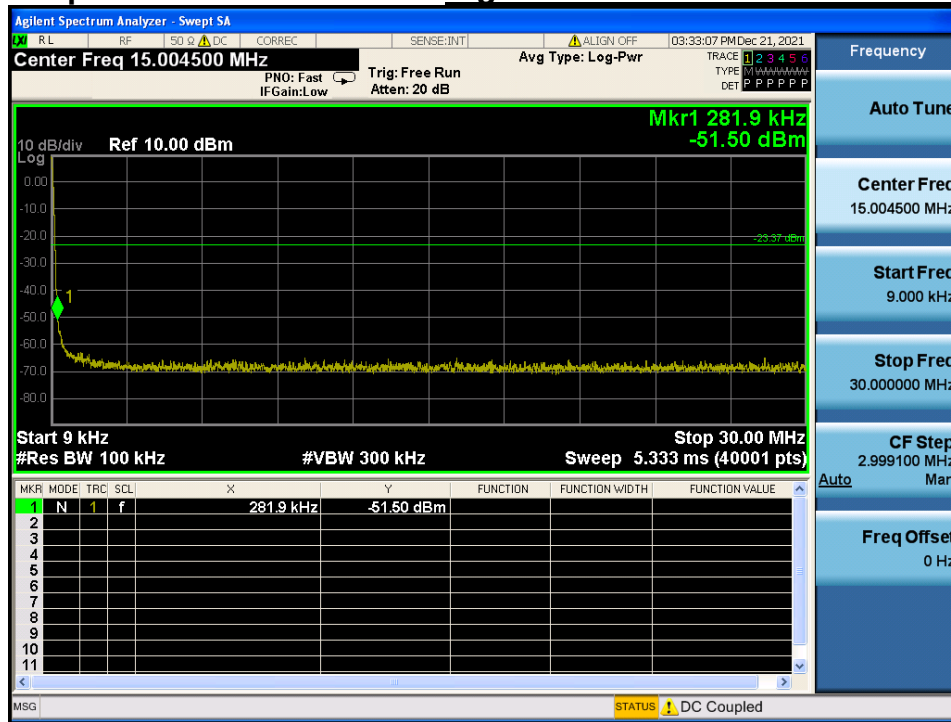

Conducted Spurious Emissions

Highest Channel & Modulation : 8DPSK

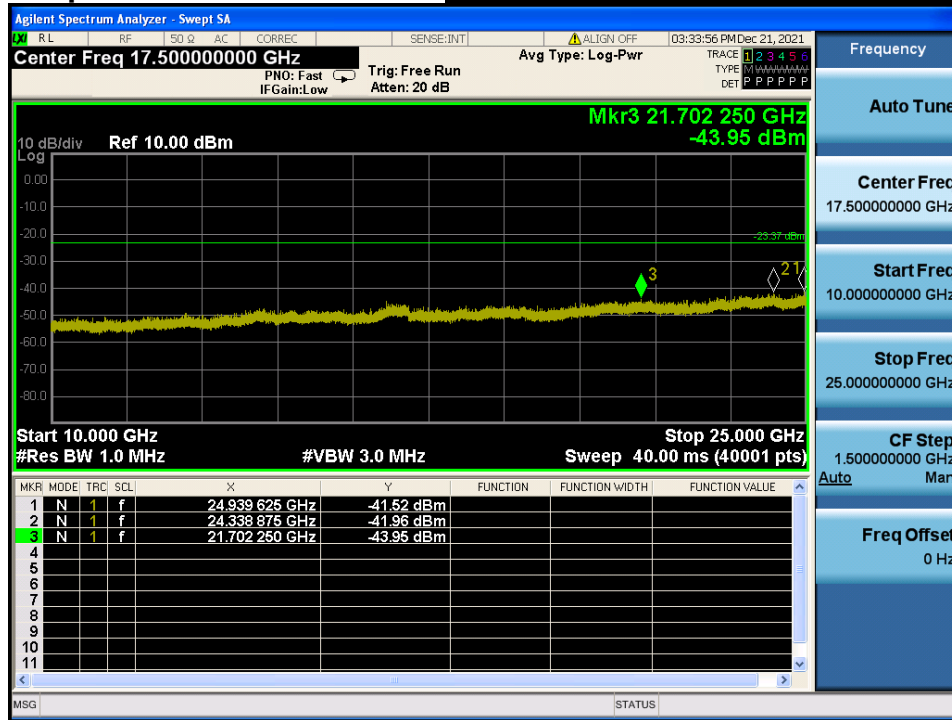



## 10. AC Power-Line Conducted Emissions

### 10.1. Test Setup

NA

### 10.2. Limit

According to §15.207(a) for an intentional radiator that is designed to be connected to the public utility (AC) power line, the radio frequency voltage that is conducted back onto the AC power line on any frequency or frequencies, within the band 150 kHz to 30 MHz, shall not exceed the limits in the following table, as measured using a 50 uH/50 ohm line impedance stabilization network (LISN).

Compliance with the provision of this paragraph shall on the measurement of the radio frequency voltage between each power line and ground at the power terminal. The lower applies at the boundary between the frequency ranges.

Frequency Range (MHz)	Conducted Limit (dBuV)	
	Quasi-Peak	Average
0.15 ~ 0.50	66 to 56 *	56 to 46 *
0.5 ~ 5.0	56	46
5 ~ 30	60	50

\* Decreases with the logarithm of the frequency

### 10.3. Test Procedure

Conducted emissions from the EUT were measured according to the ANSI C63.10.

1. The test procedure is performed in a 6.5 m × 3.5 m × 3.5 m (L × W × H) shielded room. The EUT along with its peripherals were placed on a 1.0 m (W) × 1.5 m (L) and 0.8 m in height wooden table and the EUT was adjusted to maintain a 0.4 meter space from a vertical reference plane.
2. The EUT was connected to power mains through a line impedance stabilization network (LISN) which provides 50 ohm coupling impedance for measuring instrument and the chassis ground was bounded to the horizontal ground plane of shielded room.
3. All peripherals were connected to the second LISN and the chassis ground also bounded to the horizontal ground plane of shielded room.
4. The excess power cable between the EUT and the LISN was bundled. The power cables of peripherals were unbundled. All connecting cables of EUT and peripherals were moved to find the maximum emission.

### 10.4. Test Results

NA

# APPENDIX I

## Test set up diagrams

### ▪ Radiated Measurement

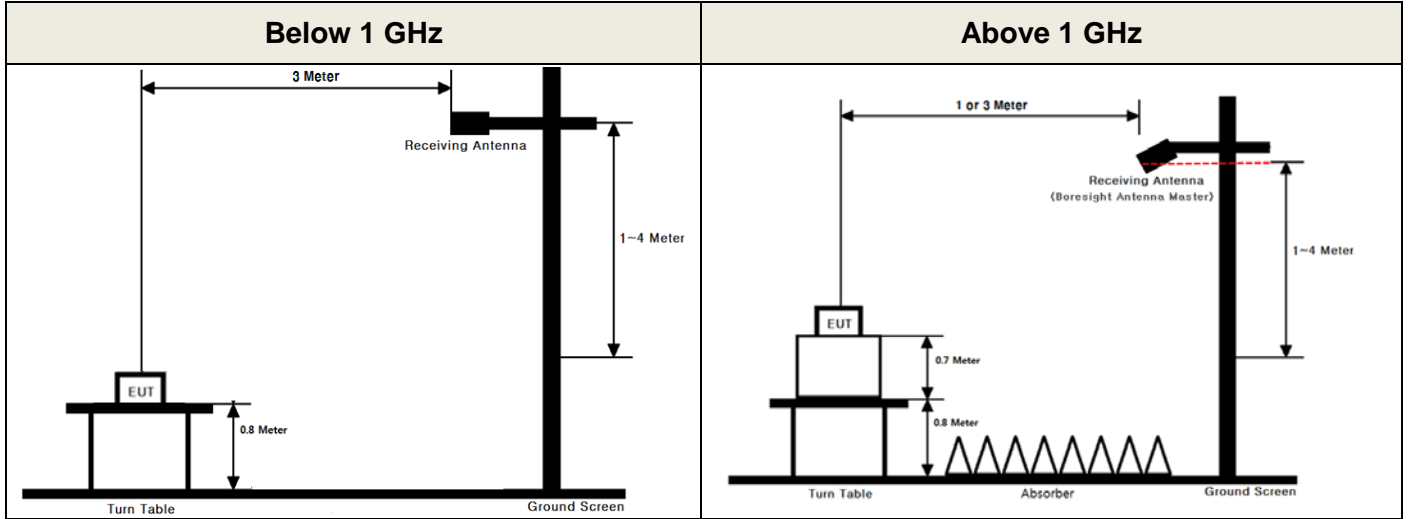

### ▪ Conducted Measurement

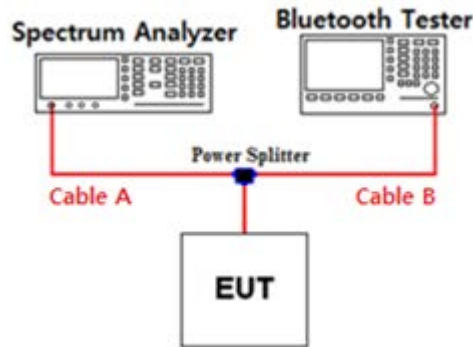

Path loss information

Frequency (GHz)	Path Loss (dB)	Frequency (GHz)	Path Loss (dB)
0.03	6.03	15	10.12
1	6.79	20	11.15
2.402 & 2.441 & 2.480	7.35	25	11.81
5	7.96	-	-
10	8.80	-	-

Note 1: The path loss from EUT to Spectrum analyzer was measured and used for test.  
 Path loss (S/A's correction factor) = Cable A + Power Splitter

## APPENDIX II

### Unwanted Emissions (Radiated) Test Plot

GFSK & Lowest & X & Ver

Detector Mode : PK

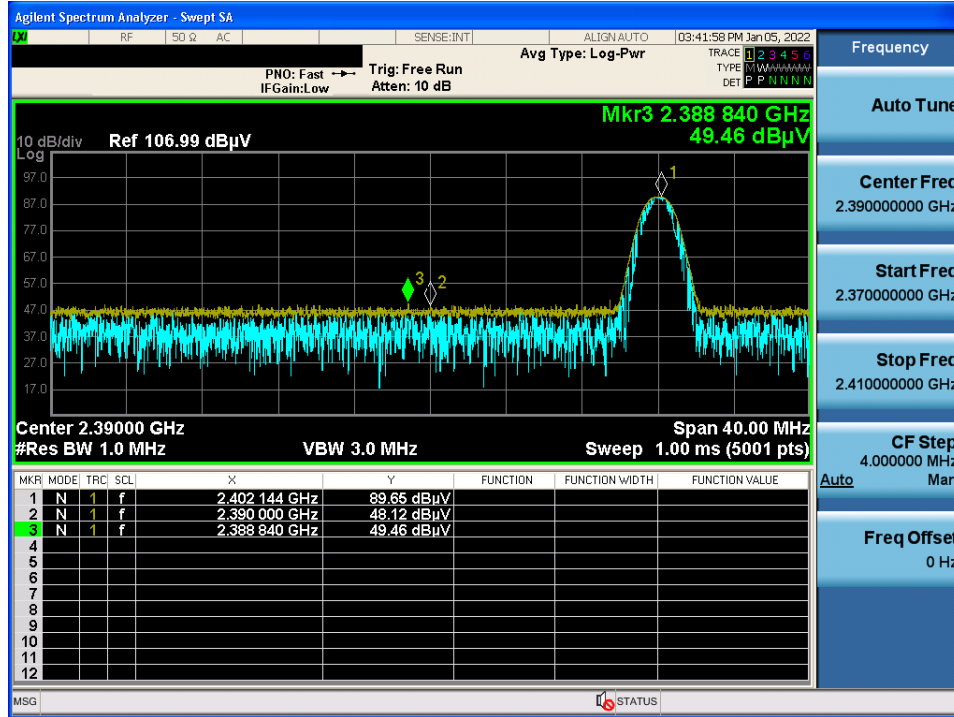

GFSK & Highest & X & Ver

Detector Mode : PK

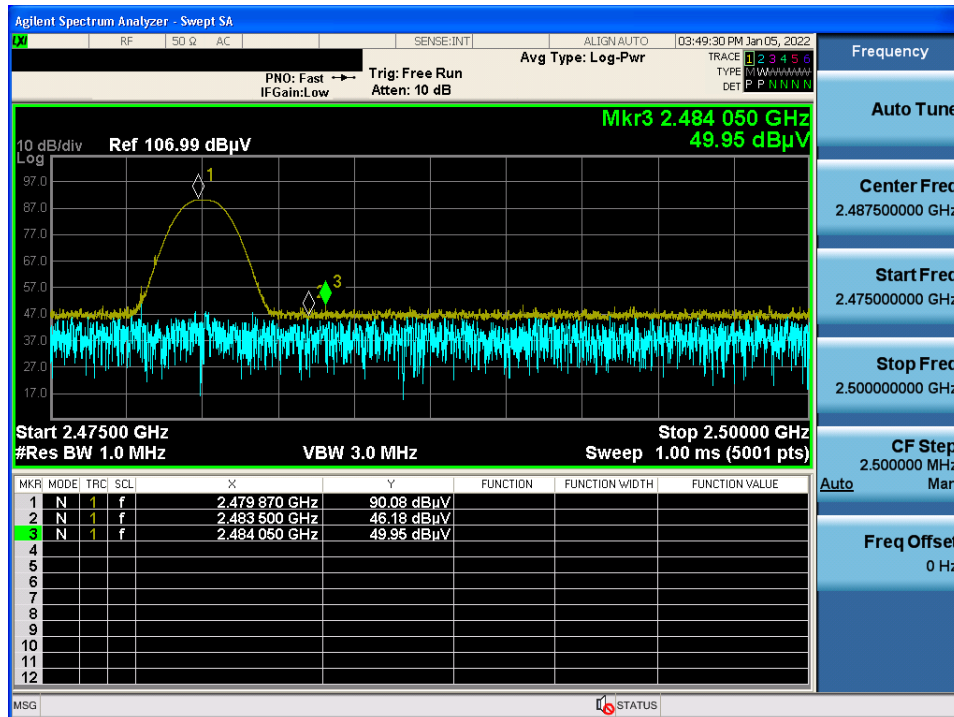

$\pi/4$ DQPSK & Lowest & X & Ver

Detector Mode : PK

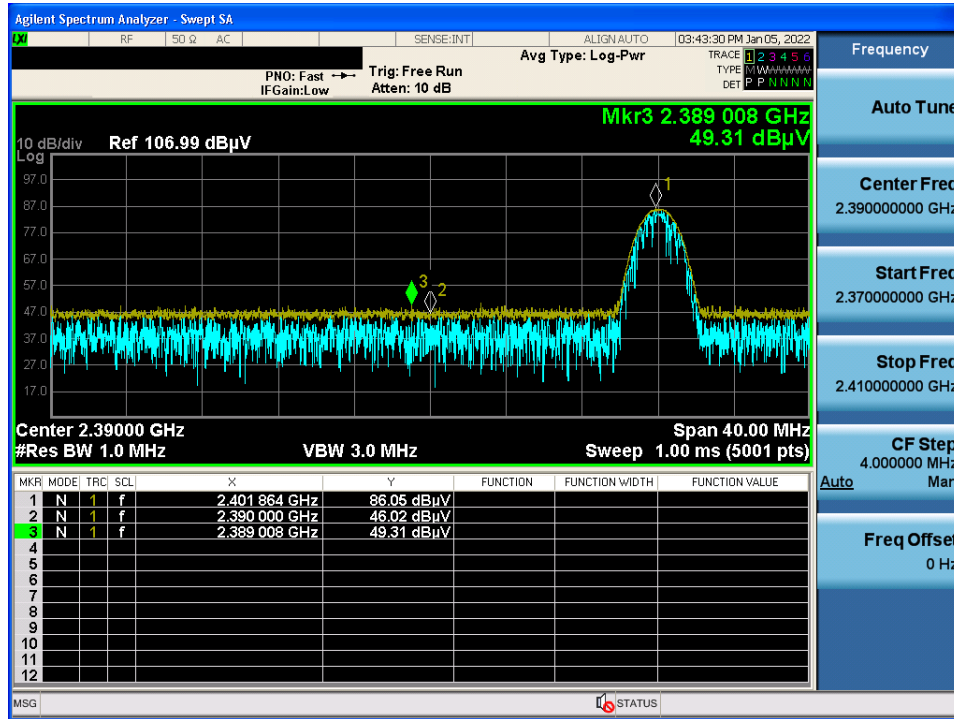

$\pi/4$ DQPSK & Highest & X & Ver

Detector Mode : PK

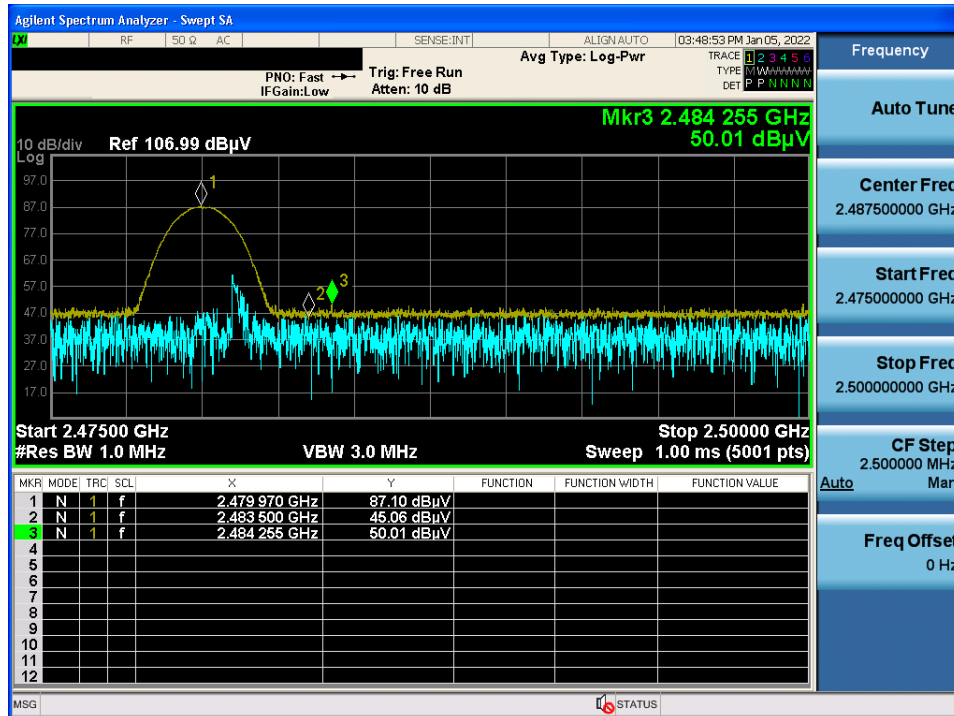

8DPSK & Lowest & X & Ver

Detector Mode : PK

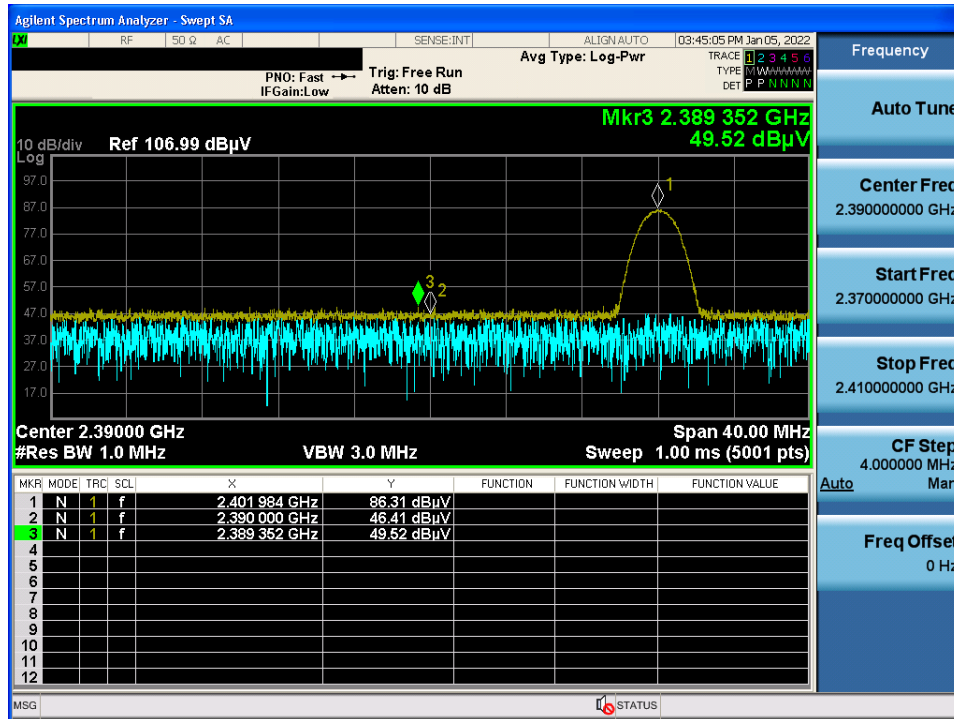

8DPSK & Highest & X & Ver

Detector Mode : PK

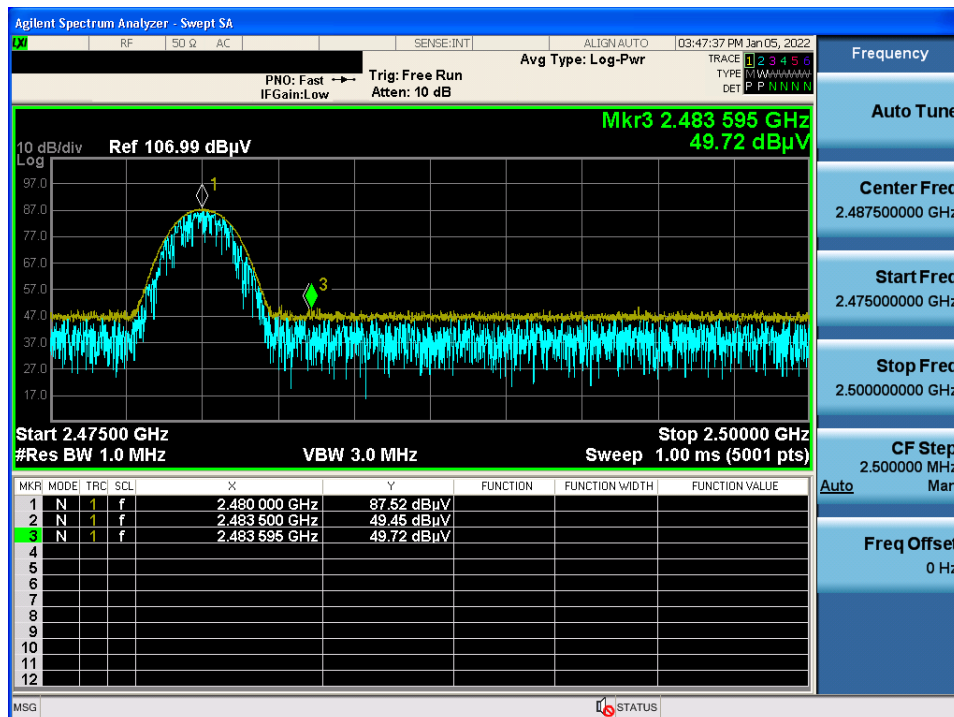

GFSK & Lowest & X & Ver

Detector Mode : PK

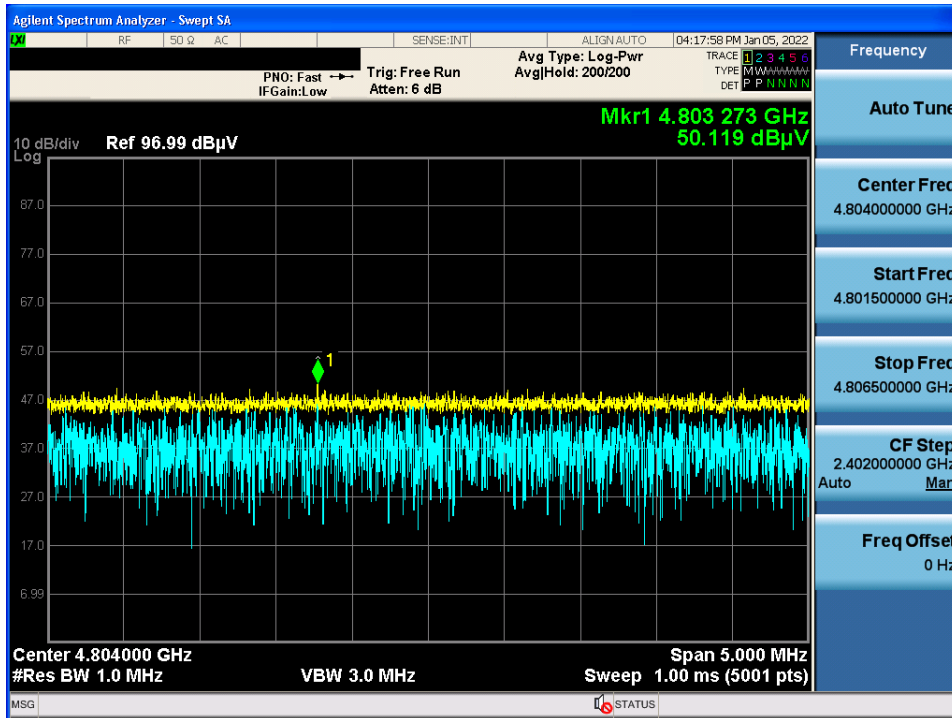

$\pi/4$ DQPSK & Lowest & X & Ver

Detector Mode : PK

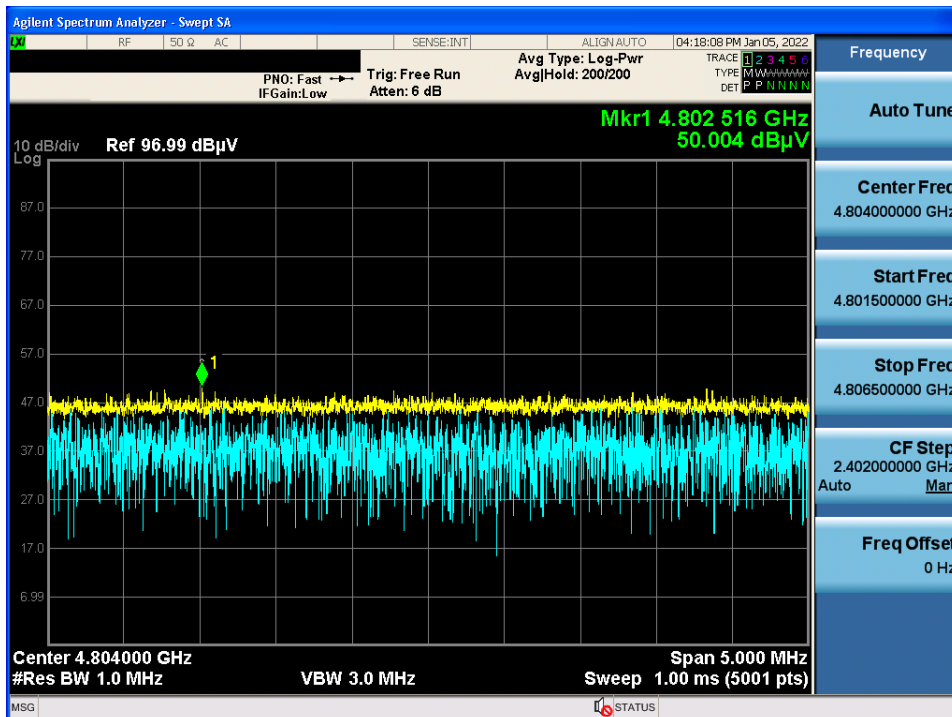

8DPSK & Lowest & X & Ver

Detector Mode : PK

