

TEST REPORT



DT&C Co., Ltd.

42, Yurim-ro, 154Beon-gil, Cheoin-gu, Yongin-si, Gyeonggi-do, Korea, 17042
Tel : 031-321-2664, Fax : 031-321-1664

1. Report No : DRTFCC2112-0161

2. Customer

• Name (FCC) : HYUNDAI MOBIS CO., LTD.

• Address (FCC) : 203, Teheran-ro Gangnam-gu Seoul South Korea 135-977

3. Use of Report : FCC Original Grant

4. Product Name / Model Name : DISPLAY CAR SYSTEM / DA330I6GG
FCC ID : TQ8-DA330I6GG

5. FCC Regulation(s): Part 15.247

Test Method used: KDB558074 D01v05r02, ANSI C63.10-2013

6. Date of Test : 2021.11.03 ~ 2021.11.30

7. Location of Test : Permanent Testing Lab On Site Testing

8. Testing Environment : See appended test report.

9. Test Result : Refer to the attached test result.

The results shown in this test report refer only to the sample(s) tested unless otherwise stated.
This test report is not related to KOLAS accreditation.

Affirmation	Tested by		Reviewed by	
	Name : ChangWon Lee	(Signature)	Name : JaeJin Lee	(Signature)

2021 . 12 . 22 .

DT&C Co., Ltd.

If this report is required to confirmation of authenticity, please contact to report@dtnc.net

Test Report Version

Test Report No.	Date	Description	Revised by	Reviewed by
DRTFCC2112-0161	Dec. 22, 2021	Initial issue	ChangWon Lee	JaeJin Lee

Table of Contents

1. General Information	4
1.1. Description of EUT	4
1.2. Declaration by the applicant / manufacturer	4
1.3. Testing Laboratory	5
1.4. Testing Environment	5
1.5. Measurement Uncertainty	5
1.6. Information about the FHSS characteristics	6
1.7. Conclusion of worst-case and operation mode	7
1.8. Test Equipment List.....	8
2. Antenna Requirement	9
3. Summary of Test Results	10
4. Maximum Peak Conducted Output Power	11
4.1. Test Setup	11
4.2. Limit.....	11
4.3. Test Procedure.....	11
4.4. Test Results	12
5. 20 dB BW	18
5.1. Test Setup	18
5.2. Limit.....	18
5.3. Test Procedure.....	18
5.4. Test Results	18
6. Carrier Frequency Separation	24
6.1. Test Setup	24
6.2. Limit.....	24
6.3. Test Procedure.....	24
6.4. Test Results	24
7. Number of Hopping Channels	29
7.1. Test Setup	29
7.2. Limit.....	29
7.3. Test Procedure.....	29
7.4. Test Results	29
8. Time of Occupancy	35
8.1. Test Setup	35
8.2. Limit.....	35
8.3. Test Procedure.....	35
8.4. Test Results	35
9. Unwanted Emissions	40
9.1. Test Setup	40
9.2. Limit.....	40
9.3. Test Procedures.....	42
9.3.1. Test Procedures for Unwanted Emissions(Radiated)	42
9.3.2. Test Procedures for Unwanted Emissions(Conducted).....	43
9.4. Test Results	44
9.4.1. Unwanted Emissions(Radiated).....	44
9.4.2. Unwanted Emissions(Conducted)	47
10. AC Power-Line Conducted Emissions	71
10.1. Test Setup	71
10.2. Limit.....	71
10.3. Test Procedure.....	71
10.4. Test Results	71
APPENDIX I	72
APPENDIX II	73

1. General Information

1.1. Description of EUT

Equipment Class	Spread Spectrum Transmitter(DSS)
Product Name	DISPLAY CAR SYSTEM
Model Name	DA330I6GG
Add Model Name	DA340I6GG
Firmware Version Identification Number	1.0
EUT Serial Number	No specified
Power Supply	DC 14.4 V
Frequency Range	2 402 MHz ~ 2 480 MHz
Max. RF Output Power	3.34 dBm (0.002 W)
Modulation Technique (Data rate)	GFSK(1 Mbps), $\pi/4$ DQPSK(2 Mbps), 8DPSK(3 Mbps)
Number of Channels	79
Antenna Specification	Antenna Type: Pattern Antenna Gain: -0.18 dBi (PK)

1.2. Declaration by the applicant / manufacturer

- NA

1.3. Testing Laboratory

DT&C Co., Ltd.		
The 3 m test site and conducted measurement facility used to collect the radiated data are located at the 42, Yurim-ro, 154beon-gil, Cheoin-gu, Yongin-si, Gyeonggi-do, Korea 17042.		
The test site complies with the requirements of Part 2.948 according to ANSI C63.4-2014.		
- FCC & IC MRA Designation No. : KR0034		
- ISED#: 5740A		
www.dtnet.net		
Telephone	:	+ 82-31-321-2664
FAX	:	+ 82-31-321-1664

1.4. Testing Environment

Ambient Condition	
▪ Temperature	+20 °C ~ +23 °C
▪ Relative Humidity	38 % ~ 40 %

1.5. Measurement Uncertainty

The measurement uncertainties shown below were calculated in accordance with requirements of ANSI C63.4-2014 and ANSI C63.10-2013. All measurement uncertainty values are shown with a coverage factor of $k = 2$ to indicate a 95 % level of confidence.

Parameter	Measurement uncertainty
Antenna-port conducted emission	1.0 dB (The confidence level is about 95 %, $k = 2$)
AC power-line conducted emission	3.4 dB (The confidence level is about 95 %, $k = 2$)
Radiated emission (1 GHz Below)	4.9 dB (The confidence level is about 95 %, $k = 2$)
Radiated emission (1 GHz ~ 18 GHz)	5.0 dB (The confidence level is about 95 %, $k = 2$)
Radiated emission (18 GHz Above)	5.3 dB (The confidence level is about 95 %, $k = 2$)

1.6. Information about the FHSS characteristics

- This Bluetooth module has been tested by a Bluetooth Qualification Lab, and we confirm the following :

A) The hopping sequence is pseudorandom

Note 1 : Pseudorandom Frequency Hopping Sequence Table as below:

Channel: 08, 24, 40, 56, 42, 54, 72, 09, 01, 11, 33, 41, 34, 42, 65, 73, 53, 69, 06, 22, 04, 20,
36, 52, 38, 46, 70, 78, 68, 76, 21, 29, 10, 26, 41, 58, 44, 60, 76, 13, 03, 11, 35, 43,
37, 45, 69, 77, 52, 71, 08, 24, 06, 24, 48, 56, 45, 46, 70, 01, 72, 06, 25, 33, 12, 28,
49, 60, 45, 58, 74, 13, 05, 18, 37, 49 etc

The System receiver have input bandwidths that match the hopping channel bandwidths of their corresponding transmitters and shift frequencies in synchroniztation with the transmitted signals.

B) All channels are used equally on average

C) The receiver input bandwidth equals the transmit bandwidth

D) The receiver hops in sequence with the transmit signal

- 15.247(g) : In accordance with the Bluetooth Industry Standard, the system is designed to comply with all of the regulations in Section 15.247 when the transmitter is presented with a continuous data (or information) system.
- 15.247(h) : In accordance with the Bluetooth Industry Standard, the system does not coordinate its channels selection / hopping sequence with other frequency hopping systems for the express purpose of avoiding the simultaneous occupancy of individual hopping frequencies by multiple transmitters.
- 15.247(h) : The EUT employs Adaptive Frequency Hopping (AFH) which identifies sources of interference namely devices operating in 802.11 WLAN and excludes them from the list of available channels. The process of re-mapping reduces the number of test channels from 79 channels to a minimum number of 20 channels.

1.7. Conclusion of worst-case and operation mode

The EUT has three types of modulation (GFSK, $\pi/4$ DQPSK and 8DPSK). Therefore all applicable requirements were tested with all the modulations. And packet type was tested at the worst case(DH5).

EUT Operation test setup

Bluetooth tester was used to control the transmit parameters during test.

Tested frequency information,

- Hopping Function : Enable

	Tested Frequency (MHz)
Hopping Band	2 402 ~ 2 480

- Hopping Function : Disable

	Tested Frequency (MHz)
Lowest Channel	2 402
Middle Channel	2 441
Highest Channel	2 480

1.8. Test Equipment List

Type	Manufacturer	Model	Cal.Date (yy/mm/dd)	Next.Cal.Date (yy/mm/dd)	S/N
Spectrum Analyzer	Agilent Technologies	N9020A	21/06/24	22/06/24	MY50200867
Spectrum Analyzer	Agilent Technologies	N9020A	20/12/16	21/12/16	MY48011700
Spectrum Analyzer	Agilent Technologies	N9020A	21/06/24	22/06/24	US47360812
DC Power Supply	Agilent Technologies	66332A	21/06/24	22/06/24	US37473627
DC Power Supply	SM techno	SDP30-5D	21/06/24	22/06/24	305DMG305
DC Power Supply	SM techno	SDP30-5D	21/06/24	22/06/24	305DNF079
Multimeter	FLUKE	17B+	20/12/16	21/12/16	36390701WS
Signal Generator	Rohde Schwarz	SMBV100A	20/12/16	21/12/16	255571
Signal Generator	ANRITSU	MG3695C	20/12/16	21/12/16	173501
Thermohygrometer	BODYCOM	BJ5478	20/12/16	21/12/16	120612-2
Thermohygrometer	BODYCOM	BJ5478	21/06/24	22/06/24	N/A
Thermohygrometer	XIAOMI	MHO-C201	20/12/16	21/12/16	00089675
BlueTooth Tester	Tescom	TC-3000C	21/06/24	22/06/24	3000C000563
Power Splitter	Anritsu	K241B	20/12/16	21/12/16	1301182
Loop Antenna	ETS-Lindgren	6502	21/01/28	23/01/28	00226186
BILOG ANTENNA	Schwarzbeck	VULB 9160	20/12/16	21/12/16	3362
Horn Antenna	ETS-Lindgren	3117	21/06/24	22/06/24	00143278
Horn Antenna	A.H.Systems Inc.	SAS-574	21/06/24	22/06/24	155
PreAmplifier	tsj	MLA-0118-B01-40	20/12/16	21/12/16	1852267
PreAmplifier	tsj	MLA-1840-J02-45	21/06/24	22/06/24	16966-10728
PreAmplifier	H.P	8447D	20/12/16	21/12/16	2944A07774
High Pass Filter	Wainwright Instruments	WHKX12-935-1000-15000-40SS	21/06/24	22/06/24	8
High Pass Filter	Wainwright Instruments	WHKX10-2838-3300-18000-60SS	21/06/24	22/06/24	1
High Pass Filter	Wainwright Instruments	WHNX8.0/26.5-6SS	21/06/24	22/06/24	3
Attenuator	Hefei Shunze	SS5T2.92-10-40	21/06/24	22/06/24	16012202
Attenuator	SRTechnology	F01-B0606-01	21/06/24	22/06/24	13092403
Attenuator	Aeroflex/Weinschel	56-3	21/06/24	22/06/24	Y2370
Attenuator	SMAJK	SMAJK-2-3	21/06/24	22/06/24	2
Power Meter & Wide Bandwidth Sensor	Anritsu	ML2496A MA2490A	20/12/16	21/12/16	1338004 1249303
Cable	DT&C	Cable	21/01/08	22/01/08	G-1
Cable	DT&C	Cable	21/01/08	22/01/08	G-2
Cable	HUBER+SUHNER	SUCOFLEX 100	21/01/08	22/01/08	G-3
Cable	DT&C	Cable	21/01/08	22/01/08	G-4
Cable	Radiall	TESTPRO3	21/01/08	22/01/08	M-01
Cable	DT&C	Cable	21/01/08	22/01/08	M-02
Cable	HUBER+SUHNER	SUCOFLEX 104	21/01/08	22/01/08	M-03
Cable	Junkosha	MWX221	21/01/08	22/01/08	M-07
Cable	HUBER+SUHNER	SUCOFLEX106	21/01/08	22/01/08	M-09
Cable	Junkosha	MWX241	21/01/08	22/01/08	mmW-1
Cable	Junkosha	MWX241	21/01/08	22/01/08	mmW-4
Cable	DT&C	Cable	21/01/05	22/01/05	RFC-45
Test Software	tsj	Raidated Emission Measurement	NA	NA	Version 2.00.0177

Note1: The measurement antennas were calibrated in accordance to the requirements of ANSI C63.5-2017

Note2: The cable is not a regular calibration item, so it has been calibrated by DT & C itself.

2. Antenna Requirement

An intentional radiator shall be designed to ensure that no antenna other than that furnished by the responsible party shall be used with the device. The use of a permanently attached antenna or of an antenna that uses a unique coupling to the intentional radiator shall be considered sufficient to comply with the provisions.

Conclusion: Comply

The antenna is permanently printed on the PCB. (Refer to Internal Photo file.)

Therefore this E.U.T complies with the requirement of Part 15.203

3. Summary of Test Results

FCC part section(s)	Test Description	Limit (Using in 2400~ 2483.5 MHz)	Test Condition	Status Note 1
15.247(a) 15.247(b)	Maximum Peak Conducted Output Power	=< 0.125 W(conducted)	Conducted	C
15.247(a)	20 dB Bandwidth	NA		C
	Carrier Frequency Separation	>= 25 kHz or >= Two thirds of the 20 dB BW, whichever is greater.		C
	Number of Hopping Channels	>= 15 hops		C
	Time of Occupancy	=< 0.4 seconds		C
15.247(d)	Unwanted Emissions (Conducted)	The radiated emission to any 100 kHz of out-band shall be at least 20 dB below the highest in-band spectral density.		C
15.247(d) 15.205 15.209	Unwanted Emissions (Radiated)	Part 15.209 Limits (Refer to section 9)	Radiated	C
15.207	AC Power-Line Conducted Emissions	Part 15.207 Limits (Refer to section 10)	AC Line Conducted	NA ^{Note3}
15.203	Antenna Requirement	Part 15.203 (Refer to section 2)	-	C
Note 1: C = Comply NC = Not Comply NT = Not Tested NA = Not Applicable Note 2: For radiated emission tests below 30 MHz were performed on semi-anechoic chamber which is correlated with OATS. Note 3: This device is installed in a car. Therefore the power source is a battery of car.				

4. Maximum Peak Conducted Output Power

4.1. Test Setup

Refer to the APPENDIX I.

4.2. Limit

■ FCC Requirements

The maximum peak output power of the intentional radiator shall not exceed the following :

1. §15.247(a)(1), Frequency hopping systems shall have hopping channel carrier frequencies separated by a minimum of 25 kHz or the 20 dB bandwidth of the hopping channel, whichever is greater. Alternatively, frequency hopping systems operating in the 2 400 MHz - 2 483.5 MHz band may have hopping channel carrier frequencies that are separated by 25 kHz or two-thirds of the 20 dB bandwidth of the hopping channel, whichever is greater, provided the systems operate with an output power no greater than 125 mW.
2. §15.247(b)(1), For frequency hopping systems operating in the 2 400 – 2 483.5 MHz employing at least 75 non-overlapping hopping channels, and all frequency hopping systems in the 5 725 MHz – 5 805 MHz band : 1 Watt. For all other frequency hopping systems in the 2 400 MHz – 2 483.5 MHz band: 0.125 watts.

4.3. Test Procedure

1. The RF output power was measured with a spectrum analyzer connected to the RF Antenna connector (conducted measurement) while EUT was operating in transmit mode at the appropriate center frequency, A spectrum analyzer was used to record the shape of the transmit signal.
2. The peak output power of the fundamental frequency was measured with the spectrum analyzer using ;
Span = approximately 5 times of the 20 dB bandwidth, centered on a hopping channel
RBW \geq 20 dB BW
VBW \geq RBW
Sweep = auto
Detector function = peak
Trace = max hold

4.4. Test Results

Modulation	Tested Channel	Burst Average Output Power		Peak Output Power	
		dBm	mW	dBm	mW
<u>GFSK</u>	Lowest	2.18	1.65	2.39	1.73
	Middle	3.25	2.11	3.34	2.16
	Highest	3.08	2.03	3.26	2.12
<u>$\pi/4$DQPSK</u>	Lowest	-2.98	0.50	-0.52	0.89
	Middle	-1.41	0.72	0.45	1.11
	Highest	-1.23	0.75	0.90	1.23
<u>8DPSK</u>	Lowest	-2.99	0.50	-0.48	0.90
	Middle	-1.39	0.73	0.91	1.23
	Highest	-1.21	0.76	1.17	1.31

Note 1: The average output power was tested using an average power meter for reference only.

Note 2: See next pages for actual measured spectrum plots.

Peak Output Power

Lowest Channel & Modulation : GFSK

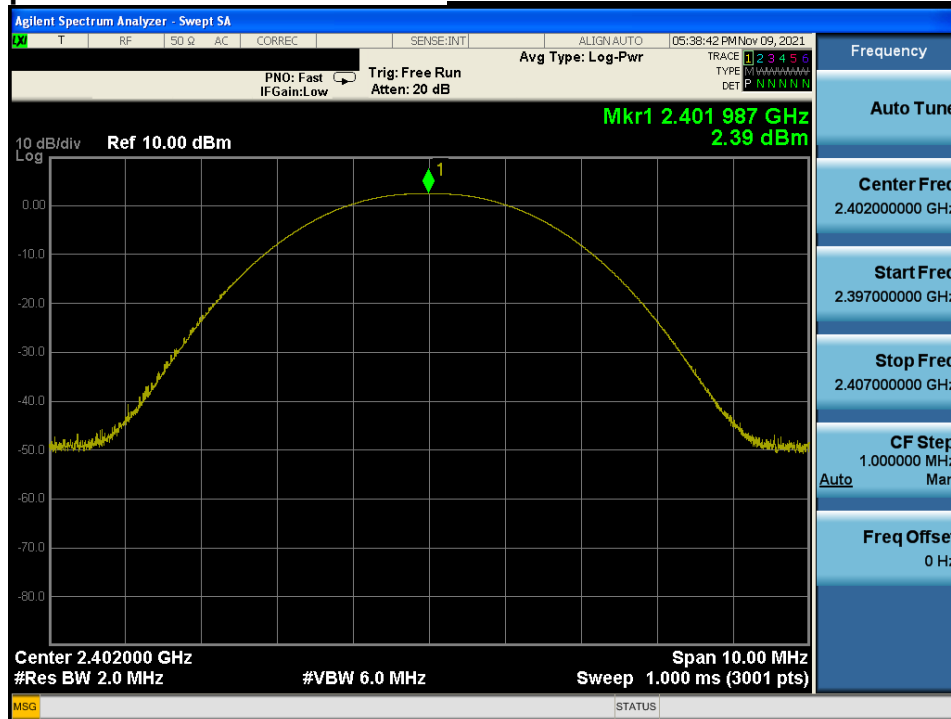

Peak Output Power

Middle Channel & Modulation : GFSK

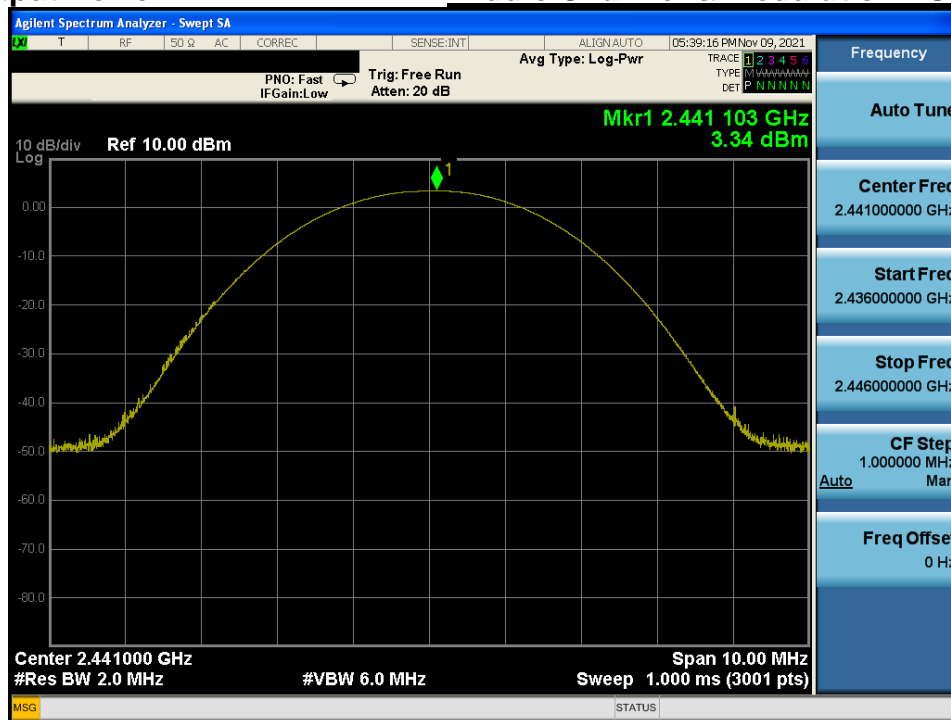

Peak Output Power

Highest Channel & Modulation : GFSK

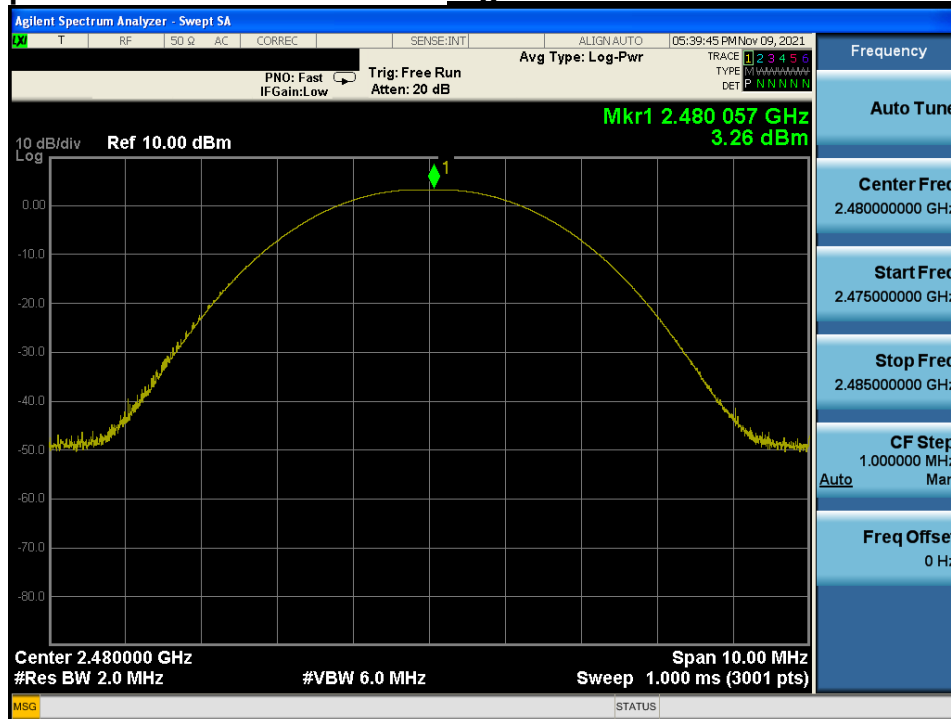

Peak Output Power

Lowest Channel & Modulation : $\pi/4$ DQPSK

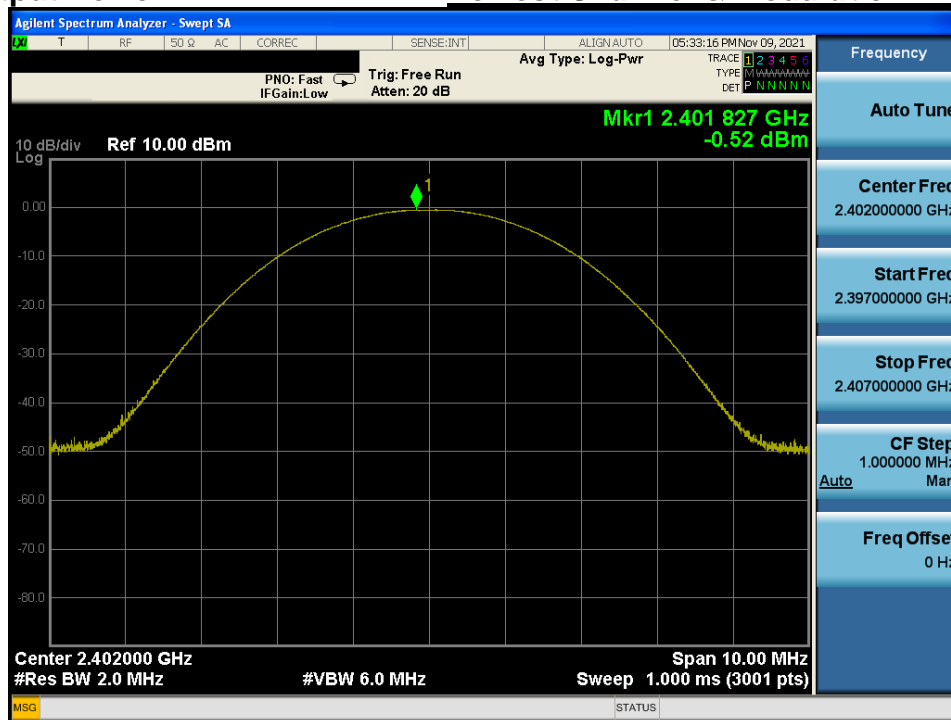

Peak Output Power

Middle Channel & Modulation : $\pi/4$ DQPSK

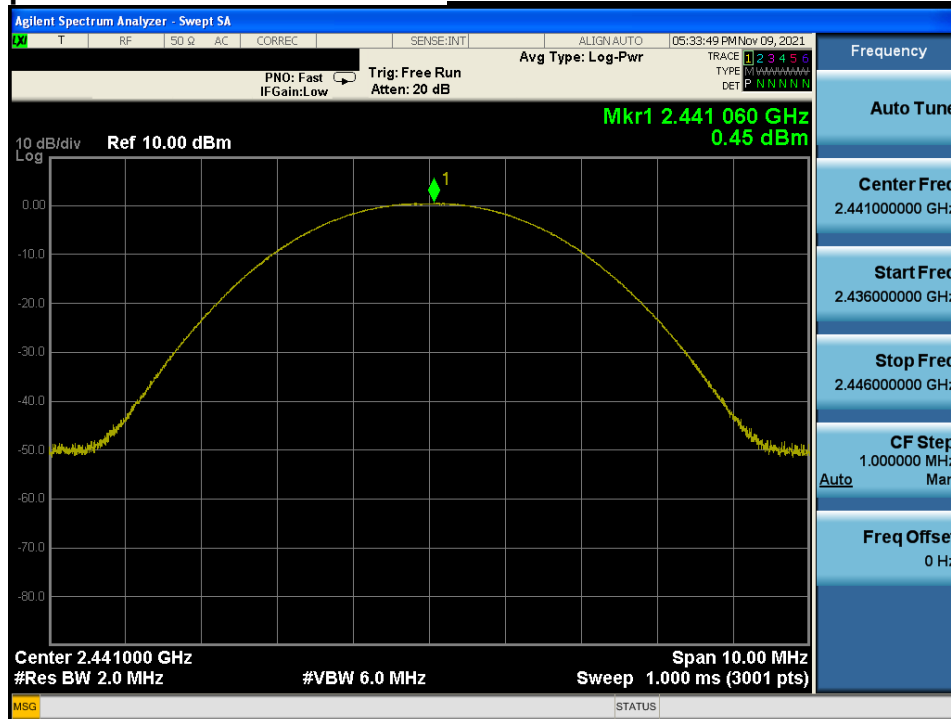

Peak Output Power

Highest Channel & Modulation : $\pi/4$ DQPSK

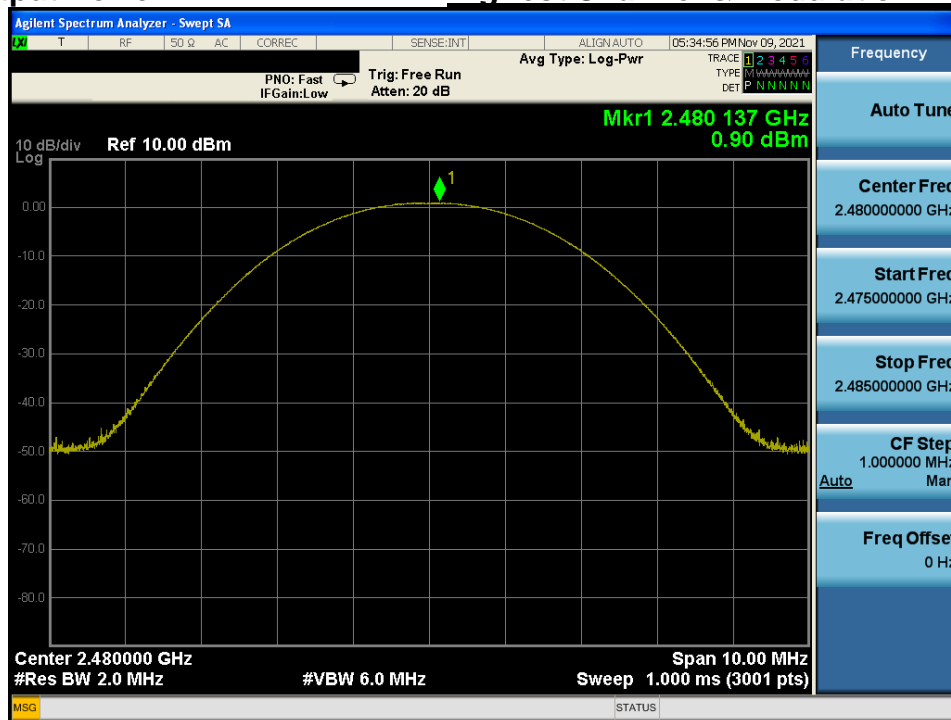

Peak Output Power

Lowest Channel & Modulation : 8DPSK

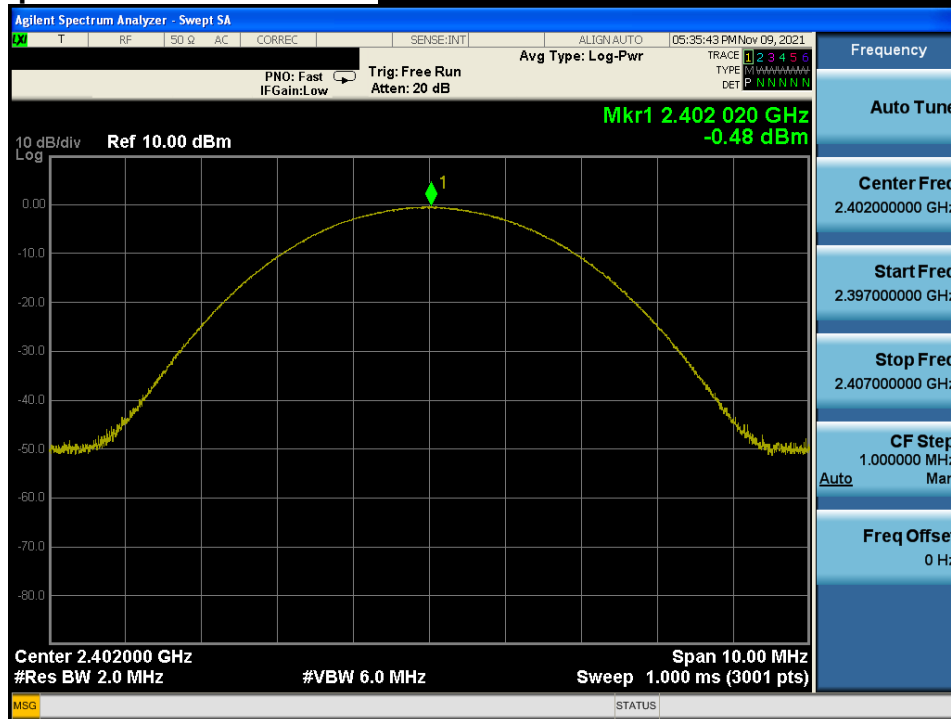

Peak Output Power

Middle Channel & Modulation : 8DPSK

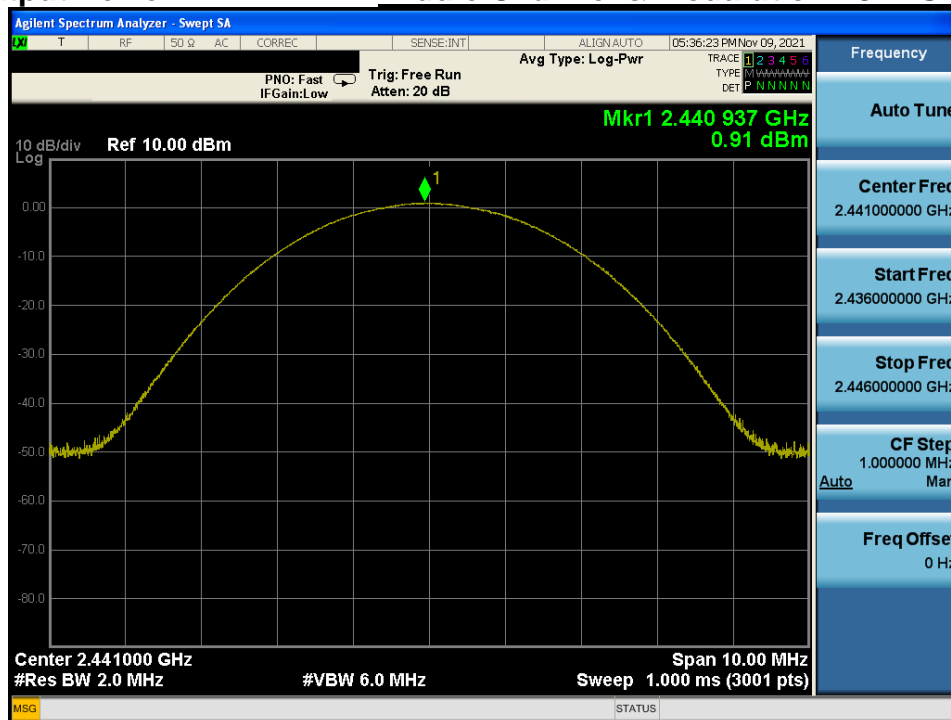

Peak Output Power

Highest Channel & Modulation : 8DPSK

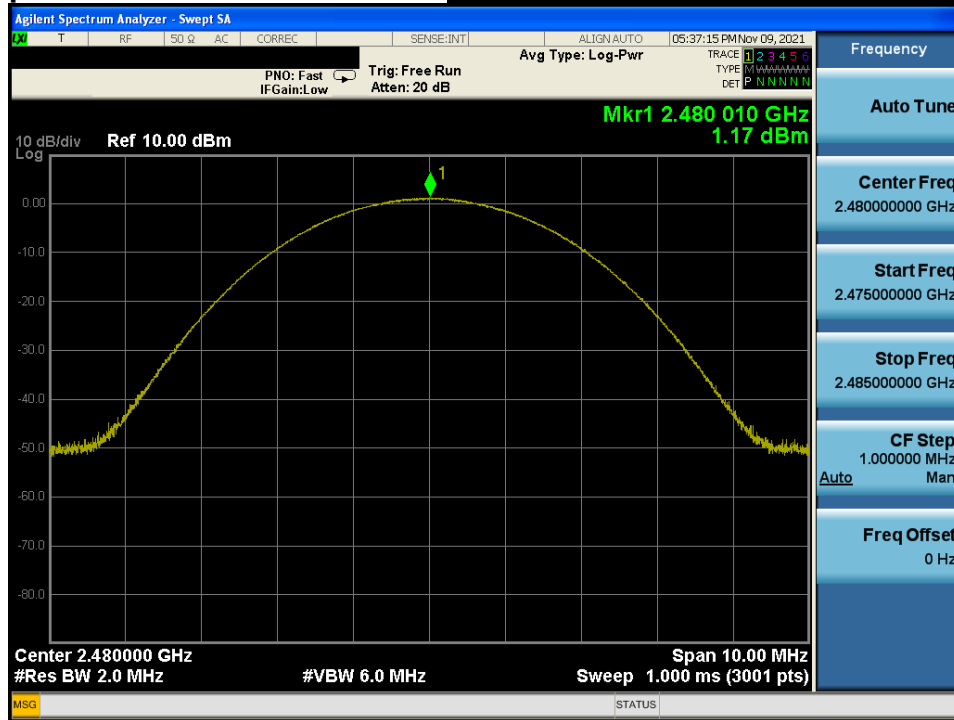

5. 20 dB BW

5.1. Test Setup

Refer to the APPENDIX I.

5.2. Limit

Limit : Not Applicable

5.3. Test Procedure

1. The 20 dB bandwidth was measured with a spectrum analyzer connected to RF antenna Connector (conducted measurement) while EUT was operating in transmit mode. The analyzer center frequency was set to the EUT carrier frequency, using the analyzer.
2. The bandwidth of the fundamental frequency was measured with the spectrum analyzer using below setting:
 - RBW = 1 % to 5 % of the 20 dB BW
 - VBW $\geq 3 \times$ RBW
 - Span = between two times and five times the 20 dB bandwidth
 - Sweep = auto
 - Detector function = peak
 - Trace = max hold

5.4. Test Results

Modulation	Tested Channel	20 dB BW (MHz)
<u>GFSK</u>	Lowest	0.955
	Middle	0.955
	Highest	0.955
<u>$\pi/4$DQPSK</u>	Lowest	1.331
	Middle	1.344
	Highest	1.345
<u>8DPSK</u>	Lowest	1.345
	Middle	1.344
	Highest	1.345

20 dB BW

Lowest Channel & Modulation : GFSK

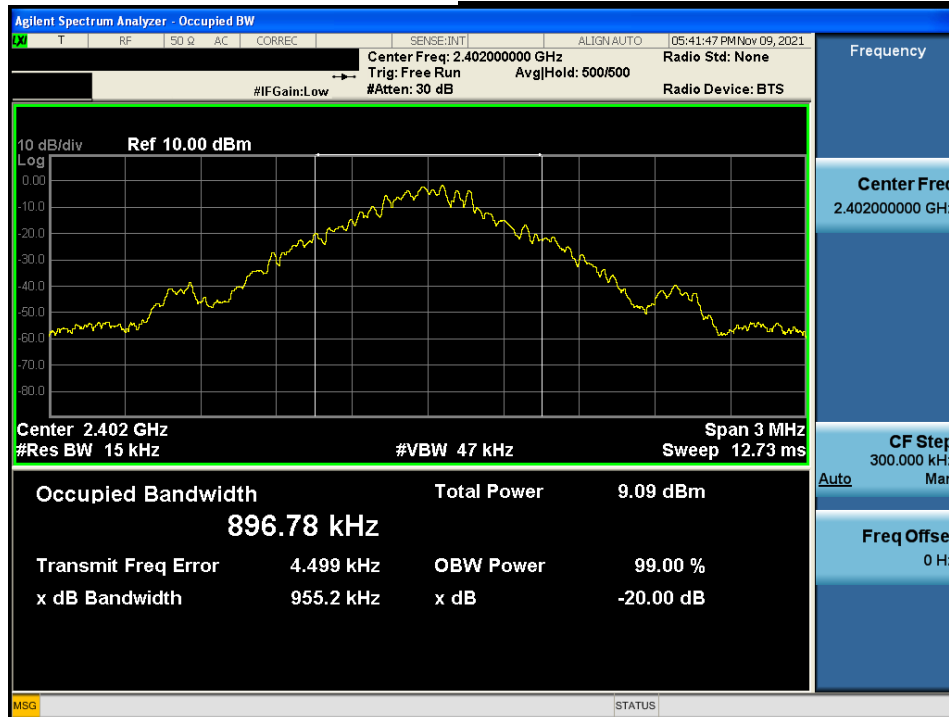

20 dB BW

Middle Channel & Modulation : GFSK

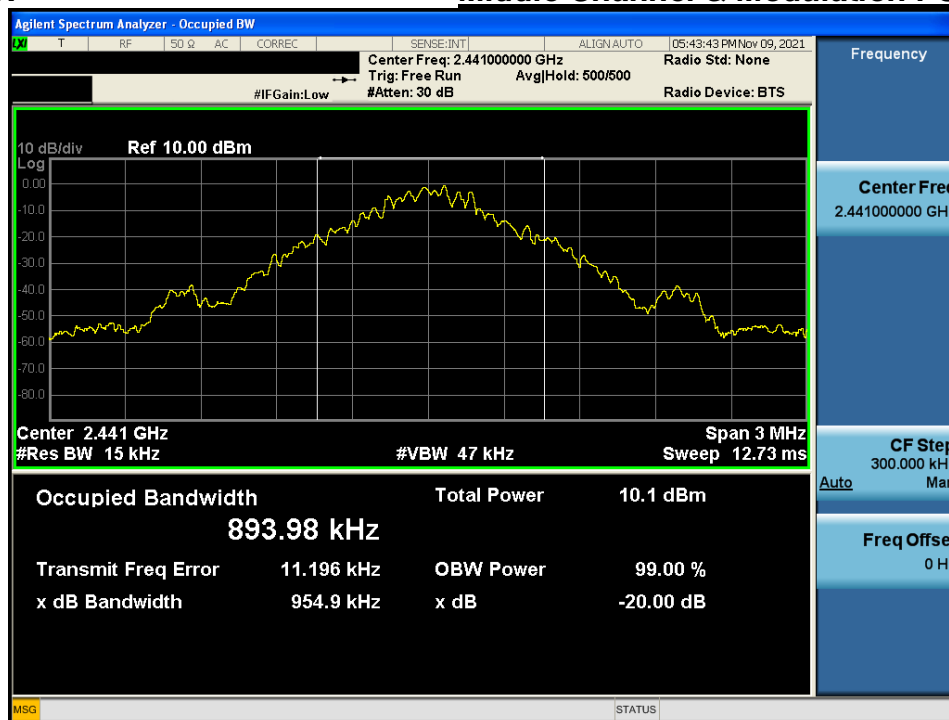

20 dB BW

Highest Channel & Modulation : GFSK

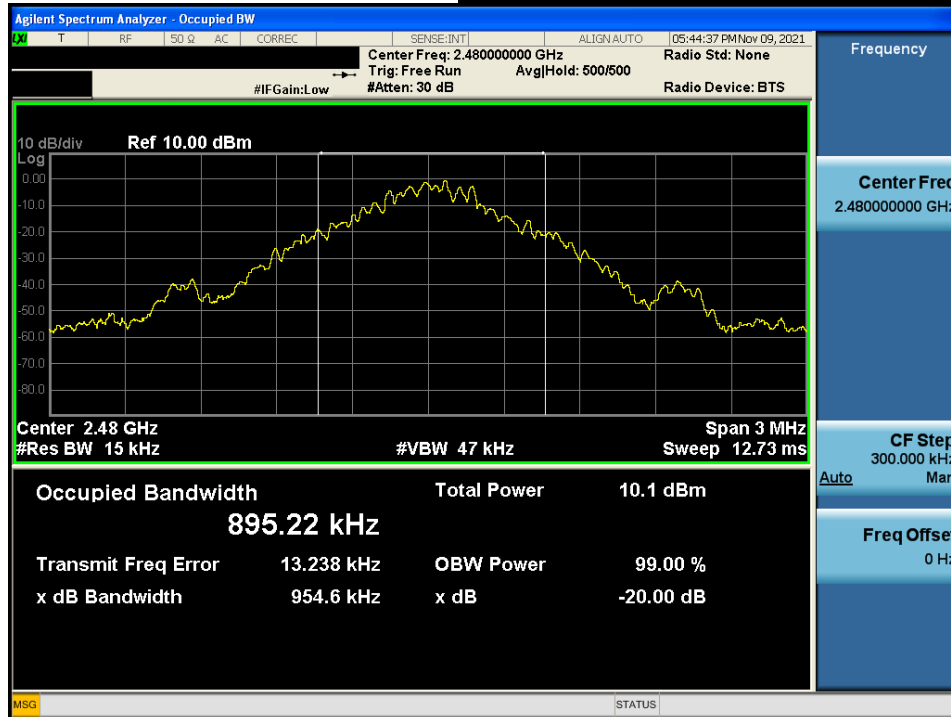

20 dB BW

Lowest Channel & Modulation : $\pi/4$ DQPSK

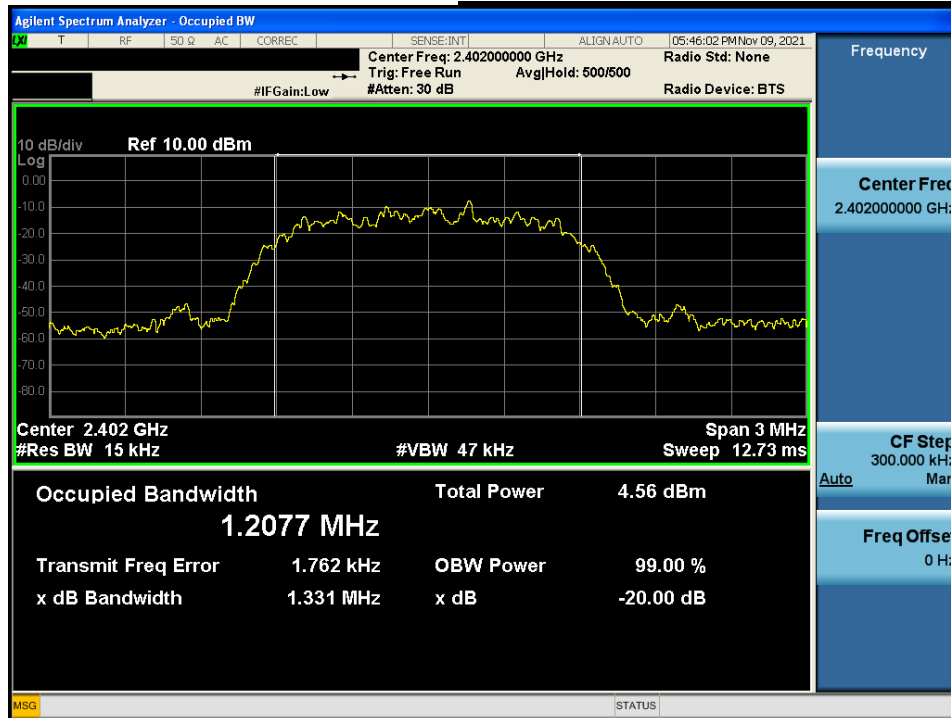

20 dB BW

Middle Channel & Modulation : $\pi/4$ DQPSK

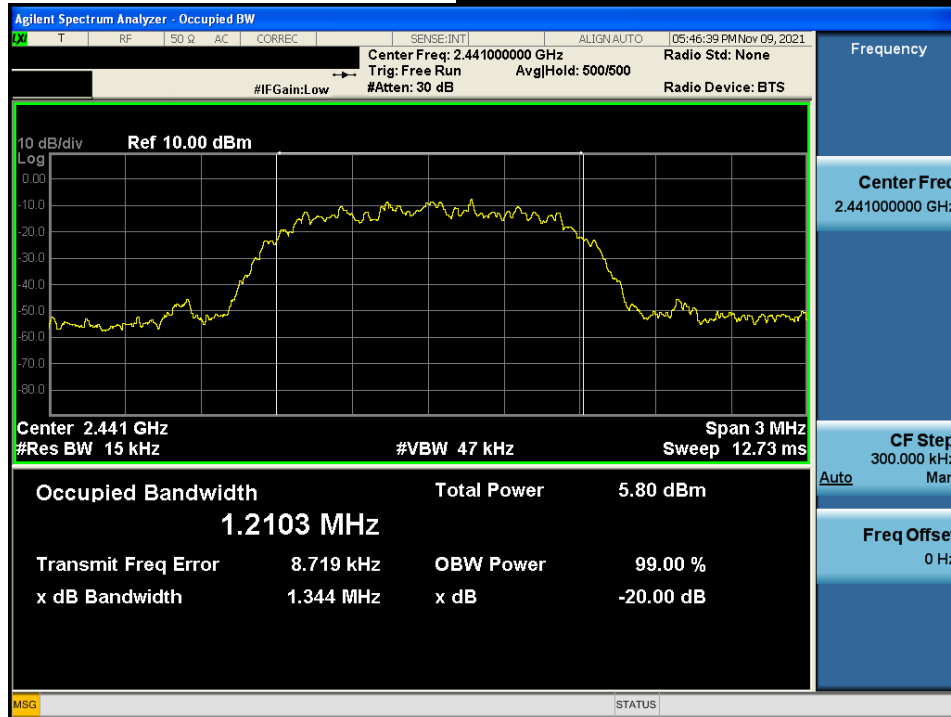

20 dB BW

Highest Channel & Modulation : $\pi/4$ DQPSK

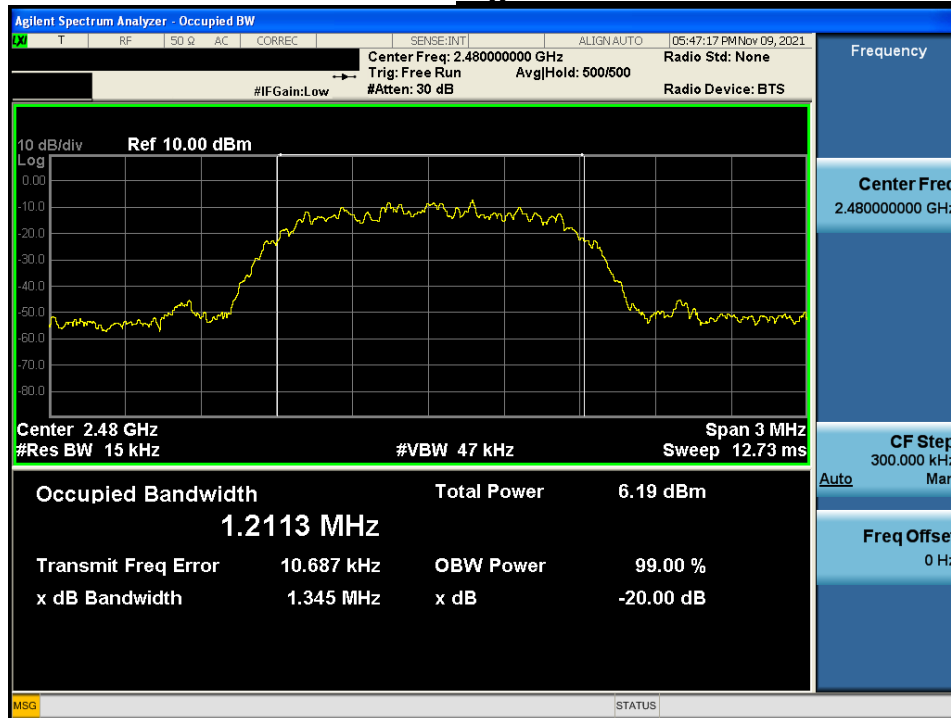

20 dB BW

Lowest Channel & Modulation : 8DPSK

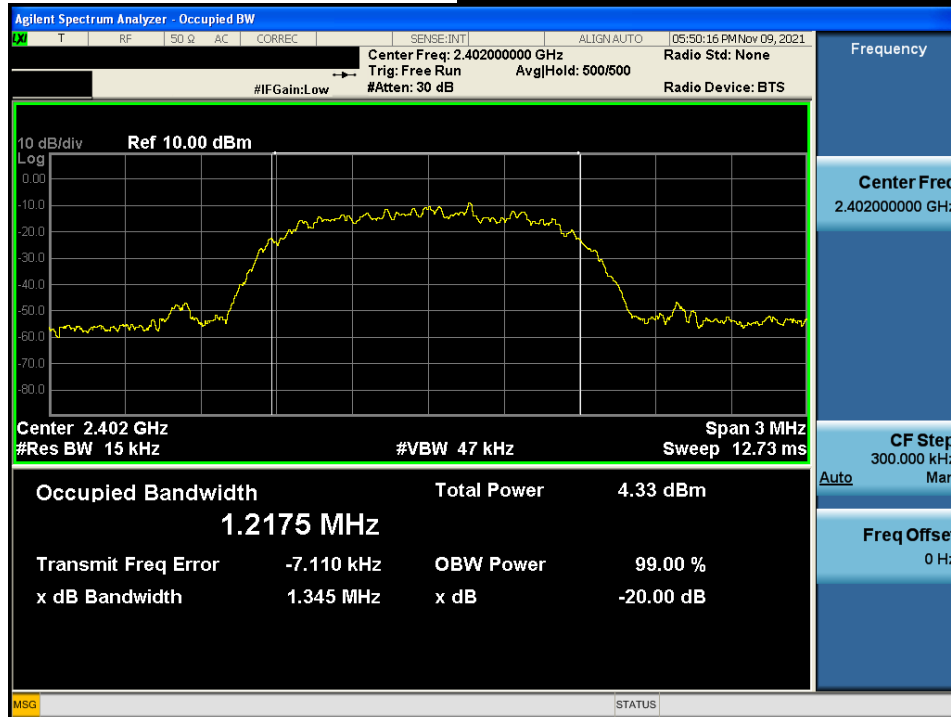

20 dB BW

Middle Channel & Modulation : 8DPSK

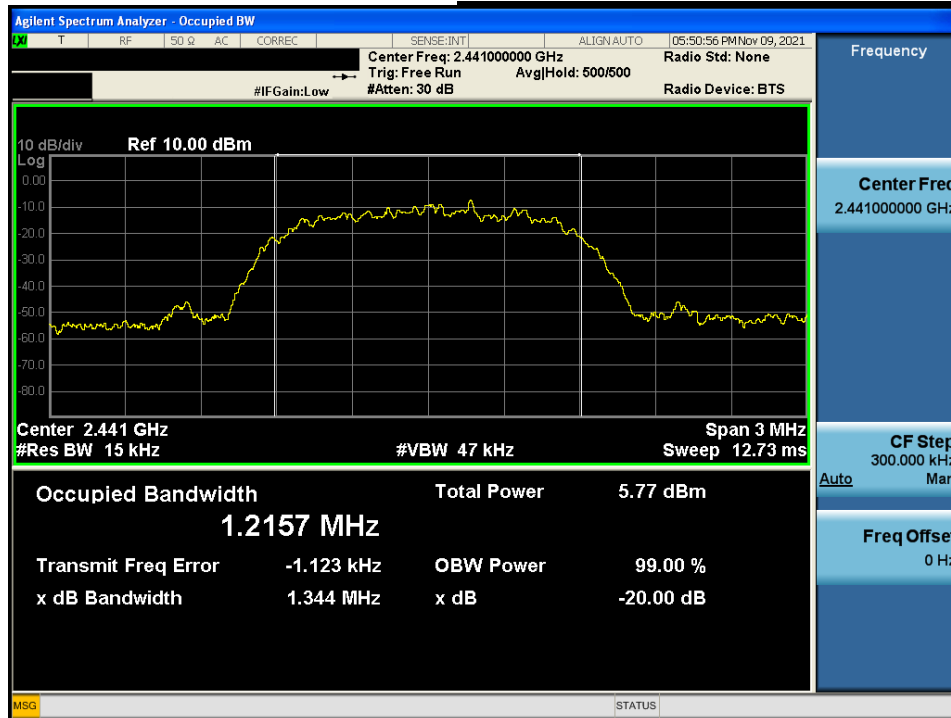

20 dB BW

Highest Channel & Modulation : 8DPSK

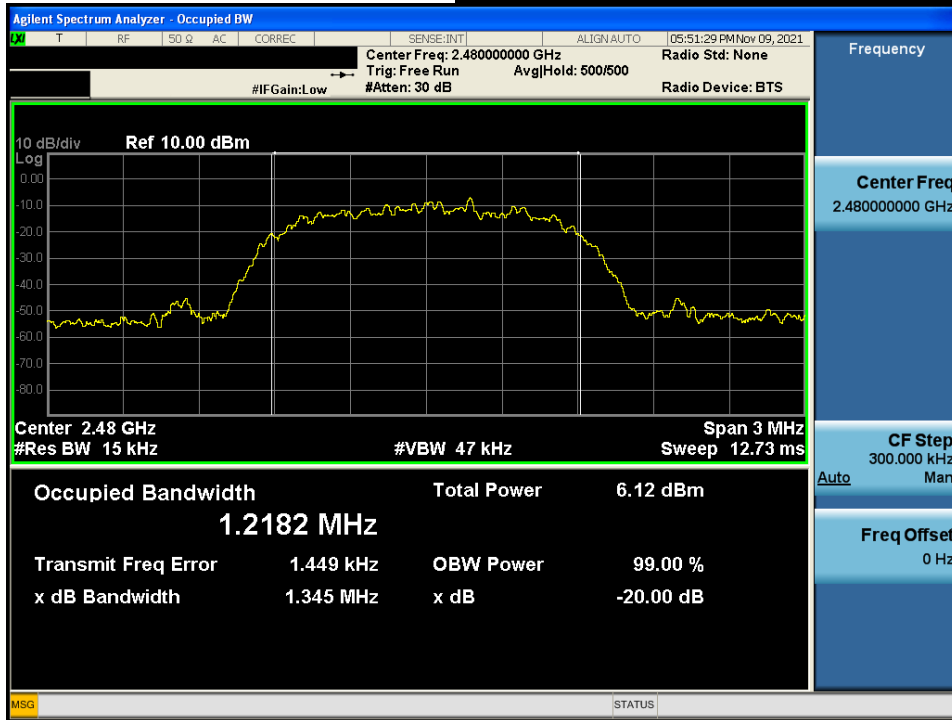

6. Carrier Frequency Separation

6.1. Test Setup

Refer to the APPENDIX I.

6.2. Limit

Limit : ≥ 25 kHz or \geq Two-Thirds of the 20 dB BW whichever is greater.

6.3. Test Procedure

The carrier frequency separation was measured with a spectrum analyzer connected to the antenna terminal, while EUT had its hopping function enabled.

After the trace being stable, the reading value between the peaks of the adjacent channels using the marker-delta function was recorded as the measurement results.

The spectrum analyzer is set to :

Span = wide enough to capture the peaks of two adjacent channels

RBW = Start with the RBW set to approximately 30 % of the channel spacing; adjust as necessary to best identify the center of each individual channel.

VBW \geq RBW

Sweep = auto

Detector function = peak

Trace = max hold

6.4. Test Results

FH mode

Hopping Mode	Modulation	Peak of reference channel(MHz)	Peak of adjacent Channel(MHz)	Test Result (MHz)
Enable	GFSK	2 441.010	2 442.013	1.003
	$\pi/4$ DQPSK	2 441.026	2 442.011	0.985
	8DPSK	2 441.011	2 442.151	1.140

AFH mode

Hopping Mode	Modulation	Peak of reference channel(MHz)	Peak of adjacent Channel(MHz)	Test Result (MHz)
Enable	GFSK	2 441.009	2 442.165	1.156
	$\pi/4$ DQPSK	2 441.004	2 442.004	1.000
	8DPSK	2 441.019	2 442.161	1.142

Note 1 : See next pages for actual measured spectrum

Carrier Frequency Separation (FH) *Hopping mode : Enable&GFSK*



Carrier Frequency Separation (FH) *Hopping mode : Enable& $\pi/4$ QPSK*

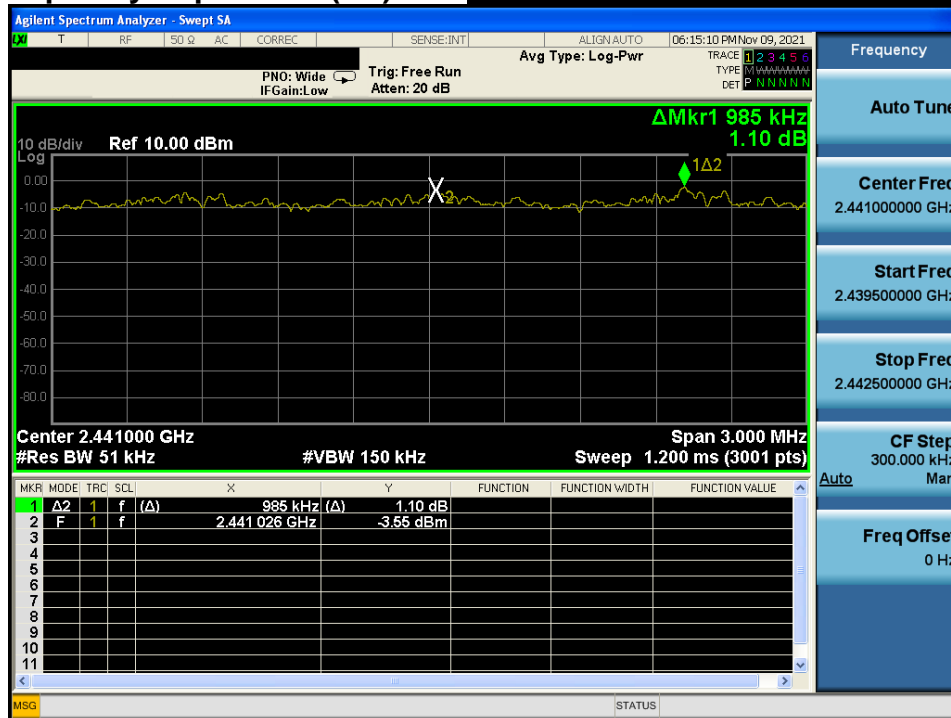

Carrier Frequency Separation (FH) *Hopping mode : Enable&8DPSK*

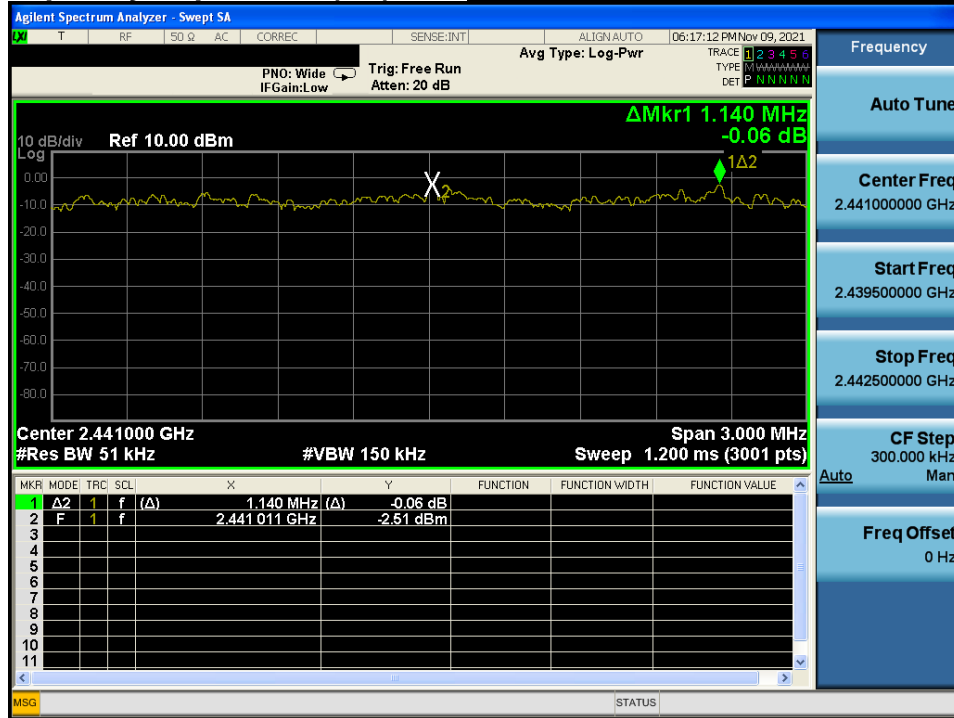

Carrier Frequency Separation (AFH) *Hopping mode : Enable&GFSK*



Carrier Frequency Separation (AFH) *Hopping mode : Enable& π /4DQPSK*

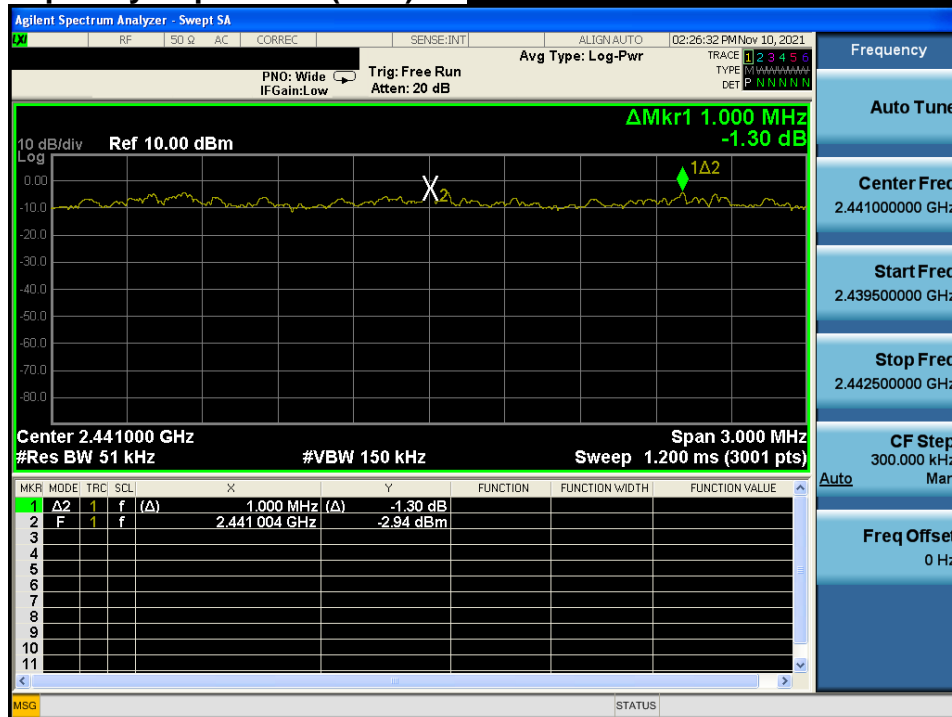

Carrier Frequency Separation (AFH) *Hopping mode : Enable&8DPSK*

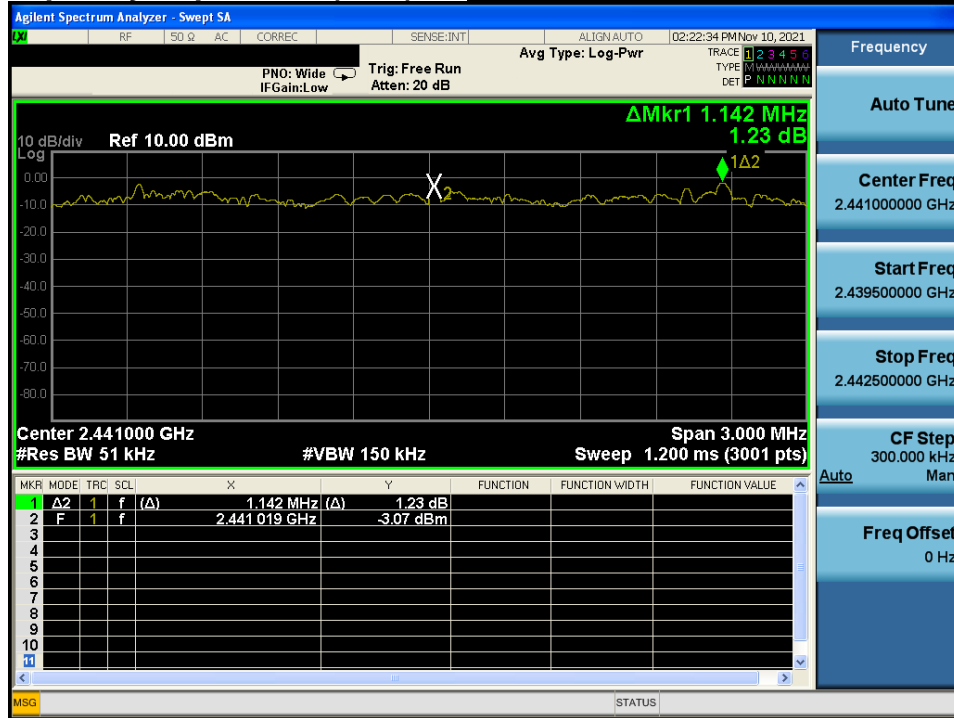

7. Number of Hopping Channels

7.1. Test Setup

Refer to the APPENDIX I.

7.2. Limit

Limit : ≥ 15 hops

7.3. Test Procedure

The number of hopping frequencies was measured with a spectrum analyzer connected to the antenna terminal, while EUT had its hopping function enabled.

To get higher resolution, two frequency ranges for FH mode within the 2 400 MHz ~ 2 483.5 MHz were examined.

The spectrum analyzer is set to :

Span for FH mode = 50 MHz Start Frequency = 2 391.5 MHz, Stop Frequency = 2 441.5 MHz

Start Frequency = 2 441.5 MHz, Stop Frequency = 2 491.5 MHz

Span for AFH mode = 30 MHz Start Frequency = 2 426.0 MHz, Stop Frequency = 2 456.0 MHz

RBW = To identify clearly the individual channels, set the RBW to less than 30 % of the channel spacing or the 20 dB bandwidth, whichever is smaller.

VBW \geq RBW

Sweep = auto

Detector function = peak

Trace = max hold

7.4. Test Results

FH mode

Hopping mode	Modulation	Test Result (Total Hops)
Enable	GFSK	79
	$\pi/4$ DQPSK	79
	8DPSK	79

AFH mode

Hopping mode	Modulation	Test Result (Total Hops)
Enable	GFSK	20
	$\pi/4$ DQPSK	20
	8DPSK	20

Note 1 : See next pages for actual measured spectrum plots.

Number of Hopping Channels 1(FH)

Hopping mode : Enable & GFSK

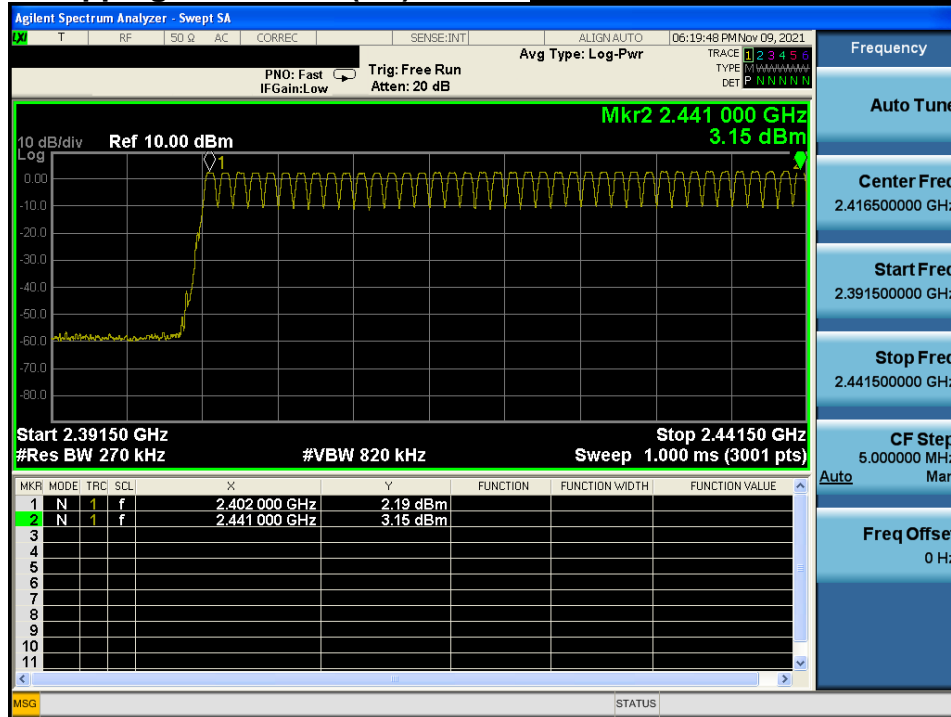

Number of Hopping Channels 2(FH)

Hopping mode : Enable & GFSK

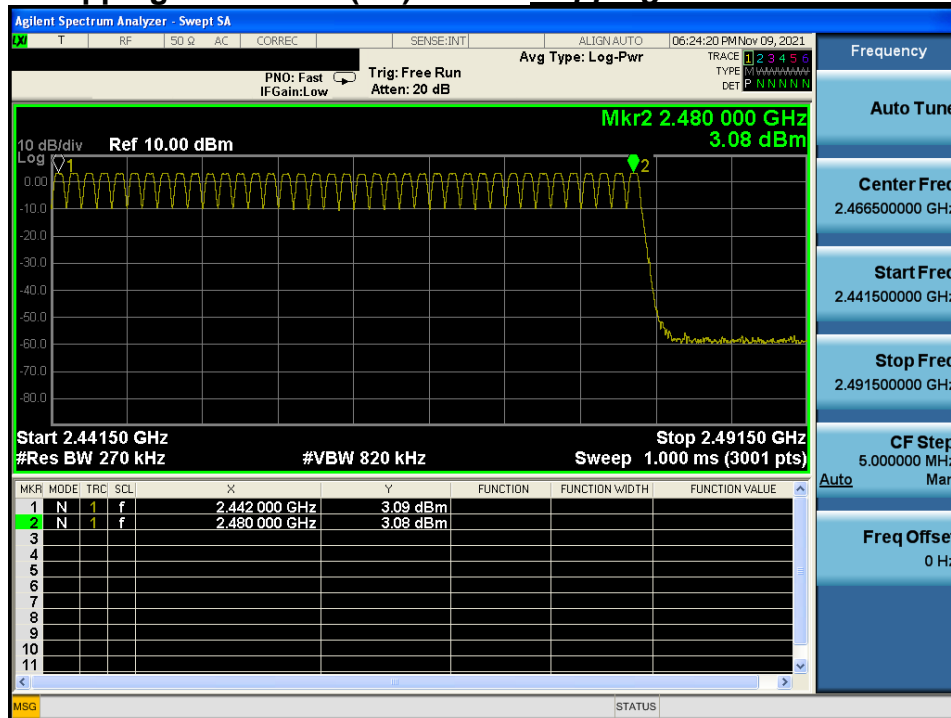

Number of Hopping Channels 1(FH)

Hopping mode : Enable & $\pi/4$ DQPSK

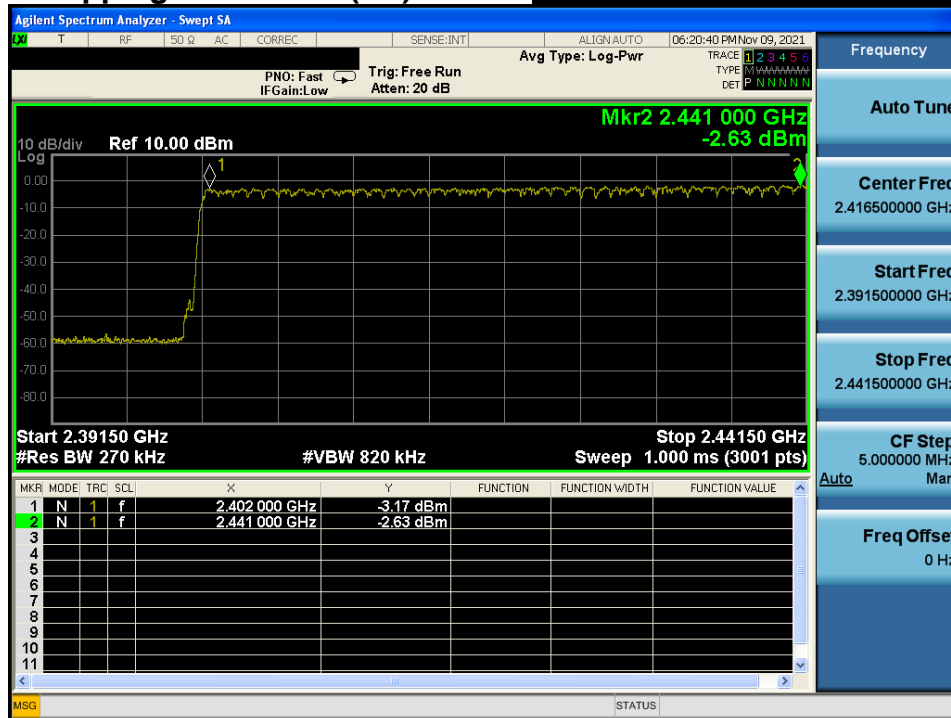

Number of Hopping Channels 2(FH)

Hopping mode : Enable & $\pi/4$ DQPSK

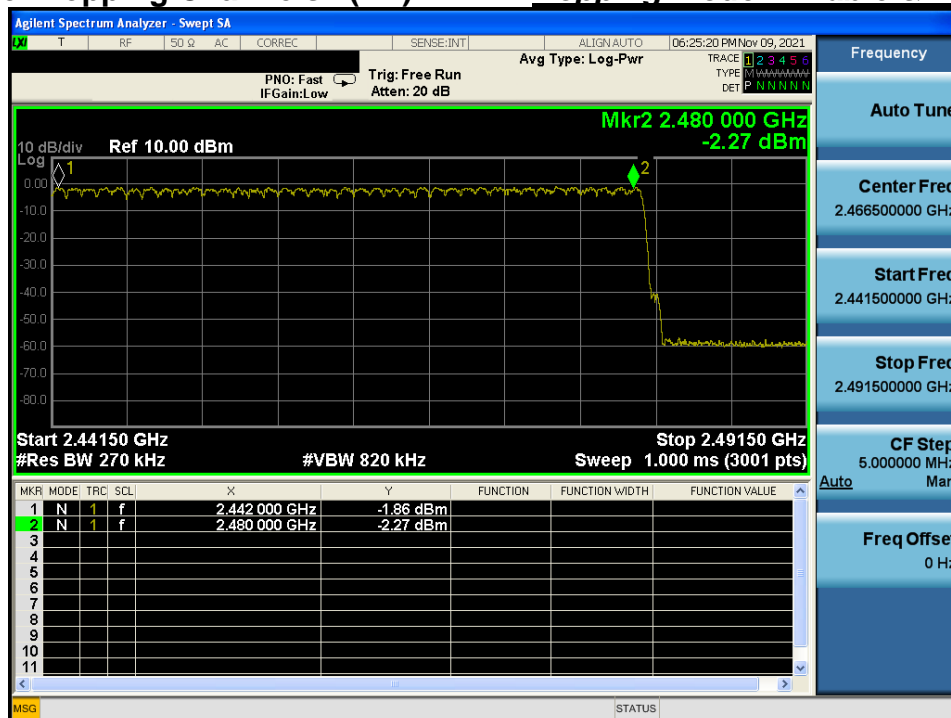

Number of Hopping Channels 1(FH) Hopping mode : Enable&8DPSK

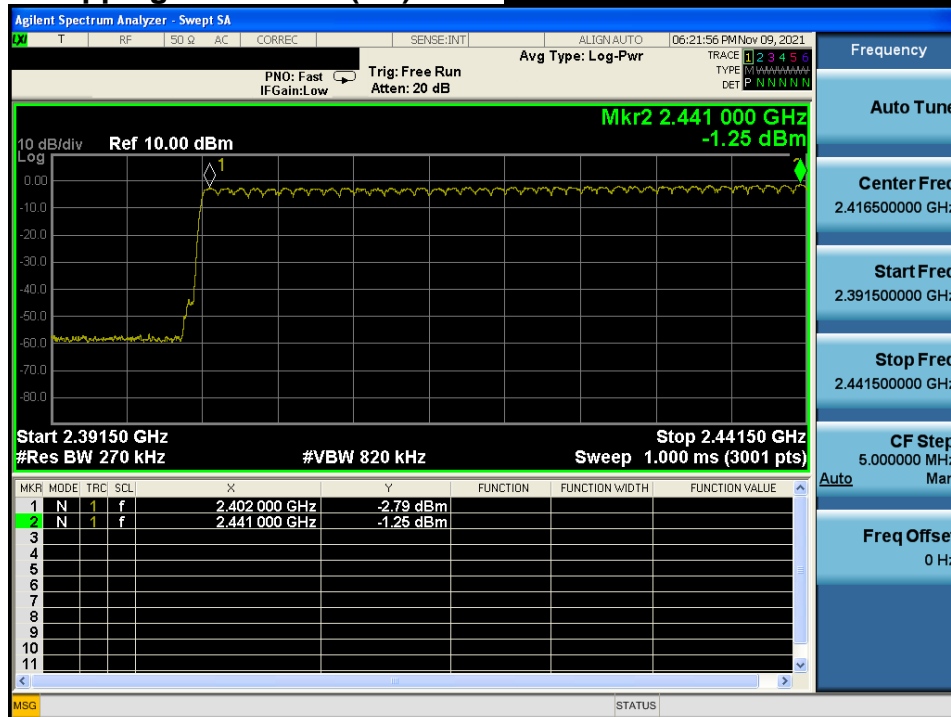

Number of Hopping Channels 2(FH) Hopping mode : Enable & 8DPSK

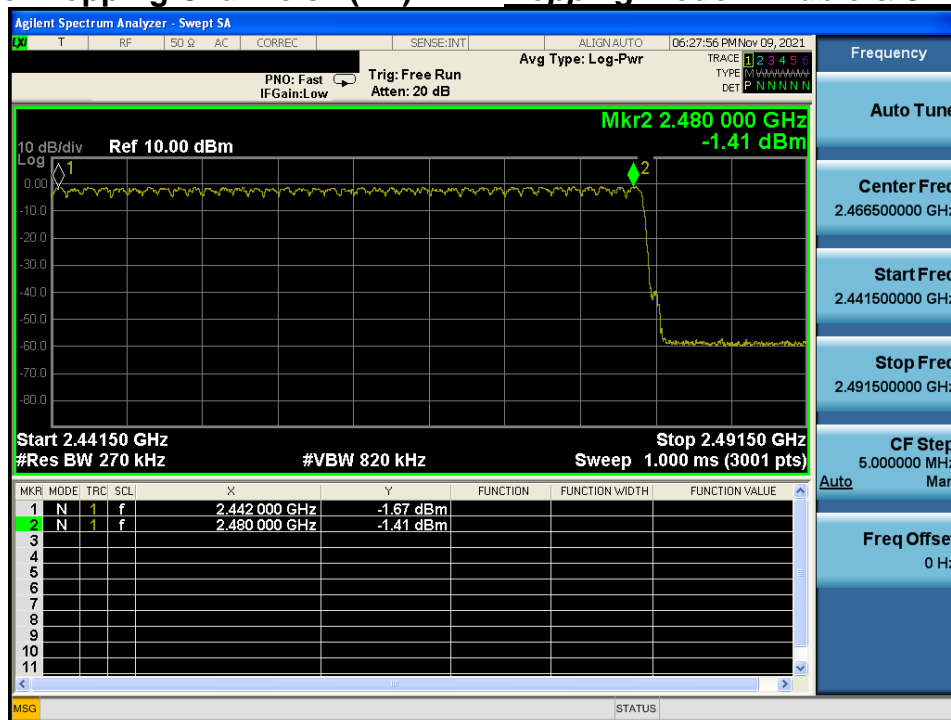

Number of Hopping Channels 1(AFH) *Hopping mode : Enable &GFSK*

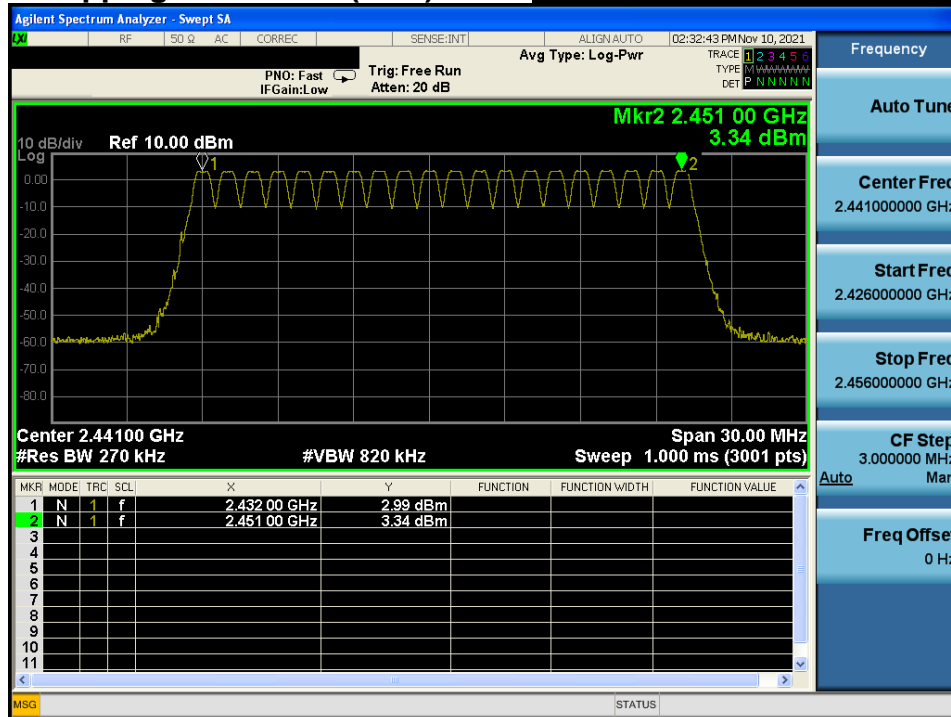

Number of Hopping Channels 1(AFH) *Hopping mode : Enable & $\pi/4$ DQPSK*

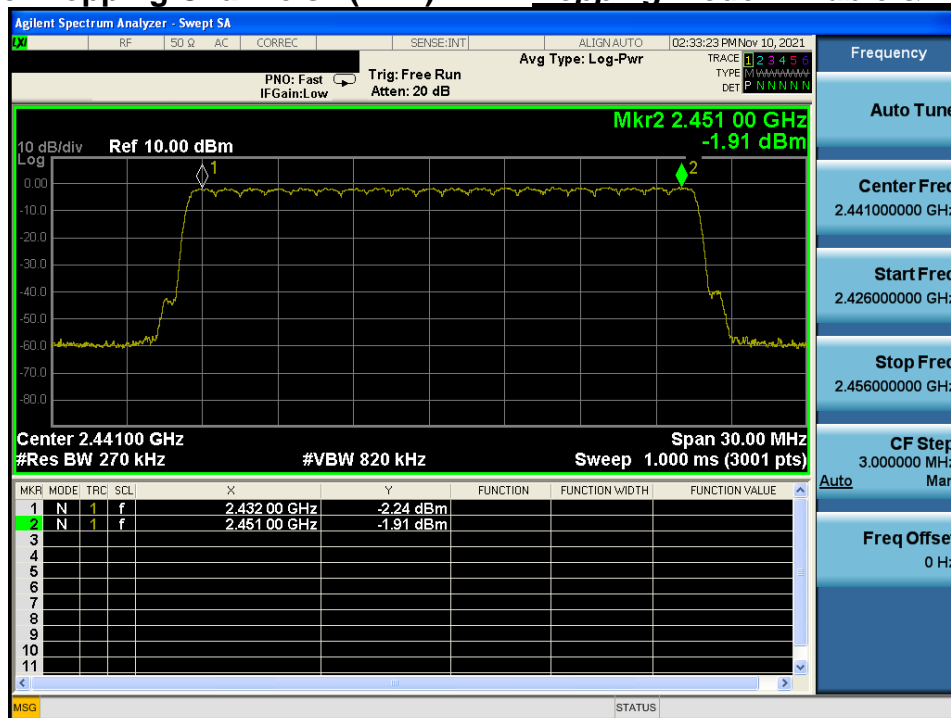

Number of Hopping Channels 1(AFH) *Hopping mode : Enable & 8DPSK*

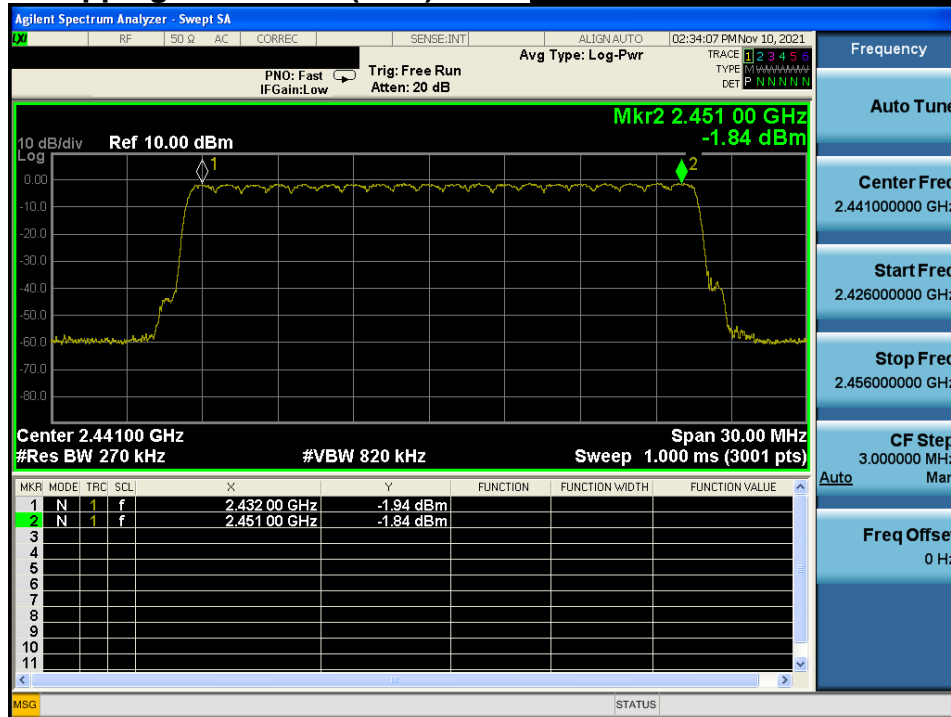

8. Time of Occupancy

8.1. Test Setup

Refer to the APPENDIX I.

8.2. Limit

The maximum permissible time of occupancy is 400 ms within a period of 400 ms multiplied by the number of hopping channels employed.

8.3. Test Procedure

The dwell time was measured with a spectrum analyzer connected to the antenna terminal, while EUT had its hopping function enabled.

The spectrum analyzer is set to :

Center frequency = 2 441 MHz

Span = zero

RBW = 1 MHz (RBW shall be \leq channel spacing and where possible RBW should be set $\gg 1 / T$, where T is the expected dwell time per channel)

VBW \geq RBW

Detector function = peak

Trace = max hold

8.4. Test Results

FH mode

Hopping mode	Packet Type	Number of hopping Channels	Burst On Time (ms)	Period (ms)	Test Result (sec)
Enable	DH 5	79	2.880	3.750	0.307
	2 DH 5	79	2.880	3.750	0.307
	3 DH 5	79	2.880	3.750	0.307

AFH mode

Hopping mode	Packet Type	Number of hopping Channels	Burst On Time (ms)	Period (ms)	Test Result (sec)
Enable	DH 5	20	2.880	3.750	0.154
	2 DH 5	20	2.880	3.750	0.154
	3 DH 5	20	2.880	3.750	0.154

Note 1 : Dwell Time = $0.4 \times \text{Hopping channel} \times \text{Burst ON time} \times$
 $((\text{Hopping rate} \div \text{Time slots}) \div \text{Hopping channel})$

- Time slots for DH5 = 6 slots (TX = 5 slots / RX = 1 slot)
- Hopping Rate = 1 600 for FH mode & 800 for AFH mode

Note 2 : See next pages for actual measured spectrum plots.

Time of Occupancy (FH)

Hopping mode : Enable&DH5

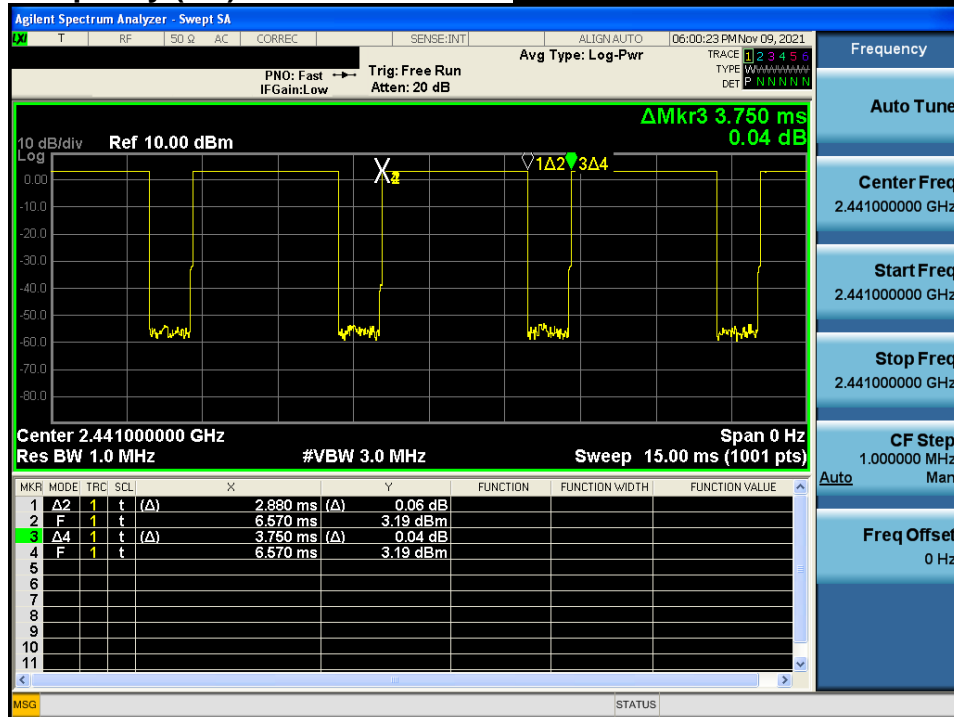

Time of Occupancy (FH)

Hopping mode : Enable&2-DH5

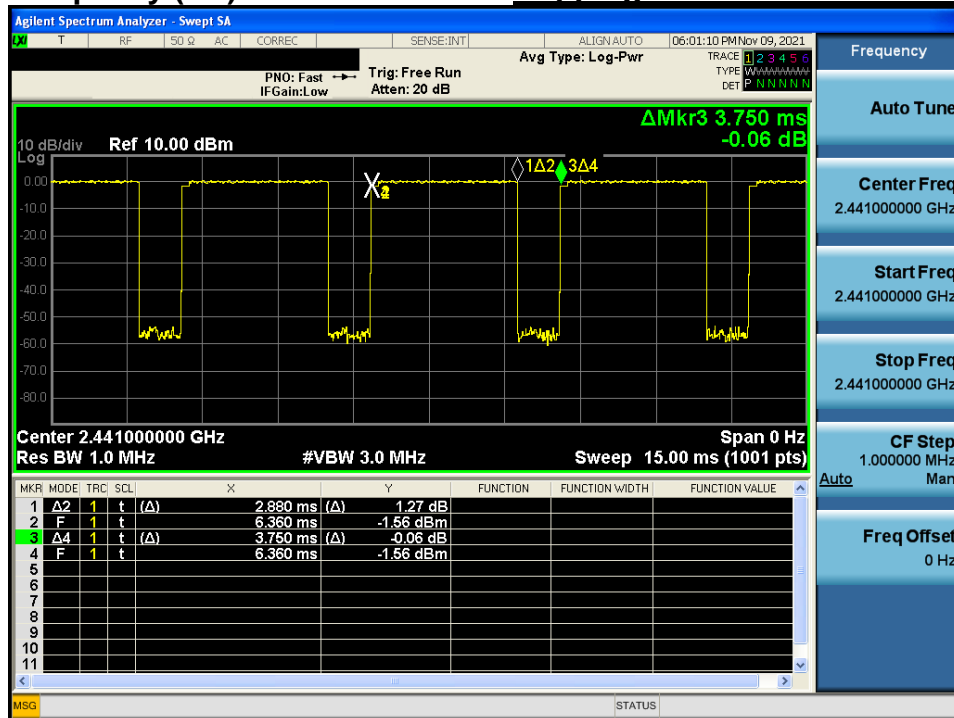

Time of Occupancy (FH)

Hopping mode : Enable&3-DH5

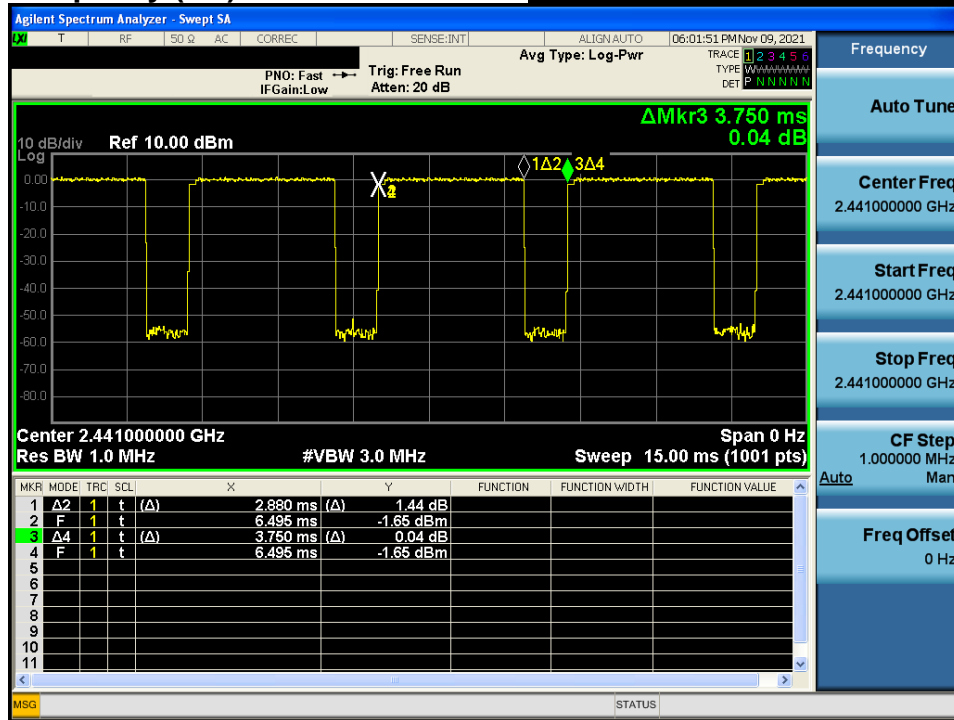

Time of Occupancy (AFH)

Hopping mode : Enable&DH5

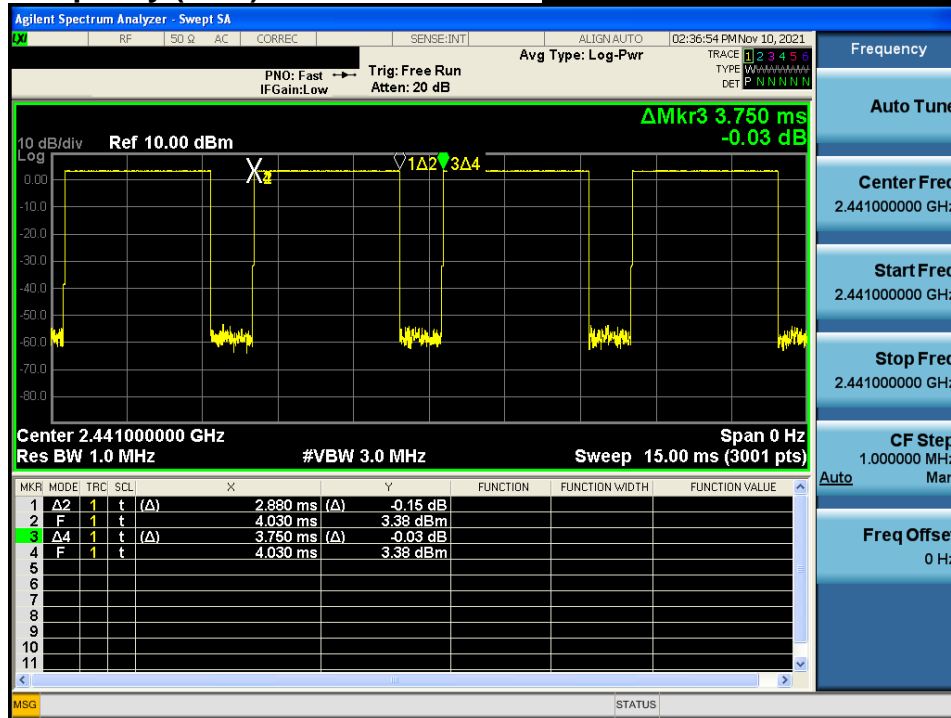

Time of Occupancy (AFH)

Hopping mode : Enable&2-DH5

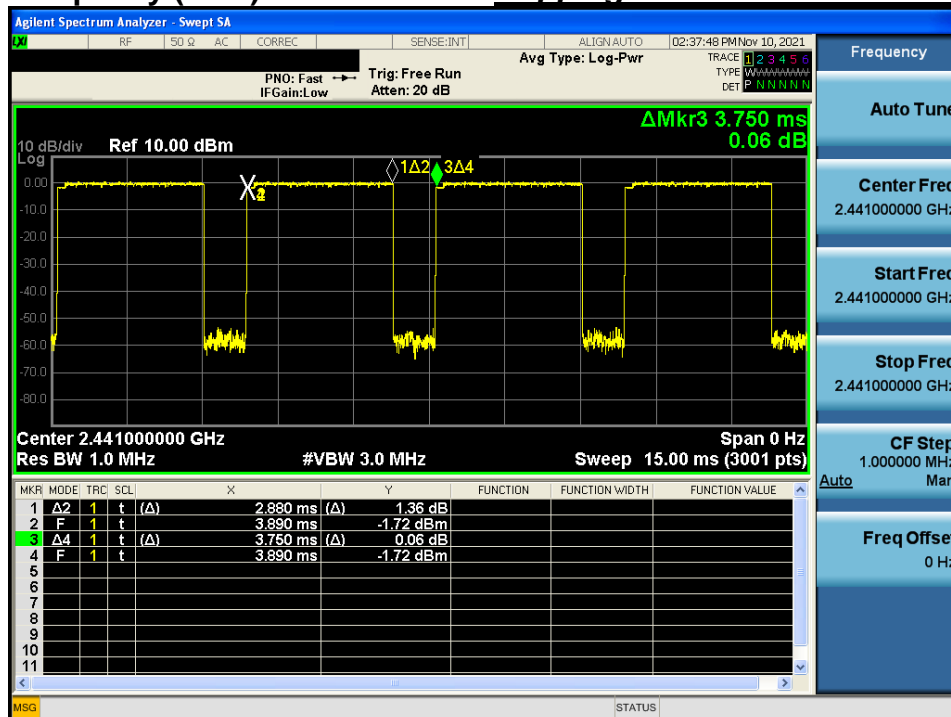

Time of Occupancy (AFH)

Hopping mode : Enable&3-DH5

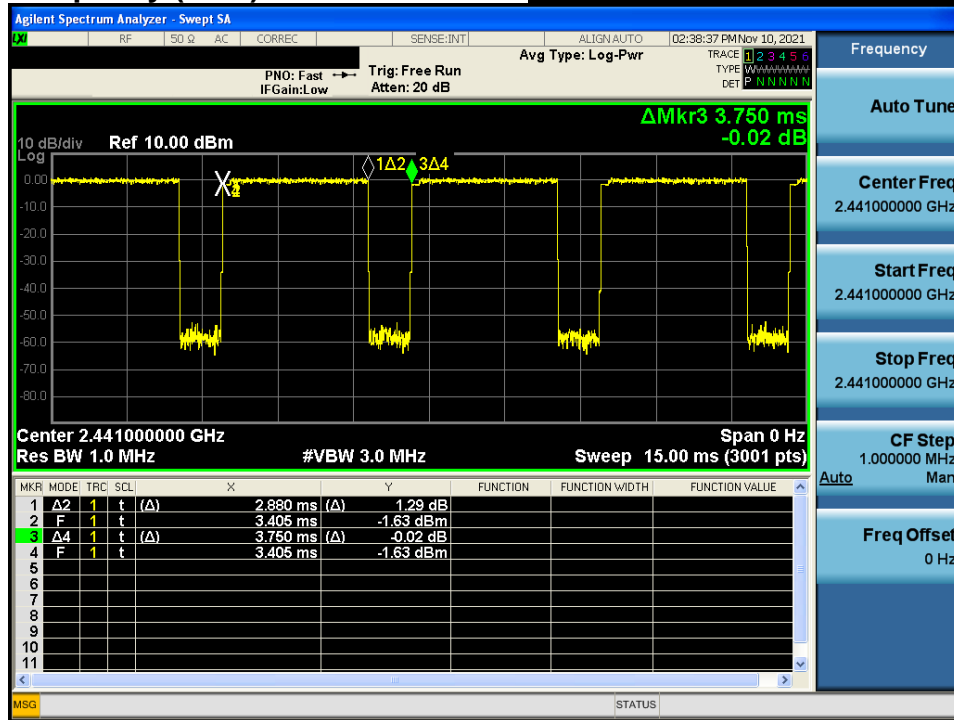

9. Unwanted Emissions

9.1. Test Setup

Refer to the APPENDIX I.

9.2. Limit

Part 15.247(d), Part 15.205, Part 15.209

In any 100 kHz bandwidth outside the frequency band in which the spread spectrum or digitally modulated intentional radiator is operating, the radio frequency power that is produced by the intentional radiator shall be at least 20 dB below that in the 100 kHz bandwidth within the band that contains the highest level of the desired power, based on either an RF conducted or a radiated measurement, provided the transmitter demonstrates compliance with the peak conducted power limits. If the transmitter complies with the conducted power limits based on the use of RMS averaging over a time interval, as permitted under paragraph (b)(3) of Part 15.247 the attenuation required under this paragraph shall be 30 dB instead of 20 dB. Attenuation below the general limits specified in §15.209(a) is not required. In addition, radiated emissions which fall in the restricted bands, as defined in §15.205(a), must also comply with the radiated emission limits specified in §15.209(a) (see §15.205(c)).

- Part 15.209: General requirement

Frequency (MHz)	FCC Limit (uV/m)	Measurement Distance (m)
0.009 – 0.490	2 400 / F (kHz)	300
0.490 – 1.705	2 4000 / F (kHz)	30
1.705 – 30.0	30	30

Frequency (MHz)	FCC Limit (uV/m)	Measurement Distance (m)
30 ~ 88	100 **	3
88 ~ 216	150 **	3
216 ~ 960	200 **	3
Above 960	500	3

**Except as provided in paragraph (g), fundamental emissions from intentional radiators operating under this section shall not be located in the frequency bands 54-72 MHz, 76-88 MHz, 174-216 MHz or 470-806 MHz. However, operation within these frequency bands is permitted under other sections of this part, e.g., §§15.231 and 15.241.

- Part 15.205(a): Restricted band of operation

MHz	MHz	MHz	MHz	GHz	GHz
0.009 ~ 0.110	8.414 25 ~ 8.414 75	108 ~ 121.94	1 300 ~ 1 427	4.5 ~ 5.15	14.47 ~ 14.5
0.495 ~ 0.505	12.29 ~ 12.293	123 ~ 138	1 435 ~ 1 626.5	5.35 ~ 5.46	15.35 ~ 16.2
2.173 5 ~ 2.190 5	12.519 75 ~ 12.520 25	149.9 ~ 150.05	1 645.5 ~ 1 646.5	7.25 ~ 7.75	17.7 ~ 21.4
4.125 ~ 4.128	12.576 75 ~ 12.577 25	156.524 75 ~ 156.525 25	1 660 ~ 1 710	8.025 ~ 8.5	22.01 ~ 23.12
4.177 25 ~ 4.177 75	13.36 ~ 13.41	156.7 ~ 156.9	1 718.8 ~ 1 722.2	9.0 ~ 9.2	23.6 ~ 24.0
4.207 25 ~ 4.207 75	16.42 ~ 16.423	162.012 5 ~ 167.17	2 200 ~ 2 300	9.3 ~ 9.5	31.2 ~ 31.8
6.215 ~ 6.218	16.694 75 ~ 16.695 25	167.72 ~ 173.2	2 310 ~ 2 390	10.6 ~ 12.7	36.43 ~ 36.5
6.267 75 ~ 6.268 25	16.804 25 ~ 16.804 75	240 ~ 285	2 483.5 ~ 2 500	13.25 ~ 13.4	Above 38.6
6.311 75 ~ 6.312 25	25.5 ~ 25.67	322 ~ 335.4	2 655 ~ 2 900		
8.291 ~ 8.294	37.5 ~ 38.25	399.90 ~ 410	3 260 ~ 3 267		
8.362 ~ 8.366	73 ~ 74.6	608 ~ 614	3 332 ~ 3 339		
8.376 25 ~ 8.386 75	74.8 ~ 75.2	960 ~ 1 240	3 345.8 ~ 3 358		
			3 600 ~ 4 400		

9.3. Test Procedures

9.3.1. Test Procedures for Unwanted Emissions(Radiated)

1. The EUT is placed on a non-conductive table. For emission measurements at or below 1 GHz, the table height is 80 cm. For emission measurements above 1 GHz, the table height is 1.5 m.
The table was rotated 360 degrees to determine the position of the highest radiation.
2. During performing radiated emission below 1 GHz, the EUT was set 3 meters away from the interference receiving antenna, which was mounted on the top of a variable-height antenna tower. During performing radiated emission above 1 GHz, the EUT was set 1 or 3 meter away from the interference-receiving antenna.
3. For measurements above 1 GHz absorbers are placed on the floor between the turn table and the antenna mast in such a way so as to maximize the reduction of reflections. For measurements below 1 GHz, the absorbers are removed.
4. The antenna is a broadband antenna, and its height is varied from one meter to four meters above the ground to determine the maximum value of the field strength. Both horizontal and vertical polarizations of the antenna are set to make the measurement.
5. For each suspected emission, the EUT was arranged to its worst case and then the antenna was tuned to heights from 1 meter to 4 meters and the table was turned from 0 degrees to 360 degrees to find the maximum reading.
6. The test-receiver system was set to Peak Detect Function and Specified Bandwidth with Maximum Hold Mode.
7. If the emission level of the EUT in peak mode was 10 dB lower than the limit specified, then testing could be stopped and the peak values of the EUT would be reported. Otherwise the emissions that did not have 10 dB margin would be re-tested one by one using peak, quasi-peak or average method as specified and then reported in a data sheet.

Measurement Instrument Setting

- Frequencies less than or equal to 1 000 MHz
The resolution bandwidth and video bandwidth of test receiver/spectrum analyzer is 120 kHz for Quasi-peak detection (QP) at frequency below 1 GHz.
- Frequencies above 1 000 MHz
The resolution bandwidth and video bandwidth of test receiver/spectrum analyzer is 1 MHz for Peak detection and frequency above 1 GHz.
The result of Average measurement is calculated using PK result and duty correction factor.

9.3.2. Test Procedures for Unwanted Emissions(Conducted)

1. The transmitter output was connected to the spectrum analyzer.
2. The **reference level** of the fundamental frequency was measured with the spectrum analyzer using RBW = 100 kHz, VBW = 300 kHz.
3. The conducted spurious emission was tested each ranges were set as below.

Frequency range : 9 kHz ~ 30 MHz

RBW = 100 kHz, VBW = 300 kHz, SWEEP TIME = AUTO, DETECTOR = PEAK, TRACE = MAX HOLD, SWEEP POINT : 40 001

Frequency range : 30 MHz ~ 10 GHz, 10 GHz ~ 25 GHz

RBW = 1 MHz, VBW = 3 MHz, SWEEP TIME = AUTO, DETECTOR = PEAK, TRACE = MAX HOLD, SWEEP POINT : 40 001

LIMIT LINE = 20 dB below of the reference level of above measurement procedure Step 2. (RBW = 100 kHz, VBW = 300 kHz)

If the emission level with above setting was close to the limit (ie, less than 3 dB margin) then zoom scan is required using RBW = 100 kHz, VBW = 300 kHz, SPAN = 100 MHz and BINS = 2 001 to get accurate emission level within 100 kHz BW.

Also the path loss for conducted measurement setup was used as described on the Appendix I of this test report.

9.4. Test Results

9.4.1. Unwanted Emissions(Radiated)

▪ Test Notes.

- The radiated emissions were investigated 1 GHz to 25 GHz. And no other spurious and harmonic emissions were found below listed frequencies.
- Information of Distance Correction Factor
 For finding emissions, measurements may be performed at a distance closer than that specified in the regulations.
 In this case, the distance correction factor is applied to the result.
 - Calculation of distance factor
 At frequencies below 30 MHz = $40 \log(\text{tested distance} / \text{specified distance})$
 At frequencies at or above 30 MHz = $20 \log(\text{tested distance} / \text{specified distance})$
 When distance factor is "N/A", the measurements were performed at the specified distance and distance factor is not applied.
- DCCF Calculation. (DCCF = Duty Cycle Correction Factor)
 - Time to cycle through all channels = $\Delta t = T [\text{ms}] \times 20$ minimum hopping channels, where T = pulse width = **2.88 ms**
 - $100 \text{ ms} / \Delta t [\text{ms}] = H \rightarrow$ Round up to next highest integer, to account for worst case, $H' = 100 / (2.88 \times 20) = 1.74 \approx 2$
 - The Worst Case Dwell Time = $T [\text{ms}] \times H' = 2.88 \text{ ms} \times 2 = 5.76 \text{ ms}$
 - DCCF = $20 \log(\text{The Worst Case Dwell Time} / 100 \text{ ms}) \text{ dB} = 20 \log(5.76 / 100) = -24.79 \text{ dB}$
- Sample Calculation.
 $\text{Margin} = \text{Limit} - \text{Result} / \text{Result} = \text{Reading} + \text{TF} + \text{DCCF} + \text{DCF} / \text{TF} = \text{AF} + \text{CL} + \text{HL} + \text{AL} - \text{AG}$
 Where, TF = Total Factor, AF = Antenna Factor, CL = Cable Loss, AG = Amplifier Gain, HL = High pass filter Loss, AL = Attenuator Loss, DCCF = Duty Cycle Correction Factor, DCF = Distance Correction Factor

9 kHz ~ 25 GHz Data (Modulation : GFSK)

▪ Lowest Channel

Frequency (MHz)	ANT Pol	EUT Position (Axis)	Detector Mode	Reading (dBuV)	TF (dB/m)	DCCF (dB)	DCF (dB)	Result (dBuV/m)	Limit (dBuV/m)	Margin (dB)
2 382.01	H	X	PK	49.96	4.44	N/A	N/A	54.40	74.00	19.60
2 382.01	H	X	AV	49.96	4.44	-24.79	N/A	29.61	54.00	24.39
4 803.14	H	X	PK	49.36	2.40	N/A	N/A	51.76	74.00	22.24
4 803.14	H	X	AV	49.36	2.40	-24.79	N/A	26.97	54.00	27.03

▪ Middle Channel

Frequency (MHz)	ANT Pol	EUT Position (Axis)	Detector Mode	Reading (dBuV)	TF (dB/m)	DCCF (dB)	DCF (dB)	Result (dBuV/m)	Limit (dBuV/m)	Margin (dB)
4 883.10	H	X	PK	49.70	2.38	N/A	N/A	52.08	74.00	21.92
4 883.10	H	X	AV	49.70	2.38	-24.79	N/A	27.29	54.00	26.71

▪ Highest Channel

Frequency (MHz)	ANT Pol	EUT Position (Axis)	Detector Mode	Reading (dBuV)	TF (dB/m)	DCCF (dB)	DCF (dB)	Result (dBuV/m)	Limit (dBuV/m)	Margin (dB)
2 492.74	H	X	PK	50.60	5.54	N/A	N/A	56.14	74.00	17.86
2 492.74	H	X	AV	50.60	5.54	-24.79	N/A	31.35	54.00	22.65
4 959.55	H	X	PK	49.80	2.45	N/A	N/A	52.25	74.00	21.75
4 959.55	H	X	AV	49.80	2.45	-24.79	N/A	27.46	54.00	26.54

9 kHz ~ 25 GHz Data (Modulation : $\pi/4$ DQPSK)

▪ Lowest Channel

Frequency (MHz)	ANT Pol	EUT Position (Axis)	Detector Mode	Reading (dBuV)	TF (dB/m)	DCCF (dB)	DCF (dB)	Result (dBuV/m)	Limit (dBuV/m)	Margin (dB)
2 385.36	H	X	PK	49.63	4.45	N/A	N/A	54.08	74.00	19.92
2 385.36	H	X	AV	49.63	4.45	-24.79	N/A	29.29	54.00	24.71
4 805.07	H	X	PK	49.78	2.40	N/A	N/A	52.18	74.00	21.82
4 805.07	H	X	AV	49.78	2.40	-24.79	N/A	27.39	54.00	26.61

▪ Middle Channel

Frequency (MHz)	ANT Pol	EUT Position (Axis)	Detector Mode	Reading (dBuV)	TF (dB/m)	DCCF (dB)	DCF (dB)	Result (dBuV/m)	Limit (dBuV/m)	Margin (dB)
4 881.20	H	X	PK	49.43	2.36	N/A	N/A	51.79	74.00	22.21
4 881.20	H	X	AV	49.43	2.36	-24.79	N/A	27.00	54.00	27.00

▪ Highest Channel

Frequency (MHz)	ANT Pol	EUT Position (Axis)	Detector Mode	Reading (dBuV)	TF (dB/m)	DCCF (dB)	DCF (dB)	Result (dBuV/m)	Limit (dBuV/m)	Margin (dB)
2 492.25	H	X	PK	50.29	5.53	N/A	N/A	55.82	74.00	18.18
2 492.25	H	X	AV	50.29	5.53	-24.79	N/A	31.03	54.00	22.97
4 959.30	H	X	PK	49.84	2.45	N/A	N/A	52.29	74.00	21.71
4 959.30	H	X	AV	49.84	2.45	-24.79	N/A	27.50	54.00	26.50

9 kHz ~ 25 GHz Data (Modulation : 8DPSK)

▪ Lowest Channel

Frequency (MHz)	ANT Pol	EUT Position (Axis)	Detector Mode	Reading (dBuV)	TF (dB/m)	DCCF (dB)	DCF (dB)	Result (dBuV/m)	Limit (dBuV/m)	Margin (dB)
2 376.79	H	X	PK	49.42	4.43	N/A	N/A	53.85	74.00	20.15
2 376.79	H	X	AV	49.42	4.43	-24.79	N/A	29.06	54.00	24.94
4 803.07	H	X	PK	50.36	2.40	N/A	N/A	52.76	74.00	21.24
4 803.07	H	X	AV	50.36	2.40	-24.79	N/A	27.97	54.00	26.03

▪ Middle Channel

Frequency (MHz)	ANT Pol	EUT Position (Axis)	Detector Mode	Reading (dBuV)	TF (dB/m)	DCCF (dB)	DCF (dB)	Result (dBuV/m)	Limit (dBuV/m)	Margin (dB)
4 883.29	H	X	PK	49.84	2.38	N/A	N/A	52.22	74.00	21.78
4 883.29	H	X	AV	49.84	2.38	-24.79	N/A	27.43	54.00	26.57

▪ Highest Channel

Frequency (MHz)	ANT Pol	EUT Position (Axis)	Detector Mode	Reading (dBuV)	TF (dB/m)	DCCF (dB)	DCF (dB)	Result (dBuV/m)	Limit (dBuV/m)	Margin (dB)
2 486.49	H	X	PK	49.48	5.44	N/A	N/A	54.92	74.00	19.08
2 486.49	H	X	AV	49.48	5.44	-24.79	N/A	30.13	54.00	23.87
4 958.97	H	X	PK	49.78	2.45	N/A	N/A	52.23	74.00	21.77
4 958.97	H	X	AV	49.78	2.45	-24.79	N/A	27.44	54.00	26.56

9.4.2. Unwanted Emissions(Conducted)

Low Band-edge

Lowest Channel & Modulation : GFSK

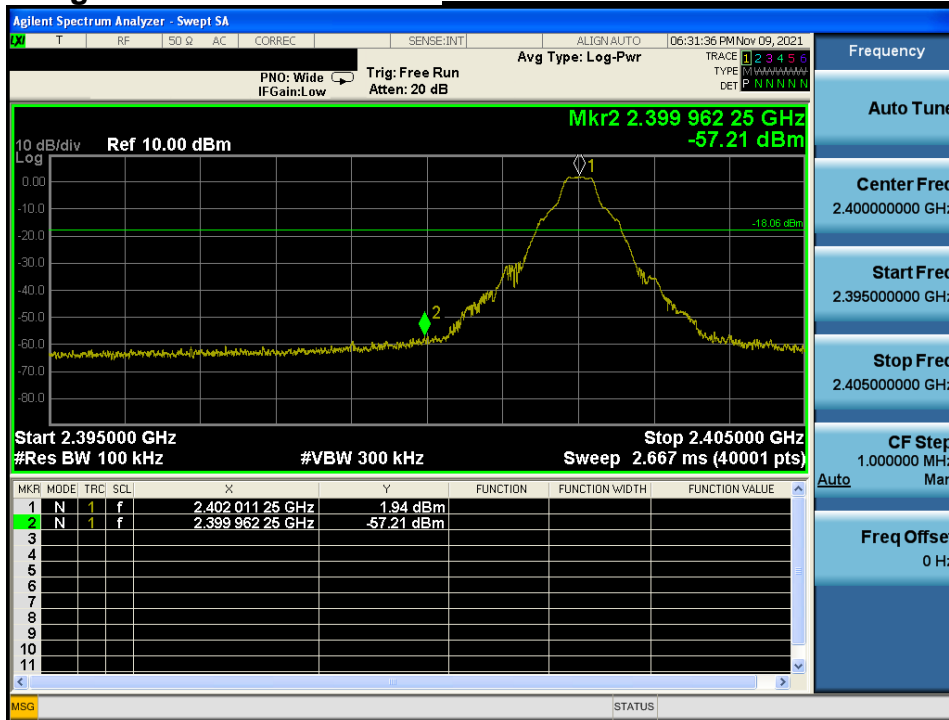

Low Band-edge

Hopping mode & Modulation : GFSK



Conducted Spurious Emissions **Lowest Channel & Modulation : GFSK**

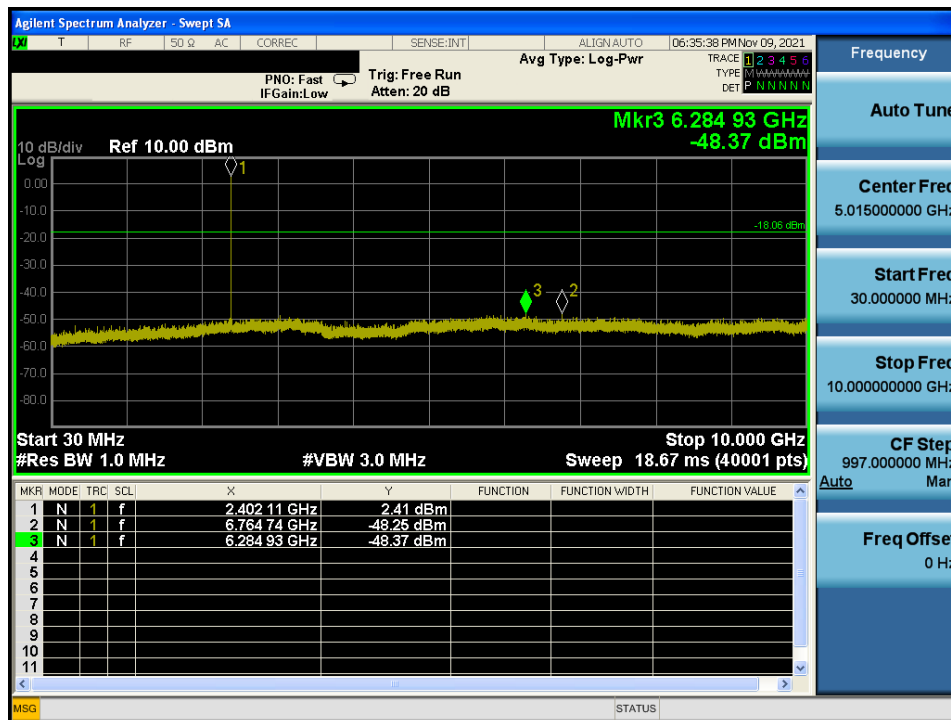
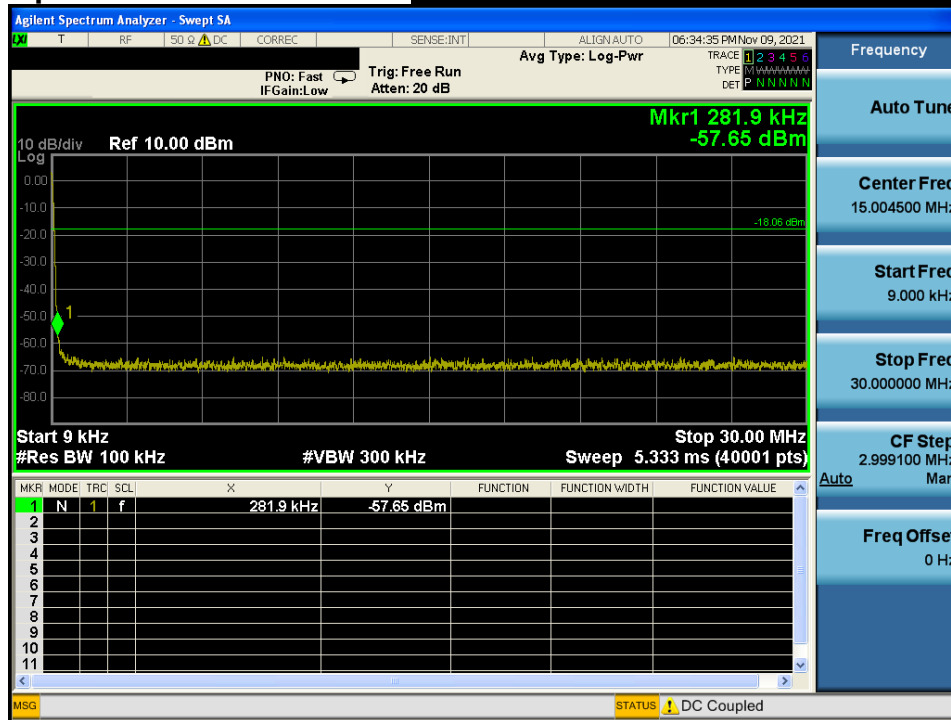

Conducted Spurious Emissions **Lowest Channel & Modulation : GFSK**



Reference for limit

Middle Channel & Modulation : GFSK

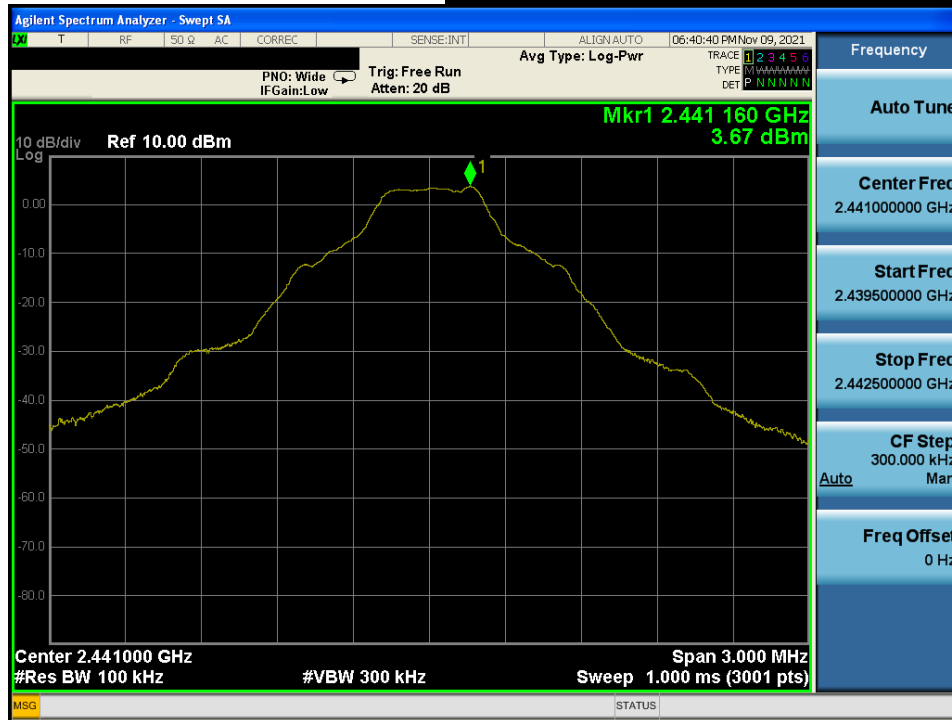

Conducted Spurious Emissions

Middle Channel & Modulation : GFSK

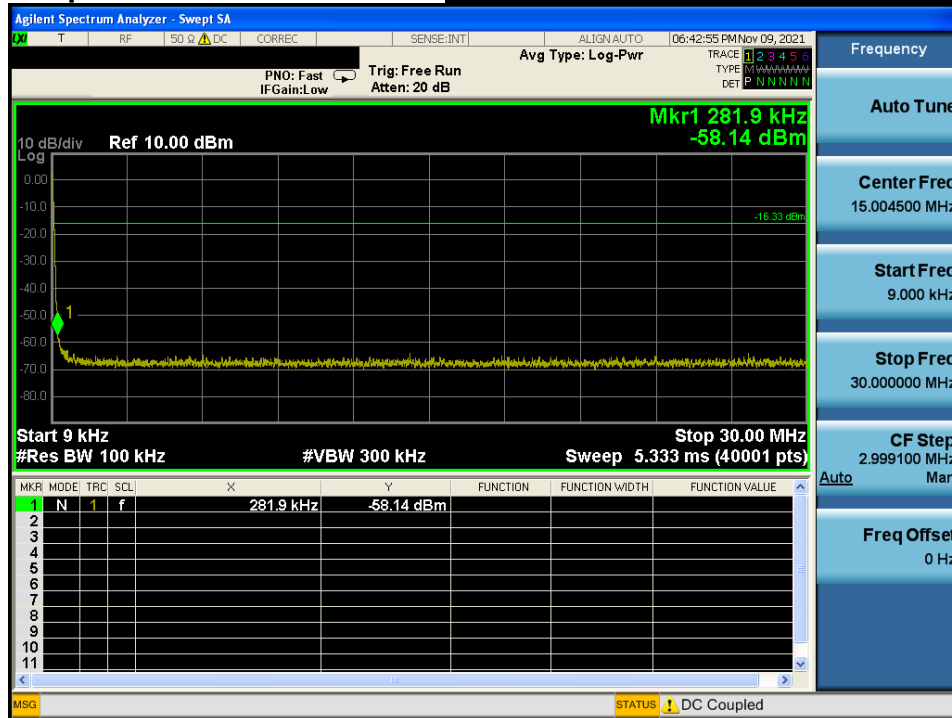

Conducted Spurious Emissions *Middle Channel & Modulation : GFSK*

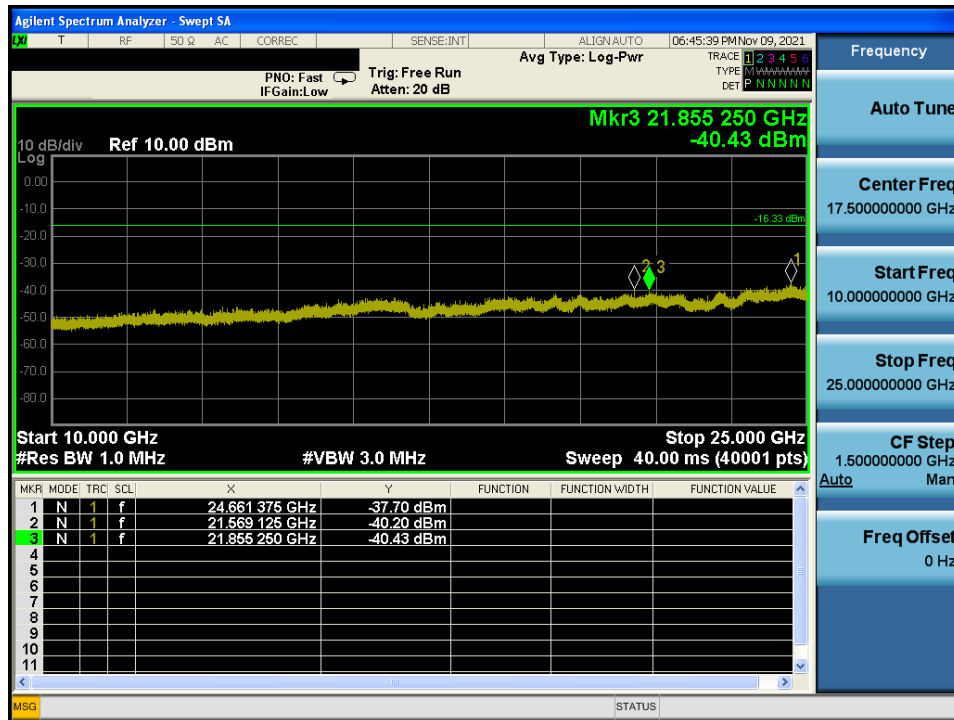
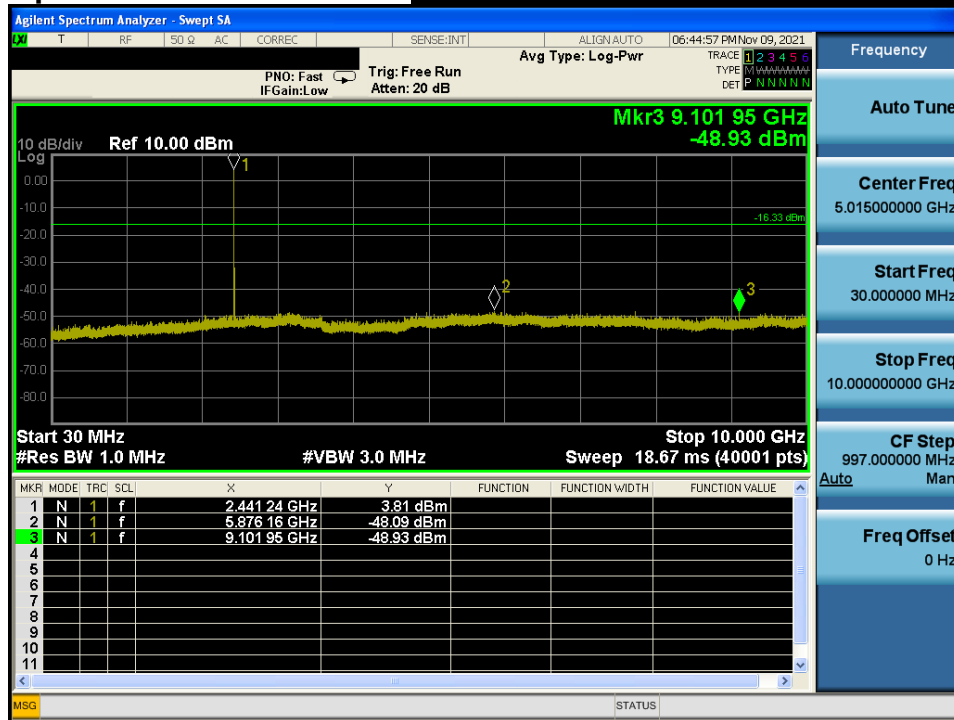

High Band-edge

Highest Channel & Modulation : GFSK

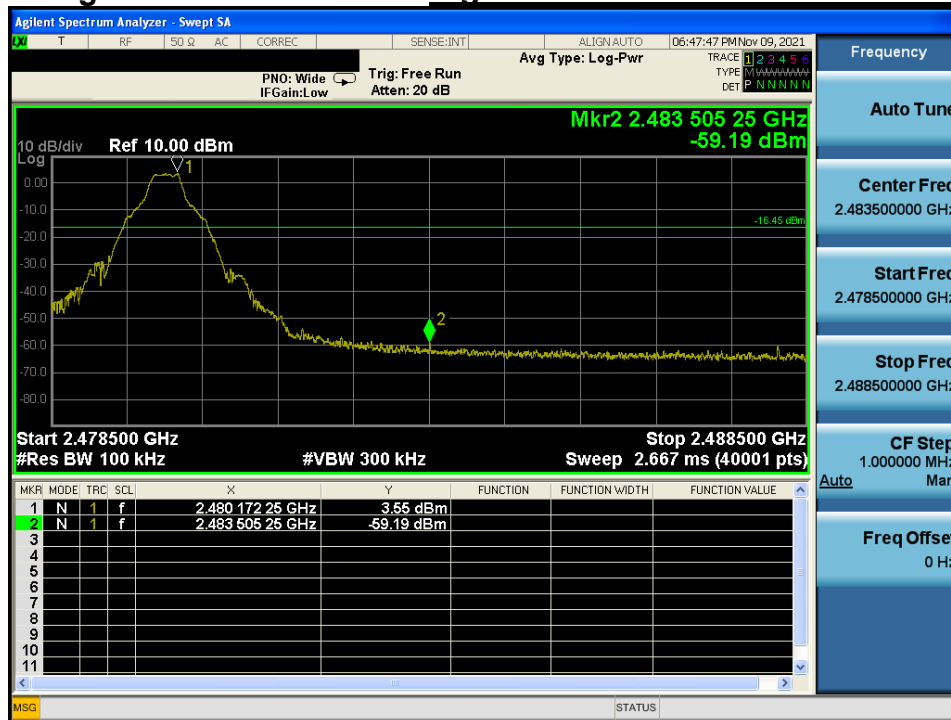

High Band-edge

Hopping mode & Modulation : GFSK

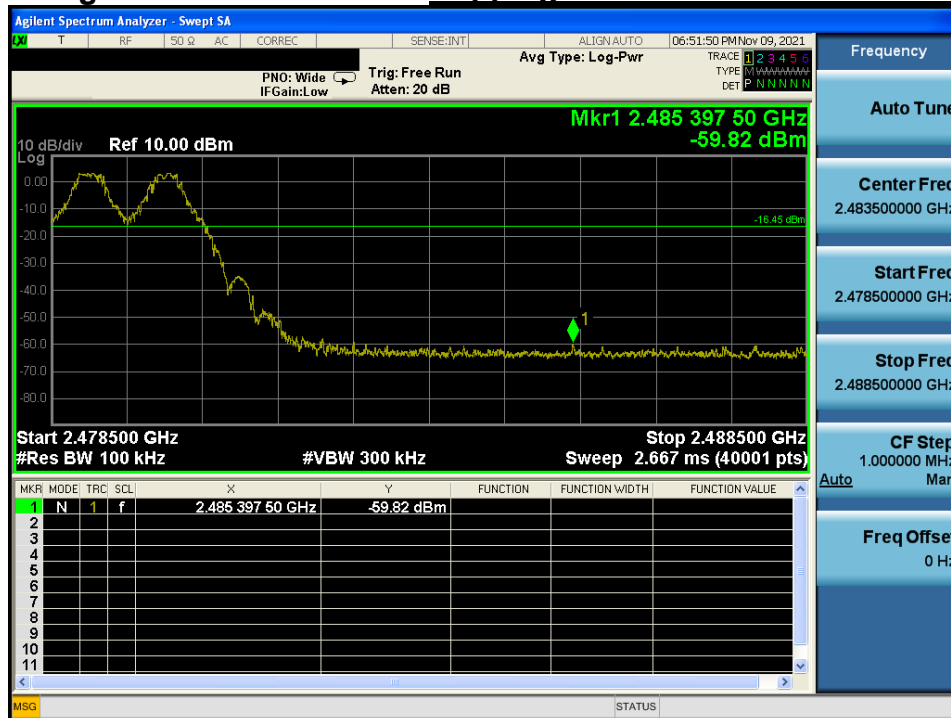

Conducted Spurious Emissions **Highest Channel & Modulation : GFSK**

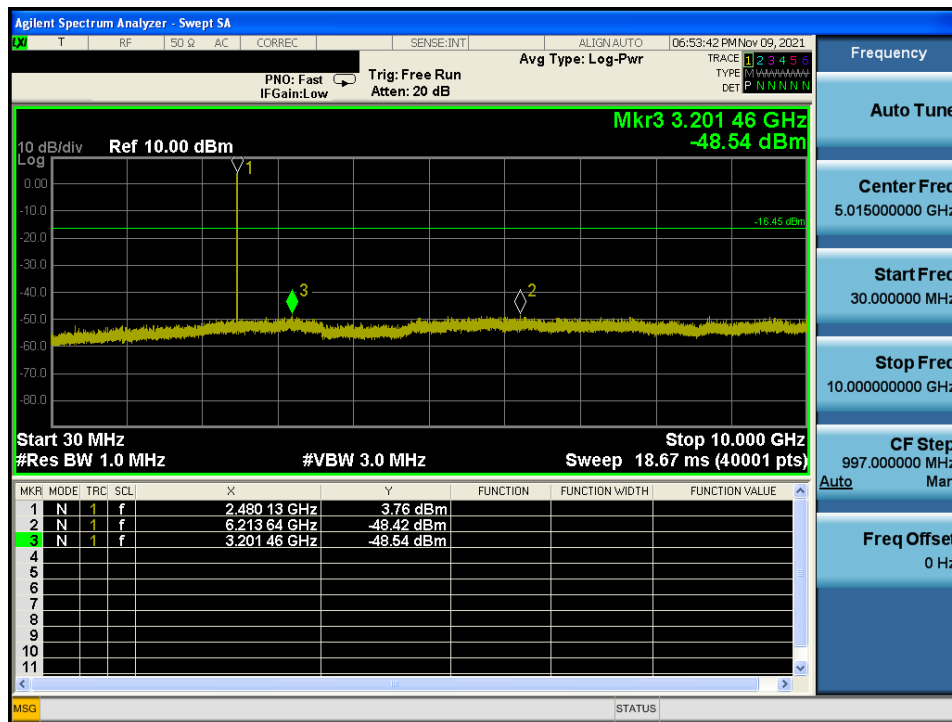
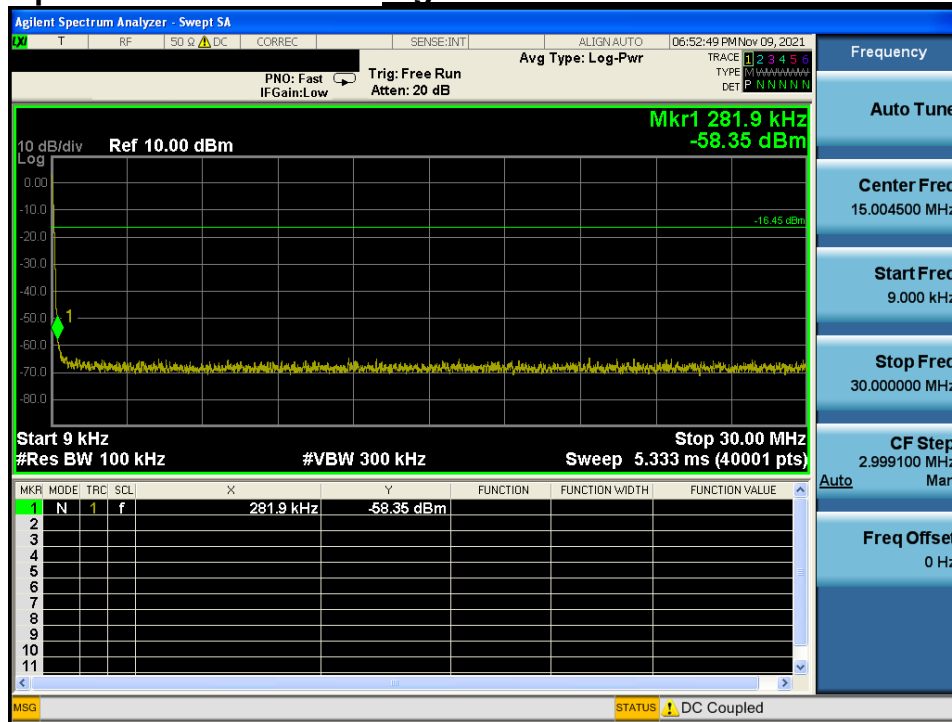

Conducted Spurious Emissions **Highest Channel & Modulation : GFSK**

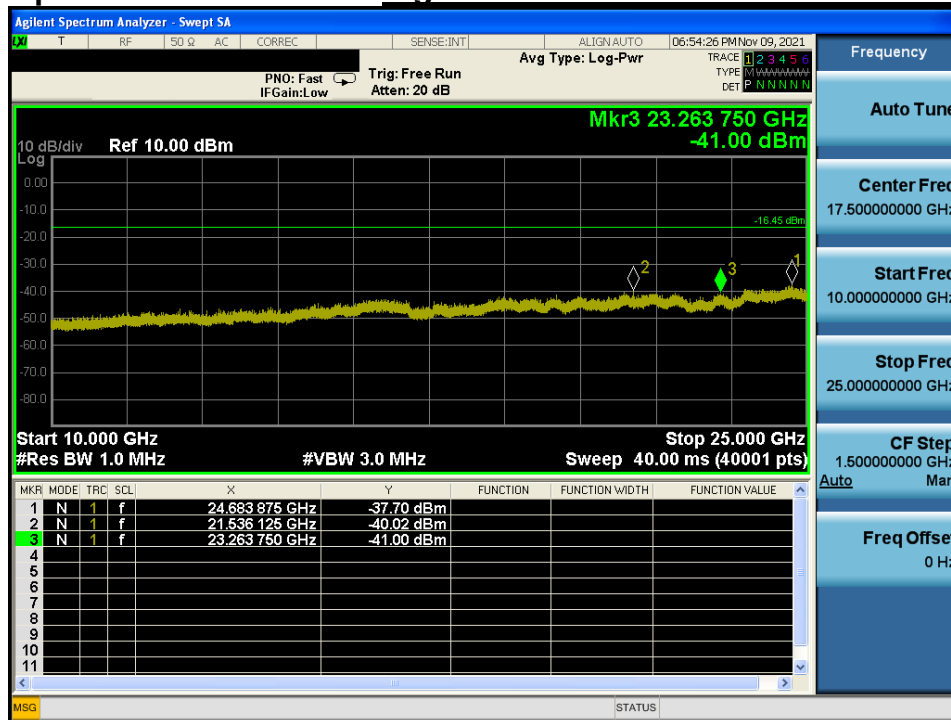

Low Band-edge

Lowest Channel & Modulation : $\pi/4$ DQPSK

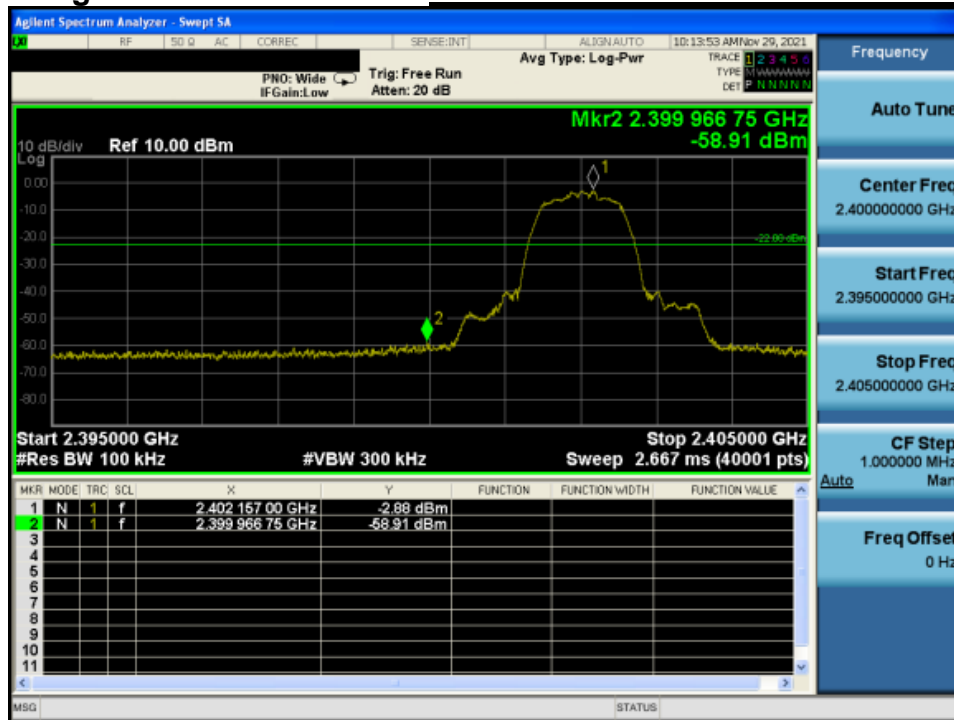

Low Band-edge

Hopping mode & Modulation : $\pi/4$ DQPSK



Conducted Spurious Emissions Lowest Channel & Modulation : $\pi/4$ DQPSK

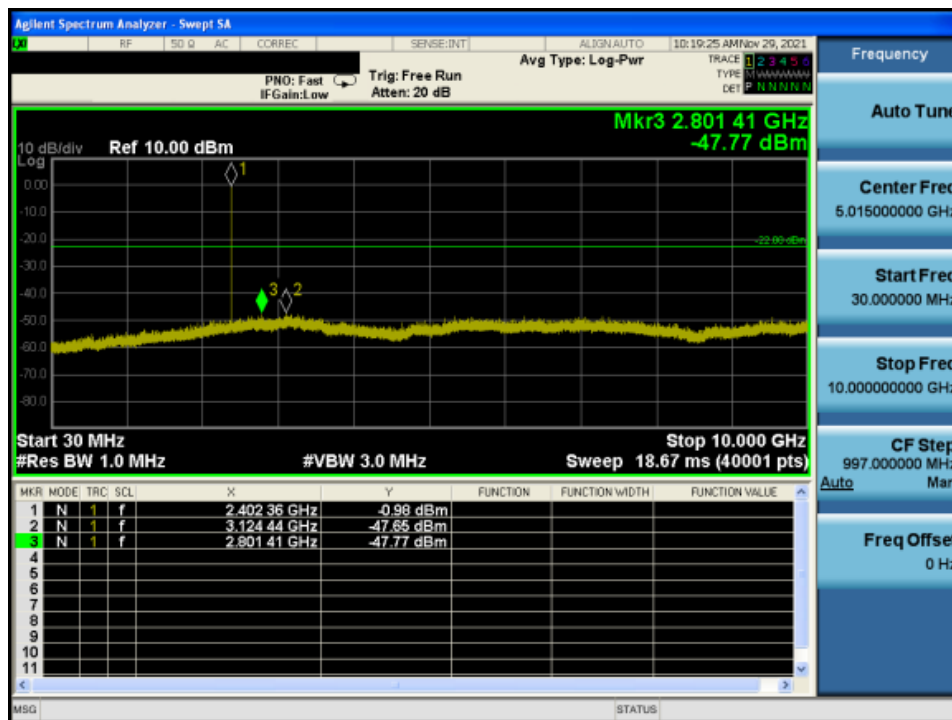
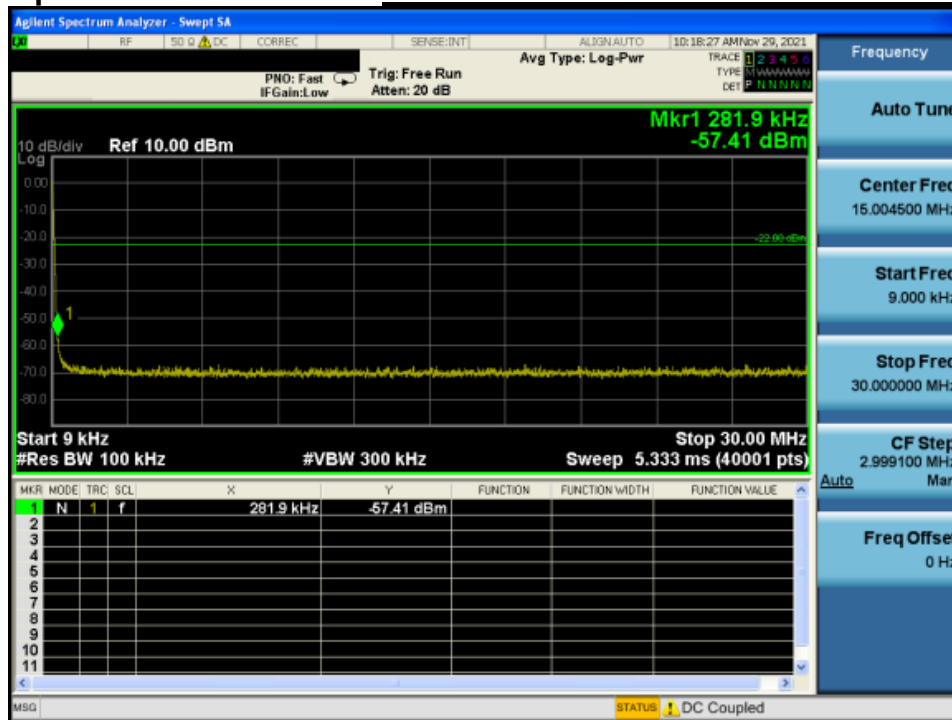

Conducted Spurious Emissions Lowest Channel & Modulation : $\pi/4$ DQPSK



Reference for limit

Middle Channel & Modulation : $\pi/4$ DQPSK

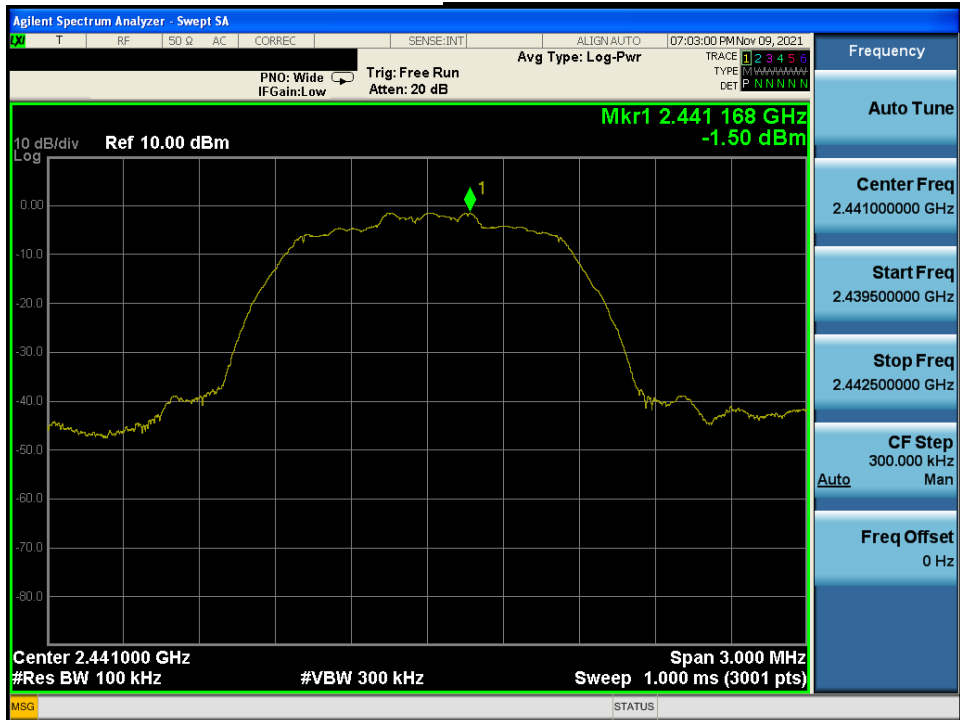

Conducted Spurious Emissions

Middle Channel & Modulation : $\pi/4$ DQPSK

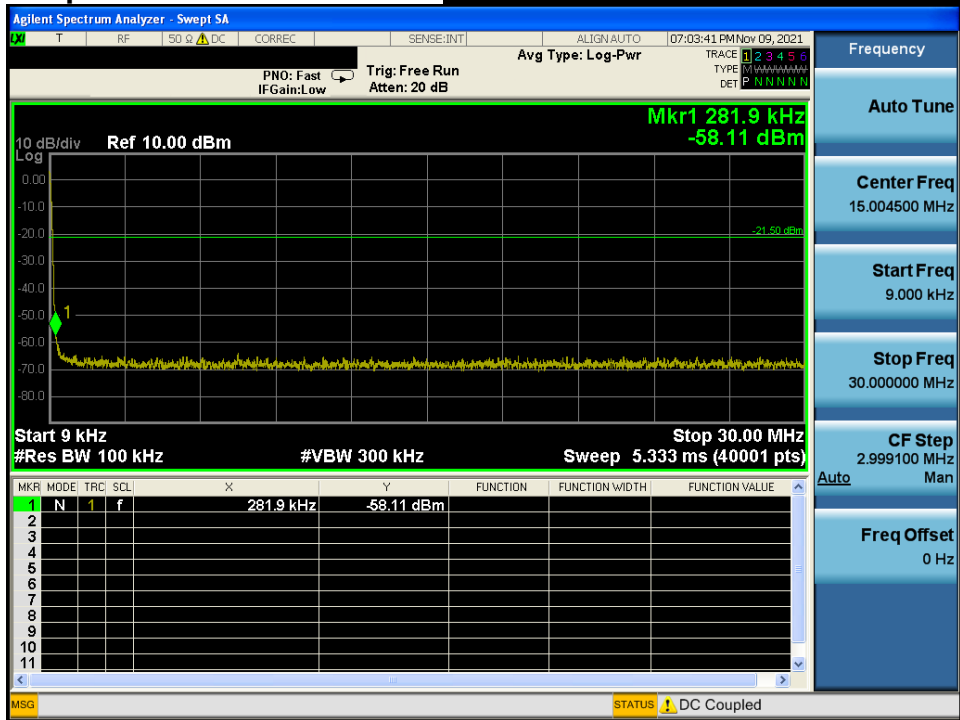

Conducted Spurious Emissions *Middle Channel & Modulation : $\pi/4$ DQPSK*

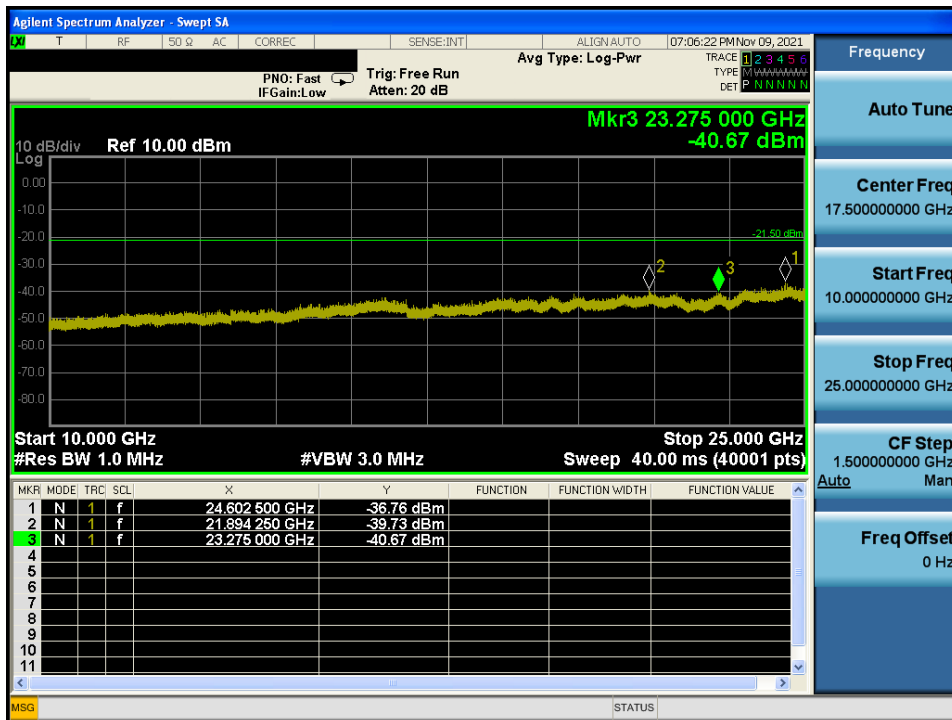
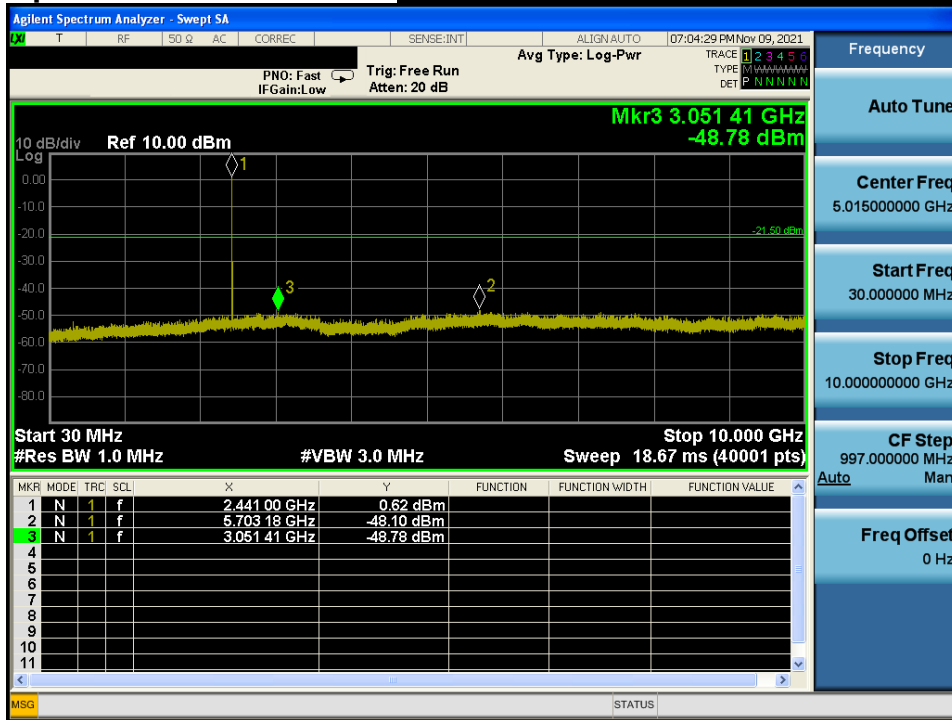

High Band-edge

Highest Channel & Modulation : $\pi/4$ DQPSK

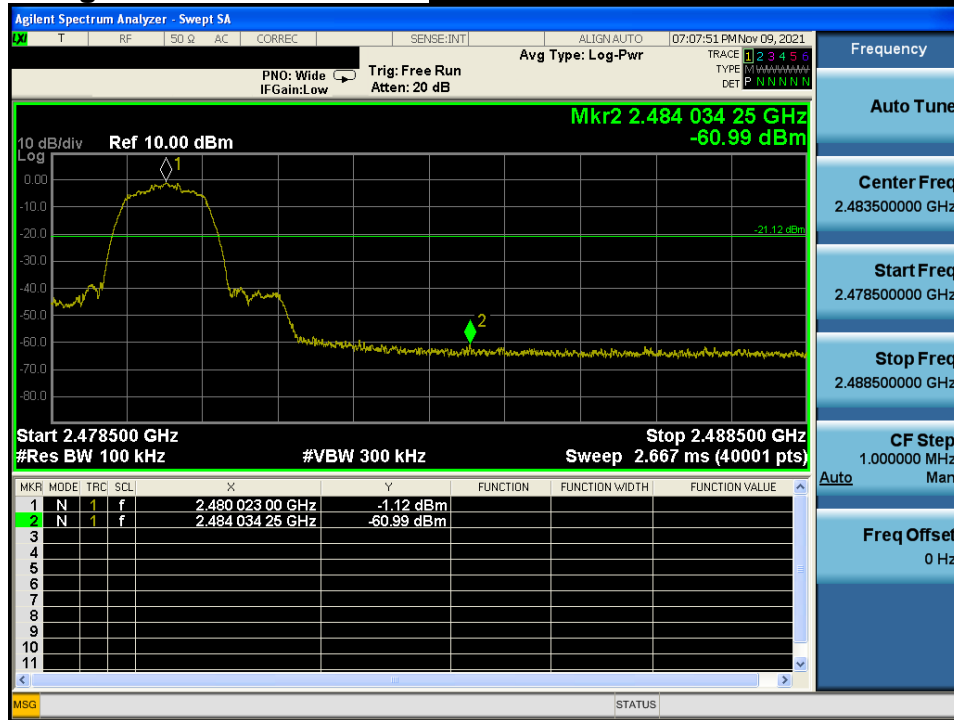

High Band-edge

Hopping mode & Modulation : $\pi/4$ DQPSK

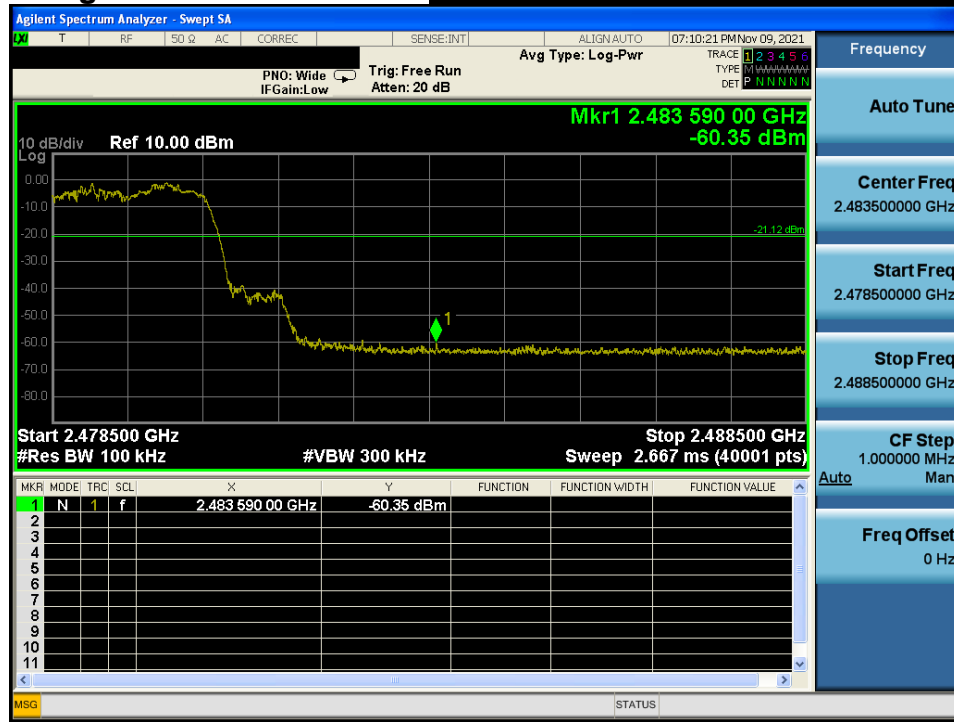

Conducted Spurious Emissions

Highest Channel & Modulation : $\pi/4$ DQPSK

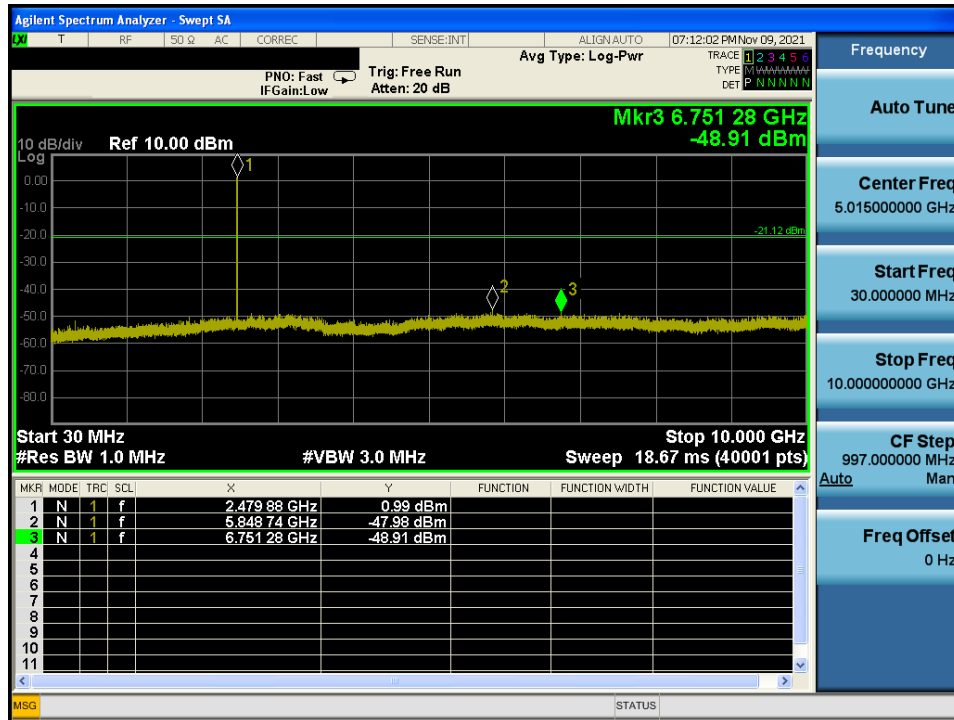
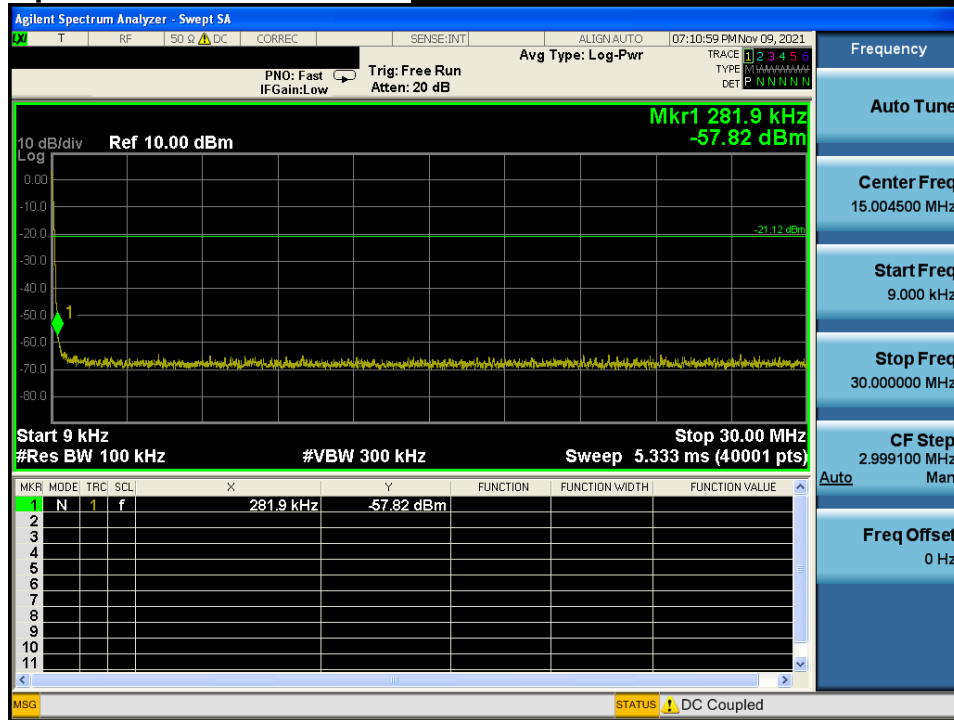

Conducted Spurious Emissions

Highest Channel & Modulation : $\pi/4$ DQPSK

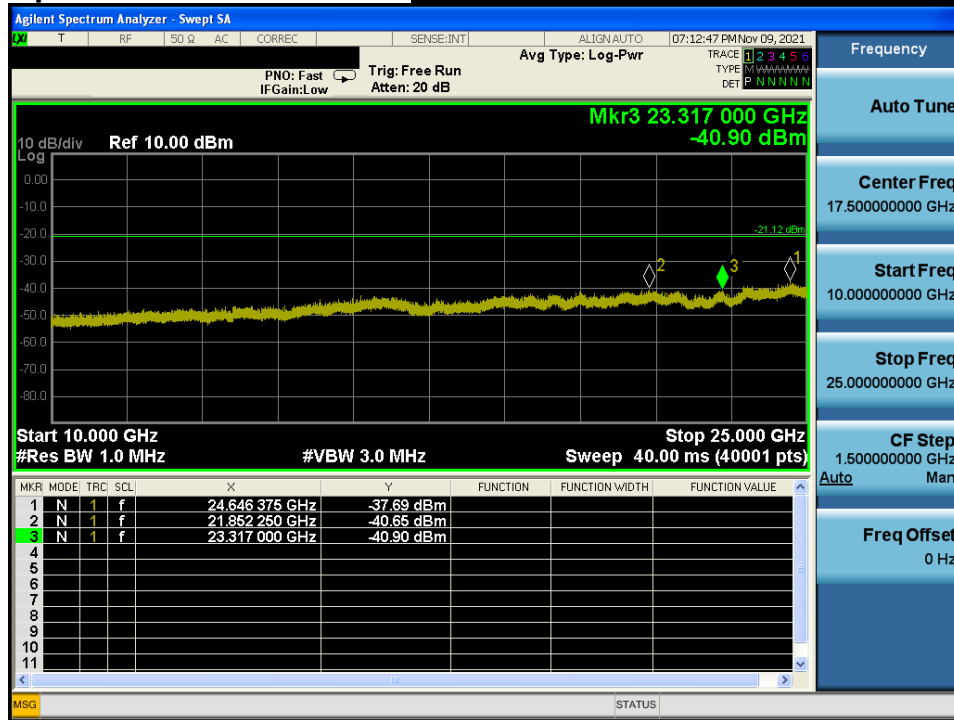

Low Band-edge

Lowest Channel & Modulation : 8DPSK

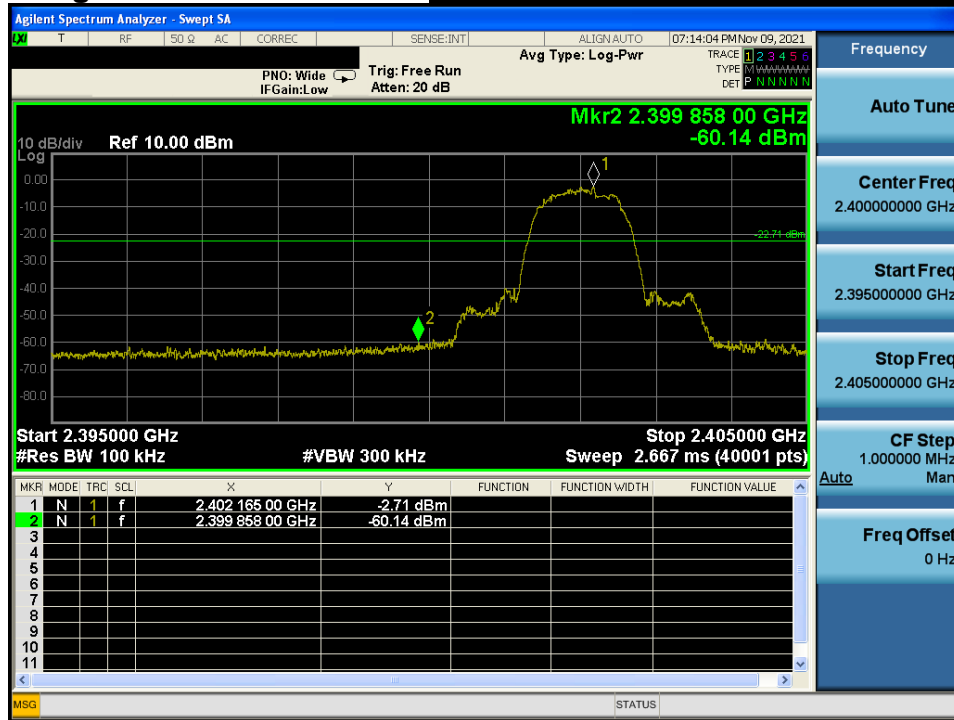

Low Band-edge

Hopping mode & Modulation : 8DPSK

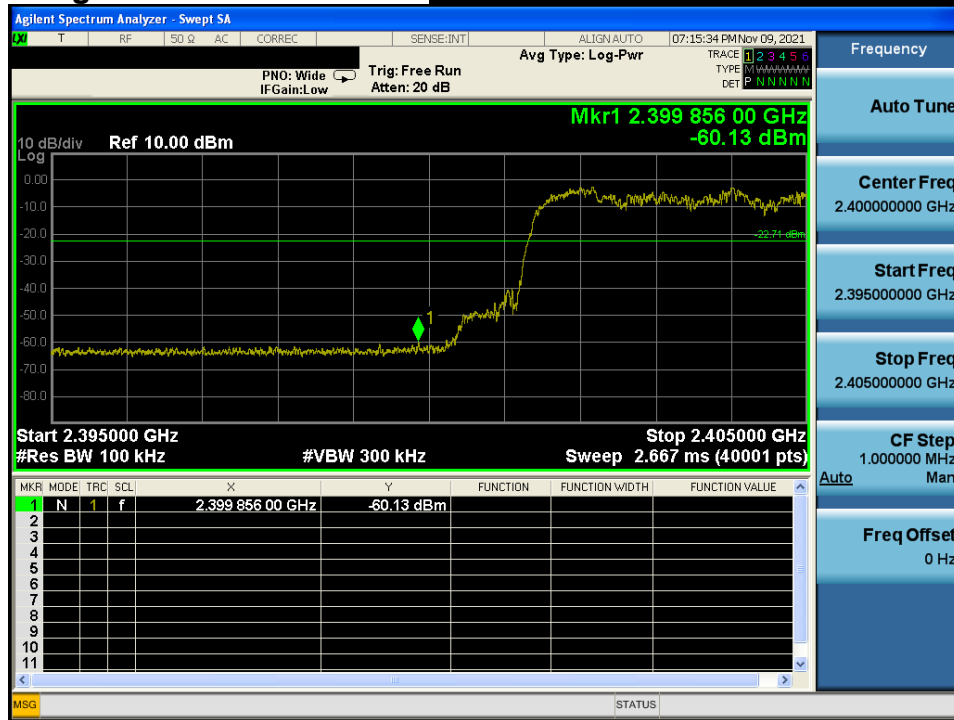

Conducted Spurious Emissions **Lowest Channel & Modulation : 8DPSK**

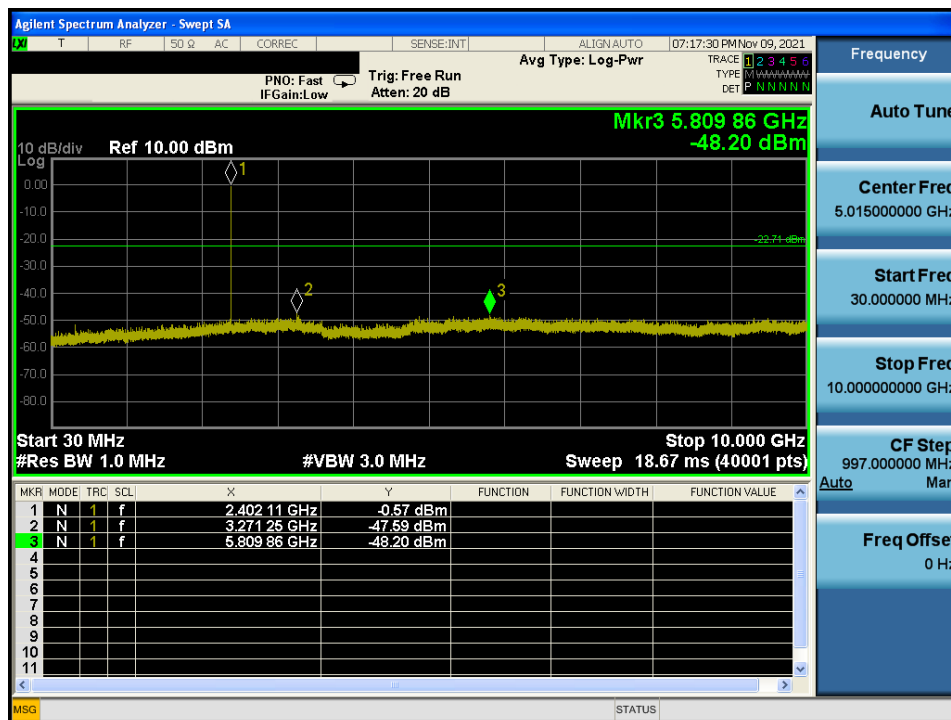
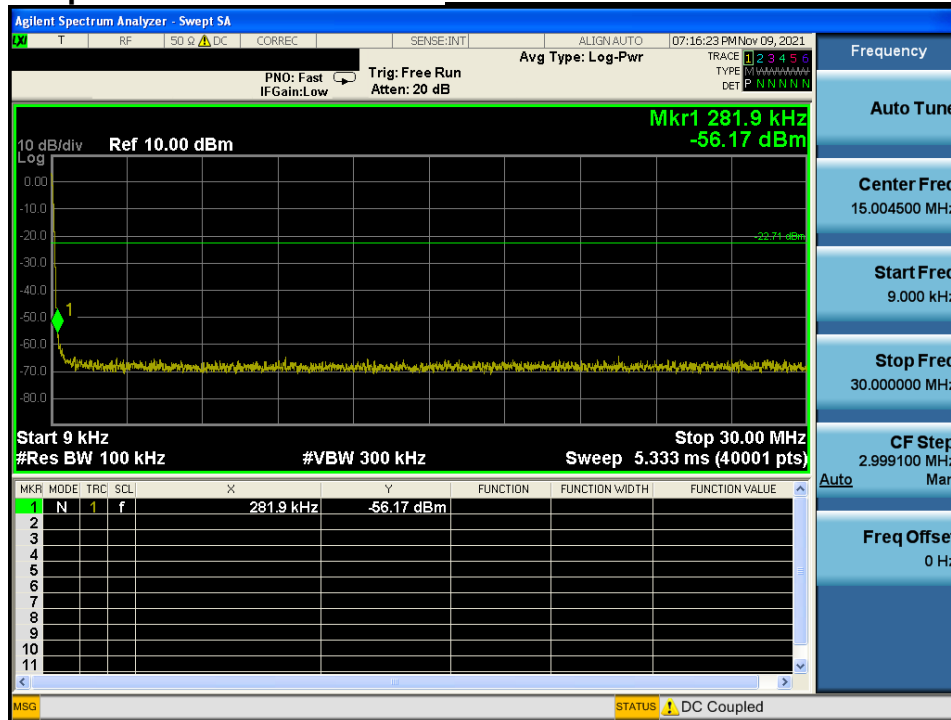

Conducted Spurious Emissions **Lowest Channel & Modulation : 8DPSK**



Reference for limit

Middle Channel & Modulation : 8DPSK

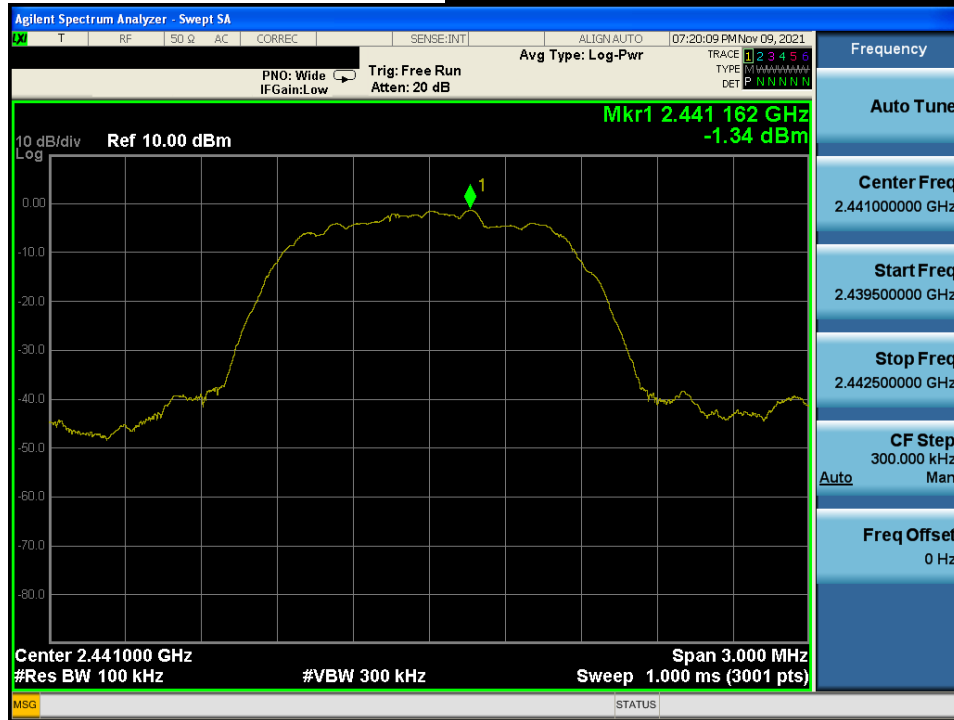

Conducted Spurious Emissions

Middle Channel & Modulation : 8DPSK

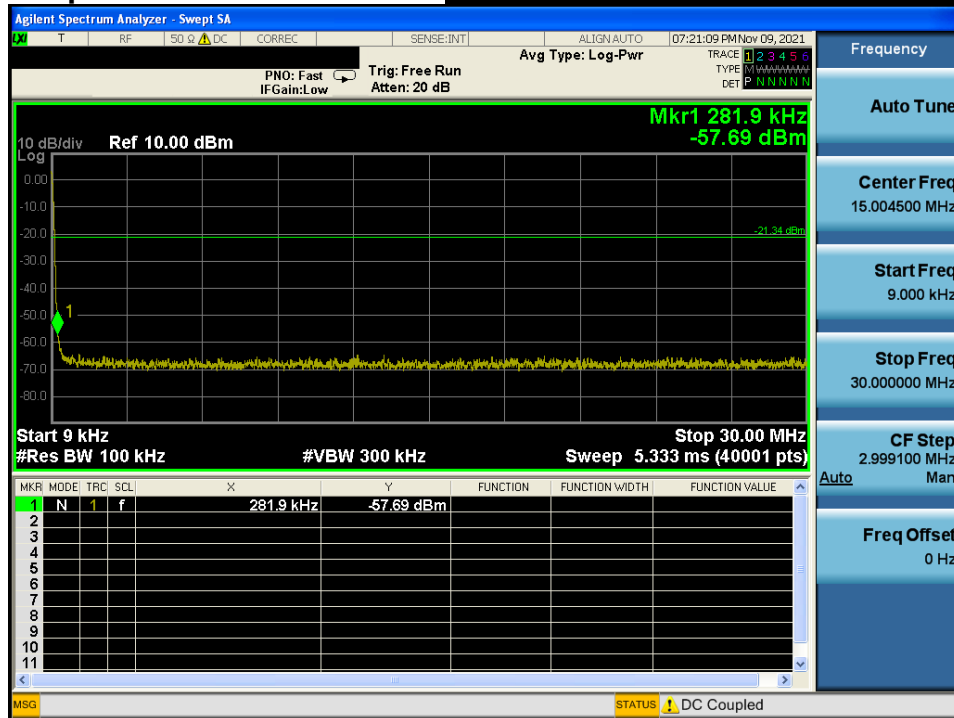

Conducted Spurious Emissions *Middle Channel & Modulation : 8DPSK*

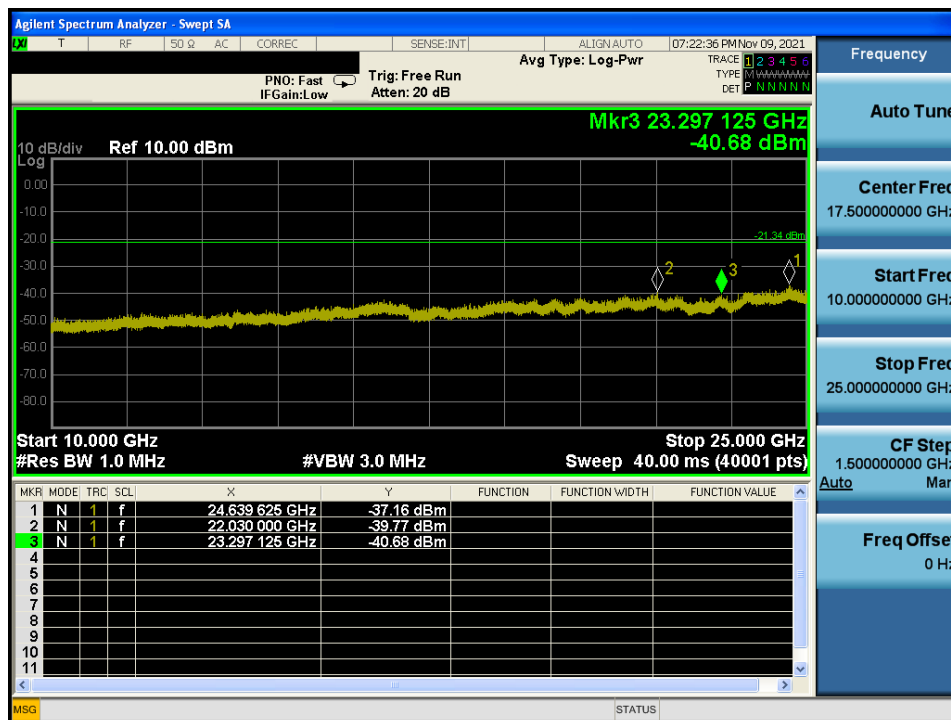
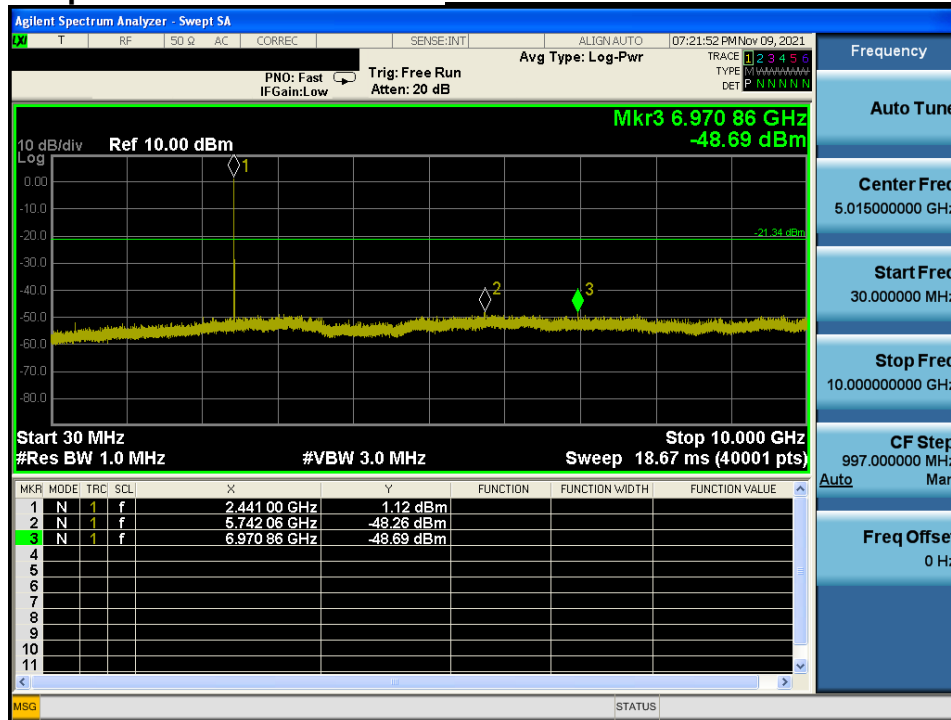

High Band-edge

Highest Channel & Modulation : 8DPSK

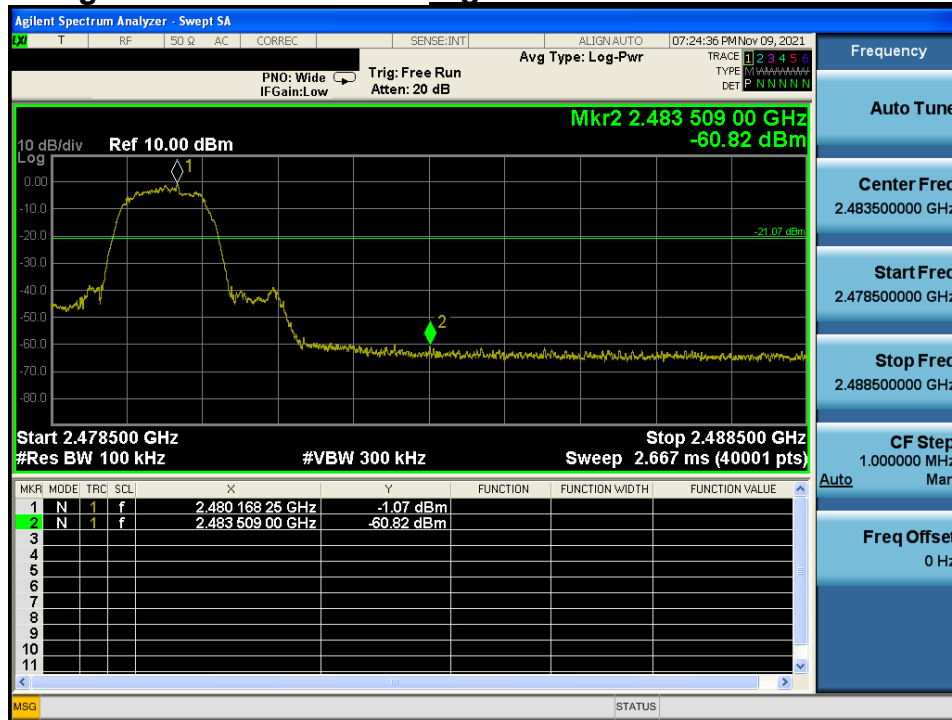

High Band-edge

Hopping mode & Modulation : 8DPSK



Conducted Spurious Emissions **Highest Channel & Modulation : 8DPSK**

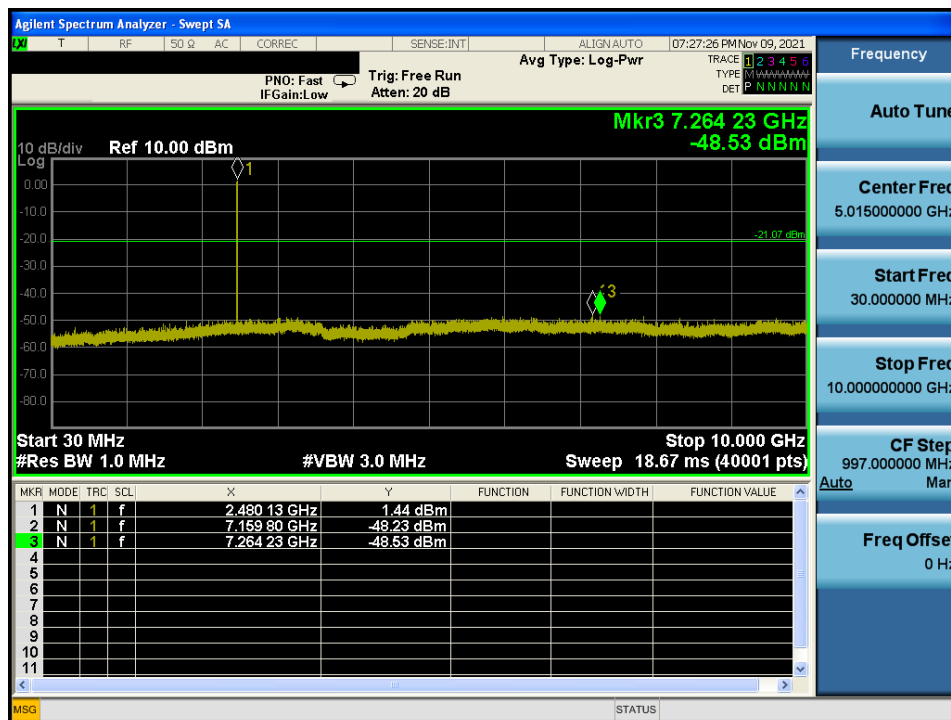
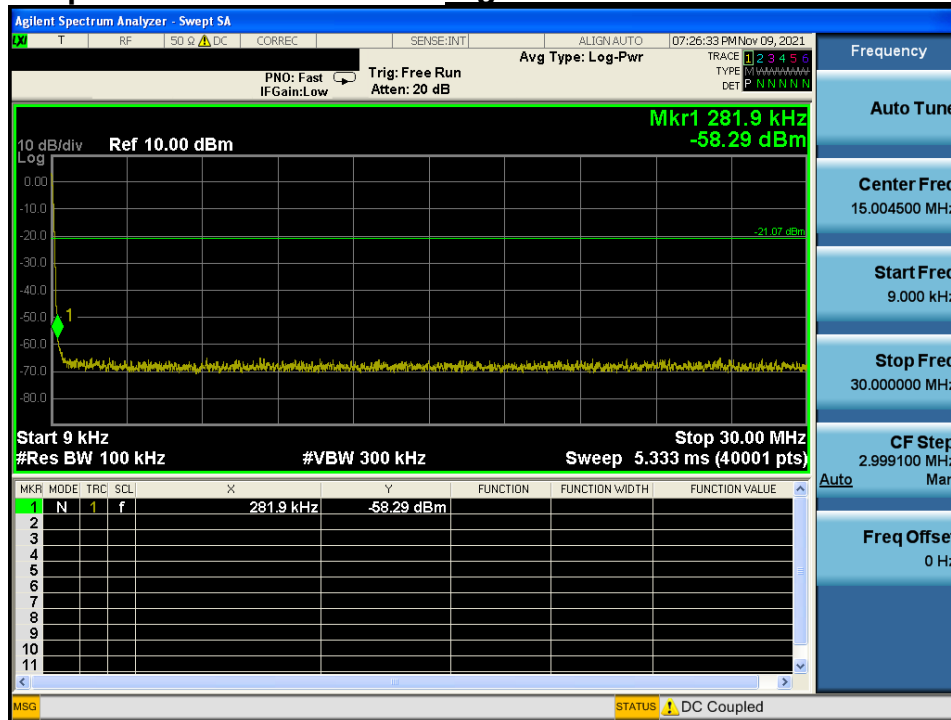

Conducted Spurious Emissions *Highest Channel & Modulation : 8DPSK*



10. AC Power-Line Conducted Emissions

10.1. Test Setup

NA

10.2. Limit

According to §15.207(a) for an intentional radiator that is designed to be connected to the public utility (AC) power line, the radio frequency voltage that is conducted back onto the AC power line on any frequency or frequencies, within the band 150 kHz to 30 MHz, shall not exceed the limits in the following table, as measured using a 50 uH/50 ohm line impedance stabilization network (LISN).

Compliance with the provision of this paragraph shall on the measurement of the radio frequency voltage between each power line and ground at the power terminal. The lower applies at the boundary between the frequency ranges.

Frequency Range (MHz)	Conducted Limit (dBuV)	
	Quasi-Peak	Average
0.15 ~ 0.50	66 to 56 *	56 to 46 *
0.5 ~ 5.0	56	46
5 ~ 30	60	50

* Decreases with the logarithm of the frequency

10.3. Test Procedure

Conducted emissions from the EUT were measured according to the ANSI C63.10.

1. The test procedure is performed in a 6.5 m × 3.5 m × 3.5 m (L × W × H) shielded room. The EUT along with its peripherals were placed on a 1.0 m (W) × 1.5 m (L) and 0.8 m in height wooden table and the EUT was adjusted to maintain a 0.4 meter space from a vertical reference plane.
2. The EUT was connected to power mains through a line impedance stabilization network (LISN) which provides 50 ohm coupling impedance for measuring instrument and the chassis ground was bounded to the horizontal ground plane of shielded room.
3. All peripherals were connected to the second LISN and the chassis ground also bounded to the horizontal ground plane of shielded room.
4. The excess power cable between the EUT and the LISN was bundled. The power cables of peripherals were unbundled. All connecting cables of EUT and peripherals were moved to find the maximum emission.

10.4. Test Results

NA

APPENDIX I

Test set up diagrams

▪ Radiated Measurement

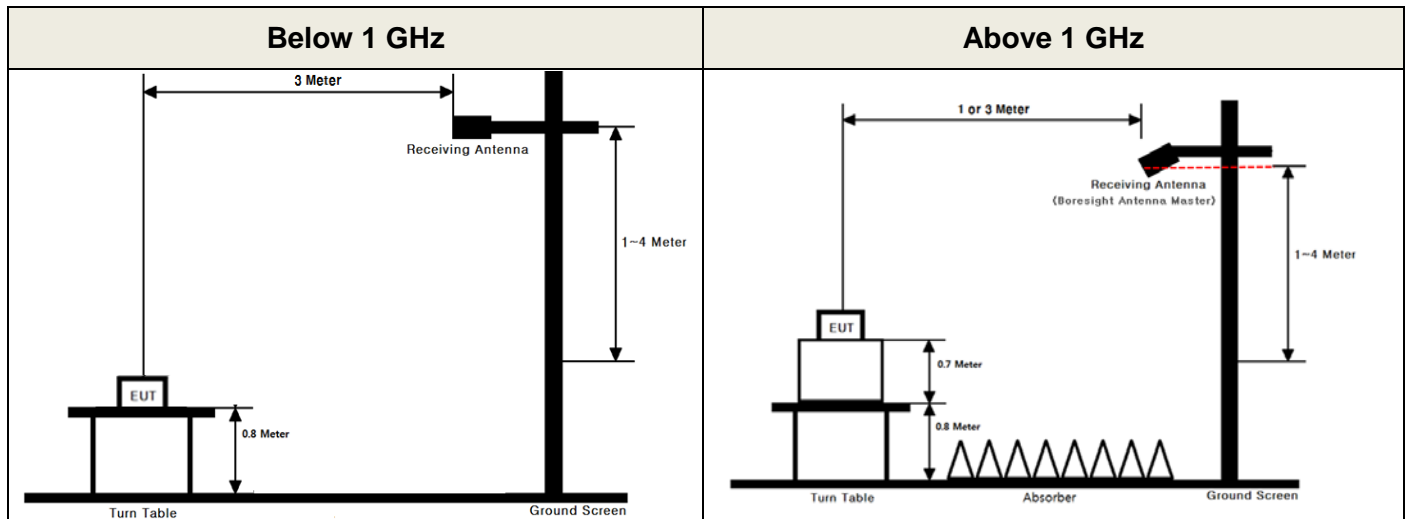

▪ Conducted Measurement

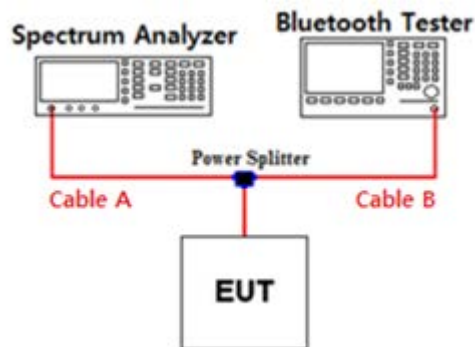

Path loss information

Frequency (GHz)	Path Loss (dB)	Frequency (GHz)	Path Loss (dB)
0.03	6.27	15	9.05
1	6.67	20	9.47
2.402 & 2.441 & 2.480	7.06	25	9.86
5	7.82	-	-
10	8.25	-	-

Note 1: The path loss from EUT to Spectrum analyzer was measured and used for test.
 Path loss (S/A's correction factor) = Cable A + Power Splitter

APPENDIX II

Unwanted Emissions (Radiated) Test Plot

GFSK & Lowest & X & Hor

Detector Mode : PK

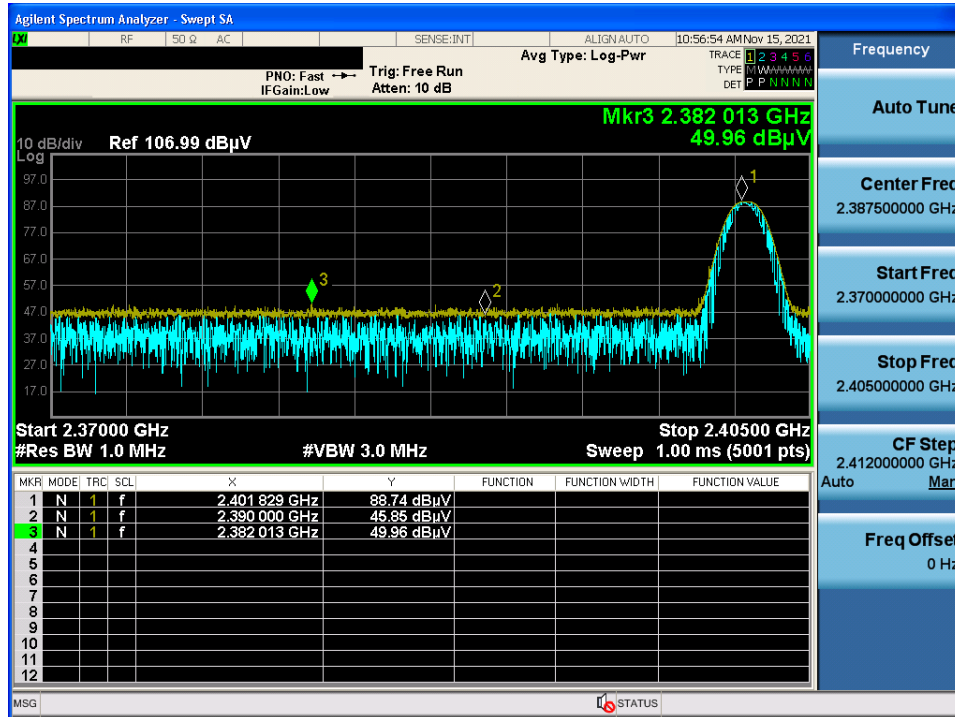

GFSK & Highest & X & Hor

Detector Mode : PK

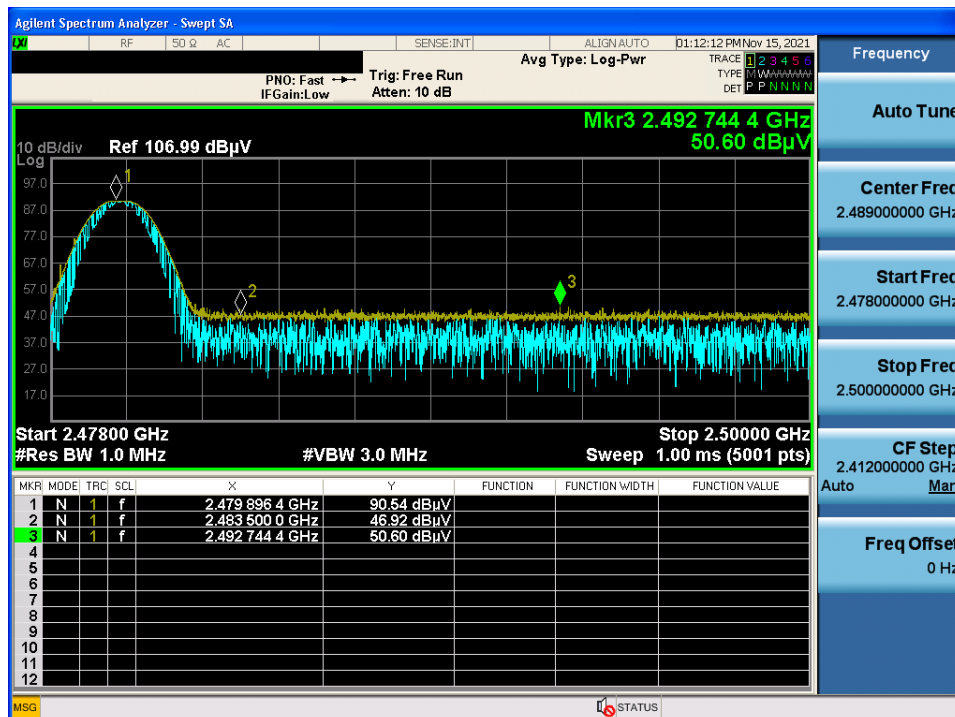

$\pi/4$ DQPSK & Lowest & X & Hor

Detector Mode : PK

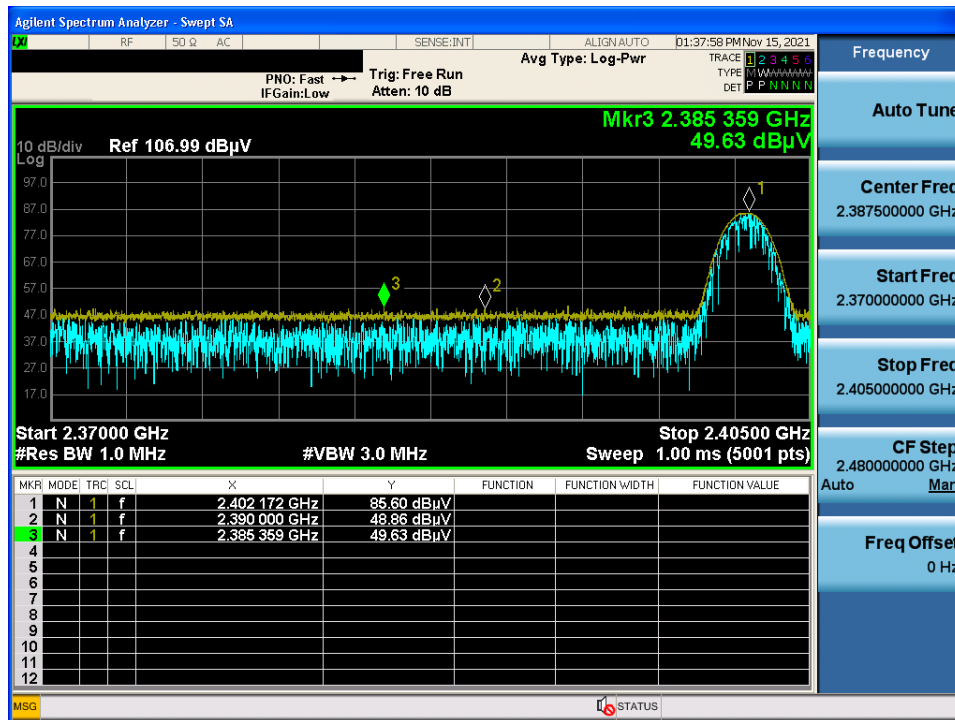

$\pi/4$ DQPSK & Highest & X & Hor

Detector Mode : PK

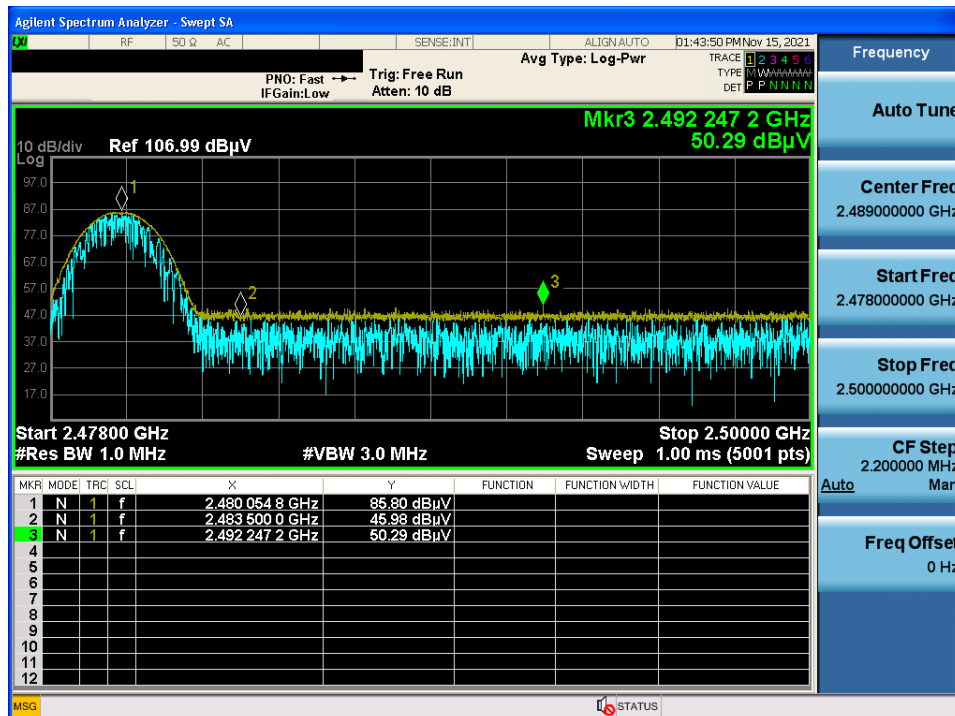

8DPSK & Lowest & X & Hor

Detector Mode : PK

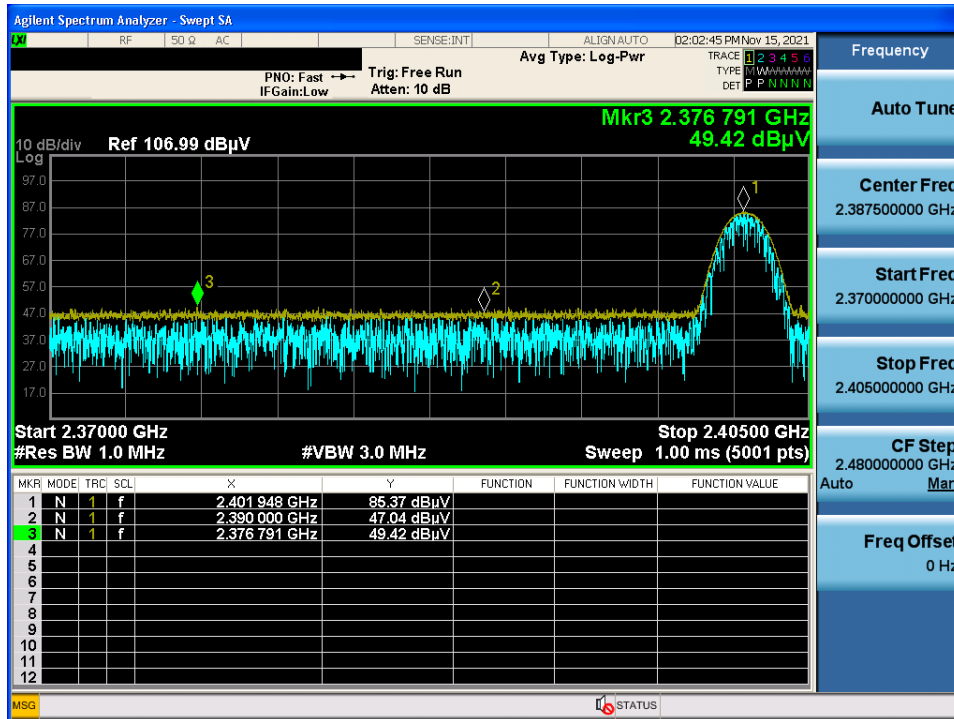

8DPSK & Highest & X & Hor

Detector Mode : PK

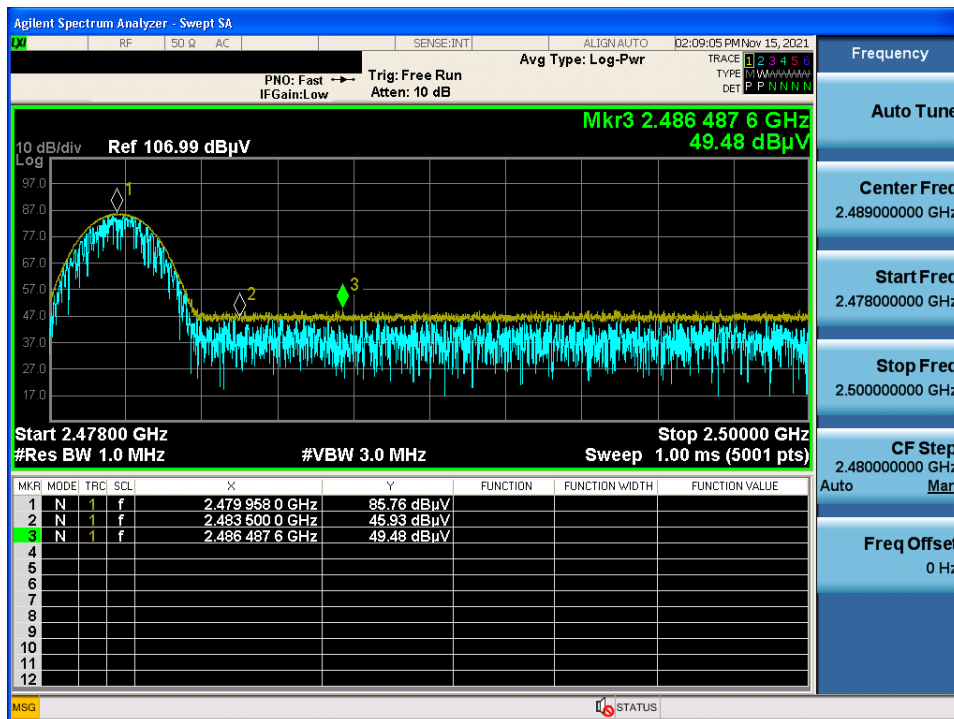

GFSK & Highest & X & Hor

Detector Mode : PK

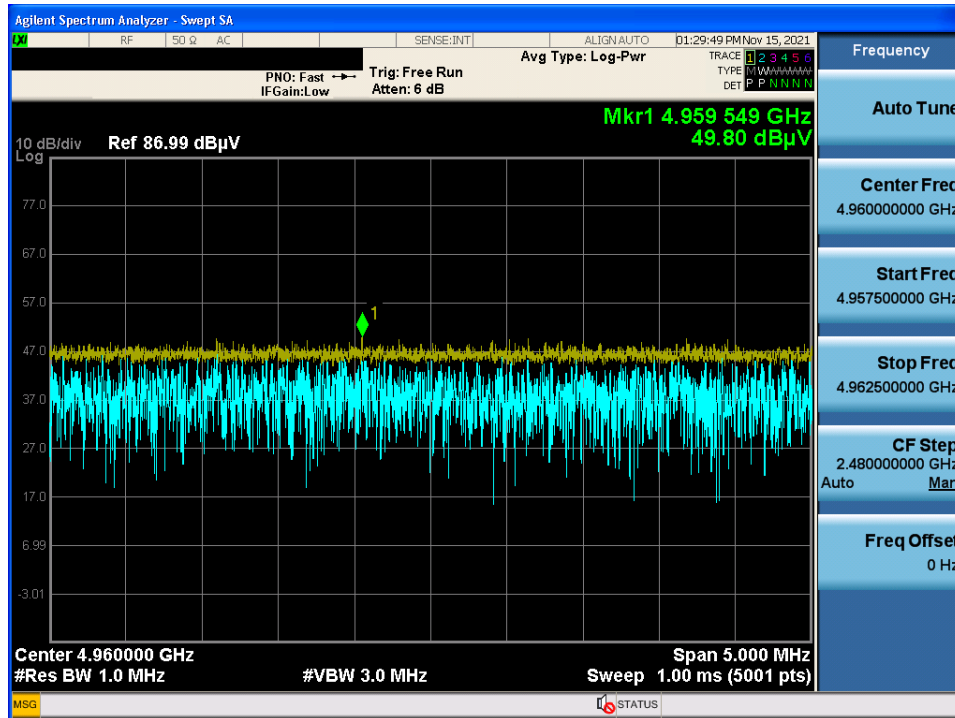

$\pi/4$ DQPSK & Highest & X & Hor

Detector Mode : PK

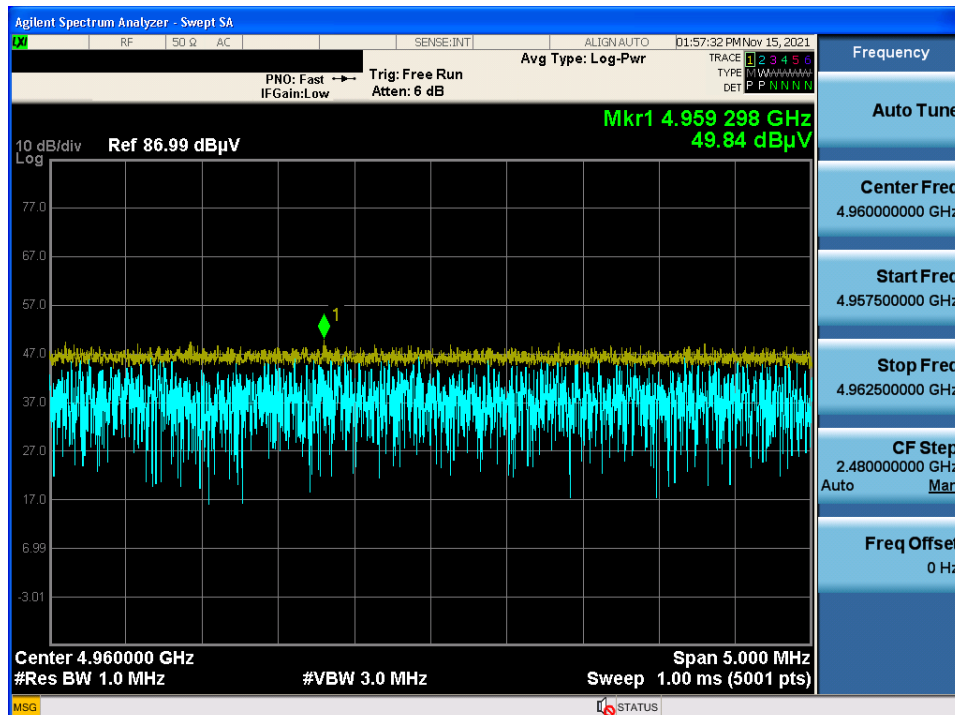

8DPSK & Lowest & X & Hor

Detector Mode : PK

