

TEST REPORT

of

FCC Part 15 Subpart C §15.247
RSS-247 Issue 2, RSS-Gen Issue 5

FCC ID: TQ8-ATC40S8AN
IC Certification: 5074A-ATC40S8KN

Equipment Under Test : DIGITAL CAR AVN SYSTEM
FCC Model Name : ATC40S8AN
IC Model Name : ATC40S8KN
FCC Variant Model Name : ATC41S8AN
IC Variant Model Name : ATC41S8KN
Applicant : Hyundai Mobis Co., Ltd.
Manufacturer : Hyundai Mobis Co., Ltd.
Date of Receipt : 2018.09.03
Date of Test(s) : 2018.10.01 ~ 2018.11.23
Date of Issue : 2018.11.27

In the configuration tested, the EUT complied with the standards specified above.

Tested By:



Nancy Park

Date:

2018.11.27

Technical
Manager:



Jungmin Yang

Date:

2018.11.27

The results shown in this test report refer only to the sample(s) tested unless otherwise stated. This test report cannot be reproduced, except in full, without prior written permission of the Company. This test report does not assure KOLAS accreditation.

INDEX

<u>Table of Contents</u>	Page
1. General Information -----	3
2. Transmitter Radiated Spurious Emissions and Conducted Spurious Emission -----	9
3. 20 dB Bandwidth and 99% Bandwidth -----	32
4. Maximum Peak Conducted Output Power -----	44
5. Carrier Frequency Separation -----	46
6. Number of Hopping Frequencies -----	50
7. Time of Occupancy(Dwell Time) -----	54
8. Antenna Requirement -----	68

The results shown in this test report refer only to the sample(s) tested unless otherwise stated. This test report cannot be reproduced, except in full, without prior written permission of the Company. This test report does not assure KOLAS accreditation.

1. General Information

1.1. Testing Laboratory

SGS Korea Co., Ltd. (Gunpo Laboratory)

-Wireless Div. 2FL, 10-2, LS-ro 182beon-gil, Gunpo-si, Gyeonggi-do, Korea, 15807

-Designation number: KR0150

All SGS services are rendered in accordance with the applicable SGS conditions of service available on request and accessible at <http://www.sgs.com/en/Terms-and-Conditions.aspx>.

Phone No. : +82 31 688 0901

Fax No. : +82 31 688 0921

1.2. Details of Applicant

Applicant : Hyundai Mobis Co., Ltd.

Address : 203, Teheran-ro, Gangnam-gu, Seoul, South Korea, 06141

Contact Person : Choe, Seung-hoon

Phone No. : +82 31 260 0098

1.3. Details of Manufacturer

Company : Same as applicant

Address : Same as applicant

1.4. Description of EUT

Kind of Product	DIGITAL CAR AVN SYSTEM	
Model Name	FCC : ATC40S8AN IC : ATC40S8KN	
Variant Model Name	FCC : ATC41S8AN IC : ATC41S8KN	
Power Supply	DC 14.4 V	
Frequency Range	2 402 MHz ~ 2 480 MHz (Bluetooth), 2 412 MHz ~ 2 462 MHz (11b/g/n_HT20), 5 745 MHz ~ 5 825 MHz (Band 3: 11a/n_HT20, 11ac_VHT20), 5 755 MHz ~ 5 795 MHz (Band 3: 11n_HT40, 11ac_VHT40), 5 775 MHz (Band 3: 11ac_VHT80), 5 180 MHz ~ 5 240 MHz (Band 1: 11a/n_HT20, 11ac_VHT20), 5 190 MHz ~ 5 230 MHz (Band 1: 11n_HT40, 11ac_VHT40), 5 210 MHz (Band 1: 11ac_VHT80), 5 260 MHz ~ 5 320 MHz (Band 2A: 11a/n_HT20, 11ac_VHT20), 5 270 MHz ~ 5 310 MHz (Band 2A: 11n_HT40, 11ac_VHT40), 5 290 MHz (Band 2A: 11ac_VHT80), 5 500 MHz ~ 5 720 MHz (Band 2C: 11a/n_HT20, 11ac_VHT20), 5 510 MHz ~ 5 710 MHz (Band 2C: 11n_HT40, 11ac_VHT40), 5 530 MHz ~ 5 690 MHz (Band 2C: 11ac_VHT80)	
Modulation Technique	DSSS, OFDM, GFSK, $\pi/4$ DQPSK, 8DPSK	
Number of Channels	79 channel (Bluetooth), 11 channel (11b/g/n_HT20), 5 channel (Band 3: 11a/n_HT20, 11ac_VHT20), 2 channel (Band 3: 11n_HT40, 11ac_VHT40), 1 channel (Band 3: 11ac_VHT80), 4 channel (Band 1: 11a/n_HT20, 11ac_VHT20), 2 channel (Band 1: 11n_HT40, 11ac_VHT40), 1 channel (Band 1: 11ac_VHT80), 4 channel (Band 2A: 11a/n_HT20, 11ac_VHT20), 2 channel (Band 2A: 11n_HT40, 11ac_VHT40), 1 channel (Band 2A: 11ac_VHT80), 9 channel (Band 2C: 11a/n_HT20, 11ac_VHT20), 4 channel (Band 2C: 11n_HT40, 11ac_VHT40), 2 channel (Band 2C: 11ac_VHT80)	
Antenna Type	PCB pattern antenna	
Antenna Gain	Bluetooth	2 400 MHz ~ 2 4835 MHz: 0.29 dB i
	WLAN	2 400 MHz ~ 2 4835 MHz: -0.70 dB i, 5 150 MHz ~ 5 250 MHz: 3.51 dB i, 5 250 MHz ~ 5 350 MHz: 3.12 dB i, 5 470 MHz ~ 5 725 MHz: 2.28 dB i, 5 725 MHz ~ 5 850 MHz: -0.84 dB i

The results shown in this test report refer only to the sample(s) tested unless otherwise stated. This test report cannot be reproduced, except in full, without prior written permission of the Company. This test report does not assure KOLAS accreditation.

1.5. Declaration by the Manufacturer

- Adaptive Frequency Hopping is supported and use at least 20 channels.

1.6. Information about the FHSS characteristics:

1.6.1. Pseudorandom Frequency Hopping Sequence

The channel is represented by a pseudo-random hopping sequence hopping through the 79 RF channels. The hopping sequence is unique for the piconet and is determined by the Bluetooth device address of the master; the phase in the hopping sequence is determined by the Bluetooth clock of the master. The channel is divided into time slots where each slot corresponds to an RF hop frequency. Consecutive hops correspond to different RF hop frequencies. The nominal hop rate is 1 600 hops/s.

1.6.2. Equal Hopping Frequency Use

The channels of this system will be used equally over the long-term distribution of the hopsets.

1.6.3. Example of a 79 hopping sequence in data mode:

02, 05, 31, 24, 20, 10, 43, 36, 30, 23, 40, 06, 21, 50, 44, 09, 71, 78, 01, 13, 73, 07, 70, 72, 35, 62, 42, 11, 41, 08, 16, 29, 60, 15, 34, 61, 58, 04, 67, 12, 22, 53, 57, 18, 27, 76, 39, 32, 17, 77, 52, 33, 56, 46, 37, 47, 64, 49, 45, 38, 69, 14, 51, 26, 79, 19, 28, 65, 75, 54, 48, 03, 25, 66, 05, 16, 68, 74, 59, 63, 55

1.6.4. System Receiver Input Bandwidth

Each channel bandwidth is 1 MHz.

The system receivers have input bandwidths that match the hopping channel bandwidths of their corresponding transmitters and shift frequencies in synchronization with the transmitted signals.

1.6.5. Equipment Description

15.247(a)(1) that the Rx input bandwidths shift frequencies in synchronization with the transmitted signals.

15.247(g): In accordance with the Bluetooth Industry Standard, the system is designed to comply with all of the regulations in Section 15.247 when the transmitter is presented with a continuous data (or information) system.

15.247(h): In accordance with the Bluetooth Industry Standard, the system does not coordinate its channels selection/ hopping sequence with other frequency hopping systems for the express purpose of avoiding the simultaneous occupancy of individual hopping frequencies by multiple transmitters.

The results shown in this test report refer only to the sample(s) tested unless otherwise stated. This test report cannot be reproduced, except in full, without prior written permission of the Company. This test report does not assure KOLAS accreditation.

1.7. Test Equipment List

Equipment	Manufacturer	Model	S/N	Cal. Date	Cal. Interval	Cal. Due
Signal Generator	R&S	SMR40	100272	Jun. 12, 2018	Annual	Jun. 12, 2019
Signal Generator	R&S	SMBV100A	255834	Jun. 15, 2018	Annual	Jun. 15, 2019
Spectrum Analyzer	R&S	FSV30	103102	Jun. 11, 2018	Annual	Jun. 11, 2019
Spectrum Analyzer	Agilent	N9020A	MY53421758	Sep. 21, 2018	Annual	Sep. 21, 2019
Bluetooth Tester	TESCOM	TC-3000C	3000C000296	Jun. 12, 2018	Annual	Jun. 12, 2019
Directional Coupler	KRYTAR	152613	122660	Jun. 14, 2018	Annual	Jun. 14, 2019
Coaxial Fixed Attenuator	Agilent	8491A-006	MY39264893	Jan. 15, 2018	Annual	Jan. 15, 2019
High Pass Filter	Wainwright Instrument GmbH	WHK3.0/18G-10SS	344	May 27, 2018	Annual	May 27, 2019
High Pass Filter	Wainwright Instrument GmbH	WHNX7.5/26.5G-6SS	15	Jun. 11, 2018	Annual	Jun. 11, 2019
Low Pass Filter	Mini-Circuits	NLP-1200+	V 8979400903-1	May 24, 2018	Annual	May 24, 2019
Power Sensor	R&S	NRP-Z81	100748	Jun. 12, 2018	Annual	Jun. 12, 2019
DC Power Supply	Agilent	U8002A	MY50060028	Mar. 15, 2018	Annual	Mar. 15, 2019
Preamplifier	H.P.	8447F	2944A03909	Aug. 07, 2018	Annual	Aug. 07, 2019
Signal Conditioning Unit	R&S	SCU-18	10117	Aug. 07, 2018	Annual	Aug. 07, 2019
Preamplifier	MITEQ Inc.	JS44-18004000-35-8P	1546891	May 13, 2018	Annual	May 13, 2019
Loop Antenna	Schwarzbeck Mess-Elektronik	FMZB 1519	1519-039	Aug. 23, 2017	Biennial	Aug. 23, 2019
Bilog Antenna	Schwarzbeck Mess-Elektronik	VULB 9163	01126	Mar. 26, 2018	Biennial	Mar. 26, 2020
Horn Antenna	R&S	HF906	100326	Feb. 14, 2018	Biennial	Feb. 14, 2020
Horn Antenna	Schwarzbeck Mess-Elektronik	BBHA 9170	BBHA9170431	Sep. 10, 2018	Biennial	Sep. 10, 2020
Antenna Master	INNCO systems GmbH	MA4640-XP-ET	MA4640/536/383 30516/L	N.C.R.	N/A	N.C.R.
Controller	INNCO systems GmbH	CONTROLLER CO3000-4P	CO3000/963/383 30516/L	N.C.R.	N/A	N.C.R.
Turn Table	INNCO systems GmbH	DS 1200 S	N/A	N.C.R.	N/A	N.C.R.
Test Receiver	R&S	ESU26	100109	Feb. 07, 2018	Annual	Feb. 07, 2019
Anechoic Chamber	SY Corporation	L x W x H (9.6 m x 6.4 m x 6.6 m)	N/A	N.C.R.	N/A	N.C.R.
Coaxial Cable	SUCOFLEX	104 (3 m)	MY3258414	Jul. 04, 2018	Semi-annual	Jan. 04, 2019
Coaxial Cable	SUCOFLEX	104 (10 m)	MY3145814	Jul. 04, 2018	Semi-annual	Jan. 04, 2019
Coaxial Cable	Rosenberger	LA1-C006-1500	131014 01/20	Sep. 04, 2018	Semi-annual	Mar. 04, 2019
Coaxial Cable	Rosenberger	LA1-C006-1500	131014 05/20	Sep. 04, 2018	Semi-annual	Mar. 04, 2019
Coaxial Cable	Rosenberger	LA1-C006-1500	131014 10/20	Sep. 04, 2018	Semi-annual	Mar. 04, 2019

The results shown in this test report refer only to the sample(s) tested unless otherwise stated. This test report cannot be reproduced, except in full, without prior written permission of the Company. This test report does not assure KOLAS accreditation.

1.8. Summary of Test Results

The EUT has been tested according to the following specifications:

APPLIED STANDARD: FCC Part15 Subpart C, RSS-247 Issue 2, RSS-Gen Issue 5			
Section		Test Item	Result
15.205(a) 15.209 15.247(d)	RSS-247 Issue 2 5.5 RSS-Gen Issue 5 8.9	Transmitter Radiated Spurious Emissions and Conducted Spurious Emission	Complied
15.247(a)(1)	RSS-247 Issue 2 5.1(b) RSS-Gen Issue 5 6.7	20 dB Bandwidth and 99 % Bandwidth	Complied
15.247(b)(1)	RSS-247 Issue 2 5.1(b) 5.4(b)	Maximum Peak Conducted Output Power	Complied
15.247(a)(1)	RSS-247 Issue 2 5.1(b)	Carrier Frequency Separation	Complied
15.247(a)(1)(iii)	RSS-247 Issue 2 5.1(d)	Number of Hopping Frequencies	Complied
15.247(a)(1)(iii)	RSS-247 Issue 2 5.1(d)	Time of Occupancy (Dwell Time)	Complied

1.9. Test Report Revision

Revision	Report number	Date of Issue	Description
0	F690501/RF-RTL013162	2018.11.27	Initial

1.10. Test Procedure(s)

The measurement procedures described in the American National Standard of Procedure for Compliance Testing of Unlicensed Wireless Devices (ANSI C63.10-2013) is used in the measurement of the DUT.

1.11. Sample Calculation

Where relevant, the following sample calculation is provided:

1.11.1. Conducted Test

Offset value (dB) = Directional coupler (dB) + Cable loss (dB)

1.11.2. Radiation Test

Field strength level (dB μ V/m) = Measured level (dB μ V) + Antenna factor (dB) + Cable loss (dB) - Amplifier gain (dB)

The results shown in this test report refer only to the sample(s) tested unless otherwise stated. This test report cannot be reproduced, except in full, without prior written permission of the Company. This test report does not assure KOLAS accreditation.

1.12. Measurement Uncertainty

Where relevant, the following measurement uncertainty levels have been estimated for tests performed on the apparatus:

Parameter	Uncertainty (dB)
Radiated Disturbance, 9 kHz to 30 MHz	± 3.59
Radiated Disturbance, below 1 GHz	± 5.88
Radiated Disturbance, above 1 GHz	± 5.94

Uncertainty figures are valid to a confidence level of 95 %.

1.13. Information of Variant Model

Model Name		Description
FCC basic model	ATC40S8AN	- Basic Model
FCC variant model	ATC41S8AN	- Same to basic model, but software is difference depending on the type of vehicle.
IC basic model	ATC40S8KN	- Basic Model
IC variant model	ATC41S8KN	- Same to basic model, but software is difference depending on the type of vehicle.

The results shown in this test report refer only to the sample(s) tested unless otherwise stated. This test report cannot be reproduced, except in full, without prior written permission of the Company. This test report does not assure KOLAS accreditation.

1.14. Descriptions of Test Mode

Preliminary tests were performed in different data rates and recorded the RF output power in the following table:

Operation Mode	Data Rate (Mbps)	Channel	Frequency (MHz)	RF Output Power (dB m)
GFSK	1	Low	2 402	3.44
		Middle	2 441	<u>4.07</u>
		High	2 480	3.66
$\pi/4$ DQPSK	2	Low	2 402	0.59
		Middle	2 441	<u>1.66</u>
		High	2 480	1.58
8DPSK	3	Low	2 402	0.78
		Middle	2 441	<u>1.83</u>
		High	2 480	1.63

Note;

1. For transmitter radiated spurious emissions, conducted spurious emission, carrier frequency separation and number of hopping frequencies, GFSK / DH5 and 8DPSK / 3DH5 are tested as worst condition.
2. For 20 dB bandwidth and maximum peak conducted output power, GFSK / DH5, $\pi/4$ DQPSK / 2DH5 and 8DPSK / 3DH5 are tested as worst condition.
3. For Time of Occupancy, GFSK / DH1, DH3, DH5 and 8DPSK / 3DH1, 3DH3, 3DH5 are tested as worst condition.

The results shown in this test report refer only to the sample(s) tested unless otherwise stated. This test report cannot be reproduced, except in full, without prior written permission of the Company. This test report does not assure KOLAS accreditation.

2. Transmitter Radiated Spurious Emissions and Conducted Spurious Emission

2.1. Test Setup

2.1.1. Transmitter Radiated Spurious Emissions

The diagram below shows the test setup that is utilized to make the measurements for emission from 9 kHz to 30 MHz.

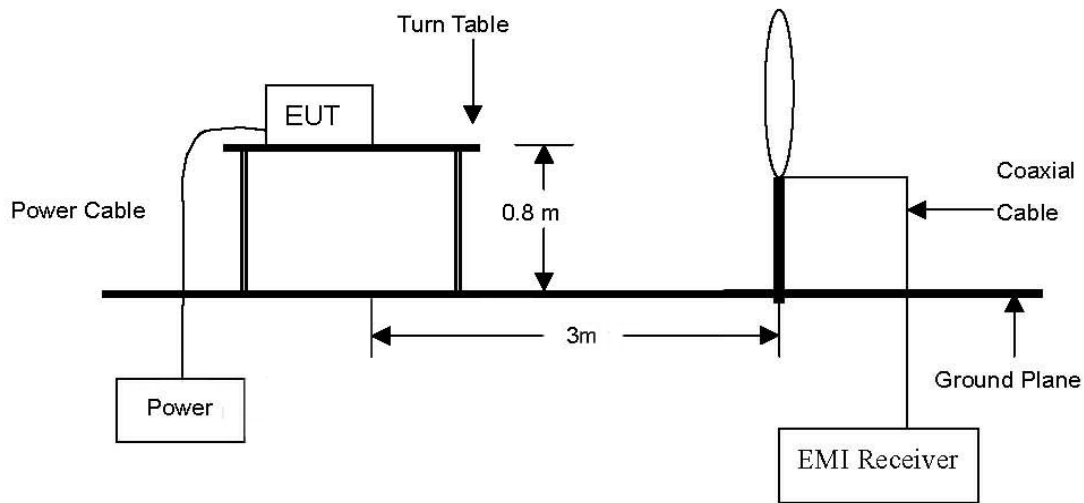

The diagram below shows the test setup that is utilized to make the measurements for emission from 30 MHz to 1 GHz.

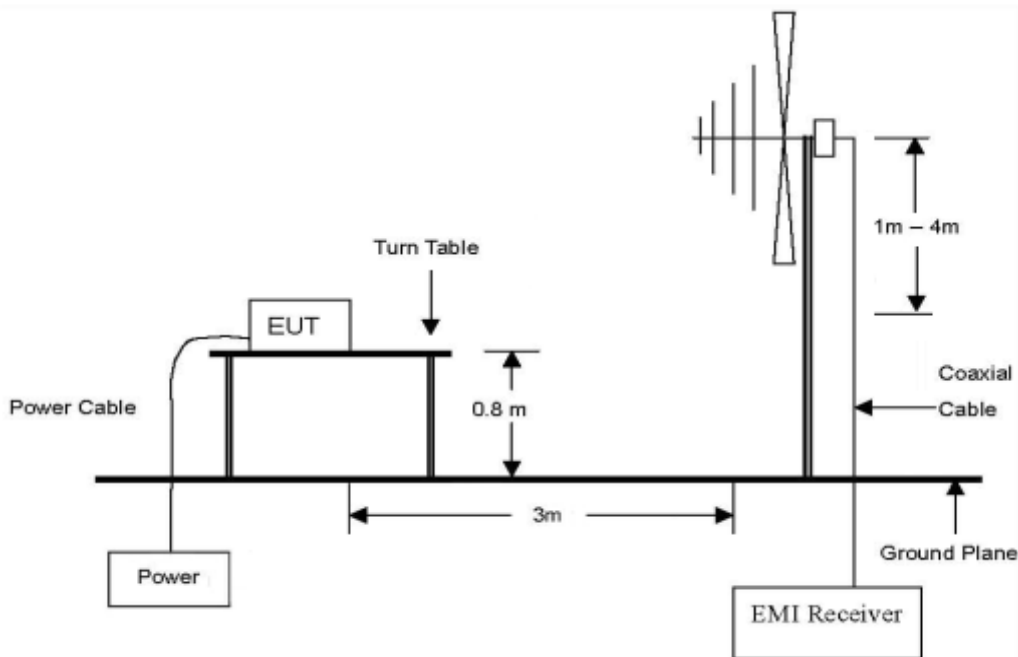

The results shown in this test report refer only to the sample(s) tested unless otherwise stated. This test report cannot be reproduced, except in full, without prior written permission of the Company. This test report does not assure KOLAS accreditation.

The diagram below shows the test setup that is utilized to make the measurements for emission. The spurious emissions were investigated from 1 GHz to the 10th harmonic of the highest fundamental frequency or 40 GHz, whichever is lower.

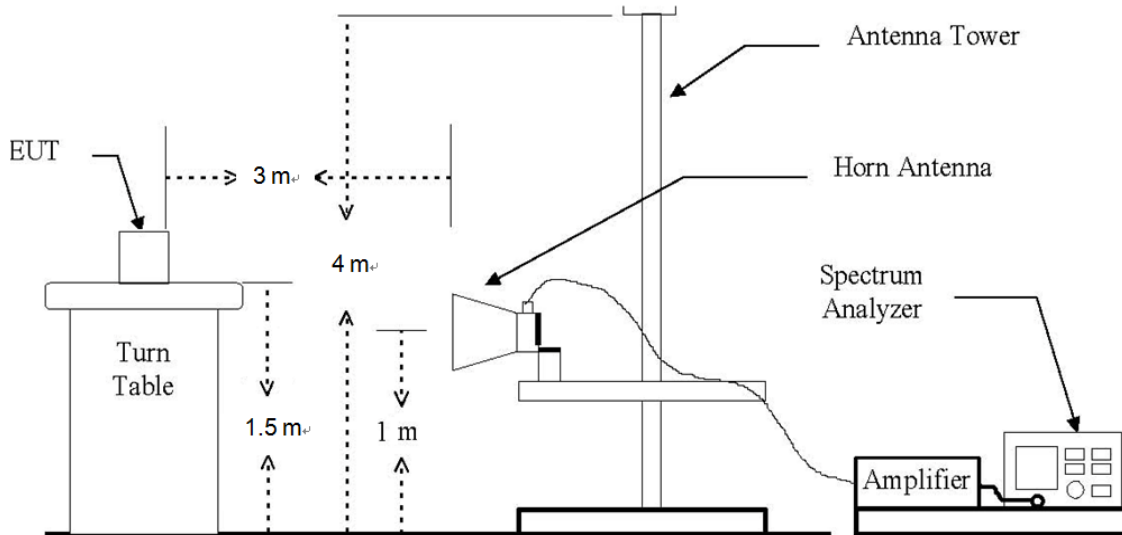

The results shown in this test report refer only to the sample(s) tested unless otherwise stated. This test report cannot be reproduced, except in full, without prior written permission of the Company. This test report does not assure KOLAS accreditation.

2.1.2. Conducted Spurious Emissions

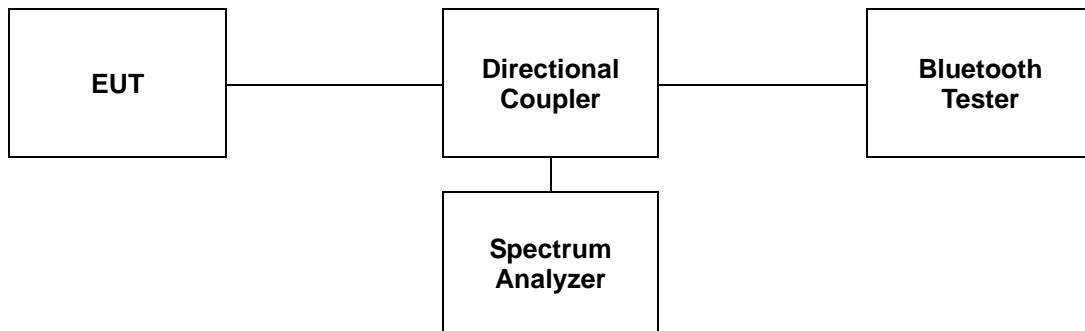

2.2. Limit

2.2.1. FCC

According to §15.247(d), in any 100 kHz bandwidth outside the frequency band in which the spread spectrum or digitally modulated intentional radiator is operating, the radio frequency power that is produced by the intentional radiator shall be at least 20 dB below that in the 100 kHz bandwidth within the band that contains the highest level of the desired power, based on either an RF conducted or a radiated measurement, provided the transmitter demonstrates compliance with the peak conducted power limits. If the transmitter complies with the conducted power limits based on the use of RMS averaging over a time interval, as permitted under paragraph (b)(3) of this section, the attenuation required under this paragraph shall be 30 dB instead of 20 dB. Attenuation below the general limits specified in section §15.209(a) is not required. In addition, radiated emission which fall in the restricted bands, as defined in section §15.205(a), must also comply with the radiated emission limits specified in section §15.209(a) (see §15.205(c)).

According to §15.209(a), except as provided elsewhere in this subpart, the emissions from an intentional radiator shall not exceed the field strength levels specified in the following table:

Frequency (MHz)	Field Strength (µV/m)	Measurement Distance (Meters)
0.009-0.490	2 400/F(kHz)	300
0.490-1.705	24 000/F(kHz)	30
1.705-30.0	30	30
30-88	100**	3
88-216	150**	3
216-960	200**	3
Above 960	500	3

** Except as provided in paragraph (g), fundamental emissions from intentional radiators operating under this section shall not be located in the frequency bands 54-72 MHz, 76-88 MHz, 174-216 MHz or 470-806 MHz. However, operation within these frequency bands is permitted under other sections of this part, e.g., §§15.231 and 15.241.

The results shown in this test report refer only to the sample(s) tested unless otherwise stated. This test report cannot be reproduced, except in full, without prior written permission of the Company. This test report does not assure KOLAS accreditation.

2.2.2. IC

According to RSS-247 Issue 2, 5.5, in any 100 kHz bandwidth outside the frequency band in which the spread spectrum or digitally modulated device is operating, the RF power that is produced shall be at least 20 dB below that in the 100 kHz bandwidth within the band that contains the highest level of the desired power, based on either an RF conducted or a radiated measurement, provided that the transmitter demonstrates compliance with the peak conducted power limits. If the transmitter complies with the conducted power limits based on the use of root-mean-square averaging over a time interval, as permitted under section 5.4(d), the attenuation required shall be 30 dB instead of 20 dB. Attenuation below the general field strength limits specified in RSS-Gen is not required.

According to RSS-Gen Issue 5, 8.9, except where otherwise indicated in the applicable RSS, radiated emissions shall comply with the field strength limits shown in table 5 and table 6. Additionally, the level of any transmitter unwanted emission shall not exceed the level of the transmitter's fundamental emission.

Table 5 – General Field Strength Limits at frequencies above 30 MHz

Frequency (MHz)	Field Strength ($\mu\text{V}/\text{m}$ at 3 m)
30-88	100
88-216	150
216-960	200
Above 960	500

Table 6 – General Field Strength Limits at frequencies below 30 MHz

Frequency	Magnetic Field Strength (H-Field) ($\mu\text{A}/\text{m}$)	Measurement Distance (meters)
9-490 kHz ¹	6.37/F (F in kHz)	300
490-1 705 kHz	63.7/F (F in kHz)	30
1.705-30 MHz	0.08	30

Note¹: The emission limits for the ranges 9-90 kHz and 110-490 kHz are based on measurements employing a linear average detector.

The results shown in this test report refer only to the sample(s) tested unless otherwise stated. This test report cannot be reproduced, except in full, without prior written permission of the Company. This test report does not assure KOLAS accreditation.

2.3. Test Procedures

Radiated emissions from the EUT were measured according to the dictates of ANSI C63.10-2013.

2.3.1. Test Procedures for emission below 30 MHz

1. The EUT was placed on the top of a rotating table 0.8 meters above the ground at a 3 meter anechoic chamber test site. The table was rotated 360 degrees to determine the position of the highest radiation.
2. Then antenna is a loop antenna is fixed at one meter above the ground to determine the maximum value of the field strength. Both parallel and perpendicular of the antenna are set to make the measurement.
3. For each suspected emission, the EUT was arranged to its worst case and then the table was turned from 0 degrees to 360 degrees to find the maximum reading.
4. The test-receiver system was set to average or quasi peak detect function and Specified Bandwidth with Maximum Hold Mode.

2.3.2. Test Procedures for emission from above 30 MHz

1. The EUT was placed on the top of a rotating table 0.8 meters above the ground at a 3 meter anechoic chamber test site below 1 GHz and 1.5 meter above the ground at a 3 meter anechoic chamber test site above 1 GHz. The table was rotated 360 degrees to determine the position of the highest radiation.
2. During performing radiated emission below 1 GHz, the EUT was set 3 meters away from the interference receiving antenna, which was mounted on the top of a variable-height antenna tower. During performing radiated emission above 1 GHz, the EUT was set 3 meter away from the interference-receiving antenna.
3. The antenna is a bi-log antenna, a horn antenna and its height is varied from one meter to four meters above the ground to determine the maximum value of the field strength. Both horizontal and vertical polarizations of the antenna are set to make the measurement.
4. For each suspected emission, the EUT was arranged to its worst case and then the antenna was tuned to heights from 1 meter to 4 meters and the table was turned from 0 degrees to 360 degrees to find the maximum reading.
5. The test-receiver system was set to Peak Detect Function and Specified Bandwidth with Maximum Hold Mode.
6. If the emission level of the EUT in peak mode was 10 dB lower than the limit specified, then testing could be stopped and the peak values of the EUT would be reported. Otherwise the emissions that did not have 10 dB margin would be re-tested one by one using peak, quasi-peak or average method as specified and then reported in a data sheet.

Note;

1. The resolution bandwidth and video bandwidth of test receiver/spectrum analyzer is 120 kHz for Peak detection (PK) and Quasi-peak detection (QP) at frequency below 1 GHz.
2. For frequency above 1 GHz, set spectrum analyzer detector to peak, and resolution bandwidth is 1 MHz and video bandwidth is 3 MHz.
3. Definition of DUT Axis.
Definition of the test orthogonal plan for EUT was described in the test setup photo.
The test orthogonal plan of EUT is **X - axis** during radiation test.

The results shown in this test report refer only to the sample(s) tested unless otherwise stated. This test report cannot be reproduced, except in full, without prior written permission of the Company. This test report does not assure KOLAS accreditation.

2.3.3. Test Procedures for Conducted Spurious Emissions

2.3.3.1. Band-edge Compliance of RF Conducted Emissions

The transmitter output was connected to the spectrum analyzer.

Span = wide enough to capture the peak level of the emission operating on the channel closest to the band edge, as well as any modulation products which fall outside of the authorized band of operation.

RBW = 100 kHz

VBW = 300 kHz

Sweep = auto

Detector function = peak

Trace = max hold

2.3.3.2. Spurious RF Conducted Emissions

The transmitter output was connected to the spectrum analyzer.

RBW = 1 MHz

VBW = 3 MHz

Sweep = auto

Detector function = peak

Trace = max hold

2.3.3.3. TDF function

- For plots showing conducted spurious emissions from 9 kHz to 25 GHz, all path loss of wide frequency range was investigated and compensated to spectrum analyzer as TDF function.

So, the reading values shown in plots were final result.

The results shown in this test report refer only to the sample(s) tested unless otherwise stated. This test report cannot be reproduced, except in full, without prior written permission of the Company. This test report does not assure KOLAS accreditation.

2.4. Test Results

Ambient temperature : (23 ± 1) °C
 Relative humidity : 47 % R.H.

2.4.1. Radiated Spurious Emission below 1 000 MHz

The frequency spectrum from 9 kHz to 1 000 MHz was investigated. All reading values are peak values.

Radiated Emissions			Ant.	Correction Factors		Total	Limit	
Frequency (MHz)	Reading (dBμV)	Detect Mode	Pol.	AF (dB/m)	AMP + CL (dB)	Actual (dBμV/m)	Limit (dBμV/m)	Margin (dB)
201.29	38.60	Peak	V	11.17	-25.36	24.41	43.50	19.09
340.68	41.10	Peak	H	14.91	-25.22	30.79	46.00	15.21
486.71	44.30	Peak	H	17.13	-24.66	36.77	46.00	9.23
Above 500.00	Not detected	-	-	-	-	-	-	-

Remark;

1. Spurious emissions for all channels and modes were investigated and almost the same below 1 GHz.
2. Reported spurious emissions are in **BDR / DH5 / Middle channel** as worst case among other modes.
3. Radiated spurious emission measurement as below.
(Actual = Reading + AF + AMP + CL)
4. According to §15.31(o), emission levels are not report much lower than the limits by over 20 dB.

- Test plot

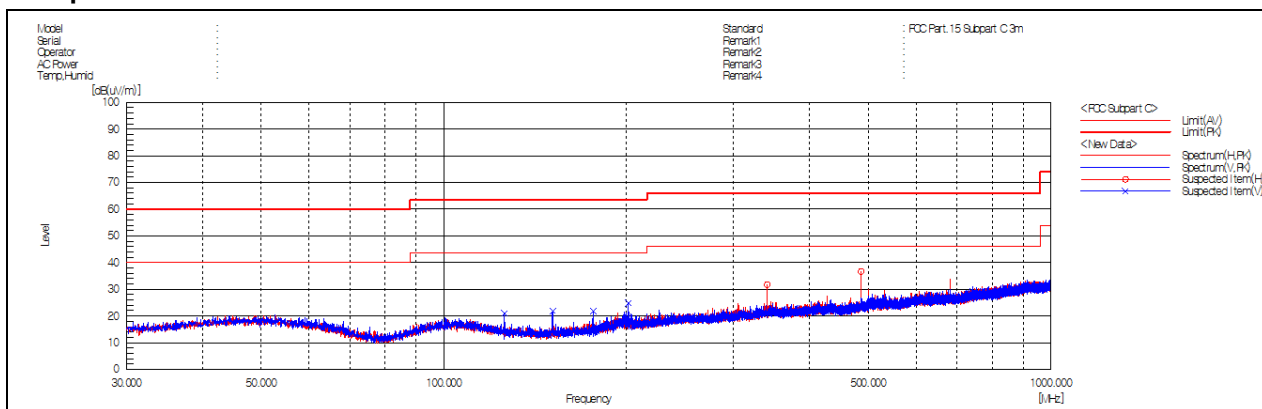

The results shown in this test report refer only to the sample(s) tested unless otherwise stated. This test report cannot be reproduced, except in full, without prior written permission of the Company. This test report does not assure KOLAS accreditation.

2.4.2. Radiated Spurious Emission above 1 000 MHz

The frequency spectrum above 1 000 MHz was investigated. All reading values are peak and average values.

Operating Mode: GFSK (1 Mbps)

A. Low Channel (2 402 MHz)

Radiated Emissions			Ant.	Correction Factors		Total	Limit	
Frequency (MHz)	Reading (dB μ V)	Detect Mode	Pol.	AF (dB/m)	AMP+CL (dB)	Actual (dB μ V/m)	Limit (dB μ V/m)	Margin (dB)
Above 1 000.00	Not detected	-	-	-	-	-	-	-

B. Middle Channel (2 441 MHz)

Radiated Emissions			Ant.	Correction Factors		Total	Limit	
Frequency (MHz)	Reading (dB μ V)	Detect Mode	Pol.	AF (dB/m)	AMP+CL (dB)	Actual (dB μ V/m)	Limit (dB μ V/m)	Margin (dB)
Above 1 000.00	Not detected	-	-	-	-	-	-	-

C. High Channel (2 480 MHz)

Radiated Emissions			Ant.	Correction Factors		Total	Limit	
Frequency (MHz)	Reading (dB μ V)	Detect Mode	Pol.	AF (dB/m)	AMP+CL (dB)	Actual (dB μ V/m)	Limit (dB μ V/m)	Margin (dB)
Above 1 000.00	Not detected	-	-	-	-	-	-	-

The results shown in this test report refer only to the sample(s) tested unless otherwise stated. This test report cannot be reproduced, except in full, without prior written permission of the Company. This test report does not assure KOLAS accreditation.

Operating Mode: 8DPSK (3 Mbps)

A. Low Channel (2 402 MHz)

Radiated Emissions			Ant.	Correction Factors		Total	Limit	
Frequency (MHz)	Reading (dB μ V)	Detect Mode	Pol.	AF (dB/m)	AMP+CL (dB)	Actual (dB μ V/m)	Limit (dB μ V/m)	Margin (dB)
Above 1 000.00	Not detected	-	-	-	-	-	-	-

B. Middle Channel (2 441 MHz)

Radiated Emissions			Ant.	Correction Factors		Total	Limit	
Frequency (MHz)	Reading (dB μ V)	Detect Mode	Pol.	AF (dB/m)	AMP+CL (dB)	Actual (dB μ V/m)	Limit (dB μ V/m)	Margin (dB)
Above 1 000.00	Not detected	-	-	-	-	-	-	-

C. High Channel (2 480 MHz)

Radiated Emissions			Ant.	Correction Factors		Total	Limit	
Frequency (MHz)	Reading (dB μ V)	Detect Mode	Pol.	AF (dB/m)	AMP+CL (dB)	Actual (dB μ V/m)	Limit (dB μ V/m)	Margin (dB)
Above 1 000.00	Not detected	-	-	-	-	-	-	-

Remark;

1. “*” means the restricted band.
2. Measuring frequencies from 1 GHz to the 10th harmonic of highest fundamental frequency.
3. Radiated emissions measured in frequency above 1 000 MHz were made with an instrument using peak/average detector mode.
3. Band edge measurement.
Actual = Reading + AF + Atten. + AMP + CL
4. Radiated spurious emission measurement.
Actual = Reading + AF + AMP + CL
5. According to § 15.31(o), emission levels are not reported much lower than the limits by over 20 dB.
6. The maximized peak measured value complies with the average limit, to perform an average measurement is unnecessary.

The results shown in this test report refer only to the sample(s) tested unless otherwise stated. This test report cannot be reproduced, except in full, without prior written permission of the Company. This test report does not assure KOLAS accreditation.

2.4.3. Plot of Conducted Spurious Emissions

Operating Mode: GFSK (1 Mbps)

Low channel

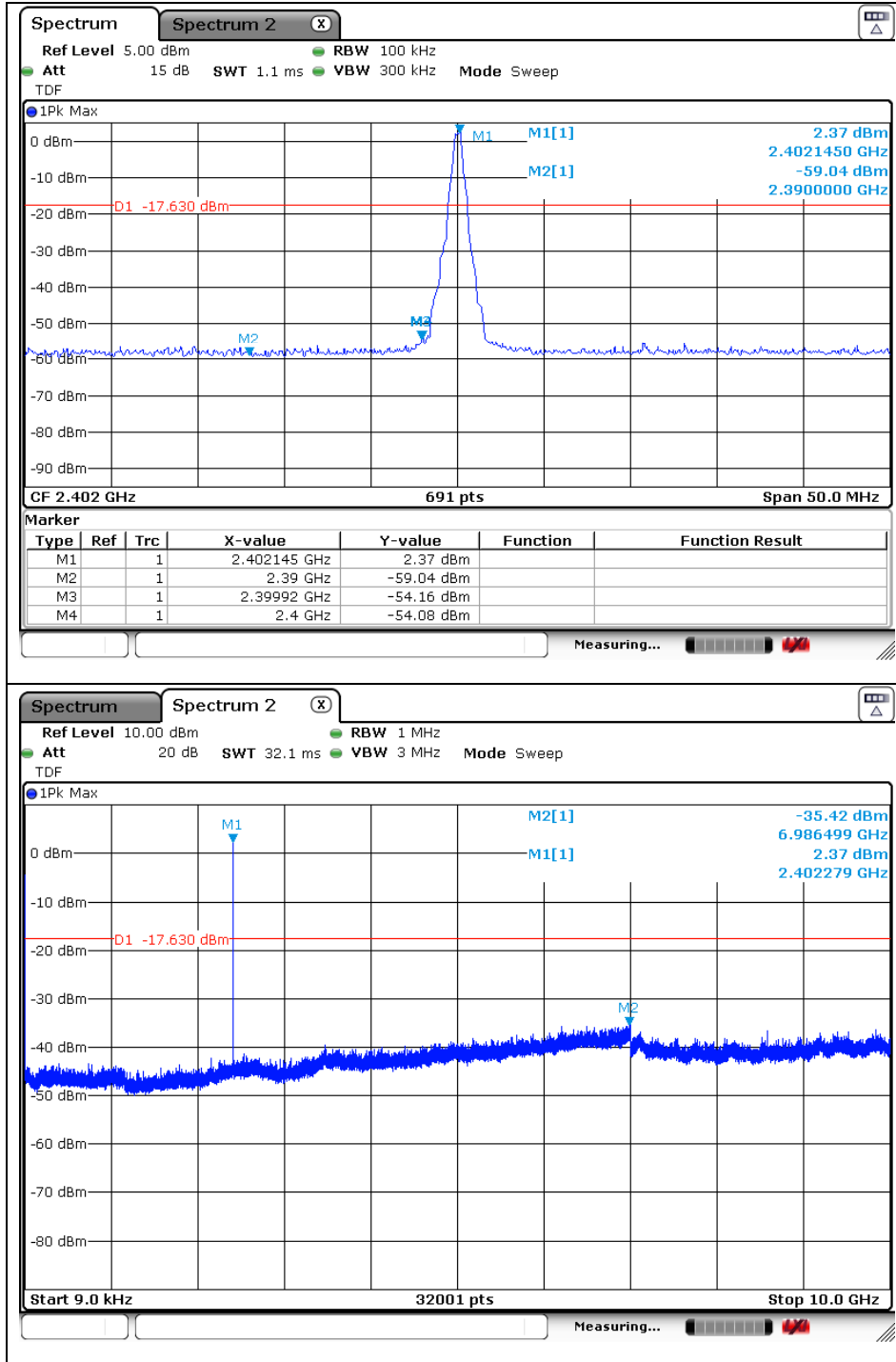

The results shown in this test report refer only to the sample(s) tested unless otherwise stated. This test report cannot be reproduced, except in full, without prior written permission of the Company. This test report does not assure KOLAS accreditation.

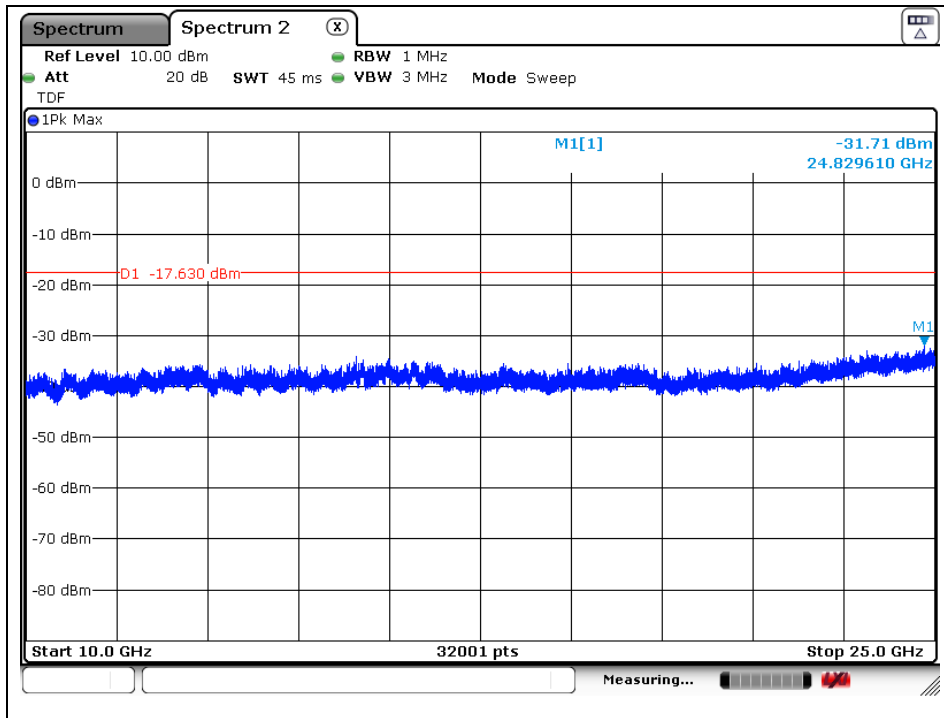

The results shown in this test report refer only to the sample(s) tested unless otherwise stated. This test report cannot be reproduced, except in full, without prior written permission of the Company. This test report does not assure KOLAS accreditation.

Middle channel

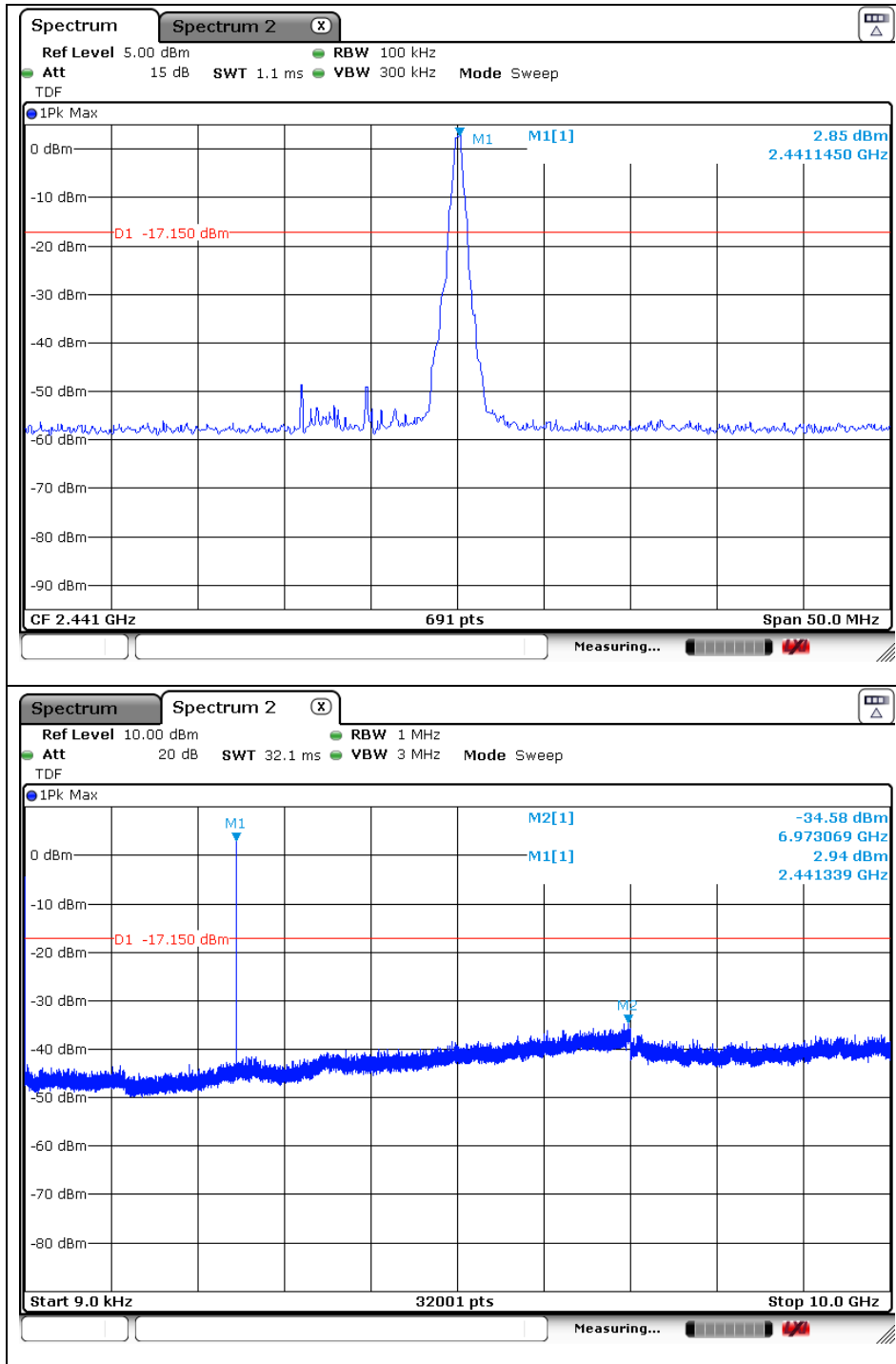

The results shown in this test report refer only to the sample(s) tested unless otherwise stated. This test report cannot be reproduced, except in full, without prior written permission of the Company. This test report does not assure KOLAS accreditation.

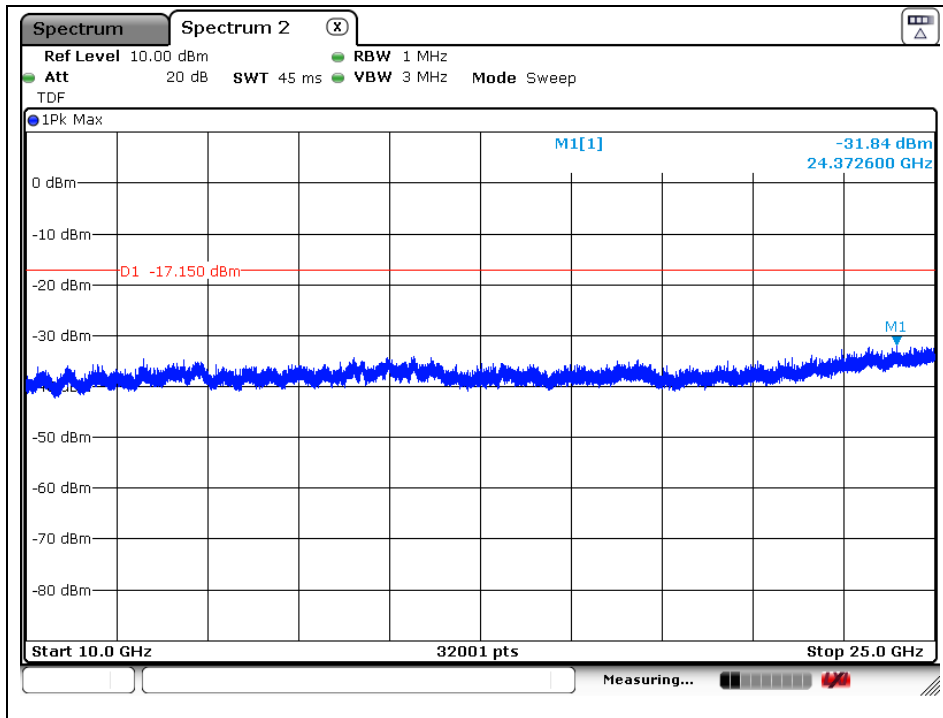

The results shown in this test report refer only to the sample(s) tested unless otherwise stated. This test report cannot be reproduced, except in full, without prior written permission of the Company. This test report does not assure KOLAS accreditation.

High channel

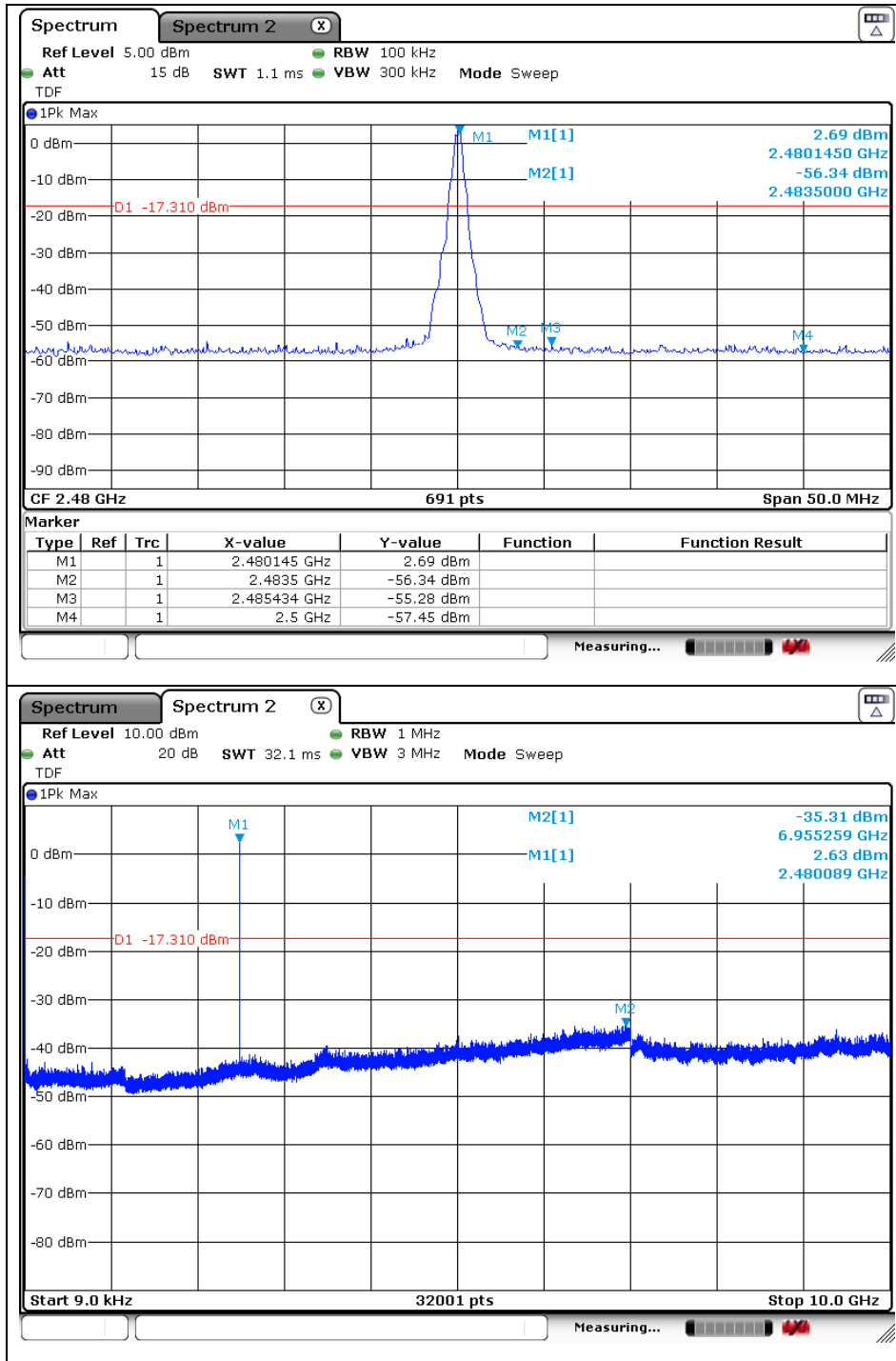

The results shown in this test report refer only to the sample(s) tested unless otherwise stated. This test report cannot be reproduced, except in full, without prior written permission of the Company. This test report does not assure KOLAS accreditation.

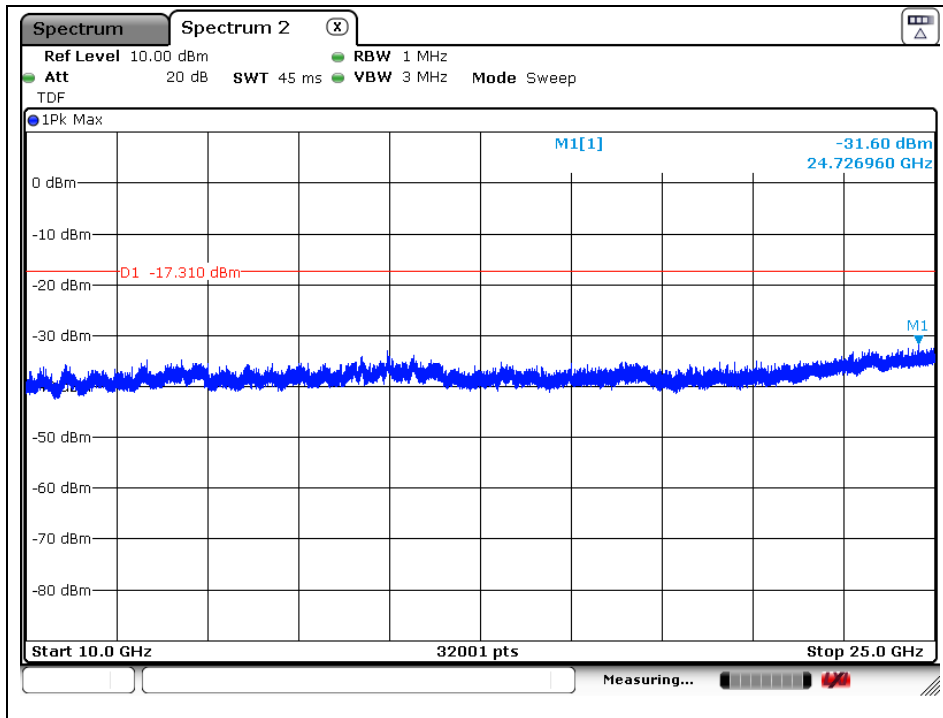

The results shown in this test report refer only to the sample(s) tested unless otherwise stated. This test report cannot be reproduced, except in full, without prior written permission of the Company. This test report does not assure KOLAS accreditation.

Band edge compliance with hopping enabled

Low channel

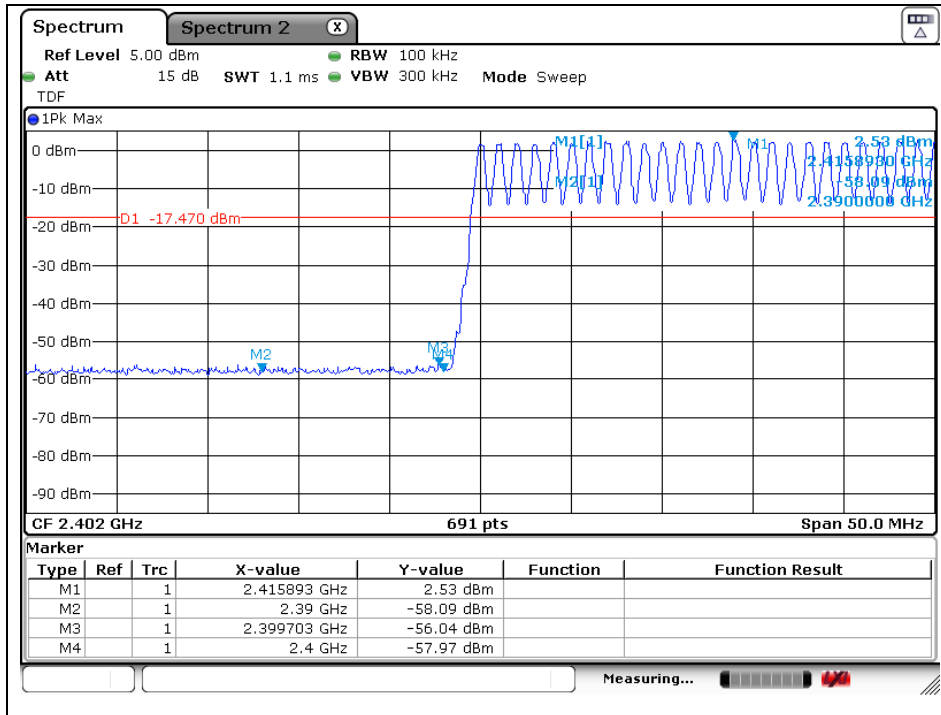

High channel

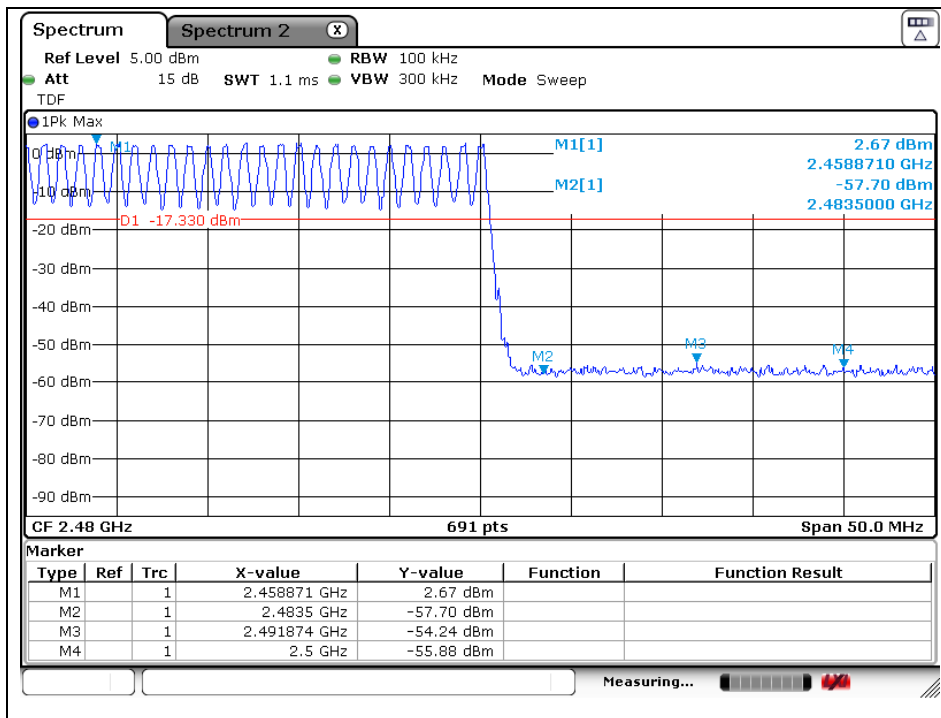

The results shown in this test report refer only to the sample(s) tested unless otherwise stated. This test report cannot be reproduced, except in full, without prior written permission of the Company. This test report does not assure KOLAS accreditation.

Operating Mode: 8DPSK (3 Mbps)

Low channel

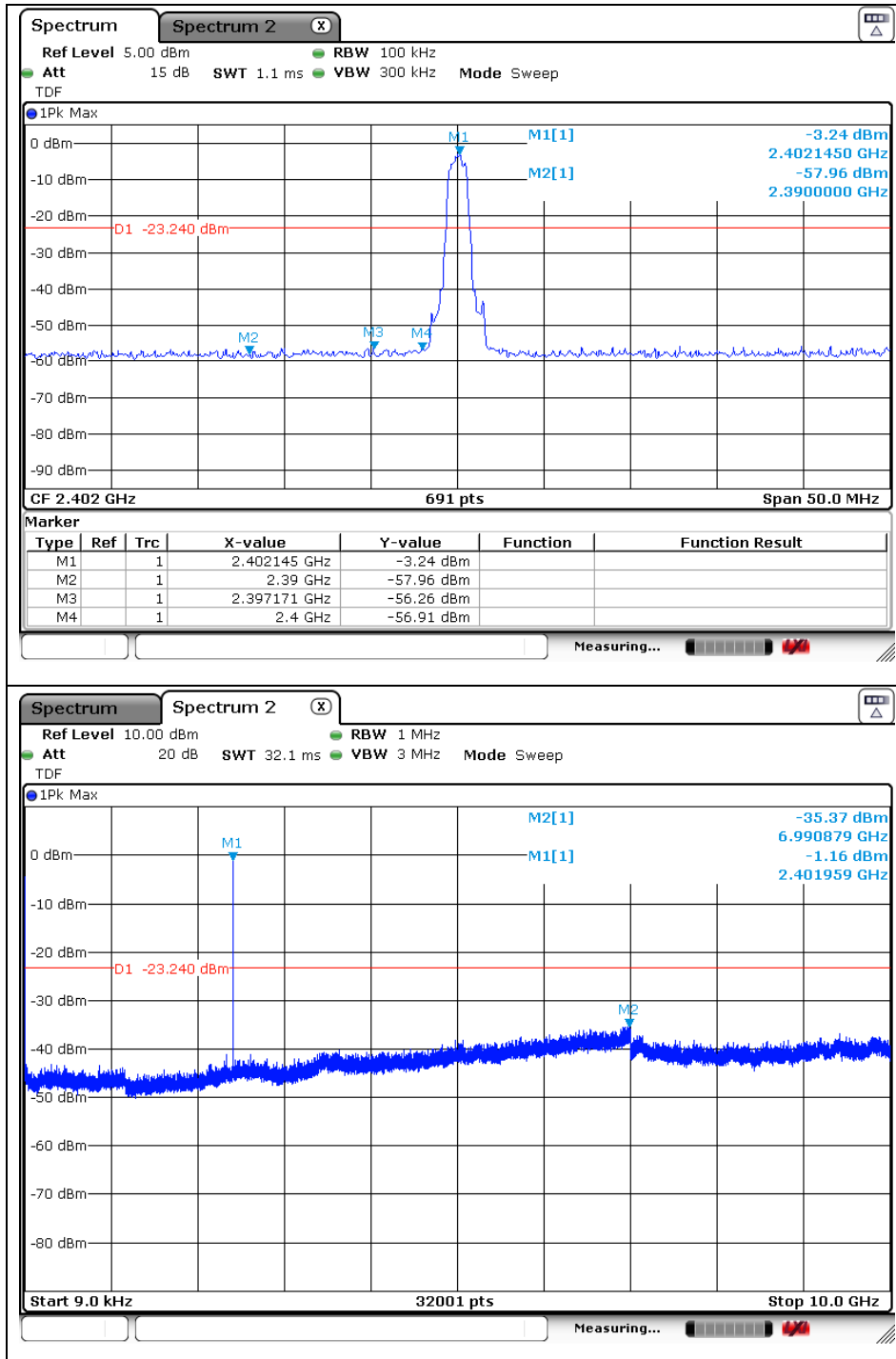

The results shown in this test report refer only to the sample(s) tested unless otherwise stated. This test report cannot be reproduced, except in full, without prior written permission of the Company. This test report does not assure KOLAS accreditation.

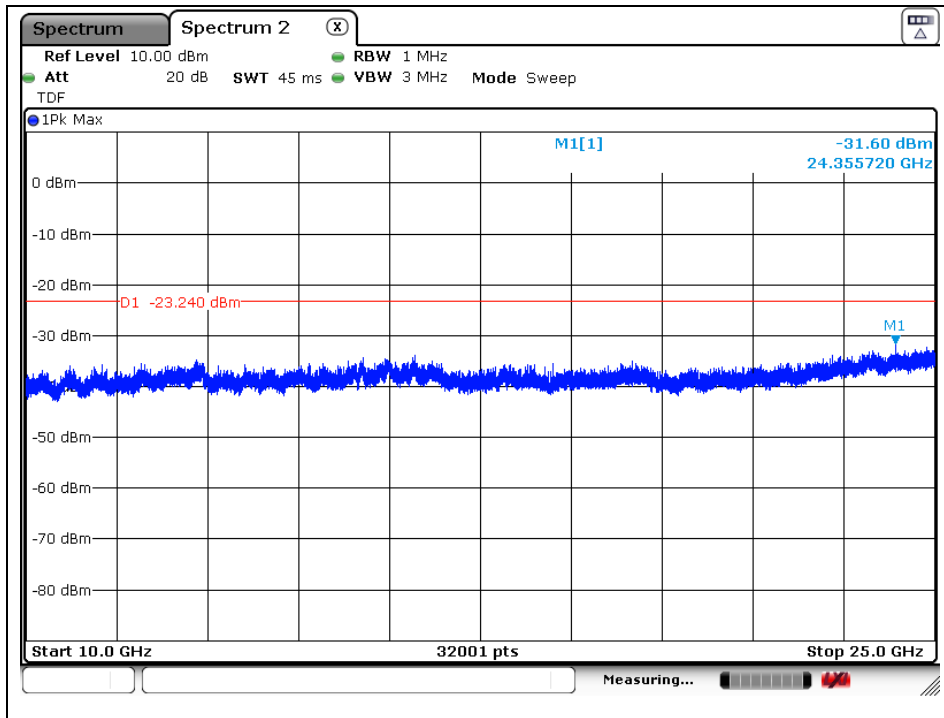

The results shown in this test report refer only to the sample(s) tested unless otherwise stated. This test report cannot be reproduced, except in full, without prior written permission of the Company. This test report does not assure KOLAS accreditation.

Middle channel

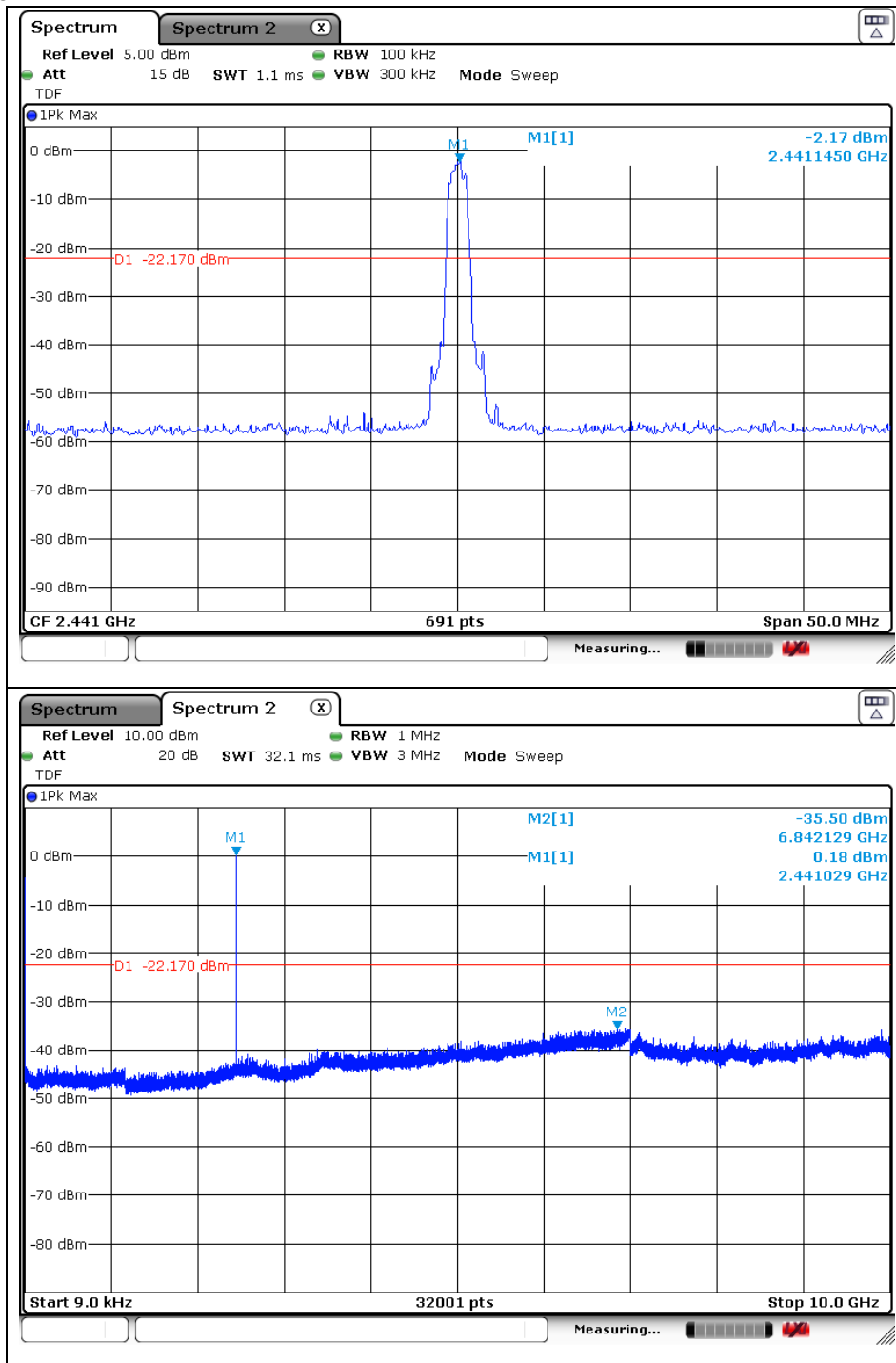

The results shown in this test report refer only to the sample(s) tested unless otherwise stated. This test report cannot be reproduced, except in full, without prior written permission of the Company. This test report does not assure KOLAS accreditation.

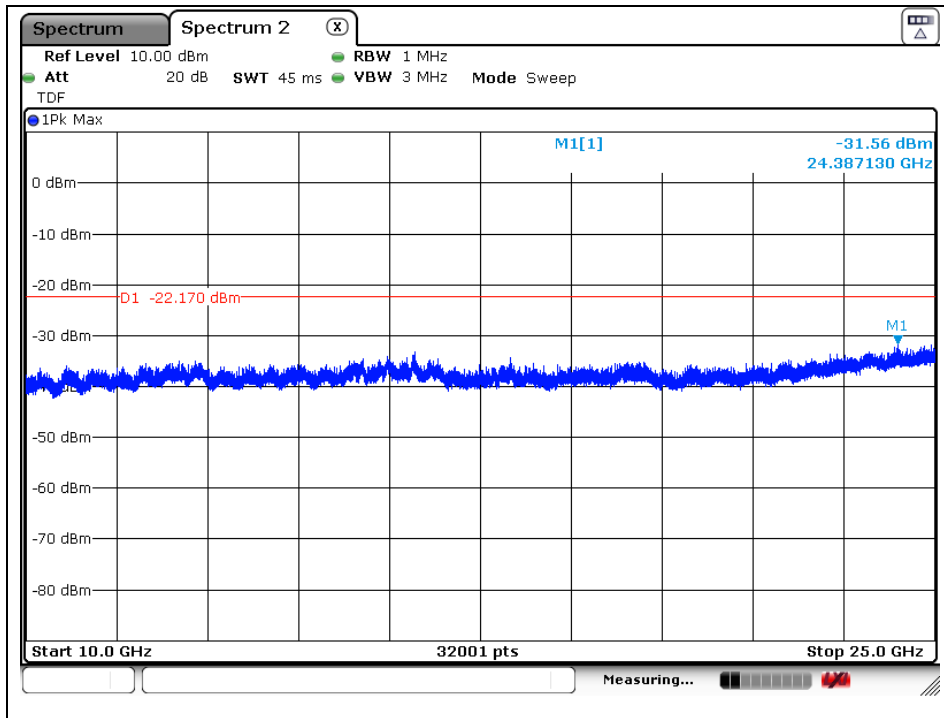

The results shown in this test report refer only to the sample(s) tested unless otherwise stated. This test report cannot be reproduced, except in full, without prior written permission of the Company. This test report does not assure KOLAS accreditation.

High channel

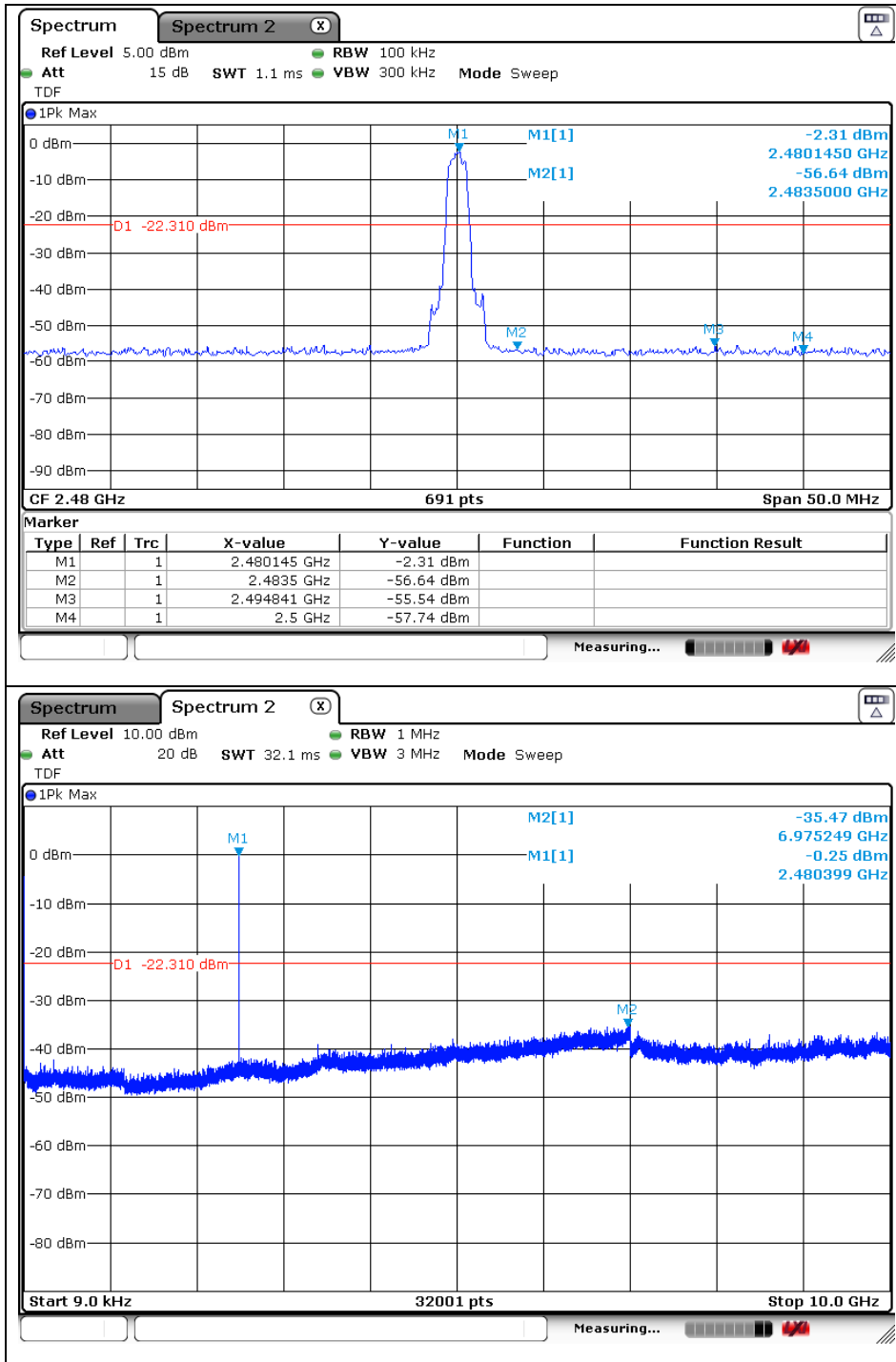

The results shown in this test report refer only to the sample(s) tested unless otherwise stated. This test report cannot be reproduced, except in full, without prior written permission of the Company. This test report does not assure KOLAS accreditation.

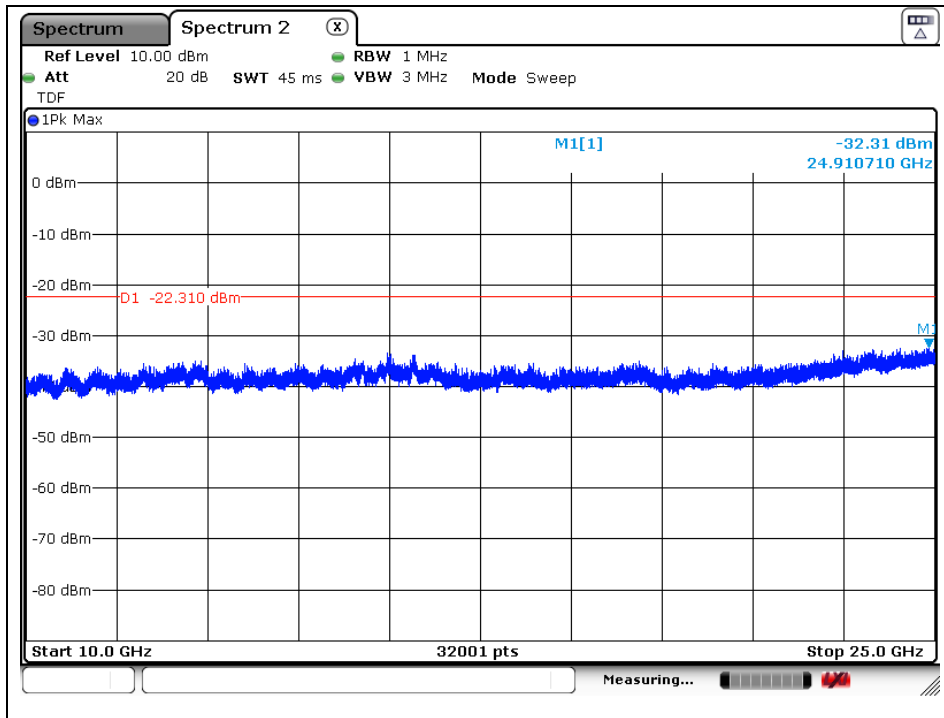

The results shown in this test report refer only to the sample(s) tested unless otherwise stated. This test report cannot be reproduced, except in full, without prior written permission of the Company. This test report does not assure KOLAS accreditation.

Band edge compliance with hopping enabled

Low channel

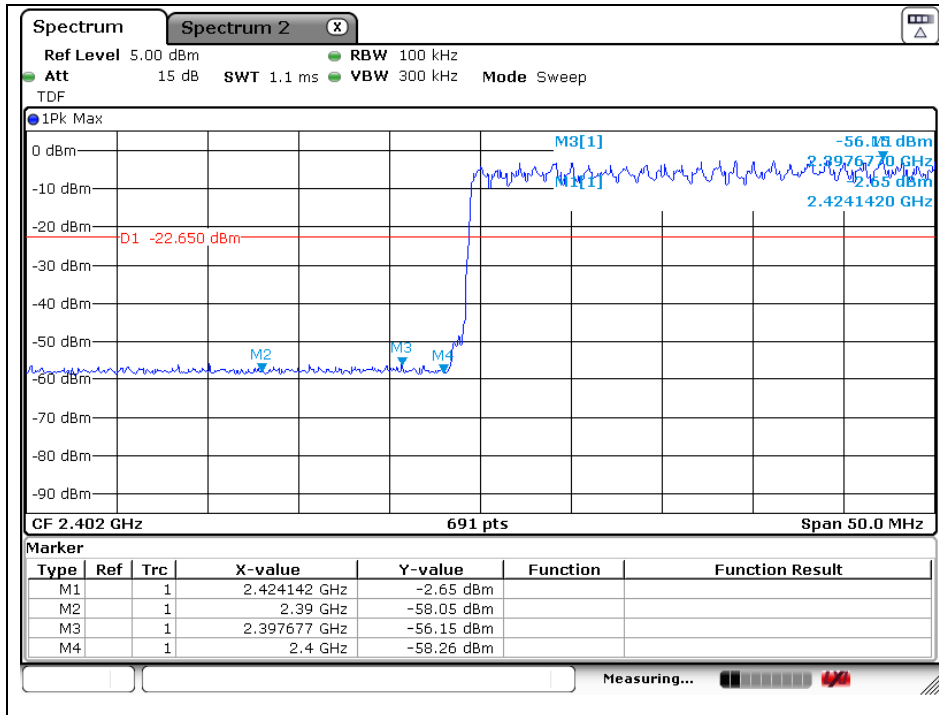

High channel

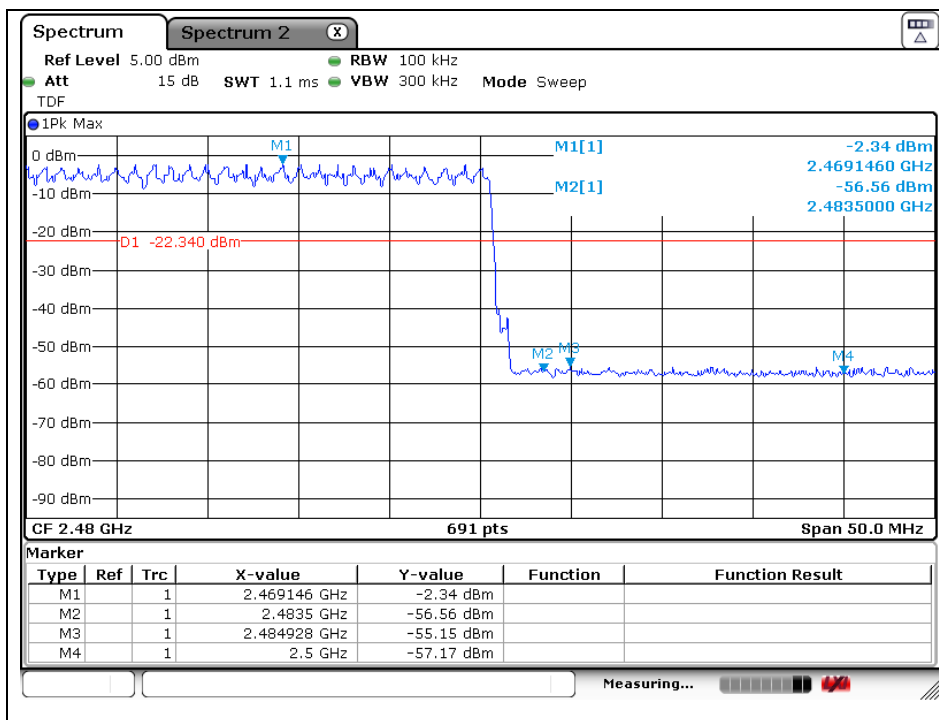

The results shown in this test report refer only to the sample(s) tested unless otherwise stated. This test report cannot be reproduced, except in full, without prior written permission of the Company. This test report does not assure KOLAS accreditation.

3. 20 dB Bandwidth and 99 % Bandwidth

3.1. Test Setup

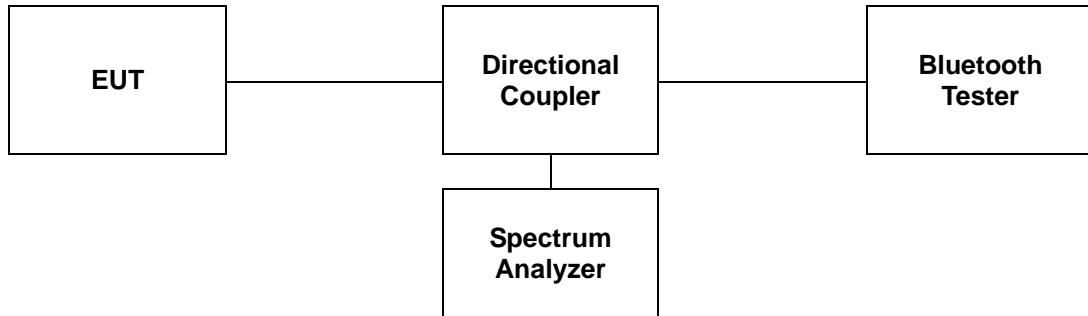

3.2. Limit

Limit: Not Applicable

3.3. Test Procedure

3.3.1. 20 dB Bandwidth

The test follows ANSI C63.10-2013.

The 20 dB bandwidth was measured with a spectrum analyzer connected to RF antenna connector (conducted measurement) while EUT was operating in transmit mode at the appropriate center frequency.

Use the following spectrum analyzer setting:

Span = approximately 2 to 3 times the 20 dB bandwidth, centered on a hopping channel.

RBW \geq 1 % of the 20 dB bandwidth

VBW \geq RBW

Sweep = auto

Detector = peak

Trace = max hold

The marker-to-peak function to set the mark to the peak of the emission. Use the marker-delta function to measure 20 dB down one side of the emission. Reset the function, and move the marker to the other side of the emission, until it is (as close as possible to) even with the reference marker level. The marker-delta reading at this point is 20 dB bandwidth of the emission.

The results shown in this test report refer only to the sample(s) tested unless otherwise stated. This test report cannot be reproduced, except in full, without prior written permission of the Company. This test report does not assure KOLAS accreditation.

3.3.2. 99 % Bandwidth

- The span of the spectrum analyzer shall be set large enough to capture all products of the modulation process, including the emission skirts, around the carrier frequency, but small enough to avoid having other emissions (e.g. on adjacent channels) within the span.
- The detector of the spectrum analyzer shall be set to "Sample". However, a peak, or peak hold, may be used in place of the sampling detector since this usually produces a wider bandwidth than the actual bandwidth (worst-case measurement). Use of a peak hold (or "Max Hold") may be necessary to determine the occupied / x dB bandwidth if the device is not transmitting continuously.
- The resolution bandwidth (RBW) shall be in the range of 1 % to 5 % of the actual occupied / x dB bandwidth and the video bandwidth (VBW) shall not be smaller than three times the RBW value. Video averaging is not permitted.

For the 99% emission bandwidth, the trace data points are recovered and directly summed in linear power level terms. The recovered amplitude data points, beginning at the lowest frequency, are placed in a running sum until 0.5 % of the total is reached, and that frequency recorded. The process is repeated for the highest frequency data points (starting at the highest frequency, at the right side of the span, and going down in frequency). This frequency is then recorded. The difference between the two recorded frequencies is the occupied bandwidth (or the 99% emission bandwidth).

The results shown in this test report refer only to the sample(s) tested unless otherwise stated. This test report cannot be reproduced, except in full, without prior written permission of the Company. This test report does not assure KOLAS accreditation.

3.4. Test Results

Ambient temperature : (23 ± 1) °C
 Relative humidity : 47 % R.H.

Operation Mode	Data Rate (Mbps)	Channel	Frequency (MHz)	20 dB Bandwidth (MHz)	99 % Bandwidth (MHz)
GFSK	1	Low	2 402	1.051	0.938
		Middle	2 441	1.051	0.938
		High	2 480	1.051	0.933
π/4DQPSK	2	Low	2 402	1.346	1.203
		Middle	2 441	1.359	1.207
		High	2 480	1.359	1.207
8DPSK	3	Low	2 402	1.346	1.211
		Middle	2 441	1.346	1.207
		High	2 480	1.346	1.203

The results shown in this test report refer only to the sample(s) tested unless otherwise stated. This test report cannot be reproduced, except in full, without prior written permission of the Company. This test report does not assure KOLAS accreditation.

- Test plots

20 dB Bandwidth

Operating Mode: GFSK

Low Channel

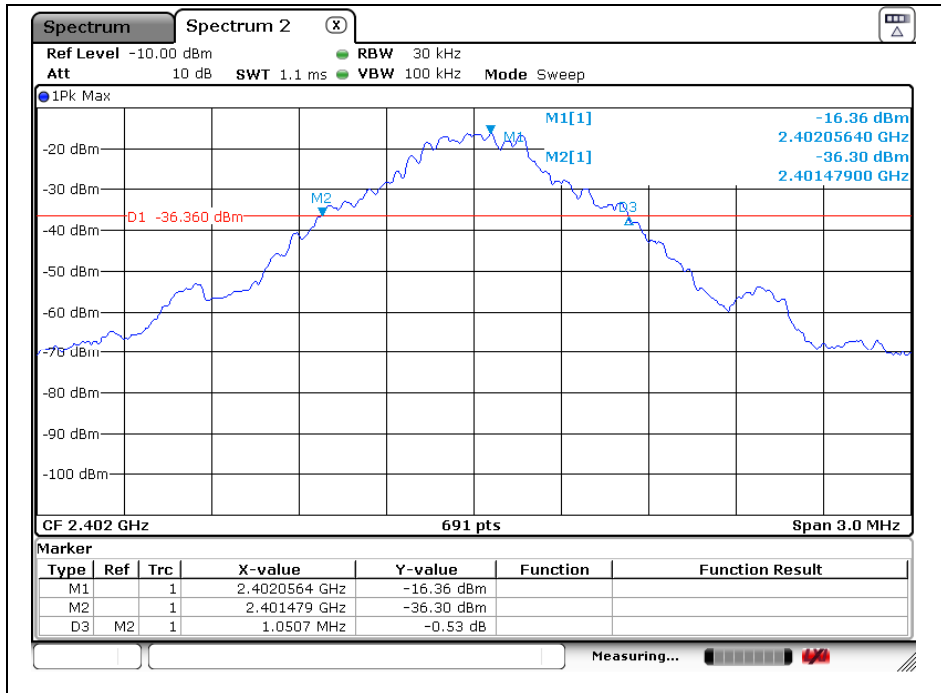

Middle Channel

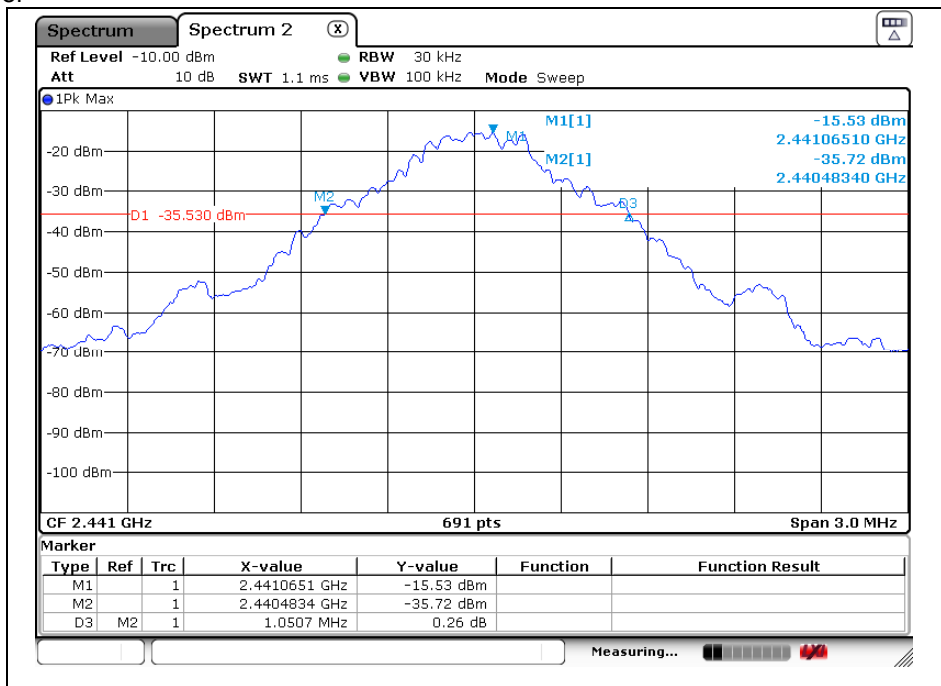

The results shown in this test report refer only to the sample(s) tested unless otherwise stated. This test report cannot be reproduced, except in full, without prior written permission of the Company. This test report does not assure KOLAS accreditation.

High Channel

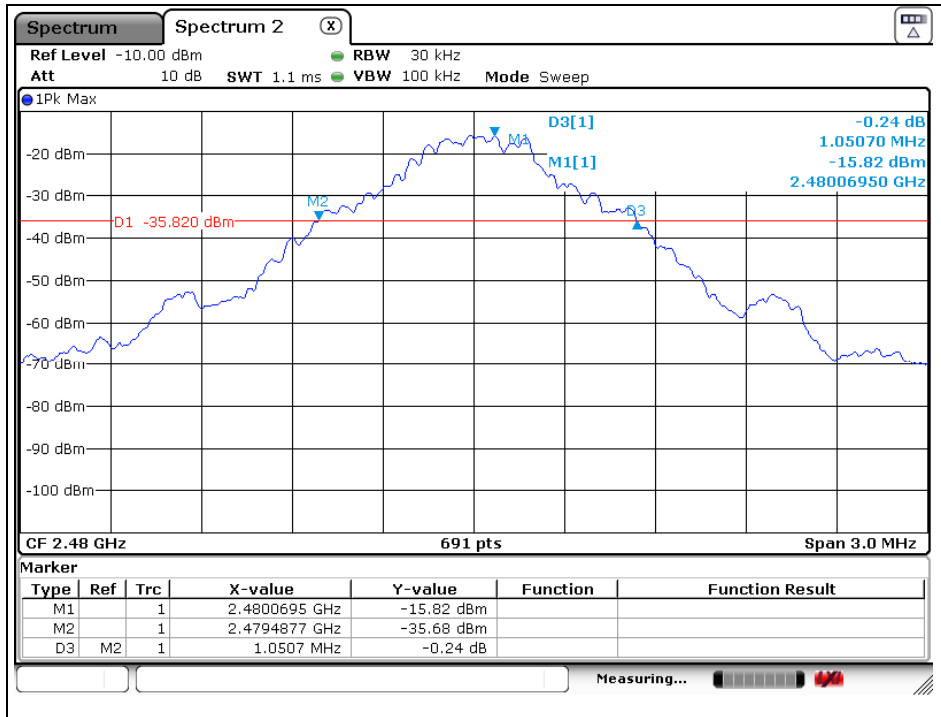

Operating Mode: $\pi/4$ DQPSK

Low Channel

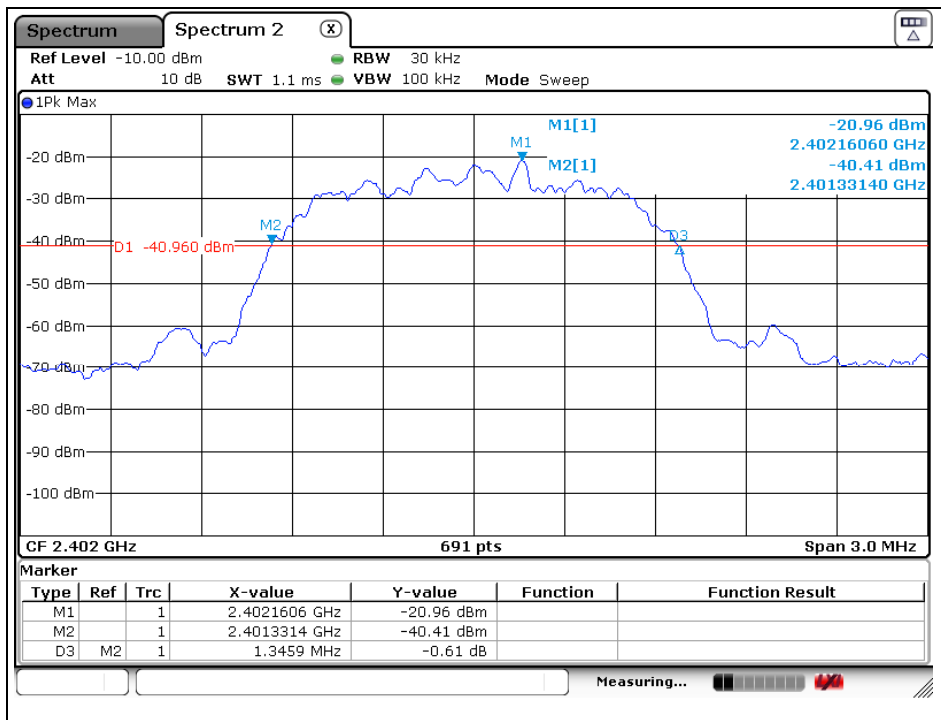

The results shown in this test report refer only to the sample(s) tested unless otherwise stated. This test report cannot be reproduced, except in full, without prior written permission of the Company. This test report does not assure KOLAS accreditation.

Middle Channel

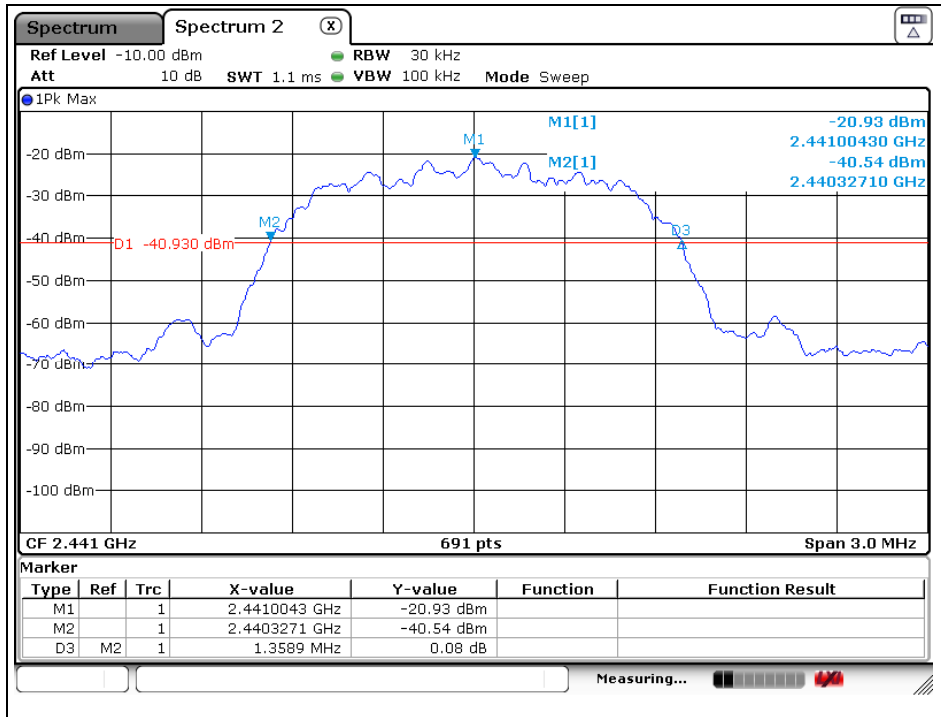

High Channel

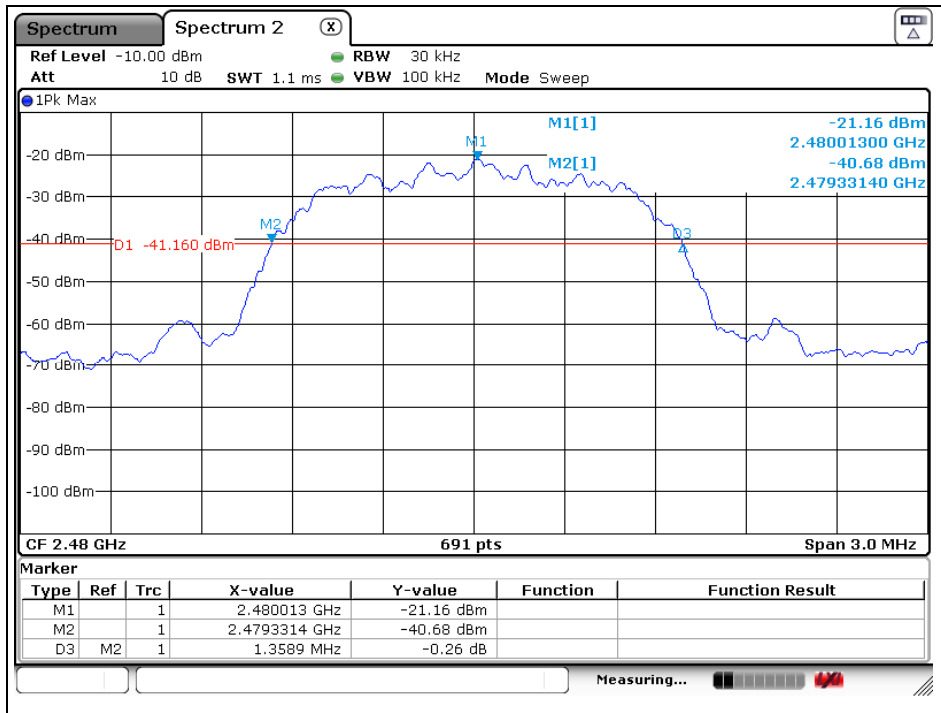

The results shown in this test report refer only to the sample(s) tested unless otherwise stated. This test report cannot be reproduced, except in full, without prior written permission of the Company. This test report does not assure KOLAS accreditation.

Operating Mode: 8DPSK

Low Channel

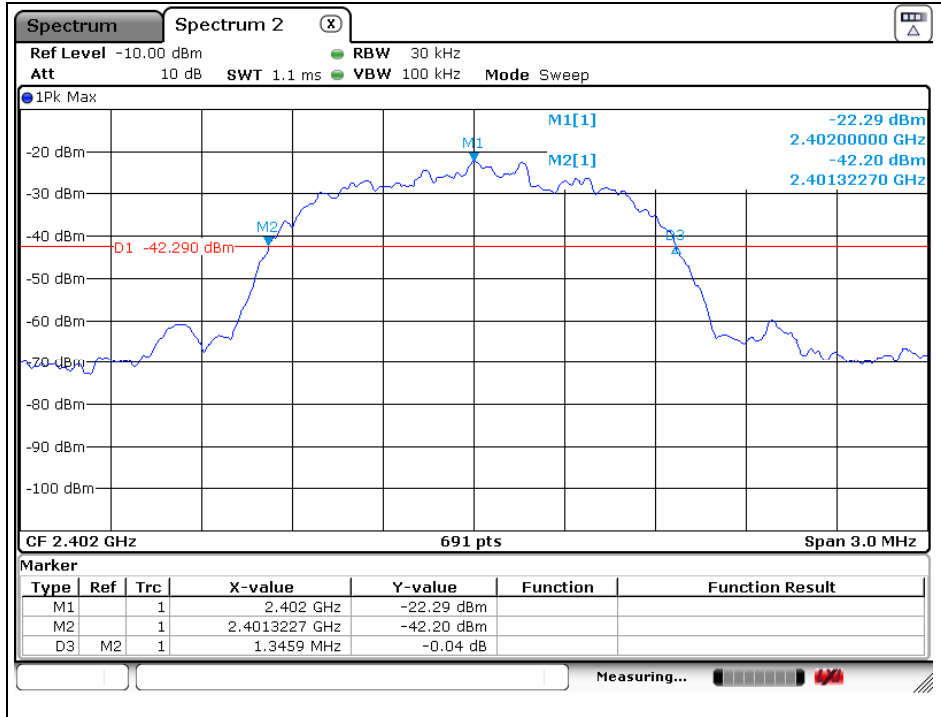

Middle Channel

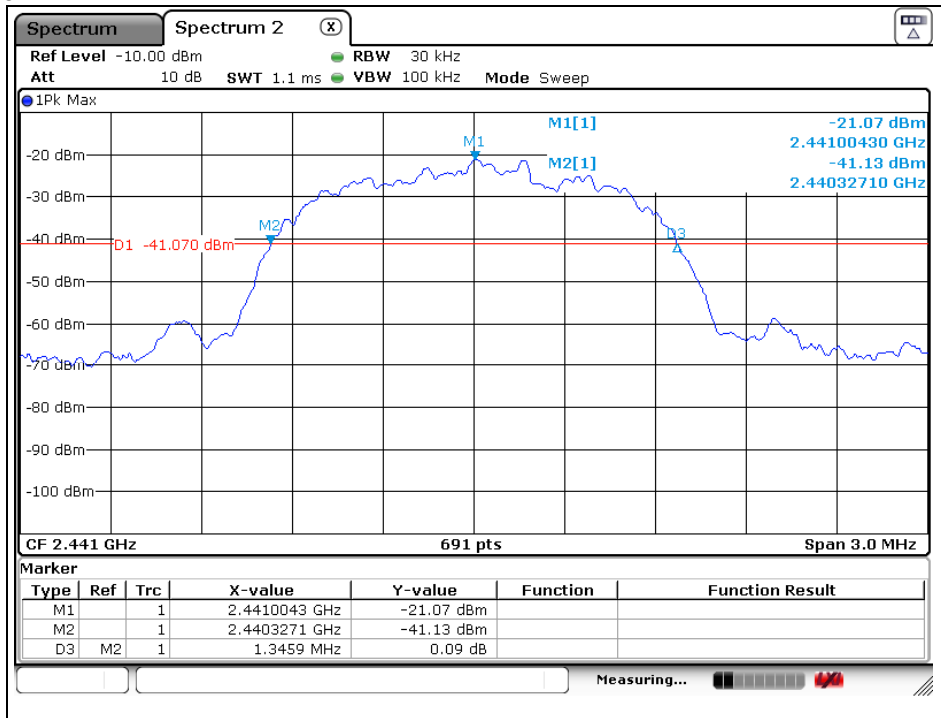

The results shown in this test report refer only to the sample(s) tested unless otherwise stated. This test report cannot be reproduced, except in full, without prior written permission of the Company. This test report does not assure KOLAS accreditation.

High Channel

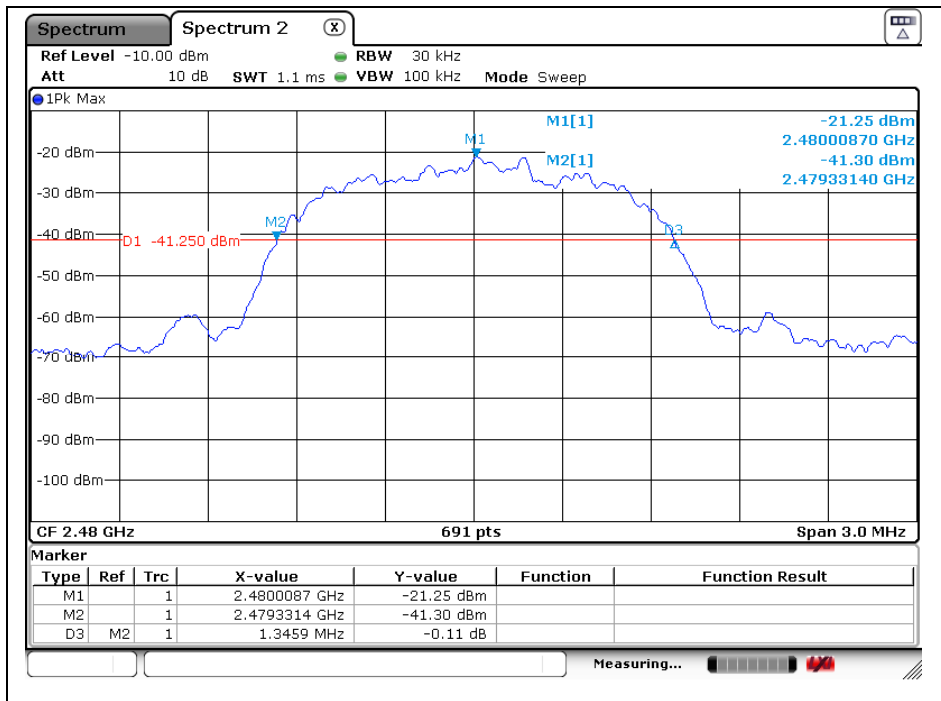

99% Bandwidth

Operating Mode: GFSK

Low Channel

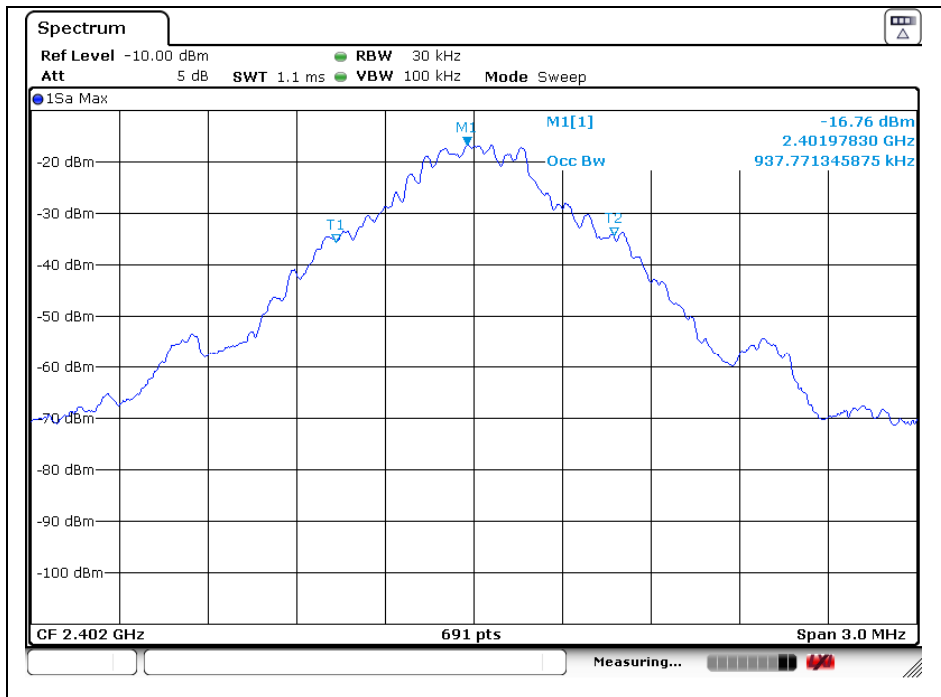

The results shown in this test report refer only to the sample(s) tested unless otherwise stated. This test report cannot be reproduced, except in full, without prior written permission of the Company. This test report does not assure KOLAS accreditation.

Middle Channel

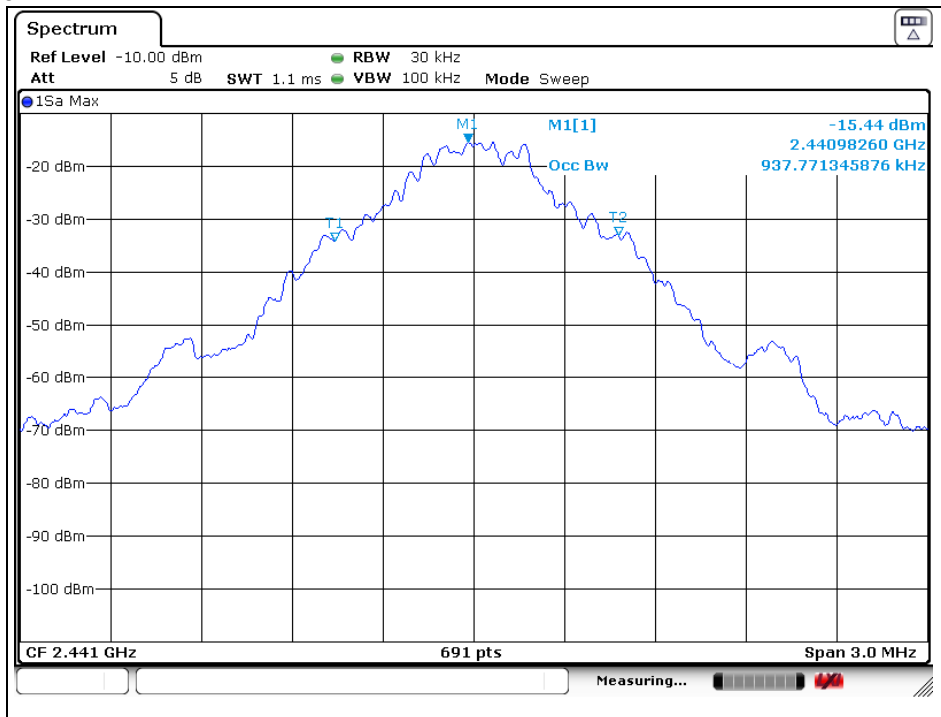

High Channel

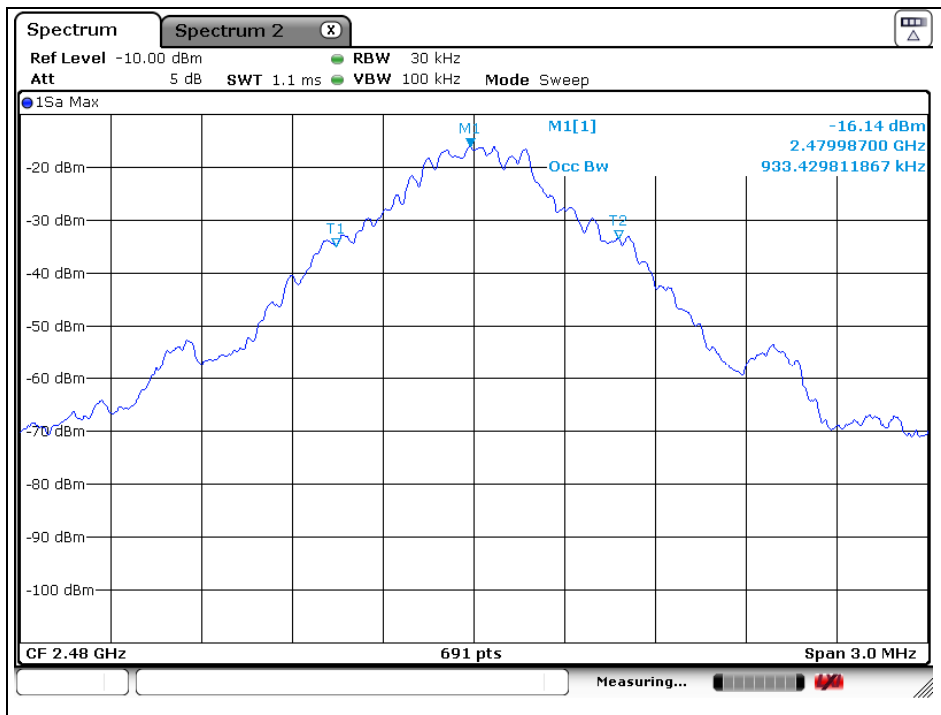

The results shown in this test report refer only to the sample(s) tested unless otherwise stated. This test report cannot be reproduced, except in full, without prior written permission of the Company. This test report does not assure KOLAS accreditation.

Operating Mode: $\pi/4$ DQPSK

Low Channel

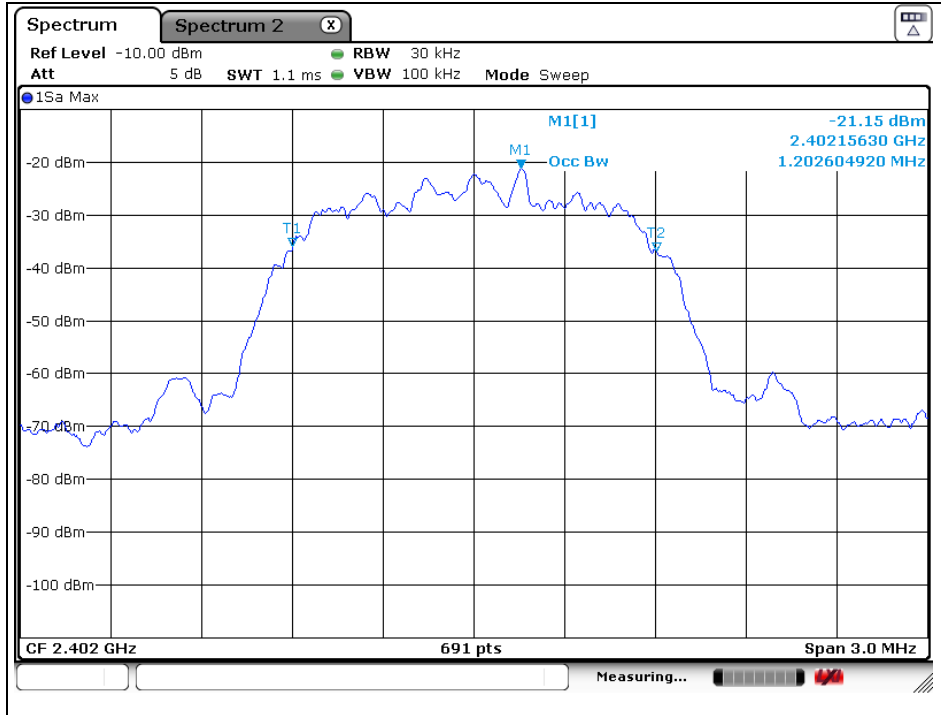

Middle Channel

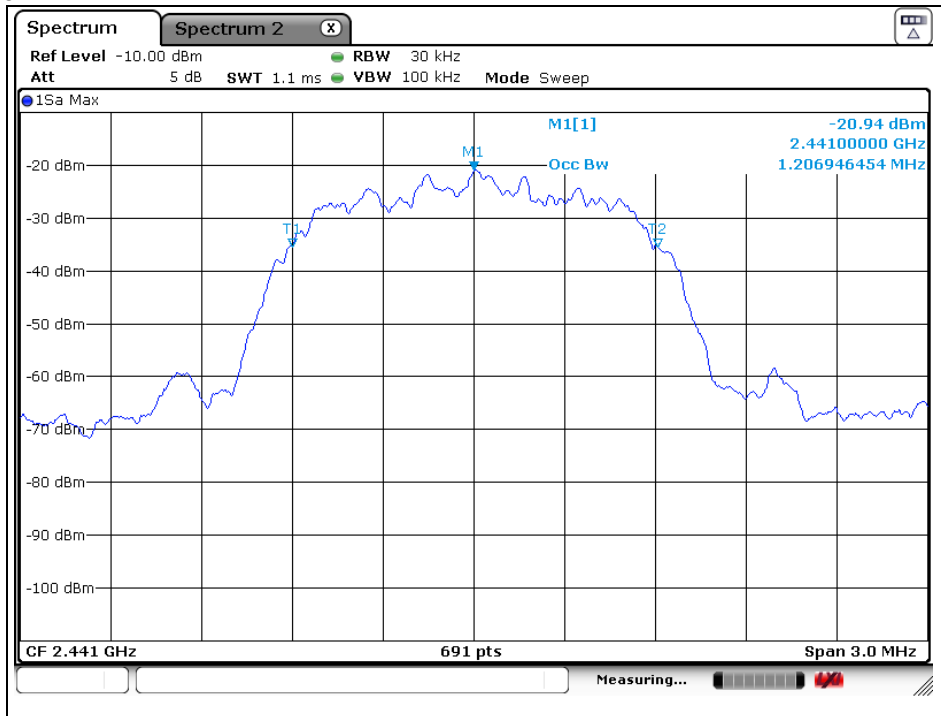

The results shown in this test report refer only to the sample(s) tested unless otherwise stated. This test report cannot be reproduced, except in full, without prior written permission of the Company. This test report does not assure KOLAS accreditation.

High Channel

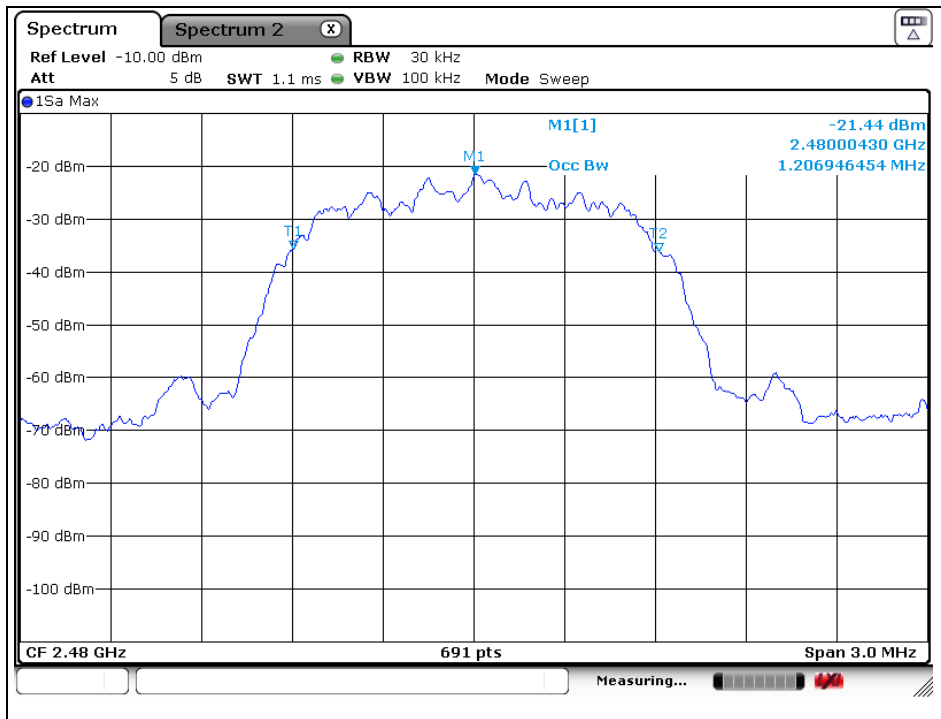

Operating Mode: 8DPSK

Low Channel

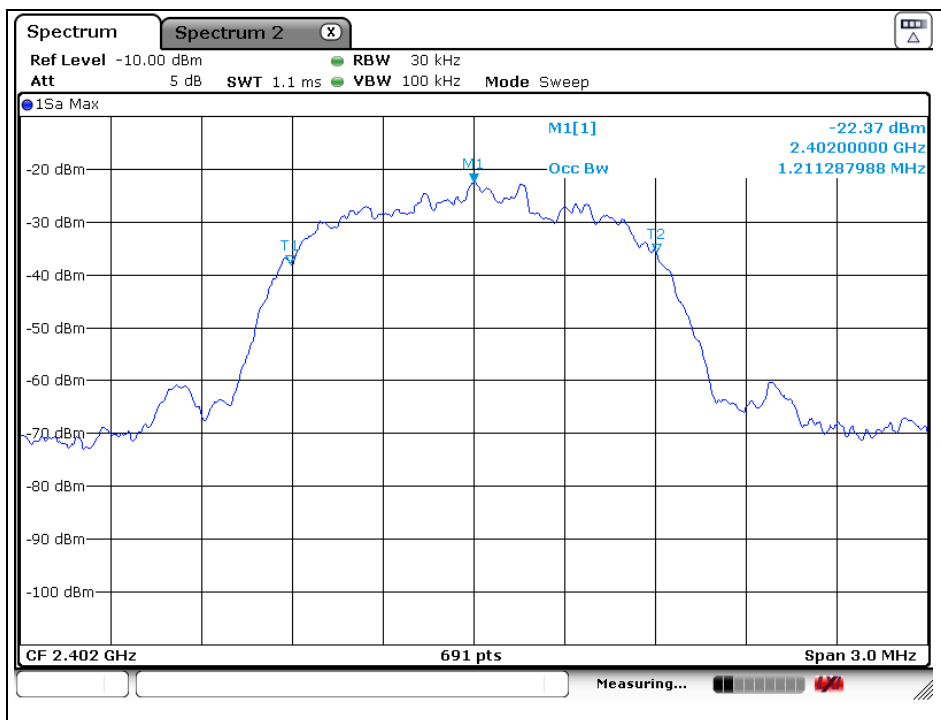

The results shown in this test report refer only to the sample(s) tested unless otherwise stated. This test report cannot be reproduced, except in full, without prior written permission of the Company. This test report does not assure KOLAS accreditation.

Middle Channel

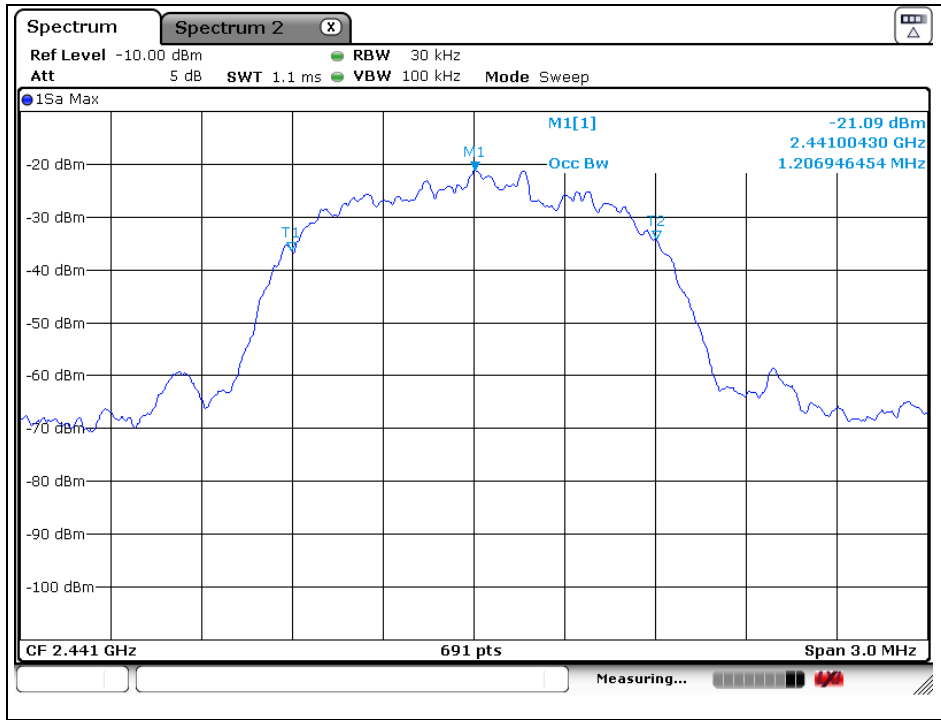

High Channel



The results shown in this test report refer only to the sample(s) tested unless otherwise stated. This test report cannot be reproduced, except in full, without prior written permission of the Company. This test report does not assure KOLAS accreditation.

4. Maximum Peak Conducted Output Power

4.1. Test Setup

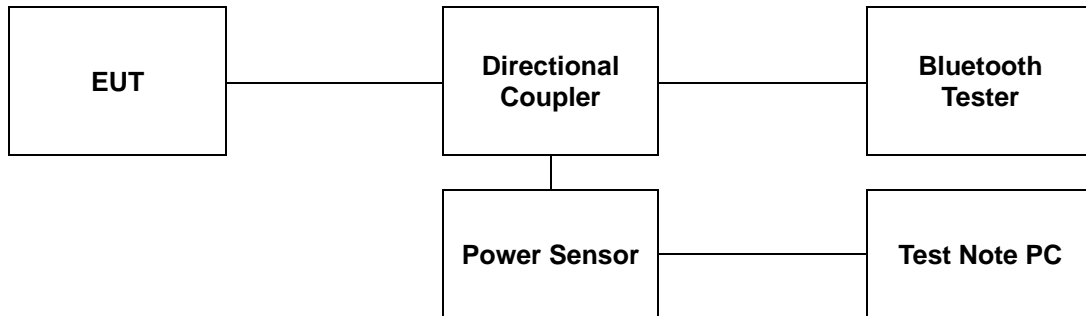

4.2. Limit

4.2.1. FCC

- §15.247(a)(1), Frequency hopping systems shall have hopping channel carrier frequencies separated by a minimum of 25 kHz or the 20 dB bandwidth of the hopping channel, whichever is greater. Alternatively, frequency hopping systems operating in the 2 400-2 483.5 MHz band may have hopping channel carrier frequencies that are separated by 25 kHz or two-thirds of the 20 dB bandwidth of the hopping channel, whichever is greater, provided the systems operate with an output power no greater than 125 mW.
- §15.247(b)(1), For frequency hopping systems operating in the 2 400-2 483.5 MHz band employing at least 75 non-overlapping hopping channels, and all frequency hopping systems in the 5 725-5 850 MHz band: 1 watt. For all other frequency hopping systems in the 2 400-2 483.5 MHz band: 0.125 watts.

4.2.2. IC

- According to RSS-247 Issue 2, 5.1(b), FHSs shall have hopping channel carrier frequencies separated by a minimum of 25 kHz or the 20 dB bandwidth of the hopping channel, whichever is greater. Alternatively, FHSs operating in the band 2 400-2 483.5 MHz may have hopping channel carrier frequencies that are separated by 25 kHz or two thirds of the 20 dB bandwidth of the hopping channel, whichever is greater, provided that the systems operate with an output power no greater than 0.125 W.
- According to RSS-247 Issue 2, 5.4(b), for FHSs operating in the band 2 400-2 483.5 MHz, the maximum peak conducted output power shall not exceed 1.0 W if the hopset uses 75 or more hopping channels; the maximum peak conducted output power shall not exceed 0.125 W if the hopset uses less than 75 hopping channels. The e.i.r.p. shall not exceed 4 W, except as provided in section 5.4(e).

4.3. Test Procedure

The test follows ANSI C63.10-2013. Using the power sensor instead of a spectrum analyzer.

- Place the EUT on the table and set it in the transmitting mode.
- Remove the antenna from the EUT and then connect a low loss RF cable from the antenna port to the Power sensor.
- Test program: (S/W name: R&S Power Viewer, Version: 3.2.0)
- Measure peak power each channel.

The results shown in this test report refer only to the sample(s) tested unless otherwise stated. This test report cannot be reproduced, except in full, without prior written permission of the Company. This test report does not assure KOLAS accreditation.

4.4. Test Results

Ambient temperature : (23 ± 1) °C
 Relative humidity : 47 % R.H.

Operation Mode	Data Rate	Channel	Frequency (MHz)	Average Power Result (dB m)	Peak Power Result (dB m)	Limit (dB m)
GFSK	1 Mbps	Low	2 402	3.00	3.44	20.97
		Middle	2 441	<u>3.64</u>	<u>4.07</u>	
		High	2 480	3.24	3.66	
π/4DQPSK	2 Mbps	Low	2 402	-2.42	0.59	
		Middle	2 441	<u>-1.28</u>	<u>1.66</u>	
		High	2 480	-1.52	1.58	
8DPSK	3 Mbps	Low	2 402	-2.42	0.78	
		Middle	2 441	<u>-1.27</u>	<u>1.83</u>	
		High	2 480	-1.46	1.63	

Remark;

In the case of AFH, the limit for peak power is 0.125 W.
 Directional coupler and cable offset compensate for test program (R&S Power Viewer) before measuring.

The results shown in this test report refer only to the sample(s) tested unless otherwise stated. This test report cannot be reproduced, except in full, without prior written permission of the Company. This test report does not assure KOLAS accreditation.

5. Carrier Frequency Separation

5.1. Test Setup

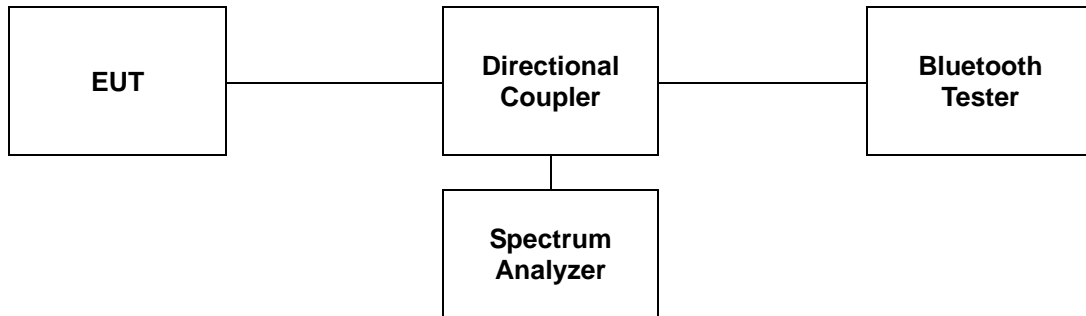

5.2. Limit

5.2.1. FCC

§15.247(a)(1), Frequency hopping systems shall have hopping channel carrier frequencies separated by a minimum of 25 kHz or the 20 dB bandwidth of the hopping channel, whichever is greater. Alternatively, frequency hopping systems operating in the 2 400-2 483.5 MHz band may have hopping channel carrier frequencies that are separated by 25 kHz or two-thirds of the 20 dB bandwidth of the hopping channel, whichever is greater, provided the systems operate with an output power no greater than 125 mW.

5.2.2. IC

According to RSS-247 Issue 2, 5.1(b), FHSs shall have hopping channel carrier frequencies separated by a minimum of 25 kHz or the 20 dB bandwidth of the hopping channel, whichever is greater. Alternatively, FHSs operating in the band 2 400-2 483.5 MHz may have hopping channel carrier frequencies that are separated by 25 kHz or two thirds of the 20 dB bandwidth of the hopping channel, whichever is greater, provided that the systems operate with an output power no greater than 0.125 W.

The results shown in this test report refer only to the sample(s) tested unless otherwise stated. This test report cannot be reproduced, except in full, without prior written permission of the Company. This test report does not assure KOLAS accreditation.

5.3. Test Procedure

The test follows ANSI C63.10-2013.

The device is operating in hopping mode between 79 channels and also supporting Adaptive Frequency Hopping with hopping between 20 channels. As compared with each operating mode, 79 channels are chosen as a representative for test.

Use the following spectrum analyzer settings:

Span = wide enough to capture the peaks of two adjacent channels

RBW = Start with the RBW set to approximately 30% of the channel spacing; adjust as necessary to best identify the center of each individual channel.

VBW \geq RBW

Sweep = auto

Detector = peak

Trace = max hold

Allow the trace to stabilize.

Use the marker-delta function to determine the between the peaks of the adjacent channels.

The results shown in this test report refer only to the sample(s) tested unless otherwise stated. This test report cannot be reproduced, except in full, without prior written permission of the Company. This test report does not assure KOLAS accreditation.

5.4. Test Results

Ambient temperature : (23 ± 1) °C
 Relative humidity : 47 % R.H.

Operation Mode	Frequency (MHz)	Adjacent Hopping Channel Separation (kHz)	Two-third of 20 dB Bandwidth (kHz)	Minimum Bandwidth (kHz)
GFSK	2 441	1 000	701	25
8DPSK	2 441	1 000	897	25

Remark;

Measurement is made with EUT operating in hopping mode between 79 channels providing a worst case scenario as compared to AFH mode hopping between 20 channels.

The results shown in this test report refer only to the sample(s) tested unless otherwise stated. This test report cannot be reproduced, except in full, without prior written permission of the Company. This test report does not assure KOLAS accreditation.

Operating Mode: GFSK

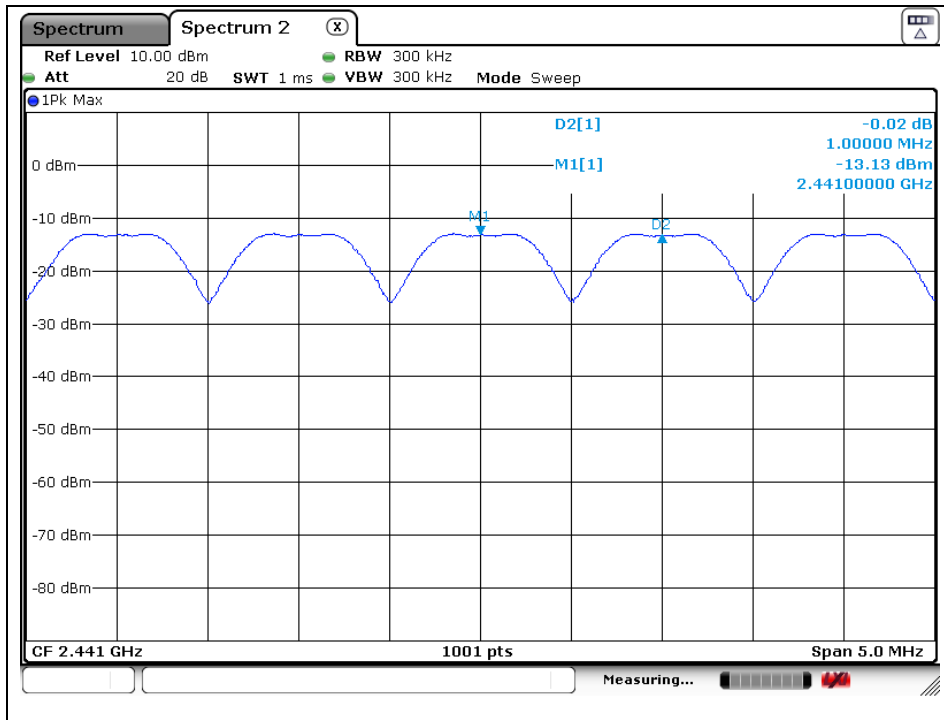

Operating Mode: 8DPSK

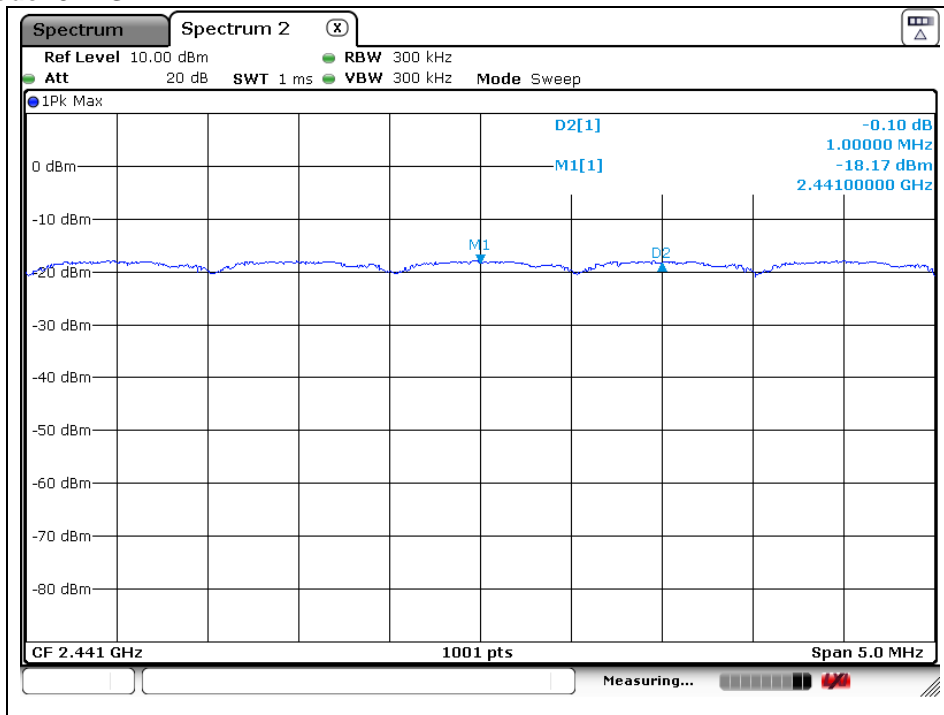

The results shown in this test report refer only to the sample(s) tested unless otherwise stated. This test report cannot be reproduced, except in full, without prior written permission of the Company. This test report does not assure KOLAS accreditation.

6. Number of Hopping Frequencies

6.1. Test Setup

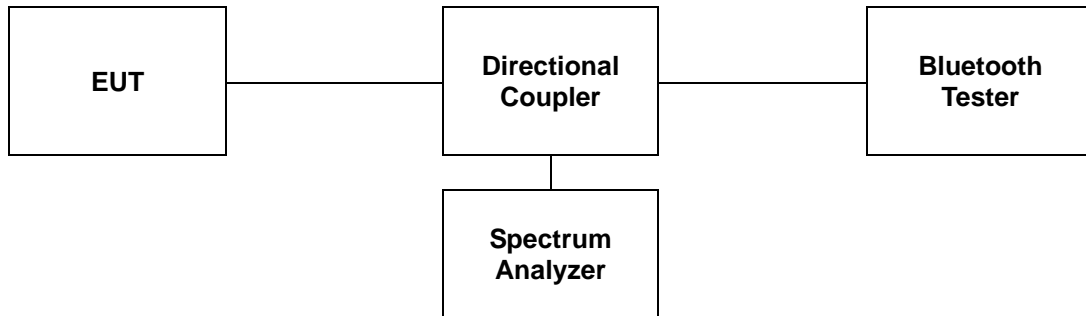

6.2. Limit

6.2.1. FCC

§15.247(a)(1)(iii), Frequency hopping systems in the 2 400-2 483.5 MHz band shall use at least 15 channels. The average time of occupancy on any channel shall not be greater than 0.4 seconds within a period of 0.4 seconds multiplied by the number of hopping channels employed. Frequency hopping systems may avoid or suppress transmissions on a particular hopping frequency provided that a minimum of 15 channels are used.

6.2.2. IC

According to RSS-247 Issue 2, 5.1(d), FHSs operating in the band 2 400-2 483.5 MHz shall use at least 15 hopping channels. The average time of occupancy on any channel shall not be greater than 0.4 seconds within a period of 0.4 seconds, multiplied by the number of hopping channels employed. Transmissions on particular hopping frequencies may be avoided or suppressed provided that at least 15 hopping channels are used.

6.3. Test Procedure

The test follows ANSI C63.10-2013.

The device supports Adaptive Frequency Hopping and will use a minimum of 20 channels of the 79 available channels.

The EUT shall have its hopping function enabled. Use the following spectrum analyzer settings:

1. Span: The frequency band of operation. Depending on the number of channels the device supports, it may be necessary to divide the frequency range of operation across multiple spans, to allow the individual channels to be clearly seen.
2. RBW: To identify clearly the individual channels, set the RBW to less than 30 % of the channel spacing or the 20 dB bandwidth, whichever is smaller.
3. VBW \geq RBW
4. Sweep: Auto
5. Detector function: Peak
6. Trace: Max hold
7. Allow the trace to stabilize.

The results shown in this test report refer only to the sample(s) tested unless otherwise stated. This test report cannot be reproduced, except in full, without prior written permission of the Company. This test report does not assure KOLAS accreditation.

6.4. Test Results

Ambient temperature : (23 ± 1) °C
 Relative humidity : 47 % R.H.

Operation Mode	Number of Hopping Frequency	Limit
GFSK	79	≥ 15
8DPSK	79	≥ 15

Remark;

Measurement is made with EUT operating in hopping mode between 79 channels providing a worst case scenario as compared to AFH mode hopping between 20 channels.

The results shown in this test report refer only to the sample(s) tested unless otherwise stated. This test report cannot be reproduced, except in full, without prior written permission of the Company. This test report does not assure KOLAS accreditation.

Operating Mode: GFSK

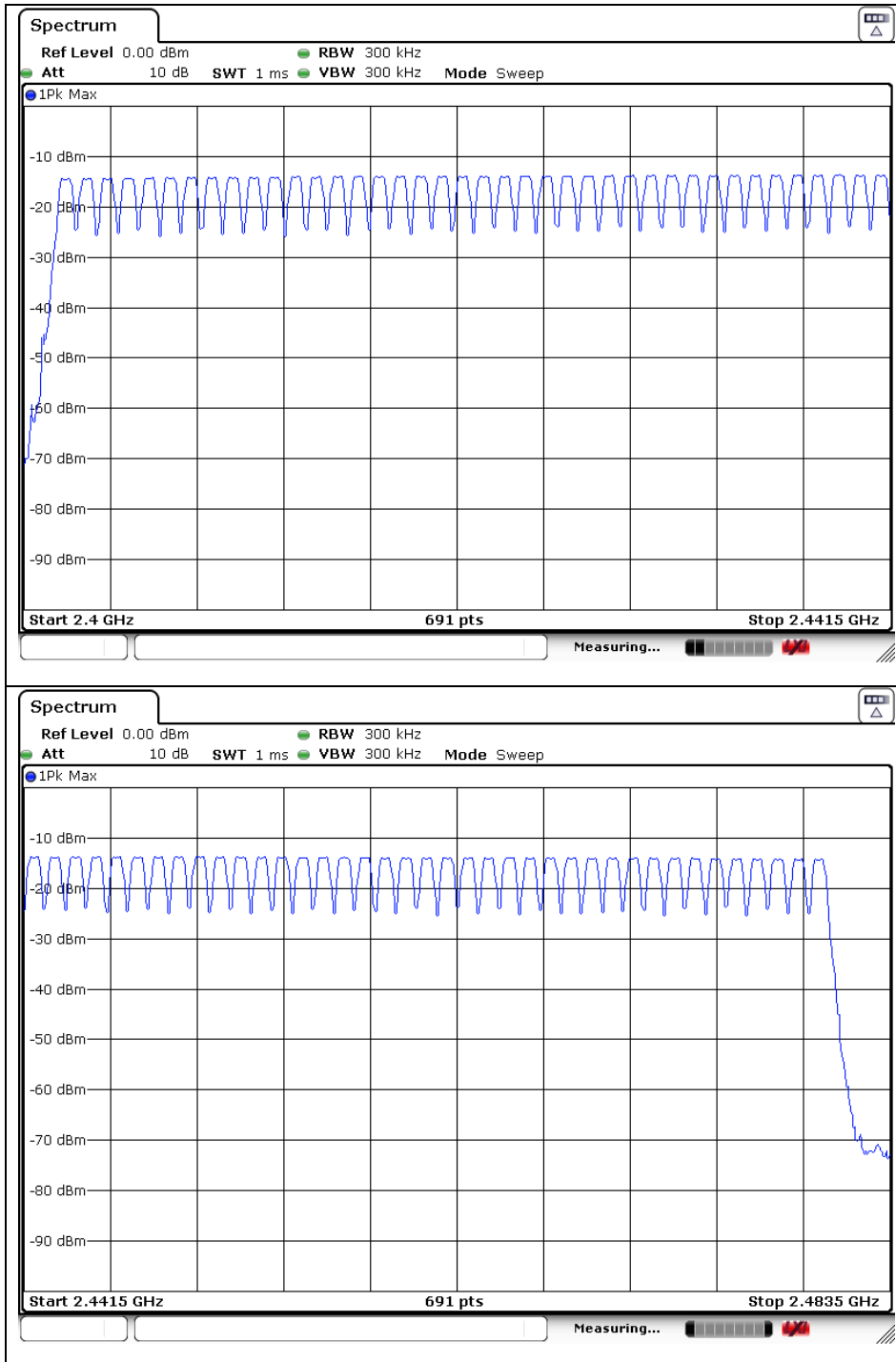

The results shown in this test report refer only to the sample(s) tested unless otherwise stated. This test report cannot be reproduced, except in full, without prior written permission of the Company. This test report does not assure KOLAS accreditation.

Operating Mode: 8DPSK

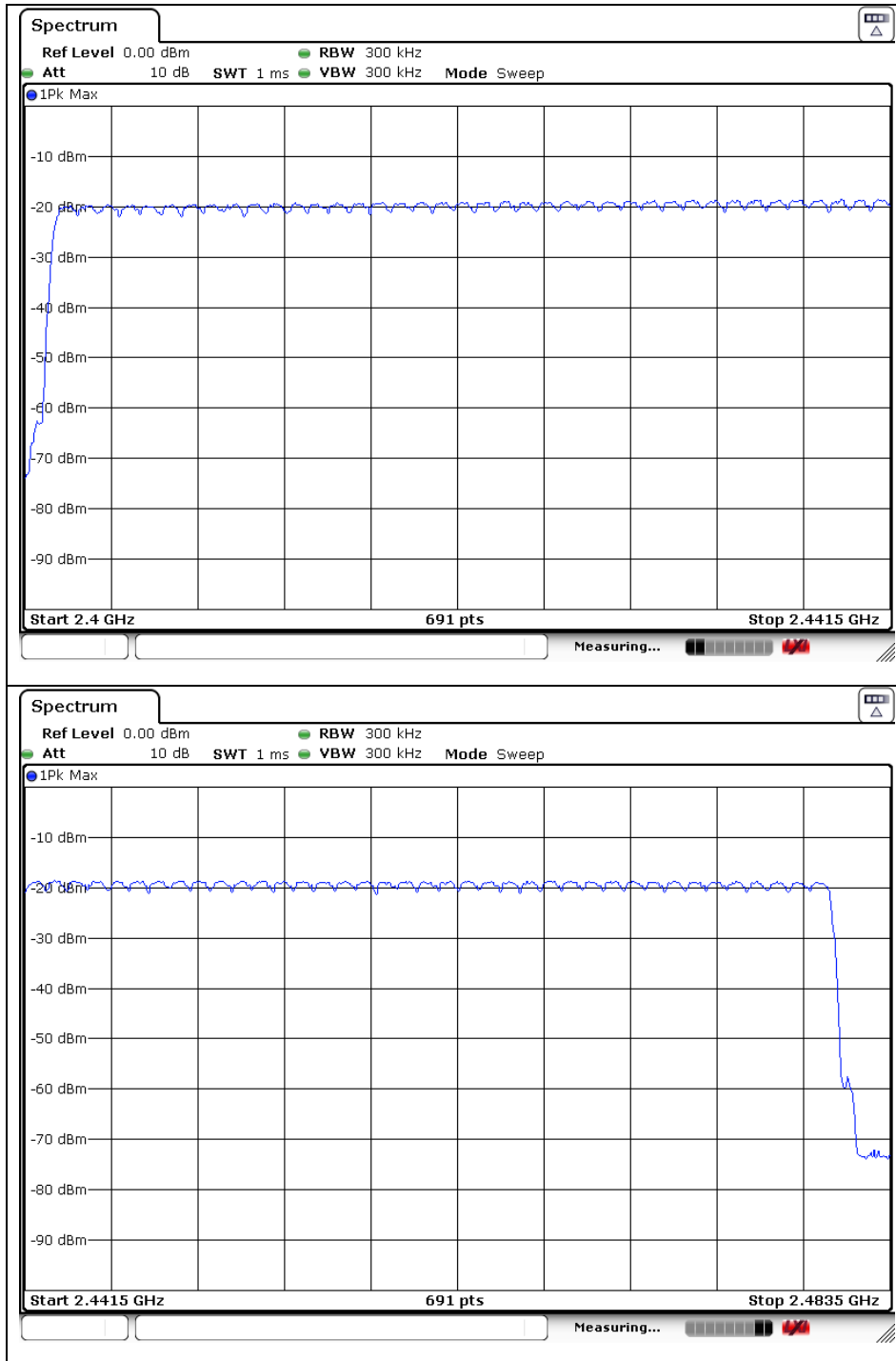

The results shown in this test report refer only to the sample(s) tested unless otherwise stated. This test report cannot be reproduced, except in full, without prior written permission of the Company. This test report does not assure KOLAS accreditation.

7. Time of Occupancy (Dwell Time)

7.1. Test Set up

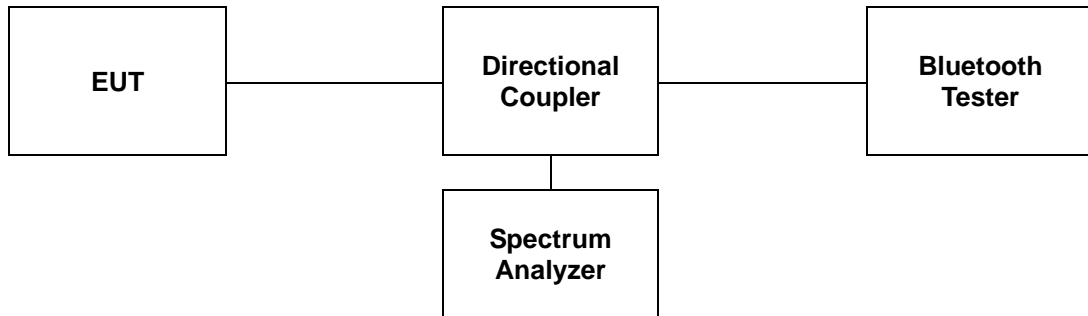

7.2. Limit

7.2.1. FCC

§15.247(a)(1)(iii), Frequency hopping systems in the 2 400-2 483.5 MHz band, the average time of occupancy on any frequency shall not be greater than 0.4 second within a 31.6 second period.

7.2.2. IC

According to RSS-247 Issue 2, 5.1(d), FHSs operating in the band 2 400-2 483.5 MHz shall use at least 15 hopping channels. The average time of occupancy on any channel shall not be greater than 0.4 seconds within a period of 0.4 seconds, multiplied by the number of hopping channels employed. Transmissions on particular hopping frequencies may be avoided or suppressed provided that at least 15 hopping channels are used.

A period time = 0.4 (s) * 79 = 31.6 (s)

*Adaptive Frequency Hopping

A period time = 0.4 (s) * 20 = 8 (s)

The results shown in this test report refer only to the sample(s) tested unless otherwise stated. This test report cannot be reproduced, except in full, without prior written permission of the Company. This test report does not assure KOLAS accreditation.

7.3. Test Procedure

All data rates and modes were investigated for this test. The full data for the worst case data rate are reported in this section. The test follows ANSI C63.10-2013.

1. Check the calibration of the measuring instrument using either an internal calibrator or a known signal from an external generator.
2. Position the EUT as shown in test setup without connection to measurement instrument. Turn on the EUT and connect its antenna terminal to measurement instrument via a low loss cable.
3. Measure the time duration of one transmission on the measured frequency. And then plot the result with time difference of this time duration.
4. The Bluetooth has 3 type of payload, DH1, DH3, DH5 and 3DH1, 3DH3, 3DH5. The hopping rate is insisted of 1 600 per second.

The EUT must have its hopping function enabled. Use the following spectrum analyzer setting:

Span = zero span, centered on a hopping channel

RBW = 1 MHz

VBW ≥ RBW

Sweep = as necessary to capture the entire dwell time per hopping channel

Detector = peak

Trace = max hold

Use the marker-delta function to determine the dwell time. If this value varies with different modes of operation, repeat this test for each variation.

The results shown in this test report refer only to the sample(s) tested unless otherwise stated. This test report cannot be reproduced, except in full, without prior written permission of the Company. This test report does not assure KOLAS accreditation.

7.4. Test Results

Ambient temperature : (23 ± 1) °C
 Relative humidity : 47 % R.H.

7.4.1. Packet Type: DH1, 3DH1

Operation Mode	Frequency (MHz)	Dwell Time (ms)	Time of occupancy on the Tx Channel in 31.6 sec (ms)	Limit for time of occupancy on the Tx Channel in 31.6 sec (ms)
GFSK	2 441	0.38	121.60	400
8DPSK	2 441	0.39	124.80	400

Remark;

Time of occupancy on the TX channel in 31.6 sec

In case of GFSK: $0.38 \times \{(1\ 600 \div 2) / 79\} \times 31.6 = 121.60$ ms

In case of 8DPSK: $0.39 \times \{(1\ 600 \div 2) / 79\} \times 31.6 = 124.80$ ms

The results shown in this test report refer only to the sample(s) tested unless otherwise stated. This test report cannot be reproduced, except in full, without prior written permission of the Company. This test report does not assure KOLAS accreditation.

Operating Mode: GFSK

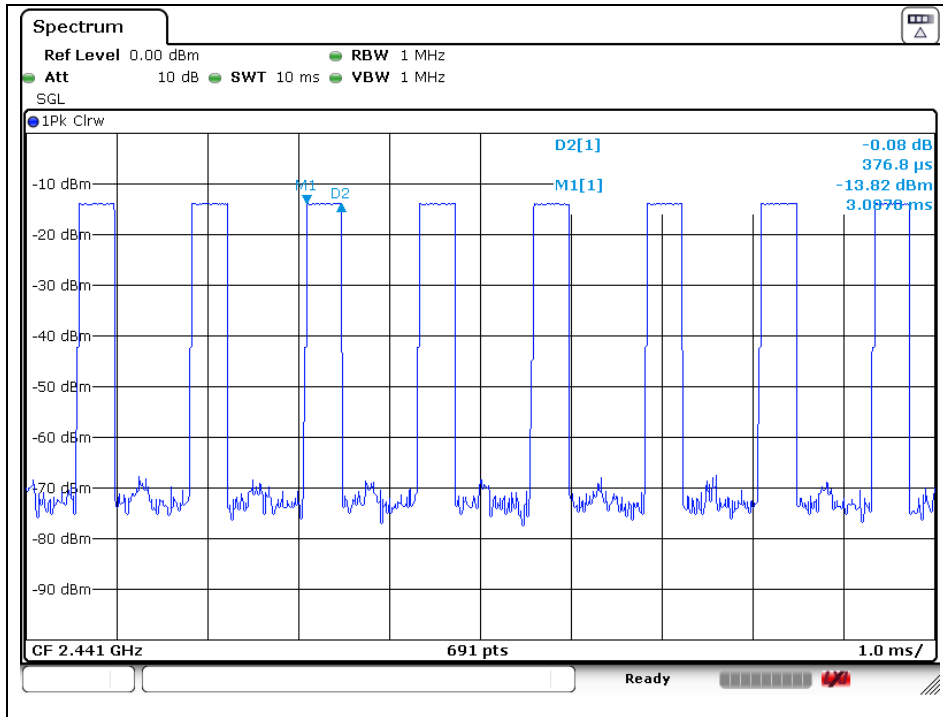

Operating Mode: 8DPSK

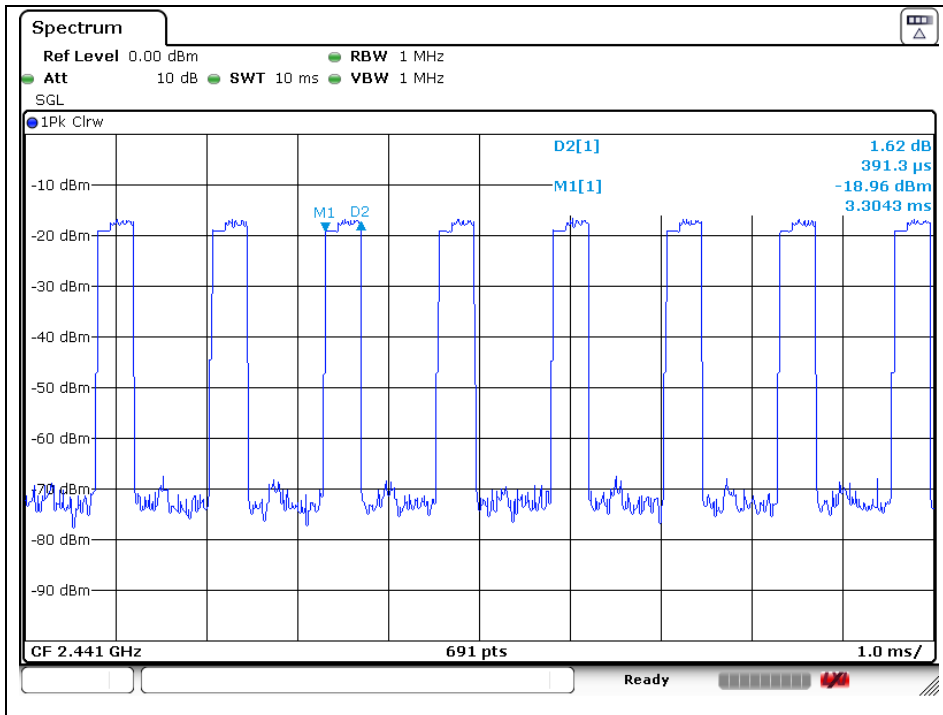

The results shown in this test report refer only to the sample(s) tested unless otherwise stated. This test report cannot be reproduced, except in full, without prior written permission of the Company. This test report does not assure KOLAS accreditation.

7.4.2. Packet Type: DH3, 3DH3

Operation Mode	Frequency (MHz)	Dwell Time (ms)	Time of occupancy on the Tx Channel in 31.6 sec (ms)	Limit for time of occupancy on the Tx Channel in 31.6 sec (ms)
GFSK	2 441	1.64	262.40	400
8DPSK	2 441	1.65	264.00	400

Remark;

Time of occupancy on the TX channel in 31.6 sec

In case of GFSK: $1.64 \times \{(1\ 600 \div 4) / 79\} \times 31.6 = 262.40$ ms

In case of 8DPSK: $1.65 \times \{(1\ 600 \div 4) / 79\} \times 31.6 = 264.00$ ms

The results shown in this test report refer only to the sample(s) tested unless otherwise stated. This test report cannot be reproduced, except in full, without prior written permission of the Company. This test report does not assure KOLAS accreditation.

Operating Mode: GFSK

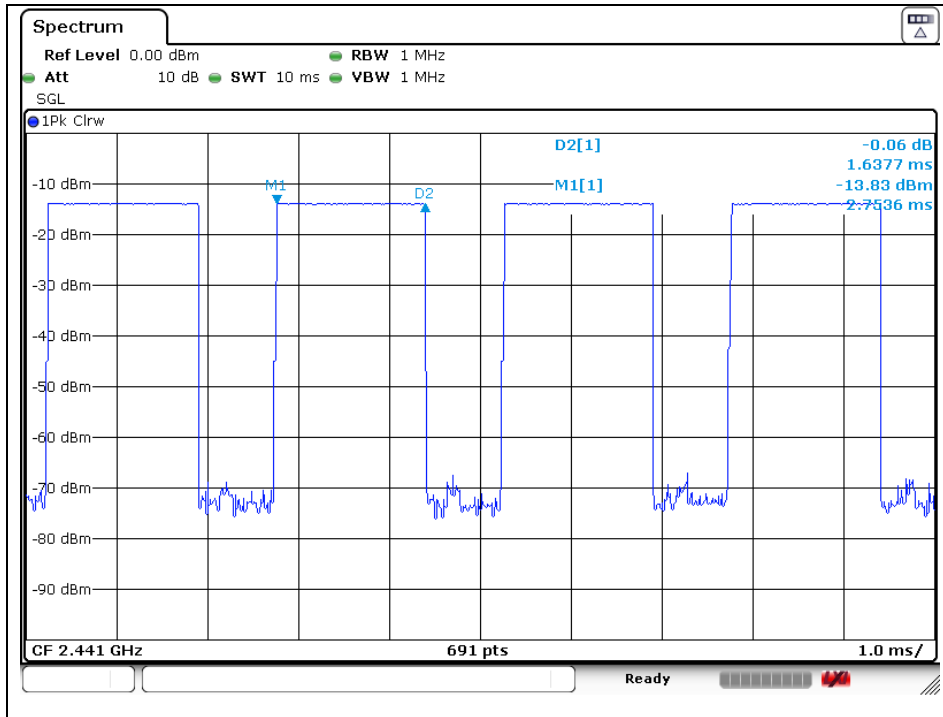

Operating Mode: 8DPSK

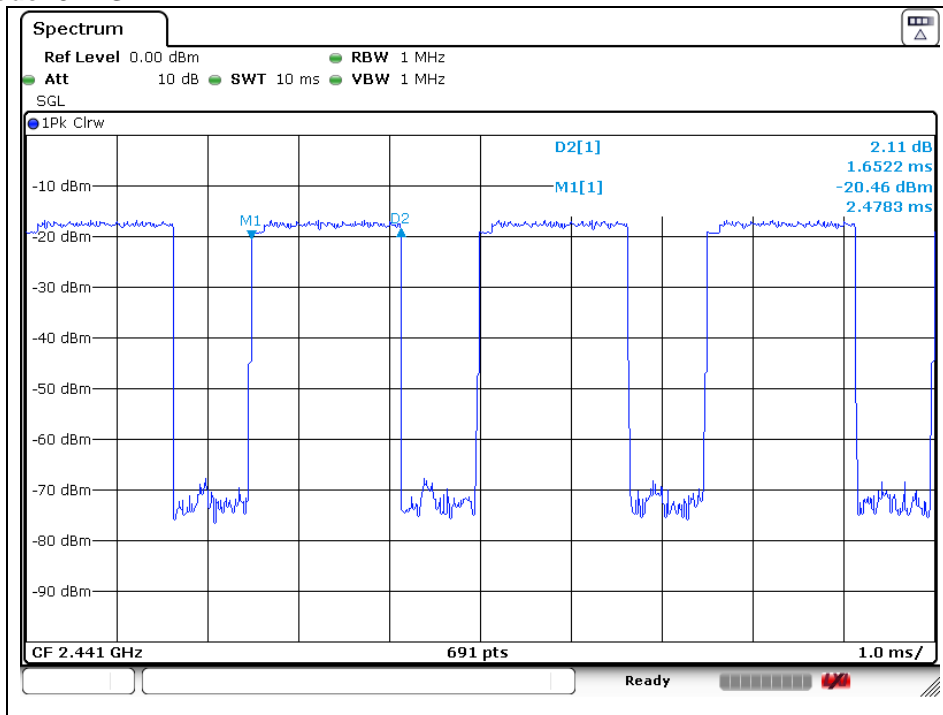

The results shown in this test report refer only to the sample(s) tested unless otherwise stated. This test report cannot be reproduced, except in full, without prior written permission of the Company. This test report does not assure KOLAS accreditation.

7.4.3. Packet Type: DH5, 3DH5

Operation Mode	Frequency (MHz)	Dwell Time (ms)	Time of occupancy on the Tx Channel in 31.6 sec (ms)	Limit for time of occupancy on the Tx Channel in 31.6 sec (ms)
GFSK	2 441	2.88	307.20	400
8DPSK	2 441	2.90	309.33	400

Remark;

Time of occupancy on the TX channel in 31.6 sec

In case of GFSK: $2.88 \times \{(1\ 600 \div 6) / 79\} \times 31.6 = 307.20$ ms

In case of 8DPSK: $2.90 \times \{(1\ 600 \div 6) / 79\} \times 31.6 = 309.33$ ms

The results shown in this test report refer only to the sample(s) tested unless otherwise stated. This test report cannot be reproduced, except in full, without prior written permission of the Company. This test report does not assure KOLAS accreditation.

Operating Mode: GFSK

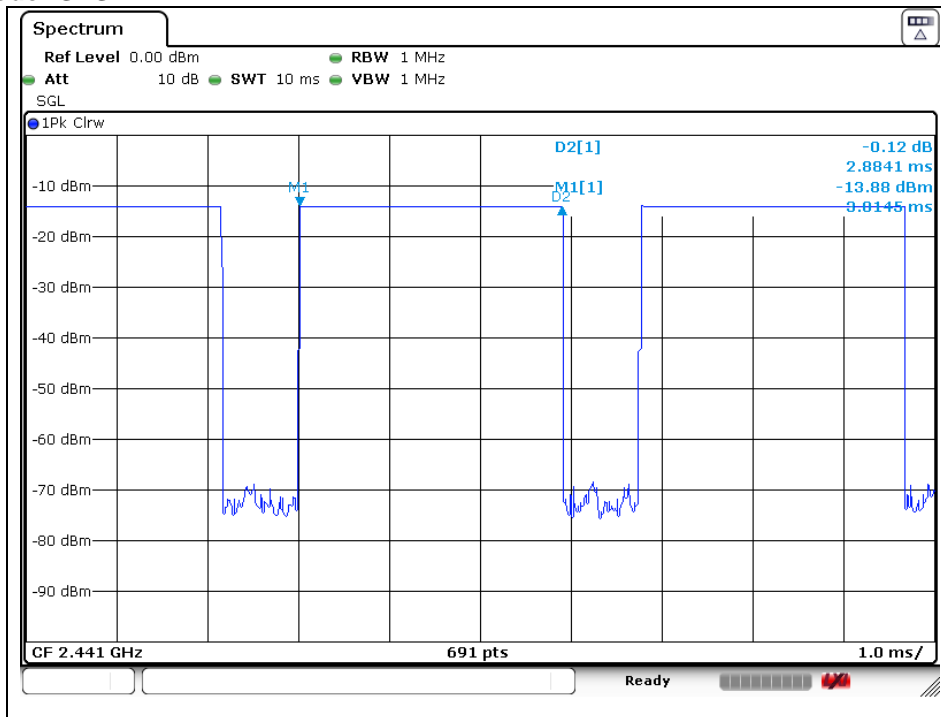

Operating Mode: 8DPSK

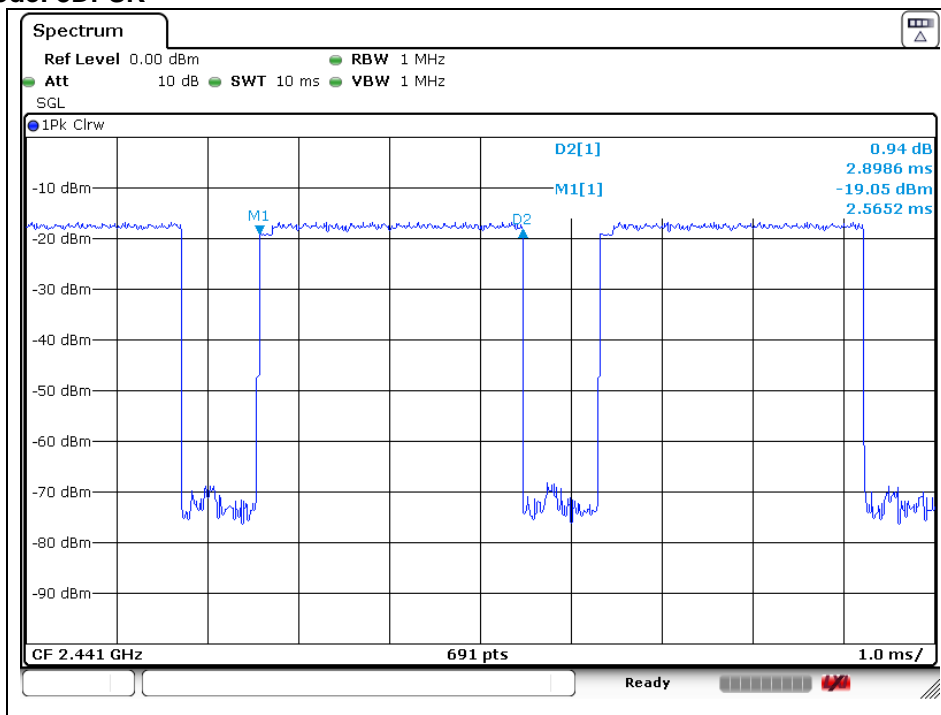

The results shown in this test report refer only to the sample(s) tested unless otherwise stated. This test report cannot be reproduced, except in full, without prior written permission of the Company. This test report does not assure KOLAS accreditation.

7.4.4. Packet Type: DH1, 3DH1 (Adaptive Frequency Hopping)

Operation Mode	Frequency (MHz)	Dwell Time (ms)	Time of occupancy on the Tx Channel in 8 sec (ms)	Limit for time of occupancy on the Tx Channel in 8 sec (ms)
GFSK	2 441	0.38	60.80	400
8DPSK	2 441	0.39	62.40	400

Remark;

Time of occupancy on the TX channel in 8 sec

In case of GFSK: $0.38 \times \{(800 \div 2) / 20\} \times 8 = 60.80 \text{ ms}$

In case of 8DPSK: $0.39 \times \{(800 \div 2) / 20\} \times 8 = 62.40 \text{ ms}$

The results shown in this test report refer only to the sample(s) tested unless otherwise stated. This test report cannot be reproduced, except in full, without prior written permission of the Company. This test report does not assure KOLAS accreditation.

Operating Mode: GFSK

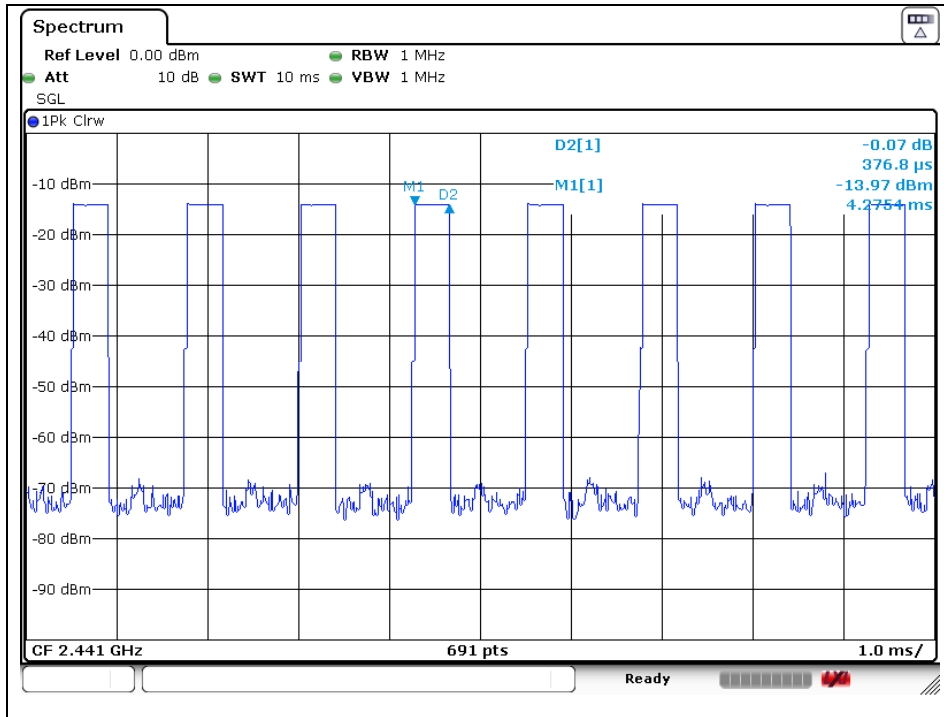

Operating Mode: 8DPSK

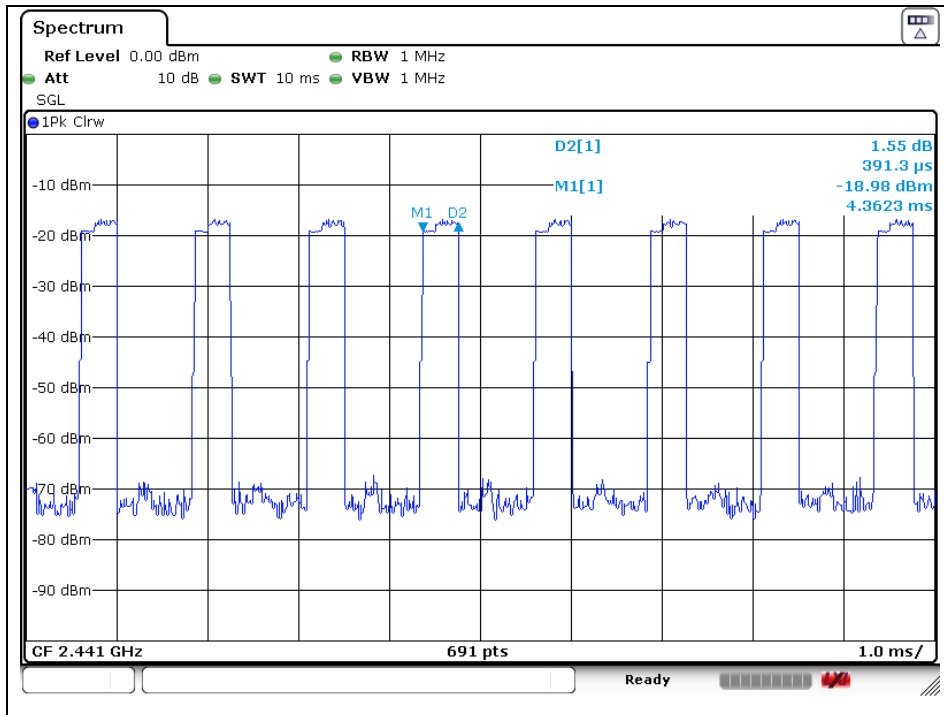

The results shown in this test report refer only to the sample(s) tested unless otherwise stated. This test report cannot be reproduced, except in full, without prior written permission of the Company. This test report does not assure KOLAS accreditation.

7.4.5. Packet Type: DH3, 3DH3 (Adaptive Frequency Hopping)

Operation Mode	Frequency (MHz)	Dwell Time (ms)	Time of occupancy on the Tx Channel in 8 sec (ms)	Limit for time of occupancy on the Tx Channel in 8 sec (ms)
GFSK	2 441	1.64	131.20	400
8DPSK	2 441	1.64	131.20	400

Remark;

Time of occupancy on the TX channel in 8 sec

In case of GFSK and 8DPSK: $1.64 \times \{(800 \div 4) / 20\} \times 8 = 131.20$ ms

The results shown in this test report refer only to the sample(s) tested unless otherwise stated. This test report cannot be reproduced, except in full, without prior written permission of the Company. This test report does not assure KOLAS accreditation.

Operating Mode: GFSK

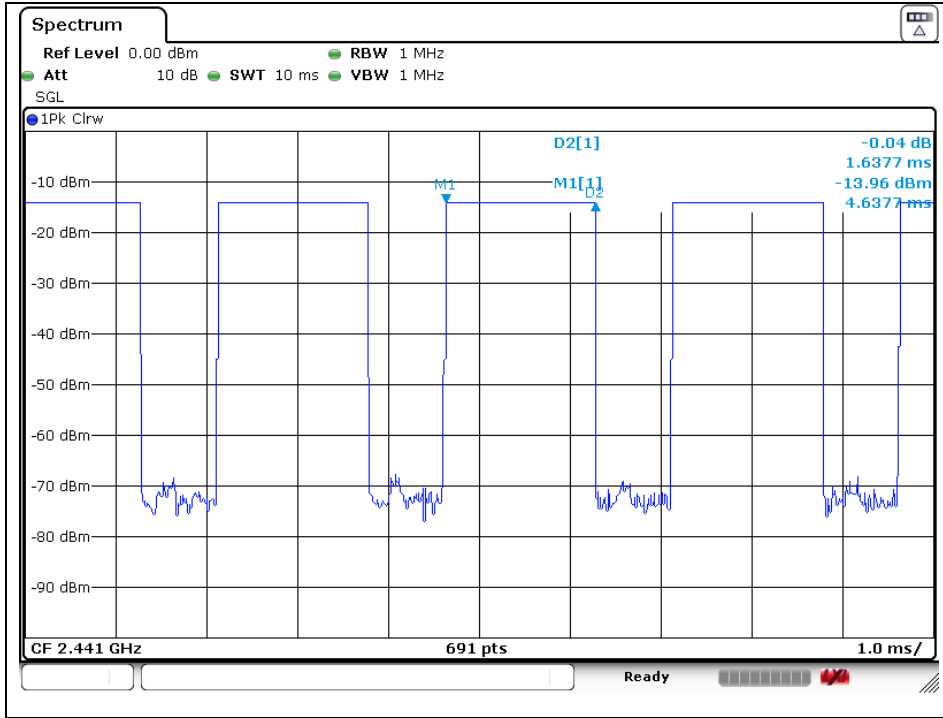

Operating Mode: 8DPSK

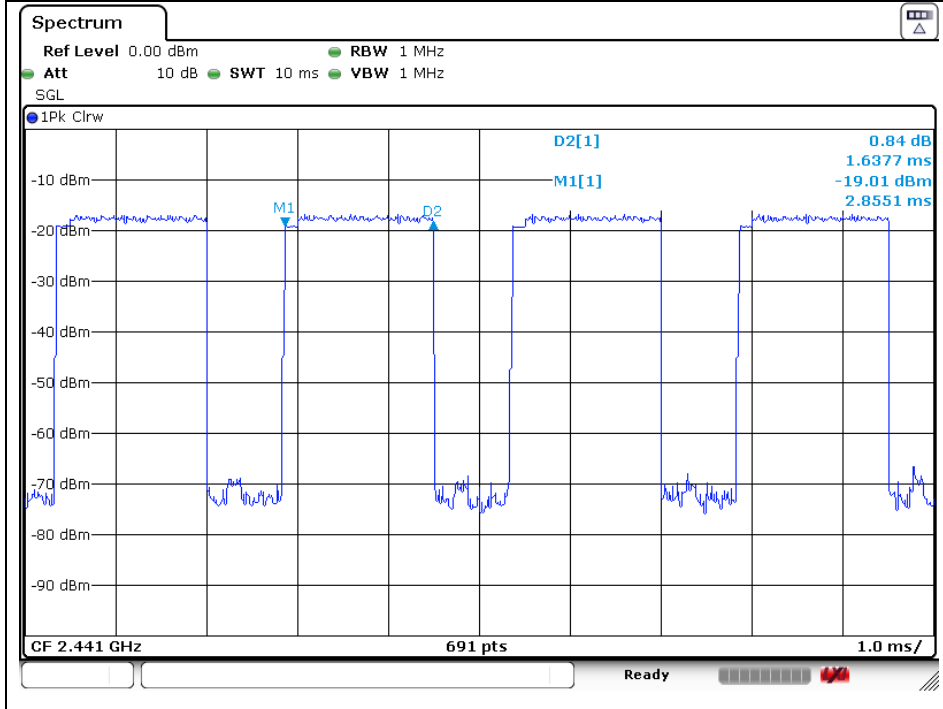

The results shown in this test report refer only to the sample(s) tested unless otherwise stated. This test report cannot be reproduced, except in full, without prior written permission of the Company. This test report does not assure KOLAS accreditation.

7.4.6. Packet Type: DH5, 3DH5 (Adaptive Frequency Hopping)

Operation Mode	Frequency (MHz)	Dwell Time (ms)	Time of occupancy on the Tx Channel in 8 sec (ms)	Limit for time of occupancy on the Tx Channel in 8 sec (ms)
GFSK	2 441	2.88	153.60	400
8DPSK	2 441	2.90	154.67	400

Remark;

Time of occupancy on the TX channel in 8 sec

In case of GFSK: $2.88 \times \{(800 \div 6) / 20\} \times 8 = 153.60$ ms

In case of 8DPSK: $2.90 \times \{(800 \div 6) / 20\} \times 8 = 154.67$ ms

The results shown in this test report refer only to the sample(s) tested unless otherwise stated. This test report cannot be reproduced, except in full, without prior written permission of the Company. This test report does not assure KOLAS accreditation.

SGS Korea Co., Ltd. (Gunpo Laboratory) 4, LS-ro 182beon-gil, Gunpo-si, Gyeonggi-do, Korea, 15807 <http://www.sgsgroup.kr>

RTT5041-19(2017.07.10)(0)

Tel. +82 31 428 5700 / Fax. +82 31 427 2370

A4(210 mm x 297 mm)

Operating Mode: GFSK

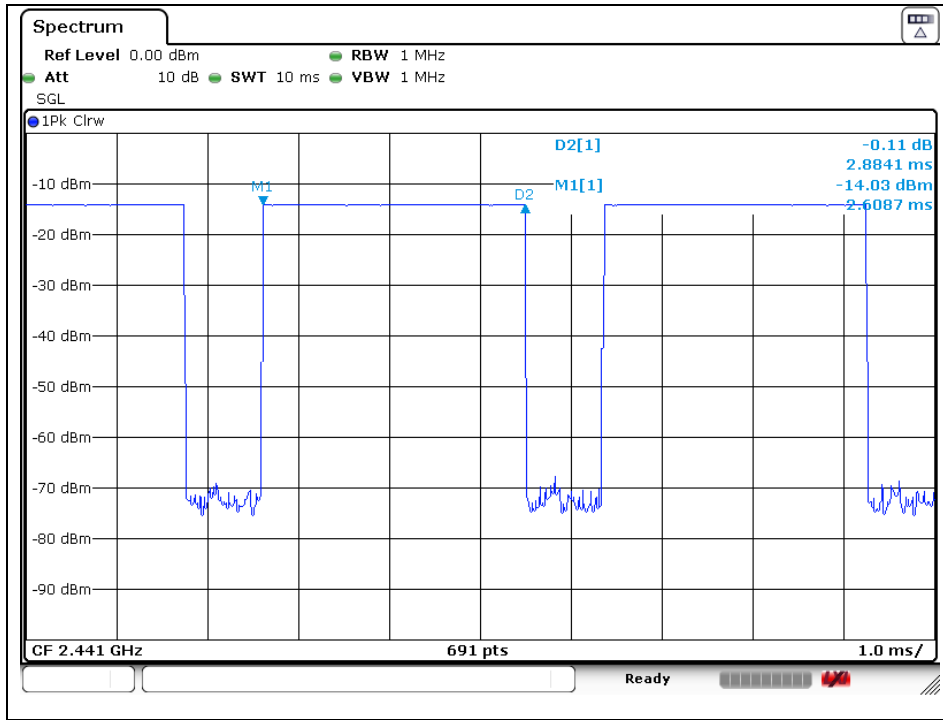

Operating Mode: 8DPSK

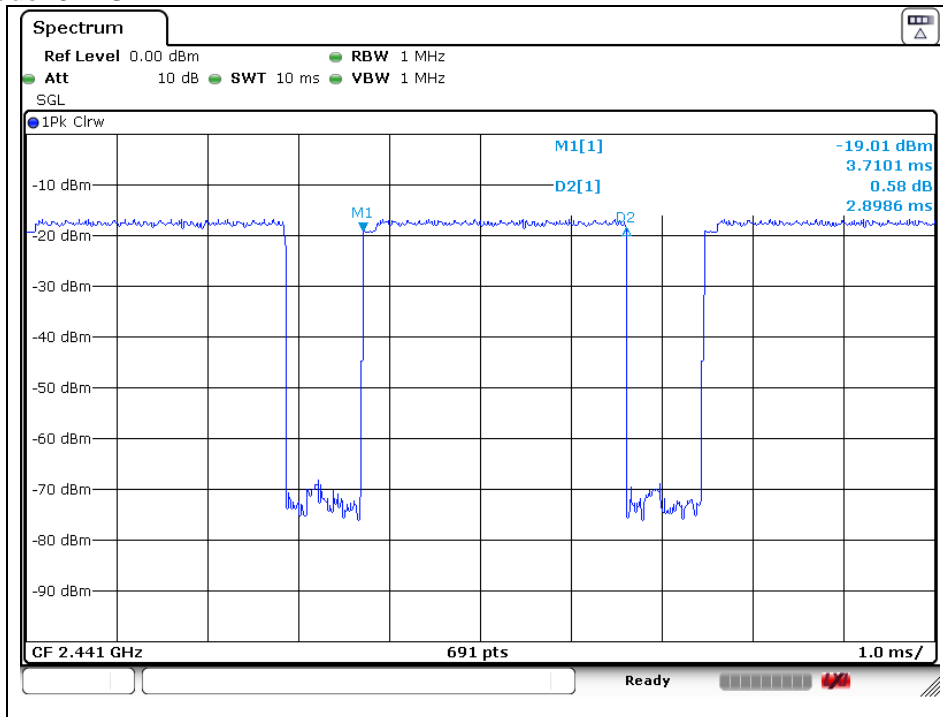

The results shown in this test report refer only to the sample(s) tested unless otherwise stated. This test report cannot be reproduced, except in full, without prior written permission of the Company. This test report does not assure KOLAS accreditation.

8. Antenna Requirement

8.1. Standard Applicable

For intentional device, according to FCC 47 CFR Section §15.203, an intentional radiator shall be designed to ensure that no antenna other than that furnished by the responsible party shall be used with the device. And according to FCC 47 CFR Section §15.247 (b) if transmitting antennas of directional gain greater than 6 dBi are used, the power shall be reduced by the amount in dB that the gain of the antenna exceeds 6 dBi.

8.2. Antenna Connected Construction

Antenna used in this product is PCB pattern antenna with gain of 0.29 dBi.

- End of the Test Report -

The results shown in this test report refer only to the sample(s) tested unless otherwise stated. This test report cannot be reproduced, except in full, without prior written permission of the Company. This test report does not assure KOLAS accreditation.