

# CAR INFOTAINMENT SYSTEM

## QUICK REFERENCE GUIDE

(ATC31HYAN, ATC31HCAN, ATC34HCAN)

To access the **online manual** for Car Infotainment System, scan the **QR code**.



# Reading the manual on web with the QR code

You can access the online user's manual of the system by scanning the QR code with your smartphone.

## Warning

Pull over the vehicle to a safe area and scan the QR code. To ensure your safety, the system does not provide QR codes while driving.

### 1 Scan the QR code by using any of the following methods:

- On the All Menu screen, touch **User's Manual**.
- On the All Menu screen, touch **Setup ► General ► System Info ► User's Manual on Web (QR Code)**.
- Or scan the QR code in the Quick Reference Guide.





### 2 Scan the QR code after installing the QR code reader application from App Store () or Google Play Store (.

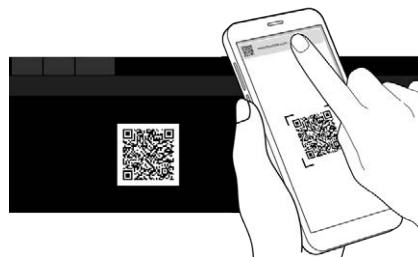

### 3 Touch the URL for User's Manual on Web from the smartphone display.

The online user's manual of the system appears in the Internet browser application on the smartphone.



-  Depending on how you scan the QR code, the online manual may open without touching the URL.
-  With a camera application of your iPhone or Android smartphone, the QR code can also be scanned. Depending on the Android smartphone model, the QR code scanning may not be supported for the provided application. For more details, see the smartphone's manual.
-  When you scan the QR code on each function menu, you can see the usage of the function running (except for several functions).
  - Run the desired function on the system and then touch **Menu ► User's Manual on Web (QR Code)**.
-  Without scanning the QR code, you can directly enter the URL address to see User's Manual on Web. ([http://webmanual.kia.com/STD\\_GEN5\\_WIDE/AVNT/USA/English/index.html](http://webmanual.kia.com/STD_GEN5_WIDE/AVNT/USA/English/index.html))

# Safety Warnings

Be sure to keep the following instructions. Otherwise, it may cause serious injury or accident.

## Driving

---

Obey all traffic laws while driving.

- Relying solely on the navigation system may cause violation of traffic rules and regulations, resulting in an accident.

In order to check the vehicle speed, see the speedometer first, not the speed on the navigation system.

- The speed on the navigation system may differ from actual vehicle speed.

While driving, refrain from watching the screen.

- An accident may occur by negligence in keeping your eyes forward.
- To manipulate the screen or buttons requiring multiple steps, be sure to stop your vehicle.

To use your mobile phone, first stop your vehicle.

- When you use your mobile phone while driving, it may disperse your attention, resulting in an accident.
- When making a call while driving, use the Bluetooth Hands-free function and if possible, minimize the call time.

Make sure that the volume of the phone is sufficiently low so that the external sound is audible.

- When you drive with no external sound present may cause a traffic accident.
- When you drive for a long time with a loud audio volume, it may affect your hearing.

For emergency services (e.g. hospital, fire station), do not rely solely on the navigation system.

- Some emergency services may not be included in the navigation map. Check relevant information in advance to stay prepared for an emergency.

## System handling

---

Do NOT arbitrarily disassemble or modify the system.

- It may cause an accident, fire, or electric shock.

Exercise caution to make sure that no liquid or foreign materials enter the system.

- It may cause smoke generation, fire ignition, or system failure.

When the screen is not displayed, the volume is muted, or other system failures occur, immediately stop using the system.

- Otherwise, it may cause fire, electric shock, or fatal system failure.

 If you experience any problems with the system, contact your place of purchase or dealer.

# Safety Precautions

Be sure to keep the following instructions. Otherwise, it may cause minor injury or system damage.

## Operation

Use the system with the vehicle started.

- When you use the system for a long time with the vehicle stopped, it may cause battery discharge.

Do NOT arbitrarily install an unauthorized aftermarket product in your vehicle.

- Using unapproved products may cause an error while using the system.
- System errors caused by installing unapproved products are not covered under the warranty.

## System handling

Do NOT apply excessive force to the system.

- When you apply excessive pressure to the screen, the LCD panel or touch panel may get damaged.

To clean the screen or button panel, first turn off the vehicle and then use a dry, soft cloth to wipe it.

- Do not wipe using a rough or hard cloth, chemical fiber, organic solvent (e.g. alcohol, benzene, thinner), or air freshener. The panel surface may become scratched or damaged due to a chemical reaction.

When you install an air freshener on the air conditioner vent, the surface may be deformed due to leakage.

 If you experience any problems with the system, contact your place of purchase or dealer.

# Component names and functions

## Control panel

### ① POWER button/VOLUME knob

- Press the button to turn on or off the Radio/Media.
- Press and hold the button to turn off the screen and sound.
- Turn the knob left or right to adjust the system volume.
- Turn the knob while hearing voice navigation to adjust the volume.

### ② System Reset button

- Restarts the system.

### ③ MAP button

- Returns to the current location on the map.
- When pressed while in guidance on the map screen, the voice guidance is repeated.

### ④ NAV button

- Moves to the navigation/route screen.
- When you press and hold the button, the Places screen appears.

### ⑤ Custom button

- Runs the user-defined function.
- Press and hold the button to display the Custom Button settings screen.

#### ⑥ **SEEK/TRACK button**

- Changes the broadcast program channel, music, or file while using the Radio/Media function.
- Press and hold the button to search a broadcast program while listening to the radio.
- Press and hold the button to fast forward or rewind during playback (except for Bluetooth audio mode).

#### ⑦ **RADIO button**

- Turns on the radio.
- When you press the button repeatedly with the radio turned on, it toggles between FM, AM and SiriusXM modes.

#### ⑧ **MEDIA button**

- Run the media.
- Press and hold to display the media selection window.

#### ⑨ **SETUP button**

- Displays the Settings screen.
- When you press and hold the button the SW Info/Update screen appears.

#### ⑩ **TUNE knob/FILE knob/ENTER button**

- Turn the knob to change the frequency and channel while listening to the radio.
- Turn the knob to search for music or file while playing media.
- Press the button to select a channel, music, or file during a search.
- Turn the knob on the map screen to zoom in or out the map (if activated).
- When you press and hold the button, the TUNE Knob Function screen appears.

## Steering wheel remote control

### ① Voice Recognition button

- Press to start voice recognition and press and hold to end voice recognition.
- Press and hold to start or end voice recognition of a connected smartphone via phone projection. (The button's operation may vary depending on smartphone specifications.)

### ② MODE button

- Press the button repeatedly to toggle between the radio and media modes.
- Press and hold the button to display the settings for the Steering Wheel MODE button.

### ③ Volume lever/button

- Volume adjustment.
- Press the button to mute or unmute the volume (except for navigation sound).
- Press the button to pause or resume playback.

### ④ Move lever

- Changes the broadcast program channel, music, or file while using the Radio/Media function.
- Long push or long press to search a broadcast program while listening to the radio.
- Long push or long press to fast forward or rewind while playing media (except for Bluetooth Audio mode).

### ⑤ Call button

- Before connection of Bluetooth: Press to display the Bluetooth connection window.
- After connection of Bluetooth: Press to display the recent calls list, press and hold to redial the last number, and press for an incoming call to answer it.
- On a Bluetooth call: Press to switch to Call Waiting and press and hold to switch between the system and mobile phone.

### ⑥ End Call button

- During a Bluetooth call, press to end the call.
- Press to ignore a call with the Bluetooth connected.

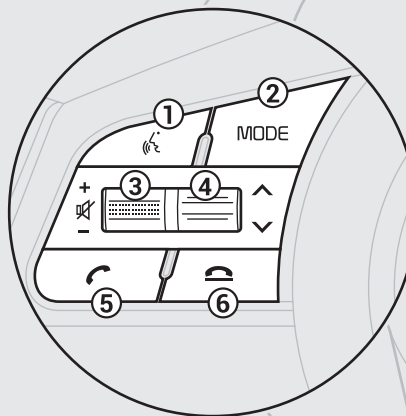



# Turning the system on or off

## Turning on the system

- 1 Turn on the vehicle.
- 2 When a safety warning message appears, read it and touch **Confirm**.
  - ✍ To change the display language, touch **Language**.

## Turning off the system

To turn off the system while driving, press and hold the Power button on the panel.

The screen and sound will be turned off.

- ✍ To use the system again, press the Power button.
- ✍ When a specified period of time elapses after turning off the vehicle, the system automatically shuts down. When you open the driver's door, the system immediately shuts down.

## Warning

- Driving while distracted can result in a loss of vehicle control that may lead to an accident, severe bodily injury, or death. The driver's primary responsibility is the safe and legal operation of the vehicle, and the use of any vehicle systems, including the touch screen and steering wheel controls, which take the driver's eyes, attention, and focus away from the safe operation of the vehicle, or which are not permissible by law, should never be used during the operation of the vehicle.
- Some functions may not be active while driving to ensure safety. Those functions run only when the vehicle is stationary. In order to use them, first stop the vehicle.
- When the screen is not displayed, the volume is muted, or other system failures occur, immediately stop using the system. When you use the faulty system continuously, it may cause fire, electric shock, or fatal system failure.

## Caution

- The system can be turned on even when the ignition switch is in "ACC" or "ON." However, when you use the system without turning on the vehicle for a long time, it may cause battery discharge. To use the system for a long time, be sure to turn on the vehicle.
- When you use the system with the vehicle turned off, the battery warning message appears. The warning message disappears as soon as you turn on the vehicle.

# Product specifications

## Common specifications

Item	Specifications
External dimensions	
Weight	

## Display

Item	Specifications
Display size	AV body - 10.25 inch (243.65 x 91.37 mm)
Number of pixels	AV body - 1,382,400 pixels (resolution: 1920 x 720)
Drive system	TFT (Thin Film Transistor) active matrix system
Viewing angle	AV body - Horizontal/vertical: 89°
Internal lighting	LED

# Disclaimers

- Driving while distracted is dangerous and should be avoided. Drivers should remain attentive to driving and always exercise caution when using the steering-wheelmounted controls while driving.
- Driving while distracted can result in a loss of vehicle control that may lead to an accident, severe personal injury and death. The driver's primary responsibility is in the safe and legal operation of a vehicle, and use of any handheld devices, other equipment or vehicle systems which take the driver's eyes, attention and focus away from the safe operation of a vehicle or that are not permissible by law should never be used during operation of the vehicle.
- SiriusXM®: SiriusXM Satellite Radio, SiriusXM Traffic and SiriusXM Travel Link each require a subscription sold separately, or as a package, by SiriusXM Radio Inc. If you decide to continue your service at the end of your trial subscription, the plan you choose will automatically renew and bill at then-current rates until you call 1-866-635-2349 to cancel. See SiriusXM Customer Agreement for complete terms at [www.siriusxm.com](http://www.siriusxm.com). Other fees and taxes will apply. All fees and programming are subject to change. Not all vehicles or devices are capable of receiving all services offered by SiriusXM. Data displays and individual product availability vary by vehicle hardware. Current information and features may not be available in all locations, or on all receivers. Weather Forecast, Current Conditions may not be available in all locations. Images above are for representative purposes only and are not real products. For actual features and images of real products, consult the vehicle manufacturer. SiriusXM is not responsible for any errors or inaccuracies in the data

services or their use in the vehicle. Travel Link Stocks displays current price and daily delta of around 7,000 actively reported securities traded on the NYSE®, NASDAQ® and AMEX®. The service is delayed approximately 20 minutes. SiriusXM satellite service is available only to those at least 18 years of age in the 48 contiguous USA, DC, and Puerto Rico (with coverage limitations). SiriusXM Internet Radio service is available throughout our satellite service area and in AK and HI. ©2018 SiriusXM Radio Inc.

- Android Auto: Vehicle user interface is a product of Google and its terms and privacy statements apply. Requires the Android Auto app on Google Play and an Android compatible smartphone running Android™ 5.0 Lollipop or higher. Data plan rates apply.
- Navigation: Distracted driving can result in a loss of vehicle control. When operating a vehicle, never use a vehicle system that takes your focus away from safe vehicle operation. Navigation is for information purposes only, and Kia does not make any warranties about the accuracy of the information.

# FCC Certification

This equipment has been tested and found to comply with the limits for a Class B digital device, pursuant to part 15 of the FCC Rules. These limits are designed to provide reasonable protection against harmful interference in a residential installation.

This equipment generates, uses and can radiate radio frequency energy and, if not installed and used in accordance with the instructions, may cause harmful interference to radio communications. However, there is no guarantee that interference will not occur in a particular installation. If this equipment does cause harmful interference to radio or television reception, which can be determined by turning the equipment off and on, the user is encouraged to try to correct the interference by one or more of the following measures:

- Reorient or relocate the receiving antenna.
- Increase the separation between the equipment and receiver.
- Connect the equipment into an outlet on a circuit different from that to which the receiver is connected.
- Consult the dealer or an experienced radio/TV technician for help.

Caution: Any changes or modifications to this device not explicitly approved by manufacturer could void your authority to operate this equipment.

This device complies with part 15 of the FCC Rules. Operation is subject to the following two conditions: (1) This device may not cause harmful interference, and (2) this device must accept any interference received, including interference that may cause undesired operation.

This equipment complies with FCC radiation exposure limits set forth for an uncontrolled environment.

This equipment should be installed and operated with minimum 20 cm between the radiator and your body. This transmitter must not be co-located or operating in conjunction with any other antenna or transmitter unless authorized to do so by the FCC.

# Car Infotainment System User's Manual

- This guide covers specifications for all vehicle models, including optional specifications, and is based on the latest version of system software.
- The design and specification of the system may change without prior notice for performance improvement.
- In order to improve the product performance, the functions and services in this manual are subject to change without notice. In case of software update, the screens in this manual may differ from actual ones on the product.
- For more information about the functions and services updated for performance improvement, access the online user's manual.
- Functions and services in this manual may differ from those in the actual vehicle. For more details, refer to the owner's manual or brochure of your vehicle.
- Your system is not compatible with the system software and map data for regions outside of the country of purchase.

# Available materials for operation



## Quick Reference Guide

Provided in the format of a booklet. It provides brief information of the system, including basic controls and main functions.



## User's Manual on Web

To see the information while using the system, touch **Menu ► User's Manual on Web (QR Code)**. By scanning the QR code with your smartphone, you can access the online user's manual.

# Symbols in this User's Manual



Warning

Indicates very important information directly related to user safety. Failure to follow instructions may cause serious injury.



Caution

Indicates important information directly related to user safety. Failure to follow instructions may cause minor injury or vehicle damage or breakdown.



Note

Indicates helpful information for operation of the product.

If equipped

Indicates descriptions for optional features, which may not be available on your specific vehicle depending on the model or trim level.

This guide covers specifications for all vehicle models, including optional specifications. It may include descriptions for features that are not equipped in your vehicle or are unavailable for your vehicle model.

HEV only

Displays only the functions that can be used in a hybrid vehicle.

PHEV only

Displays only the functions that can be used in a plug-in hybrid vehicle.

EV only

Displays only the functions that can be used in an electric vehicle.

# Safety Warnings

Be sure to keep the following instructions. Otherwise, it may cause serious injury or accident.

## **Driving**

---

Obey all traffic laws while driving.

- Relying solely on the navigation system may cause violation of traffic rules and regulations, resulting in an accident.

In order to check the vehicle speed, see the speedometer first, not the speed on the navigation system.

- The speed on the navigation system may differ from actual vehicle speed.

While driving, refrain from watching the screen.

- An accident may occur by negligence in keeping your eyes forward.
- To manipulate the screen or buttons requiring multiple steps, be sure to stop your vehicle.

To use your mobile phone, first stop your vehicle.

- When you use your mobile phone while driving, it may disperse your attention, resulting in an accident.
- If necessary, use handsfree (Bluetooth) calling when driving and minimize the call time.

Make sure that the volume of the phone is sufficiently low so that the external sound is audible.

- When you drive with no external sound present may cause a traffic accident.
- When you drive for a long time with a loud audio volume, it may affect your hearing.

For emergency services (e.g. hospital, fire station), do not rely solely on the navigation system.

- Some emergency services may not be included in the navigation map.  
Check relevant information in advance to stay prepared for an emergency.

## **System handling**

---

Do NOT arbitrarily disassemble or modify the system.

- It may cause an accident, fire, or electric shock.

Exercise caution to make sure that no liquid or foreign materials enter the system.

- It may cause smoke generation, fire ignition, or system failure.

When the screen is not displayed, the volume is muted, or other system failures occur, immediately stop using the system.

- Otherwise, it may cause fire, electric shock, or fatal system failure.

 If you experience any problems with the system, contact your place of purchase or dealer.



# Safety Precautions

Be sure to keep the following instructions. Otherwise, it may cause minor injury or system damage.

## Operation

Use the system with the vehicle started.

- When you use the system for a long time with the vehicle stopped, it may cause battery discharge.

Do NOT arbitrarily install an unauthorized aftermarket product in your vehicle.

- Using unapproved products may cause an error while using the system.
- System errors caused by installing unapproved products are not covered under the warranty.

## System handling

Do NOT apply excessive force to the system.

- When you apply excessive pressure to the screen, the LCD panel or touch panel may get damaged.

To clean the screen or button panel, first turn off the vehicle and then use a dry, soft cloth to wipe it.

- Do not wipe using a rough or hard cloth, chemical fiber, organic solvent (e.g. alcohol, benzene, thinner), or air freshener. The panel surface may become scratched or damaged due to a chemical reaction.

When you install an air freshener on the air conditioner vent, the surface may be deformed due to leakage.

 If you experience any problems with the system, contact your place of purchase or dealer.

# Contents

## 01

### System overview

Component names and functions	1-2
Control panel	1-2
Steering wheel remote control	1-3
Turning the system on or off	1-4
Turning on the system	1-4
Turning off the system	1-5
Using the touch screen	1-6
"Touch" gesture	1-7
"Touch and hold" gesture	1-7
"Slide" gesture	1-8
"Drag" gesture	1-8
"Swipe" gesture	1-9
"Spread/pinch" gesture	1-9
Using the Home screen	1-10
Home screen	1-10
Editing widgets on the Home screen	1-11
Editing icons on the Home screen	1-11
Seeing the all menus screen	1-12

Using the split screen	1-12
Opening the split screen	1-12
Editing the split screen	1-13
Closing the split screen	1-13

## 02

### Useful functions

Using the First Run Setup	2-2
Using the phone projection function	2-4
Pairing to an Android smartphone via Android Auto	2-4
Pairing to an iPhone via Apple CarPlay	2-6
Using the driving assist display	2-8
Using the rear-view display	2-9
Surround View Monitor	2-11
Using the climate control system	2-13
Using the rear-seat climate control system	2-14
Using the Driver Talk mode in the rear seat	2-15
Using the Quiet mode in the rear seat	2-16
Using the sound mood lamp	2-16

Playing Sounds of Nature	2-17
Using the HD Radio Data	2-18
Seeing traffic information by using HD radio data	2-19
Seeing weather information by using HD radio data	2-20
Seeing weather information by using Doppler weather radar	2-20
Seeing fuel price information by using HD radio data	2-21
Seeing the driving information	2-21
Seeing notifications	2-22

## 03

Listening to the radio	3-2
Radio screen	3-2
Changing the radio mode	3-4
Changing the radio channel	3-4
Saving the current radio channel	3-5
Editing the radio channel list	3-6
Listening to HD Radio™	3-7
HD Radio™ Technology	3-7
Listening to SiriusXM™ radio	3-8
Changing to SiriusXM mode	3-8
Searching for SiriusXM radio channels	3-10
Selecting channels by using channel numbers	3-10
Seeing the program schedule	3-11
Listening to Featured Favorites channels	3-11

## Radio

## 04

Using media	4-2
Listening to music from a USB device	4-2
Listening to music via Bluetooth	4-7

## Media

## 05

Navigation functions	5-2
Navigation Menu overview	5-2
Finding a route easily	5-3
Map screen	5-6
Adjusting the navigation volume	5-8
Stopping the route guidance	5-9
Seeing traffic Information	5-9
Various ways to find routes	5-10
Searching by keyword	5-10
Searching by previous destinations	5-12
Searching for Kia Dealerships	5-13
Searching the nearby points of interest	5-14
Searching for restaurants	5-17
Searching for emergency services	5-17
Editing the route	5-18
Changing the route search criteria	5-21
Avoiding specific zones	5-22

## Navigation

<b>Using the address book</b>	5-22
Registering a searched place as a favorite place	5-22
Registering the current position as a favorite place	5-24
Registering a frequently visited place as a favorite place	5-24
Setting a registered favorite place as a destination	5-25
Registering a frequently visited place as a destination	5-25
Editing the registered place	5-26
Deleting a registered favorite place(s)	5-26
Importing/exporting the address book	5-27
<b>Searching for gas stations</b>	5-27
<b>Searching for EV (Electric Vehicle) charging stations</b>	5-28

## 06

<b>Connecting a Bluetooth device</b>	6-2
Registering a device	6-3
Connecting a registered device	6-4
Disconnecting a registered device	6-6
Deleting a registered device	6-6
<b>Making a call via Bluetooth</b>	6-7
Dialing from the recent call list	6-7
Dialing from the favorites list	6-9
Dialing from the contacts	6-11
Using the dial pad	6-13
Dialing with voice recognition	6-15

## Phone

<b>Accepting an incoming call over Bluetooth</b>	6-15
Rejecting a call	6-16
Using functions during a call	6-16
<b>Checking a new message over Bluetooth</b>	6-18
Checking a new message	6-18
Checking a new message from the list	6-19
Sending a text by using the voice recognition	6-20

## 07

## Voice functions

<b>Voice recognition</b>	7-2
Using the voice recognition	7-2
Seeing the voice recognition help	7-4
Available voice commands	7-6
POI names	7-11
<b>Using the Siri Eyes Free</b>	7-19
<b>Voice Memo</b>	7-20
Using the voice memos	7-20
Recording a voice memo	7-21
Playing a voice memo	7-21

# 08

UVO service	8-2
Service restrictions	8-2
Subscribing to the service	8-3
<b>Running the UVO</b>	<b>8-4</b>
Contacting for roadside assistance	8-5
Using the received location information	8-6
Diagnosing the vehicle	8-7
Checking maintenance service intervals	8-8
Contacting the UVO Center	8-8
Using Voice Local Search	8-9
Configuring the UVO settings	8-9

# UVO

# 09

Configuring the vehicle settings	9-2
Drive Mode	9-2
Climate	9-3
Lights	9-4
Seat/Steering Wheel	9-5
<b>Configuring the device connection settings</b>	<b>9-6</b>
Bluetooth	9-6
Android Auto	9-7
Apple CarPlay	9-7
<b>Configuring the advanced system settings</b>	<b>9-8</b>
Return to Map: Set Time	9-8
TUNE Knob Function	9-8
Custom Button ☆	9-9
Steering Wheel MODE Button	9-9
Home Screen	9-9
Split Screen	9-10
My Data	9-10
Extend Rear Camera Use	9-10

# Settings

<b>Configuring the sound settings</b>	<b>9-11</b>	<b>Configuring the user profile settings</b>	<b>9-27</b>
Position	9-11	Profile Settings	9-27
Volume	9-12	<b>Configuring the general system settings</b>	<b>9-28</b>
Advanced	9-12	Date/Time	9-28
Tone	9-13	Language	9-29
Priority	9-13	Keyboard	9-29
Navigation Volume	9-14	Units	9-30
Reset	9-15	Screen Saver	9-30
Turning on/off the screen touch sound	9-15	SW Info/Update	9-31
<b>Configuring the voice recognition settings</b>	<b>9-15</b>	System Info	9-32
Use Network	9-16	<b>Configuring the display settings</b>	<b>9-33</b>
Guidance	9-16	Mode	9-33
<b>Configuring the navigation settings</b>	<b>9-17</b>	Illumination	9-33
Display	9-17	Blue Light Filter	9-34
Guidance	9-18	Reset	9-34
Traffic	9-19	<b>Configuring the media settings</b>	<b>9-35</b>
Volume Control	9-19	Media Change Notifications	9-35
Reset	9-20	Repeat Folder	9-35
Display	9-20	<b>Updating the system software and map</b>	<b>9-36</b>
Guidance	9-22		
Others	9-23		
<b>Configuring the UVO settings</b>	<b>9-25</b>		
Activate UVO	9-25		
911 Connect	9-25		
Modem Information	9-26		
Modem Status	9-26		

# 10

## Appendix

Solutions	10-2
System status indicator icons	10-9
FAQ	10-11
Product specifications	10-13
Important information	10-17
Index	10-20
Trademarks	10-25
Open Source Information	10-26

MEMO





# 01

## System overview



Component names and functions

Turning the system on or off

Using the touch screen

Using the Home screen

Seeing the all menus screen

Using the split screen

# Component names and functions

The following describes the part names and controls on the control panel and steering wheel.

## Control panel

 The shape may differ depending on the vehicle model and specifications. For more information, see “Quick Reference Guide” that is separately provided.

- 
- |   |   |
|---|---|
| <b>POWER button (POWER/PWR)/<br/>VOLUME knob (VOLUME/VOL)</b> | <ul style="list-style-type: none"><li>• Press the button to turn on or off the Radio/Media.</li><li>• Press and hold the button to turn off the screen and sound.</li><li>• Turn the knob left or right to adjust the system volume.</li><li>• Turn the knob while hearing voice navigation to adjust the volume.</li></ul> |
|---|---|

- 
- |                   |   |
|-------------------|---|
| <b>MAP button</b> | <ul style="list-style-type: none"><li>• Returns to the current location on the map.</li><li>• When pressed while in guidance on the map screen, the voice guidance is repeated.</li></ul> |
|-------------------|---|
- 

- 
- |                   |  |
|-------------------|--|
| <b>NAV button</b> | <ul style="list-style-type: none"><li>• Moves to the navigation/route screen.</li><li>• When you press and hold the button, the Places screen appears.<br/>▶ See “Searching by keyword.”</li></ul> |
|-------------------|--|
- 

- |                     |  |
|---------------------|--|
| <b>RADIO button</b> | <ul style="list-style-type: none"><li>• Turns on the radio.</li><li>• When you press the button repeatedly with the radio turned on, it toggles between FM, AM and SiriusXM modes.</li></ul> |
|---------------------|--|
- 

- |                     |  |
|---------------------|--|
| <b>MEDIA button</b> | <ul style="list-style-type: none"><li>• Run the media.</li><li>• Press and hold to display the media selection window.</li></ul> |
|---------------------|--|
- 



- |                          |  |
|--------------------------|--|
| <b>SEEK/TRACK button</b> | <ul style="list-style-type: none"><li>• Changes the broadcast program channel, music, or file while using the Radio/Media function.</li><li>• Press and hold the button to search a broadcast program while listening to the radio.</li><li>• Press and hold the button to fast forward or rewind during playback (except for Bluetooth audio mode).</li></ul> |
|--------------------------|--|
- 

- |                          |  |
|--------------------------|--|
| <b>Custom button (☆)</b> | <ul style="list-style-type: none"><li>• Runs the user-defined function.</li><li>• Press and hold the button to display the Custom button settings screen.<br/>▶ See “Custom Button ☆.”</li></ul> |
|--------------------------|--|
-

<b>SETUP button</b>	<ul style="list-style-type: none"> <li>• Displays the Settings screen.</li> <li>• When you press and hold the button the SW Info/Update screen appears. <ul style="list-style-type: none"> <li>▶ See “SW Info/Update.”</li> </ul> </li> </ul>
<b>TUNE knob/ FILE knob/ ENTER button</b>	<ul style="list-style-type: none"> <li>• Turn the knob to change the frequency and channel while listening to the radio.</li> <li>• Turn the knob while playing media to scan for music or file.</li> <li>• Press the button to select a channel, music, or file during a search.</li> <li>• Turn the knob on the map screen to zoom in or out the map (if activated). <ul style="list-style-type: none"> <li>▶ See “TUNE Knob Function.”</li> </ul> </li> <li>• When you press and hold the button, the TUNE Knob Function screen appears. ▶ See “TUNE Knob Function.”</li> </ul>
<b>System Reset button</b>	<ul style="list-style-type: none"> <li>• Restarts the system.</li> </ul>

## Steering wheel remote control

 The shape may differ depending on the vehicle model and specifications. For more information, see “Quick Reference Guide” that is separately provided.

<b>Voice Recognition button</b> (  )	<ul style="list-style-type: none"> <li>• Press to start voice recognition and press and hold to end voice recognition.</li> <li>• Press and hold to start or end voice recognition of a connected smartphone via phone projection. (The button's operation may vary depending on smartphone specifications.)</li> </ul>
<b>MODE button</b>	<ul style="list-style-type: none"> <li>• Press the button repeatedly to toggle between the radio and media modes.</li> <li>• Press and hold the button to display the settings for the Steering wheel MODE button: ▶ see “Steering Wheel MODE Button.”</li> </ul>
<b>Volume lever/button (+/-)</b>	<ul style="list-style-type: none"> <li>• Volume adjustment.</li> </ul>
<b>Mute button</b> (  )	<ul style="list-style-type: none"> <li>• Press the button to mute or unmute the volume (except for navigation sound).</li> <li>• Press the button to pause or resume playback.</li> </ul>

---

**Move lever/button**  
(^/v)

- Changes the broadcast program channel, music, or file while using the Radio/Media function.
- Long push or long press to search a broadcast program while listening to the radio.
- Long push or long press to fast forward or rewind while playing media (except for Bluetooth Audio mode).

---

**Call button**  
(☎)

- Before connection of Bluetooth: Press to display the Bluetooth connection window.
- After connection of Bluetooth: Press to display the recent calls list, press and hold to redial the last number, and press for an incoming call to answer it.
- On a Bluetooth call: Press to switch to Call Waiting and press and hold to switch between the system and mobile phone.

---

**End Call button**  
(📞)

- During a Bluetooth call, press to end the call.
  - Press to ignore a call with the Bluetooth connected.
- 

## Turning the system on or off

The following explains how to turn on or off the system. Before using the system, be sure to read the user's manual for safe and convenient manipulation.

### Turning on the system

- 1 Turn on the vehicle.
- 2 When a safety warning message appears, read it and touch **Confirm**.

 To change the display language, touch **Language**.

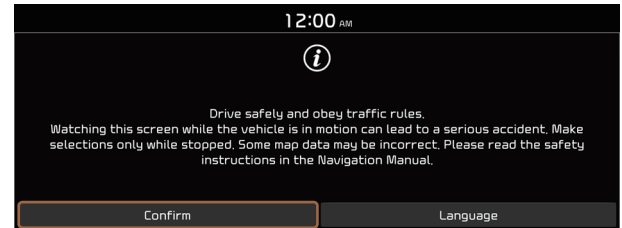

Type A

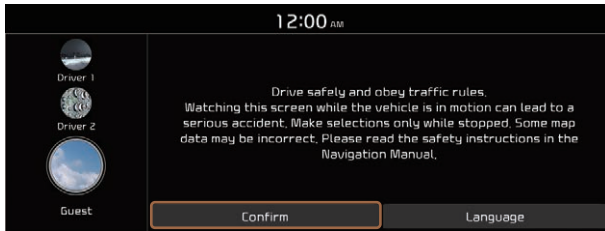

Type B

- ✎ The screen may differ depending on the vehicle model and specifications.
- ✎ To set the user profile, note the following. ► See “Using the First Run Setup (if equipped)”

## Turning off the system

To turn off the system while driving, press and hold the Power button on the panel.

The screen and sound will be turned off.

- ✎ To use the system again, press the Power button.
- ✎ When a specified period of time elapses after turning off the vehicle, the system automatically shuts down. When you open the driver's door, the system immediately shuts down.

### Warning

- Driving while distracted can result in a loss of vehicle control that may lead to an accident, severe bodily injury, or death. The driver's primary responsibility is the safe and legal operation of the vehicle, and the use of any vehicle systems, including the touch screen and steering wheel controls, which take the driver's eyes, attention, and focus away from the safe operation of the vehicle, or which are not permissible by law, should never be used during the operation of the vehicle.
- Some functions may not be active while driving to ensure safety. Those functions run only when the vehicle is stationary. In order to use them, first stop the vehicle.
- When the screen is not displayed, the volume is muted, or other system failures occur, immediately stop using the system. When you use the faulty system continuously, it may cause fire, electric shock, or fatal system failure.

## ⚠ Caution

- The system can be turned on even when the ignition switch is in "ACC" or "ON." However, when you use the system without turning on the vehicle for a long time, it may cause battery discharge. To use the system for a long time, be sure to turn on the vehicle.
- When you use the system with the vehicle turned off, the battery warning message appears. The warning message disappears as soon as you turn on the vehicle.

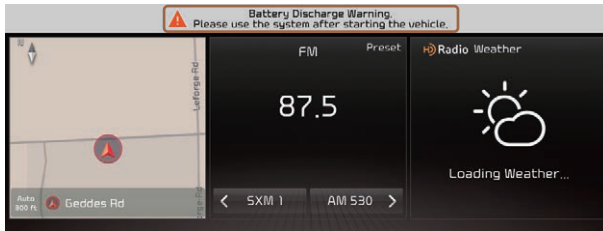

- ✍ The screen may differ depending on the vehicle model and specifications.
- ✍ When you turn off and on the vehicle, the system is turned on with the mode and settings used when the vehicle was turned off.
- ✍ To prevent audio from playing loud when you turn on the vehicle, adjust the system volume to an adequate level.
- ✍ To automatically decrease the system volume, move to the All Menus screen and touch **Setup ▶ Sound ▶ Priority ▶ Start-up Volume Limit** to set the function. ▶ See "Start-up Volume Limit."

## Using the touch screen

This system is equipped with a touch-enabled screen. You can use various practices by using this feature.

## ⚠ Warning

Do not use the touch screen while driving as this will divert your attention away from the safe operation of the vehicle. You may lose your steering control which could cause an accident and severe bodily injuries.

## ⚠ Caution

- Do not press the touch screen with excessive force or a sharp object. The touch screen may become damaged.
- Be careful for the touch screen not to contact any electrically charged object. Static or other electric shock may cause the system to malfunction or damage the touch screen.
- ✍ The touch screen does not respond when you are wearing gloves. Take off the gloves or wear electrostatic touch gloves.

## “Touch” gesture

Lightly touch the desired item and release the finger.

The corresponding function is run or the corresponding menu is selected.

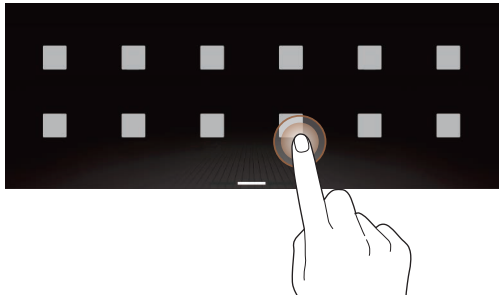

## “Touch and hold” gesture

Touch and hold the desired item.

It is used to fast forward or rewind during playback.

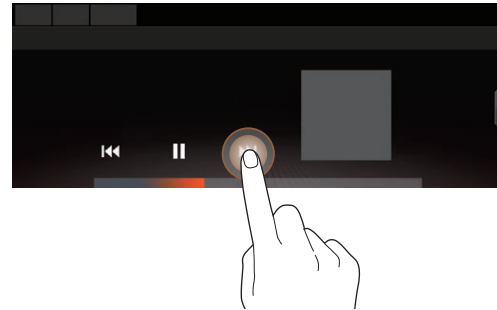

## “Slide” gesture

On the media playback screen, touch the slide bar to change the playback position.

You can change the playback position during playback.

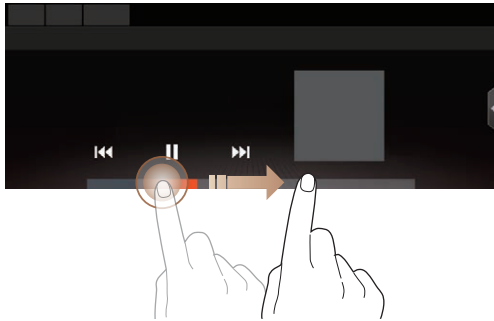

## “Drag” gesture

Touch and hold the desired item and drag it to another position.

The selected item moves to the new position.

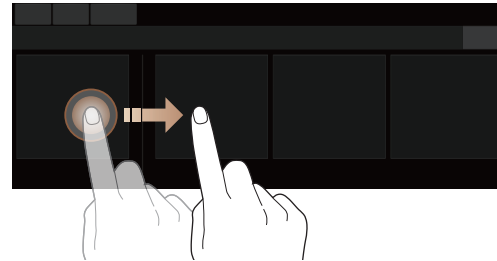



## “Swipe” gesture

Lightly swipe the screen in the desired direction.

It is used to move fast vertically or horizontally across the menu screen or options list.

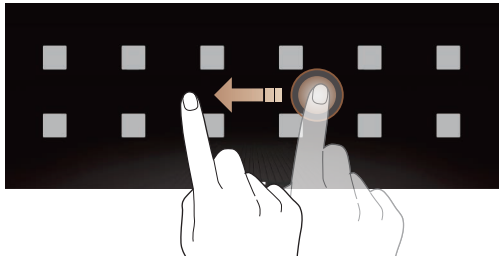

## “Spread/pinch” gesture

On the map screen, touch and hold the screen with two fingers and spread or pinch the fingers.

It is used to zoom in or out the map.

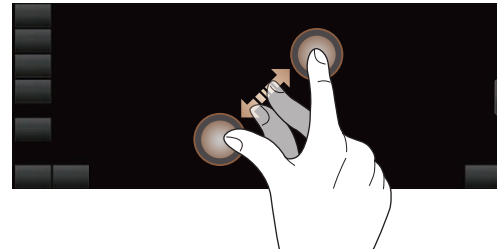

# Using the Home screen

The Home screen provides various functions.

 To return to the Home screen from other screens, touch .

## Home screen

The Home screen layout is as follows:



- 1 Current time. Depending on the vehicle model or specifications, time and date display may vary. Touch to access the time and date settings screen. ▶ See "Date/Time"
- 2 System status icons. Status icons are not included in the screenshots in this guide, because their appearance may differ depending on the system status or mode. ▶ See "System status indicator icons."
- 3 Displays active widgets. When a widget is touched, the corresponding function runs in full screen. ▶ See "Editing widgets on the Home screen."

- 4 Displays the specified user profile image. When the image is pressed, the user profile setting screen appears (if equipped).  
▶ See "Configuring the user profile settings (if equipped)."
- 5 The list of menu items appears.
  - **Edit Home Widgets:** Used to edit the types and positions of widgets on the Home screen.
  - **Edit Home Icons:** Used to edit the types of icons on the Home screen.
  - **User's Manual on Web (QR Code):** Displays the QR code that provides access to the online user manual for the system.

 The screen may differ depending on the vehicle model and specifications.

 To see all menus on the Multi-page Home screen, swipe the screen to the left.

## Editing widgets on the Home screen

You can edit the types and positions of the widgets to display on the Home screen.

- 1 At the upper left of the Home screen, touch **Menu** ► **Edit Home Widgets**.
- 2 Perform any of the following methods:
  - To change the widget type, touch and hold the desired widget on ① List of widgets and then drag it to ② Widget area.
  - To change the listed order for widgets, touch and hold a widget on ② Widget area and then drag it to the desired position.



① List of widgets

② Widget area

- ✍ The screen may differ depending on the vehicle model and specifications.
- ✍ To initialize the types and positions of widgets, touch **Reset**.

## Editing icons on the Home screen

You can see and rearrange the list of icons in the Home screen.

- 1 At the upper left of the Home screen, touch **Menu** ► **Edit Home Icons**.
- 2 To change the location of an icon, touch and hold, and drag the icon to the desired position.



- ✍ The screen may differ depending on the vehicle model and specifications.
- ✍ To initialize the positions of icons, touch **Reset**.

# Seeing the all menus screen

You can see all menus on the Home screen.

Touch and gently swipe the Home screen to the left as shown below.

The All Menu screen appears. You can see the list of all functions of the system.



✍ The screen may differ depending on the vehicle model and specifications.

# Using the split screen (if equipped)

You can set to display various information such as map, Radio/Media info, driving info, and clock on the split system screen.

## Opening the split screen

Touch the split screen button.

The split screen appears on the right.

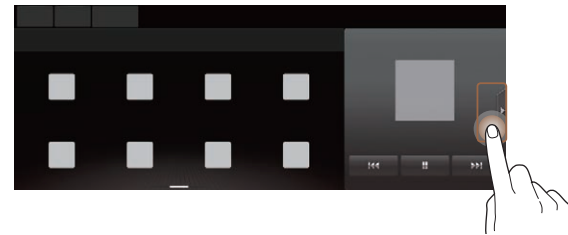

✍ When the **Menu** button exists at the top of the screen, you can open the split screen by touching **Menu ► Split Screen**.



## Editing the split screen

You can change information on the split screen.

Touch and hold, and then drag the split screen up or down to select the desired information item.



## Closing the split screen

Touch the split screen button when the split screen is open.

✎ When the **Menu** button exists at the top of the screen, you can close the split screen by touching **Menu ► Split Screen**.

MEMO



# 02

## Useful functions



Using the First Run Setup

Using the phone projection function

Using the driving assist display

Using the climate control system

Using the rear-seat climate control system

Using the Driver Talk mode in the rear seat

Using the Quiet mode in the rear seat

Using the sound mood lamp

Playing Sounds of Nature Using the HD Radio Data

Seeing the driving information

Seeing notifications

# Using the First Run Setup

(if equipped)

You can configure the system settings for each driver when multiple people are using the vehicle.

In First Run Setup, you can configure the values to display on the screen such as user name, language, and map display method.

- 1 When a safety warning message appears, read it, select the driver image, and then touch **Confirm**.

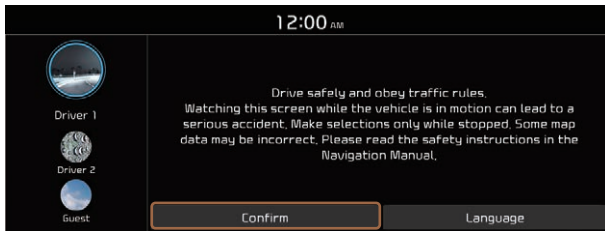

- ✎ When you log in as guest, you cannot configure the profile settings. To set a different profile, select another user.
- ✎ You can register up to 2 users.

- 2 When the First Run Setup screen appears, touch **Start**.

- ✎ To use the default settings without changing the environment, touch **Skip**.

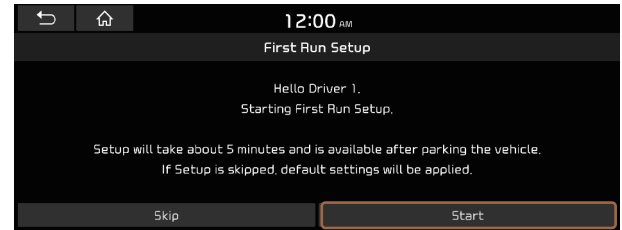

- 3 Set the language to display on the screen and then touch **Next**.

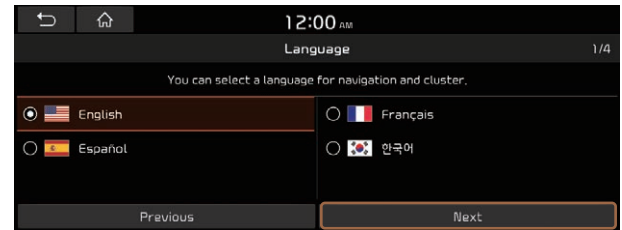



- 4 Set the keyboard type for text entry and then touch **Next**.

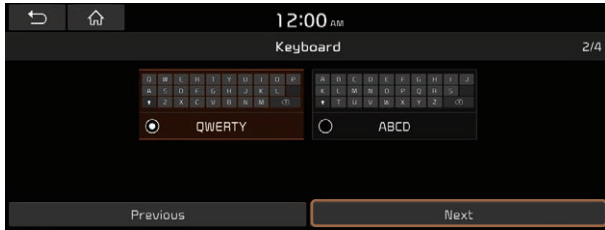

- 5 To set the driver's name, touch **Rename**.

The name change screen appears.

- ✎ To proceed with First Run Setup without changing the driver's name, touch **Next**.

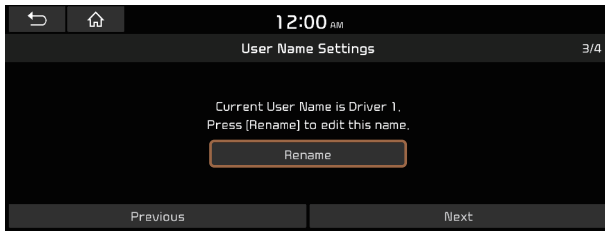

- 6 Set the map display method and then touch **Next**.

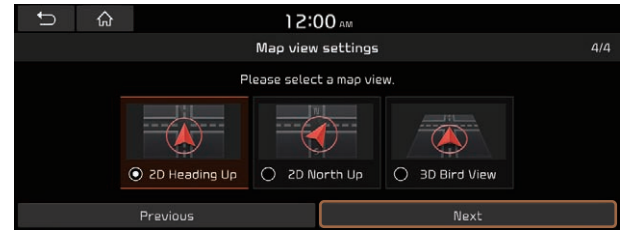

- **2D Heading Up:** The map is rotated depending on the driving direction.
- **2D North Up:** Displays the map with the north fixed at the top.
- **3D Bird View:** The map is rotated depending on the driving direction and it is displayed in three dimensions.

- 7 When the First Run Setup screen appears, touch **OK**.

Displays the Home screen.

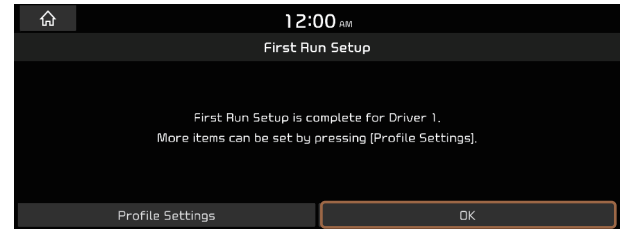

- ✎ To set the detailed user information and operation environment, press **Profile Settings**. ► See "Configuring the user profile settings (if equipped)."

# Using the phone projection function

When you connect an Android smartphone or iPhone to the vehicle with a USB cable, you can run and control applications on the phone through the widescreen using its user-friendly interface.

## **Warning**

Do not adjust or set up any phone settings while driving. You may lose your steering control which could cause an accident and severe bodily injuries.

## **Caution**

Using an approved USB cable provided by your smartphone manufacturer is recommended. Using unapproved USB cables may cause a phone projection error or a system malfunction.

## Pairing to an Android smartphone via Android Auto

When you connect an Android smartphone to the vehicle with Android Auto, you can run and control applications on the phone through the widescreen using its user-friendly interface.

- 1 To use Android Auto, first check the following.
  - Visit the Android Auto website at <https://www.android.com/auto> to check the list of countries, device types, and models that support Android Auto.
  - Download and install the Android Auto application from Google Play Store. It is not possible to install Android Auto in countries that do not support the feature.
- 2 On the All Menus screen, touch **Setup ► Device Connections ► Android Auto** and select the **Enable Android Auto** checkbox.

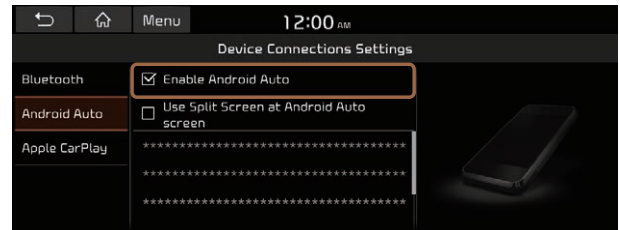

- ✎ The screen may differ depending on the vehicle model and specifications.
- ✎ Select **Use Split Screen at Android Auto screen** to show split screen when using Android Auto (if equipped).

### 3 Connect a smartphone to the USB port on the vehicle by using the provided USB cable.

- ✎ When the connection is made for the first time, the system screen displays a notification window. Check the details and then touch **OK**.
- ✎ To end the Android Auto and disconnect from the smartphone, remove the USB cable from the system.



#### **Caution**

Do not repeatedly connect and remove the USB connector within a short time. It may cause device errors or system failures.

### 4 When the smartphone is locked, unlock it first and then consent to the use of Android Auto.

When the smartphone is recognized successfully, the **Android Auto** menu is activated on the All Menus screen.

## Using the Android Auto

### 1 On the All Menus screen, touch **Android Auto**.

### 2 Perform the desired function.

- To run the functions for phone, music, or navigation on the smartphone, touch the corresponding app icon.
  - To use the Google voice recognition, press and hold the Voice Recognition button on the steering wheel.
- ✎ By pressing the **[MODE]** button on the steering wheel, you can run the media application on your smartphone as well as the Radio/Media mode of the system.
  - ✎ On the All Menus screen, touch **Setup ► Advanced ► Steering Wheel MODE Button** and then press the **[MODE]** button to set the functions to run. ► See "Steering Wheel MODE Button."
  - ✎ By pressing the Call button on the steering wheel, you can make a call via Bluetooth connection.

- ✍ When phone projection is active, you cannot change the phone projection settings. To change the settings, remove the USB cable from your system.
- ✍ The icons on the screen are subject to change according to the policy of Google Corporation.
- ✍ Applications or functions used through Android Auto are subject to change according to the policy of Google Corporation. For supportable functions, visit the Android website at <https://www.android.com/auto>.
- ✍ To use the functions on your smartphone with the minimized system settings, update the smartphone OS to the latest version.
- ✍ The recognition time may differ depending on the device type, firmware, and OS version.
- ✍ Charges may apply for any mobile data used while Android Auto is running.
- ✍ Some functions may not work properly depending on the network signal strength.
- ✍ Avoid interacting with the smartphone while using Android Auto.
- ✍ You cannot use the following functions when Android Auto is in use.
  - USB mode
  - Browse function using the [TUNE/FILE] knob
  - Apple CarPlay

## Pairing to an iPhone via Apple CarPlay

After you connect an iPhone to the vehicle with Apple CarPlay, you can run and control applications on the phone through the system screen.

- 1 To use Apple CarPlay, first check the following:
  - For iPhone models that support Apple CarPlay, visit the Apple website at <https://www.apple.com/ios/carplay>.
  - Make sure Apple CarPlay and Siri are enabled in your iPhone settings. If you do not see options for Apple CarPlay or Siri, update to the latest iOS version.
- 2 On the All Menus screen, touch **Setup ► Device Connections ► Apple CarPlay** and then check **Enable Apple CarPlay**.

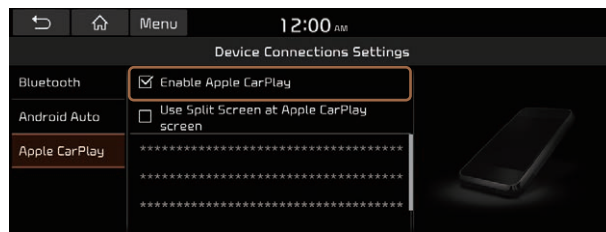

- ✍ The screen may differ depending on the vehicle model and specifications.
- ✍ Select **Use Split Screen at Apple CarPlay screen** to show split screen when using Apple CarPlay (if equipped).

### 3 Connect an iPhone to the USB port on the vehicle by using the provided USB cable.

✍ When the connection is made for the first time, the system screen displays a notification window. Check the details and then touch **OK**.

✍ To end the Apple CarPlay and disconnect from the iPhone, remove the USB cable from the system.



#### **Caution**

Do not repeatedly connect and remove the USB connector within a short time. It may cause device errors or system failures.

### 4 When the iPhone is locked, unlock it first and then consent to the use of Apple CarPlay.

When the iPhone is recognized successfully, the **Apple CarPlay** menu is activated on the All Menu screen.

## Using the Apple CarPlay

### 1 On the All Menu screen, touch **Apple CarPlay**.

### 2 Perform the desired function.

- To run any of functions (phone, messaging, navigation, etc.) on your iPhone, touch the corresponding function icon.
- To run the Siri voice recognition, press and hold the Voice Recognition button on the steering wheel.

✍ To display the system Home screen, touch .

✍ By pressing the **[MODE]** button on the steering wheel, you can run the media application on your smartphone as well as the Radio/Media mode of the system.

✍ On the All Menu screen, touch **Setup ▶ Advanced ▶ Steering Wheel MODE Button** and then press the **[MODE]** button to set the functions to run. ▶ See "Steering Wheel MODE Button."

✍ When you receive a call, press the Call button on the steering wheel to answer it.

✍ When phone projection is active, you cannot change the phone projection settings. To change the settings, remove the USB cable from your system.

✍ Applications or functions used through Apple CarPlay are subject to change according to the policy of Apple Corporation. For supportable functions, visit the Apple Corporation website at <http://www.apple.com/ios/carplay>.

- ✎ To use the functions on your smartphone with the minimized system settings, update the smartphone OS to the latest version.
- ✎ The recognition time may differ depending on the device type, firmware, and OS version.
- ✎ Charges may apply for any mobile data used while Apple CarPlay is running.
- ✎ Some functions may not work properly depending on the network signal strength.
- ✎ Avoid interacting with the smartphone while using Apple CarPlay.
- ✎ You cannot use the following functions when Apple CarPlay is in use.
  - Bluetooth
  - USB mode
  - Browse function using the [TUNE/FILE] knob
  - Android Auto

## Using the driving assist display

You can see the view around the vehicle through the system screen.

- ✎ The displayed screen may differ depending on the vehicle model.



### Warning

---

When backing up, make sure to follow the guidelines below:

- Before entering your vehicle, always check the area behind your vehicle.
- Do not solely rely on the rear view camera when backing up. Always ensure that it is safe to back up by checking behind you and looking in the rearview mirrors.
- Always back up slowly and stop immediately if you suspect that a person, especially a child, might be behind you.



### Caution

---

Objects on the screen may not be as close or far as they appear. Be sure to check the rear, left, and right sides with your own eyes for safety.

## Using the rear-view display

- 1 Press the "R" (Reverse) button shifter (or move the shift lever to "R" in a previous vehicle model) with the vehicle turned on.

The system automatically displays the rear view with parking assist guidelines.

- 2 Safely park your vehicle, checking the rear view and guidelines.

🔗 The example may differ from the actual screen display.

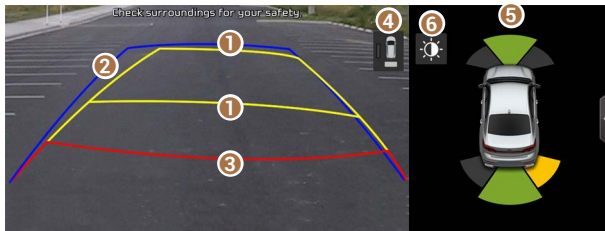

Type A



Type B

### 1 Moving direction lines (yellow)

Displays the vehicle's moving direction based on the steering angle.

### 2 Neutral steering lines (blue)

Displays the moving direction if you reverse the vehicle in neutral. Noting these lines, you can determine whether the vehicle is stopped in correct direction and the distances to the neighboring vehicles are adequate.

### 3 Collision warning lines (red)

Used to prevent collision.

### 4 Rear top view button (if equipped)

Touch the button to display the rear top view.

### 5 Parking distance warning (if equipped)

Depending on the distance to obstacles, the warning color and alert sound change along with the level (1/2/3) to notify of the distance.

### 6 Camera image adjustment

Used to adjust the brightness and contrast of camera images.

### 7 Center

Used to initialize the brightness and contrast of camera images.

✎ Available settings may differ depending on the vehicle model and specifications.

✎ You can change the motion settings of the rear camera. On the All Menus screen, touch **Setup ▶ Advanced ▶ Extend Rear Camera Use** and then check **Extend Rear Camera Use** to turn on the function. The rear view appears continuously even when you change the shift position other than "R" (Reverse) after reversing (if equipped). ▶ See "Extend Rear Camera Use (if equipped)."

✎ Noting the parking assist guide lines based on the steering, you can see the moving direction.



✎ A warning sound is heard when the vehicle approaches obstacles while parking. When you set to automatically lower the audio volume while parking, it can prevent accidents caused by failure to hear the warning sound. On the All Menus screen, touch **Setup ▶ Sound ▶ Priority ▶ Proximity Warning**. ▶ See "Proximity Warning."

## Viewing the rear top view display (if equipped)

You can look down the rear view from the top through the rear-view display.

- 1 On the rear-view screen, touch .
- 2 Check the top view display and assist guide lines.
  - ✎ The guide lines appear on the rear top view.
    - Displays the space required to open the trunk (tailgate). After a parking, check whether the space is sufficient to open the trunk and there is no obstacle.
    - Displays the extension line from the center of the vehicle. According to the steering direction, the moving direction of the center is displayed on the screen.



## Surround View Monitor (if equipped)

You can check the surroundings by using multiple cameras on the vehicle.

✍ Use the +/- button on the right of the screen to zoom in or out.





### Viewing the surround view while driving

1 In order to see the surround view, press the  button.

The system displays both the front view and surround view.

- ✍ The surround view monitor function operates only when any of the following conditions are met.
- The driving speed is below 9mph with the shift position in "D" (Drive).
  - The vehicle is stationary and the shift position is in "D" (Drive) or "N" (Neutral).

2 Touch the icon to get a view in the desired direction.

Icon	Description
	Displays the front wide view and top view (default).
	Displays the zoom-in front top view and top view.
	Display the front blind spot view and top view.
	Used to adjust the brightness and contrast of the camera images.
	Displays the surround view settings.

✍ When any door or trunk (tailgate) is open or outside rear-view mirrors are folded, an alert icon appears on the right of the screen.

✍ To turn off the surround view screen, press the  button.





## Viewing the surround view while reversing

- 1 Press the "R" (Reverse) button shifter (or move the shift lever to "R" in a previous vehicle model) with the vehicle turned on.

The system displays the rear view of the vehicle.

 The surround view monitor function is not available when you change the shift position to "P" (Park).

- 2 Touch the icon to get a view in the desired direction.

Icon	Description
	Displays the rear wide view and top view (default).
	Displays the zoom-in rear top view and top view.
	Display the rear blind spot view and top view.
	Used to adjust the brightness and contrast of the camera images.
	Displays the surround view settings.

## Configuring the surround view monitor settings

- 1 On the surround view screen, touch .
- 2 Select and then change the settings.
  - To select the information to appear on the video, touch **Display Contents**. (e.g. Top view parking guidance, rear view parking guidance, parking distance warning).
  - To select the default view for top view monitoring, touch **Top View Default Mode**.
  - To select the default view for using the surround view monitor function while driving, touch **Front View Default Mode**.

# Using the climate control system (if equipped)

You can check and adjust the climate system settings on the screen.

Press the **[CLIMATE]** button on the climate control system.

 For more information about how to use the heater and air conditioner, refer to Owner's Manual of the vehicle.





- 1 Returns to the previous step.
- 2 Displays the outside temperature.
- 3 Can adjust the driver's seat temperature.
- 4 Can to adjust the passenger's seat temperature.
- 5 Can adjust the fan speed.
- 6 Can adjust the air direction.

- 7 Can turn on or off the automatic temperature control function.
- 8 Can turn on or off the air conditioner.
- 9 Can turn on or off the function that adjusts the temperatures for the driver's seat and passenger's seat equally.
- 10 The list of menu items appears.
  - **Climate Settings:** Can configure the operation environment for climate control system.
  - **User's Manual on Web (QR Code):** Displays the QR code that provides access to the online user manual for the system.
  - **Split Screen:** Can turn on or off the split screen mode.

When you manipulate the climate control system while using the product, the climate settings appear on the upper part of the screen.



-  The temperature of the climate system can be adjusted by 1 °F increments. When the temperature is set to the lower limit or upper limit, "LOW" or "HIGH" appears on the screen.
-  In Auto mode, the mode turns off in the following situations:
  - The fan speed or air direction is changed.
  - The air conditioner is turned on or off.
  - The Auto Defog function is turned on to ensure driver's visibility.
-  Available settings may differ depending on the vehicle model and specifications.

# Using the rear-seat climate control system (if equipped)

You can check or set the rear-seat climate status on the system screen.

- 1 Perform any of the following methods:
  - Press the **[REAR]** button on the climate control system.
  - On the All Menu screen, touch **Rear Climate Controls**.
- 2 Select and then change the settings.

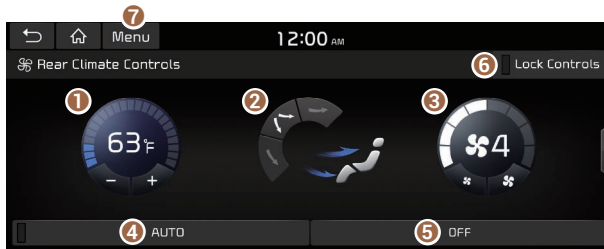

For automatic temperature control

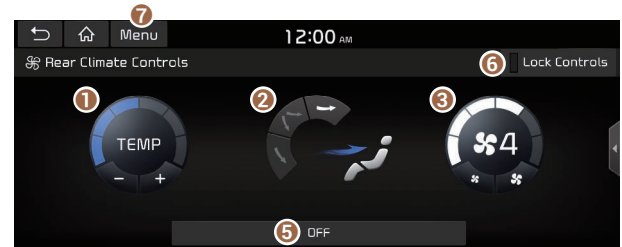

For manual temperature control

- 1 Can set the inside temperature.
- 2 Can adjust the air direction.
- 3 Can adjust the fan speed.
- 4 Can turn on or off the automatic temperature control function of the rear seat.
- 5 The climate for the rear seat is turned off.
- 6 Can lock to prevent any occupant from controlling the climate control system.
- 7 The list of menu items appears.
  - **User's Manual on Web (QR Code):** Displays the QR code that provides access to the online user manual for the system.
  - **Split Screen:** Can turn on or off the split screen mode.

 Available settings may differ depending on the vehicle model and specifications.

## Using the Driver Talk mode in the rear seat (if equipped)

When the driver's voice cannot be delivered well to the rear seat, you can use the microphone of the driver's seat for smooth communication.

### 1 On the All Menus screen, touch **Driver Talk**.

The driver talk icon appears at the top right of the system screen to display its status.

### 2 Make conversation through the microphone of the driver's seat.

- ✎ To end the Driver Talk mode, touch **End**.
- ✎ When you move to another screen without touching **End**, shortly press the End Call button on the steering wheel to end the driver talk function.

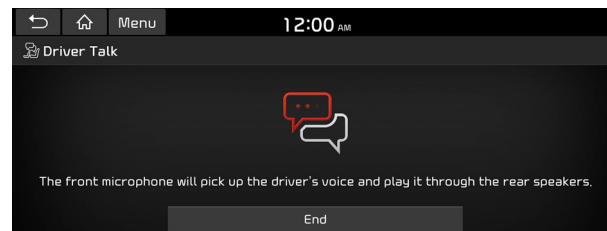

- ✎ When the Driver Talk mode is active, the Radio/Media functions are unavailable.
- ✎ To access the online user's manual on the Driver Talk screen, touch **Menu ▶ User's Manual on Web (QR Code)** and then scan the displayed QR code.

## Using the Quiet mode in the rear seat (if equipped)

To allow occupants in the rear seat to have rest and sleep, you can set to adjust the system volume.

- 1 On the All Menus screen, touch **Quiet Mode**.
- 2 Touch **Quiet Mode**.

The audio volume in the rear seat is muted. When the volume for the front seats is set too high, the volume decreases automatically.

 To end the Quiet mode, touch **Quiet Mode** once more.

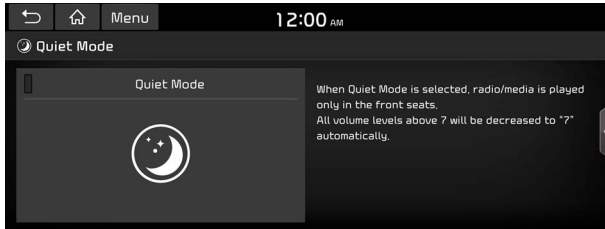

 To access the online user's manual on the Quiet mode screen, touch **Menu ► User's Manual on Web (QR Code)** and then scan the displayed QR code.

## Using the sound mood lamp (if equipped)

You can set to implement various lighting effects by synchronizing with the playing music.

- 1 On the All Menus screen, touch **Sound Mood Lamp**.
- 2 Select and then change the settings.

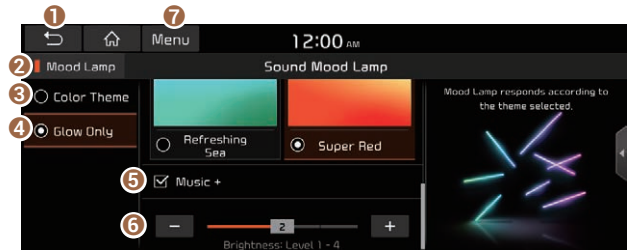

- 1 Returns to the previous step.
- 2 Can turn on or off the sound mood lamp.
- 3 Can select various color themes. Based on the selected color theme, the interior lighting changes its colors in various patterns.
- 4 Can select the color of the light. The selected lighting color changes into a soft glow effect.

- 5 Can synchronize the light with the playing music.
  - ✎ After checking **Music+**, music is not played back or the light does not illuminate when muted.
- 6 Can adjust the brightness of the light.
- 7 The list of menu items appears.
  - **Reset:** Can reset all the settings of the sound mood lamp.
  - **User's Manual on Web (QR Code):** Displays the QR code that provides access to the online user manual for the system.
  - **Split Screen:** Can turn on or off the split screen mode.

- ✎ You cannot manipulate the sound mood lamp while driving.
- ✎ When a door is opened, the light automatically turns off.
- ✎ The screen may differ depending on the vehicle model and specifications.

## Playing Sounds of Nature

(if equipped)

Listen to the calming sound of rain, waves, and more to relax while driving by turning on a Sounds of Nature.

- 1 On the All Menus screen, touch **Sounds of Nature**.
- 2 Select from the Sounds of Nature list to play.

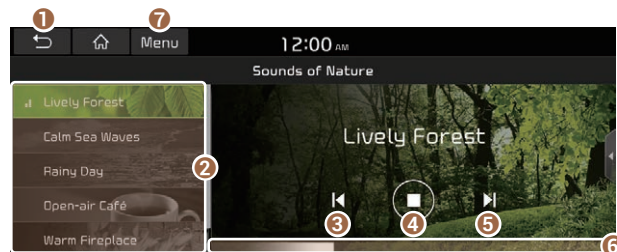

- 1 Returns to the previous step.
- 2 Select and play Sounds of Nature.
- 3 Play the previous sound.
- 4 Stop or play playback.
- 5 Play the next sound.
- 6 You can check the playback status of Sound of Nature.

- 7 The list of menu items appears.
  - **Media Sources:** Open the media selection window.
  - **Sound Settings:** Configure system sound settings.
  - **User's Manual on Web (QR Code):** Displays the QR code that provides access to the online user manual for the system.
  - **Split Screen:** Can turn on or off the split screen mode.

✎ Playing Sounds of Nature will mute or pause other sound effects and music that may be active at the moment.

✎ Incoming or outgoing calls will pause Sounds of Nature playback.

✎ The sound effect settings button may appear on the screen depending on the amp specifications.

## Using the HD Radio Data

You can access an array of information with HD radio data such as HD Radio™.

✎ HD radio data are available only in metropolitan areas.

1 On the All Menus screen, touch **HD Radio Data**.

2 Perform any of the following methods:

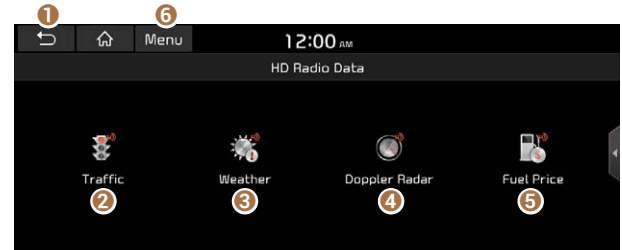

1 Returns to the previous step.

2 Can see traffic information by using HD Radio data.  
▶ See "Seeing traffic information by using HD radio data."

3 Can see weather information by using HD Radio data.  
▶ See "Seeing weather information by using HD radio data."

4 Can see weather information from the Doppler Radar.  
▶ See "Seeing weather information by using Doppler weather radar."

5 Can see fuel price information by using HD Radio data (if equipped). ▶ See "Seeing fuel price information by using HD radio data."



- 6 The list of menu items appears.
  - **User's Manual on Web (QR Code):** Displays the QR code that provides access to the online user manual for the system.
  - **Split Screen:** Can turn on or off the split screen mode.

## Seeing traffic information by using HD radio data

- 1 On the All Menus screen, touch **HD Radio Data**.
- 2 Touch **Traffic**.
- 3 Select an item from the traffic information list to see the details.
  - ✍ To see traffic information along with your current route or to see all available traffic information, touch **On Route**.
  - ✍ To select the types of traffic information to see, touch **Filter**.

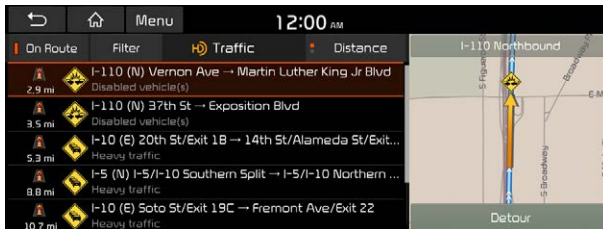

- 4 Check the traffic information details.



- ✍ Traffic information for border crossings and speed limits in local roads may not be accurate. Use the information at your discretion.

## Seeing weather information by using HD radio data

- 1 On the All Menus screen, touch **HD Radio Data**.
- 2 Touch **Weather**.
- 3 Check today's weather information of your position (for city).
  - ✎ To see weather forecasts for today and the next four days, touch **5 Days**.
  - ✎ To see weather information of another area, touch **Menu** ► **Other City**.



## Seeing weather information by using Doppler weather radar

- 1 On the All Menus screen, touch **HD Radio Data**.
- 2 Touch **Doppler Radar**.
- 3 See the weather condition details in the HD Radio coverage area.

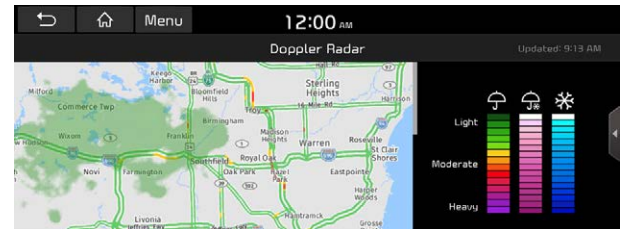

## Seeing fuel price information by using HD radio data

1 On the All Menus screen, touch **HD Radio Data**.

2 Touch **Fuel Price**.

3 Search nearby gas stations or charging stations, and check the current fuel or charging prices.

✎ To change the sorting order, touch  on the drop-down list and then select the sorting criteria.

✎ To see the latest information, touch .

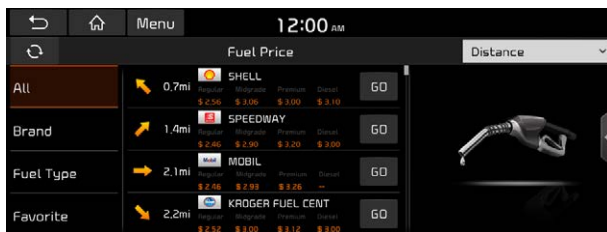

## Seeing the driving information

You can analyze the driving patterns by checking the driving information such as driving time, distance, idle time, and vehicle speed distribution. Use this information to ensure safe and economical driving.

✎ This function is available only when your vehicle is stationary with the vehicle started.

1 On the All Menus screen, touch **Driving Info**.

2 Check the driving information of your vehicle.

✎ To see the latest information, touch .



✎ To access the online user's manual on the driving information screen, touch **Menu** ► **User's Manual on Web (QR Code)** and then scan the displayed QR code.

# Seeing notifications (if equipped)

You can view UVO notifications including the navigation and map update information.

✍ Subscribe to UVO to check the function. ▶ See “Subscribing to the service.”

1 On the All Menu screen, touch **Notifications**.

2 Select to view the item.

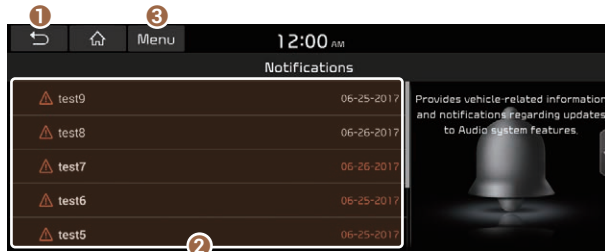

1 Returns to the previous step.

2 View the list of received notifications. Select from the list to view details.

✍ Important notifications are marked with  next to the title.

✍ You cannot display notification details while driving. Stop the vehicle first to view notifications.

3 The list of menu items appears.

- **Notification Popup:** Set to display notifications upon receipt in a pop-up.
- **User's Manual on Web (QR Code):** Displays the QR code that provides access to the online user manual for the system.
- **Split Screen:** Can turn on or off the split screen mode.

# 03 Radio

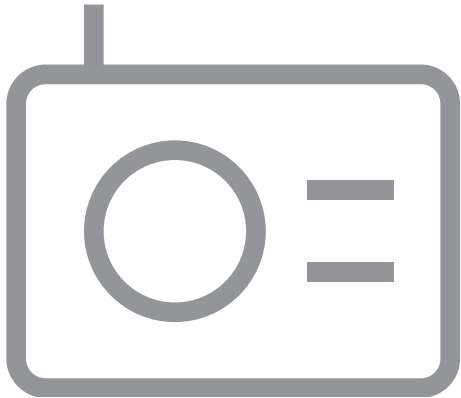

Listening to the radio  
Listening to HD Radio™  
Listening to SiriusXM™ radio

# Listening to the radio

You can scan radio channels by using various options. Save your favorite channels to the presets list.

Perform any of the following methods:

- On the All Menu screen, touch **Radio**.
- On the control panel, press the **[RADIO]** button.

## Radio screen

The radio screen provides various functions while listening to radio broadcasts.

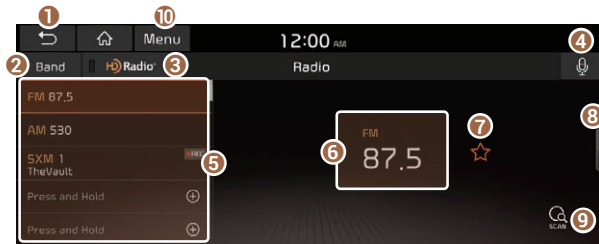

- 1 Returns to the previous step.
- 2 Can change the radio mode.
- 3 Activate the HD Radio mode.
- 4 You can change radio channels by using voice commands.  
▶ See "Changing the channel by using voice commands."
- 5 Presets list
- 6 Radio broadcast information
- 7 You can delete or save the current frequency to the presets list. ▶ See "Saving the current radio channel."
- 8 Split Screen: Can turn on or off the split screen mode.
- 9 You can listen to each radio channel for a short time and select the desired channel. ▶ See "Using the scan function."

- 10 The list of menu items appears.
- **Enter Station:** Can select or directly enter the desired radio frequency.
  - **Station List:** Can see the list of available radio stations.
  - **Info:** Turns the Radio text information transmitted from the broadcasting station on and off.
  - **Reorder Presets:** Can change the location of a channel by dragging on the presets list. ▶ See “Changing the order of registered channels.”
  - **Delete Presets:** Can delete a registered channel from the presets list. ▶ See “Deleting a registered channel.”
  - **Set Number of Presets:** Used to set the number of channels to display on the preset list. ▶ See “Changing the number of channels to display on the preset list.”
  - **Sound Settings:** Can configure system sound settings. ▶ See “Configuring the sound settings.”
  - **User’s Manual on Web (QR Code):** Displays the QR code that provides access to the online user manual for the system.
  - **Split Screen:** Can turn on or off the split screen mode.
- ✍ The broadcast station names and local information are displayed using GPS data. Those information may not appear when there is no GPS data received.
- ✍ The displayed broadcast station names may not match the actual ones.

 **Warning**

---

Driving while distracted can result in a loss of vehicle control that may lead to an accident, severe bodily injury, or death. The driver’s primary responsibility is the safe and legal operation of the vehicle, and the use of any vehicle systems, including the touch screen and steering wheel controls, which take the driver’s eyes, attention, and focus away from the safe operation of the vehicle, or which are not permissible by law, should never be used during the operation of the vehicle.

## Changing the radio mode

Perform any of the following methods:

- On the **Radio** screen, touch **Band**.
- On the control panel, press the [RADIO] button repeatedly.



## Changing the radio channel

Perform any of the following methods:

- On the **Radio** screen, touch the desired channel from the presets list.
  - ✍ You can also change the channel by using the Move lever/button on the steering wheel.
- On the control panel, press the [ < SEEK ] or [ TRACK > ] button. You can move to the previous or next channel with good reception.
- When you know an accurate frequency, turn the [TUNE/FILE] knob on the control panel to change the frequency.

You can listen to the changed radio broadcast.

## Changing the channel by using voice commands

You can change the radio channel by using voice commands.

- 1 On the **Radio** screen, touch .
- 2 When a guiding beep is heard, say the desired radio station channel.



## Using the scan function

You can listen to each broadcast briefly and select a desired one.

- 1 On the **Radio** screen, touch .

Only the channels with good reception can be listened for 5 seconds in turn.



- 2 When you find the desired broadcast, touch .

You can continue listening to the scanned channel.

## Saving the current radio channel



When you save the current playing channel in the preset list, you can easily select it later.

Perform any of the following methods:

- While listening to a broadcast, touch and hold an empty preset number with no channel on the radio screen.
- While listening to a broadcast, touch  in the middle of the screen.



The current channel is added to the presets list.



-  Touch and hold a previously configured preset number to reassign it with the currently listening channel.
-  You can register up to 40 channels.

## Editing the radio channel list

### Changing the order of registered channels

- 1 At the upper left of the **Radio** screen, touch **Menu** ► **Reorder Presets**.
- 2 On the presets list, touch  next to the channel you want to move, then drag it to reposition.
- 3 To complete the change, touch .

The presets list is updated with the sequences changed.

### Deleting a registered channel

- 1 At the upper left of the **Radio** screen, touch **Menu** ► **Delete Presets**.
  - 2 Select the channel to delete and touch **Delete** ► **Yes**.  
The channel is deleted and the preset number is emptied.
- ✎ When the current channel is already assigned to the presets list, touch the  icon to remove the channel from the list.

### Changing the number of channels to display on the preset list

- 1 At the upper left of the **Radio** screen, touch **Menu** ► **Set Number of Presets**.
- 2 Select the number of channels to display on the preset list and then touch **OK**.

The channels for the selected number appear on the preset list.

- ✎ When the number of channels is changed to a lower value, the channels for the number appear with removing others.

# Listening to HD Radio™

You can listen to radio from HD radio stations when they are available.

On the **Radio** screen, touch **HD Radio**.

When HD Radio signals are received, the radio switches from the analog mode to the HD mode.



- ✎ In HD mode, the buttons for HD Radio stations appear at the top of the radio screen. Touch a button to select any available HD radio station.
- ✎ HD radio is available only in metropolitan areas.

## HD Radio™ Technology



## Program Info

Program Info: Presents song name, artist, station IDs, and other relevant data streams.

## Digital Sound

Digital, CD-quality sound. HD Radio™ Technology enables local radio stations to broadcast a clean digital signal. AM sounds like today's FM and FM sounds like a CD.

## HD2/HD3

FM stations can provide additional digital-only audio programming on HD2/HD3 Channels.

## Traffic

Real-Time Traffic reports, alerts, and flow data displayed on screen via interactive traffic maps and/or data.

# Listening to SiriusXM™ radio

You can listen to radio channels provided by SiriusXM, a satellite radio service.

## Changing to SiriusXM mode

On the **Radio** screen, touch **Band** ► **SiriusXM**.



## SiriusXM mode screen

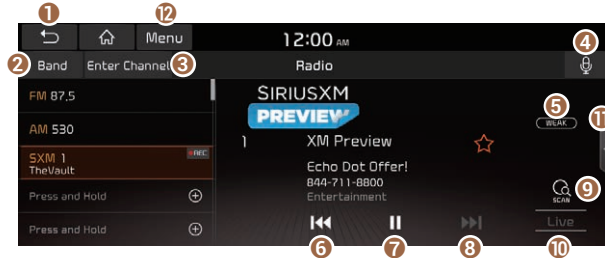

- 1 Returns to the previous step.
- 2 Can change the radio mode.
- 3 Can access the list of available SiriusXM radio channels.
- 4 You can change radio channels by using voice commands.  
▶ See "Changing the channel by using voice commands."
- 5 Weak reception indicator.
- 6 Moves to the previous segment. Touch and hold to rewind the broadcast by five-second decrements.
- 7 Pauses or stops the broadcast.
- 8 Moves to the next segment. Touch and hold to fast forward the broadcast by five-second increments.
- 9 Scans through all available SiriusXM radio channels.
- 10 Switches to the live broadcast mode. This button is activated only when a live broadcast is available for the selected channel.

- 11 Split Screen: Can turn on or off the split screen mode.
  - 12 Displays the options list.
    - **Channel List:** Can see the list of available SiriusXM channels.
    - **What is on My Presets?:** Displays the broadcast schedule.
    - **Featured Favorites:** Can listen to groups of channels provided by SiriusXM.
    - **Reorder Presets:** Can change the location of a channel by dragging on the presets list.
    - **Delete Presets:** Can delete a registered channel from the presets list.
    - **Set Number of Presets:** Used to set the number of channels to display on the preset list. ▶ See "Changing the number of channels to display on the preset list."
    - **Sound Settings:** Can customize the system sound settings.
    - **User's Manual on Web (QR Code):** Displays the QR code that provides access to the online user manual for the system.
    - **Split Screen:** Can turn on or off the split screen mode.
- ✍ The **REC** icon appears next to the first 10 SiriusXM channels saved. Once preset channels have been saved, the broadcasts from them are buffered automatically for your convenience each time you start the vehicle.

## Searching for SiriusXM radio channels

You can select a channel from available SiriusXM channels.

1 On the **Radio** screen, touch **Band ► SiriusXM**.

2 On the SiriusXM radio screen, touch **Menu ► Channel List**.

3 Select a category and a channel.

✍ To skip a channel when scanning with the [TRACK >] and [◀ SEEK] buttons or [TUNE/FILE] knob, touch **Skip**.

✍ The current channel is added to the presets list when touching .

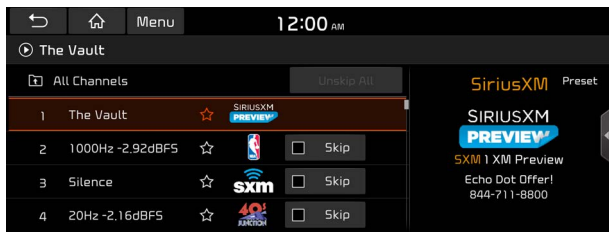

## Selecting channels by using channel numbers

When you know the exact channel number, you can enter it to select the channel directly.

1 On the **Radio** screen, touch **Band ► SiriusXM**.

2 On the SiriusXM radio screen, touch **Enter Channel**.

3 Enter a channel number and touch **OK**.

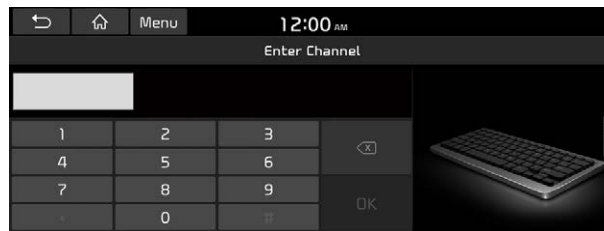

## Seeing the program schedule

You can see the program schedule and information for the channels saved in your preset list.

1 On the **Radio** screen, touch **Band ▶ SiriusXM**.

2 On the SiriusXM radio screen, touch **Menu ▶ What is on My Presets?**.

3 Set the date and time on the top line of the screen.

✎ To select a date, touch the date display field at the top left of the preset list and select the date and time zone.

✎ To select a time, touch ◀ or ▶.

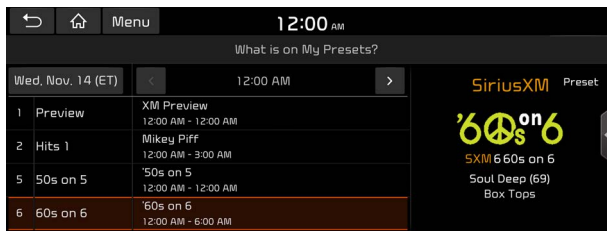

4 Select a channel and a program to see its detailed information.

✎ If any hidden information, an arrow appears next to the program. Touch the arrow to see the hidden information.

## Listening to Featured Favorites channels

You can listen to Featured Favorites channels on the SiriusXM radio. Multiple sets of channels can be broadcast and can be changed by SiriusXM.

1 On the **Radio** screen, touch **Band ▶ SiriusXM**.

2 On the SiriusXM radio screen, touch **Menu ▶ Featured Favorites**.

3 Select a channel.

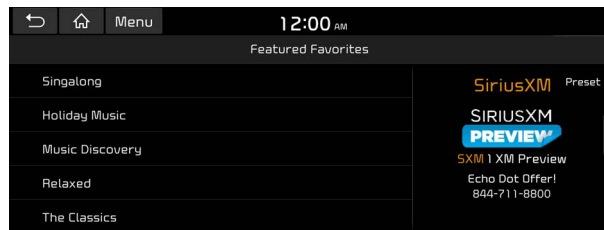

MEMO





# 04

## Media

Using media

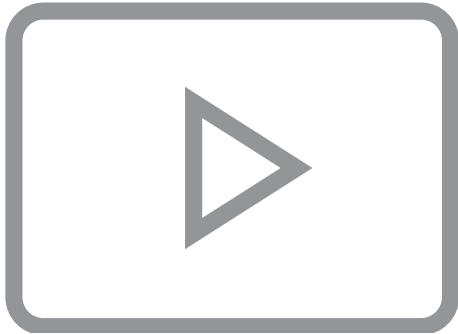

# Using media

You can use the USB mode to play music files on a connected mobile device, such as USB device and MP3 player. You can also play Bluetooth music by connecting a Bluetooth device, which supports a Bluetooth function.

## Listening to music from a USB device

- 1 Connect a media device to play to the USB port on the vehicle.

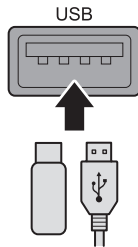

- ✍ Playback may start automatically depending on the media type.
- ✍ For more information about supportable devices and file types: ► see "USB mode."
- ✍ The shapes and arrangement of the buttons and USB ports may differ depending on the vehicle model and specifications.

- 2 Perform any of the following methods:

- On the Home screen, touch the Radio/Media info widget.
- On the control panel, press the **[MEDIA]** button.
- ✍ When multiple media are connected, press the **[MEDIA]** button once more and then press the desired media source from the media selection window.

## USB music screen

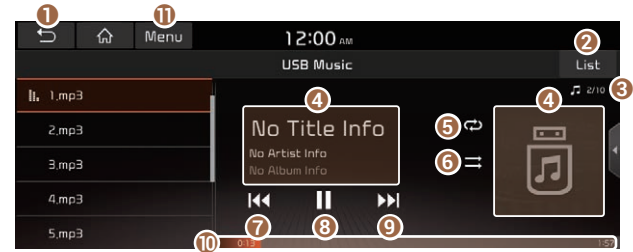

- 1 Returns to the previous step.
- 2 Moves to the file list screen.
- 3 Displays the sequence number of the current file and the total number of files for playback.
- 4 Displays the information of the current music. Touch the artist or album info of the current song to go to list of songs by the artist or from the album.
- 5 Used to change the repeat playback mode.
- 6 Used to turn on or off the random playback mode.

- 7 Restart playing the current file or previous file.
  - 8 Can pause or resume playback.
  - 9 Can play the next file.
  - 10 Can see the duration of the playing song and the current playback position.
  - 11 The list of menu items appears.
    - **Media Sources:** Opens the media selection window.
    - **Songs by this Artist:** Moves to the list of the artist's songs.
    - **Songs from this Album:** Moves to the list of music albums that contain the current song.
    - **Hide Current File:** You can hide the file that is playing.
    - **Sound Settings:** Can configure system sound settings.
      - ▶ See "Configuring the sound settings."
    - **User's Manual on Web (QR Code):** Displays the QR code that provides access to the online user manual for the system.
    - **Split Screen:** Can turn on or off the split screen mode.
- ✎ The screen may differ depending on the vehicle model and specifications.
- ✎ The sound effect settings button may appear on the screen depending on the amp specifications.

## Warning

Driving while distracted can result in a loss of vehicle control that may lead to an accident, severe bodily injury, or death. The driver's primary responsibility is the safe and legal operation of the vehicle, and the use of any vehicle systems, including the touch screen and steering wheel controls, which take the driver's eyes, attention, and focus away from the safe operation of the vehicle, or which are not permissible by law, should never be used during the operation of the vehicle.

## Pause/Resume

You can pause or resume playback of a USB music file.

On the USB music playback screen, touch  or .

## Rewind

By using the rewind function, you can listen to music in the USB device from the desired point during playback.

Perform any of the following methods:

- On the USB music playback screen, touch and hold .
- On the control panel, press and hold the [**SEEK**] button.

✎ You can also run the function by using the Move lever/button on the steering wheel.

## Fast forward

By using the fast forward function, you can listen to music in the USB device from the desired point during playback.

Perform any of the following methods:

- On the USB music playback screen, touch and hold .
- On the control panel, press and hold the [TRACK >] button.

 You can also run the function by using the Move lever/button on the steering wheel.

## Resuming playback of the current music

You can play the current music in the USB device from the beginning.

Perform any of the following methods:

- On the USB music playback screen, touch  after 3 seconds during playback.
- On the control panel, press the [< SEEK] button after 3 seconds during playback.



 You can also run the function by using the Move lever/button on the steering wheel.

## Playing the previous file

You can play the previous file during playback in the USB device.

Perform any of the following methods:

- On the USB music playback screen, touch  within 3 seconds during playback.
- On the control panel, press the [< SEEK] button within 3 seconds during playback.

 After playback, you can play the previous music by touching  twice or pressing the [< SEEK] button on the control panel twice.

 You can also run the function by using the Move lever/button on the steering wheel.

 On the control panel, turn the [TUNE/FILE] knob to search for a music file and press the knob within 5 seconds to play it.

 When there is no input for 5 seconds, the search stops and the system displays the information of the current file.

## Playing the next file

You can play the next file in the USB device during playback.

Perform any of the following methods:

- On the USB music playback screen, touch .
- On the control panel, press the [TRACK >] button.

 You can also run the function by using the Move lever/button on the steering wheel.

 On the control panel, turn the [TUNE/FILE] knob to search for a music file and press the knob within 5 seconds to play it

 When there is no input for 5 seconds, the search stops and the system displays the information of the current file.

## Changing the repeated playback mode for USB music

You can change the repeated playback mode for USB music: Repeat One, Repeat Folder, and Repeat All.

On the USB music playback screen, touch  repeatedly.

Each time the icon is touched, the playback repetition modes are toggled and the activated mode icon appears on the screen.

## Turning on/off the random playback

You can turn on or off the random playback mode for USB music.

On the USB music playback screen, touch  repeatedly.

Each time the icon is touched, the random playback mode is turned on and off. When the random playback is active, the files are played randomly with no sequence.

## USB music list screen

You can search and play the desired music from the list by touching **List** on the USB music playback screen.

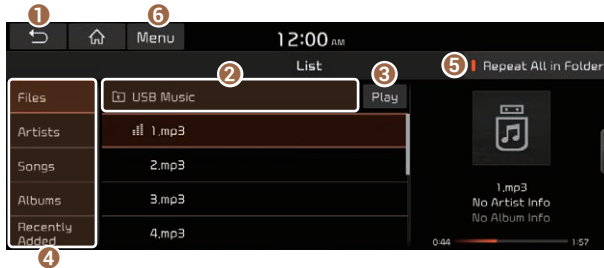

- 1 Returns to the previous step.
- 2 Moves to the upper folder or category.
- 3 Play all songs in this category.
- 4 Can see music files for each category.
- 5 Set to play media files in all sub-folders included in the current playlist (if equipped).
- 6 The list of menu items appears.
  - **Media Sources:** Opens the media selection window.
  - **Now Playing:** You can return to the folder of the playing file while searching in the list.
  - **Split Screen:** Can turn on or off the split screen mode.

 The sound effect settings button may appear on the screen depending on the amp specifications.

## Caution

- Be sure to start the vehicle before connecting a USB device. When you start the vehicle after connecting a USB device, the USB device may get damaged.
- Be careful of static electricity when connecting or removing a USB device. It may cause a system failure.
- Be careful and avoid your body or any object coming into contact with the USB port on the vehicle. It may cause an accident or system failures.
- Do not repeatedly connect and remove the USB connector within a short time. It may cause device errors or system failures.
- Do not use a USB device for purposes other than playback. When you connect a USB for charging or heating, the system performance may decrease or it may cause system failures.

- ✍ When connecting a USB storage, do not use a separate extension cable and directly connect to the USB port. When you connect a USB storage via a USB hub or extension cable, the device may not be recognized.
- ✍ Push the USB connector fully into the USB port. When the connector is not fully inserted, a communication problem may occur.
- ✍ Noise may occur when removing a USB device from the system.
- ✍ You can play only the files that have been encoded in the standard format.
- ✍ The following USB devices may not be recognized or may not work properly.
  - Encrypted MP3 players
  - USB devices that are not recognized as removable disks
- ✍ USB devices may not be recognized depending on the device status.
- ✍ Some USB devices may not be supported due to compatibility issues.
- ✍ USB device recognition may take longer than usual depending on the device type, capacity, and file formats on the device.
- ✍ Some devices may not be charged through USB connection. It depends on the USB specifications.
- ✍ You can hide files only in the USB device formatted in exFAT/NTFS/FAT16/32. The hidden files can be found in the "Hidden\_" folder.

## Listening to music via Bluetooth

To use a Bluetooth device for audio playback, connect a device that supports Bluetooth communication such as mobile phone and MP3 player.

For more information about Bluetooth connection:

► see "Connecting a Bluetooth device."

- ✍ The controls or display screens may differ depending on the connected Bluetooth device, phone model, and music player application.
- ✍ The streaming may not be supported in some music player applications.
- ✍ Some functions may not be available depending on the connected Bluetooth device or phone model.
- ✍ When a media device or mobile phone is connected by both the Bluetooth and USB cable at the same time, the device or system may not work properly. To use the Bluetooth connection, remove all cables from the device.

## Bluetooth audio playback screen

The media player runs when you play a music file from a connected audio device via Bluetooth.

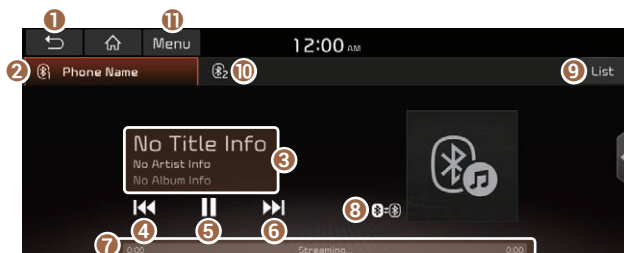

- 1 Returns to the previous step.
- 2 Name of the connected Bluetooth device
- 3 Displays the information of the current music.
- 4 Restart playing the current file or play the previous file.
- 5 Can pause or resume playback.
- 6 Can play the next file.
- 7 Can see the duration of the playing song and the current playback position.
- 8 Find and connect other Bluetooth devices.
- 9 Moves to the music list screen.
  - ✍ The list of Bluetooth audio files may not appear depending on the connected device or app.

- 10 When two Bluetooth audio devices are connected to the system, select a device to play music.
  - 11 The list of menu items appears.
    - **Media Sources:** Opens the media selection window.
    - **Sound Settings:** Can configure system sound settings.
      - ▶ See "Configuring the sound settings."
    - **Change Device:** Find and connect other Bluetooth devices.
    - **User's Manual on Web (QR Code):** Displays the QR code that provides access to the online user manual for the system.
    - **Split Screen:** Can turn on or off the split screen mode.
- ✍ The screen may differ depending on the vehicle model and specifications.
- ✍ The sound effect settings button may appear on the screen depending on the amp specifications.

## Pause/Resume

You can pause or resume playback of a Bluetooth audio file.

On the Bluetooth audio playback screen, touch **⏸** or **▶**.



## Resuming playback of the current Bluetooth audio file

You can play the current Bluetooth audio file from the beginning.

Perform any of the following methods:

- On the Bluetooth audio playback screen, touch .
- On the control panel, press the [**< SEEK**] button.

 The actions required may differ depending on the connected device.

 You can also run the function by using the Move lever/button on the steering wheel.

## Resuming playback of the previous Bluetooth audio file

You can play the previous Bluetooth audio file during playback.

Perform any of the following methods:

- On the Bluetooth audio playback screen, touch  twice.
- On the control panel, press the [**< SEEK**] button twice.

 The actions required may differ depending on the connected device.

 You can also run the function by using the Move lever/button on the steering wheel.

 On the control panel, turn the [**TUNE/FILE**] knob to search for a music file and press the knob within 5 seconds to play it.

 When there is no operation for 5 seconds, the search stops and the system displays the information of the playing content.

## Resuming playback of the next Bluetooth audio file

You can play the next Bluetooth audio file during playback.

Perform any of the following methods:

- On the Bluetooth audio playback screen, touch .
- On the control panel, press the **[TRACK >]** button.

 You can also run the function by using the Move lever/button on the steering wheel.

 On the control panel, turn the **[TUNE/FILE]** knob to search for a music file and press the knob within 5 seconds to play it.

 When there is no operation for 5 seconds, the search stops and the system displays the information of the playing content.

# 05

## Navigation



Navigation functions

Various ways to find routes

Using the address book

Searching for gas stations

Searching for EV (Electric Vehicle) charging stations

# Navigation functions

## Navigation Menu overview

You can use the navigation system conveniently through various functions on the Navigation Menu screen.



Type A

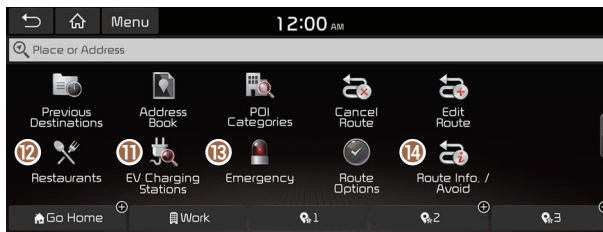

Type B

- 1 Returns to the previous step.
  - 2 Search for a location by entering various types of keywords such as place name and address. ▶ See "Searching by keyword."
  - 3 Search for POIs by category to set as a destination. ▶ See "Searching the nearby points of interest."
  - 4 Select any of previous destinations to set as a destination. ▶ See "Searching by previous destinations."
  - 5 Register the location or use the address book for setting a destination. ▶ See "Using the address book."
  - 6 You can easily search for Kia Dealerships. ▶ See "Searching for Kia Dealerships (if equipped)."
  - 7 You can cancel guidance to the destination. ▶ See "Stopping the route guidance."
  - 8 You can see the entire route information to the destination.
  - 9 You can edit the current route so that you can travel via waypoints on the way to the destination. ▶ See "Editing the route."
  - 10 You can change the route search criteria to resume routing. ▶ See "Changing the route search criteria."
  - 11 You can set a destination after searching for gas stations or EV charging stations. ▶ See "Searching for gas stations," "Searching for EV (Electric Vehicle) charging stations (EV only)."
- ✍ When the station data is received in real time, the menu name changes to "Real-time Stations."

- 12 You can easily search for restaurants. ► See “Searching for restaurants (if equipped).”
  - 13 You can easily search for emergency services. ► See “Searching for emergency services (if equipped).”
  - 14 You can see the entire route information to the destination. ► See “Avoiding specific zones (if equipped).”
  - 15 You can register your home, office, or other frequently visited places as a favorite for ease of search. ► See “Registering a frequently visited place as a favorite place.”
  - 16 The list of menu items appears.
    - **Reorder Icons:** Can change the location of an icon on the Navigation Menu screen.
    - **User’s Manual on Web (QR Code):** Displays the QR code that provides access to the online user manual for the system.
    - **Split Screen:** Can turn on or off the split screen mode.
- ✎ Available icons and their arrangement may differ depending on the vehicle model and specifications.

## Finding a route easily

### Warning

Driving while distracted may cause a loss of vehicle control that may lead to an accident, severe bodily injury, or death. The driver’s primary responsibility is the safe and legal operation of the vehicle, and the use of any devices or systems that take the driver’s attention away from driving.

#### 1 Perform any of the following methods:

- On the All Menus screen, touch **Navigation Menu ► Places.**
- On the map screen, touch .

✎ Press and hold the [NAV] button on the control panel to enter into Places.

#### 2 Enter the location data such as place name, address, or coordinates and then touch **OK.**

✎ To check the recent keyword list, touch .



### 3 Select a destination from the search result.

- ✍ When communication is available, online search is performed first.
- ✍ You can see the sites in the list on the preview screen at the right.
- ✍ To sort the search results in a different order, touch on the attribute to toggle between options.

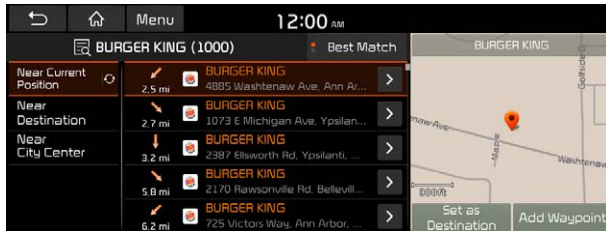

### 4 Touch **Set as Destination**.



- ✍ If you touch **Parking** at the bottom right of the screen, the map screen displays the parking lot icon.

### 5 Select the desired route from the searched ones and touch **Start Guidance**.

- ✍ When there is no searched result, you can see the button that enables to search data offline.

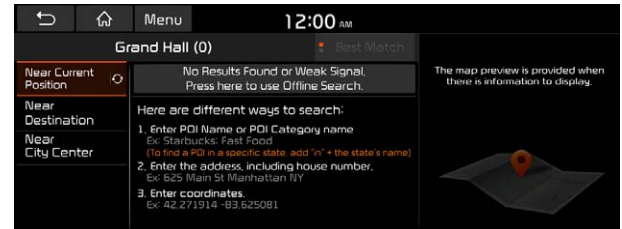

- ✍ When you click the button for offline search and communication is unavailable, search is performed for internal data.

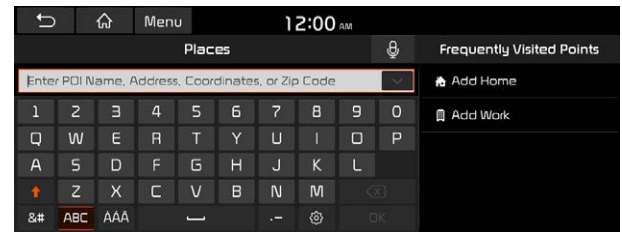

 **Caution**

- Distracted driving or negligence in keeping your eyes forward may cause a loss of vehicle control. Never use any devices or systems that take the driver's attention away from driving.
  - The information on the map may differ from actual road conditions, depending on the location or driving conditions.
    - Digitalized roads may not be identical to the actual roads. When guidance does not match the actual route, drive the vehicle according to actual road conditions.
    - The system may provide guidance that differs from the actual route due to a change in road conditions. When guidance does not match the actual route, drive the vehicle according to road conditions with observing the traffic regulations. When the vehicle reaches a zone that matches the actual route, the system guides the route correctly.
-  Vehicle location may not be displayed correctly if:
- The vehicle is driving on a Y-shaped or winding road with narrow angles.
  - The vehicle is driving closely to another road.
  - The vehicle is driving on a road where there are many tall buildings in the vicinity.
  - The vehicle is driving on a new road or a road under construction.
  - The vehicle is transported by a ferry or heavy-duty transport vehicle.

- The vehicle is driving in a rugged mountain area or on a steep curve road.
- The vehicle is entering a public road after making a turn through the turntable in an underground parking lot or multi-story parking lot.
- The vehicle stops and starts repeatedly or moves slowly in front of an intersection.
- The system reboots after the vehicle battery has been recharged or replaced.
- The vehicle is driving on a slippery road due to heavy snow, etc.
- The tires have been replaced recently or spare tires (or studless tires) are used.
- Improper-sized tires are used or the pressure of each tire is different.
- The replaced tire is worn out or the studless tires have been used for over two seasons.
- A roof carrier is installed on the vehicle.
- On a highway, continued driving causes the system to perform map matching or apply the updated GPS data.

✎ Navigation service may not be provided correctly under the following conditions:

- When the vehicle drives on a straight road continuously, the system may guide you to drive straight. It is not a malfunction.
- Guidance may not be followed immediately after the vehicle makes a turn at an intersection or drives through an intersection.
- The system may guide you to make a U-turn in a prohibited area.
- The system may guide you to a traffic-blocked road (e.g. no-entry road or road under construction).
- The system may guide you to a road away from the destination when there is no road to the destination or there are only narrow roads on the way.
- Guidance may not be proper when the vehicle is off the route.
- Guidance may not match the actual distance on an overpass or underpass due to the difference of the start point.
- When you are driving at high speeds, route recalculations may take longer.

✎ Because the navigation system is used for information purposes only, Kia does not assume responsibility of the accuracy of the information.

✎ When the traffic information is not received, the status icon appears at the top of the map screen.

- HD Radio: The system is using the HD radio data. If no traffic information is available, the status icon (  ) will be displayed instead.

## Map screen

The map screen provides various functions and information, as follows:





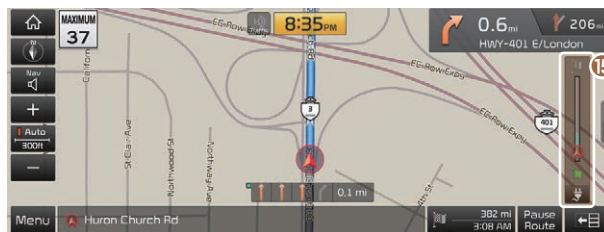

Type A



Type B (EV only)



- 1 Displays the Home screen.
- 2 Used to change the map display mode.
  -  (**Heading Up**): Rotates the map depending on the travel direction.
  -  (**North Up**): Displays the map with the north fixed at the top.
  -  (**3D Map**): Rotates the map depending on the travel direction for 3D view.
- 3 You can adjust the volume of navigation or GPS warning sound.
- 4 Zooms in the map.
- 5 The scale of the map automatically changes.
- 6 Zooms out the map.
- 7 Displays the point to change the driving direction.
- 8 Displays the next point to change the driving direction.
- 9 Displays the lanes in different colors.
  - Orange: Recommended lane
  - White: Available lane
  - Gray: Unavailable lane

- 10 Displays quick menu items that can be used during guidance.
  - 11 Can cancel the route guidance. ► See “Stopping the route guidance.”
  - 12 Displays the remaining distance to the destination and the estimated time of arrival. For more details, touch the information item.
  - 13 Displays or hides the detailed guidance.
  - 14 You can see the system information on the map. (It can display up to two items.)
    - Traffic information (with an icon if there is no HD data reception)
    - Bluetooth connection status
  - 15 Check the range you can drive with the current amount of battery (EV only).
-  The screen may differ depending on the vehicle model and specifications.

## Using the detailed guidance

When the vehicle needs to change the driving direction or lanes, a zoomed-in map automatically appears.

To display or hide the detailed guidance, touch  or .



When the detailed guidance appears while driving, select and perform the desired function.

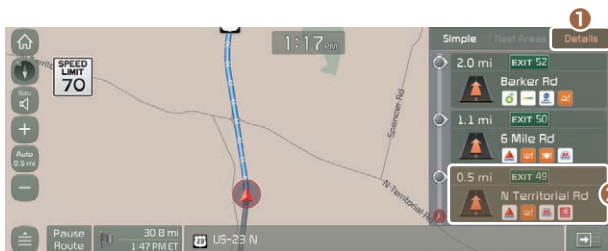



- 1 For more information about the highway exits or rest areas, touch **Details**.
- 2 You can check the POIs near the highway exit.

## Adjusting the navigation volume

You can adjust the volume of navigation or GPS warning sound.

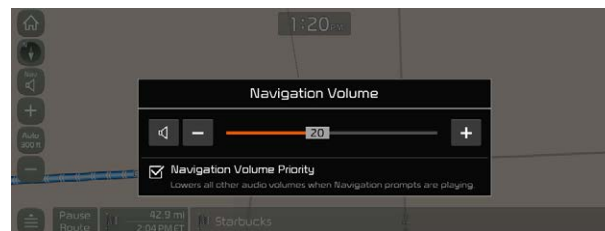
On the map screen, touch  and then touch  or , or use the control bar to adjust the volume.



- 1 To have the navigation sound always output first over media sound, check **Navigation Volume Priority**.
- 2 To turn off the navigation sound, touch  and then touch .
- 3 To adjust the navigation volume, on the All Menus screen, touch **Setup** ► **Sound** ► **Navigation Volume** ► **Use Map Screen Volume Buttons or Volume Knob**. During guidance, use the Volume knob on the control panel or the Volume lever/button on the steering wheel to adjust the navigation volume.  
► See "Use Map Screen Volume Buttons or Volume Knob."

## Stopping the route guidance

To stop route guidance, touch **Pause Route**.

The destination displayed at the bottom of the screen disappears and the **Pause Route** is replaced by **Resume Route**.

- ✎ To resume guidance to the previous destination, touch **Resume Route**.
- ✎ To cancel guidance to the destination, touch and hold **Pause Route**, **Resume Route**, or **Navigation Menu** ► **Cancel Route** on the All Menus screen.

## Seeing traffic information

You can see real-time traffic information such as ongoing road works or accidents.

- 1 On the map screen, touch  ► **Traffic**.

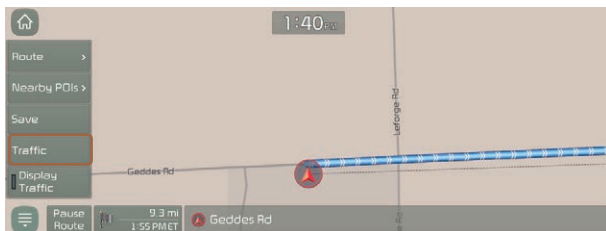

- 2 Select an item from the real-time traffic information list and see the details.

- ✎ To reroute using recent traffic information while in guidance, touch **Detour**.
- ✎ To see traffic information along the current route or to see all available traffic information, touch **On Route**.
- ✎ To select the type of traffic information, touch **Filter**.

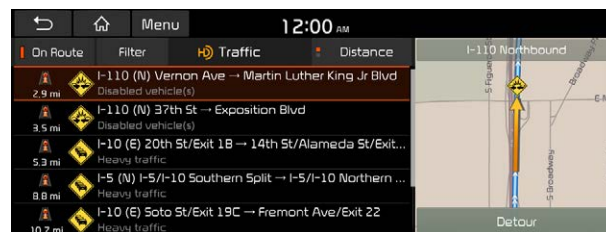

- 3 Check the detailed traffic information.

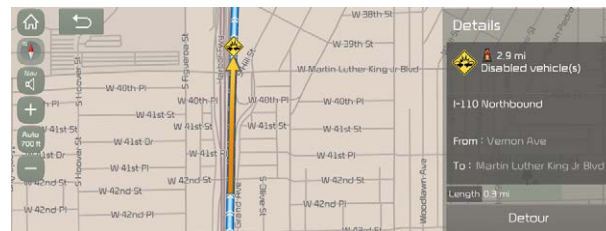

- ✎ Traffic information for border crossings and speed limits for individual roads may not be accurate. Depending on the road conditions, note the information.

# Various ways to find routes

On the Navigation menu, you can set the destination by using various searches, such as entering the location information or selecting from recent destinations or categorized places.

Perform any of the following methods:

- On the All Menus screen, touch **Navigation Menu**.
- On the control panel, press the [NAV] button.





 Available icons and their arrangement may differ depending on the vehicle model and specifications.

## Searching by keyword

Enter various types of keywords such as place name and address and then search for the destination.

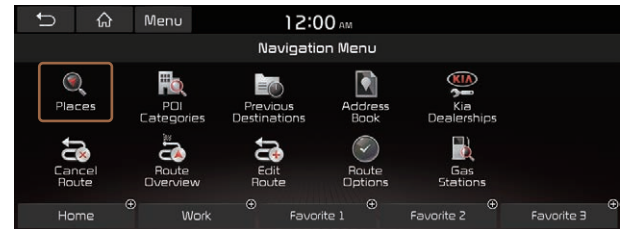
- 1 On the **Navigation Menu** screen, touch **Places**.



 Available icons and their arrangement may differ depending on the vehicle model and specifications.

2 Enter the location data such as place name, address, or coordinates and then touch **OK**.

✍ When there are any similar matches, the recommendations appear at the right of keypad.

✍ To access the online user's manual on the Places screen, touch **Menu ► User's Manual on Web (QR Code)** and then scan the displayed QR code.

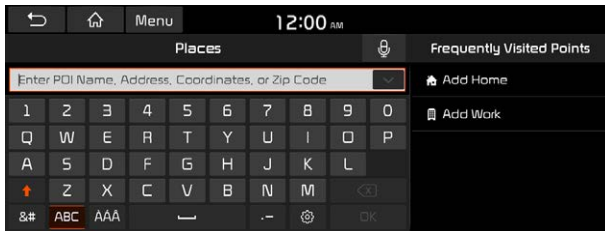

3 Select a destination from the search result.

✍ You can see the sites in the list on the preview screen at the right.

✍ To sort the search results in a different order, touch on the attribute to toggle between options.

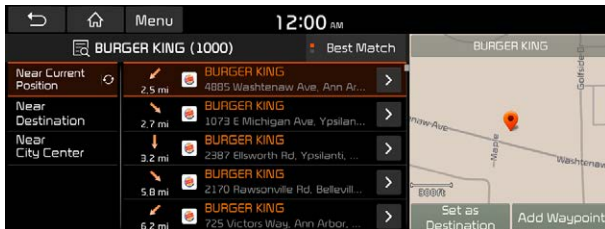

4 Check the location of the destination and then touch **Set as Destination**.



✍ If you touch **Parking** at the bottom right of the screen, the map screen displays the parking lot icon.

5 Select the desired route from the searched ones and touch **Start Guidance**.

## Searching by previous destinations

You can set a destination by selecting from the recently searched ones.



### 1 On the **Navigation Menu** screen, touch **Previous Destinations**.

The navigated destinations appear in the list.



 Available icons and their arrangement may differ depending on the vehicle model and specifications.

### 2 Select the desired destination from the list.

-  To categorize the searched items, select a category.
-  To sort the search results in a different order, touch on the attribute to toggle between options.
-  To access the online user's manual on the Previous Destinations screen, touch **Menu ► User's Manual on Web (QR Code)** and then scan the displayed QR code.

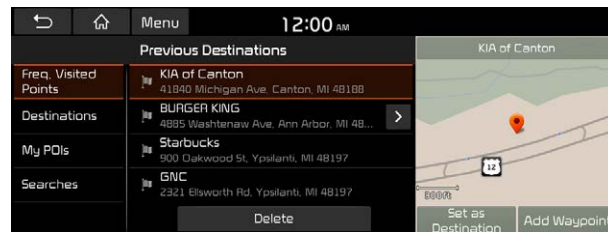

### 3 Check the location of the destination and then touch **Set as Destination**.

### 4 Select the desired route from the searched ones and touch **Start Guidance**.

## Deleting a previous destination

- 1 On the Previous Destinations screen, touch **Delete**.
- 2 Select the destination(s) to delete and touch **Delete**.

You can delete the selected place(s) or all places.

## Searching for Kia Dealerships (if equipped)

You can easily search for service centers or service stations.

- 1 On the **Navigation Menu** screen, touch **Kia Dealerships**.



-  Available icons and their arrangement may differ depending on the vehicle model and specifications.

## 2 Select a Kia Dealerships from the list.

- ✍ To sort the search results in a different order, touch on the attribute to toggle between options.
- ✍ To access the online user's manual, on the Kia Dealerships screen, touch **Menu ► User's Manual on Web (QR Code)** and then scan the displayed QR code.

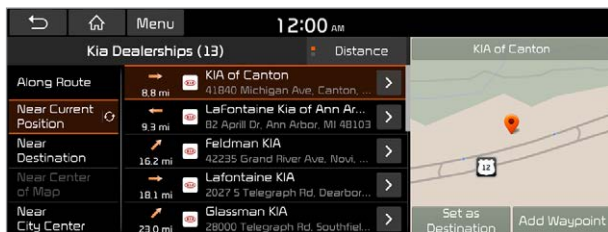

## 3 Check the location of the destination and then touch **Set as Destination**.

## 4 Select the desired route from the searched ones and touch **Start Guidance**.

## Searching the nearby points of interest

You can set a destination after searching the nearby points of interest by the category.

### 1 On the **Navigation Menu** screen, touch **POI Categories**.

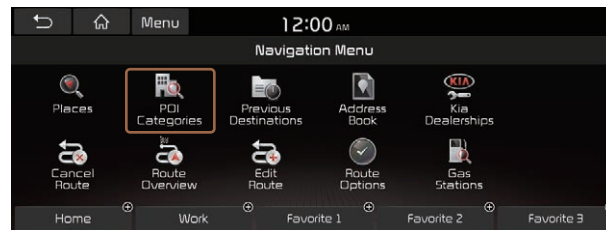

- ✍ Available icons and their arrangement may differ depending on the vehicle model and specifications.



## 2 Select a desired point according to the instructions.

- ✍ To access the online user's manual on the POI Categories screen, touch **Menu ► User's Manual on Web (QR Code)** and then scan the displayed QR code.
- ✍ The screen may differ depending on the vehicle model and specifications.

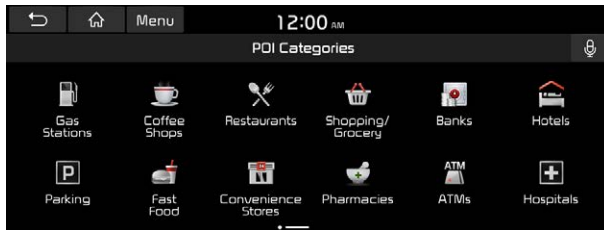

## 3 Select a destination from the search result.

- ✍ To categorize the searched items, select a category.
- ✍ To sort the search results in a different order, touch on the attribute to toggle between options.
- ✍ The screen may differ depending on the vehicle model and specifications.

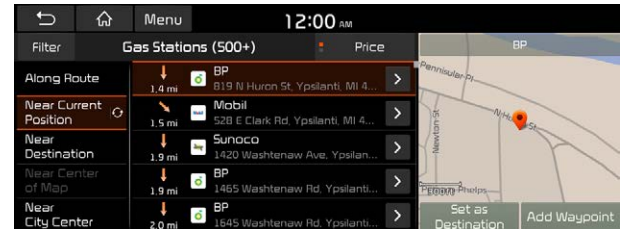

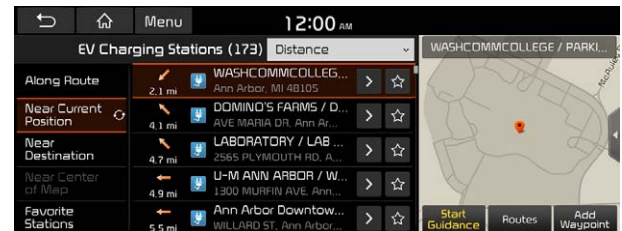

Type A



Type B (EV only)

4 Check the location of the destination and then touch **Set as Destination**.

- ✎ To change the type of nearby POIs on the map, touch  **► Nearby POIs ► POI Display Setting**.
- ✎ To see nearby POIs during guidance on the map, touch  **► Nearby POIs ► POI Categories**.
- ✎ The screen may differ depending on the vehicle model and specifications.

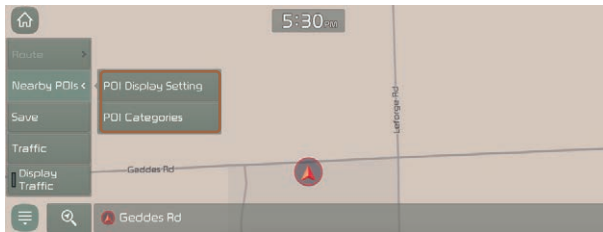

5 Select the desired route from the searched ones and touch **Start Guidance**.

## Displaying the points of interest on the map

You can set to display nearby points of interest on the map.

On the map screen, touch  **► Nearby POIs ► POI Display Setting** and then select an item to display on the map.

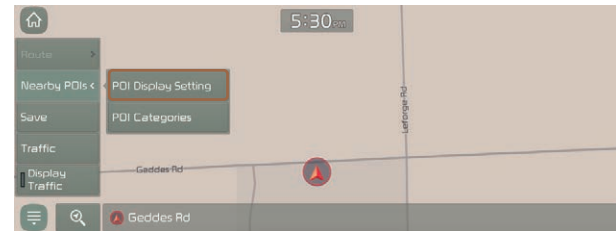

- ✎ The screen may differ depending on the vehicle model and specifications.

## Searching for restaurants (if equipped)

- 1 On the **Navigation Menu** screen, touch **Restaurants**.

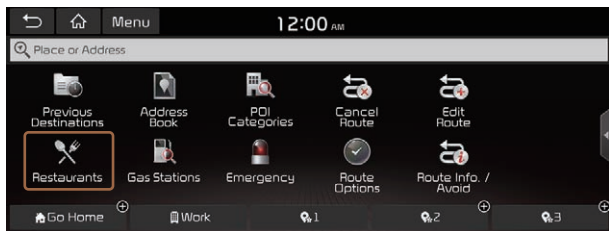

Available icons and their arrangement may differ depending on the vehicle model and specifications.

- 2 Select a destination from the search result.

- Available icons and their arrangement may differ depending on the vehicle model and specifications.
- To sort the search results in a different order, touch on the attribute to toggle between options.
- To access the online user's manual on the Restaurants screen, touch **Menu ► User's Manual on Web (QR Code)** and then scan the displayed QR code.

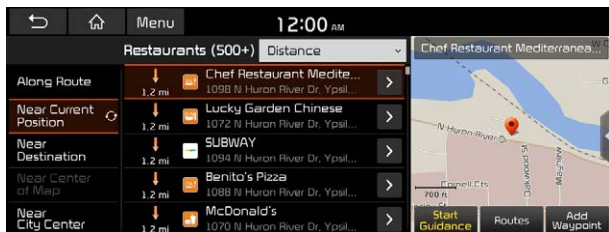

- 3 Check the location of the destination and then touch **Start Guidance**.

## Searching for emergency services

(if equipped)

- 1 On the **Navigation Menu** screen, touch **Emergency**.



Available icons and their arrangement may differ depending on the vehicle model and specifications.

## 2 Select the type of emergency service.

- ✍ Use the location information at the bottom of the screen, if necessary to contact the desired emergency service.
- ✍ To access the online user's manual on the Emergency screen, touch **Menu ► User's Manual on Web (QR Code)** and then scan the displayed QR code.

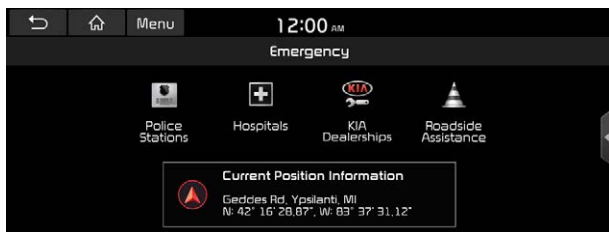

## 3 Select a destination from the search result.

- ✍ To sort the search results in a different order, touch on the attribute to toggle between options.

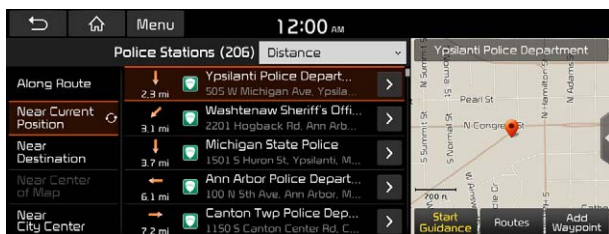

## 4 Check the location of the destination and then touch **Start Guidance**.

## Editing the route

You can edit the current route so that you can travel via waypoints on the way to the destination. You can add up to two waypoints.

## Setting a waypoint

You can search for the desired place and set it as a waypoint.

## 1 On the **Navigation Menu** screen, touch the desired search method to search for a waypoint.



- ✍ Available icons and their arrangement may differ depending on the vehicle model and specifications.
- ✍ For more information about the waypoint search:
  - see “Searching by keyword,” “Searching by previous destinations,” “Searching the nearby points of interest,” “Searching for restaurants (if equipped),” “Searching for emergency services (if equipped).”

- 2 On the map for a search, touch **Add Waypoint**.  
The selected waypoint is immediately added to the route.



- 3 After adding waypoints, touch **Reroute**.  
To access the online user's manual on the Edit Route screen, touch **Menu ► User's Manual on Web (QR Code)** and then scan the displayed QR code.

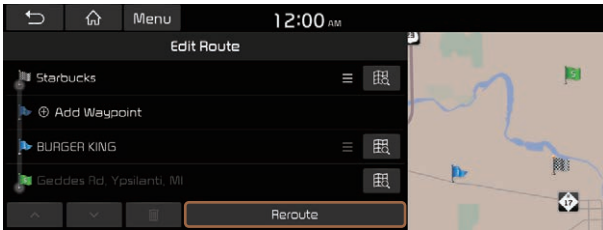

- 4 Select the updated route and then touch **Start Guidance**.

## Changing the order of waypoints

You can change the order of waypoints on the route.

- 1 On the **Navigation Menu** screen, touch **Edit Route**.
- 2 To change the order of waypoints, select a waypoint and then touch **▲** or **▼**.
  - To add another waypoint on the Edit Route screen, touch **Add waypoint**.
  - To see on the map, touch **🗺** next to the name.

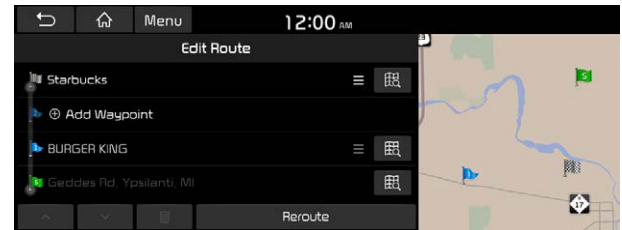

- 3 After editing the route, touch **Reroute**.
- 4 Select the updated route and then touch **Start Guidance**.

## Deleting a waypoint

You can delete a waypoint from the route.

- 1 On the **Navigation Menu** screen, touch **Edit Route**.
- 2 Select a waypoint to delete from the route and then touch .

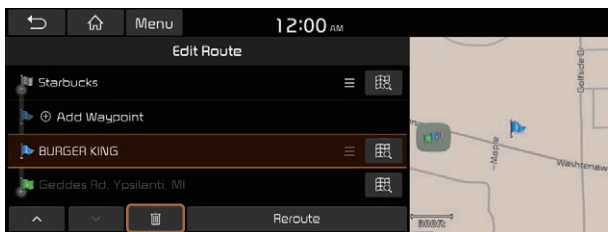

- 3 To search the route again after removing the waypoint, touch **Reroute**.
- 4 Select the updated route and then touch **Start Guidance**.

## Avoiding specific zones (if equipped)

You can resume routing after excluding the specified roads such as congested roads or roads under construction.

- 1 On the **Navigation Menu** screen, touch **Route Overview**.
- 2 Touch **Route Info. / Avoid**.

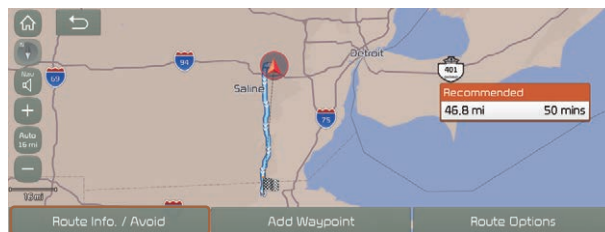

-  The screen may differ depending on the vehicle model and specifications.

- 3 Select the roads to avoid and touch **Avoid the Selected Road**.

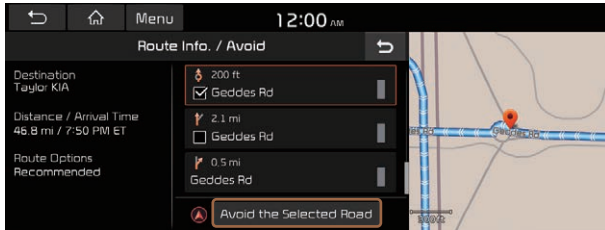



- 4 Select the updated route and then touch **Start Guidance**.

 When there is any zone under construction ahead on the way, you are prompted to confirm whether or not to exclude the zone from the route. To avoid the zone, touch **Yes** to resume routing.

## Changing the route search criteria

You can change the route search criteria to resume routing.

- 1 On the **Navigation Menu** screen, touch **Route Options**.
- 2 Select the search criteria and touch **Recalculate**.
  -  To access the online user's manual on the Route Options screen, touch **Menu** ► **User's Manual on Web (QR Code)** and then scan the displayed QR code.
  -  Available options may differ depending on the vehicle model and specifications.

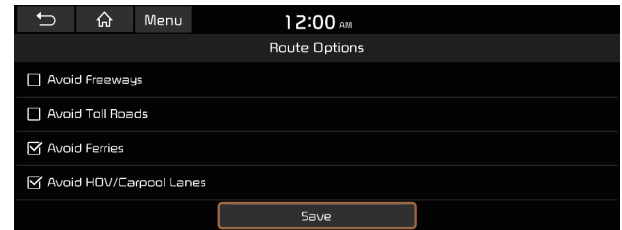

## Avoiding specific zones (if equipped)

You can resume routing after excluding the specified roads such as congested roads or roads under construction.

1 On the **Navigation Menu** screen, touch **Route Info. / Avoid.**

2 Select the roads to avoid and then touch **Avoid the Selected Road.**

 To access the online user's manual on the Route Info screen, touch **Menu ► User's Manual on Web (QR Code)** and then scan the displayed QR code.

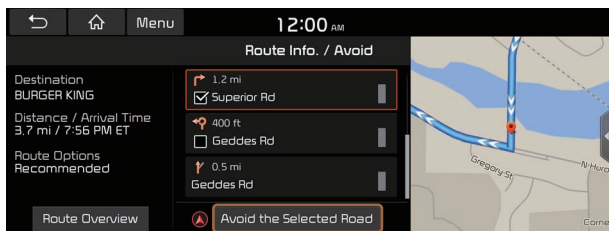

3 Select the updated route and then touch **Start Guidance.**

 When there is any zone under construction ahead on the way, you are prompted to confirm whether or not to exclude the zone from the route. To avoid the zone, touch **Yes** to resume routing.

## Using the address book

After registering the current location or frequently visited places, you can easily set any of them as a destination.

### Registering a searched place as a favorite place

You can search and register the desired place.

1 On the **Navigation Menu** screen, touch **Address Book.**



 Available icons and their arrangement may differ depending on the vehicle model and specifications.



## 2 On the **Address Book** screen, touch **My Places**.

- ✎ To access the online user's manual on the Address Book screen, touch **Menu ► User's Manual on Web (QR Code)** and then scan the displayed QR code.

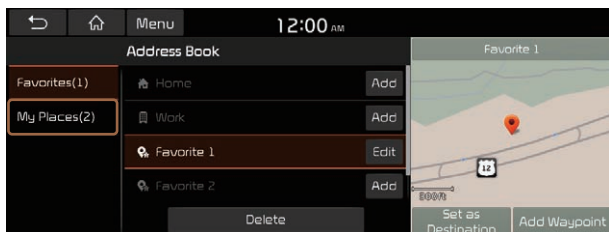

## 3 Touch **Add**.

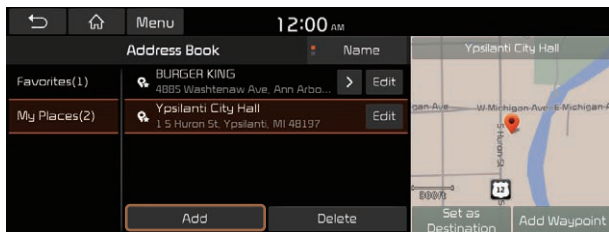

## 4 Touch **Places** and enter a keyword for a search.

- ✎ You can also search for the place by using other methods.  
► See "Various ways to find routes."

## 5 Check the location and information of the current position and then touch **OK**.

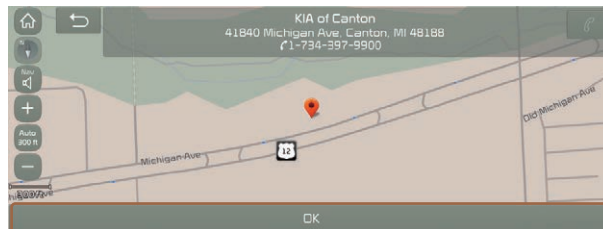

The place is registered as a favorite place.

## Registering the current position as a favorite place

- 1 On the map screen, touch  ► **Save**.

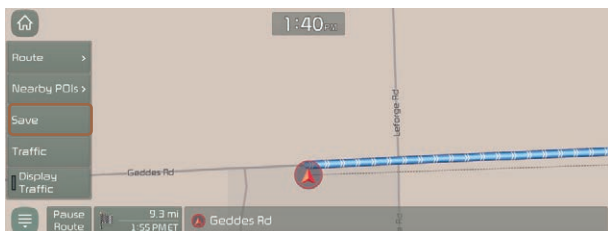

- 2 If necessary, touch **Save** after making changes.

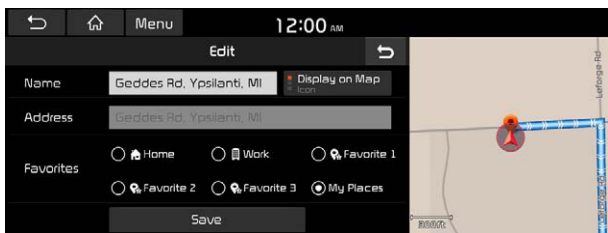

The place is registered as a favorite place.

## Registering a frequently visited place as a favorite place

You can register your home, office, or other frequently visited place as a favorite.

- 1 At the bottom of the **Navigation Menu** screen, select a button that has .

 Long-press a button you have assigned as a favorite to edit or delete the place.



 Available icons and their arrangement may differ depending on the vehicle model and specifications.

- 2 Touch **Places** and enter a keyword for a search.

 You can also search for the place by using other methods.  
► See "Various ways to find routes."

- 3 Check the location and information of the current position and then touch **OK**.

The selected place is saved as a favorite and displayed as a shortcut button at the bottom of the Navigation Menu screen.

## Setting a registered favorite place as a destination

You can set any in the address book of the navigation system as a destination.

- 1 On the **Navigation Menu** screen, touch **Address Book**.
- 2 Select the desired group.

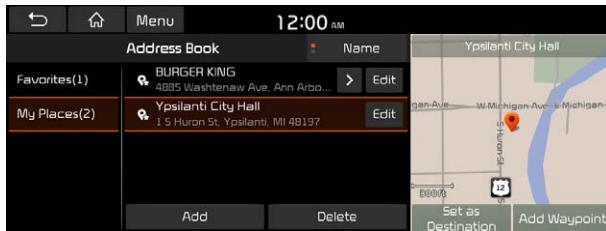

- 3 Select the place to set as a destination.
- 4 Check the location of the destination and then touch **Set as Destination**.
- 5 Select the desired route from the searched ones and touch **Start Guidance**.

## Registering a frequently visited place as a destination

You can set your home, office, or other frequently visited places as a destination directly from your favorites list once you add them.

At the bottom of the **Navigation Menu** screen, touch a desired shortcut button.

Route guidance immediately starts for the destination.



- ✎ When guidance to a destination is in progress, touch **Change Destination**.
- ✎ Available icons and their arrangement may differ depending on the vehicle model and specifications.

## Editing the registered place

You can change the place name, phone number, and other information of a favorite place.

- 1 On the **Navigation Menu** screen, touch **Address Book**.
- 2 Select a group that contains the destination to change at the left of the screen.

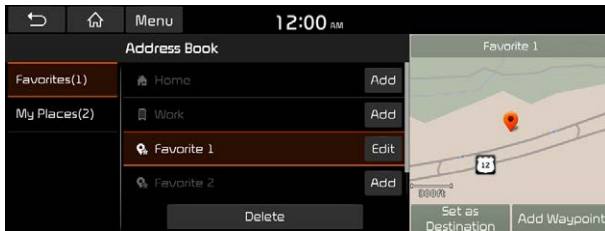

- 3 Touch **Edit** next to the place for information change.

- 4 After changing the information, touch **Save**.

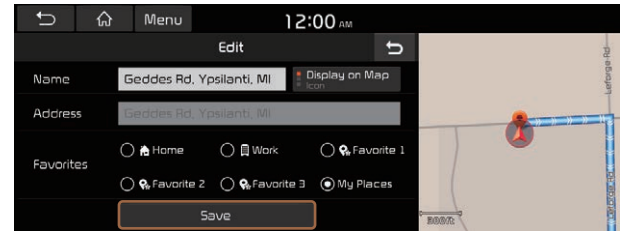

## Deleting a registered favorite place(s)

- 1 On the **Navigation Menu** screen, touch **Address Book**.
- 2 Select the desired group.
- 3 Among the registered favorite places, select a place to delete and touch **Delete**.
- 4 Select the destination(s) to delete and touch **Delete**.

## Importing/exporting the address book (if equipped)

You can import location data from a USB device to the system, or export the data on the system to a USB device.



- ✍ When importing or exporting the location data, you can use only the USB device formatted in exFAT, FAT16/32, or NTFS.
- ✍ The previous location data on the system is deleted after an import.
- ✍ While importing from a navigation system that uses a different coordinate system, the locations may appear differently.

## Searching for gas stations

- 1 On the **Navigation Menu** screen, touch **Gas Stations**.



- ✍ Available icons and their arrangement may differ depending on the vehicle model and specifications.

## 2 Select a destination from the search result.

- ✍ To categorize the searched items, select a category.
- ✍ To sort the search results in a different order, touch on the attribute to toggle between options.
- ✍ To access the online user's manual on the Gas Stations screen, touch **Menu ► User's Manual on Web (QR Code)** and then scan the displayed QR code.

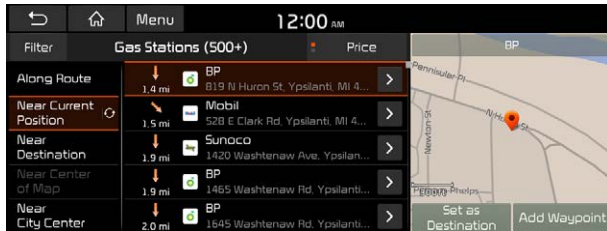

## 3 Check the location of the destination and then touch **Set as Destination**.

## 4 Select the desired route from the searched ones and touch **Start Guidance**.

# Searching for EV (Electric Vehicle) charging stations (EV only)

## 1 On the **Navigation Menu** screen, touch **EV Charging Stations**.

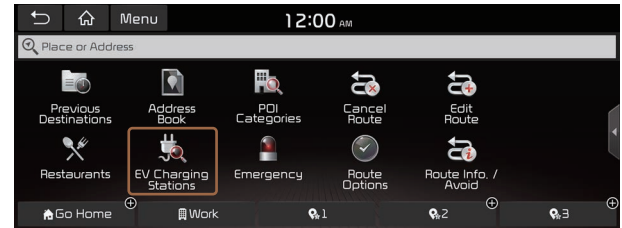

- ✍ When the station data is received in real time, the menu name changes to "**Real-time Stations**."

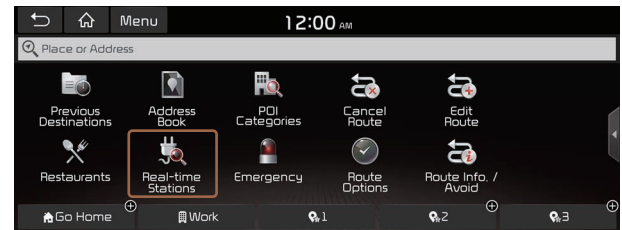

## 2 Select a destination from the search result.

- ✍ To categorize the searched items, select a category.
- ✍ To sort the search results in a different order, touch on the attribute to toggle between options.
- ✍ To access the online user's manual on the EV Charging Stations screen, touch **Menu ► User's Manual on Web (QR Code)** and then scan the displayed QR code.



## 3 Check the location of the destination and then touch **Start Guidance**.

# END USER LICENSE AGREEMENT

PLEASE READ THIS END USER LICENSE AGREEMENT ("EULA") CAREFULLY BEFORE USING THE NAVIGATION SYSTEM.

This is a license agreement between you and Hyundai MnSoft, INC. including its affiliates ("COMPANY") regarding a copy of the COMPANY navigable map database together with associated software, media and explanatory printed documentation published by COMPANY (jointly the "Product"). The Product is provided for your personal, internal use only and not for resale. It is protected by copyright and is subject to the following terms which are agreed to by you, on the one hand, and COMPANY and its licensors (and their licensors and suppliers) (collectively, "Licensors") on the other hand.

By using the Product, you accept and agree to all terms and conditions in this End User License Agreement ("EULA"). IF YOU DO NOT AGREE TO THE TERMS OF THIS EULA, YOU MUST PROMPTLY EXIT THE PRODUCT OPERATION PROGRAM AND DO NOT USE OR ACCESS TO THE PRODUCT. YOU AGREE THAT YOUR RIGHTS UNDER THIS EULA MAY BE TERMINATED AUTOMATICALLY WITHOUT NOTICE IF YOU FAIL TO COMPLY WITH ANY TERM(S) OF THIS EULA.

## Terms and Conditions

**Personal Use Only.** You agree to use this Product together with COMPANY's authorized application for the solely personal, non-commercial purposes for which you were licensed, and not for service bureau, time-sharing or other similar purposes. Accordingly, but subject to the restrictions set forth in the following paragraphs, you agree not to otherwise reproduce, copy, modify, decompile, disassemble, create any derivative works of, or reverse engineer any portion of this Data, and may not transfer or distribute it in any form, for any purpose, except to the extent permitted by mandatory laws. You may not assign this EULA or any of the rights or licenses granted under this EULA, except when installed in the system for which it was created.

**Restrictions.** Except where you have been specifically licensed to do so by COMPANY, and without limiting the preceding paragraph, you may not use the Product (i) with any products, systems, or applications installed or otherwise connected to or in communication with vehicles, capable of vehicle navigation, positioning, dispatch, real time route guidance, fleet management or similar applications; or (ii) with or in communication with any positioning devices or any mobile or wireless-connected electronic or computer devices, including without limitation cellular phones, palmtop and handheld computers, pagers, and personal digital assistants or PDAs.

**COPYING OR USE OF THE PRODUCT EXCEPT AS PERMITTED BY THIS EULA IS UNAUTHORIZED AND IS COPYRIGHT INFRINGEMENT UNDER THE LAWS OF YOUR COUNTRY. IF YOU COPY OR USE THE PRODUCT WITHOUT COMPANY'S PERMISSION, EXCEPT AS PERMITTED BY THIS EULA, YOU ARE VIOLATING THE LAW AND LIABLE TO COMPANY AND ITS LICENSORS FOR DAMAGES, AND YOU MAY BE SUBJECT TO CRIMINAL PENALTIES.**

THE PRODUCT MAY INCLUDE ENFORCEMENT TECHNOLOGY DESIGNED TO PREVENT (i) UNAUTHORIZED COPYING OF THE PRODUCT ONTO PHYSICAL STORAGE MEDIA OR VIA TRANSFER OVER THE INTERNET OR OTHER ELECTRONIC COMMUNICATION MEANS AND/OR (ii) ILLEGAL USAGE OF THE PRODUCT OTHER THAN BY A SPECIFICALLY AHTORIZED DEVICE. YOU AGREE THAT COMPANY MAY USE THESE MEASURES TO PROTECT COMPANY AND THE LICENSORS AGAINST COPYRIGHT INFRINGEMENT.

**Uploads.** The Product may provide functionality through which you are able to upload certain information about your use of the Product (collectively, "Uploads") to COMPANY's servers or receive other services from COMPANY (collectively, the "Services"). If you use such functionality, you authorize COMPANY to retain your Uploads on its servers. COMPANY will have no obligation to provide any Services, may change the form and nature of any Services at any time with or without notice to you, will have no liability whatsoever to you for any failure of the Product or Services to transmit your Uploads to or from COMPANY's servers, may cease providing any Services at any time with or without notice to you, and will have no obligation to retain your Uploads (or any other materials you may provide to COMPANY) on its servers or return your Uploads (or any other materials you may provide to COMPANY) to you before deleting them from its servers.



**Storage.** The Product may provide functionality through which you are able to store information (such as images) on the device on which you are using the Product. COMPANY will have no liability whatsoever to you or any third party for any failure of the Product to store any such information on such device.

**Personal Information.** By using the Product, you agree to the collection, retention and processing of your personal data (including the location of your mobile device) by COMPANY and to the storage and processing of such personal information on computers located outside of the country in which you reside. Even though COMPANY has taken steps intended to protect your personal information from being intercepted, accessed, used, or disclosed by unauthorized persons, COMPANY cannot fully eliminate security risks associated with your personal information and cannot guarantee that its systems will not be breached. See [\*] for additional information regarding COMPANY's use of your personal information.

**WARNING. THE PRODUCT REFLECTS REALITY AS EXISTING BEFORE YOU RECEIVED THE PRODUCT AND IT COMPRISES DATA AND INFORMATION FROM GOVERNMENT OTHER SOURCES. ACCORDINGLY, THE PRODUCT MAY CONTAIN INACCURATE OR INCOMPLETE INFORMATION DUE TO THE PASSAGE OF TIME, CHANGING CIRCUMSTANCES, SOURCES USED AND THE NATURE OF COLLECTING COMPREHENSIVE GEOGRAPHIC PRODUCT, ANY OF WHICH MAY LEAD TO INCORRECT RESULTS.** THE PRODUCT AND SERVICES MAY NOT TO BE USED FOR SAFETY OF LIFE APPLICATIONS, OR FOR ANY OTHER APPLICATION IN WHICH THE ACCURACY OR RELIABILITY OF THE PRODUCT OR SERVICES COULD CREATE A SITUATION WHERE PERSONAL INJURY OR DEATH MAY OCCUR. **DO NOT ATTEMPT TO CONFIGURE THE PRODUCT OR INPUT INFORMATION WHILE DRIVING. FAILURE TO PAY FULL ATTENTION TO THE OPERATION OF YOUR VEHICLE COULD RESULT IN DEATH, SERIOUS INJURY, OR PROPERTY DAMAGE. BY USING THE PRODUCT, YOU ASSUME ALL RESPONSIBILITY AND RISK.**

**Disclaimer of Warranty.** The Product is provided to you "as is," and you agree to use it at your own risk. SUBJECT TO THE APPLICABLE LAWS, COMPANY AND THE LICENSORS MAKE NO GUARANTEES, REPRESENTATIONS OR WARRANTIES OF ANY KIND, EXPRESS OR IMPLIED, ARISING BY LAW OR OTHERWISE, INCLUDING BUT NOT LIMITED TO, CONTENT, QUALITY, ACCURACY, COMPLETENESS, EFFECTIVENESS, RELIABILITY, PERFORMANCE, MERCHANTABILITY, FITNESS FOR A PARTICULAR PURPOSE, NON-INFRINGEMENT, USEFULNESS, USE OR RESULTS TO BE OBTAINED FROM THE PRODUCT, OR THAT THE PRODUCT OR SERVER WILL BE UNINTERRUPTED OR ERROR-FREE, OR THAT ERRORS IN THE PRODUCT OR NONCONFORMITY TO ITS DOCUMENTATION CAN OR WILL BE CORRECTED. YOU ACKNOWLEDGE THAT THE PROVISIONS OF THIS SECTION ARE A MATERIAL INDUCEMENT AND CONSIDERATION TO COMPANY AND THE LICENSORS TO GRANT THE LICENSE CONTAINED IN THIS EULA AND TO PROVIDE YOU WITH ACCESS TO THE SERVICES.

**Limitation of Liability:** TO THE MAXIMUM EXTENT PERMITTED UNDER THE APPLICABLE LAWS, COMPANY AND THE LICENSORS SHALL NOT BE LIABLE TO YOU: IN RESPECT OF ANY CLAIM, DEMAND OR ACTION, IRRESPECTIVE OF THE NATURE OF THE CAUSE OF THE CLAIM, DEMAND OR ACTION ALLEGING ANY LOSS, INJURY OR DAMAGES, DIRECT OR INDIRECT, INCURRED BY YOU OR ANY THIRD PARTY WHICH MAY ARISE IN CONNECTION WITH OR RESULT FROM THE USE OR POSSESSION OF THE PRODUCT; OR FOR ANY LOSS OF DATA, PROFIT, REVENUE, CONTRACTS OR SAVINGS, OR OTHER DIRECT, INDIRECT, INCIDENTAL, SPECIAL OR CONSEQUENTIAL DAMAGES ARISING OUT OF YOUR USE OF OR INABILITY TO USE THE PRODUCT, ANY DEFECT IN THE PRODUCT, OR THE BREACH OF THESE TERMS OR CONDITIONS, WHETHER IN AN ACTION IN CONTRACT OR TORT OR BASED ON A WARRANTY, EVEN IF COMPANY OR THE LICENSORS HAVE BEEN ADVISED OF THE POSSIBILITY OF SUCH DAMAGES AND NOTWITHSTANDING THE FAILURE OF ANY LIMITED REMEDY PROVIDED HEREIN.

**Exclusions.** Some jurisdictions do not allow certain warranty exclusions or the limitation or exclusion of liability, so to that extent the above exclusion may not apply to you. To the extent that COMPANY may not, as a matter of applicable law, disclaim any implied warranty or limit its liabilities, the scope and duration of such warranty and the extent of COMPANY's liability shall be the minimum permitted under such applicable law. The disclaimer of warranty and limitation of liability set forth in this EULA does not affect or prejudice your statutory rights where you have acquired the Product otherwise than in the course of business.

**Third-Party Copyright Notices.** The third-party sourced data has been incorporated into or made a part of the Product and is being sublicensed to you subject to the terms and conditions of this EULA. In this regard, you shall not remove or tamper with any intellectual property rights notice attached or used in relation to data supplied by the Licensors.

**Entire Agreement.** This EULA is the entire agreement between COMPANY (and the Licensors) and you pertaining to the subject matter hereof, and supersedes in their entirety any and all previous written or oral communications or documents (including, if you are obtaining an update, any agreement that may have been included with an earlier version of the Product) with respect to such subject matter.

**Governing Law.** This EULA shall be governed by the laws of the jurisdiction in which you reside at the date of acquisition of the Product. Should you at that moment reside outside the European Union or Switzerland, the law of the jurisdiction within the European Union or Switzerland where you acquired the Product shall apply. In all other cases, or if the jurisdiction where you acquired the Product cannot be defined, the laws of the Republic of Korea shall apply. This EULA will not be governed by the U.N. Convention on Contracts for the International Sale of Goods. The courts competent at your place of residence at the time you acquired the Product shall have jurisdiction over any dispute arising out of, or relating to this EULA, without prejudice to COMPANY's right to bring claims at your then current place of residence.

**Export Control.** You agree not to export or re-export from anywhere any part of the Product in any form except in compliance with applicable export laws, rules and regulations, including but not limited to the laws, rules and regulations administered by the Office of Foreign Assets Control of the U.S. Department of Commerce and the Bureau of Industry and Security of the U.S. Department of Commerce.

**Miscellaneous.** If any provision of this EULA is found to be invalid or unenforceable, it will be enforced to the extent permissible and the remainder of this EULA will remain in full force and effect. Failure by COMPANY to prosecute any right with respect to a default hereunder will not constitute a waiver by COMPANY of the right to enforce rights with respect to the same or any other breach. No refunds or replacements will be permitted on damaged Product.

**U.S. Government End Users.** If the Product is being acquired by or on behalf of the United States Government or any other entity seeking or applying rights similar to those customarily claimed by the United States Government, this Product and related documentation are "Commercial Items" as that term is defined at 48 C.F.R. ("FAR") 2.101. This Product and related documentation are licensed to the United States Government end users (a) only as "Commercial Items" and (b) with only those rights as are granted to all other end users in accordance with this EULA, and each copy of Product delivered or otherwise furnished shall be marked and embedded as appropriate with the following "Notice of Use," and shall be treated in accordance with such Notice:

## NOTICE OF USE

CONTRACTOR (MANUFACTURER/ SUPPLIER) NAME: Hyundai MnSoft, Inc.

CONTRACTOR (MANUFACTURER/SUPPLIER) ADDRESS: 74 Wonhyo-ro, Yongsan-gu, Seoul 140-711, Republic of Korea

This Product and related documentation are commercial items as defined in FAR 2.101 and is subject to this EULA under which this Product is provided.

© 2013 Hyundai MnSoft. All rights reserved

If the Contracting Officer, federal government agency, or any federal official refuses to use the legend provided herein, the Contracting Officer, federal government agency, or any federal official must notify COMPANY prior to seeking additional or alternative rights in the Product.

**End-User Terms Required by HERE.** The Product utilizes map data that COMPANY licenses from HERE and the following copyright notices apply to such map data (the "HERE Data"): © 2013 HERE. All rights reserved.

The HERE Data for areas of Canada includes information taken with permission from Canadian authorities, including: © Her Majesty the Queen in Right of Canada, © Queen's Printer for Ontario, © Canada Post Corporation, GeoBase ®, © Department of Natural Resources Canada. All rights reserved.

HERE holds a non-exclusive license from the United States Postal Service® to publish and sell ZIP+4® information.

©United States Postal Service® 2010. Prices are not established, controlled or approved by the United States Postal Service®.

The following trademarks and registrations are owned by the USPS: United States Postal Service, USPS, and ZIP+4.

The HERE Data for Mexico includes certain data from Instituto Nacional de Estadística y Geografía.

Austria: © Bundesamt für Eich- und Vermessungswesen

Croatia, Cyprus, Estonia, Latvia, Lithuania, Moldova, Poland, Slovenia and/or Ukraine: © EuroGeographics

France: source: © IGN 2009 – BD TOPO ®

Germany: Die Grundlagendaten wurden mit Genehmigung der zustaendigen Behoerden entnommen

Great Britain: Contains Ordinance Survey data © Crown copyright and database right 2010, and Royal Mail data © Royal Mail copyright and database right 2010.

Greece: Copyright Geomatics Ltd.

Italy: La Banca Dati Italiana è stata prodotta usando quale riferimento anche cartografia numerica ed al tratto prodotta e fornita dalla Regione Toscana.

Norway: Copyright © 2000; Norwegian Mapping Authority

Portugal: Source: IgeoE – Portugal

Spain: Información geográfica propiedad del CNIG

Sweden: Based upon electronic data Ó National Land Survey Sweden

Switzerland: Topografische Grundlage: Ó Bundesamt für Landestopographie

United Kingdom: Contains public sector information licensed under the Open Government Licence v1.0 (see for the license <http://www.nationalarchives.gov.uk/doc/open-government-licence/>) and is adapted from data from the office for National Statistics licensed under the Open Government Licence v.1.0.

Israel: © Survey of Israel data source

Jordan: © Royal Jordanian Geographic Centre. The foregoing notice requirement for Jordan Data is a material term of the Agreement. If Client or any of its permitted sublicensees (if any) fail to meet such requirement, HERE shall have the right to terminate Client's license with respect to the Jordan Data.

Mozambique: Certain Data for Mozambique provided by Cenacarta © 20XX by Cenacarta

Réunion: source: © IGN 2009 - BD TOPO ®

**End-User Terms Required by ZENRIN.** The Product utilizes map data that COMPANY licenses from ZENRIN and the following copyright notices apply to such map data (the "ZENRIN Data"):

Europe: Junction View Data provided by ZENRIN CO., LTD. Copyright © 20XX, All Rights Reserved.

Europe: Junction View Data and Exit View Data provided by ZENRIN CO., LTD. Copyright © 20XX, All Rights Reserved.

North America: Junction View Data provided by ZENRIN USA, INC. Copyright © 20XX, All Rights Reserved; Junction View Data fourni par ZENRIN USA, INC. Copyright © 20XX. Tous droits réservés; Las imágenes de las rutas alternas son proveídas por ZENRIN USA, INC. Copyright © 20XX. Todos los derechos reservados.

© 2013 Hyundai MnSoft. All rights reserved.

### **Copyright for Brand Icon**

The marks of companies displayed by this product to indicate business locations are the marks of their respective owners. The use of such marks in this product does not imply any sponsorship, approval, or endorsement by such companies of this product.

### **Copyright for Junction View**

Junction View Data provided by ZENRIN USA, INC. Copyright(C) 20XX, All rights Reserved.

### **About Map Updates**

You can contact your KIA dealer or call at 1-888-757-0010.



The Data and all copyrights and intellectual property or neighboring rights therein are owned by HERE and Hyundai MnSoft Inc.

Importance Notice: This is protected by U.S. copyright laws.

You may not extract or reutilize substantial parts of the contents of the Data, nor reproduce, copy, modify, adapt, translate, disassemble, decompile or reverse engineer any portion of the Data, except to the extent explicitly permitted by mandatory laws.

© 1987-2019 HERE. All rights reserved.

# 06

## Phone

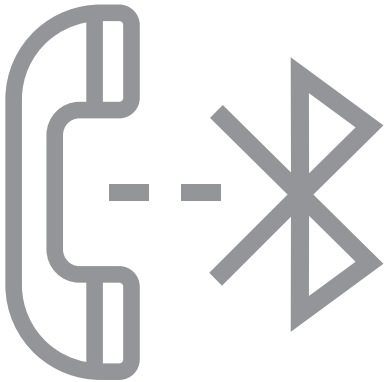

Connecting a Bluetooth device

Making a call via Bluetooth

Accepting an incoming call over Bluetooth

Checking a new message over Bluetooth

# Connecting a Bluetooth device

Bluetooth is a short-range wireless networking technology. The Bluetooth communication function allows you to exchange data by connecting a Bluetooth device to another neighboring Bluetooth device without a cable connection. With this function, you can use different types of devices more efficiently.

To make a phone call or play audio from a Bluetooth device, check the following first:

- For a device that is not registered to the system,  
▶ see “Registering a device.”
- A registered device will automatically connect to the system when you bring it near the system. If it does not automatically connect, ▶ see “Connecting a registered device”, “Disconnecting a registered device.”

## Warning

---

- Driving while distracted can result in a loss of vehicle control that may lead to an accident, severe bodily injury, or death. The driver's primary responsibility is the safe and legal operation of the vehicle, and the use of any vehicle systems, including the touch screen and steering wheel controls, which take the driver's eyes, attention, and focus away from the safe operation of the vehicle, or which are not permissible by law, should never be used during the operation of the vehicle.
- Pull over the vehicle at a safe place before connecting a Bluetooth device to the system. It may take the driver attention off the road and cause a traffic accident which can result in damages, injuries, and/or death.
- ✎ The Bluetooth connection function supports only the hands-free and audio related functions. Connect your mobile phone, MP3 player, or device that supports the hands-free or audio function.
- ✎ For more information on Bluetooth-enabled devices and their functional compatibility, visit the KIA Motors America website (<https://www.kia.com>).



## Registering a device



To connect a Bluetooth device to the system, first add the device to the list of Bluetooth devices on the system.

- 1 On the All Menu screen, touch **Setup ► Device Connections ► Bluetooth ► Bluetooth Connections ► Add New.**

 To register a device for the first time, press the Call button on the steering wheel or by touching **Phone** on the All Menu screen.

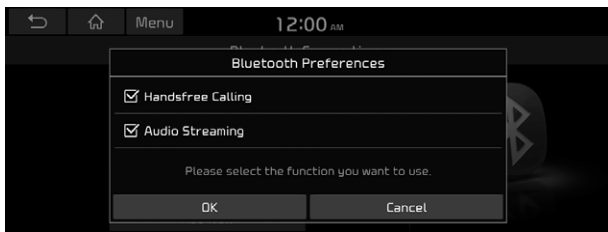
- 2 Select the function to connect.



-  To use your phone on the system via Bluetooth communication, touch **Handsfree Calling**.
-  To listen to music on the system via Bluetooth communication, touch **Audio Streaming**.

- 3 Turn on Bluetooth on the Bluetooth device to connect and select the vehicle system on the list of searched devices.

 The system's Bluetooth name can be seen on the Add New window.

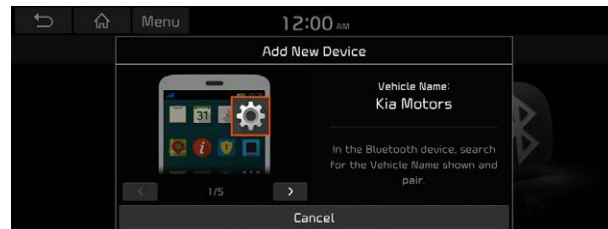

- 4 Check that the authentication code on the Bluetooth device screen matches the one on the system screen and approve the connection on the device.
- 5 When your smartphone is using Bluetooth communication, to download contacts from the phone to the system or use the text message notification, allow access to your phone.

 Access is only required to use Bluetooth calling. There will be no access request when you connect an audio device.

- ✎ After the access request is approved, it may take a while until the Bluetooth connection is completed. As soon as the Bluetooth connection is completed, the Bluetooth connection indicator icon appears at the top of the screen.
- ✎ Access to data can be enabled or disabled by using the Bluetooth Settings menu on the mobile phone. For more details, refer to the mobile phone's user manual.
- ✎ You cannot register another device while operating a Bluetooth device.
- ✎ In order not to use the automatic Bluetooth connection, turn off the Bluetooth function on the device.
- ✎ You can add Bluetooth devices up to 6.

## Connecting a registered device

To use a Bluetooth device, first connect a registered Bluetooth device to the system.

- ✎ You can add one Bluetooth hands-free kit or up to two Bluetooth audio devices.

- 1 On the All Menus screen, touch **Setup ▶ Device Connections ▶ Bluetooth ▶ Bluetooth Connections**.

## 2 Touch the device name or icons to connect.

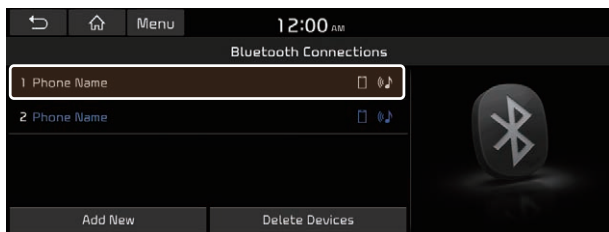

## 3 Select the function to connect and touch **OK**.

- ✎ If you cannot connect your device, check to make sure its Bluetooth option is enabled.
- ✎ When the connection is terminated abnormally due to being out of range or device failures, the connection is automatically restored as soon as the device returns to the connection range or normal state.
- ✎ When the connection is unstable due to a Bluetooth communication error, on the All Menus screen, touch **Setup ► Device Connections ► Bluetooth ► Reset** to initialize the Bluetooth function and connect the device again. ► See "Reset."

## Bluetooth connection screen

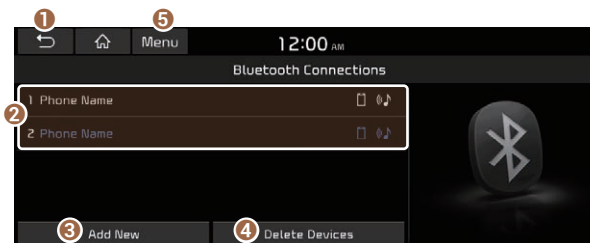

- 1 Returns to the previous step.
- 2 Select hands-free or Bluetooth audio to connect or disconnect Bluetooth devices.
  - ✎ A device list will appear when a Bluetooth device is added to the system.
- 3 Add a new device to the system.
- 4 Delete a registered device from the system.
- 5 The list of menu items appears.
  - **Auto Connection Priority:** Set Bluetooth connection priority for devices to automatically connect them when starting the vehicle (if equipped).
  - **User's Manual on Web (QR Code):** Displays the QR code that provides access to the online user manual for the system.

## Disconnecting a registered device

- 1 On the All Menus screen, touch **Setup ► Device Connections ► Bluetooth ► Bluetooth Connections**.
- 2 Touch the connected device name or icons.
- 3 Touch **Disconnect** in the connection settings window.
  - ✍ To disconnect a function, select the function to disconnect and touch **OK**.

## Deleting a registered device

If you will no longer use a Bluetooth device or you want to add a new device when 6 devices are already registered, delete an existing registered device.

- 1 On the All Menus screen, touch **Setup ► Device Connections ► Bluetooth ► Bluetooth Connections ► Delete Devices**.
- 2 Select a device to delete and touch **Delete**.  
To delete all registered devices, touch **Mark All ► Delete**.
- 3 Touch **Yes**.
  - ✍ When you delete a registered device, all related contacts, call logs, and text messages are removed from the system.

# Making a call via Bluetooth

You can connect a Bluetooth device with the hands-free function to use a Bluetooth phone. The Bluetooth connection allows you to view call details directly from the system screen, and to make calls safely and easily use the system microphone and speaker.

## Warning

- Pull over the vehicle at a safe place before connecting your mobile phone. It may take the driver attention off the road and cause a traffic accident which can result in damages, injuries, and/or death.
- While driving, do not make a call by dialing a phone number or do not pick up your phone to talk. Distraction by the use of a mobile phone may cause you not to recognize traffic flow around and not to cope with unexpected situations. As a result, a traffic accident may occur. If necessary, use the Bluetooth hands-free function and make the call as short as possible.

## Dialing from the recent call list

Make calls directly from call history of your mobile device.

When you connect your mobile device and system over Bluetooth, the list of recent calls from the device will be downloaded to the system and you can call them again by selecting them from the system screen. The system has a built-in microphone and speaker that make using mobile phones safe and easy.

### 1 Perform any of the following methods:

- On the All Menus screen, touch **Phone**.
- On the steering wheel, press the Call button.

### 2 On the Bluetooth Call screen, touch .

### 3 Choose a call from the list.

The system dials the selected number.

-  You can also move to a desired number by using the Move lever/button on the steering wheel without touching on the screen.

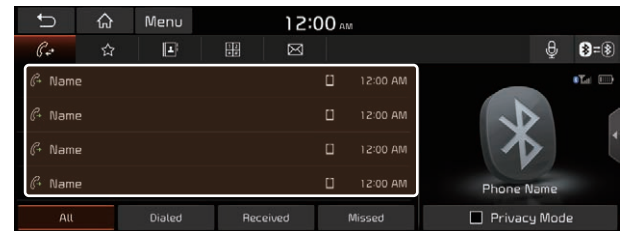

- ✍ The download may not work in some phone models.
- ✍ You can download up to 50 call records for each list.
- ✍ Call durations do not appear on the system screen.
- ✍ You cannot download call records when the download is prohibited by the phone. Some phone models may require approval for a download. When a successful download is not made, check the phone screen or its settings.
- ✍ When call records are newly downloaded, the previous records are removed.
- ✍ Learn more about receiving calls while using a Bluetooth connection. ► See [“Accepting an incoming call over Bluetooth.”](#)

## Recent calls list screen

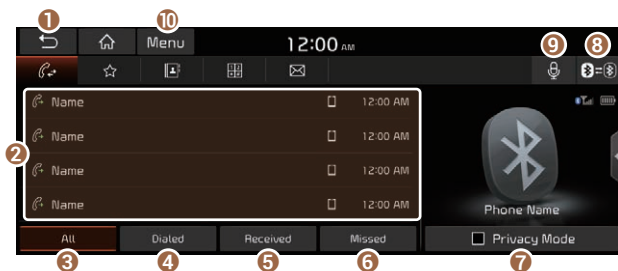



- 1 Returns to the previous step.
- 2 View a list of recent calls downloaded to the system from the device.
- 3 View all recent calls.
- 4 View only dialed calls in the list.
- 5 View only received calls in the list.
- 6 View only missed calls in the list.
- 7 Activate the lock mode to protect personal data. The data downloaded from the mobile phone stays hidden while this mode is on.
- 8 Find and connect other Bluetooth devices.
- 9 Make a phone call using voice recognition. ► See [“Dialing with voice recognition.”](#)
- 10 The list of menu items appears.
  - **Download:** Download the list of recent calls from the connected mobile device.
  - **Privacy Mode:** Activate the lock mode to protect personal data. The data downloaded from the mobile phone stays hidden while this mode is on.
  - **Change Device:** Find and connect other Bluetooth devices.
  - **Bluetooth Settings:** Can change the Bluetooth settings.
  - **User's Manual on Web (QR Code):** Displays the QR code that provides access to the online user manual for the system.
  - **Split Screen:** Can turn on or off the split screen mode.

## Dialing from the favorites list

Make a list of frequently used phone numbers to call them quickly in the future.

When you connect your mobile device and system over Bluetooth, your contacts stored on the device will be downloaded to the system, and you can add frequently used phone numbers to the favorites list. Call your favorite contacts quickly and easily by selecting them from the list.

- 1 Perform any of the following methods:
  - On the All Menus screen, touch **Phone**.
  - On the steering wheel, press the Call button.
- 2 On the Bluetooth Call screen, touch .
- 3 On the favorites screen, touch **Add New** and select a name from the displayed list.
  -  If you already have contacts on your favorites list, touch **Menu ► Edit** on the Favorites screen.
  -  To search for a contact by entering a name or phone number on your contacts list, touch **Menu ► Search**.

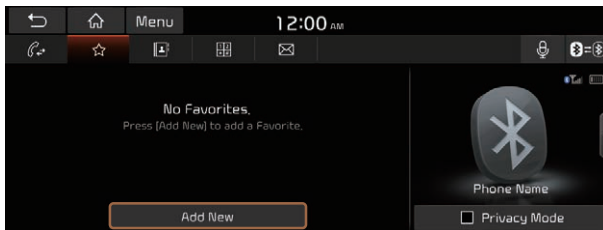



- 4 To set a phone number as a favorite, touch the  button next to it.

The phone number is now added to your favorites list.



- 5 Choose a contact from the list.

The system dials the selected contact.

-  You can add up to 10 favorite contacts for each device.
-  When another mobile phone is connected, the screen does not display the contacts from the previous phone, but they are kept in the system until the phone is deleted from the list.
-  Learn more about receiving calls while using a Bluetooth connection. ► See "Accepting an incoming call over Bluetooth."

## Favorites screen

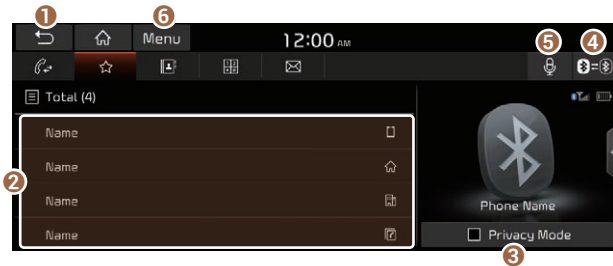

- 1 Returns to the previous step.
- 2 View a list of favorite contacts.
- 3 Activate the lock mode to protect personal data. The data downloaded from the mobile phone stays hidden while this mode is on.
- 4 Find and connect other Bluetooth devices.
- 5 Make a phone call using voice recognition. ► See "Dialing with voice recognition."

- 6 The list of menu items appears.
  - **Add New/Edit:** Add a new contact or edit the favorites list from downloaded contacts.
  - **Delete:** Delete a contact from the favorites list.
  - **Privacy Mode:** Activate the lock mode to protect personal data. The data downloaded from the mobile phone stays hidden while this mode is on.
  - **Change Device:** Find and connect other Bluetooth devices.
  - **Bluetooth Settings:** Can change the Bluetooth settings.
  - **User's Manual on Web (QR Code):** Displays the QR code that provides access to the online user manual for the system.
  - **Split Screen:** Can turn on or off the split screen mode.



## Dialing from the contacts

You can use contacts from the connected mobile device on the system.

When you connect your mobile device with the system via Bluetooth, contacts from the device are downloaded to the system, and you can choose to call them from the system screen. The system has a built-in microphone and speaker that make using mobile phones safe and easy.

### 1 Perform any of the following methods:

- On the All Menus screen, touch **Phone**.
- On the steering wheel, press the Call button.

### 2 On the Bluetooth Call screen, touch .

### 3 Select a contact from the list.

The system dials the selected contact.

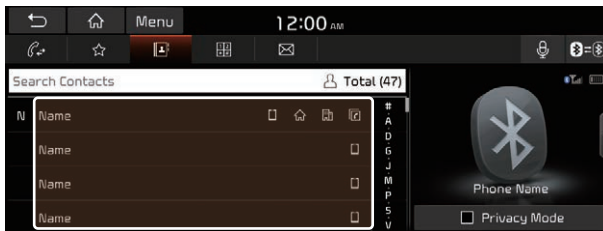

- ✎ You can download only the contacts that can be displayed on the connected Bluetooth device. The contacts may not appear in some applications.
- ✎ You can download up to 5,000 contacts for each device.
- ✎ The download may not work in some phone models.
- ✎ Contacts from both the mobile device and its SIM card are downloaded at the same time. The system may not be able to download SIM card contacts from all phone models.
- ✎ When speed dial numbers are set to contacts on the phone, press and hold a speed dial number on the dial pad to make a call easily. Some mobile phone models may not support the speed dial function.
- ✎ You cannot download contacts when the download is prohibited by the phone. Some phone models may require approval for a download. When a successful download is not made, check the phone screen or its settings.
- ✎ Depending on the phone model or operation status, downloading may take longer than usual.
- ✎ When a new contacts list is downloaded, the previous records are removed.
- ✎ The downloaded contacts cannot be edited or deleted from the system.

- ✎ When another mobile phone is connected, the screen does not display the contacts downloaded from the previous phone, but they are kept in the system until the phone is deleted from the list.
- ✎ Learn more about receiving calls while using a Bluetooth connection. ▶ See “Accepting an incoming call over Bluetooth.”

## Contacts list screen



- 1 Returns to the previous step.
- 2 Enter a contact's name or phone number to search the list. You can also search for a contact by touching  and saying the contact's name or phone number.
- 3 View a list of contacts downloaded to the system from the device.
- 4 Use the index to quickly find the contact you are looking for.
- 5 Activate the lock mode to protect personal data. The data downloaded from the mobile phone stays hidden while this mode is on.

- 6 Find and connect other Bluetooth devices.
- 7 Make a phone call using voice recognition. ▶ See “Dialing with voice recognition.”
- 8 The list of menu items appears.
  - **Download:** Download the list of contacts from the connected mobile device.
  - **Search:** Search contacts by entering a name or a phone number.
  - **Privacy Mode:** Activate the lock mode to protect personal data. The data downloaded from the mobile phone stays hidden while this mode is on.
  - **Change Device:** Find and connect other Bluetooth devices.
  - **Bluetooth Settings:** Can change the Bluetooth settings.
  - **User's Manual on Web (QR Code):** Displays the QR code that provides access to the online user manual for the system.
  - **Split Screen:** Can turn on or off the split screen mode.

## Using the dial pad

Enter a phone number using the dial pad to make a call.

When you connect your mobile device to the system via Bluetooth, you can enter and dial a phone number from the system screen, without interacting with the device. The system has a built-in microphone and speaker that make using mobile phones safe and easy.

### Warning

Do not manually dial a call while driving. Distraction by the use of a mobile phone may cause you not to recognize traffic flow around and not to cope with unexpected situations. As a result, a traffic accident may occur.

#### 1 Perform any of the following methods:

- On the All Menus screen, touch **Phone**.
- On the steering wheel, press the Call button.

#### 2 On the Bluetooth Call screen, touch .

#### 3 After entering a phone number, touch .

A call is connected to the entered phone number.

- ✎ When contacts are on the system, search for the desired contact by entering the initial letters or number on the dial pad. (e.g. John Doe ► JD).



- ✎ Learn more about receiving calls while using Bluetooth connection. ► See ["Accepting an incoming call over Bluetooth."](#)

## Dial pad screen

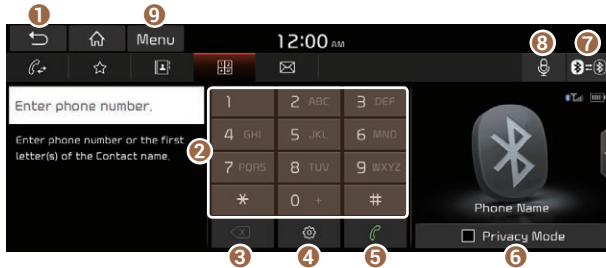

- 1 Returns to the previous step.
- 2 Use the dial pad to enter phone numbers.
- 3 Delete an entered number.
- 4 Can configure the Bluetooth connection settings.
- 5 Touch to dial the number you entered.
  - ✍ If you have recent calls stored on your system, you can use the following feature before entering a phone number.
    - Touching this button will display the most recently dialed numbers in the field.
    - Touch and hold this button to automatically call the most recently dialed number.
- 6 Activate the lock mode to protect personal data. The data downloaded from the mobile phone stays hidden while this mode is on.

- 7 Find and connect other Bluetooth devices.
- 8 Make a phone call using voice recognition. ▶ See "Dialing with voice recognition."
- 9 The list of menu items appears.
  - **Privacy Mode:** Activate the lock mode to protect personal data. The data downloaded from the mobile phone stays hidden while this mode is on.
  - **Change Device:** Find and connect other Bluetooth devices.
  - **Bluetooth Settings:** Can change the Bluetooth settings.
  - **User's Manual on Web (QR Code):** Displays the QR code that provides access to the online user manual for the system.
  - **Split Screen:** Can turn on or off the split screen mode.

## Dialing with voice recognition

When you connect your mobile device to the system via Bluetooth, contacts from the device are downloaded to the system, and you can choose to call them using voice recognition.

 To call using voice recognition, there must be contacts stored on the system.



### 1 Perform any of the following methods:

- On the All Menus screen, touch **Phone**.
- On the steering wheel, press the Call button.

### 2 On the Bluetooth Call screen, touch .

### 3 When a guiding beep is heard, say the name of the contact to make a phone call.

The system dials the selected contact.

 In case of the dial pad screen, touch  say the phone number to make a call.

## Accepting an incoming call over Bluetooth

The system screen alerts you when you receive a call while connected using Bluetooth.

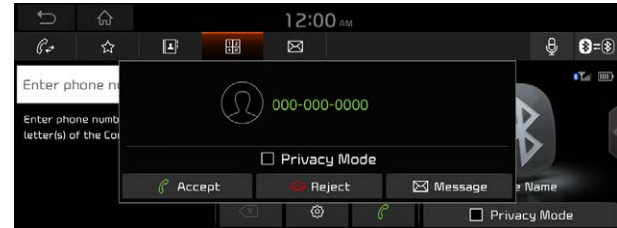

### Perform any of the following methods:

- Touch **Accept** on the screen.
- On the steering wheel, press the Call button.



## Warning

- Pull over the vehicle at a safe place before connecting your mobile phone. It may take the driver attention off the road and cause a traffic accident which can result in damages, injuries, and/or death.
- Do not talk on your mobile device while driving. Distraction by the use of a mobile phone may cause you not to recognize traffic flow around and not to cope with unexpected situations. As a result, a traffic accident may occur. If necessary, use the Bluetooth hands-free function and make the call as short as possible.

 When a mobile phone is connected to the system, the vehicle's speaker may be used to output a call tone even after you leave the vehicle. To disconnect the call, disable the Bluetooth connection on the system or turn off the Bluetooth function on the mobile phone.

## Rejecting a call

Perform any of the following methods:

- Touch **Reject** on the screen.
- On the steering wheel, press the End Call button.
-  To reject by sending a call-reject message, touch **Message**. From the list, select the call-reject message and touch **Send**.
-  The call-reject or auto-reply message may not be supported in some phone models.

## Using functions during a call

During a call, the following screen appears.

Touch to use the available options.

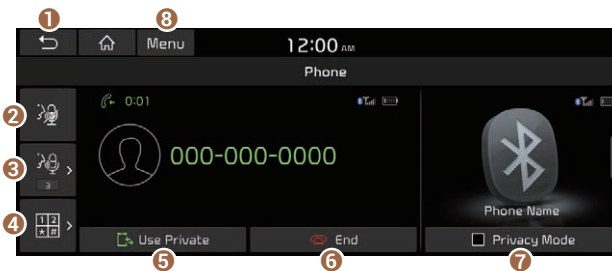

- 1 Returns to the previous step.
- 2 Can turn off the microphone so that the other party cannot hear you.
- 3 Can adjust the microphone volume.
- 4 Displays or hides the dial pad screen.
- 5 Used to switch the call to the mobile phone. This option may not be available in some phone models.
- 6 Used to end a call.
- 7 Activate the lock mode to protect personal data. The data downloaded from the mobile phone stays hidden while this mode is on.

- 8 The list of menu items appears.
- **Privacy Mode:** Activate the lock mode to protect personal data. The data downloaded from the mobile phone stays hidden while this mode is on (if equipped).
  - **Split Screen:** Can turn on or off the split screen mode.
- ✍ If you set the microphone volume too high, the other party may have a difficulty understanding you due to noise or echoing, depending on their mobile phone and surroundings. Setting the volume to 30 or lower is recommended.
- ✍ When the caller is in the contact list, the caller's name and phone number of the caller are displayed. Otherwise, only the phone number appears.
- ✍ During a call with a Bluetooth connection, you cannot switch to another screen such as Radio/Media mode.
- ✍ Depending on the phone model, the call volume of the other party may differ.
- ✍ Depending on the phone model, the telephone number may not appear.

## Switching to another call

You can receive another incoming call while in a call. This option is available only when the connected mobile phone supports the call hold function. The original call is put on hold.

To switch between two calls, use either option.

- Touch **Switch**.
- Touch a displayed phone number.

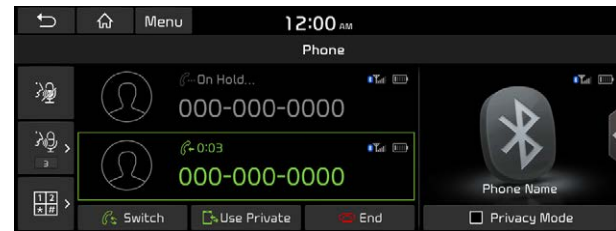

✍ This option may not be available in some phone models.

## Checking a new message over Bluetooth

After connecting a mobile phone via Bluetooth, you can check the received messages through the system screen and listen to voice messages converted from the text messages. This option is available when a mobile phone is connected via Bluetooth. You can also send the brief reply message registered in the system.

## Checking a new message

When a message is received, the new message notification window appears.

To check the message, touch **View**.

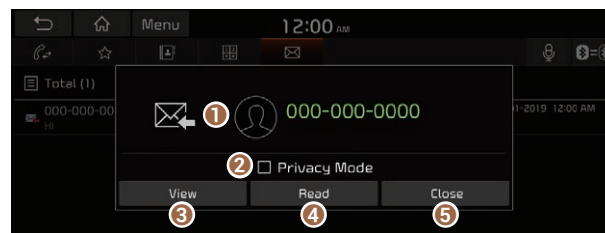

- 1 View caller details.
  - 2 Activate the lock mode to protect personal data. The data downloaded from the mobile phone stays hidden while this mode is on.
  - 3 Can see the message details.
  - 4 Reads out the message through the speakers in the vehicle.
  - 5 Used to close the notification window.
-  The message notification window does not appear when the privacy mode is enabled or the message notification is turned off.



## Bluetooth message screen

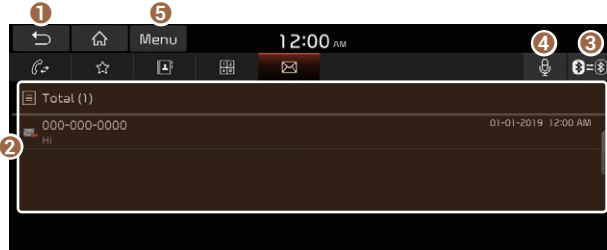

- 1 Returns to the previous step.
- 2 View the list of received messages.
- 3 Find and connect other Bluetooth devices.
- 4 Can text a message by using the voice recognition.  
▶ See "Sending a text by using the voice recognition."
- 5 The list of menu items appears.
  - **Message Settings:** Displays the message settings screen (if equipped).
  - **Privacy Mode:** Activate the lock mode to protect personal data. The data downloaded from the mobile phone stays hidden while this mode is on.
  - **Change Device:** Find and connect other Bluetooth devices.
  - **Bluetooth Settings:** Can change the Bluetooth settings.
  - **User's Manual on Web (QR Code):** Displays the QR code that provides access to the online user manual for the system.
  - **Split Screen:** Can turn on or off the split screen mode.

## Checking a new message from the list

- 1 Perform any of the following methods:
  - On the All Menus screen, touch **Phone**.
  - On the steering wheel, press the Call button.
- 2 On the Bluetooth Call screen, touch .
- 3 Select a message from the list.
- 4 Check the message.

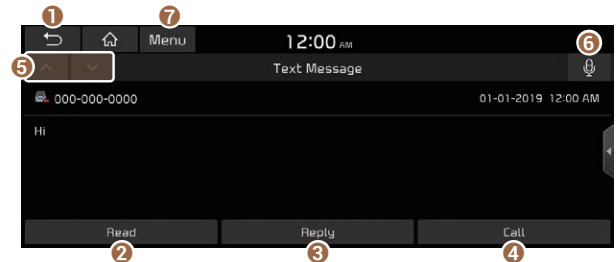

- 1 Returns to the previous step.
- 2 Reads out the message through the speakers in the vehicle.
- 3 Used to select a message registered in the system for sending a brief reply message.
- 4 Used to make a call to a message sender.
- 5 Used to move to the previous or next message.

6 Can text a message by using the voice recognition.

▶ See "Sending a text by using the voice recognition."

7 The list of menu items appears.

- **Message Settings:** Displays the message settings screen (if equipped).
- **Bluetooth Settings:** Can change the Bluetooth settings (if equipped).
- **Split Screen:** Can turn on or off the split screen mode.

✍ The auto-reply messaging may not be available depending on the smartphone model.

✍ To edit or delete a message, pull over the vehicle at a safe place and access the messaging function on your smartphone. You cannot edit or delete a message from the system.

✍ When an iPhone is connected to the system, there are some restrictions when receiving messages as follows:

- Only the sender name appears when the sender information is saved.
- When the sender information is not saved, only the phone number appears.
- You cannot use the auto-reply message function.
- When the incoming message notification or lock-screen view option is off, messages cannot be received.

✍ The message reader function may not be supported depending on the system language.

## Sending a text by using the voice recognition

When you connect your mobile device to the system via Bluetooth, contacts from the device are downloaded to the system so you can text a message to a contact by using the voice recognition.

✍ To call using voice recognition, there must be contacts stored on the system.

✍ It is available only when the UVO service is active.

1 Perform any of the following methods:

- On the All Menus screen, touch **Phone**.
- On the steering wheel, press the Call button.

2 On the bluetooth message screen, touch .

3 When a guiding beep is heard, say the message.

The system sends the text to the selected contact.

# 07

## Voice functions



Voice recognition  
Using the Siri Eyes Free  
Voice Memo

# Voice recognition

With the voice recognition function, you can access various functions of the infotainment system without manipulating the screen or buttons. This function prevents driver distraction and dangerous situations.

Use voice commands to access various functions easily.

✍ The system can recognize the specified voice commands.  
▶ See “Available voice commands” or the voice recognition help.

✍ Note the following for accurate delivery of command when saying it.

- Pronounce a command accurately and naturally like a conversation.
- Keep the correct posture and say commands toward the direction of the microphone.

✍ Voice recognition is automatically ended when:

- You make or receive a call.
- A media source is connected or disconnected.
- The front or rear cameras operate (if equipped).
- The [RADIO] or [MEDIA] button is pressed to perform another function.
- Rerouting or other unexpected action is made due to deviation from the route during guidance.

✍ Voice recognition may not work properly when:

- The sunroof or windows are open so the wind is strong.
- The fan speed of the air conditioner or heater is high (level 3 or below is recommended).
- The vehicle is passing through a tunnel.
- The vehicle is driving on an unpaved road and its noise and vibration are loud.
- Noise is loud due to a heavy rain or storm.

## Using the voice recognition

### 1 On the steering wheel, press the Voice Recognition button.

Voice recognition starts along with voice guidance.

✍ To skip the voice guidance, press the Voice Recognition button on the steering wheel.

### 2 When a beep sound is heard, say a command to perform (e.g. navigation, music, call). ▶ See “Available voice commands” or the voice recognition help.

The recognized command appears in text at the top of the screen and the corresponding function is performed.

✍ When an additional command is required to perform, the commands that can be followed in the next step appear on the screen. Say a command or touch a command.

✍ When there are several similar commands, say a command number to perform.

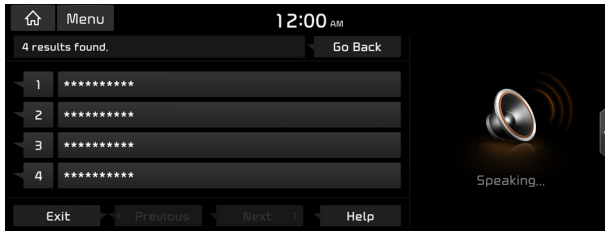

### 3 To end the voice recognition, perform one of the following methods:

- In standby mode for voice recognition, say "Exit"
  - On the voice recognition screen, touch **Exit**.
  - On the steering wheel, press and hold the Voice Recognition button.
- ✍ When the Voice Recognition button is pressed in standby mode for voice recognition, the standby time is extended.
- ✍ When the voice recognition is not available, press the Voice Recognition button on the steering wheel and use the voice recognition on your smartphone via phone projection. ► See "Using the phone projection function."

## Voice recognition screen

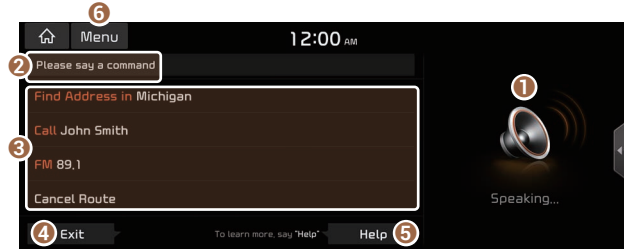

- 1 According to voice recognition, the icons for voice recognition, voice guidance, and command process appear.
- 2 The recognized voice command appears in text.
- 3 Shows the representative voice command.
- 4 Ends the voice recognition.
- 5 Displays the voice recognition help.
- 6 The list of menu items appears.
  - **Split Screen:** Can turn on or off the split screen mode.

## Adjusting the voice guidance volume

Adjust the voice guidance volume when the system volume is so low or high and it interferes with your driving.

When the voice recognition is active, turn the Volume knob on the control panel.

## Seeing the voice recognition help

You can see more details on how to perform various functions by voice commands.

### Caution

Pull over the vehicle at a safe place and see the help.

- 1 On the steering wheel, press the Voice Recognition button.
- 2 Say "Help"

 When the mode time exceeds before you speak, you can touch **Help** instead.

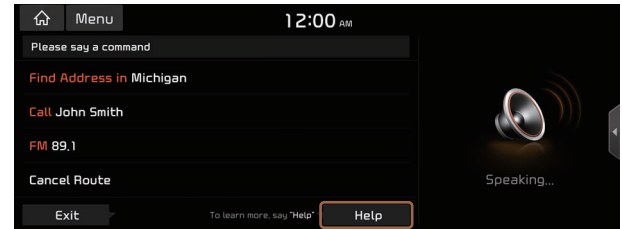

### 3 Select the desired option and see its help.

- To see the entire help for use of voice commands, touch  at the bottom of the screen.

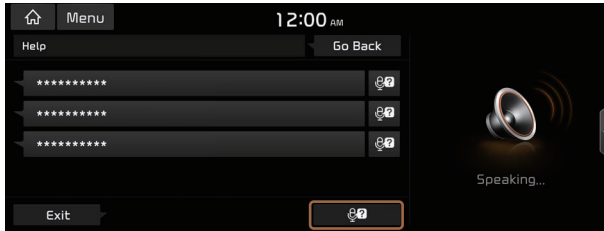

- To see more details on how to use voice commands for each function, touch  next to the function name.

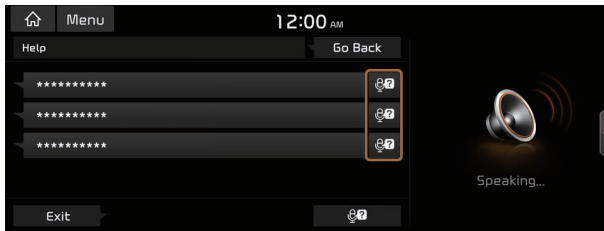

### 4 After seeing the help, perform any of the following methods.

- On the help screen, touch **Exit**.
- In standby mode for voice recognition, say "Exit"

## Voice recognition Help



- 1 Returns to the previous step.
- 2 The function list appears.
  -  To see the list of voice commands that can be used for each function, touch or say the function.
- 3 You can see the usages for each function.
- 4 Ends the voice recognition.
- 5 You can see the entire help for use of voice commands.
- 6 According to voice recognition, the icons for voice recognition, voice guidance, and command process appear.
- 7 The list of menu items appears.
  - **Split Screen:** Can turn on or off the split screen mode.

## Available voice commands

### Call commands

Command	Function
Call	You can make a call to one of your mobile phone's contacts. Say a contact's name to begin a call.
Call <Name>	The system dials the phone number of that contact. If the contact has multiple phone numbers, select a phone number.
Call <Name> on Mobile	The system dials the phone number saved as "Mobile" for that contact.
Call <Name> at Work	The system dials the phone number saved as "Work" for that contact.
Call <Name> at Home	The system dials the phone number saved as "Home" for that contact.

Command	Function
Call <Name> on Other	The system dials a phone number saved as other than "Mobile", "Work", or "Home" for that contact.
Dial Number	You can make a call. Say a phone number to begin a call.
Dial <Phone #>	You can make a call immediately to that phone number.
Send Message	<p>You can send a text message to one of your mobile phone's contacts. Say a contact's name and then enter the message content by following the guidance.</p> <p>This command is available only if UVO is activated.</p>
Send Message to <Name>	<p>You can send a text message to that specific contact. Enter the message content by following the guidance.</p> <p>This command is available only if UVO is activated.</p>



Command	Function
Send Message to <Name> <Message>	You can send a text message to that contact more directly.  This command is available only if UVO is activated.
Change Bluetooth Device	You can search for and connect another Bluetooth device.

 To use call commands, your mobile phone must be connected to the system via Bluetooth and your contacts must be downloaded. ► See ["Connecting a Bluetooth device."](#)

## Navigation commands

Command	Function
Find <POI or Address>	You can search for a designated POI name or address.  For example, say "Find Kia dealerships" or "Find Kia dealerships in Seattle."
Find Address in <State>	You can search for a location with its address in a designated state. Say an address in order of the house number, street, and city.
Find <POI>	You can search for a designated category of POIs nearby. ► See <a href="#">"POI names."</a>
Frequently Visited Points	You can select a location from the list of your frequently visited points. Say the number of the location you want.
Address Book	Access the address book screen.

<b>Command</b>	<b>Function</b>
Previous Points	You can select a location from the list of your previous destinations, frequently visited points, and starting points. Say the number of the location you want.
Previous Destinations	You can select a location from the list of your previous destinations. Say the number of the location you want.
Previous Starting Points	You can select a location from the list of your previous starting points. Say the number of the location you want.
Traffic Information	Access the traffic information screen.
Go Home	Set the location saved to the Go Home shortcut button in your address book as your destination.
Go to Work	Set the location saved to the Work shortcut button in your address book as your destination.
Change Home	You can change the location saved as your home.

<b>Command</b>	<b>Function</b>
Change Work	You can change the location saved as your work.
Pause Route	Pause the navigation guidance.
Resume Route	Resume the navigation guidance.
Turn Guidance On	Unmute the navigation guidance.
Turn Guidance Off	Mute the navigation guidance.
Zoom In	Zoom in on the map.
Zoom Out	Zoom out from the map.
Cancel Route	Stop the navigation guidance and cancel your current destination.
Destination Information	View information on the distance and time to your current destination.
Route Options	Find another route.

Command	Function
Emergency Services	You can select a location from the list of nearby police stations, hospitals, dealerships, and roadside assistance services. Say the number of the location you want.
Police Stations	You can select a location from the list of nearby police stations. Say the number of the location you want.
Hospitals	You can select a location from the list of nearby hospitals. Say the number of the location you want.
Dealerships	You can select a location from the list of nearby motor dealerships. Say the number of the location you want.
Roadside Assistance	You can select a location from the list of nearby roadside assistance services. Say the number of the location you want.
Show Route	View the entire route on the map.

- ✎ When you use a command starting with "Find," the system searches for locations within the state or province where your vehicle is currently located. To search for locations in another state or province, say the state or province name first and then say the location you want.
- ✎ Some commands, such as "Cancel Route" or "Show Route," are available only when a destination is set.
- ✎ When **Use UVO Network** is selected in the **Setup ► Voice Recognition ► Use Network** menu, a UVO subscription is required to use voice commands for finding POIs or addresses. If you do not have a UVO subscription or do not want to use server-based voice recognition, deactivate the option.

## Radio commands

Command	Function
FM <87.5 to 107.9>	Turn on the FM radio with that frequency.
AM <530 to 1710>	Turn on the AM radio with that frequency.
SiriusXM <0 to 999>	Turn on the SiriusXM radio with that channel number.

## Other commands

Command	Function
Help	Move to the help screen.
Line <1 to 4>*	Select an item with the designated number on a list. Simple numbers, such as "One" or "Two," can be recognized.
Yes*	Accept a notification asking for your confirmation in an exceptional situation.

Command	Function
No*	Deny a notification asking for your confirmation in an exceptional situation.
Next*	If there are more than five items on a list, scroll to the next page.
Previous*	If you scroll to the next page of a list, scroll back to the previous page.
Manual Input*	When using the Dial Number command, open the keypad to enter a phone number manually.
Go Back*	Returns to the previous step.
Exit	End voice recognition.

\* These commands are available only in certain situations.

## POI names

### Restaurants

#### POI name

##### Fast Food Restaurants

Arby's

Boston Market

BURGER KING

Carl's Jr

Chick-fil-A

Chipotle

Church's Chicken

Dairy Queen

Firehouse Subs

Hardee's

IHOP

In-N-Out Burger

Jack in the Box

Jimmy John's

KFC

Little Caesars

#### POI name

Long John Silver's

McAlister's Deli

McDonald's

Panda Express

Panera Bread

Popeyes

Quiznos Sub

Schlotzsky's

SONIC

SUBWAY

Taco Bell

Taco John's

Waffle House

Wendy's

White Castle

Blimpie

Checkers

Culver's

Five Guys Burgers and Fries

Jamba Juice

Jersey Mike's Subs

#### POI name

Smoothie King

Steak n Shake

Whataburger

##### Coffee Shops

Starbucks

Dunkin' Donuts

Tim Hortons

##### American Restaurants

Applebee's

Bahama Breeze

Boston's Restaurant &  
Sports Bar

Cheeseburger in Paradise

Chili's Grill & Bar

Cool River

Denny's

Frisch's Big Boy

Good Eats

III Forks

Lee Roy Selmon's

#### POI name

Lone Star Steakhouse &  
Saloon

Longhorn Steakhouse

Luckys Cafe

Outback Steakhouse

Ponderosa

Publix

Seasons 52

Sheetz

Silver Fox

Texas Roadhouse

TGI Friday's

The Capital Grille

A&W

Bob Evans

Buffalo Wild Wings

Cracker Barrel Old Country  
Store

Golden Corral

Red Robin

Ruby Tuesday

<b>POI name</b>	<b>POI name</b>
Wingstop	El Chico
Fleming's	Del Taco
<b>Italian Restaurants</b>	Moe's Southwest Grill
Bonefish Grill	Qdoba
Carrabba's Italian Grill	Toks
Chuck E Cheese's	<b>Asian Restaurants</b>
Domino's	<b>Chinese Restaurants</b>
Olive Garden	PF Chang's China Bistro
Papa John's	<b>Japanese Restaurants</b>
Papa Murphy's	<b>Korean Restaurants</b>
Pizza 73	<b>Seafood Restaurants</b>
Pizza Hut	Red Lobster
pizza pizza	Captain D's
Cici's Pizza	<b>Vegetarian Restaurants</b>
Godfather's	<b>French Restaurants</b>
Hungry Howie's Pizza	<b>Continental Restaurants</b>
Marco's Pizza	<b>African Restaurants</b>
<b>Latin American Restaurants</b>	<b>Other Restaurants</b>
<b>Mexican Restaurants</b>	Auntie Anne's
Cantina Laredo	Baskin-Robbins
Chevy's	Haagen-Dazs

<b>POI name</b>	<b>POI name</b>
Hooters	CITGO
Roy's	Conoco
TCBY	Esso
VAN DER VALK	Exxon
Bojangles'	Fleetfuels
Cold Stone Creamery	GetGo
Zaxby's	Giant Gasoline

## **Automotive**

<b>POI name</b>	<b>POI name</b>
<b>KIA Dealerships</b>	Ingles Gas Express
<b>Gas Stations</b>	Marathon
76	Martin's Gasoline
ampm	Meijer Gas Station
ARCO	Mobil
BP	Murphy Express
Gas+	Murphy USA
Casey's General Store	Petro Stopping Centers
Cenex	PETRO-CANADA
Chevron	Phillips 66
	Pioneer

<b>POI name</b>	<b>POI name</b>
QuikTrip	AutoZone
Rutter's	BOSCH Car Service
Sheetz	Canadian Tire
Shell	Certigard
Sinclair	Chevron
Speedway	CITGO
Sunoco	Discount Tire
Sunoco Canada	Exxon
TEXACO	Firestone
TravelCenters of America	GOODYEAR
Ultramar	Gulf
Valero	Jiffy Lube
Wawa	Kal Tire
Hess Express	Midas
Irving	Mobil
Pemex	Napa
<b>Parking</b>	O'Reilly Auto Parts
<b>Auto Services</b>	PETRO-CANADA
AAA	Sears Auto Center
Advance Auto Parts	Shell
America's Tire	TEXACO

<b>POI name</b>	<b>POI name</b>
AAMCO Transmissions	CITGO
ACDelco	Costco
Big O Tires	Exxon
CARQUEST	Flying J
Meineke Car Care Center	Fred Meyer Fuel Center
Monro Muffler Brake & Service	Fry's Fuel Center
Napa Autocare Center	Fry's Marketplace Fuel Center
Pep Boys	Kroger Fuel Center
Quick Lane	Kum & Go
Safelite AutoGlass	Kwik Trip
Tires Plus	Meijer Gas Station
Valvoline Instant Oil Change	Murphy Express
<b>Roadside Assistance</b>	NISSAN
<b>Auto Parts</b>	QuikTrip
<b>Car Washes</b>	Shell
<b>Automobile Dealerships</b>	TEXACO
<b>Motorcycle Dealerships</b>	Valero
<b>EV Charging Stations</b>	<b>Hydrogen Stations</b>
Aloha	
Chevron	

## Travel

<b>POI name</b>	<b>POI name</b>
	Days Inn
	DELTA
Airports	Doubletree
Hotels	Econo Lodge
Americas Best Value Inn	Embassy Suites
AmericInn	Grand Residences by Marriott
Andaz	Hampton Inn
Ascend Collection	Hawthorn Suites
Baymont Inn & Suites	Hilton
Best Western	Hilton Garden Inn
Cambria Suites	Hilton Grand Vacations
Canadas Best Value Inn	Holiday Inn
Candlewood Suites	Holiday Inn Express Hotel & Suites
Clarion Hotel	Homewood Suites
Comfort INN	Hotel Indigo
Comfort Suites	Howard Johnson
CONRAD	Hyatt Place
Country Inn & Suites by Carlson	Hyatt
COURTYARD by Marriott	Hyatt Summerfield Suites
Crowne Plaza	

<b>POI name</b>	<b>POI name</b>
Intercontinental	Ritz-Carlton
JW Marriott	Rodeway Inn
La Quinta Inn & Suites	Sheraton
Lexington	Sleep Inn
Mainstay Suites	SOFITEL
Marriott	Staybridge Suites
Marriott VACATION CLUB	Studio 6
Microtel Inns & Suites	Suburban Extended Stay
Motel 6	Super 8
NOVOTEL	Thriftlodge Canada
Omni Hotels	Travelodge
Park Inn	Travelodge Canada
Park Plaza	VAN DER VALK
QUALITY INN	WALDORF ASTORIA COLLECTION
Radisson	Wingate by Wyndham
Radisson SAS	Wyndham
RAMADA	Extended Stay America
Red Roof Inn	Fairfield Inn by Marriott
Regent Hotels & Resorts	<b>Rental Car Agencies</b>
Renaissance	Alamo
Residence Inn	



POI name	Shopping
AVIS	
Budget	
Dollar Rent A Car	
Enterprise	
Hertz	
National	
Thrifty	
Tourist Information	
Tourist Attractions	
Travel Agents	
Rest Areas	
City Centers	
Campgrounds	
Ferry Terminals	
Bus Stations	
Local Transit	
Train Stations	
	POI name
	Department Stores
	Canadian Tire
	Dollar General
	Dollar Tree
	Family Dollar
	JCPenney
	Kmart
	Kohl's
	Nordstrom
	Sears
	Sears Hometown Store
	Target
	T.J. Maxx
	Walmart
	Big Lots
	Macy's
	Marshalls
	Ross Dress For Less

POI name	POI name
Convenience Stores	Mac's
7-Eleven	Mini Mart
ampm	Quick Stop
BP	Valero Corner Store
Circle K	Shopping Centers
Fleetfuels	Grocery Stores
GetGo	Giant Eagle
GTO	Giant Food Stores
Kangaroo Express	IGA
Murphy Express	Ingles Markets
Murphy USA	Food Lion
Petro Stopping Centers	Kmart
QuikTrip	Kroger
Rutter's	Martin's Food Markets
Sunoco Canada	Meijer
TravelCenters of America	Publix
Wawa	Sav-Mor Foods
Cumberland Farms	Save-A-Lot
Hess Express	SuperValu

<b>POI name</b>	<b>POI name</b>
Albertsons	Sam's Club
ALDI	<b>Electronics Stores</b>
Piggly Wiggly	AT&T
Safeway	Best Buy
Winn-Dixie	GameStop
<b>Pharmacies</b>	Radioshack
CVS/pharmacy	Sprint
Giant Drugstore	Staples
Giant Eagle	T-Mobile
Ingles Pharmacy	OfficeMax
Kmart Pharmacy	US Cellular
Kroger Pharmacy	Verizon
Martin's Drugstore	Boost Mobile
Meijer Pharmacy	Cricket Wireless
Publix	metroPCS
Rite Aid	<b>Home Specialty Stores</b>
Shoppers Drug Mart	ABC Fine Wine & Spirits
Walgreens	Ace Hardware
Medicine Shoppe	Claire's
Safeway	Costco

<b>POI name</b>	<b>POI name</b>
Home Depot	Sam's Club
Lowe's	SEPHORA
Merle Norman	Sleepy's
PETCO	Sunglass Hut
PETSMART	Toys"R"Us
Sally Beauty Supply	Tuesday Morning
SHERWIN-WILLIAMS	<b>Sporting Goods Stores</b>
True Value	Dick's Sporting Goods
Bath & Body Works	Sports Authority
BED BATH & BEYOND	HIBBETT SPORTS
Carpet One	<b>Music Stores</b>
Do It Best	<b>Bookstores</b>
Family Video	Barnes & Noble Booksellers
GNC	<b>Gift Shops</b>
HOBBY LOBBY	<b>Clothing Shops</b>
Home Hardware	Mark's
Jo-Ann	Aeropostale
Michaels	American Eagle Outfitters
Party City	Cato
Pier 1 Imports	Chico's

<b>POI name</b>
Children's Place
Dressbarn
Famous Footwear
Finish Line
Foot Locker
GAP
Gymboree
Hot Topic
Journeys
Justice
Lane Bryant
Men's Wearhouse
Old Navy
PacSun
Rainbowshops
rue21
Victoria's Secret
<b>Shoe Stores</b>
Payless Shoesource
<b>General Merchandise</b>

## Recreation

<b>POI name</b>
Amusement Parks
Museums
Cinemas
Golf Courses
Sports Complexes
Sports Activities
Wineries
Video & Game Rental
Ski Resorts
Recreation Areas
<b>Other Recreation Areas</b>

## Financial Services

<b>POI name</b>
<b>Banks</b>
Bank of America
BB&T
Chase
Citibank
Citizens Bank
Fifth Third Bank
KeyBank
PNC Bank
RBC Royal Bank
<b>Regions</b>
SunTrust
TD Bank
TD Canada Trust
US Bank
Wells Fargo
Bank of the West
BBVA Compass
BMO Bank of Montreal
BMO Harris Bank

<b>POI name</b>
Caisse Populaire Desjardins
Capital One
CIBC
First Citizens Bank
First National Bank
M&T Bank
Santander
Scotiabank
The Huntington National Bank
Woodforest National Bank
<b>ATMs</b>
Bank of America
BB&T
Chase
Citibank
Citizens Bank
Fifth Third Bank
KeyBank
PNC Bank
RBC Royal Bank
Regions

<b>POI name</b>
SunTrust
TD Bank
TD Canada Trust
US Bank
Wells Fargo
Bank of the West
BMO Bank of Montreal
BMO Harris Bank
Caisse Populaire Desjardins
Capital One
CIBC
Commerce Bank
First National Bank
HSBC
M&T Bank
Santander
Scotiabank
State Employees' Credit Union
Check Cashing Services
Money Transfer

## Community

<b>POI name</b>
Police Stations
Post Offices
Libraries
Schools
Fire Departments
Convention Centers
Churches
Synagogues
City Halls
Civic Centers
Court Houses
Government Offices
Waste & Sanitary Services
Utilities
Business Facilities

## Services

<b>POI name</b>
Hospitals
Medical Services
Physicians
Tax Services
Attorneys
Funeral Homes
Hair & Beauty Services
Cleaning & Laundry Services
Social Services
Communication
Dentists
Photography Services
Tailors & Alterations
Movers

<b>POI name</b>
Nursing Homes
Optical Services
Personal Services
Repair Services
Veterinary Hospitals
Shipping Centers

 Available POI names may change when the system is updated.

# Using the Siri Eyes Free

When you connect an Apple device that is compatible with Siri to your system via Bluetooth, you can use the Siri Eyes Free. This allows you to perform the functions on your system and Apple device with voice commands so that you can devote your attention to driving.

First, make sure that your Apple device supports Siri and that you have activated Siri.

- 1 Connect your Apple device to your system via Bluetooth.
- 2 On the steering wheel, press and hold the Voice Recognition button.
- 3 On the Siri screen, touch **Speak**.

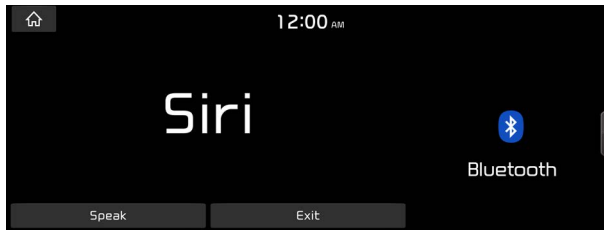

## 4 Say a command.

- ✎ You can perform the functions related to Bluetooth calls on the system and other functions on your Apple device.
- ✎ Press the Voice Recognition button to restart Siri.

## 5 To end Siri, press and hold the Voice Recognition button on the steering wheel.

Siri Eyes Free is enabled only while driving. When you shift to “P” (Park) or apply the parking brake, you can disable this function.

- ✎ Apple devices may have different functions enabled and may vary in the way how they respond to Siri commands, depending on the device type and iOS version.

# Voice Memo

You can use the microphone on the vehicle to record and play voice memos.

## Using the voice memos

On the All Menus screen, touch **Voice Memo**.

### Voice memo screen

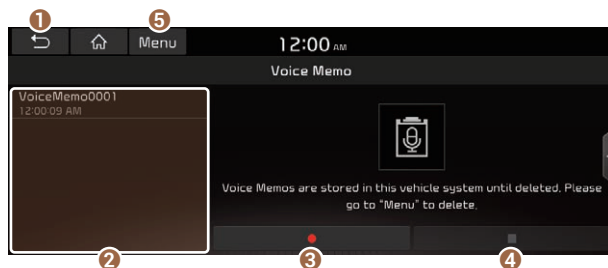

- 1 Returns to the previous step.
- 2 Displays the list of recorded voice memos.
- 3 Starts or pauses the recording.
- 4 Stops recording.
- 5 The list of menu items appears.
  - **Delete:** Can delete a voice memo.
  - **Save to USB Device:** Can record a voice memo to a USB storage device. You can delete voice memos in the USB storage devices formatted in FAT16/32.
  - **Storage Information:** Can see the file size of recorded voice memos.
  - **User's Manual on Web (QR Code):** Displays the QR code that provides access to the online user manual for the system.
  - **Split Screen:** Can turn on or off the split screen mode.

## Recording a voice memo

- 1 On the **Voice Memo** screen, touch .  
It starts recording a voice memo.

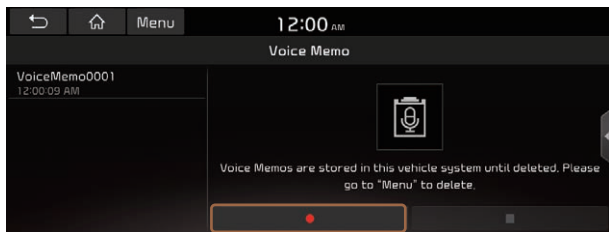

- 2 When recording is finished, touch  on the screen or press the End Call button on the steering wheel.

The voice memo is automatically saved.

- ✎ To temporarily stop recording, touch .
- ✎ When recording starts, the other audio functions are muted or playback is paused.
- ✎ When you make or receive a call while recording, the recording is paused.
- ✎ When you make an emergency call or you are connected to an emergency call after airbag deployment, the recording is stopped and the recorded voice memo is automatically saved.

## Playing a voice memo

You can select and play a recorded voice memo.

From the list of Voice Memos, touch the desired voice memo.

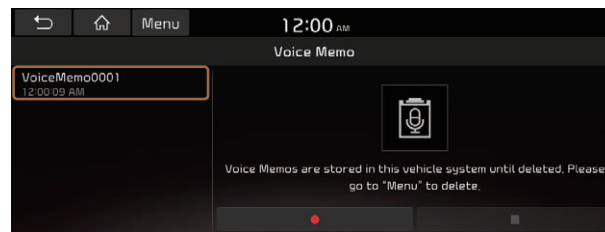

MEMO





UVO

08  
UVO

UVO service  
Running the UVO

# UVO service

UVO provides connected car services, such as roadside assistance and emergency rescue, via the latest IT and communication technologies.

When you have subscribed to UVO, you can use the UVO service by using the [UVO] buttons. You can also access other useful features using the UVO menu on your system.

- ✍ You must be an active UVO subscriber or within the initial free trial period to receive UVO services, including Auto Crash Notifications.
- ✍ Depending on the conditions such as vehicle type, system type, and the subscribed service package, available services may differ.
- ✍ Some services may incur additional charges.
- ✍ Services may be modified, added, or deleted by changes in the company's policies.

## Service restrictions

UVO services are provided via the mobile communication network. Accordingly, the service may be restricted depending on the mobile communication network condition. Use the network signal strength icon (UVO ) at the top of the screen to check the mobile communication status.

- ✍ It is recommended to use the service when the number of signal bars in the icon is 4 or more.
- ✍ Depending on the network signal status, access to UVO may be restricted in the following locations:
  - Inside a building or tunnel
  - Mountain or forest area
  - Road close to a cliff
  - Area densely populated with tall buildings
  - Road under expressway or multi-level road
  - Communication shadow area according to the service provider's network coverage policy

## Subscribing to the service

You must activate the service to use it on the system. An account with [MyUVO.com](http://MyUVO.com) is required to activate the service. When you do not have an account, create a new account to activate the service. When you already have an account, enter the verification code you received from [MyUVO.com](http://MyUVO.com).

### Caution

Do NOT turn off the vehicle when the service setting is in progress. It may cause system malfunction.

#### 1 Park your vehicle in a safe place.

 You cannot enter information for service activation while your vehicle is moving.

#### 2 On the All Menus screen, touch **UVO ► UVO Settings ► Activate UVO.**

#### 3 Enter your phone number or email address, and then touch **Submit.**

 When you have a registered account and verification code, touch **I already have a code.**

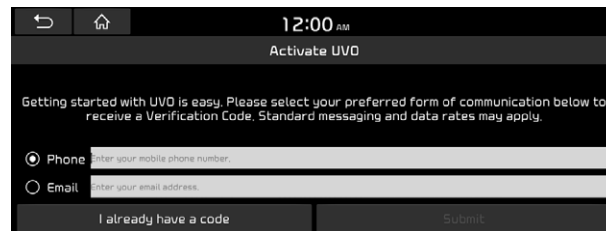

#### 4 Enter the verification code you received from [MyUVO.com](http://MyUVO.com) and then touch **Submit.**

 Now activation starts. While the activation is in progress, the system buttons are locked.

## Caution

Do not turn off the vehicle while the activation is in progress. It may cause a system malfunction.

- ✎ When activation fails, contact the UVO Center at (844) UVO-9411.
- ✎ When your UVO service expires, you can reactivate the service by renewing your subscription on [MyUVO.com](http://MyUVO.com) and entering your verification code again in the **Activate UVO** menu.

## Running the UVO

You can run the UVO in the system to use the service.

On the All Menu screen, touch **UVO**.

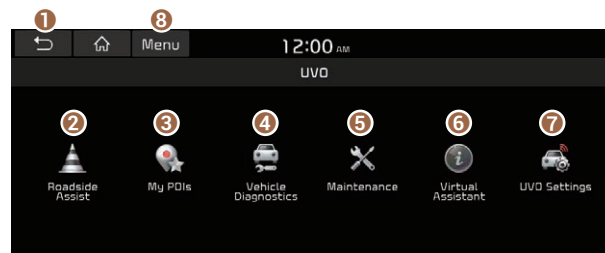

- 1 Returns to the previous step.
- 2 Call to the Roadside Assistance using the UVO service.  
▶ See "Contacting for roadside assistance."
- 3 See the location information received from the UVO website or the UVO application. ▶ See "Using the received location information."
- 4 Check your vehicle's abnormal conditions and see the diagnosis result. ▶ See "Using the received location information."
- 5 See the information about the intervals for the last and next maintenance services (if equipped). ▶ See "Checking maintenance service intervals (if equipped)."
- 6 Access the UVO service to use it on the system, activate the automatic 911 connection feature, or access modem information.

7 Call the UVO Center to request help or make inquiries about using the UVO service.

8 The list of menu items appears.

- **User's Manual on Web (QR Code):** Displays the QR code that provides access to the online user manual for the system.

 The screen may differ depending on the vehicle model and specifications.

### **Warning**

Driving while distracted may cause a loss of vehicle control that may lead to an accident, severe bodily injury, or death. The driver's primary responsibility is the safe and legal operation of the vehicle, and the use of any vehicle systems, including the touch screen and steering wheel controls that take the driver's eyes, attention, and focus away from safe driving or that are not permissible by the law, should never be used while driving.

 Use the UVO features on the system when the vehicle is stationary with the vehicle turned on.

## Contacting for roadside assistance

When you encounter a disabled vehicle or other problems on the road, you can directly contact the UVO Center for roadside assistance and receive the service for vehicle towing.

Perform any of the following methods:

- On the All Menus screen, touch **UVO ► Roadside Assist**.
- Press the [] button on the vehicle.

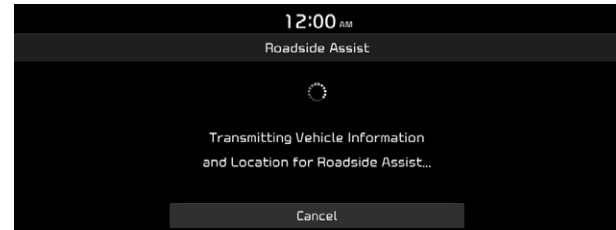

 Depending on the network status, this feature may not work correctly.

## Using the received location information

You can view points of interest (POIs) received from the UVO website and the UVO application and set one of them as the destination.

- 1 On the All Menus screen, touch **UVO ► My POIs**.
- 2 From the list of received locations, select a place name.

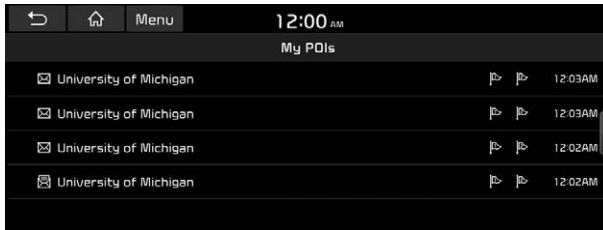

- 3 Check the location information.

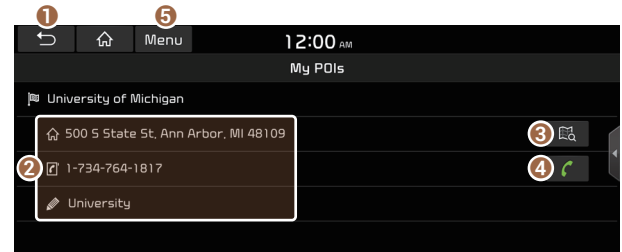

- 1 Returns to the previous step.
- 2 Displays the detailed information of the selected place including the address and contact number.
- 3 Displays the location of the selected place on the map.
- 4 Dials the phone number of the location. This option is available only when the phone number is included in the location.
- 5 The list of menu items appears.
  - **Delete:** Can delete a location from the list.
  - **User's Manual on Web (QR Code):** Displays the QR code that provides access to the online user manual for the system.
  - **Split Screen:** Can turn on or off the split screen mode.

- ✍ When the storage space is not sufficient, data is automatically deleted from the oldest ones.
- ✍ To make a call to the selected location, make sure that your mobile phone has been connected to Bluetooth or Phone Projection.

## Diagnosing the vehicle

If you are curious about whether or not there is a problem with your vehicle, you can diagnose your vehicle. With the diagnosis result, you can also reserve a maintenance service.

### 1 Park your vehicle in a safe location.

- ✍ The vehicle must be stationary because some components cannot be diagnosed while driving.

### 2 On the All Menus screen, touch **UVO ▶ Vehicle Diagnostics**.

Remote vehicle diagnosis starts.

- ✍ Keep the screen on until the diagnosed result appears. When you switch to another screen during diagnosis, the diagnosis service is canceled.

### 3 See the diagnosis results and perform a required function, as follows:

- To schedule a maintenance service at a preferred Kia dealership or the nearest one, touch **Schedule Service**.
- To call the UVO center for roadside assistance, touch **Roadside Assist**.

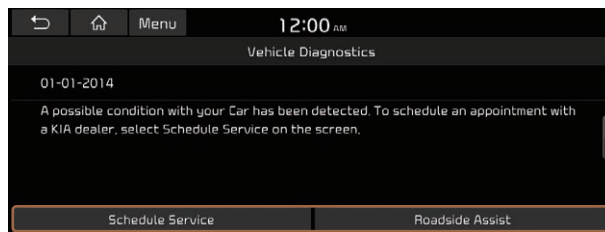

- ✍ A diagnosis result provided by this service is only an estimated result based on the signals from your vehicle. Visit a Kia Motors dealership for a detailed diagnosis.
- ✍ When a critical diagnostics issue is detected on your vehicle, an automatic diagnosis starts when a warning light illuminates on the instrument cluster. You are notified of the diagnosis result.
- ✍ Your preferred dealership must be registered on [MyUVO.com](http://MyUVO.com) for you to schedule a maintenance service with it.

## Checking maintenance service intervals

(if equipped)

You can see information about the intervals for the last and next maintenance services. This feature can help you maintain your vehicle on a regular basis.

1 On the All Menu screen, touch **UVO ► Maintenance**.

2 Check the maintenance information.

 You can see the distance driven and the number of days since your last maintenance service. Use the information to determine when to perform the next maintenance service.

 To reset the information, touch **Reset Service Intervals**.

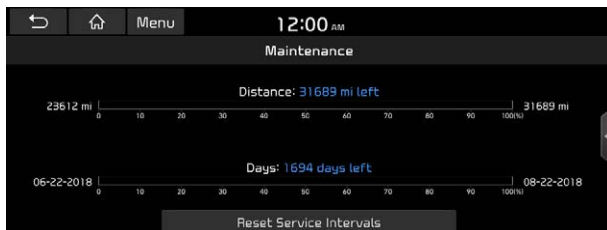

 To access the online user's manual on the Maintenance screen, touch **Menu ► User's Manual on Web (QR Code)** and then scan the displayed QR code.

## Contacting the UVO Center

You can contact a UVO Center representative directly to request help or make inquiries about using the UVO services.

Perform any of the following methods:

- On the All Menu screen, touch **UVO ► Virtual Assistant**.
- Press the  button on the vehicle.

 To end the call, touch **End** on the screen or press the  button.

 This feature is not available during a Bluetooth call.



## Using Voice Local Search

With UVO, you can search for locations from the online map database by using voice commands.

If you did not update the map or system or you cannot find your destination in the navigation, you can use the latest information from the online server to search for locations and receive guidance.

### 1 Press the [UVO] button on the vehicle.

Voice recognition starts with voice guidance.

### 2 After the voice guidance ends and you hear a beep, say the POI name or Address.

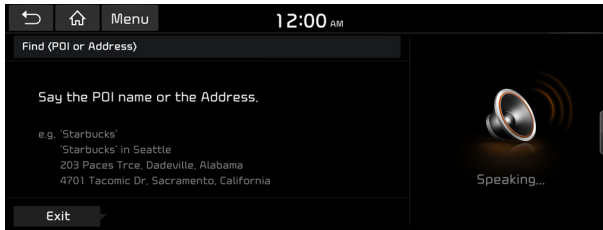

✎ Depending on the system language, voice recognition may not be supported.

## Configuring the UVO settings

You can subscribe to the UVO service or see the modem information.

✎ For more information: ► see “Configuring the UVO settings.”

MEMO



# 09

## Settings

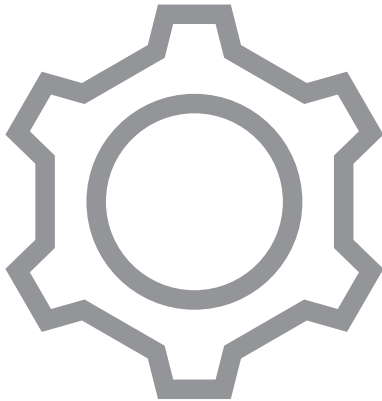

- Configuring the vehicle settings
- Configuring the device connection settings
- Configuring the advanced system settings
  - Configuring the sound settings
- Configuring the voice recognition settings
  - Configuring the navigation settings
  - Configuring the UVO settings
- Configuring the user profile settings
- Configuring the general system settings
  - Configuring the display settings
  - Configuring the media settings
- Updating the system software and map

# Configuring the vehicle settings (if equipped)

You can configure the functions for driving and related environments.

- ✎ Any changes to the settings of the vehicle should be done while the vehicle is safely parked.
- ✎ Available settings may differ depending on the vehicle model and specifications.
- ✎ Depending on the climate control system, some functions may not be supported.

- 1 On the All Menu screen, touch **Setup ► Vehicle**.  
The vehicle settings screen appears.
- 2 Configure the settings required:

## Drive Mode (if equipped)

You can change the vehicle settings for driving conditions.

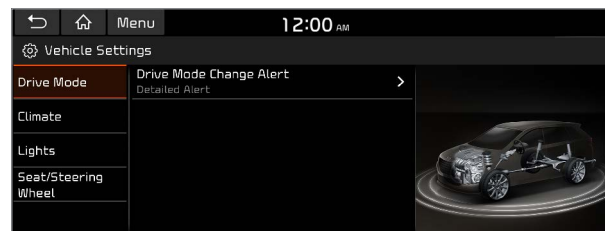

Type A



Type B (EV only)

## ECO (EV only)

This is a drive mode for increasing the vehicle's fuel efficiency. You can change the climate control mode, the active coast energy regeneration level, and speed limit settings.

## NORMAL (EV only)

This is a drive mode focused on the driver and passenger's comfort. You can change the climate control mode and the active coast energy regeneration level.

## SPORT (EV only)

This drive mode enables a more dynamic driving performance. You can change the climate control mode and the active coast energy regeneration level.

## Drive Mode Change Alert (if equipped)

You can set how to display the notification message when the drive mode is changed.

- **Detailed Alert:** Displays a detailed notification message along with the vehicle image when the drive mode is changed.
- **Simple Alert:** Displays the notification at the top or on the split screen when the drive mode is changed.
- **Off:** When the drive mode changes, no notification is provided.

## Reset ECO/NORMAL/SPORT (EV only)

You can reset the drive mode settings to the default values.

- ✎ The display may differ depending on the vehicle model and specifications.
- ✎ See how to improve ECO potential by touching the **Help** button from an EV(Electric Vehicle). In most cases, a vehicle can travel a longer distance when its ECO potential score is higher (EV only).

## Climate (if equipped)

You can configure the operation environment for climate control system.

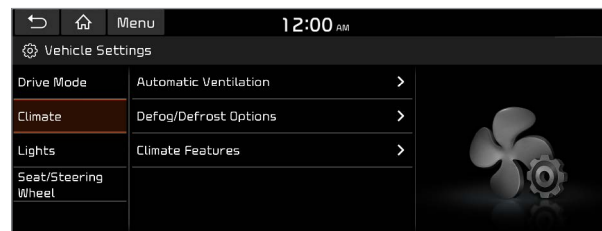

## Automatic Ventilation (if equipped)

You can set to prevent condensation inside and keep inside air pleasant using this feature.

- **Auto Dehumidify:** Once the inside air circulation mode has been used for a long time, it is switched to the outside air inflow mode to prevent condensation.

## Defog/Defrost Options (if equipped)

You can set to enable the defogger to secure driver visibility.

- **Auto Defog:** When the sensor detects fog on the windshield, the automatic ventilation is run for defogging.

## Climate Features (if equipped)

You can set or change the settings for the climate system.

- **Rear Climate Controls:** Used to move to the climate control screen for the rear seat. You can check or set the climate status for the rear seat.

 For more information about controlling the rear-seat climate control system: ► see "Using the rear-seat climate control system (if equipped)"

## Lights (if equipped)

You can configure the settings for vehicle lights.

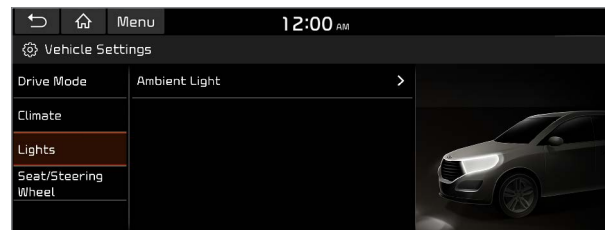

## Ambient Light (if equipped)

You can set the brightness and color of the ambient light.

- **Brightness:** Can set the brightness of the ambient light.
- **Color:** Can change the color of the ambient light. You can select or directly enter the desired color.

## Seat/Steering Wheel (if equipped)

You can configure the settings of the steering wheel or seats, such as seat position change notification and automatic control of the steering wheel warmer.

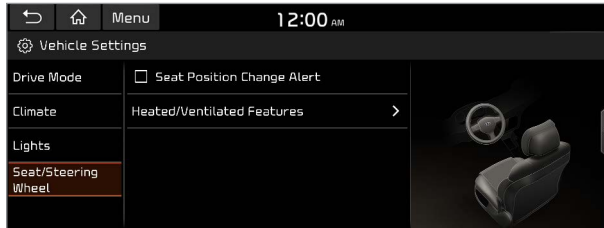

## Seat Position Change Alert (if equipped)

You can set the system to display a notification message along with the seat image on the screen when a seat position is changed.

## Heated/Ventilated Features (if equipped)

You can manage the driving environment pleasantly by linking the climate controls to the steering wheel warmer and driver's seat warmer/ventilation.

- **Steering Wheel Warmer:** Sets to automatically operate the steering wheel warmer based on the climate settings.
- **Seat Warmer/Ventilation:** Sets to automatically operate the seat warmer and ventilation based on the climate settings.

# Configuring the device connection settings

You can manage Bluetooth devices or configure their operation settings. You can also activate the phone projection so that you can control the smartphone applications on the system screen after connecting the smartphone to the system.

## 1 On the All Menus screen, touch **Setup ▶ Device Connections**.

The device connection settings screen appears.

## 2 Configure the settings required:

### Bluetooth

You can register or delete a Bluetooth device for the system and connect or disconnect a registered device. You can also configure operation settings such as notifications, messages, and other settings for Bluetooth devices.



- ✎ For more information on how to use the Bluetooth functions:
  - ▶ see “Connecting a Bluetooth device.”
- ✎ Some setting options appear when a smartphone is connected to the system.
- ✎ To edit or delete a message, pull over the vehicle at a safe place and access the messaging function on your smartphone. You cannot edit or delete a message from the system.
- ✎ When an iPhone is connected to the system, there are some restrictions when receiving messages as follows:
  - Only the sender name appears when the sender information is saved.
  - Only the phone number appears when the sender information is not saved.
  - You cannot use the auto-reply message function.
  - When the incoming message notification or lock-screen view option is off, messages cannot be received.
- ✎ The message reader function may not be supported depending on the system language.

### Bluetooth Connections

You can register or delete a Bluetooth device from the system and connect or disconnect a registered device.

- ✎ You can add one Bluetooth hands-free kit or up to two Bluetooth audio devices.



## Auto Connection Priority

Set Bluetooth connection priority for devices to automatically connect them when starting the vehicle.

## Message Settings

- **Message Notification:** Sets to receive message notifications.
- **Predefined Messages:** Can edit message templates for replies.  
✍ This option may not be available in some phone models.

## Bluetooth Voice Prompts

Set whether to hear voice prompts for events related to Bluetooth connections.

## Privacy Mode

Enable or disable Privacy Mode.

Hide data including contacts and call history from showing up on the system screen to protect privacy.

## Bluetooth System Info

You can see and edit the Bluetooth information of the system.

## Reset

You can delete all registered Bluetooth devices and initialize Bluetooth settings. All data for Bluetooth devices are also deleted.

## Android Auto

You can activate the Android Auto function to pair your Android smartphone with the system.

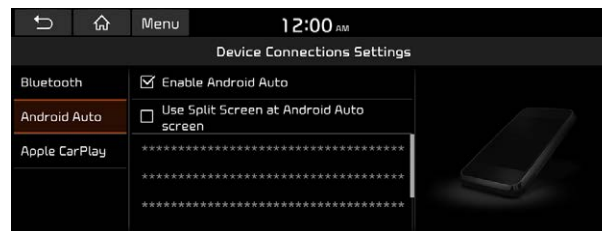

## Apple CarPlay

You can activate the Apple CarPlay function to pair your iPhone with the system.



# Configuring the advanced system settings

You can configure the settings for notification and button actions.

- 1 On the All Menus screen, touch **Setup** ► **Advanced**.

The advanced settings screen appears.

- 2 Configure the settings required:

## Return to Map: Set Time

You can set the system to automatically display the map screen after a specified period of time when switched to the Radio/Media mode screen while using the navigation.

- ✍ This function works while driving once a destination has been set.
- ✍ This feature is not available on the phone projection screen.

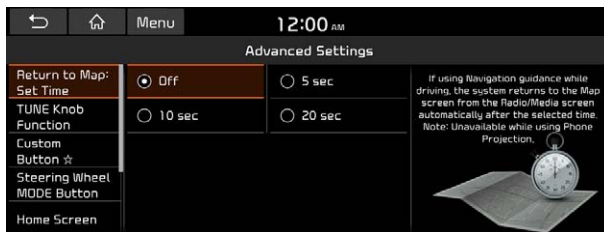

## TUNE Knob Function

You can change the [TUNE/FILE] knob's function on the map.

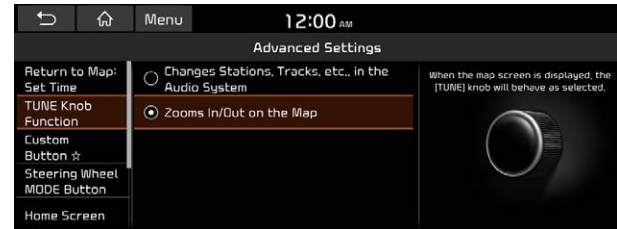

## Changes Stations, Tracks, etc., in the Audio System

You can search music or adjust the radio frequency by using the [TUNE/FILE] knob on the map.

## Zooms In/Out on the Map

You can zoom in or out the map by using the [TUNE/FILE] knob on the map.

## Custom Button ☆

You can set the frequently used functions by pressing the custom button on the control panel. Set the frequently used functions as custom buttons to access them easily.

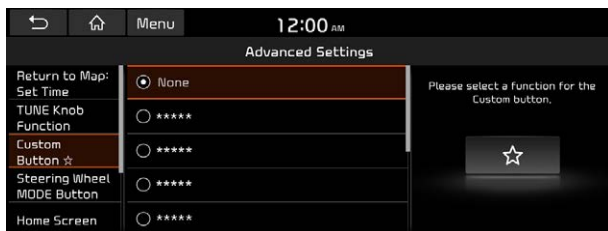

✍ The screen may differ depending on the vehicle model and specifications.

## Steering Wheel MODE Button

You can select the media mode to run when the [MODE] button on the steering wheel is pressed.

✍ You can add **AM** or **Phone Projection** function on each **MODE** button to perform easily.

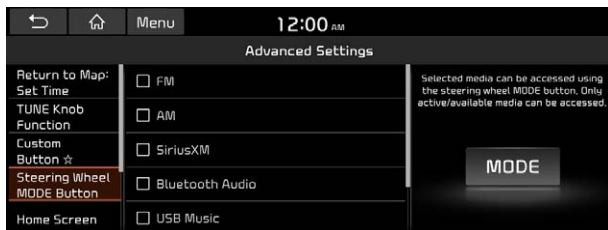

## Home Screen

You can change the layout of the Home screen.

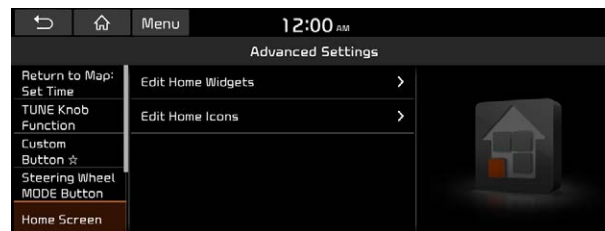

## Edit Home Widgets

You can edit the types and arrangement of home widgets.

✍ For more information: ▶ see "Editing widgets on the Home screen."

## Edit Home Icons

You can edit the arrangement of home icons.

✍ For more information: ▶ see "Editing icons on the Home screen."

## Split Screen (if equipped)

You can specify the items to display on the Split Screen.

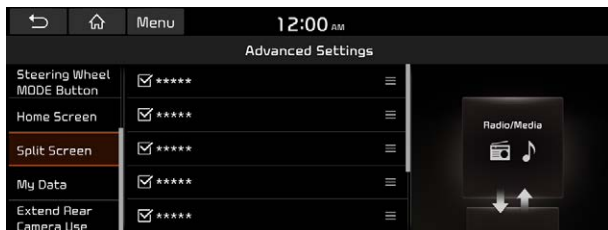

- ✎ The screen may differ depending on the vehicle model and specifications.
- ✎ This option is only available when the display supports Split Screen.
- ✎ On the screen list, touch  on the right and drag the item to reposition.

## My Data

You can import location data from a USB device to the system, or export the data on the system to a USB device.

- ✎ When importing or exporting the location data, you can use only the USB device formatted in exFAT, FAT16/32, or NTFS.

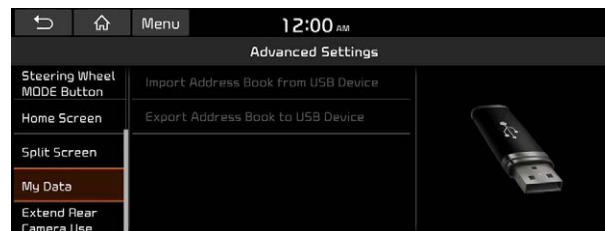

## Import Address Book from USB Device

You can import the location data on a USB device to the system.

- ✎ The previous location data on the system is to be deleted.
- ✎ While importing from a navigation system that uses a different coordinate system, the locations may appear differently.

## Export Address Book to USB Device

You can export the location data on the system to a USB device.

- ✎ The location data on the USB device is deleted.

## Extend Rear Camera Use (if equipped)

You can set to display the rear camera display even when you change the shift position other than "R" (Reverse) after reversing.

- ✎ When you shift to "P" (Park) or drive at a predetermined speed or faster, the rear view display disappears to display the previous screen.

# Configuring the sound settings

You can change the sound settings such as speaker volume and sound effects.

- ✎ Available settings may differ depending on the vehicle model and specifications.
- ✎ Some functions may not be available depending on the infotainment system and amplifier specifications on the vehicle.

- 1 On the All Menus screen, touch **Setup ► Sound**.  
The sound settings screen appears.
- 2 Configure the settings required:

## Position

You can select a position where sound is more audible in the vehicle. By touching the desired point on the seat image or touching the arrow buttons, you can finely adjust the position. To concentrate the sound to the center of the vehicle, touch .

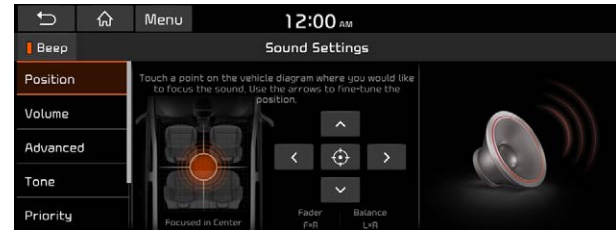

## Volume

You can adjust the volume for each system function including phone projection.

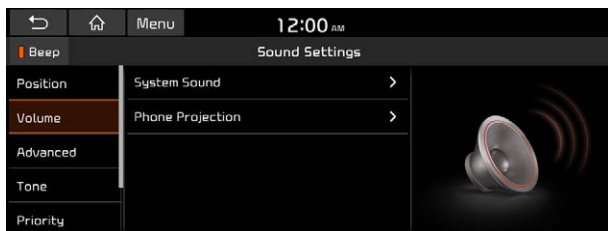

### System Sound

You can adjust the volume for each system function and initialize all volume settings.

 To initialize all system sound settings, touch **Reset**.

### Phone Projection

You can adjust the volume of the phone projection and initialize all volume settings.

 To initialize all system sound settings of the phone projection, touch **Reset**.

## Advanced

You can change the system sound settings and apply various sound effects.

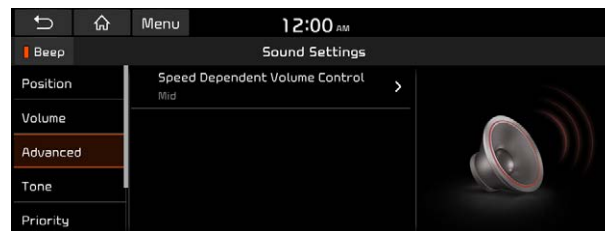

 Available sound effects may differ depending on the specifications of the amplifier.

### Speed Dependent Volume Control

Automatically adjusts Audio volume according to vehicle speed.

### Live Dynamic (if equipped)

Provides natural and vivid sound like real performance.

### Bass Boost (if equipped)

Provides magnificent and dynamic sound by amplifying the bass.

## Quantum Logic Surround (if equipped)

Provides the surround sound that can give spatial depth of field as on an actual stage.

## Clari-Fi (if equipped)

Provides sound close to the original after recovering the sound lost during compression.

## BOSE Centerpoint (if equipped)

Provides rich surround sound after converting the sound sources such as digital files and satellite radio to stereophonic sound.

## BOSE Dynamic Speed Compensation (if equipped)

Provides a stable listening environment by adjusting the audio volume depending on the vehicle speed.

## Tone

You can adjust the sound by adjusting the strengths (output levels) for each audio band: Bass, Midrange, and Treble. You can also initialize the output levels for all audio bands.

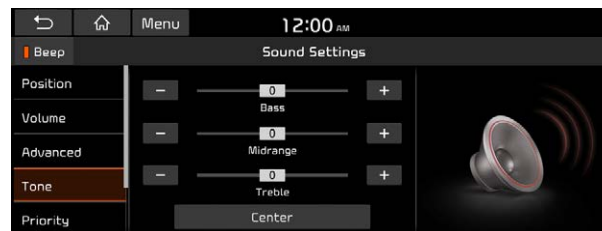

 To initialize the output levels for all audio bands, touch **Center**.

## Priority

You can configure the settings so that a specific sound is more audible over other sounds.

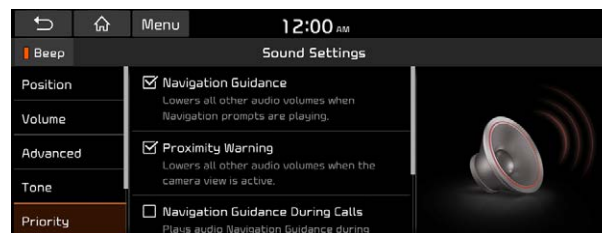

## Navigation Guidance

You can set to enable the navigation sound to be heard first when using both the navigation system and Radio/Media system.

## Proximity Warning

Lowers all other audio volumes when the camera view is active.

## Navigation Guidance During Calls

Even during a call, the navigation sound is heard.

## Start-up Volume Limit

You can set to automatically decrease the audio volume to an adequate level when turning on the vehicle.

## Navigation Volume

You can select a method to adjust the navigation volume.



### Mute Navigation Guidance (if equipped)

Press the Mute button on the steering wheel when the navigation guidance is being output to set to mute the guidance volume for 10 seconds.

### Use Map Screen Volume Buttons

You can adjust the navigation volume by using the volume control button on the map screen.

### Use Map Screen Volume Buttons or Volume Knob

By using the volume control button on the map screen or using the Volume knob on the control panel, you can adjust the navigation volume.



## Reset

You can initialize all the sound settings.

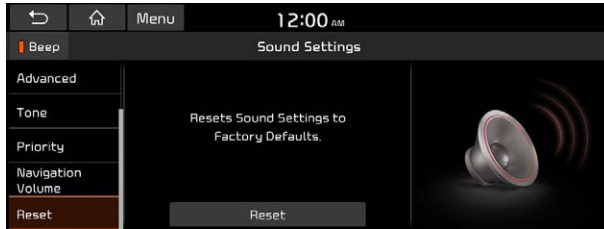

## Turning on/off the screen touch sound

To turn on or off the touch sound on the screen, touch **Beep** at the top of the screen.

## Configuring the voice recognition settings

You can change the settings for voice recognition.

- 1 On the All Menus screen, touch **Setup ► Voice Recognition**.  
The voice recognition settings screen appears.
- 2 Configure the settings required:

## Use Network (if equipped)

When UVO is activated, press the button in the vehicle to initiate network Navigation searches. Network searches can provide a greater variety of results, but rely on network signal strength. Audio samples are collected and stored anonymously for further quality improvements.



## Guidance

You can set whether to hear the voice recognition guidance briefly or in detail. You can also turn off the voice guidance.



Type A



Type B

# Configuring the navigation settings

You can configure the navigation settings for navigation operations, screen display, voice guidance, etc. You can also export or import the location data.

✍ For details on how to use navigation functions, see the "Navigation" chapter. ▶ See "Navigation."

## 1 On the All Menus screen, touch **Setup ▶ Navigation.**

The navigation settings screen appears.

## 2 Configure the settings required:

### Display

You can specify the information to display on the navigation map screen.

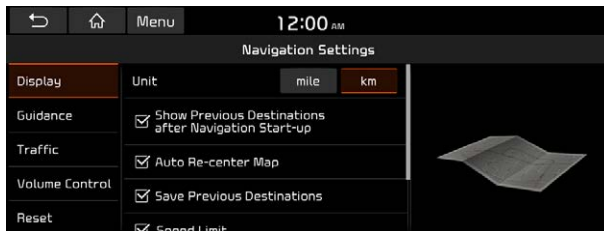

### Unit

You can set the distance unit of the navigation map to **mile** or **km**.

### Show Previous Destinations after Navigation Start-up

You can set to automatically display the previous destinations on a pop-up window when the navigation system starts.

### Auto Re-center Map

You can set the system to automatically display the current position when the specified period of time elapses after changing to another position on the map.

### Save Previous Destinations

You can set to automatically save the previous destinations, searched ones, and starting points.

### Speed Limit

Sets whether or not to display the speed limits on the screen.

## Return to Map: Set Time

You can set the system to automatically display the map screen after a specified period of time when switched to the Radio/Media mode screen while using the navigation. ► See “Return to Map: Set Time.”

## GPS Information

Can see the GPS satellite status and coordinates of the current position.

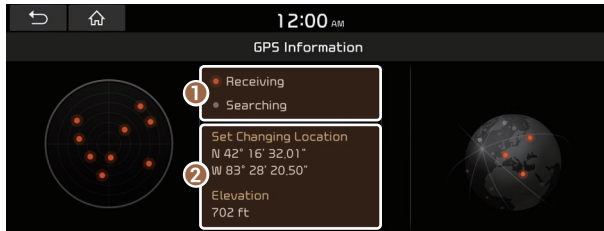

The following information appears:

- 1 Can see the reception status of the satellite signals.
  - **Receiving:** Satellite signals are being received and the current position is recognized.
  - **Searching:** The system is scanning the satellite signals.
- 2 Can see the current location.

## Guidance

You can configure the navigation guidance settings.



### Number of Guidance Prompts

You can set to hear the navigation voice guidance as **Fewer** or **More**.

### Navigation Guidance Priority

You can set to hear the navigation voice guidance in advance. When the setting is checked, the volume decreases automatically while in guidance.

### Navigation Guidance During Calls

Sets whether or not to provide guidance during a call. When checked, you can hear the guidance during a call.

## Map Auto-scale Settings

You can set the scales for each vehicle speed zone.

- ✍ For example, when you select “700 ft” for the 21–40 mi/h zone and “0.25 mi” for the 41–60 mi/h zone, the unit interval for the map scale on the navigation screen becomes 700 ft when the vehicle speed is 40 mi/h and 0.25 mi when the vehicle speed is 41 mi/h.

## Traffic

You can set whether to display traffic information on the navigation map screen. In addition, you can set the system to apply changes in traffic conditions for guidance by performing periodic re-routing.



## Traffic-based Rerouting

You can set the system to apply changes in traffic conditions for guidance by performing periodic re-routing.

- **On: Automatic Rerouting:** Automatically changes to a faster route while in guidance.
- **On: User-approved Rerouting:** Displays the selection window for faster routes while in guidance.
- **Off:** Does not change the route.

## Show Traffic Info.

Sets whether or not to display traffic information on the route of the map.

## Volume Control

You can set how to adjust the volume while using the navigation system.

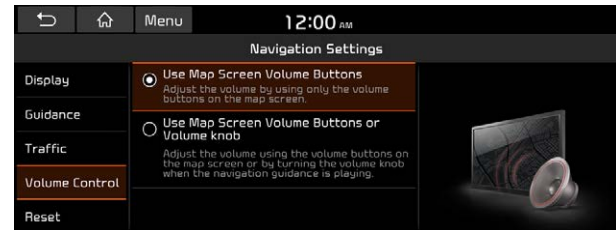

## Use Map Screen Volume Buttons

Can adjust the volume by using the button on the map screen.

## Use Map Screen Volume Buttons or Volume knob

During voice guidance, you can use the volume control button on the map or Volume knob on the control panel.

## Reset

You can initialize all the settings of the navigation system.



## Display (if equipped)

You can specify the information to display on the navigation map screen.

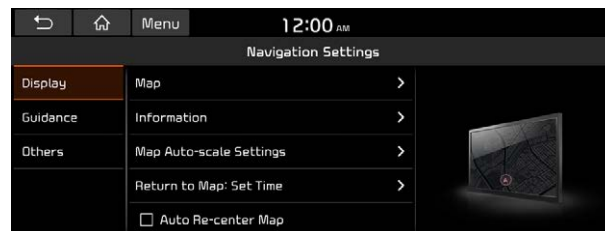

## Map

You can specify the items to display on the map.

- **Map Font Size:** You can set the size of the screen font on the navigation map.
- **Map Color:** You can set the navigation map background color.
- **Map Display:** You can specify the items to display on the map.
  - **Map View:** Set the navigation map display mode. To automatically rotate the map screen based on the driving direction, select **2D Heading Up**. To fix the top of the map screen to north, select **2D North Up**. If you select **3D Map**, the map screen is displayed in 3D mode and automatically rotates based on the driving direction.

- **Display Traffic:** Displays nearby traffic information on the map.
  - **3D Buildings:** Displays major buildings on the map in three dimensions.
  - **Auto-scale:** Automatically changes the scale of the map.
  - **POI Display:** You can specify the icon type to display nearby places on the map.
- ✎ Touch  on the right side of Gas/LPG Station to select display options for fuel prices.
- Gas and LPG stations on the Map screen will also show their fuel prices if they are lower than the set price.
  - Select **Display Fuel Price Info on Map** to view recommended fuel prices based on the prices offered in the area.
  - Fuel prices on the map may differ from actual ones.

## Information

You can specify the information to display on the navigation map screen while driving.

- **Route Guide Line:** Used to display the route guide line in different colors depending on the traffic conditions. To display the route color with a fixed one, uncheck **Show Traffic Colors on Route** and select a color.
- **Vehicle Symbol:** You can specify the icon type to display your current location on the map.
- **Show Vehicle Speed:** Displays the vehicle speed on the map.

- **Detailed Guidance View:** You can set to display detailed information on the Map screen, such as moving directions and lane change.
- **Speed Limits:** Sets whether or not to display the speed limits on the screen.

## Map Auto-scale Settings

You can set the scales for each vehicle speed zone.

- ✎ For example, when you select “100 m” for the “21–50 km/h” zone and “200 m” for the “51–80 km/h” zone, the unit interval for the map scale on the navigation screen becomes 100 m when the vehicle speed is 50 km/h and 200 m when the vehicle speed is 51 km/h.

## Return to Map: Set Time

You can set the system to automatically display the map screen after a specified period of time when switched to the Radio/Media mode screen while using the navigation. ▶ See “Return to Map: Set Time.”

- ✎ This function works while driving once a destination has been set.

- ✎ This feature is not available on the phone projection screen.

## Auto Re-center Map

You can set the system to automatically display the current position when the specified period of time elapses after changing to another position on the map.

## Guidance (if equipped)

You can configure the navigation guidance settings.

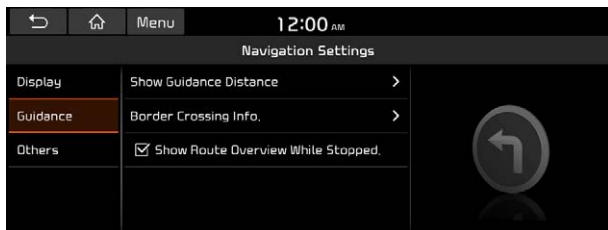

### Show Guidance Distance

You can configure settings for displaying the distance to the destination during guidance.

- **Interval Distance:** Displays the distance as the one between different zones.
- **Cumulative Distance:** Displays the distance as the one between the current position and target position.

### Border Crossing Info.

You can set whether or not to display the border crossing information on the screen.

### Show Route Overview While Stopped.

You can set to display the route overview from the start point to the destination when the vehicle is stationary.



## Others (if equipped)

You can configure navigation options, e.g., turning on or off fuel prices, exporting or importing places from and to Address Book.

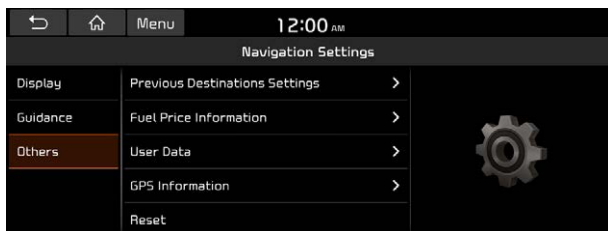

## Previous Destinations Settings

You can set to automatically save the previous destination and display the previous destinations when the navigation system starts.

- **Save Previous Destinations:** The previous destination is automatically saved.
- **Show Previous Destinations after Navigation Start-Up:** When the navigation system starts, the list of recent destinations appear on a pop-up window.

## Fuel Price Information

When displaying gas stations or LPG charging stations on the map, the fuel prices below a specific range can be displayed.

- ✎ Select **Display Fuel Price Info on Map** to view recommended fuel prices based on the prices offered in the area.
- ✎ Fuel prices on the map may differ from actual ones.

## User Data

You can import location data from a USB device to the system, or export the data on the system to a USB device.

- ✎ When importing or exporting the location data, you can use only the USB device formatted in exFAT, FAT16/32, or NTFS.
- **Import Address Book from USB Device:** You can import the location data on a USB device to the system.
  - ✎ The previous location data on the system is to be deleted.
  - ✎ While importing from a navigation system that uses a different coordinate system, the locations may appear differently.
- **Export Address Book to USB Device:** You can export the location data on the system to a USB device.
  - ✎ The location data on the USB device is deleted.

## GPS Information

You can see the GPS satellite status and coordinates of the current position.

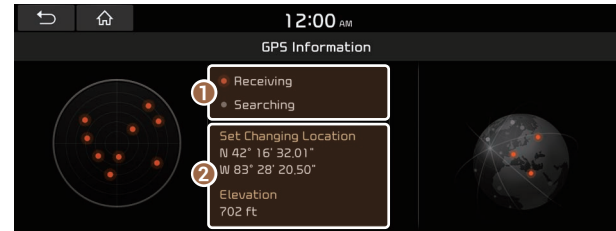

The following information appears:

- 1 Can see the reception status of the satellite signals.
  - **Receiving:** Satellite signals are being received and the current position is recognized.
  - **Searching:** The system is scanning the satellite signals.
- 2 Can see the current location.

## Reset

You can initialize all the settings of the navigation system.

# Configuring the UVO settings

You can subscribe to the UVO service or see the modem information.

- 1 On the All Menus screen, touch **Setup ► UVO**.  
The UVO settings screen appears.
- 2 Configure the settings required:

## Activate UVO

You can subscribe to the UVO service by using the UVO settings menu.

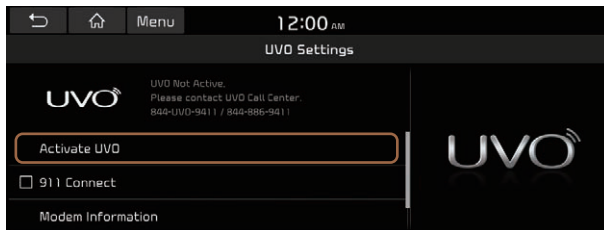

 For more information: ► see “Subscribing to the service.”

## 911 Connect

This feature provides you with immediate assistance when an accident occurs and an airbag is deployed.

- 1 On the All Menus screen, touch **Setup ► UVO**.
- 2 Touch **911 Connect** to activate it.

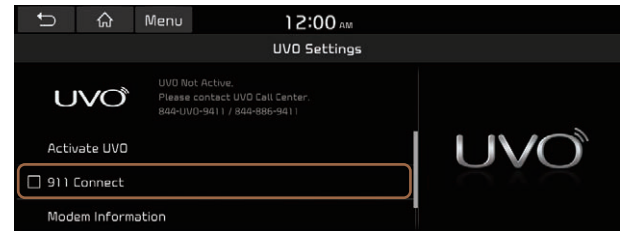

### 3 Read the terms of use and touch **Accept**.

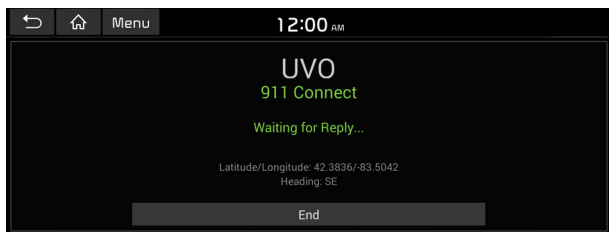

- ✎ The feature is activated and  appears at the top right of the screen.
- ✎ When an airbag is deployed, the system automatically makes a call to 911 and sends your location to the 911 operator.

## Modem Information

You can check the modem information for use of the UVO service.

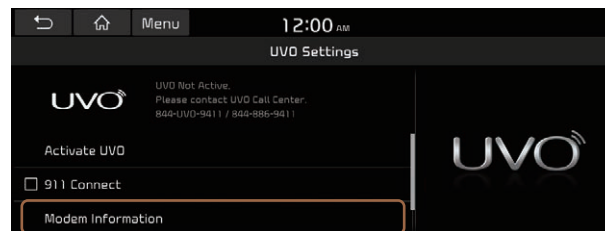

## Modem Status

You can check the modem status for use of the UVO service.

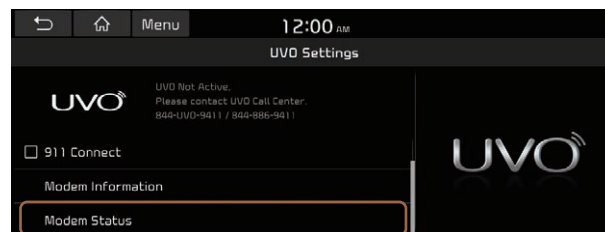

# Configuring the user profile settings (if equipped)

You can additionally set profiles for each driver after First Run Setup.

1 On the All Menus screen, touch **Setup ► User Profile**.

2 Touch the user to change its profile.

The User Profile Settings screen appears.

✍ Touch **Change User** to switch to another user's profile.

✍ When you log in as guest, you cannot set the profile items additionally. To set a different profile, select another user.

## Profile Settings

You can specify the details and operation environment for a registered user.

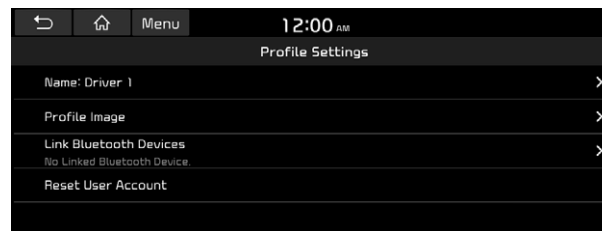

### Name

You can specify the name of the user to display on the profile.

### Profile Image

You can specify the image to display on the user profile.

### Link Bluetooth Devices

You can connect any registered Bluetooth device.

► See "Connecting a Bluetooth device."

### Reset User Account

You can initialize all account settings.

# Configuring the general system settings

You can configure general settings for date, time, language, and the like. You can also check information of the system.

## 1 On the All Menus screen, touch **Setup ► General**.

The general settings screen appears.

## 2 Configure the settings required:

### Date/Time

You can set the system date and time automatically or manually. You can also set the time display mode.

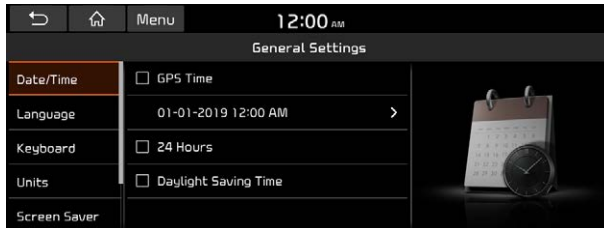

### GPS Time

After receiving the time from GPS, it sets the system date and time automatically.

- ✎ To manually set the date and time, uncheck **GPS Time**, touch the current date and time below **GPS Time**, and then set the date and time.

### 24 Hours

The system time is displayed in the 24-hour format.

- ✎ For example, when **24 Hours** is checked and the current time is 01:08 pm, the system screen displays the time as "13:08." When the checkbox is deselected, the time display changes to "01:08 PM."

### Daylight Saving Time

Displays the system time in the format of Daylight Saving Time.

## Language

You can set the system display language.

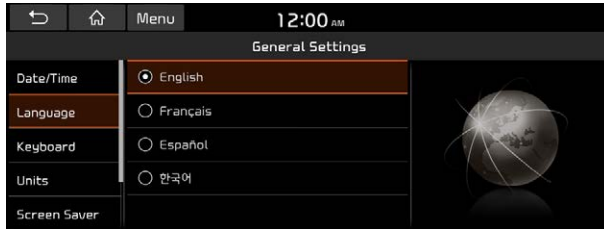

- ✍ Once the language has been changed, it takes a while to apply the new language to the system. The notification pop-up window appears as soon as the new language is applied to the system. When you wait a while or touch anywhere outside the pop-up window, the window automatically disappears.
- ✍ When you change the system language, it does not affect the display of other unique data such as MP3 music file name.
- ✍ Depending on the system language, the Bluetooth phone message view and voice recognition may not be supported.

## Keyboard

You can change the keyboard type for each language to use when entering the text.



### English Keyboard

You can select the keyboard type to use when entering the English text.

### Default Keyboard

You can select the default keyboard type.

## Units (if equipped)

You can specify the units to display on the system screen.

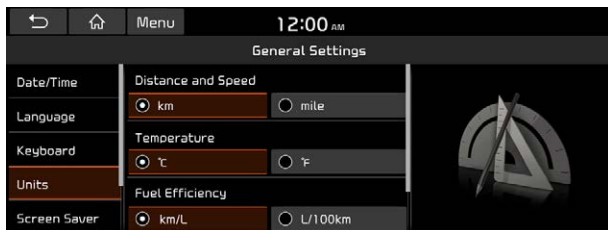

### Distance and Speed

You can select the units for distance and vehicle speed to display on the screen.

### Temperature

You can select the temperature unit to display on the screen.

### Fuel Efficiency

You can select the unit for fuel economy to display on the screen.

### Tire Pressure

You can select the unit for tire pressure to display on the screen.

## Screen Saver

You can select the items to display on the screen saver in standby mode.

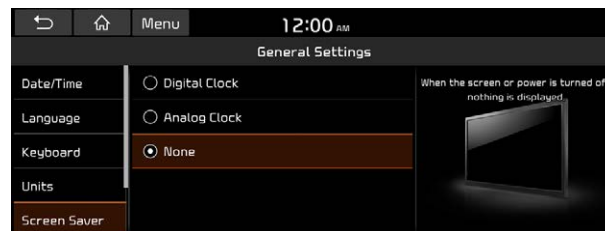

### Digital Clock

Displays the digital clock on the system screen saver.

### Analog Clock

Displays the analog clock on the system screen saver.

### None

Displays nothing on the system screen saver.



## SW Info/Update

You can see the versions of system components. You can also update the system to the latest version.

Perform any of the following methods:

- Setting in the **General** screen: On the All Menus screen, touch **Setup ► General ► SW Info/Update**.
- Setting in the **System Info** screen: On the All Menus screen, touch **Setup ► General ► System Info ► SW Info/Update**.

The SW Info/Update screen appears.

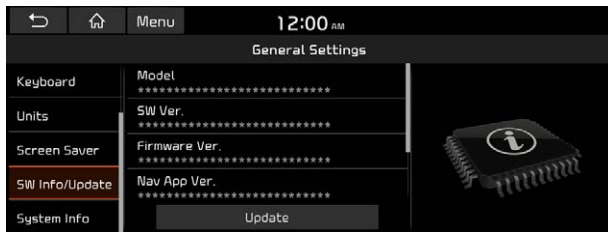

Type A

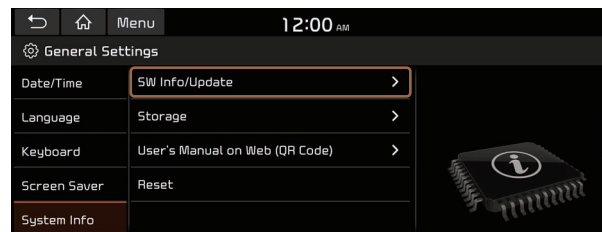



Type B

- ✎ The screen may differ depending on the vehicle model and specifications.
- ✎ For details on how to update the system software:
  - see "Updating the system software and map."

## System Info

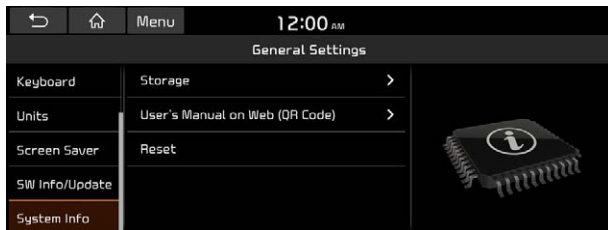
You can check the system storage space. You can also use your smartphone to access the online user's manual of the system, or initialize all system settings to default values.



 The screen may differ depending on the vehicle model and specifications.

## Storage

You can check the storage space of the system memory where voice memos can be saved.

## User's Manual on Web (QR Code)

You can access the online user's manual of the system by scanning the QR code with your smartphone.

## Reset

You can initialize all system settings including general settings and navigation settings.

### **Caution**

- When initialization is performed, all user data in the system including the location data is deleted.
- When phone projection is active, you cannot reset the system settings. To reset the settings, remove the USB cable from your system.

# Configuring the display settings

You can change the system display settings such as display brightness.

- 1 On the All Menus screen, touch **Setup ► Display**.  
The display settings screen appears.
- 2 Configure the settings required:

## Mode

You can set the system to automatically adjust the display brightness depending on the ambient light intensity. You can also set the system to keep the display bright or dark all the time.

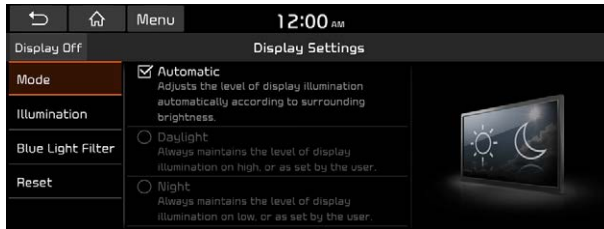

## Automatic

The display brightness is automatically adjusted based on the surrounding environment.

## Daylight

It can be activated when **Automatic** is turned off. It keeps the display always bright regardless of the surrounding environment.

## Night

It can be activated when **Automatic** is turned off. It keeps the display always dark regardless of the surrounding environment.

## Illumination

You can set the system to automatically adjust the display brightness depending on the cluster illumination. You can also set the level of display brightness to use while using the daytime or night mode.



## Link to Cluster Illumination Control

The display brightness is automatically adjusted based on the cluster illumination.

## Daylight

You can set the display brightness when **Daylight** is selected under **Mode**. Uncheck **Link to Cluster Illustration Control** and then set to the desired brightness.

## Night

You can set the display brightness when **Night** is selected under **Mode**. Uncheck **Link to Cluster Illustration Control** and then set to the desired brightness.

## Blue Light Filter

Enable blue light filtering to adjust the screen light to reduce the level of eye strain.



## Use Blue Light Filter

Enable or disable blue light filtering.

## Blue Light Filter Settings

Set to activate blue light filtering automatically based on the ambient light or pick the time range manually.

- **Automatic:** Enable blue light filtering based on the ambient light.
- **Scheduled Time:** Enable blue light filtering during the set time range.

## Reset

You can initialize all display settings such as brightness.



# Configuring the media settings

Set to receive a notification when the information changes during playback or to include sub-folders when playing a folder on repeat.

1 On the All Menu screen, touch **Setup ► Media**.

The media settings screen appears.

2 Configure the settings required:

## Media Change Notifications

You can set to briefly display media information at the top of screen while playing the next item when you move from the media player screen to another.

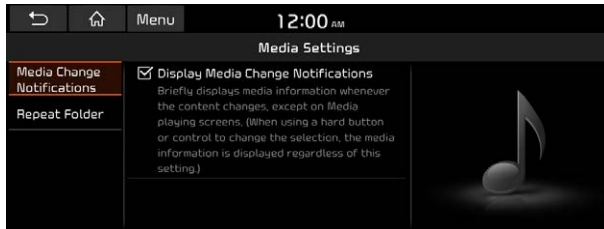

## Repeat Folder

Set to include sub-folders when playing a folder on repeat.



# Updating the system software and map

You can update the navigation map and infotainment system. Please visit your local dealership to update your system.

- ✍ Any changes made after the update file is created are not reflected in the map. As a result, certain roads, buildings, and speed limits on the map may not be up to date.
- ✍ Depending on the total data amount, an update may take several minutes.
- ✍ Do not turn off the system or remove the storage device while the update is in progress. When power supply is cut off or the storage device is removed from the system, it may damage the data or cause a system malfunction.

# 10 Appendix



Solutions  
System status indicator icons  
FAQ  
Product specifications  
Important information  
Index  
Trademarks  
Open Source Information

# Solutions

Before reporting a malfunctioning system, refer to the following table and see if you can identify and fix the problem. If the problem persists or you are unable to locate your specific need, contact your place of purchase or dealer.

## Sound and display

Symptom	Possible cause	Solution
A blank screen appears and sound is not audible.	The system is turned off.	<ul style="list-style-type: none"><li>• Check that the start switch is in “ACC” or “ON.”</li><li>• Press the Power button on the control panel to turn on the system.</li></ul>
	Sound volume is too low.	Turn the Volume knob on the control panel to adjust the volume.
	Sound is muted.	Press the Mute button on the steering wheel to unmute.
Sound is audible from only one side of the speakers.	Sound is imbalanced.	On the All Menus screen, touch <b>Setup ► Sound ► Position</b> and adjust the sound outputs for the left and right speakers. ► See “Position.”
The sound is cut off or noise is heard.	Vibration occurs in the system.	When the system vibrates, the sound may be cut off or noise may occur. This is not a system failure. The system is restored as soon as the vibration stops.



Symptom	Possible cause	Solution
The image quality is poor.	Screen adjustment is required.	On the All Menus screen, touch <b>Setup ► Display ► Illumination</b> , and then adjust the brightness. ► See "Illumination."
	Vibration occurs in the system.	The images may get distorted when vibration occurs in the system. This is not a system failure. The system is restored as soon as the vibration stops.
	The display is aged or the system performance is degraded.	If the problem persists, contact your place of purchase or dealer.
Small red, blue, and green dots are shown on the screen.		LCD has very high-density pixels. For this reason, there may be dead pixels (that are always off) or lit pixels (that are always on) within 0.01 percent of the total pixels.

## USB playback

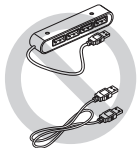
Symptom	Possible cause	Solution
Files in a USB device cannot be played.	There are no compatible files for playback	Copy the files that can be played by the system to the USB device and connect the device again. ► See "USB mode."
	Poor connection is found.	Remove the USB device from the USB port and then reconnect it properly.
	The USB device is dirty.	Remove foreign materials from the surface that contacts the USB device and USB port.
	A USB hub or extension cable is used.	Connect the USB device directly to the USB port on the vehicle.
		
	The USB device is non-standard.	Use a USB device that is compatible with the system. ► See "USB mode."
	The USB device is damaged.	Use your computer to format the USB device and then connect the device again. Format the device in FAT16/32 format.

## Bluetooth connection

Symptom	Possible cause	Solution
The system is not detected by a Bluetooth device.	Registration mode needs to be run.	On the All Menus screen, touch <b>Setup ▶ Device Connections ▶ Bluetooth ▶ Bluetooth Connections ▶ Add New</b> to run the registration mode and perform search again from the Bluetooth device. ▶ See "Connecting a Bluetooth device."
The Bluetooth device is not connected.	The Bluetooth function should be activated. Any error occurs while using the Bluetooth function.	Activate the Bluetooth function on the Bluetooth device to connect. <ul style="list-style-type: none"><li>• Turn the Bluetooth function OFF / ON on the Bluetooth device and then connect the device again.</li><li>• Turn the Bluetooth device off and on and then connect the device again.</li><li>• Remove the battery from the Bluetooth device and attach it back, turn on the device, and then connect the device again.</li><li>• Delete the system and Bluetooth device from the registration lists respectively, and then connect the device again.</li></ul>

## Phone projection

Symptom	Possible cause	Solution
The phone projection function is not performed when a smartphone is connected using a USB cable.	Phone projection is not supported.	Visit the website to check whether your smartphone supports the phone projection. <ul style="list-style-type: none"><li>• Android Auto: <a href="https://support.google.com/androidauto">https://support.google.com/androidauto</a></li><li>• Apple CarPlay: <a href="http://www.apple.com/ios/carplay">http://www.apple.com/ios/carplay</a></li></ul>
	The function is inactive.	<ul style="list-style-type: none"><li>• On the All Menus screen, touch <b>Setup ► Device Connections</b>, select the function to use, and then turn on the phone projection option.</li><li>• Make sure that the phone projection is not disabled in the application settings or block-out settings on your smartphone.</li></ul>
	Smartphone is encountered with poor operation or malfunction.	<ul style="list-style-type: none"><li>• Check that the smartphone battery level is not too low. Recognition may not work properly when the battery level is too low.</li><li>• The phone projection may not work properly when the signal strength is weak.</li><li>• When the smartphone is locked, first unlock it.</li><li>• Initialize the smartphone and connect the device again.</li></ul>
A black screen appears when the phone projection is activated or in use.	The smartphone malfunctions.	<ul style="list-style-type: none"><li>• Remove the USB cable from the smartphone and connect the device again.</li><li>• Initialize the smartphone and connect the device again.</li></ul>

## System operation

Symptom	Possible cause	Solution
The previous media mode does not appear when the system is turned off and on.	It is encountered with poor media connection or playback error.	When the media source is not connected or played normally, the previous mode appears. Connect the media source again or play it again.
The system slows down or does not operate at all.	An internal error occurs in the system.	<ul style="list-style-type: none"><li>• Restart the system by pressing the reset button with a sharp object such as pen or clip.</li><li>• If the problem persists, contact your place of purchase or dealer.</li></ul>
The system is not turned on.	Fuse-related issues	<ul style="list-style-type: none"><li>• Visit an auto service shop and replace the fuse with a new one of appropriate capacity.</li><li>• If the problem persists, contact your place of purchase or dealer.</li></ul>

## Navigation system operation

Symptom	Possible cause	Solution
The destination is not searched.	Outdated map data	To update your system, visit your local dealership.
Route guidance of the navigation system does not match the actual road conditions.	Outdated map data	To update your system, visit your local dealership.
	There have been changes in the road after a map update.	Route guidance of the navigation system may not match the actual road conditions even after the map is updated to the latest version because the update depends on the creation date. Be sure to drive according to actual road conditions and regulations.
Guidance is made by bypassing the route or the speed camera alerts are not followed.	The update for the system and map data is required.	To update your system, visit your local dealership.
The real-time traffic information is not received.	Poor signal reception	<ul style="list-style-type: none"><li>• Reception of traffic information may not be made smoothly in mountain and island areas. Check the reception status again in a region with strong signals.</li><li>• If the problem persists, contact your place of purchase or dealer.</li></ul>

# System status indicator icons

You can see the system status by checking the status indicator icons at the top right of the system screen.

Different status indicator icons appear when each function is performed. The meanings of the icons are as follows:



## Bluetooth/call



	Connecting a phone via Bluetooth
	Connecting an audio device via Bluetooth
	Connecting a phone and an audio device via Bluetooth
	Making a call via a Bluetooth phone
	Bluetooth phone's microphone off
	Downloading the contact and list of recent calls from the connected Bluetooth phone

## Mute/memo recording



	Navigation sound muted
	Radio/Media sound muted
	All sound outputs muted
	Recording a voice memo

## UVO



	Talking with a UVO phone
	UVO phone's microphone off
	Vehicle location sharing
	Sending the vehicle location
	Receiving the vehicle location
	Sending/receiving the vehicle location
	UVO network's signal strength

## System update



	Scheduling the update
	Updating

## Available functions in the rear seat (if equipped)



	Rear-seat remote control locked
	Rear-seat sleep mode On
	Front-seat driver is having a conversation with a rear-seat occupant

## Wireless charging



	Wireless charging in progress
	Wireless charging complete
	Wireless charging failure

Some icons may not appear depending on the vehicle model and specifications.



# FAQ

## Navigation

**Q** How can I update the map?

**A** You can download the latest map data to a USB device and use the device to update the map. ► See “Updating the system software and map.”

**Q** Guidance is made by bypassing the route or the speed camera alerts are late.

**A** Select another route after setting the route options. On the map screen, touch **Menu ► Route ► Route Options** to change the settings and resume navigation. ► See “Changing the route search criteria.”

When the system is not updated, update the software and map and then perform search again. ► See “Updating the system software and map.”

## Bluetooth

**Q** Which functions can I use via Bluetooth?

**A** You can use the hands-free call function with a mobile phone connected. You can also play music after connecting an audio device such as MP3 player or mobile phone. ► See “Making a call via Bluetooth.”, “Listening to music via Bluetooth.”

**Q** How can I register a Bluetooth device?

**A** On the All Menus screen, touch **Setup ► Device Connections ► Bluetooth ► Bluetooth Connections ► Add New**. From the Bluetooth device to be connected, search for the vehicle system and register it. Use the Bluetooth device to enter or approve the authentication number displayed on the system. Then the device is added to the list of Bluetooth devices in the system and automatically connected to the system. ► See “Connecting a Bluetooth device.”

**Q** I bought a new mobile phone and want to replace my old phone with the new one to connect the system. How can I register the new phone to the system?

---

**A** An additional device can be registered in the same way as in registration of a new device. You can register up to 6 devices in the list of Bluetooth devices. To delete a previously registered device, touch **Delete Devices** from the list of Bluetooth devices, select the device to delete, and then touch **Delete**. ► See “Deleting a registered device.”

**Q** How can I access the list of contacts while using a Bluetooth phone?

---

**A** Approve access to the contacts when connecting your mobile phone to the system via Bluetooth. The list of contacts on the phone is downloaded to the system. To see the downloaded list of contacts, press the Call button on the steering wheel and touch  on the call screen. You can search for a contact and make a call to the contact, or add the contact to the favorites. ► See “Dialing from the contacts.”

## Broadcast reception

**Q** I turned on the radio while driving but I heard no sound but noise.

---

**A** Depending on the location, obstacles may cause reception to deteriorate.

Radio reception rate may also drop when an on-glass antenna is mounted on the rear window and the window is tinted with metallic window films.

## Self-inspection method upon failure

**Q** The system does not operate properly. What shall I do?

**A** Inspect the system after referring to Troubleshooting Guide. ▶ See "Solutions."

When the system failure persists after inspection, press and hold the Reset button to reset the system.

If the problem persists, contact your place of purchase or dealer.

## Product specifications

### Media player

#### USB mode

##### Music files

Item	Specifications
File format	MPEG-1/2 Layer3, OGG (Vorbis), FLAC, WMA (Standard/Professional), WAV
Bit-rate and sampling frequency	MP3 8–320 kbps (CBR/VBR), up to 48 kHz (ID3 tag version: Ver. 1.0, Ver. 1.1, Ver. 2.2, Ver. 2.3, Ver. 2.4)
	OGG Q1 to Q10, up to 48 kHz
	FLAC 8/16/24-bit, up to 48 kHz
	WMA Standard (0x161): up to L3 Profile, up to 385 kbps, up to 48 kHz  Professional (0x162): up to M0b, up to 192 kbps, up to 48 kHz
WAV	8/16 to bit, up to 48 kHz

Item	Specifications
Specification details	<p>Max. number of directory layers: 20 layers</p> <p>Max. folder/file name length: 255 Bytes</p> <p>Valid characters that can be used in a folder/file name: 2,350 Alphanumeric characters/4,888 Chinese characters</p> <p>Max. number of folders: 2,000 (including the root)</p> <p>Max. number of files: 8,000</p>

- ✎ The following files are not played.
  - Modified files (format-changed files)
  - Variant files (e.g. MP3 files encoded by WMA audio codec)
  - DRM (Digital Rights Management)-protected files
  - Files with no index
- ✎ Sound quality is not guaranteed in case of music files that use the bit-rate exceeding 192 kbps.
- ✎ With the files that do not use the fixed bit rate, some functions may not work properly or the playback time may not appear accurately.
- ✎ When a trouble occurs while playing or you want to play an incompatible format file, use the latest encoder software to change the format before using the file.

## ■ USB storage devices

Item	Specifications
Byte/Sector	64 KB or less
Format system	FAT16/32 (recommended), exFAT, NTFS

✎ With the USB storage devices that are not equipped with a plug-type connector (metal cover type), proper operation is not guaranteed.

- USB storage devices with a plastic plug may not be recognized.
- USB memory cards (e.g. CF cards, SD cards) may not be recognized.

✎ Problems that are caused by using USB storage devices (not specified in the following list), are not covered by the warranty.

Product name	Manufacturer
XTICK	LG
BMK	BMK Technology
SKY-DRV	Sky Digital
TRANSCEND JetFlash	TranScend
Sandisk Cruzer	SanDisk
Micro ZyRUS	ZyRUS
NEXTIK	DIGI Works

✎ USB hard drives may not be recognized.

✎ When using a USB mass storage device divided into logical drives, only the files saved in the first drive can be played.

✎ When a USB storage device has some applications, media files may not be played.

## Common specifications

Item	Specifications
Power supply	DC 14.4 V
Operating voltage	DC 9-16 V
Dark current	Below 1 mA in average within 45 days
Operating temperature range	-20 to +70 °C
Storage temperature range	-40 to +85 °C
Electric current consumption	2.5 A

## Radio

Item	Specifications
Available channels	FM: 87.5–107.9 MHz (step: 200 kHz) AM: 530–1710 kHz (step: 10 kHz)
Sensitivity	FM: Within 10 dBuV AM: Within 35 dBuEMF
Distortion factor	Within 2 %

## Bluetooth

Item	Specifications
Frequency range	2400-2483.5 MHz
Supported Bluetooth version	4.1
Supported profiles	Hands-free (1.7), A2DP (1.3), AVRCP (1.6), PBAP (1.1), MAP (1.2)
Bluetooth Power Class 2	-6 to 4 dBm
Antenna power output	2.5 mW (max.)
Number of channels	79

## LTE RF

Item	Specifications
LTE	Reception Frequency: 1930 MHz to 1990 MHz(B2), 2110 MHz to 2155 MHz(B4), 869 MHz to 894 MHz(B5), 746 MHz to 756 MHz(B13)  Sensitivity: -94.3 dBm under@10 M(B2,5), -96.3 dBm under@10 M(B4), -93.3 dBm under@10 M(B13) (Throughput $\geq$ 95 %)
	Transmission Frequency: 1850 MHz to 1910 MHz(B2), 1710 MHz to 1755 MHz(B4), 824 MHz to 849 MHz(B5), 777 MHz to 787 MHz(B13)  Maximum RF output power: Power Class3(B4, B13), 20.3 dBm to 25.7 dBm (conducted)

Item	Specifications	
CDMA	Reception	Frequency: 869 MHz to 894 MHz(BC0), 1930 MHz to 1990 MHz(BC1)  Sensitivity: -104 dBm under(FER = 0.5 % under)
	Transmission	Frequency: 824 MHz to 849 MHz(BC0), 1850 MHz to 1910 MHz(BC1)  Maximum RF output power: Power Class3(BC0), Power Class2(BC1), 23.01 dBm to 30 dBm(conducted)

## Wi-Fi (if equipped)

Item	Specifications
Frequency	2401 to 2473 MHz, 5735 to 5815 MHz
Specification	IEEE802.11a/b/g/n/ac
Supported bandwidth	20/40/80 MHz
Operating temperature	-20 to +70 °C (-4 to +158 °F)
Maximum WLAN output power	<ul style="list-style-type: none"> <li>• 2.4 GHz: 10 dBm</li> <li>• 5 GHz: 10 dBm</li> </ul>

## Important information

Before using your system, read and follow all instructions and safety information provided in this user's guide ("User's Manual"). Not following precautions found in this guide can lead to an accident or other serious consequences.

### Keep this guide in your vehicle

When kept in the vehicle, this guide will be a ready reference for you and other users unfamiliar with the system. Ensure that before using the system for the first time, all persons have access to this guide and read its instructions and safety information carefully.

### Warning

Operating certain parts of this system while driving can distract your attention away from the road, and possibly cause an accident or other serious consequences. Do not change system settings or enter data non-verbally (using your hands) while driving. Stop the vehicle in a safe and legal manner before attempting these operations. This is important since setting up or changing some functions as you drive may distract your attention away from the road and removing your hands from the steering wheel may cause you to lose control of the vehicle.

## General operation

### Voice command control

Features within the system may be executed using only voice commands. Using voice commands while driving allows you to operate the system without removing your hands from the steering wheel.

### Prolonged views of screen

Do not access any function requiring a prolonged view of the screen while you are driving. Pull over in a safe and legal manner before attempting to access a function of the system requiring prolonged attention. Even short views of the screen may be hazardous if your attention has been diverted away from your driving.

### Volume setting

Do not raise the volume excessively. Keep the volume at a level where you can still hear outside traffic and emergency signals while driving. Driving while unable to hear these sounds could cause an accident.

## Navigation features

Navigation features included in the system are intended to provide detailed instructions to get you to a desired destination. Ensure that all persons using this system carefully read and follow all instructions on safety information.

### Distraction hazard

Some navigation features may require manual (non-verbal) setup. Attempting to perform such setup or inputting data while driving can seriously distract your attention and could cause an accident. Stop the vehicle in a safe and legal manner before attempting these operations.

### Let your judgment prevail

Any navigation features are provided only as an aid. Make your driving decisions based on your observations of local conditions and existing traffic regulations. Any such feature is not a substitute for your personal judgment. Any route suggestions made by this system should never replace any local traffic regulations or your personal judgment or knowledge of safe driving practices.



## **Route safety**

Do not follow the route suggestions if doing so would result in an unsafe or illegal maneuver, if you would be placed in an unsafe situation, or if you would be directed into an area that you consider unsafe. The driver is ultimately responsible for the safe operation of the vehicle and must evaluate whether it is safe to follow the suggested directions.

## **Potential map inaccuracy**

Maps used by this system may be inaccurate because of changes in roads, traffic controls or driving conditions. Always use good judgment and common sense when following the suggested routes.

## **Emergency services**

Do not rely on any navigation features included in the system to direct you to emergency services. Ask local authorities or an emergency services operator for these locations. Not all emergency services such as police, fire stations, hospitals and clinics are contained in the map database for navigation features.

## **Use of speech recognition functions**

Speech recognition software is inherently a statistical process which is subject to errors. It is your responsibility to monitor any speech recognition functions included in the system and address any errors.

# Index

## A

Advanced system settings 9-8

Android devices

Android Auto 2-4

Apple devices

Apple CarPlay 2-6

## B

Battery warning 1-6

Bluetooth

Bluetooth phone

Answering a call 6-15

Call 6-7

Contacts list 6-11

Dial pad 6-13

Favorites settings 6-9

Options during a call 6-16

Recent calls list 6-7

Switching to another call 6-17

Text message 6-18

Specifications 10-16

Bluetooth connection

Adding a device 6-3

Deleting a device 6-6

Device connection 6-4

Disconnecting a device 6-6

## C

Climate

Climate control system 2-13

Component Names and Functions

Control panel

Custom button 1-2

MAP button 1-2

MEDIA button 1-2

NAV button 1-2

POWER button/VOLUME knob 1-2

RADIO button 1-2

SEEK/TRACK button 1-2

SETUP button 1-3

System Reset button 1-3

TUNE knob/FILE knob/

ENTER button 1-3

Steering wheel remote control

Call button 1-4

End Call button 1-4

MODE button 1-3

Move button 1-4

Voice Recognition button 1-3

Volume lever/Mute button 1-3

Contacts list 6-11

Control panel 1-2

## D

Date and time settings 9-28

Deleting a location 5-26

Destination search 5-3

Driving assist display 2-8

## E

- Editing a location 5-26
- Editing a route 5-18
- EV charging stations 5-28

## F

- FAQ 10-11
  - Bluetooth 10-11
  - Broadcast reception 10-12
  - Navigation 10-11
  - Self-inspection method upon failure 10-13
- Finding a route easily 5-3
  - Destination search 5-3
- Finding the route
  - Adding a waypoint 5-18
  - Address search 5-10
  - Detour 5-20
  - Displaying POIs on the map 5-16
  - Frequently visited places 5-24
  - Gas stations 5-27
  - Location registration
    - Deleting a POI 5-26
    - Editing a POI 5-26
    - Registration after search 5-22

- Map 5-6
- Map update 9-36
- Previous Destinations 5-12
- Saving the current position 5-23
- Searching for POIs 5-14
- Volume adjustment 5-8

## H

- HD Radio Data 2-18
- HD Radio™ 3-7
- Home screen 1-10

## K

- Keyboard settings 9-29

## L

- Language settings 9-29
- Listening to music
  - Bluetooth audio 4-7
- Location registration 5-22

## M

- Map 5-6
  - POI display 5-16
- Map update 9-36
- Media device connection 4-2
- Media player
  - Bluetooth audio 4-8
  - USB music 4-2
- Messages 6-18
- Microphone 7-2
- Multi-page Home screen 1-10

## N

- Navigation 5-2, 5-10
- Navigation settings 9-17
- Notifications 2-22

## P

Phone 6-7

Phone projection

Android Auto 2-4

Apple CarPlay 2-6

Previous Destinations 5-12

Product specifications

Bluetooth 10-16

Common specifications 10-15

LTE RF 10-16

Media player 10-13

Radio 10-15

Proximity Warning 2-10, 9-14

## R

Radio

Changing the channel 3-4

Changing the radio mode 3-4

Deleting a channel 3-6

Registering a channel 3-5

Scanning channels 3-5

Rear view display 2-9

Recent calls list 6-7

Reset

Bluetooth 9-7

Navigation settings 9-20

Screen settings 9-34

Sound settings 9-15

System settings 9-32

## S

Save searched place 5-22

Saving frequently visited places 5-24

Saving the current position 5-24

Screen saver settings 9-30

Screen settings 9-33

Screen touch sound settings 9-15

Settings

Advanced settings 9-8

Bluetooth settings 9-6

Date and time 9-28

Device connection 9-6

Keyboard 9-29

Screen saver settings 9-30

Screen touch sound 9-15

System display settings 9-33

System Info 9-32

System language 9-29

System Sound 9-12

User profile settings 9-27

UVO settings 9-25

Vehicle settings 9-2

Voice recognition settings 9-15

## SiriusXM™ 3-8

- Changing to SiriusXM mode 3-8
- Featured Favorites channels 3-11
- Searching for channels 3-10
- Seeing the program schedule 3-11
- Selecting channels 3-10

## Sound Mood Lamp 2-16

## Sound settings 9-11

## Sounds of Nature 2-17

## Split screen 1-12

## Steering wheel remote control 1-3

## Surround view monitor

- Door opening/mirror folding alert 2-11
- Rear view video 2-12
- Screen settings 2-12
- Screen view 2-11

## System Info 9-32

## System status indicator icons 10-9

## T

### Troubleshooting 10-2

- Bluetooth connection 10-5
- Navigation operation 10-8
- Phone projection 10-6
- Sound and display 10-2
- System operation 10-7
- USB playback 10-4

### TUNE Knob Function 9-8

### Turning the system on or off 1-4

## U

### Update 9-36

### USB file specifications 10-13

### USB music 4-2

### USB port 4-2

### USB storage device specifications 10-14

### Using the Driver talk mode in the rear seat 2-15

### Using the Quiet mode in the rear seat 2-16

### Using the rear-seat climate control system 2-14

### Using the sound mood lamp 2-16

### Using the touch screen 1-6

### UVO

#### Service 8-2

#### UVO menu

- Diagnosing the vehicle 8-7
- Driving Information 2-21
- My POIs 8-6
- Roadside Assistance 8-5
- Settings 8-9, 9-25
- Virtual Assistant 8-8
- Voice Local Search 8-9

## V

Vehicle settings 9-2

Voice memo 7-19

Voice recognition

- Help 7-4

- Microphone 7-2

- Navigation commands 7-7

- Other commands 7-10

- POI name 7-11

- Radio commands 7-10

- Using the voice recognition 7-2

- Volume setting 7-4

Voice recognition settings 9-15

# Trademarks

- **Bluetooth® Wireless Technology**

A compatible Bluetooth® Wireless Technology-enabled cell phone is required to use Bluetooth® Wireless Technology. The Bluetooth® word mark and logos are registered trademarks owned by Bluetooth SIG, Inc. and any use of such marks by Kia is under license. Other trademarks and trade names are those of their respective owners. A Bluetooth® enabled cell phone is required to use Bluetooth® Wireless Technology. Bluetooth® Wireless Technology phone compatibility can be checked by visiting <https://www.kia.com>.



- Google, Android, Android Auto, and Google Play are registered trademarks of Google LLC. Distracted driving can result in a loss of vehicle control. Never use a handheld device or vehicle system that takes your focus away from safe vehicle operation.
- Apple®, Apple CarPlay™, iPad®, iPad mini™, iPhone®, iPod®, iPod classic®, iPod nano®, iPod touch®, iTunes®, and Siri® are trademarks of Apple Inc. Distracted driving can result in a loss of vehicle control. Never use a handheld device or vehicle system that takes your focus away from safe vehicle operation.

- HD Radio™ Technology is manufactured under license from iBiquity Digital Corporation. U.S. and Foreign Patents. For patents, see <http://patents.dts.com/>. HD Radio and the HD, HD Radio™, and "ARC" logos are registered trademarks or trademarks of iBiquity Digital Corporation in the United States and/ or other countries.



- Sirius, XM, SiriusXM and all related marks and logos are trademarks of Sirius XM Radio Inc.
- Other trademarks and trade names are those of their respective owners.
- The Wi-Fi CERTIFIED™ Logo is a certifiemark of Wi-Fi Alliance.



# Open Source Information

This system contains open source software.

To download the open source codes installed on this product developed under GPL, LGPL, Apache, and other open source licenses, please visit <http://en.mobis.co.kr/opensource/list.do>. All notified license content, including the source code, is available for download.

If you request the open source code of a software mounted on this product by sending an email to [MOBIS\\_OSSrequest@mobis.co.kr](mailto:MOBIS_OSSrequest@mobis.co.kr) within 3 years of purchasing this product, you will receive it on a CD-ROM or another storage media at a minimal cost, such as the costs of the medium and delivery.



MEMO



MEMO

