

TEST REPORT

of

FCC Part 15 Subpart E §15.407
RSS-247 Issue 2FCC ID: TQ8-ADC40J5AN
IC Certification: 5074A-ADC40J5KN

1. Equipment Under Test : DISPLAY CAR SYSTEM
2. Model Name : FCC: ADC40J5AN
IC: ADC40J5KN
3. Variant Model Name(s) : Refer to the page 4
4. Applicant : Hyundai Mobis Co., Ltd.
5. Manufacturer : Hyundai Mobis Co., Ltd.
6. Date of Receipt : 2020.01.30
7. Date of Test(s) : 2020.02.17 ~ 2020.03.06
8. Date of Issue : 2020.03.18

In the configuration tested, the EUT complied with the standards specified above. This test report does not assure KOLAS accreditation.

- 1) The results of this test report are effective only to the items tested.
- 2) The SGS Korea is not responsible for the sampling, the results of this test report apply to the sample as received.

Tested by:



Jinhyoung Cho

Technical
Manager:

Jungmin Yang

SGS Korea Co., Ltd. Gunpo Laboratory



SGS Korea Co., Ltd.

4, LS-ro 182beon-gil, Gunpo-si, Gyeonggi-do, Korea, 15807
Tel. +82 31 428 5700 / Fax. +82 31 427 2370
<http://www.sgsgroup.kr>

Report Number: F690501-RF-RTL000410

Page: 2 of 16

INDEX

<u>Table of contents</u>	Page
1. General Information -----	3
2. DFS (Dynamic Frequency Selection)-----	7

1. General Information

1.1. Testing Laboratory

SGS Korea Co., Ltd. (Gunpo Laboratory)

- 10-2, LS-ro 182beon-gil, Gunpo-si, Gyeonggi-do, Korea, 15807
- 4, LS-ro 182beon-gil, Gunpo-si, Gyeonggi-do, Korea, 15807
- Designation number: KR0150

All SGS services are rendered in accordance with the applicable SGS conditions of service available on request and accessible at <http://www.sgs.com/en/Terms-and-Conditions.aspx>.

Phone No. : +82 31 688 0901

Fax No. : +82 31 688 0921

1.2. Details of Applicant

Applicant : Hyundai Mobis Co., Ltd.

Address : 203, Teheran-ro, Gangnam-gu, Seoul, South Korea, 135-977

Contact Person : Choe, Seung-hoon

Phone No. : +82 31 260 0098

1.3. Details of Manufacturer

Company : Same as applicant

Address : Same as applicant

1.4. Description of EUT

Kind of Product	DISPLAY CAR SYSTEM
FCC Model Name	ADC40J5AN
IC Model Name	ADC40J5KN
FCC Variant Model Names	ADC11J5GG, ADC10J5GN, ADC10J5GL, ADC10J5BB, ADC12J5GP, ADC12J5MG, ADC10J5EG, ADC10J5EP, ADC10J5GG, ADC11J5EP, ADC12J5EP, ADCC0J5EP, ADC10J5UX, ADC40J5KN, ADC10J5RP, ADC20J5FN, ADC12J5GG
Power Supply	DC 14.4 V
Frequency Range	5 180 MHz ~ 5 240 MHz (Band 1: 11a/n_HT20, 11ac_VHT20) 5 190 MHz ~ 5 230 MHz (Band 1: 11n_HT40, 11ac_VHT40) 5 210 MHz (Band 1: 11ac_VHT80) 5 260 MHz ~ 5 320 MHz (Band 2A: 11a/n_HT20, 11ac_VHT20) 5 270 MHz ~ 5 310 MHz (Band 2A: 11n_HT40, 11ac_VHT40) 5 290 MHz (Band 2A: 11ac_VHT80) 5 500 MHz ~ 5 720 MHz (Band 2C: 11a/n_HT20, 11ac_VHT20) 5 510 MHz ~ 5 710 MHz (Band 2C: 11n_HT40, 11ac_VHT40) 5 530 MHz ~ 5 690 MHz (Band 2C: 11ac_VHT80) 5 745 MHz ~ 5 825 MHz (Band 3: 11a/n_HT20, 11ac_VHT20) 5 755 MHz ~ 5 795 MHz (Band 3: 11n_HT40, 11ac_VHT40) 5 775 MHz (Band 3: 11ac_VHT80)
Modulation Technique	OFDM
Number of Channels	4 channels (Band 1: 11a/n_HT20, 11ac_VHT20) 2 channels (Band 1: 11n_HT40, 11ac_VHT40) 1 channel (Band 1: 11ac_VHT80) 4 channels (Band 2A: 11a/n_HT20, 11ac_VHT20) 2 channels (Band 2A: 11n_HT40, 11ac_VHT40) 1 channel (Band 2A: 11ac_VHT80) 9 channels (Band 2C: 11a/n_HT20, 11ac_VHT20) 4 channels (Band 2C: 11n_HT40, 11ac_VHT40) 2 channels (Band 2C: 11ac_VHT80) 5 channels (Band 3: 11a/n_HT20, 11ac_VHT20) 2 channels (Band 3: 11n_HT40, 11ac_VHT40) 1 channel (Band 3: 11ac_VHT80)
Antenna Type	Pattern antenna
Antenna Gain	5 150 MHz ~ 5 250 MHz: -0.61 dB i 5 250 MHz ~ 5 350 MHz: -0.18 dB i 5 470 MHz ~ 5 725 MHz: -0.77 dB i 5 725 MHz ~ 5 850 MHz: -0.18 dB i

1.5. Declaration by the Manufacturer

- The EUT is a slave without radar detection and TPC.
- The EUT is not supported TDWR(5.6 - 5.65 GHz) band.

1.6. Test Equipment List

Equipment	Manufacturer	Model	S/N	Cal. Date	Cal. Interval	Cal. Due
Signal Generator	R&S	SMBV100A	255834	Jun. 10, 2019	Annual	Jun. 10, 2020
Spectrum Analyzer	R&S	FSV30	103102	Jun. 05, 2019	Annual	Jun. 05, 2020
Attenuator	AEROFLEX / INMET	18N-20dB	3	Feb. 17, 2020	Annual	Feb. 17, 2021
Power Splitter	Mini-Circuits	ZFSC-2-10G	001	Jun. 07, 2019	Annual	Jun. 07, 2020
Power Splitter	Mini-Circuits	ZFRSC-123-S+	SF186401202	Feb. 17, 2020	Annual	Feb. 17, 2021
DC Power Supply	R&S	HMP2020	020089489	May 21, 2019	Annual	May 21, 2020

► Support Equipment

Description	Manufacturer	Model	FCC ID
Access Point	Aerohive networks Inc.	AP650X	WBV-AP650X
Notebook	LG Electronics Inc.	LGE-DMLGA51	-

1.7. Summary of Test Result

The EUT has been tested according to the following specifications:

APPLIED STANDARD: FCC Part 15 Subpart E, IC RSS-247 Issue 2			
Section in FCC	Section in IC	Test Item	Result
15.407(h)	RSS-247 Issue 2 6.3	DFS -Channel closing transmission time -Channel move time -Non occupied period	Complied

1.8. Test Report Revision

Revision	Report Number	Date of Issue	Description
0	F690501-RF-RTL000410	2020.03.18	Initial

1.9. Information of Variant Models

Model Names			Description								
			AMP	USB	BT WIFI	HD	DAB	FM Frequency Range	FM Channel Space	AM Frequency Range	AM Channel Space
Basic Model	FCC	ADC40J5AN	Ex.	O	BT WIFI	O	X	87.5 ~ 107.9 MHz	200 kHz	530 ~ 1 710 kHz	10 kHz
Variant Models	FCC	ADC11J5GG	Ex.	O	BT WIFI	X	X	87.5 ~ 108.0 MHz	100 kHz	531 ~ 1 602 kHz	9 kHz
		ADC10J5GN	Ex.	O	BT WIFI	X	X	87.5 ~ 107.9 MHz	200 kHz	530 ~ 1 710 kHz	10 kHz
		ADC10J5GL	Ex.	O	BT WIFI	X	X	87.5 ~ 107.9 MHz	100 kHz	530 ~ 1 710 kHz	10 kHz
		ADC10J5BB	Ex.	O	BT WIFI	X	X	76.1 ~ 107.9 MHz	100 kHz	530 ~ 1 710 kHz	10 kHz
		ADC12J5GP	Ex.	O	BT WIFI	X	X	87.5 ~ 108.0 MHz	100 kHz	522 ~ 1 620 kHz	9 kHz
		ADC12J5MG	Ex.	O	BT	X	X	87.5 ~ 108.0 MHz	100 kHz	531 ~ 1 602 kHz	9 kHz
		ADC10J5EG	Ex.	O	BT WIFI	X	X	87.5 ~ 108.0 MHz	100 kHz	531 ~ 1 602 kHz	9 kHz
		ADC10J5EP	Ex.	O	BT WIFI	X	X	87.5 ~ 108.0 MHz	100 kHz	522 ~ 1 620 kHz	9 kHz
		ADC10J5GG	Ex.	O	BT WIFI	X	X	87.5 ~ 108.0 MHz	100 kHz	531 ~ 1 602 kHz	9 kHz
		ADC11J5EP	Ex.	O	BT WIFI	X	X	87.5 ~ 108.0 MHz	100 kHz	522 ~ 1 620 kHz	9 kHz
		ADC12J5EP	Ex.	O	BT	X	X	87.5 ~ 108.0 MHz	100 kHz	522 ~ 1 620 kHz	9 kHz
		ADCC0J5EP	Ex.	O	BT WIFI	X	O	87.5 ~ 108.0 MHz	100 kHz	522 ~ 1 620 kHz	9 kHz
		ADC10J5UX	Ex.	O	BT WIFI	X	X	87.5 ~ 108.0 MHz	100 kHz	531 ~ 1 701 kHz	9 kHz
		ADC40J5KN	Ex.	O	BT WIFI	O	X	87.5 ~ 107.9 MHz	200 kHz	530 ~ 1 710 kHz	10 kHz
		ADC10J5RP	Ex.	O	BT WIFI	X	X	87.5 ~ 108.0 MHz	100 kHz	522 ~ 1 620 kHz	9 kHz
		ADC20J5FN	Ex.	O	BT WIFI	O	X	87.5 ~ 107.9 MHz	200 kHz	530 ~ 1 710 kHz	10 kHz
		ADC12J5GG	Ex.	O	BT WIFI	X	X	87.5 ~ 108.0 MHz	100 kHz	531 ~ 1 602 kHz	9 kHz

2. DFS (Dynamic Frequency Selection)

2.1. System Overview

2.1.1. Set up of EUT

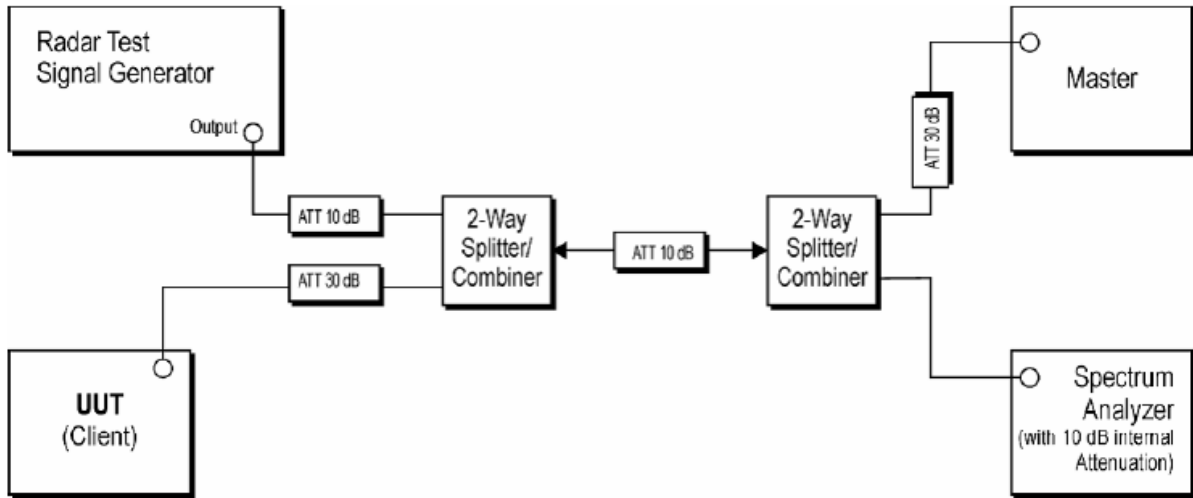

The radar signal generation equipment consists of a vector signal generator

The signal monitoring equipment consists of a spectrum analyzer set to display 8 001 bins on the horizontal axis. The time domain resolution is 2 msec/bin with a 16 second sweep time, meeting the 10 second short pulse reporting criteria. The aggregate ON time is calculated by multiplying the number of bins above a threshold during a particular observation period by the dwell time per bin, with the analyzer set to peak detection and max hold.

The Slave is tested separately for compliance with the Channel Shutdown requirements, for the situation when the Slave device vacates the channel in response to detection of a radar by the Master.

All tests were performed at a channel center frequency of 5 290 MHz and 5 530 MHz. Measurements were performed using conducted test methods.

2.2. Limit

§15.407(h) and FCC 06-96 APPENDIX “COMPLIANCE MEASUREMENT PROCEDURES FOR UNLICENSED-NATIONAL INFORMATION INFRASTRUCTURE DEVCIES OPERATING IN THE 5 250-5 350 MHz AND 5 470-5 725 MHz BANDS INCORPORATING DYNAMIC FREQUENCY SELECTION

RSS-247 Issue 2, 6.3 AND FCC 06-96 APPENDIX “COMPLIANCE MEASUREMENT PROCEDURES FOR UNLICENSED-NATIONAL INFORMATION INFRASTRUCTURE DEVCIES OPERATING IN THE 5 250-5 350 MHz AND 5 470-5 725 MHz BANDS INCORPORATING DYNAMIC FREQUENCY SELECTION”

Industry Canada requires the use of either the FCC KDB Procedure 905462 or the procedure in the ETSI EN 301 893 for demonstrating compliance with the DFS radar detection requirements set out in this section.

Table 1: Applicability of DFS Requirements Prior to Use of a Channel

Requirement	Operational Mode		
	Master	Client Without Radar Detection	Client With Radar Detection
Non-Occupancy Period	Yes	Not required	Yes
DFS Detection Threshold	Yes	Not required	Yes
Channel Availability Check Time	Yes	Not required	Not required
U-NII Detection Bandwidth	Yes	Not required	Yes

Table 2: Applicability of DFS requirements during normal operation

Requirement	Operational Mode	
	Master Device or Client with Radar Detection	Client Without Rader Detection
DFS Detection Threshold	Yes	Not required
Channel Closing Transmission Time	Yes	Yes
Channel Move Time	Yes	Yes
U-NII Detection Bandwidth	Yes	Not required

Additional requirement for devices with multiple bandwidth modes	Master Device or Client with Radar Detection	Client Without Radar Detection
U-NII Detection Bandwidth and Statistical Performance Check	All BT modes must be tested	Not required
Channel Move Time and Channel Closing Transmission Time	Test using widest BT mode available	Test using the widest BW mode available for the link
All other tests	Any single BW mode	Not required
Note: Frequencies selected for statistical performance check (Section 7.8.4) should include several frequencies within the radar detection bandwidth and frequencies near the edge of the radar detection bandwidth. For 802.11 devices it is suggested to select frequencies in each of the bonded 20 MHz channels and the channel center frequency.		

Table 3: DFS Detection Thresholds for Master Devices and Client Devices with Radar Detection

Maximum Transmit Power	Value (See Note 1, 2, and 3)
EIRP \geq 200 milliwatt	-64 dB m
EIRP < 200 milliwatt and power spectral density < 10 dB m/MHz	-62 dB m
EIRP < 200 milliwatt that do not meet the power spectral density requirement	-64 dB m
Note 1: This is the level at the input of the receiver assuming a 0 dB i receive antenna. Note 2: Throughout these test procedures an additional 1 dB has been added to the amplitude of the test transmission waveforms to account for variations in measurement equipment. This will ensure that the test signal is at or above the detection threshold level to trigger a DFS response. Note 3: EIRP is based on the highest antenna gain. For MIMO devices refer to KDB Publication 662911 D01.	

KDB 905462 D03 Client without DFS New Rules v01r02: UNII client devices without radar detection

- The guidance provided in Section 8 (DFS Test Report Guidelines) in the appropriate DFS Test Procedure specified in KDB Publication 905462 D02.
- Test results demonstrating an associated client link is established with the master on a test frequency; if a client device operates in a “listen only” mode to a master without formally “associating” with it the test report must include tests for such modes.
- The devices must be tested with a master device operating in the same band and operation modes.
- If two client devices can communicate directly with each other while maintaining an association with a master or if the client operates on a frequency band while “listening” to a master, such modes must be tested with the master device active.
- The client and DFS-certified master device are associated, and a movie can be streamed as specified in the DFS Order for a non-occupancy period test.
- The test frequency has been monitored to ensure no transmission of any type has occurred for 30 minutes. Note: If the client moves with the master, the device is considered compliant if nothing appears in the client non-occupancy period test. For devices that shut down (rather than moving channels), no beacons should appear.
- An analyzer plot that contains a single 30-minute sweep on the original channel.

Table 4: DFS Response Requirement Values

Parameter	Value
Non-occupancy period	Minimum 30 minutes
Channel Availability Check Time	60 seconds
Channel Move Time	10 seconds See Note 1.
Channel Closing Transmission Time	200 milliseconds + an aggregate of 60 milliseconds over remaining 10 second period. See Notes 1 and 2.
U-NII Detection Bandwidth	Minimum 100 % of the U-NII 99 % transmission power bandwidth. See Note 3.

Note 1: Channel Move Time and the Channel Closing Transmission Time should be performed with Radar Type 0. The measurement timing begins at the end of the Radar Type 0 burst.

Note 2: The Channel Closing Transmission Time is comprised of 200 milliseconds starting at the beginning of the Channel Move Time plus any additional intermittent control signals required to facilitate a Channel move (an aggregate of 60 milliseconds) during the remainder of the 10 second period. The aggregate duration of control signals will not count quiet periods in between transmissions.

Note 3: During the U-NII Detection Bandwidth detection test, radar type 0 should be used. For each frequency step the minimum percentage of detection is 90 percent. Measurements are performed with no data traffic.

Table 5 – Short Pulse Radar Test Waveforms

Radar Type	Pulse Width (µsec)	PRI (µsec)	Number of Pulses	Minimum Percentage of Successful Detection	Minimum Number of Trials
0	1	1 428	18	See Note 1	See Note 1
1	1	Test A: 15 unique PRI values randomly selected from the list of 23 PRI values in Table 5a	Roundup $\left\{ \begin{matrix} \left(\frac{1}{360} \right) \\ \left(\frac{19 \cdot 10^6}{PRI_{\mu sec}} \right) \end{matrix} \right\}$	60 %	30
		Test B: 15 unique PRI values randomly selected within the range of 518-3 066 µsec, with a minimum increment of 1 µsec, excluding PRI values selected in Test A			
2	1-5	150-230	23-29	60 %	30
3	6-10	200-500	16-18	60 %	30
4	11-20	200-500	12-16	60 %	30
Aggregate (Radar Types 1-4)				80 %	120
Note 1: Short Pulse Radar Type 0 should be used for the detection bandwidth test, channel move time, and channel closing time tests.					

Table 6 – Long Pulse Radar Test Waveform

Radar Type	Pulse Width (μsec)	Chirp Width (MHz)	PRI (μsec)	Number of Pulses per Burst	Number of Burst	Minimum Percentage of Successful Detection	Minimum Number of Trials
5	50-100	5-20	1 000-2 000	1-3	8-20	80 %	30

Table 7 – Frequency Hopping Radar Test Waveform

Radar Type	Pulse Width (μsec)	PRI (μsec)	Pulses per Hop	Hopping Rate (kHz)	Hopping Sequence Length (msec)	Minimum Percentage of Successful Detection	Minimum Number of Trials
6	1	333	9	0.333	300	70 %	30

2.3. Description of EUT

The EUT operates over the band 2A “5 260 MHz ~ 5 320 MHz (11a/n_HT20, 11ac_VHT20), 5 270 MHz ~ 5 310 MHz (11n_HT40, 11ac_VHT40), 5 290 MHz (11ac_VHT80)” and band 2C “5 500 MHz ~ 5 720 MHz (11a/n_HT20, 11ac_VHT20), 5 510 MHz ~ 5 710 MHz (11n_HT40, 11ac_VHT40), 5 530 MHz ~ 5 690 MHz (11ac_VHT80)” ranges.

The rated output power of the client unit is < 200 milliwatt.
 Therefore the required interference threshold level is -62 dB m.

Plot of radar waveform type 0

11ac_VHT80

5 290 MHz

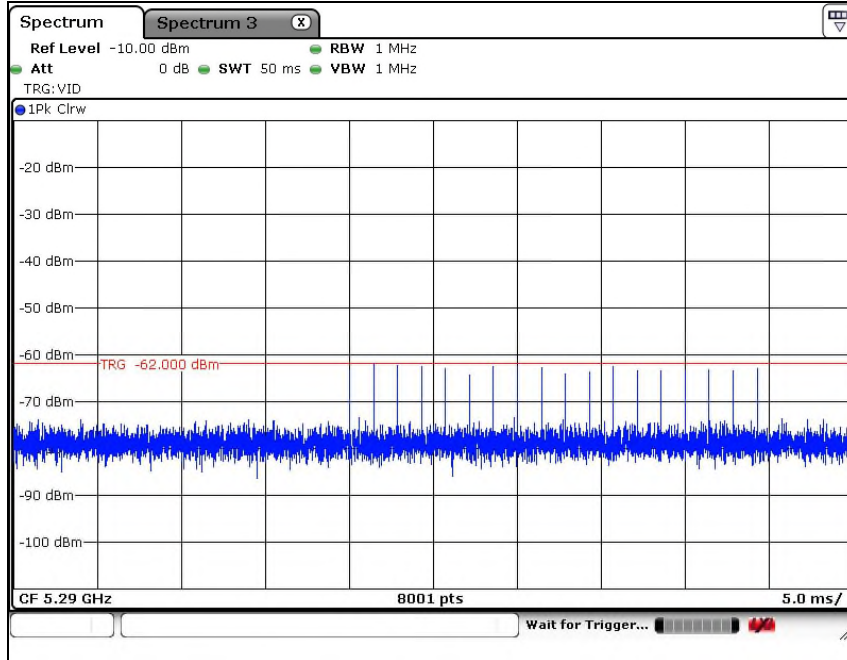

5 530 MHz

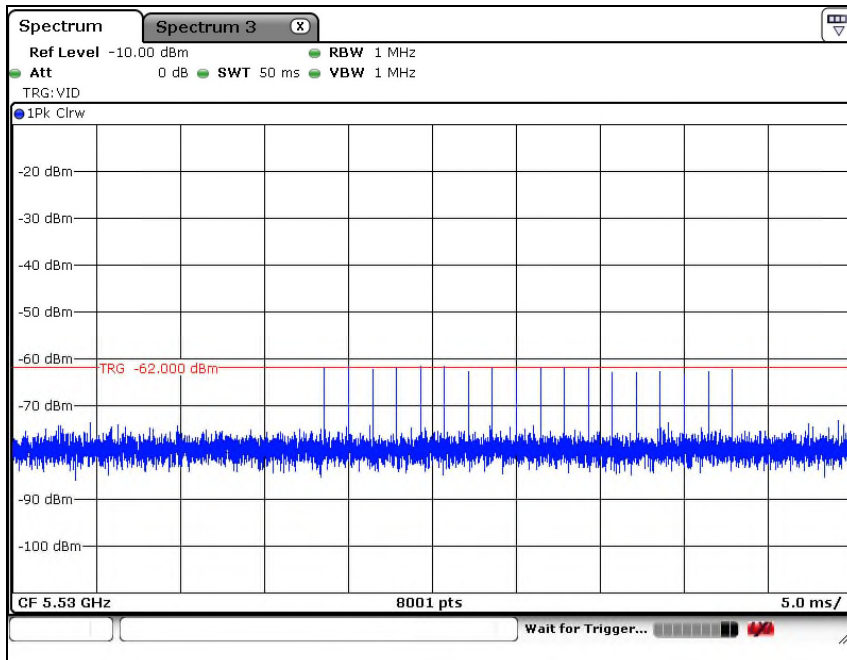

Plot of LAN traffic

11ac_VHT80

5 290 MHz

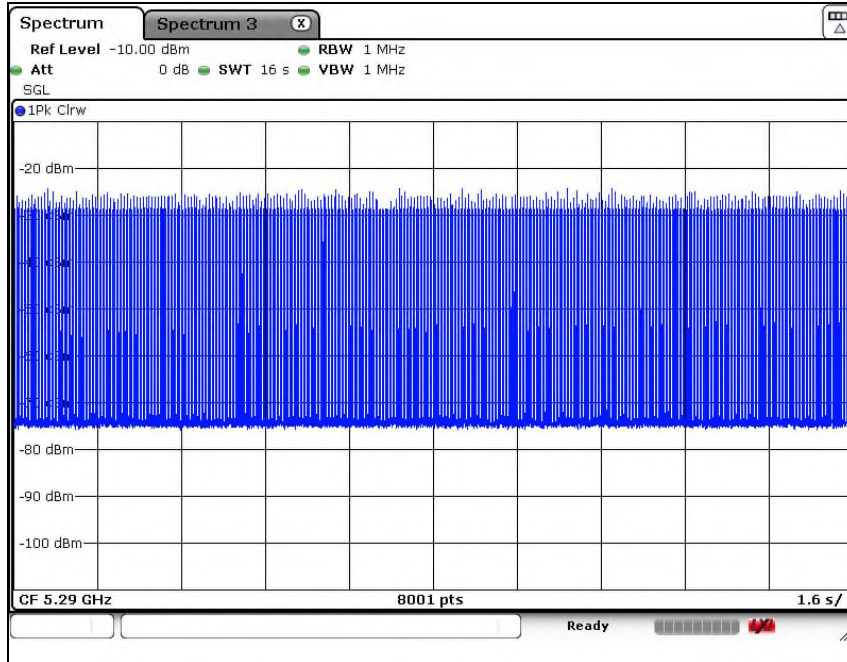

5 530 MHz

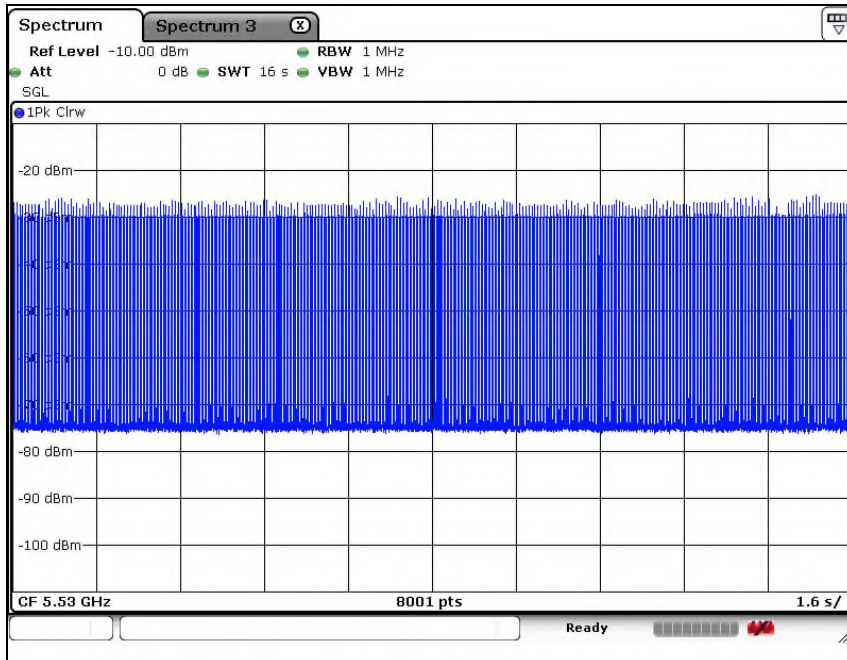

The reference maker is set after 200 ms from the end of Last radar pulse.

The delta is set at the end of the last WLAN transmission following the radar pulse. This delta is the channel move time within the 10 sec form the end of Last radar pulse.

The aggregate channel closing transmission time is calculated as follows:

Aggregate Transmission Time = (Number of analyzer bins showing transmission)*(dwell time per bin)

The observation period over which the aggregated time is calculated begins at (Reference Maker) and ends no earlier than (Reference Maker +10 sec)

2.4. Test Result

Frequency (MHz)	Channel Move Time (sec)	Limit
5 290	0.794	Not exceed 10 sec
5 530	0.880	
Frequency (MHz)	Aggregate channel closing transmission time (msec)	Limit
5 290	12	Not exceed 60 msec
5 530	16	

Aggregate channel closing transmission time

$[16s \text{ (sweep time)} / 8\,001 \text{ (sweep point)}] \times \text{The number of channel bin from } 200 \text{ ms at the end of radar pulse.}$

5 290 MHz: $(16 / 8\,001) \times 6 = 12 \text{ ms}$

5 530 MHz: $(16 / 8\,001) \times 8 = 16 \text{ ms}$

Frequency (MHz)	Non-occupancy period (min)	Limit
5 290	Above 30	Not be less than 30 minute
5 530	Above 30	

Plot of channel move time & aggregate channel closing transmission time

11ac_VHT80

5 290 MHz

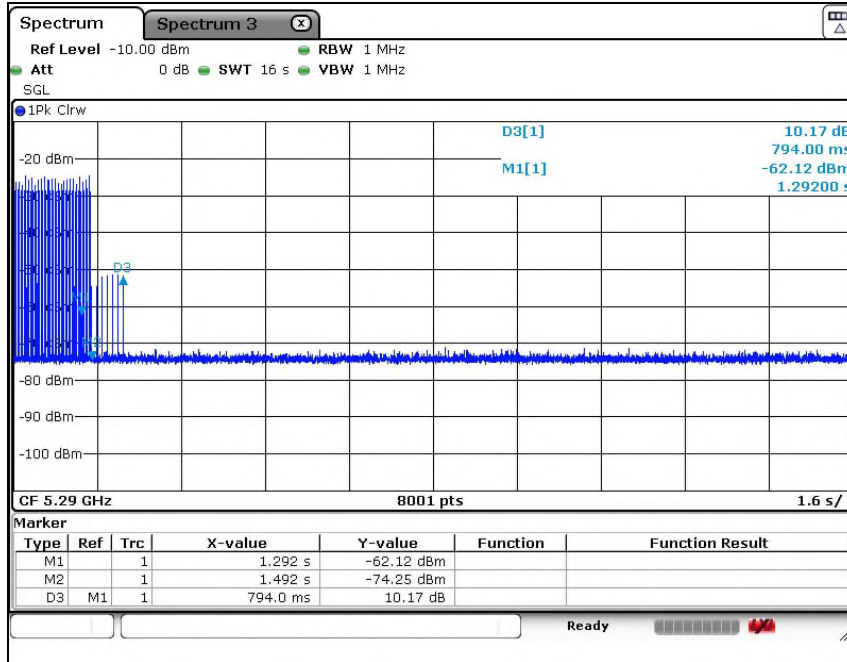

5 530 MHz

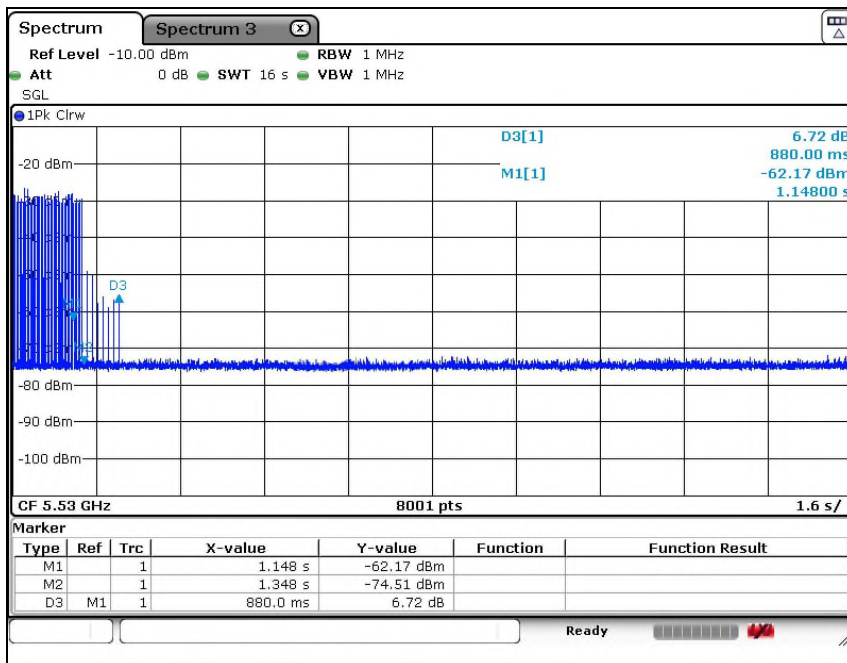

Plot of Non-occupancy period

11ac_VHT80
 5 290 MHz

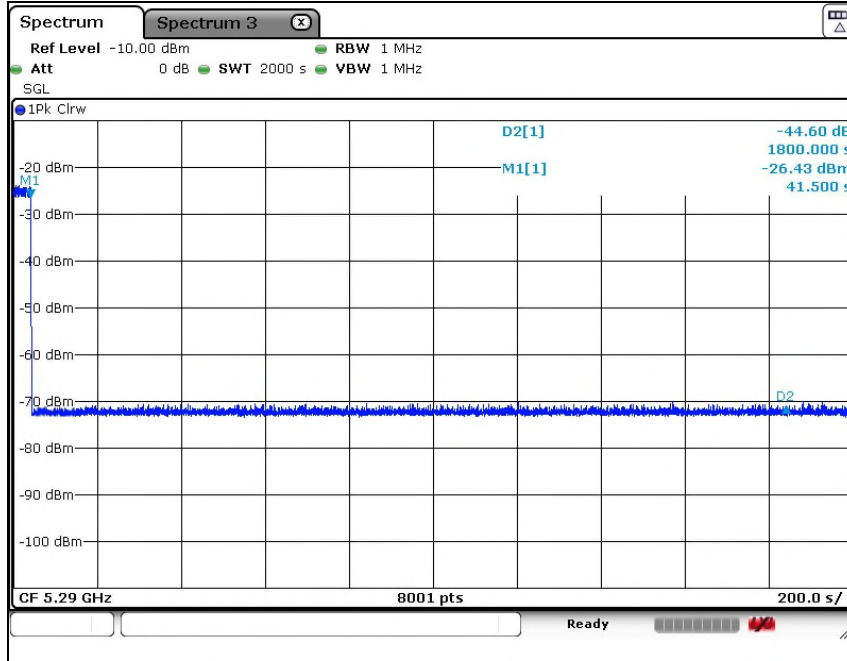

5 530 MHz

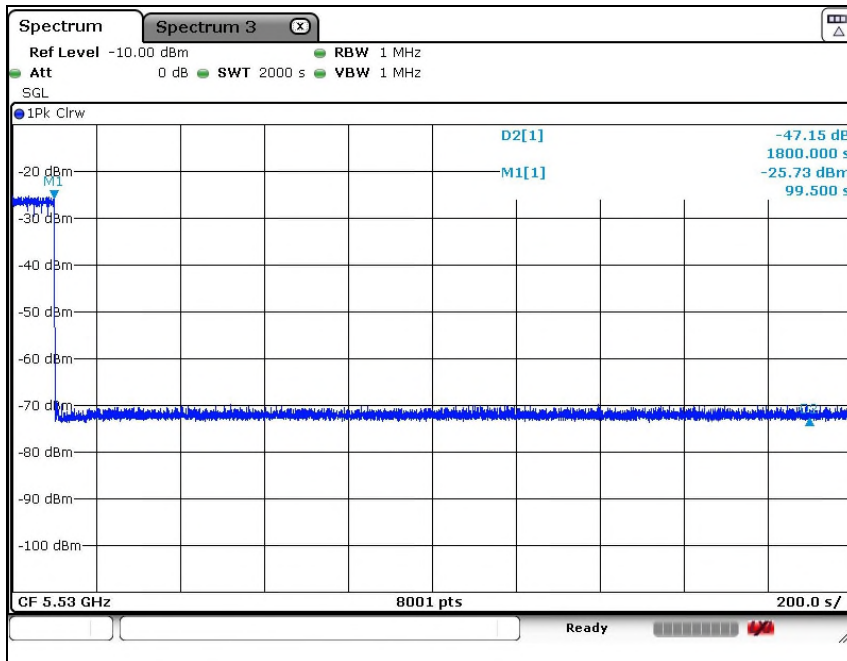

- End of the Test Report -