

TEST REPORT

of

FCC Part 15 Subpart C §15.247
IC RSS-247 Issue 2 and RSS-Gen Issue 5

FCC ID: TQ8-ADB40GWAN
IC Certification: 5074A-ADB40GWKN

1. Equipment Under Test : DISPLAY CAR SYSTEM
2. Model Name : FCC: ADB40GWAN
IC: ADB40GWKN
3. Variant Model Name(s) : Refer to the page 3
4. Applicant : Hyundai Mobis Co., Ltd.
5. Manufacturer : Hyundai Mobis Co., Ltd.
6. Date of Receipt : 2020.03.26
7. Date of Test(s) : 2020.04.03 ~ 2020.05.26
8. Date of Issue : 2020.06.09

In the configuration tested, the EUT complied with the standards specified above. This test report does not assure KOLAS accreditation.

- 1) The results of this test report are effective only to the items tested.
- 2) The SGS Korea is not responsible for the sampling, the results of this test report apply to the sample as received.

Tested by:

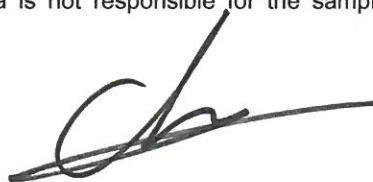

Jinhyoung Cho

Technical
Manager:



Jungmin Yang

SGS Korea Co., Ltd. Gunpo Laboratory

INDEX

<u>Table of Contents</u>	Page
1. General Information -----	3
2. Transmitter Radiated Spurious Emissions and Conducted Spurious Emission -----	11
3. 20 dB Bandwidth & 99 % Bandwidth -----	32
4. Maximum Peak Conducted Output Power -----	41
5. Carrier Frequency Separation -----	43
6. Number of Hopping Frequencies -----	46
7. Time of Occupancy(Dwell Time) -----	50
8. Antenna Requirement -----	64

1. General Information

1.1. Testing Laboratory

SGS Korea Co., Ltd. (Gunpo Laboratory)

- 10-2, LS-ro 182beon-gil, Gunpo-si, Gyeonggi-do, Korea, 15807
- 4, LS-ro 182beon-gil, Gunpo-si, Gyeonggi-do, Korea, 15807
- Designation number: KR0150

All SGS services are rendered in accordance with the applicable SGS conditions of service available on request and accessible at <http://www.sgs.com/en/Terms-and-Conditions.aspx>.

Phone No. : +82 31 688 0901

Fax No. : +82 31 688 0921

1.2. Details of Applicant

Applicant : Hyundai Mobis Co., Ltd.

Address : 203, Teheran-ro, Gangnam-gu, Seoul, South Korea, 135-977

Contact Person : Choe, Seung-hoon

Phone No. : +82 31 260 0098

1.3. Details of Manufacturer

Company : Same as applicant

Address : Same as applicant

1.4. Description of EUT

Kind of Product	DISPLAY CAR SYSTEM
FCC Model Name	ADB40GWAN
IC Model Name	ADB40GWKN
FCC Variant Model Names	ADB10GWGG, ADB10GWDG, ADB11GWGG, ADB10GWGN, ADB10GWEG, ADB10GWEP, ADB11GWEP, DAB50GWRP, ADB10GWUG, ADB10GWAN, DA350GWAN, ADB10GTEG, ADB10GTPE, ADB10GTEL, ADB10JFEP, ADB11JFEP, ADB12JFEP, ADB13JFEP, ADB14JFEP, ADB15JFEP
IC Variant Model Name	ADB10GWKN
Serial Number	Conducted Sample: 001 Radiated Sample: 002
Power Supply	DC 14.4 V
Frequency Range	2 402 MHz ~ 2 480 MHz (Bluetooth)
Modulation Technique	GFSK, $\pi/4$ DQPSK, 8DPSK
Number of Channels	79 channels (Bluetooth)
Antenna Type	Pattern antenna
Antenna Gain	-0.18 dB i
H/W Version	1.0
S/W Version	1.0

1.5. Test Equipment List

Equipment	Manufacturer	Model	S/N	Cal. Date	Cal. Interval	Cal. Due
Signal Generator	R&S	SMR40	100272	Jun. 07, 2019	Annual	Jun. 07, 2020
Signal Generator	R&S	SMBV100A	255834	Jun. 10, 2019	Annual	Jun. 10, 2020
Spectrum Analyzer	R&S	FSV30	103101	Jun. 05, 2019	Annual	Jun. 05, 2020
Spectrum Analyzer	Agilent	N9030A	US51350132	Nov. 15, 2019	Annual	Nov. 15, 2020
Bluetooth Tester	TESCOM	TC-3000C	3000C000296	Jun. 05, 2019	Annual	Jun. 05, 2020
Directional Coupler	KRYTAR	152613	140972	Jun. 12, 2019	Annual	Jun. 12, 2020
High Pass Filter	Wainwright Instrument GmbH	WHK3.0/18G-10SS	344	May 18, 2020	Annual	May 18, 2021
High Pass Filter	Wainwright Instrument GmbH	WHNX7.5/26.5G-6SS	15	Jun. 07, 2019	Annual	Jun. 07, 2020
Low Pass Filter	Mini-Circuits	NLP-1200+	V 9500401023-2	Jun. 05, 2019	Annual	Jun. 05, 2020
Power Sensor	R&S	NRP-Z81	100418	Feb. 17, 2020	Annual	Feb. 17, 2021
DC Power Supply	Agilent	U8002A	MY53150029	Jun. 10, 2019	Annual	Jun. 10, 2020
Preamplifier	H.P.	8447F	2944A03909	Aug. 07, 2019	Annual	Aug. 07, 2020
Signal Conditioning Unit	R&S	SCU-18	10117	Jun. 12, 2019	Annual	Jun. 12, 2020
Preamplifier	MITEQ Inc.	JS44-18004000-35-8P	1546891	May 08, 2020	Annual	May 08, 2021
Loop Antenna	Schwarzbeck Mess-Elektronik	FMZB 1519	1519-039	Aug. 22, 2019	Biennial	Aug. 22, 2021
Bilog Antenna	Schwarzbeck Mess-Elektronik	VULB 9163	396	Mar. 21, 2019	Biennial	Mar. 21, 2021
Horn Antenna	R&S	HF906	100326	Feb. 14, 2020	Annual	Feb. 14, 2021
Horn Antenna	Schwarzbeck Mess-Elektronik	BBHA 9170	BBHA9170431	Sep. 10, 2018	Biennial	Sep. 10, 2020
Test Receiver	R&S	ESU26	100109	Feb. 18, 2020	Annual	Feb. 18, 2021
Turn Table	Innco systems GmbH	DS 1200 S	N/A	N.C.R.	N/A	N.C.R.
Controller	Innco systems GmbH	CONTROLLER CO3000-4P	CO3000/963/383 30516/L	N.C.R.	N/A	N.C.R.
Antenna Mast	Innco systems GmbH	MA4640-XP-ET	MA4640/536/383 30516/L	N.C.R.	N/A	N.C.R.
Anechoic Chamber	SY Corporation	L x W x H (9.6 m x 6.4 m x 6.6 m)	N/A	N.C.R.	N/A	N.C.R.
Coaxial Cable	SUCOFLEX	104 (3 m)	MY3258414	Jan. 28, 2020	Semi-annual	Jul. 28, 2020
Coaxial Cable	SUCOFLEX	104 (10 m)	MY3145814	Jan. 28, 2020	Semi-annual	Jul. 28, 2020
Coaxial Cable	Rosenberger	LA1-C006-1500	131014 01/20	Feb. 23, 2020	Semi-annual	Aug. 23, 2020
Coaxial Cable	Rosenberger	LA1-C006-1500	131014 05/20	Feb. 23, 2020	Semi-annual	Aug. 23, 2020
Coaxial Cable	Rosenberger	LA1-C006-1500	131014 10/20	Feb. 23, 2020	Semi-annual	Aug. 23, 2020

Note;

Operating software of EUT has integrated test interface. No additional software was used.

1.6. Declaration by the Manufacturer

- Adaptive Frequency Hopping is supported and use at least 20 channels.

1.7. Information about the FHSS characteristics:

1.7.1. Pseudorandom Frequency Hopping Sequence

The channel is represented by a pseudo-random hopping sequence hopping through the 79 RF channels. The hopping sequence is unique for the piconet and is determined by the Bluetooth device address of the master; the phase in the hopping sequence is determined by the Bluetooth clock of the master. The channel is divided into time slots where each slot corresponds to an RF hop frequency. Consecutive hops correspond to different RF hop frequencies. The nominal hop rate is 1 600 hops/s.

1.7.2. Equal Hopping Frequency Use

The channels of this system will be used equally over the long-term distribution of the hopsets.

1.7.3. Example of a 79 hopping sequence in data mode:

02, 05, 31, 24, 20, 10, 43, 36, 30, 23, 40, 06, 21, 50, 44, 09, 71, 78, 01, 13, 73, 07, 70, 72, 35, 62, 42, 11, 41, 08, 16, 29, 60, 15, 34, 61, 58, 04, 67, 12, 22, 53, 57, 18, 27, 76, 39, 32, 17, 77, 52, 33, 56, 46, 37, 47, 64, 49, 45, 38, 69, 14, 51, 26, 79, 19, 28, 65, 75, 54, 48, 03, 25, 66, 05, 16, 68, 74, 59, 63, 55

1.7.4. System Receiver Input Bandwidth

Each channel bandwidth is 1 MHz.

The system receivers have input bandwidths that match the hopping channel bandwidths of their corresponding transmitters and shift frequencies in synchronization with the transmitted signals.

1.7.5. Equipment Description

15.247(a)(1) that the Rx input bandwidths shift frequencies in synchronization with the transmitted signals.

15.247(g): In accordance with the Bluetooth Industry Standard, the system is designed to comply with all of the regulations in Section 15.247 when the transmitter is presented with a continuous data (or information) system.

15.247(h): In accordance with the Bluetooth Industry Standard, the system does not coordinate its channels selection/ hopping sequence with other frequency hopping systems for the express purpose of avoiding the simultaneous occupancy of individual hopping frequencies by multiple transmitters.

1.8. Summary of Test Results

The EUT has been tested according to the following specifications:

APPLIED STANDARD: FCC Part15 Subpart C, IC RSS-247 Issue 2 and RSS-Gen Issue 5			
Section in FCC	Section in IC	Test Item(s)	Result
15.205(a) 15.209 15.247(d)	RSS-247 Issue 2 5.5 RSS-Gen Issue 5 8.9	Transmitter Radiated Spurious Emissions and Conducted Spurious Emission	Complied
15.247(a)(1)	RSS-247 Issue 2 5.1(b) RSS-Gen Issue 5 6.7	20 dB Bandwidth and 99 % Bandwidth	Complied
15.247(a)(1) 15.247(b)(1)	RSS-247 Issue 2 5.1(b) 5.4(b)	Maximum Peak Conducted Output Power	Complied
15.247(a)(1)	RSS-247 Issue 2 5.1(b)	Carrier Frequency Separation	Complied
15.247(a)(1)(iii)	RSS-247 Issue 2 5.1(d)	Number of Hopping Frequencies	Complied
15.247(a)(1)(iii)	RSS-247 Issue 2 5.1(d)	Time of Occupancy (Dwell Time)	Complied
15.207	RSS-Gen Issue 5 8.8	AC Power Line Conducted Emission	N/A ¹⁾

Note;

1) The AC power line test was not performed because the EUT use battery power for operation and which do not operate from the AC power lines.

1.9. Test Procedure(s)

The measurement procedures described in the American National Standard of Procedure for Compliance Testing of unlicensed Wireless Devices (ANSI C63.10-2013) and the guidance provided in KDB 558074 D01 15.247 Meas Guidance v05r02 were used in the measurement of the DUT.

1.10. Sample Calculation

Where relevant, the following sample calculation is provided:

1.10.1. Conducted Test

Offset value (dB) = Directional coupler (dB) + Cable loss (dB)

1.10.2. Radiation Test

Field strength level (dB_{μV}/m) = Measured level (dB_{μV}) + Antenna factor (dB) + Cable loss (dB) - Amplifier gain (dB) + Duty Factor (dB)

1.11. Test Report Revision

Revision	Report Number	Date of Issue	Description
0	F690501-RF-RTL000749	2020.06.09	Initial

1.12. Measurement Uncertainty

Where relevant, the following measurement uncertainty levels have been estimated for tests performed on the apparatus:

Parameter	Uncertainty
RF Output Power	± 0.39 dB
Occupied Bandwidth	± 9.66 kHz
Conducted Spurious Emission	± 0.76 dB
Radiated Emission, 9 kHz to 30 MHz	± 3.59 dB
Radiated Emission, below 1 GHz	± 5.88 dB
Radiated Emission, above 1 GHz	± 5.94 dB

Uncertainty figures are valid to a confidence level of 95 %.

1.13. Information of Variant Models

Model Names			Description							
			Local	BT / WIFI / TELE	UI	RDS	DAB	SXM	HD	FM/AM Code
Basic Model	FCC	ADB40GWAN	U.S.A.	BT, WIFI, TELE	GEN	X	X	O	O	A2
	IC	ADB40GWKN	Canada	BT, WIFI, TELE	GEN	X	X	O	O	A2
Variant Models	FCC	ADB10GWGG	General	BT, WIFI	GEN	X	X	X	X	A1
		ADB10GWDG	South Korea	BT, WIFI	GEN	X	X	X	X	A1
		ADB11GWGG	General	BT, WIFI	GEN	O	X	X	X	A1
		ADB10GWGN	General	BT, WIFI	GEN	X	X	X	X	A2
		ADB10GWEG	Europe	BT, WIFI	GEN	X	X	X	X	A1
		ADB10GWEP	Europe	BT, WIFI	GEN	X	X	X	X	A8
		ADB11GWEP	Europe	BT, WIFI	GEN	O	X	X	X	A8
		DAB50GWRP	Russia	BT, WIFI	GEN	O	X	X	X	A8
		ADB10GWUG	Australia	BT, WIFI	GEN	O	X	X	X	A9
		ADB10GWAN	U.S.A.	BT, WIFI	GEN	X	X	X	O	A2
		DA350GWAN	U.S.A.	BT, WIFI	GEN	X	X	X	X	A2
		ADB10GTEG	Columbia	BT, WIFI	GEN	X	X	X	X	A5
		ADB10GTPEP	Mexico	BT, WIFI	GEN	O	X	X	O	A2
		ADB10GTEL	Europe	BT, WIFI	GEN	O	O	X	X	A8
		ADB10JFEP	Europe	BT, WIFI	HEV	X	X	X	X	A8
		ADB11JFEP	Europe	BT, WIFI	HEV	O	X	X	X	A8
		ADB12JFEP	Europe	BT, WIFI	HEV	O	O	X	X	A8
		ADB13JFEP	Europe	BT, WIFI	PHEV	X	X	X	X	A8
		ADB14JFEP	Europe	BT, WIFI	PHEV	O	X	X	X	A8
		ADB15JFEP	Europe	BT, WIFI	PHEV	O	O	X	X	A8
IC	ADB10GWKN	Canada	BT, WIFI	GEN	X	X	X	O	A2	

CODE	BAND	FREQUENCY RANGE	STEP	LOCAL
A1	FM	87.5-108.0 MHz	100 kHz	DOM/GEN
	AM	531-1 602 kHz	9 kHz	
A2	FM	87.5-107.9 MHz	200 kHz	NA/GEN
	AM	530-1 710 kHz	10 kHz	
A5	FM	87.5-107.9 MHz	100 kHz	COLOMBIA
	AM	530-1 710 kHz	10 kHz	
A8	FM	87.5-108.0 MHz	100 kHz	EU
	AM	522-1 620 kHz	9 kHz	
A9	FM	87.5-108.0 MHz	100 kHz	AU
	AM	522-1 701 kHz	9 kHz	

1.14. Descriptions of Test Mode

Preliminary tests were performed in different data rates and recorded the RF output power in the following table:

Operation Mode	Data Rate (Mbps)	Channel	Frequency (MHz)	RF Output Power (dB m)
GFSK	1	Low	2 402	1.19
		Middle	2 441	2.28
		High	2 480	<u>2.39</u>
$\pi/4$ DQPSK	2	Low	2 402	-1.01
		Middle	2 441	-0.05
		High	2 480	<u>0.05</u>
8DPSK	3	Low	2 402	-0.88
		Middle	2 441	<u>0.24</u>
		High	2 480	0.17

Note;

1. For transmitter radiated spurious emissions, conducted spurious emission, carrier frequency separation and number of hopping frequencies, GFSK / DH5 and 8DPSK / 3DH5 are tested as worst condition.
2. For 20 dB bandwidth and maximum peak conducted output power, GFSK / DH5, $\pi/4$ DQPSK / 2DH5 and 8DPSK / 3DH5 are tested as worst condition.
3. For Time of Occupancy, GFSK / DH1, DH3, DH5 and 8DPSK / 3DH1, 3DH3, 3DH5 are tested as worst condition.

1.15. Duty Cycle Correction Factor of EUT

According to KDB 558074 D01 15.247 Meas Guidance v05r02, 9, as a “duty cycle correction factor”, pulse averaging with 20 log (worst case dwell time / 100 ms) has to be used for average result.

3DH5 on time (One Pulse) Plot on Channel 39

3DH5 on time (Count Pulses) Plot on Channel 39

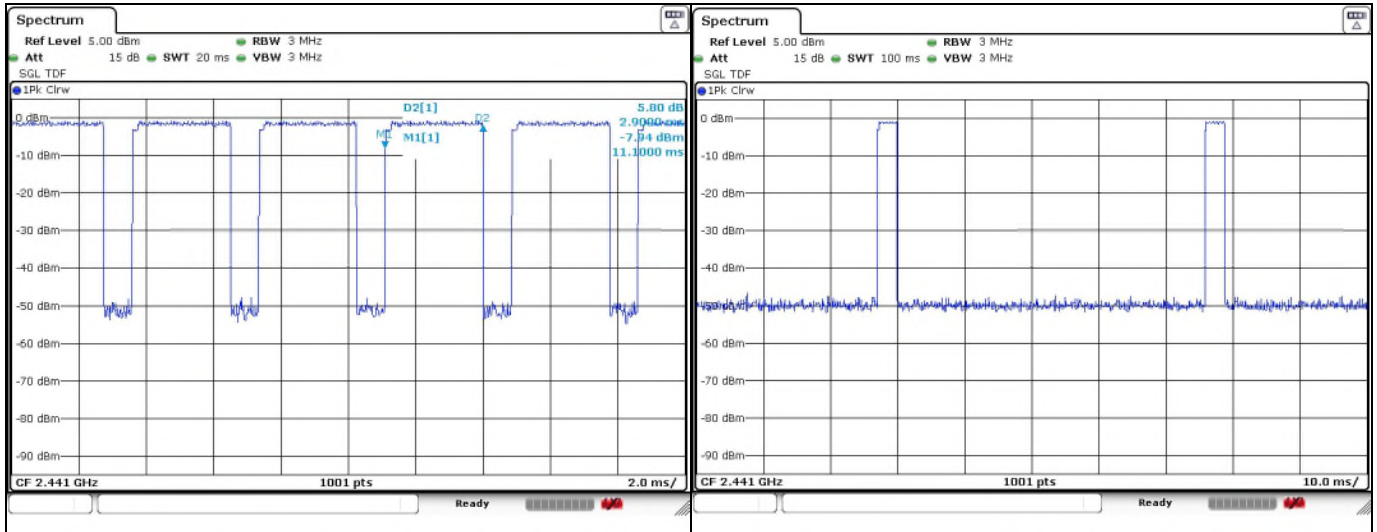

In AFH mode, the minimum hopping frequencies are 20, to get the longest dwell time 3DH5 packet is observed;
 the period to have 3/DH5 packet completing one hopping sequence is $2.90 \text{ ms} \times 20 \text{ channels} = 58.00 \text{ ms}$

There cannot be 2 complete hopping sequences within 100 ms period, considering the random hopping behavior, maximum 2 hops can be possibly observed within the period. $[100 \text{ ms} / 58.00 \text{ ms}] = 2 \text{ hops}$

Thus, the maximum possible ON time:

$$2.90 \text{ ms} \times 2 = 5.80 \text{ ms}$$

Worst case Duty Cycle Correction factor, which is derived from the maximum possible ON time:

$$20 \times \log (5.80 \text{ ms}/100 \text{ ms}) = -24.73 \text{ dB}$$

2. Transmitter Radiated Spurious Emissions and Conducted Spurious Emission

2.1. Test Setup

2.1.1. Transmitter Radiated Spurious Emissions

The diagram below shows the test setup that is utilized to make the measurements for emission from 9 kHz to 30 MHz.

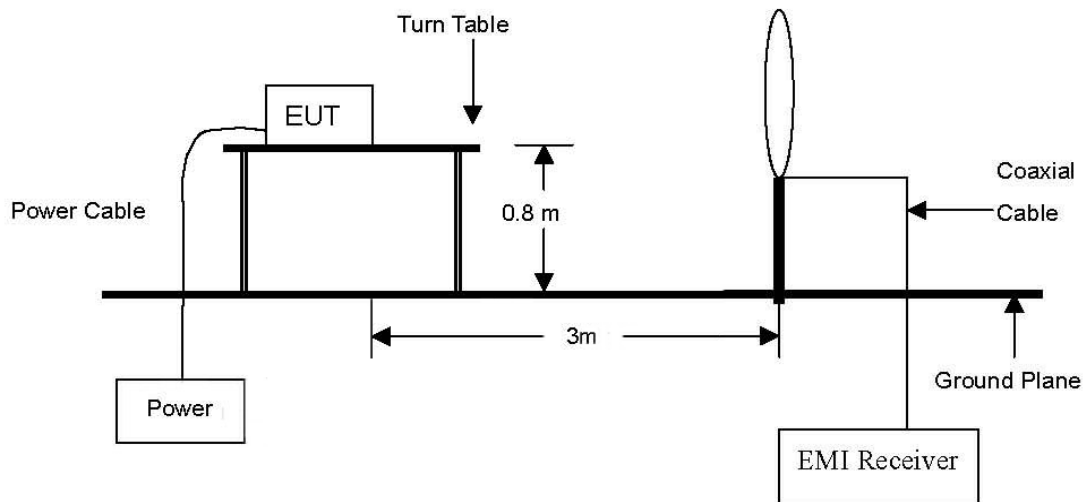

The diagram below shows the test setup that is utilized to make the measurements for emission from 30 MHz to 1 GHz.

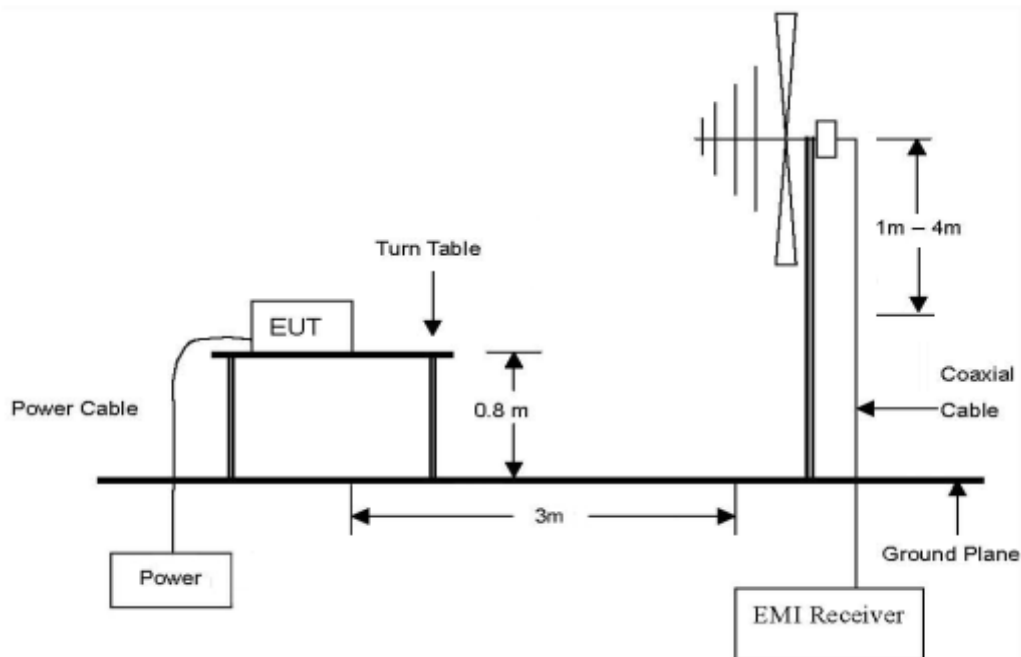

The diagram below shows the test setup that is utilized to make the measurements for emission. The spurious emissions were investigated from 1 GHz to the 10th harmonic of the highest fundamental frequency or 40 GHz, whichever is lower.

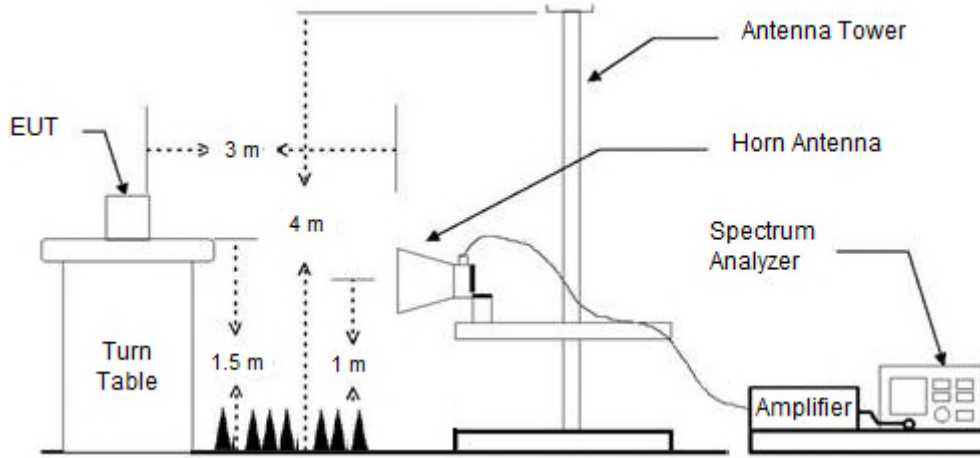

2.1.2. Conducted Spurious Emissions

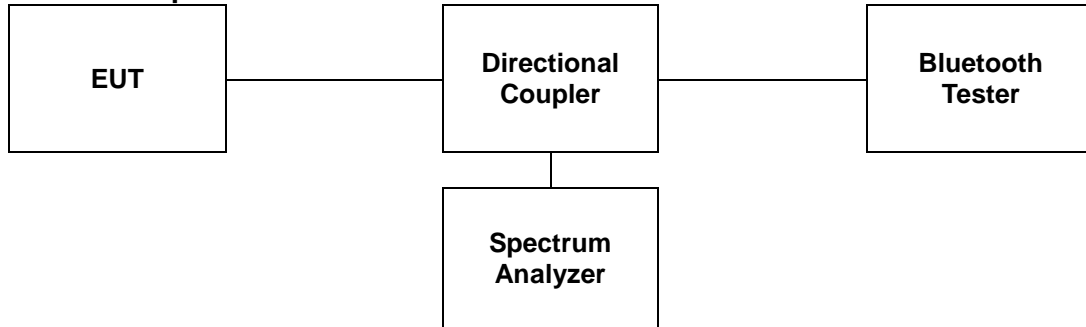

2.2. Limit

2.2.1. FCC

According to §15.247(d), in any 100 kHz bandwidth outside the frequency band in which the spread spectrum or digitally modulated intentional radiator is operating, the radio frequency power that is produced by the intentional radiator shall be at least 20 dB below that in the 100 kHz bandwidth within the band that contains the highest level of the desired power, based on either an RF conducted or a radiated measurement, provided the transmitter demonstrates compliance with the peak conducted power limits. If the transmitter complies with the conducted power limits based on the use of RMS averaging over a time interval, as permitted under paragraph (b)(3) of this section, the attenuation required under this paragraph shall be 30 dB instead of 20 dB. Attenuation below the general limits specified in §15.209(a) is not required. In addition, radiated emission which fall in the restricted bands, as defined in §15.205(a), must also comply with the radiated emission limits specified in §15.209(a) (see §15.205(c)).

According to §15.209(a), except as provided elsewhere in this subpart, the emissions from an intentional radiator shall not exceed the field strength levels specified in the following table:

Frequency (MHz)	Field Strength (µV/m)	Measurement Distance (Meters)
0.009-0.490	2 400/F(kHz)	300
0.490-1.705	24 000/F(kHz)	30
1.705-30.0	30	30
30-88	100**	3
88-216	150**	3
216-960	200**	3
Above 960	500	3

** Except as provided in paragraph (g), fundamental emissions from intentional radiators operating under this section shall not be located in the frequency bands 54-72 MHz, 76-88 MHz, 174-216 MHz or 470-806 MHz. However, operation within these frequency bands is permitted under other sections of this part, e.g., §§15.231 and 15.241.

2.2.2. IC

According to RSS-247 Issue 2, 5.5, in any 100 kHz bandwidth outside the frequency band in which the spread spectrum or digitally modulated device is operating, the RF power that is produced shall be at least 20 dB below that in the 100 kHz bandwidth within the band that contains the highest level of the desired power, based on either an RF conducted or a radiated measurement, provided that the transmitter demonstrates compliance with the peak conducted power limits. If the transmitter complies with the conducted power limits based on the use of root-mean-square averaging over a time interval, as permitted under section 5.4(d), the attenuation required shall be 30 dB instead of 20 dB. Attenuation below the general field strength limits specified in RSS-Gen is not required.

According to RSS-Gen Issue 5, 8.9, except where otherwise indicated in the applicable RSS, radiated emissions shall comply with the field strength limits shown in table 5 and table 6. Additionally, the level of any transmitter unwanted emission shall not exceed the level of the transmitter's fundamental emission.

Table 5 – General Field Strength Limits at frequencies above 30 MHz

Frequency (MHz)	Field Strength ($\mu V/m$ at 3 m)
30-88	100
88-216	150
216-960	200
Above 960	500

Table 6 – General Field Strength Limits at frequencies below 30 MHz

Frequency	Magnetic Field Strength (H-Field) ($\mu A/m$)	Measurement Distance (meters)
9-490 kHz ¹	6.37/F (F in kHz)	300
490-1 705 kHz	63.7/F (F in kHz)	30
1.705-30 MHz	0.08	30

Note¹: The emission limits for the ranges 9-90 kHz and 110-490 kHz are based on measurements employing a linear average detector.

2.3. Test Procedures

Radiated emissions from the EUT were measured according to the dictates of ANSI C63.10-2013.

2.3.1. Test Procedures for emission below 30 MHz

1. The EUT was placed on the top of a rotating table 0.8 meters above the ground at a 3 meter anechoic chamber test site. The table was rotated 360 degrees to determine the position of the highest radiation.
2. Then antenna is a loop antenna is fixed at one meter above the ground to determine the maximum value of the field strength. Both parallel and perpendicular of the antenna are set to make the measurement.
3. For each suspected emission, the EUT was arranged to its worst case and then the table was turned from 0 degrees to 360 degrees to find the maximum reading.
4. The test-receiver system was set to average or quasi peak detect function and Specified Bandwidth with Maximum Hold Mode.

2.3.2. Test Procedures for emission from above 30 MHz

1. The EUT was placed on the top of a rotating table 0.8 meters above the ground at a 3 meter anechoic chamber test site below 1 GHz and 1.5 meter above the ground at a 3 meter anechoic chamber test site above 1 GHz. The table was rotated 360 degrees to determine the position of the highest radiation.
2. During performing radiated emission below 1 GHz, the EUT was set 3 meters away from the interference receiving antenna, which was mounted on the top of a variable-height antenna tower. During performing radiated emission above 1 GHz, the EUT was set 3 meter away from the interference-receiving antenna.
3. The antenna is a bi-log antenna, a horn antenna and its height is varied from one meter to four meters above the ground to determine the maximum value of the field strength. Both horizontal and vertical polarizations of the antenna are set to make the measurement.
4. For each suspected emission, the EUT was arranged to its worst case and then the antenna was tuned to heights from 1 meter to 4 meters and the table was turned from 0 degrees to 360 degrees to find the maximum reading.
5. The test-receiver system was set to Peak Detect Function and Specified Bandwidth with Maximum Hold Mode.

Note;

1. The resolution bandwidth and video bandwidth of test receiver/spectrum analyzer is 120 kHz for Peak detection (PK) and Quasi-peak detection (QP) at frequency below 1 GHz.
2. For frequency above 1 GHz, set spectrum analyzer detector to peak, and resolution bandwidth is 1 MHz and video bandwidth is 3 MHz.
3. Definition of DUT Axis.
Definition of the test orthogonal plan for EUT was described in the test setup photo.
The test orthogonal plan of EUT is **X – axis** during radiation test.

2.3.3. Test Procedures for Conducted Spurious Emissions

2.3.3.1. Band-edge Compliance of RF Conducted Emissions

The transmitter output was connected to the spectrum analyzer.

Span = wide enough to capture the peak level of the emission operating on the channel closest to the band edge, as well as any modulation products which fall outside of the authorized band of operation.

RBW \geq 100 kHz

VBW = 300 kHz

Sweep = auto

Detector function = peak

Trace = max hold

2.3.3.2. Spurious RF Conducted Emissions

The transmitter output was connected to the spectrum analyzer.

RBW = 1 MHz

VBW = 3 MHz

Sweep = auto

Detector function = peak

Trace = max hold

2.3.3.3. TDF function

- For plots showing conducted spurious emissions from 9 kHz to 25 GHz, all path loss of wide frequency range was investigated and compensated to spectrum analyzer as TDF function.

So, the reading values shown in plots were final result.

2.4. Test Results

Ambient temperature : (23 ± 1) °C
 Relative humidity : 47 % R.H.

2.4.1. Radiated Spurious Emission below 1 000 MHz

The frequency spectrum from 9 kHz to 1 000 MHz was investigated. All reading values are peak values.

Radiated Emissions			Ant.	Correction Factors		Total	Limit	
Frequency (MHz)	Reading (dB μ V)	Detect Mode	Pol.	AF (dB/m)	AMP + CL (dB)	Actual (dB μ V/m)	Limit (dB μ V/m)	Margin (dB)
102.59	33.70	Peak	H	17.10	-25.38	25.42	43.50	18.08
119.73	33.10	Peak	H	15.45	-25.31	23.24	43.50	20.26
146.56	40.30	Peak	V	13.80	-25.21	28.89	43.50	14.61
214.02	35.40	Peak	V	16.94	-25.05	27.29	43.50	16.21
339.92	36.30	Peak	V	25.52	-24.76	37.06	46.00	8.94
365.05	35.40	Peak	H	20.30	-24.74	30.96	46.00	15.04
Above 400.00	Not detected	-	-	-	-	-	-	-

Remark;

- Spurious emissions for all channels and modes were investigated and almost the same below 1 GHz.
- Reported spurious emissions are in **BDR / DH5 / High channel** as worst case among other modes.
- Radiated spurious emission measurement as below.
 (Actual = Reading + AF + AMP + CL)
- According to §15.31(o), emission levels are not report much lower than the limits by over 20 dB.

- Test plot

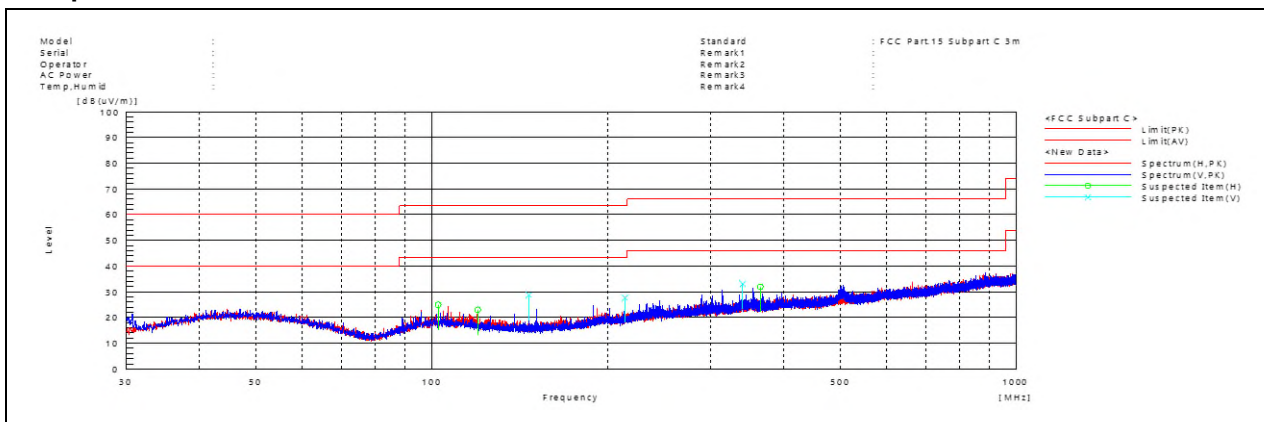

2.4.2. Radiated Spurious Emission above 1 000 MHz

The frequency spectrum above 1 000 MHz was investigated. All reading values are peak values.

Operating Mode: GFSK (1 Mbps)

A. Low Channel (2 402 MHz)

Radiated Emissions			Ant.	Correction Factors			Total	Limit	
Frequency (MHz)	Reading (dB μ V)	Detect Mode	Pol.	AF (dB/m)	CL (dB)	DF (dB)	Actual (dB μ V/m)	Limit (dB μ V/m)	Margin (dB)
*2 310.00	28.99	Peak	V	27.96	8.21	-	65.16	74.00	8.84
*2 310.00	-	-	-	-	-	-24.73	40.43	54.00	13.57
*2 359.32	31.18	Peak	V	27.89	8.29	-	67.36	74.00	6.64
*2 359.32	-	-	-	-	-	-24.73	42.63	54.00	11.37
*2 390.00	28.59	Peak	V	28.20	8.35	-	65.14	74.00	8.86
*2 390.00	-	-	-	-	-	-24.73	40.41	54.00	13.59

Radiated Emissions			Ant.	Correction Factors			Total	Limit	
Frequency (MHz)	Reading (dB μ V)	Detect Mode	Pol.	AF (dB/m)	AMP+CL (dB)	DF (dB)	Actual (dB μ V/m)	Limit (dB μ V/m)	Margin (dB)
Above 1 000.00	Not detected	-	-	-	-	-	-	-	-

B. Middle Channel (2 441 MHz)

Radiated Emissions			Ant.	Correction Factors			Total	Limit	
Frequency (MHz)	Reading (dB μ V)	Detect Mode	Pol.	AF (dB/m)	AMP+CL (dB)	DF (dB)	Actual (dB μ V/m)	Limit (dB μ V/m)	Margin (dB)
Above 1 000.00	Not detected	-	-	-	-	-	-	-	-

C. High Channel (2 480 MHz)

Radiated Emissions			Ant.	Correction Factors			Total	Limit	
Frequency (MHz)	Reading (dB μ V)	Detect Mode	Pol.	AF (dB/m)	CL (dB)	DF (dB)	Actual (dB μ V/m)	Limit (dB μ V/m)	Margin (dB)
*2 483.50	29.55	Peak	V	28.37	8.44	-	66.36	74.00	7.64
*2 483.50	-	-	-	-	-	-24.73	41.63	54.00	12.37
*2 488.65	32.77	Peak	V	28.35	8.46	-	69.58	74.00	4.42
*2 488.65	-	-	-	-	-	-24.73	44.85	54.00	9.15
*2 500.00	29.59	Peak	V	28.30	8.49	-	66.38	74.00	7.62
*2 500.00	-	-	-	-	-	-24.73	41.65	54.00	12.35

Radiated Emissions			Ant.	Correction Factors			Total	Limit	
Frequency (MHz)	Reading (dB μ V)	Detect Mode	Pol.	AF (dB/m)	AMP+CL (dB)	DF (dB)	Actual (dB μ V/m)	Limit (dB μ V/m)	Margin (dB)
Above 1 000.00	Not detected	-	-	-	-	-	-	-	-

Operating Mode: 8DPSK (3 Mbps)

A. Low Channel (2 402 MHz)

Radiated Emissions			Ant.	Correction Factors			Total	Limit	
Frequency (MHz)	Reading (dB μ V)	Detect Mode	Pol.	AF (dB/m)	CL (dB)	DF (dB)	Actual (dB μ V/m)	Limit (dB μ V/m)	Margin (dB)
*2 310.00	28.90	Peak	V	27.96	8.21	-	65.07	74.00	8.93
*2 310.00	-	-	-	-	-	-24.73	40.34	54.00	13.66
*2 327.01	31.81	Peak	V	27.89	8.22	-	67.92	74.00	6.08
*2 327.01	-	-	-	-	-	-24.73	43.19	54.00	10.81
*2 390.00	29.84	Peak	V	28.20	8.35	-	66.39	74.00	7.61
*2 390.00	-	-	-	-	-	-24.73	41.66	54.00	12.34

Radiated Emissions			Ant.	Correction Factors			Total	Limit	
Frequency (MHz)	Reading (dB μ V)	Detect Mode	Pol.	AF (dB/m)	AMP+CL (dB)	DF (dB)	Actual (dB μ V/m)	Limit (dB μ V/m)	Margin (dB)
Above 1 000.00	Not detected	-	-	-	-	-	-	-	-

B. Middle Channel (2 441 MHz)

Radiated Emissions			Ant.	Correction Factors			Total	Limit	
Frequency (MHz)	Reading (dB μ V)	Detect Mode	Pol.	AF (dB/m)	AMP+CL (dB)	DF (dB)	Actual (dB μ V/m)	Limit (dB μ V/m)	Margin (dB)
Above 1 000.00	Not detected	-	-	-	-	-	-	-	-

C. High Channel (2 480 MHz)

Radiated Emissions			Ant.	Correction Factors			Total	Limit	
Frequency (MHz)	Reading (dBμV)	Detect Mode	Pol.	AF (dB/m)	CL (dB)	DF (dB)	Actual (dBμV/m)	Limit (dBμV/m)	Margin (dB)
*2 483.50	29.31	Peak	V	28.37	8.44	-	66.12	74.00	7.88
*2 483.50	-	-	-	-	-	-24.73	41.39	54.00	12.61
*2 484.25	31.95	Peak	V	28.36	8.45	-	68.76	74.00	5.24
*2 484.25	-	-	-	-	-	-24.73	44.03	54.00	9.97
*2 500.00	29.02	Peak	V	28.30	8.49	-	65.81	74.00	8.19
*2 500.00	-	-	-	-	-	-24.73	41.08	54.00	12.92

Radiated Emissions			Ant.	Correction Factors			Total	Limit	
Frequency (MHz)	Reading (dBμV)	Detect Mode	Pol.	AF (dB/m)	AMP+CL (dB)	DF (dB)	Actual (dBμV/m)	Limit (dBμV/m)	Margin (dB)
Above 1 000.00	Not detected	-	-	-	-	-	-	-	-

Remark;

1. “*” means the restricted band.
2. Measuring frequencies from 1 GHz to the 10th harmonic of highest fundamental frequency.
3. Radiated emissions measured in frequency above 1 000 MHz were made with an instrument using peak/average detector mode.
4. Actual = Reading + AF + CL + (DF) or Reading + AF + AMP + CL + (DF).
5. According to § 15.31(o), emission levels are not reported much lower than the limits by over 20 dB.
6. The maximized peak measured value complies with the average limit, to perform an average measurement is unnecessary.

- Test plots

Operating Mode: GFSK (1 Mbps)
 Low channel band edge

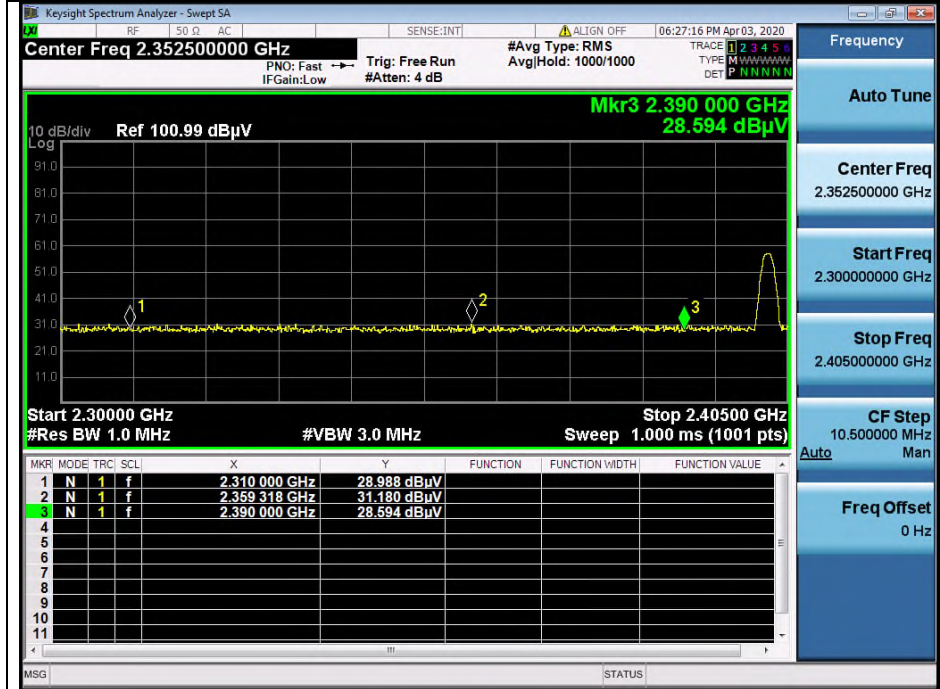

High channel band edge

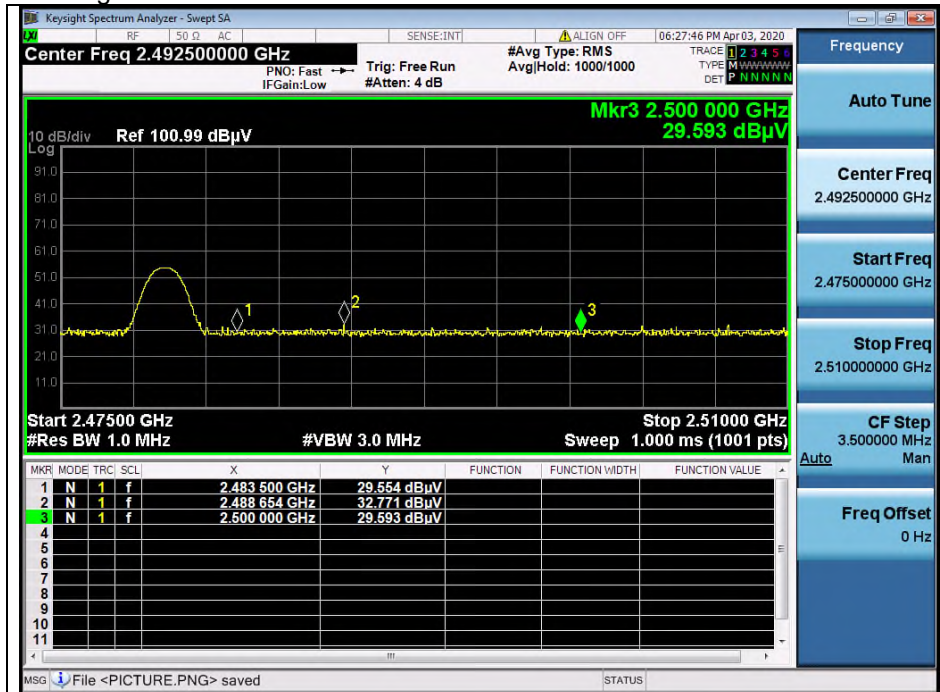

Operating Mode: 8DPSK (3 Mbps)
 Low channel band edge

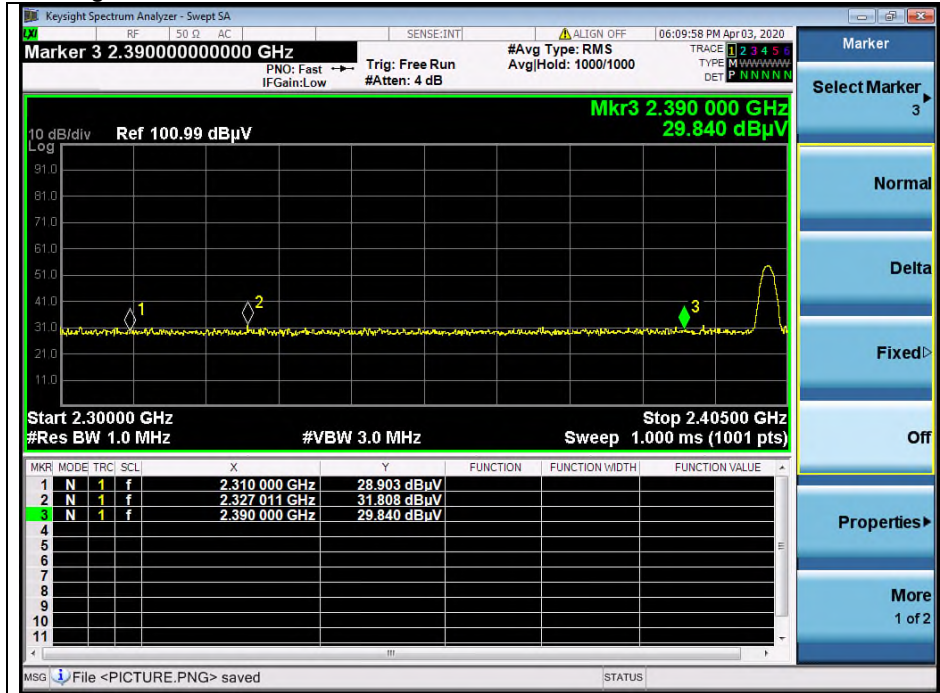

High channel band edge

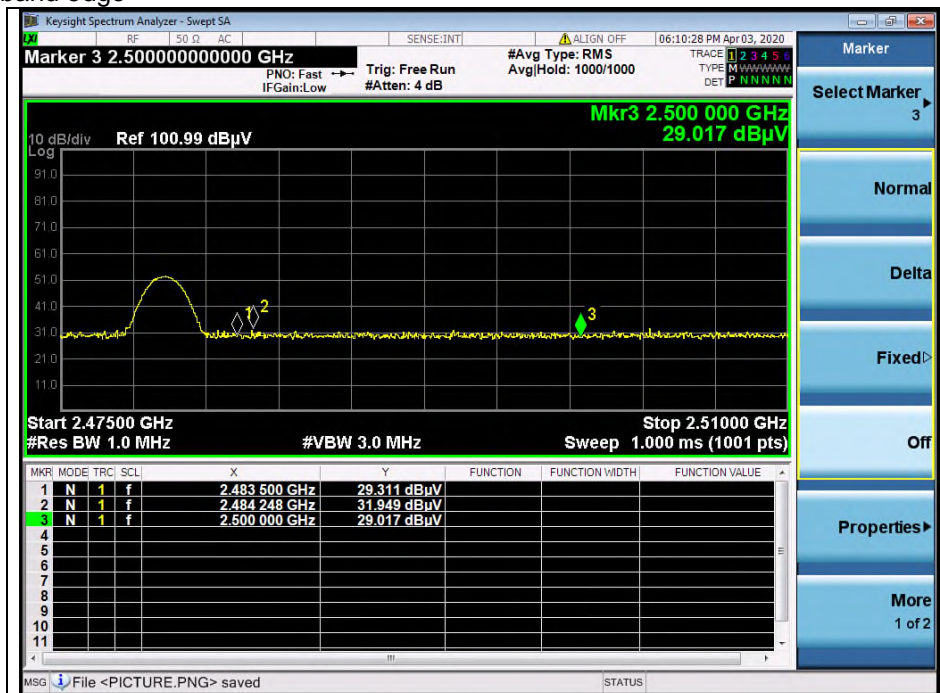

2.4.3. Plot of Spurious Conducted Emissions

Operating Mode: GFSK (1 Mbps)
 Low channel

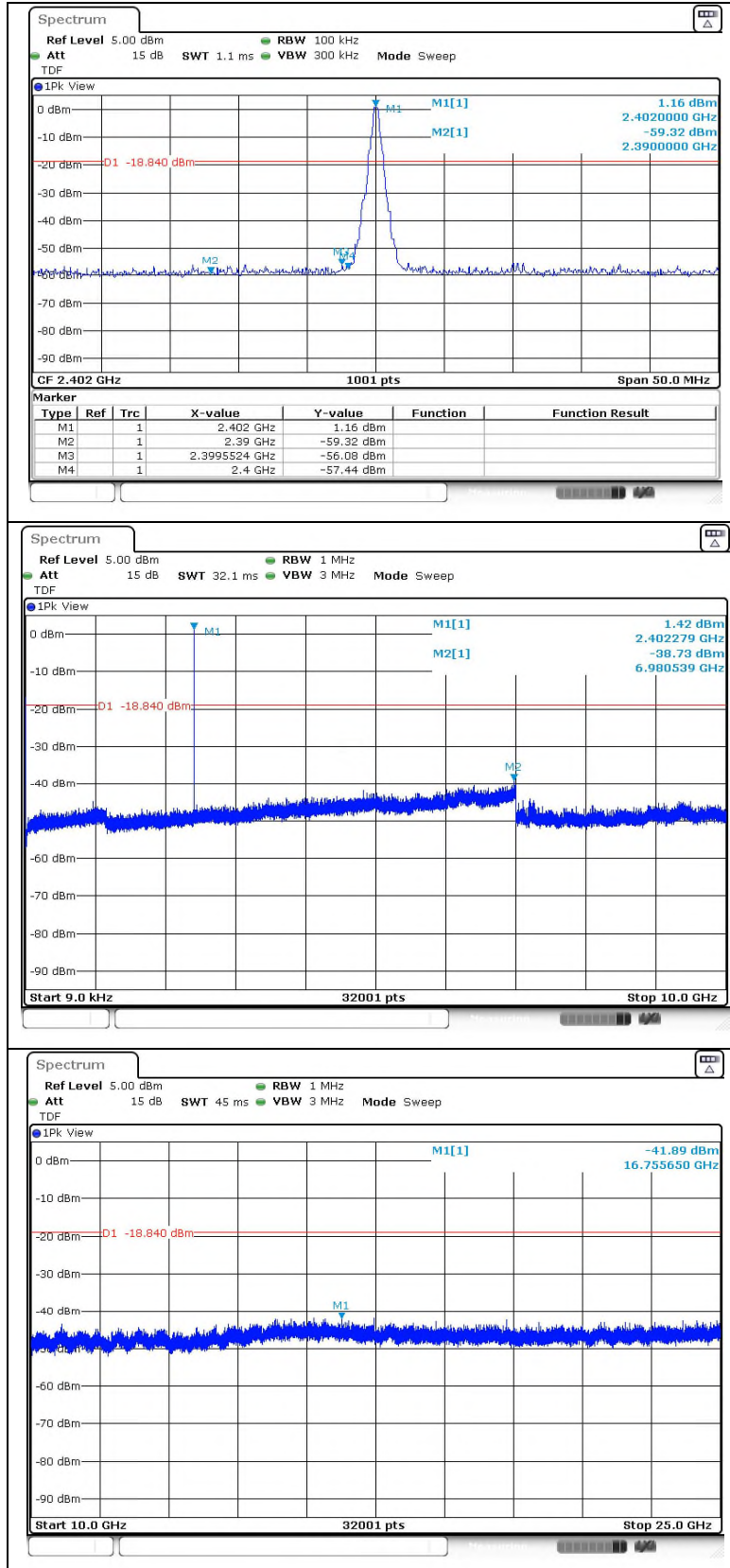

Middle channel

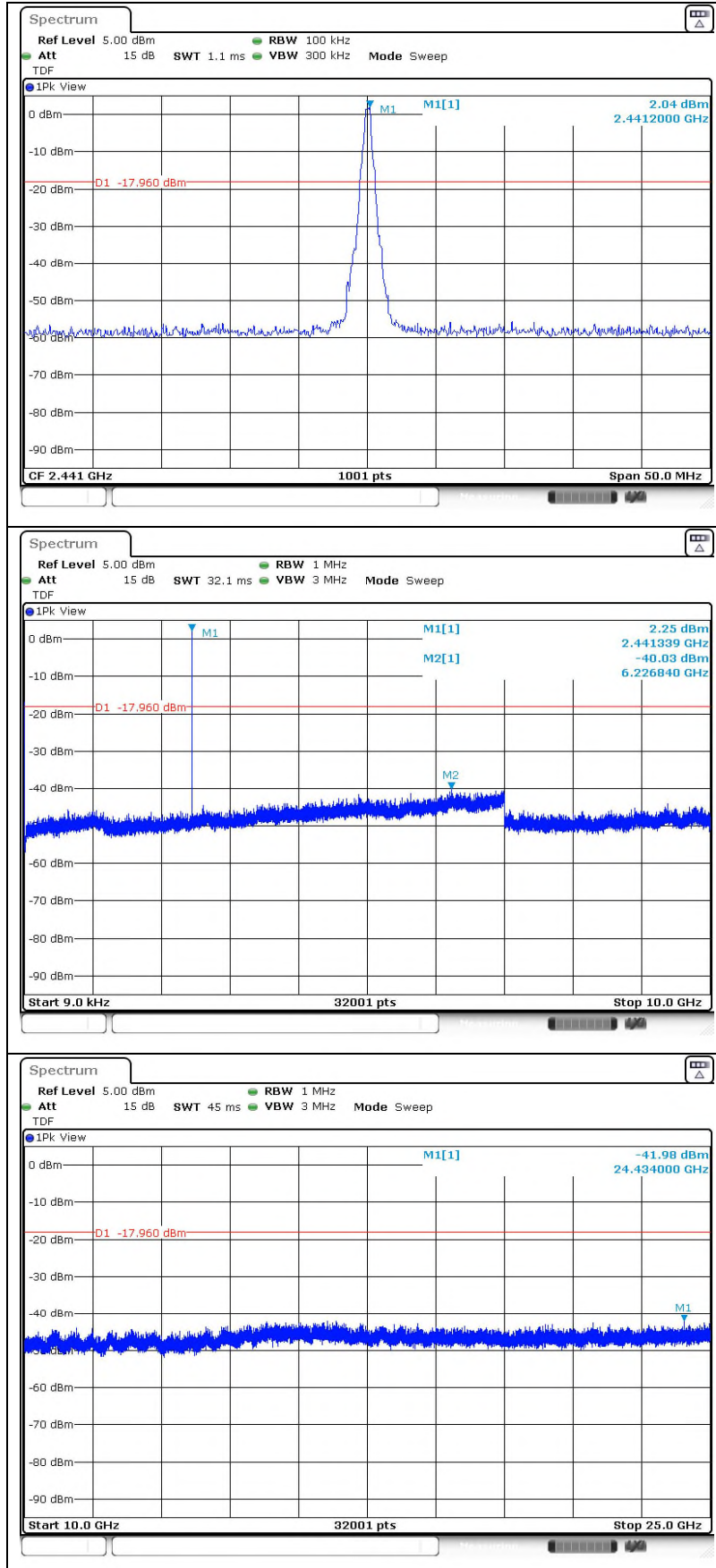

High channel

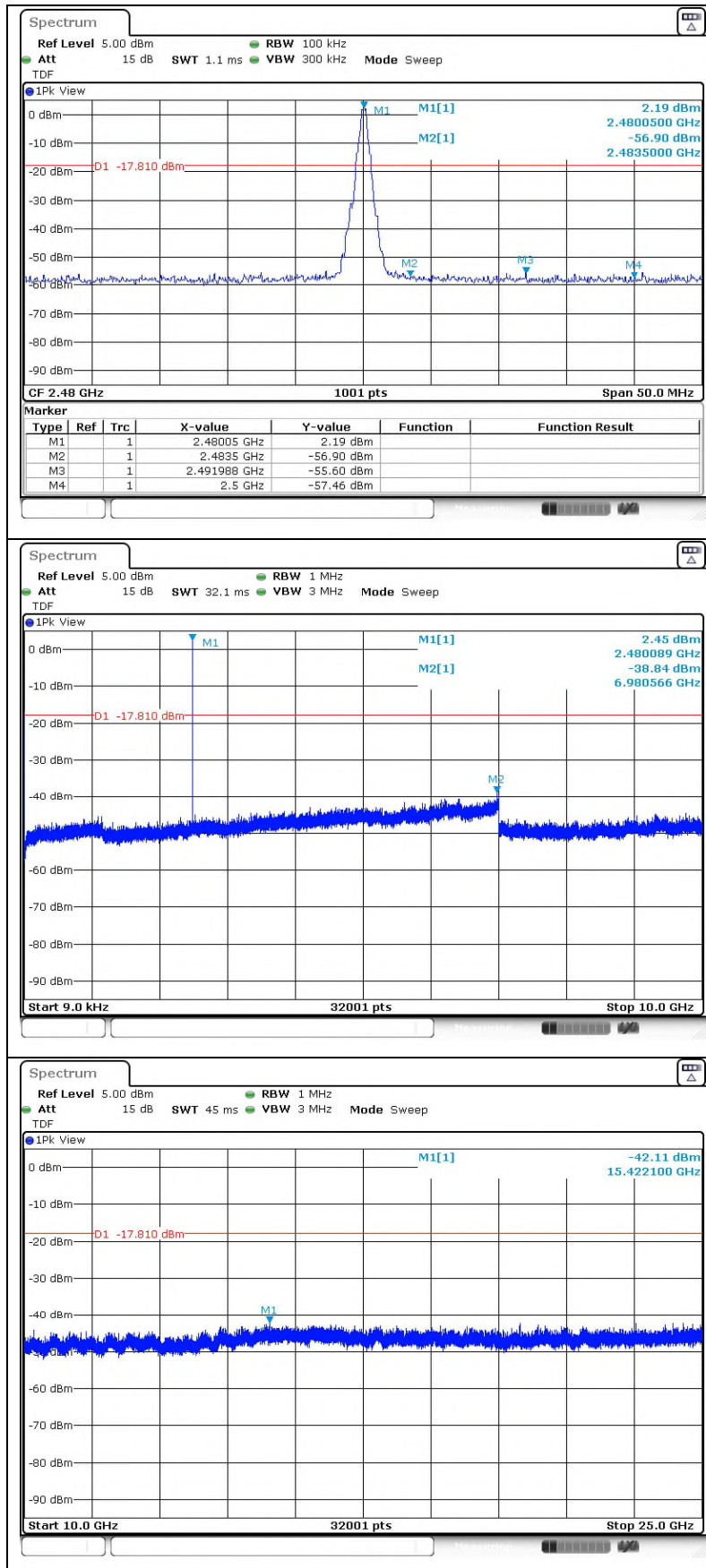

Band edge compliance with hopping enabled

Low channel

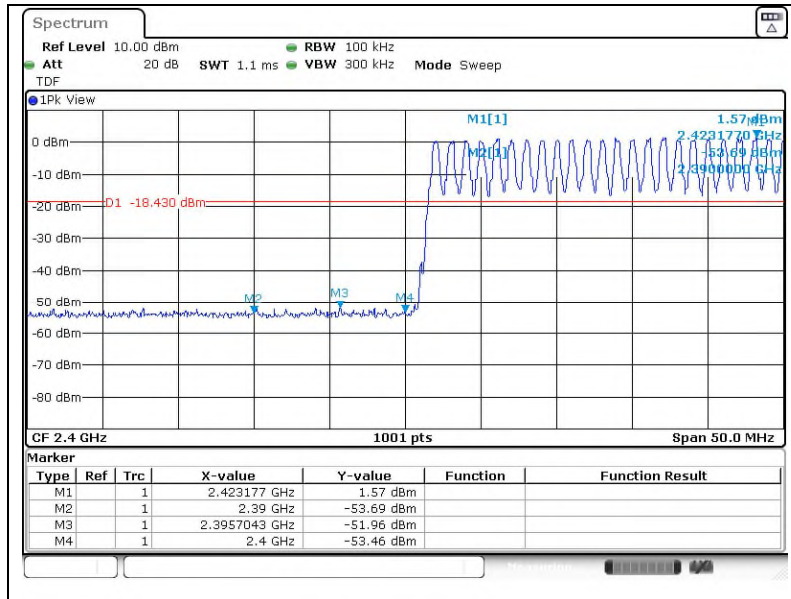

High channel

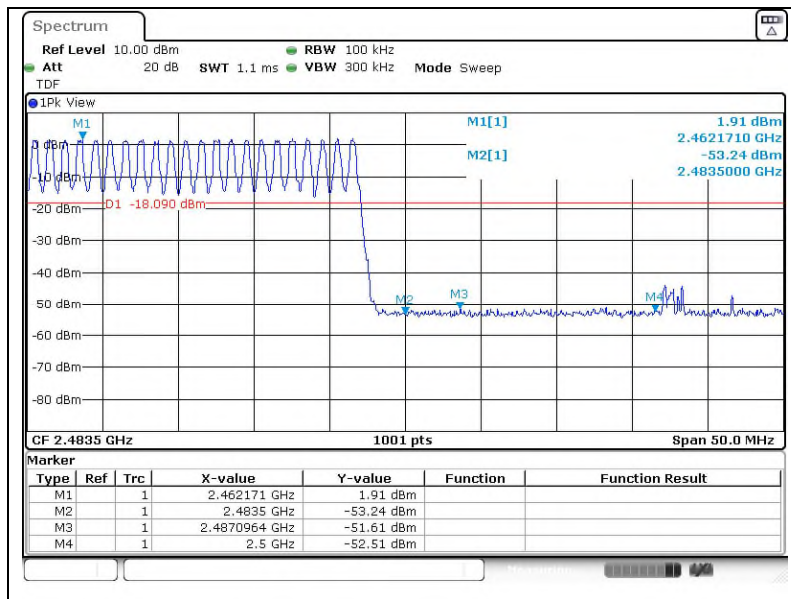

Operating Mode: 8DPSK (3 Mbps)

Low channel

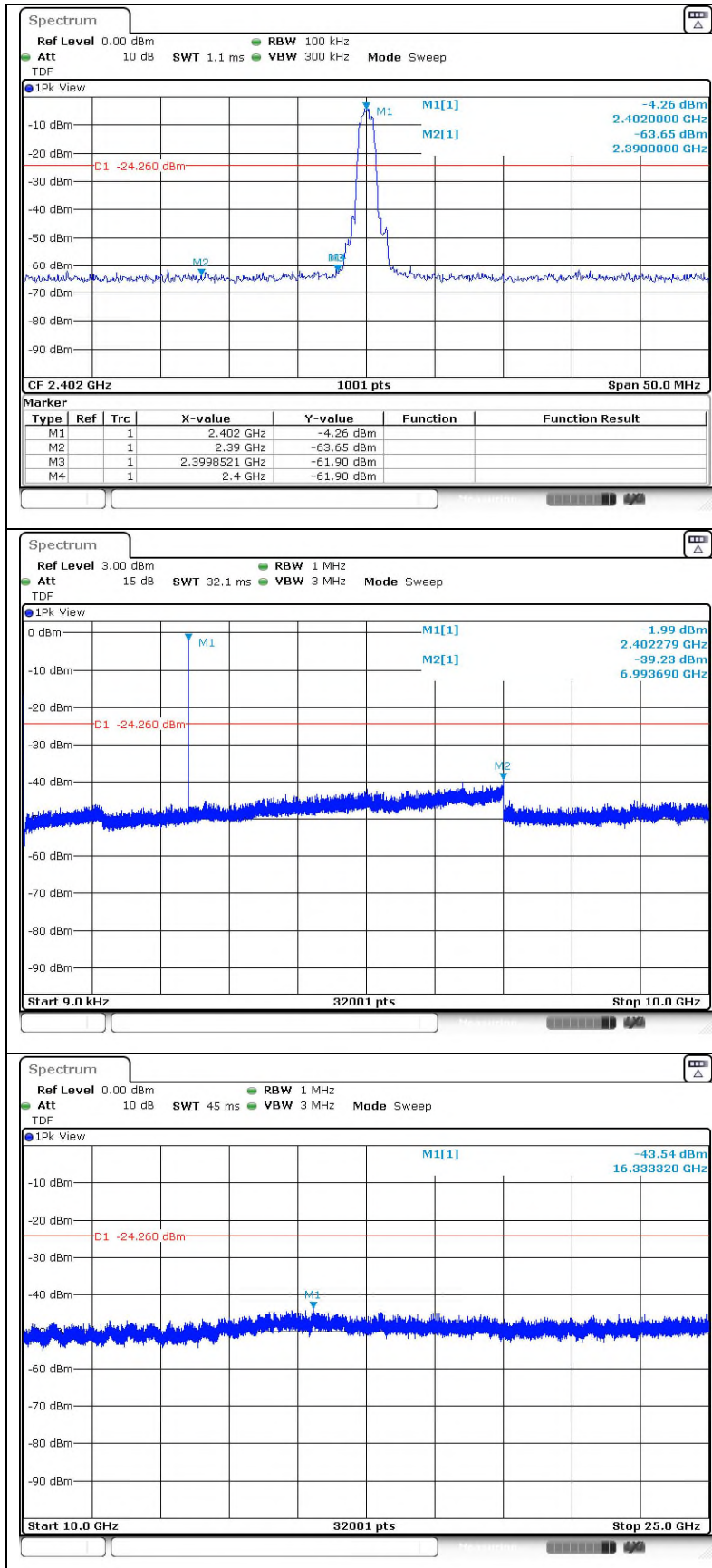

Middle channel

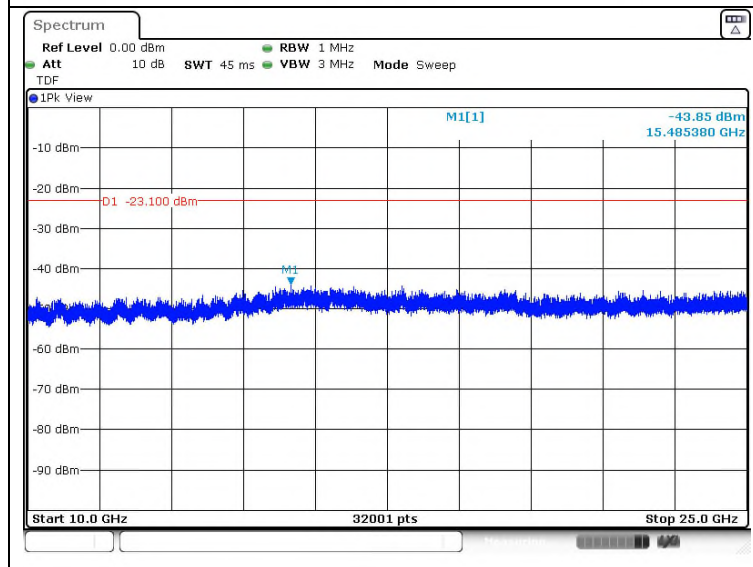
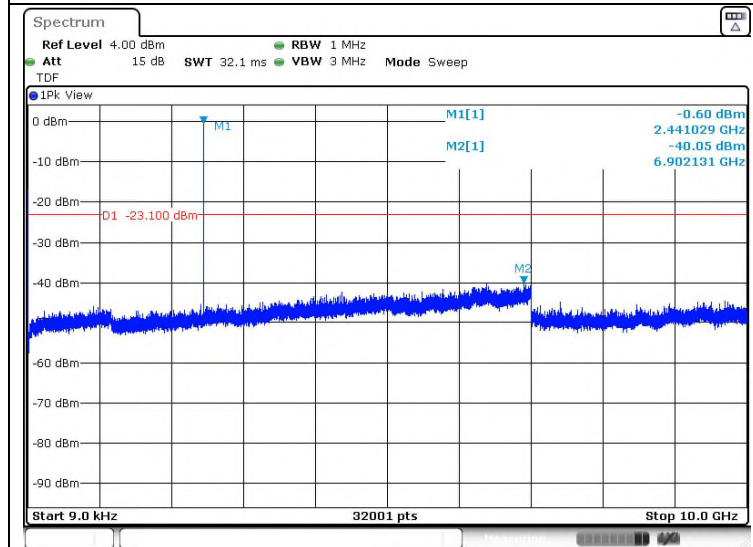
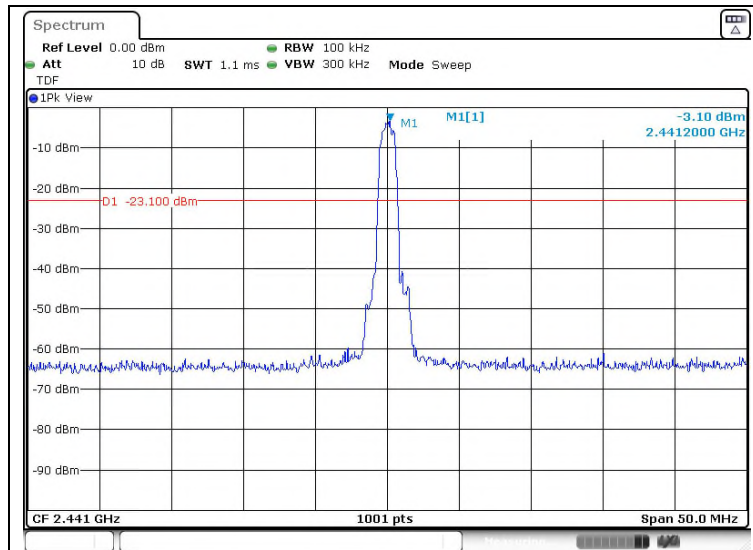

High channel

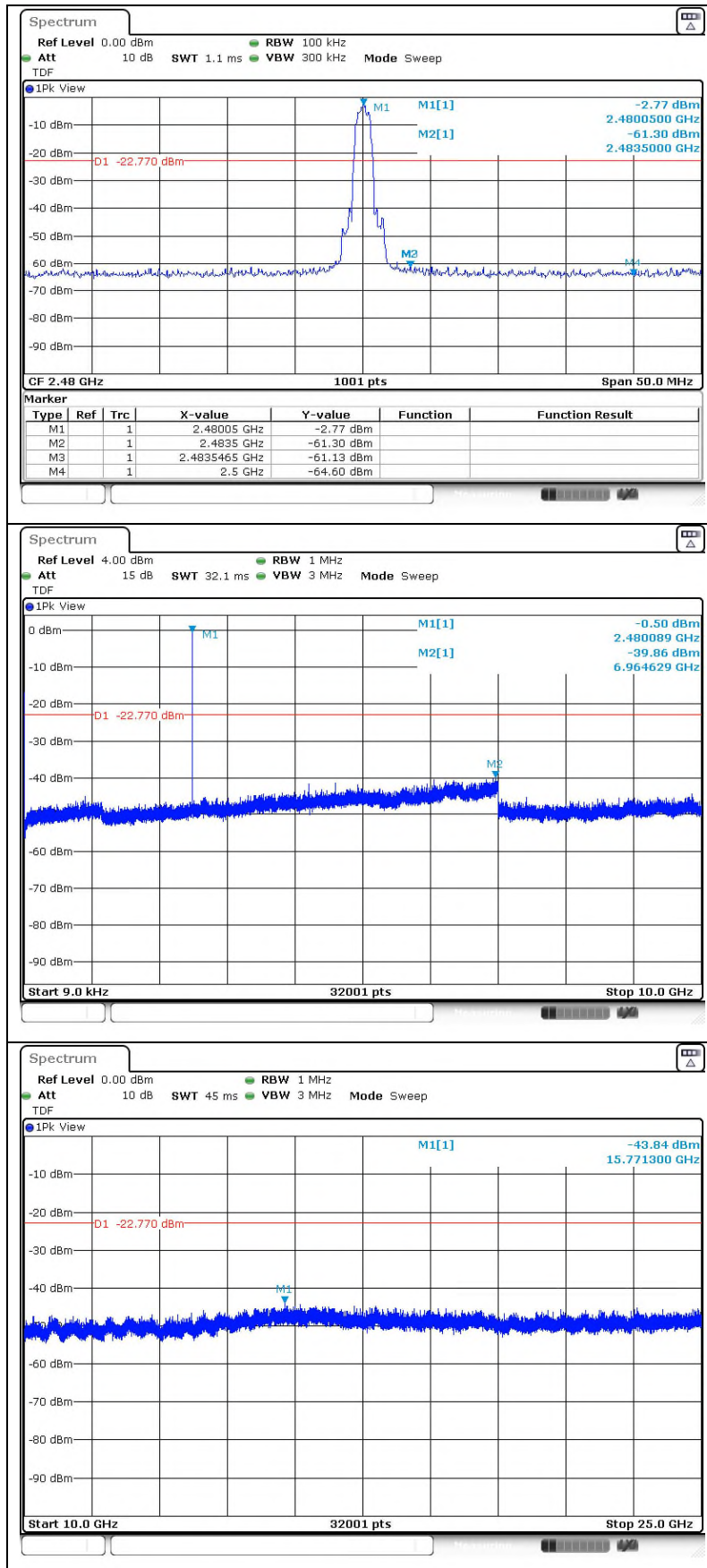

Band edge compliance with hopping enabled

Low channel

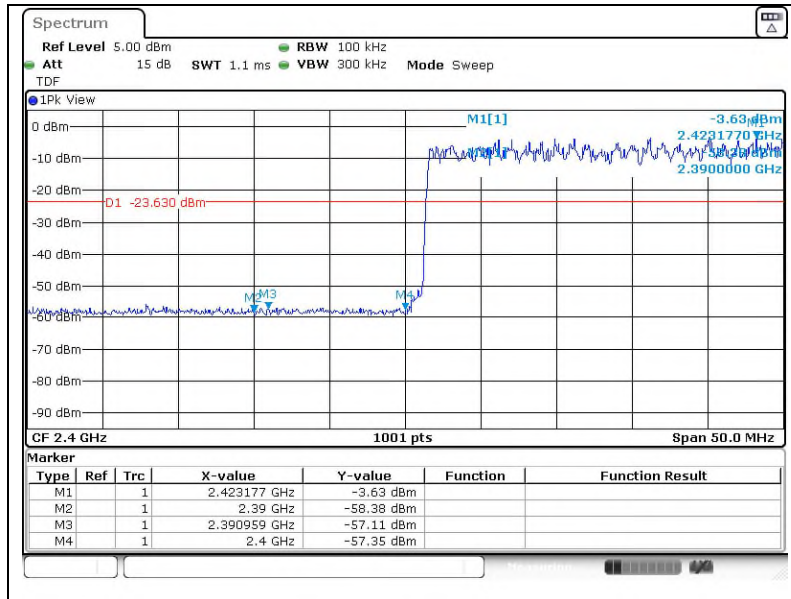

High channel

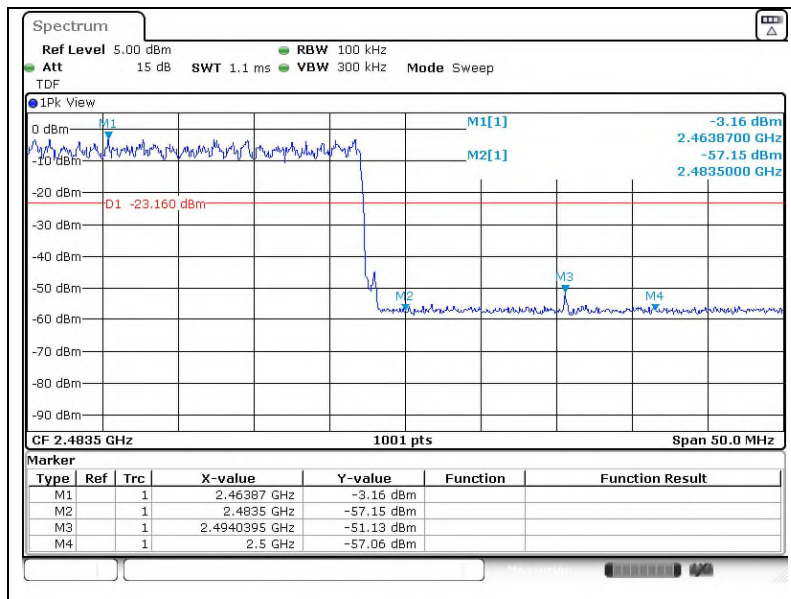

3. 20 dB Bandwidth and 99 % Bandwidth

3.1. Test Setup

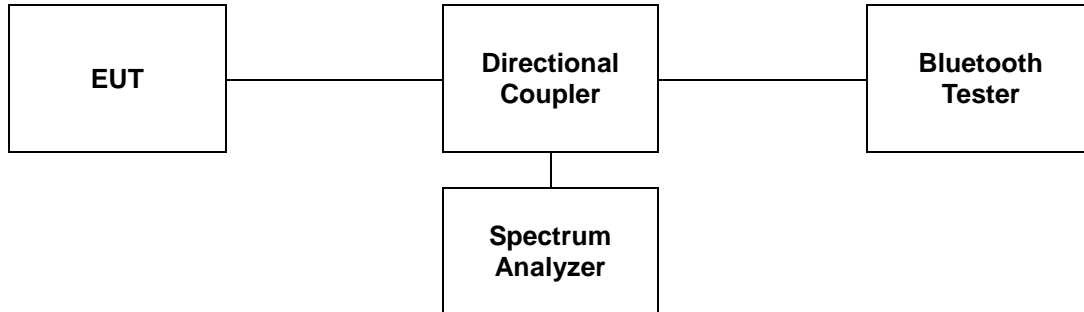

3.2. Limit

Limit: Not Applicable

3.3. Test Procedure

3.3.1. 20 dB Bandwidth

The test follows ANSI C63.10-2013.

The 20 dB bandwidth was measured with a spectrum analyzer connected to RF antenna connector (conducted measurement) while EUT was operating in transmit mode at the appropriate center frequency.

Use the following spectrum analyzer setting:

1. Span = approximately 2 to 5 times the 20 dB bandwidth.
2. RBW \geq 1 % to 5 % of the 20 dB bandwidth.
3. VBW \geq 3 x RBW
4. Sweep = auto
5. Detector = peak
6. Trace = max hold

The marker-to-peak function to set the mark to the peak of the emission. Use the marker-delta function to measure 20 dB down one side of the emission. Reset the function, and move the marker to the other side of the emission, until it is (as close as possible to) even with the reference marker level. The marker-delta reading at this point is 20 dB bandwidth of the emission.

3.3.2. 99 % Bandwidth

- The span of the spectrum analyzer shall be set large enough to capture all products of the modulation process, including the emission skirts, around the carrier frequency, but small enough to avoid having other emissions (e.g. on adjacent channels) within the span.
- The detector of the spectrum analyzer shall be set to "Sample". However, a peak, or peak hold, may be used in place of the sampling detector since this usually produces a wider bandwidth than the actual bandwidth (worst-case measurement). Use of a peak hold (or "Max Hold") may be necessary to determine the occupied / x dB bandwidth if the device is not transmitting continuously.
- The resolution bandwidth (RBW) shall be in the range of 1 % to 5 % of the actual occupied / x dB bandwidth and the video bandwidth (VBW) shall not be smaller than three times the RBW value. Video averaging is not permitted.

Note: It may be necessary to repeat the measurement a few times until the RBW and VBW are in compliance with the above requirement.

For the 99 % emission bandwidth, the trace data points are recovered and directly summed in linear power level terms. The recovered amplitude data points, beginning at the lowest frequency, are placed in a running sum until 0.5 % of the total is reached, and that frequency recorded. The process is repeated for the highest frequency data points (starting at the highest frequency, at the right side of the span, and going down in frequency). This frequency is then recorded. The difference between the two recorded frequencies is the occupied bandwidth (or the 99 % emission bandwidth).

3.4. Test Results

Ambient temperature : (23 ± 1) °C
 Relative humidity : 47 % R.H.

Operation Mode	Data Rate (Mbps)	Channel	Frequency (MHz)	20 dB Bandwidth (MHz)	99 % Bandwidth (MHz)
GFSK	1	Low	2 402	1.049	0.935
		Middle	2 441	1.046	0.935
		High	2 480	1.049	0.935
π/4DQPSK	2	Low	2 402	1.346	1.205
		Middle	2 441	1.361	1.208
		High	2 480	1.361	1.205
8DPSK	3	Low	2 402	1.343	1.211
		Middle	2 441	1.346	1.208
		High	2 480	1.346	1.211

- Test plots

20 dB Bandwidth

Operating Mode: GFSK

Low Channel

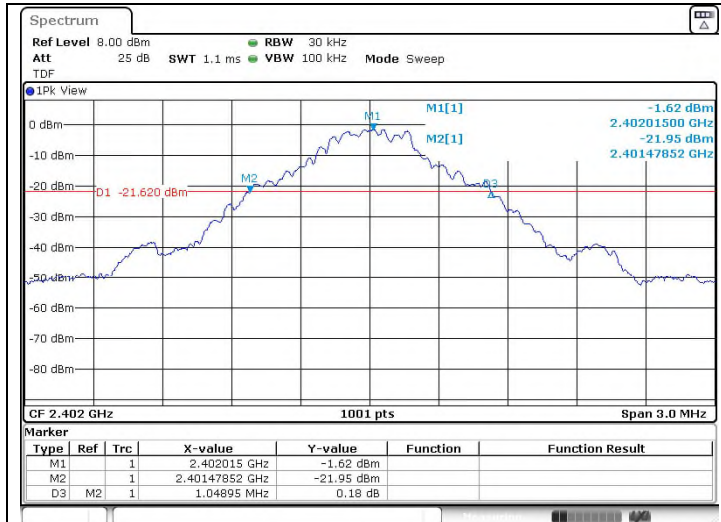

Middle Channel

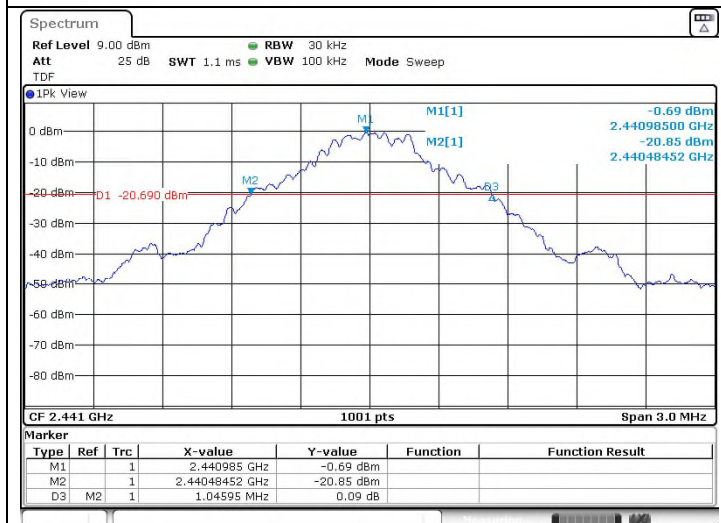

High Channel

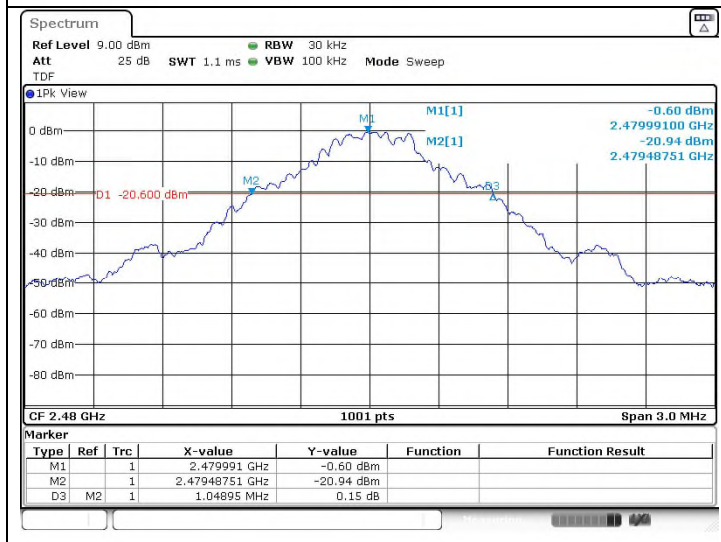

Operating Mode: $\pi/4$ DQPSK

Low Channel

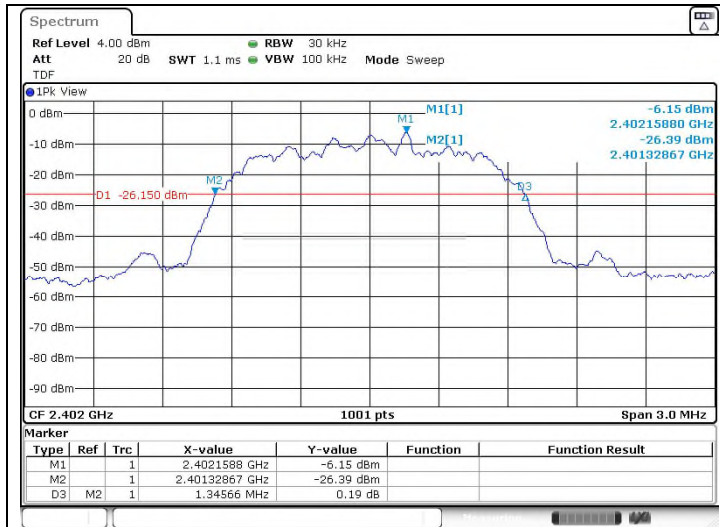

Middle Channel

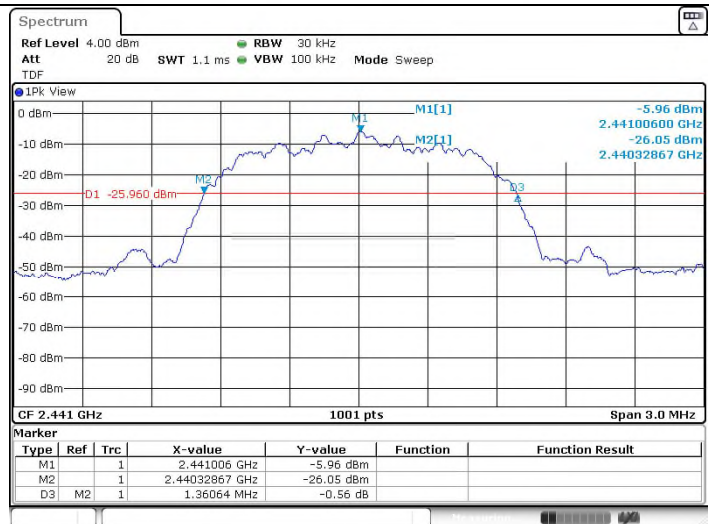

High Channel

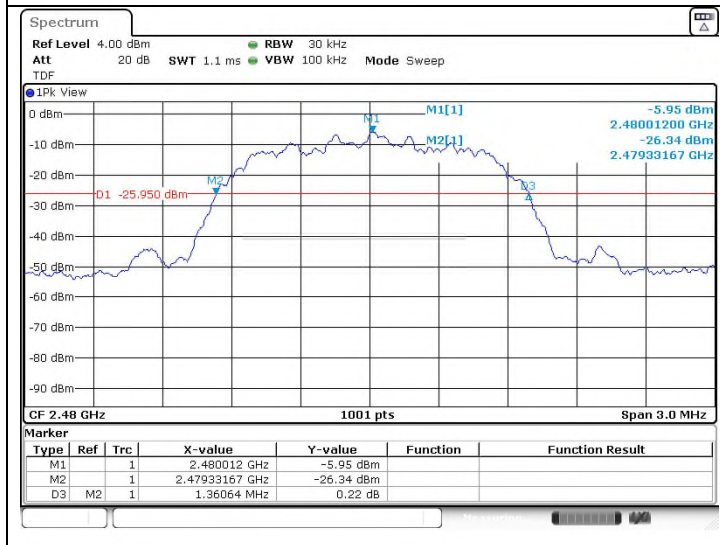

Operating Mode: 8DPSK

Low Channel

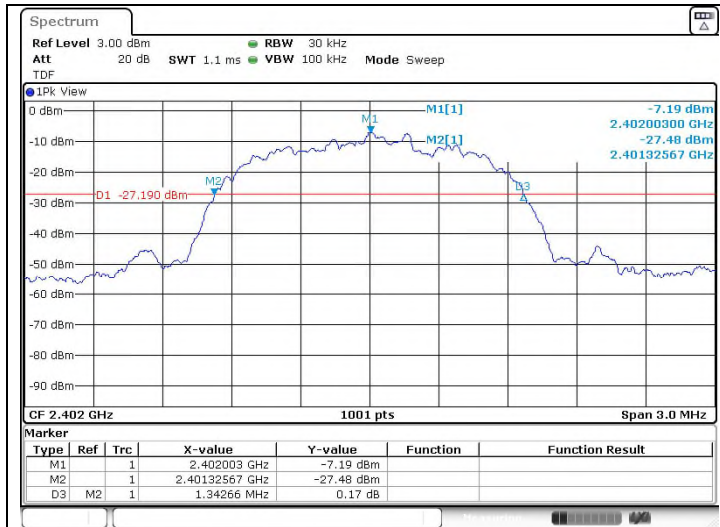

Middle Channel

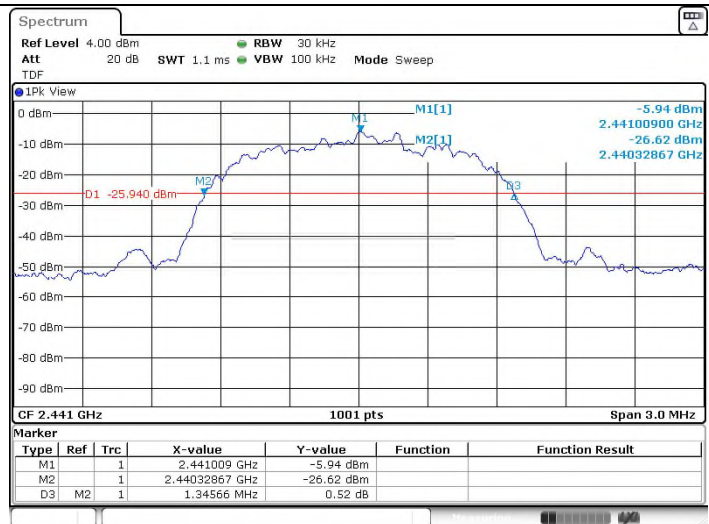

High Channel

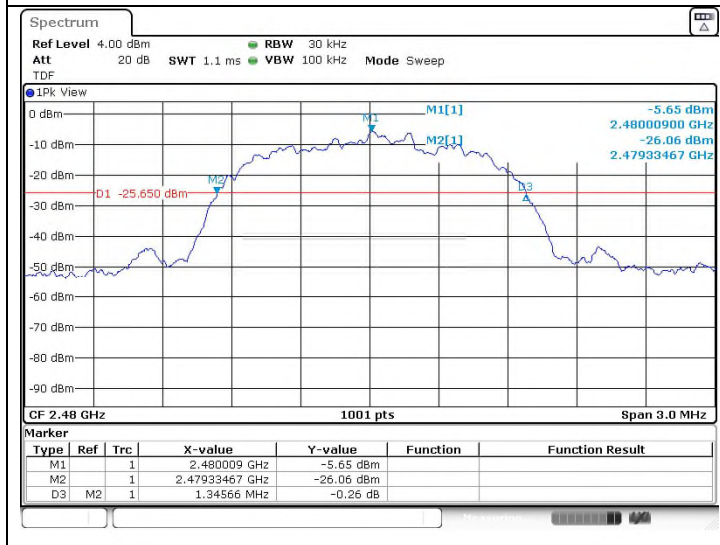

99 % Bandwidth

Operating Mode: GFSK

Low Channel

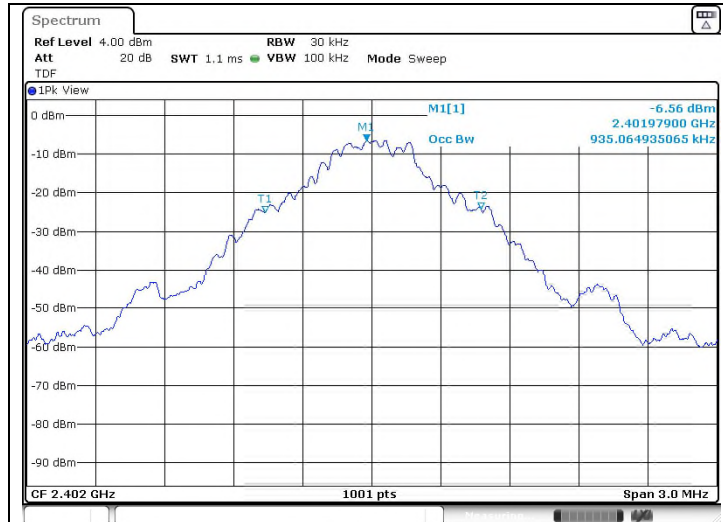

Middle Channel

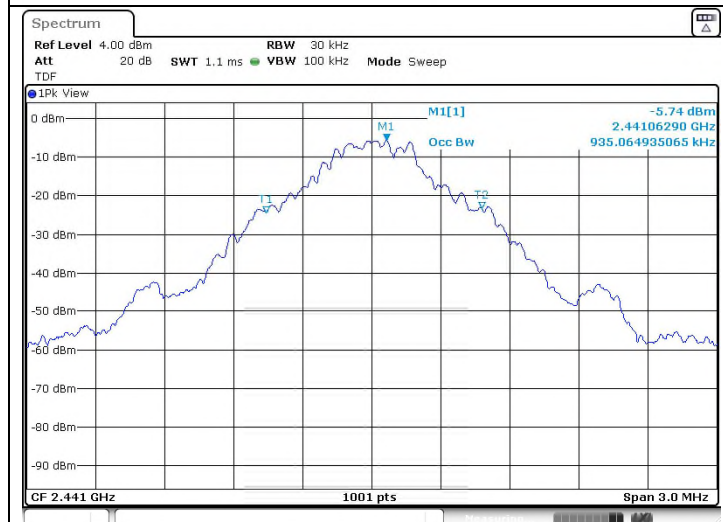

High Channel

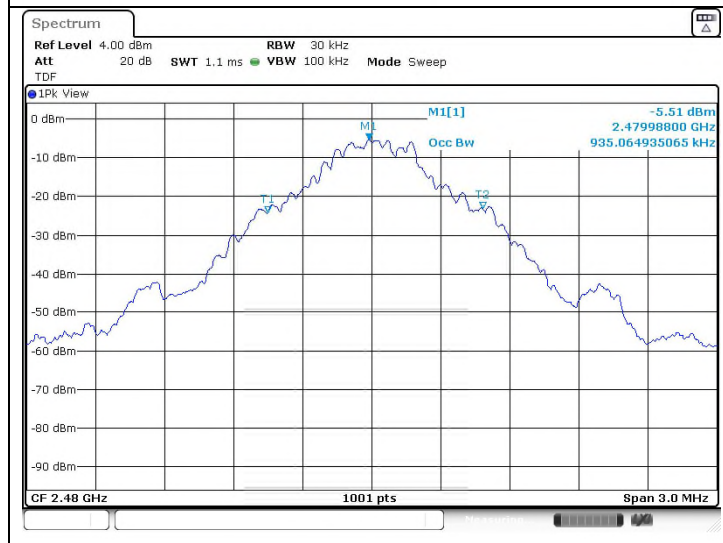

Operating Mode: $\pi/4$ DQPSK

Low Channel

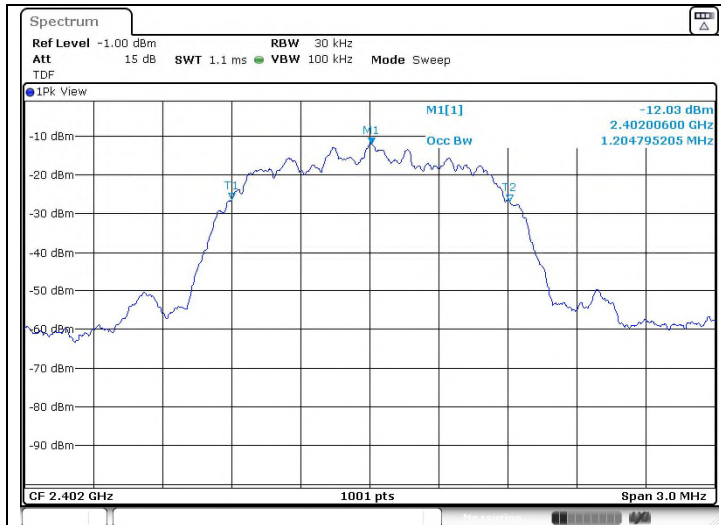

Middle Channel

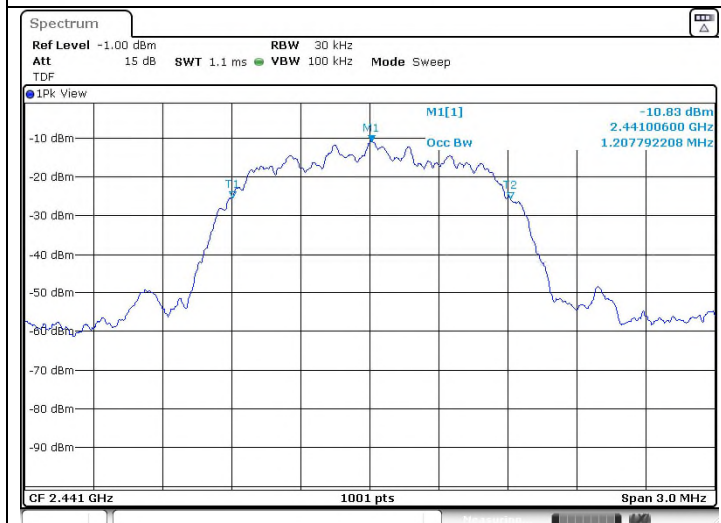

High Channel

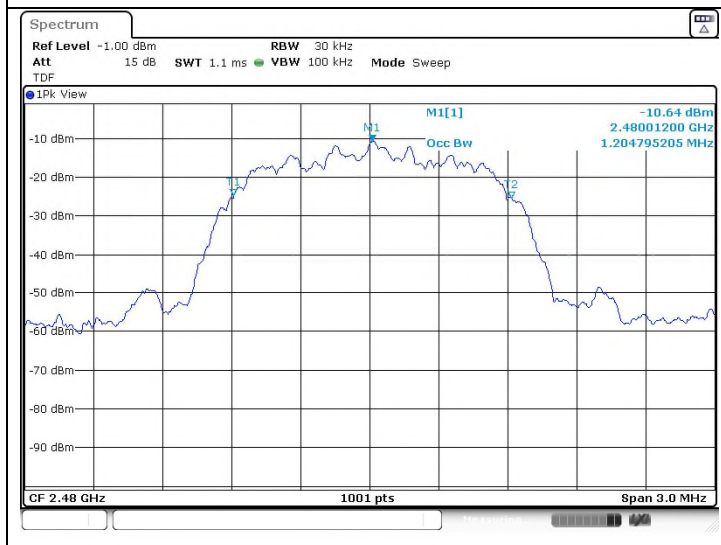

Operating Mode: 8DPSK

Low Channel

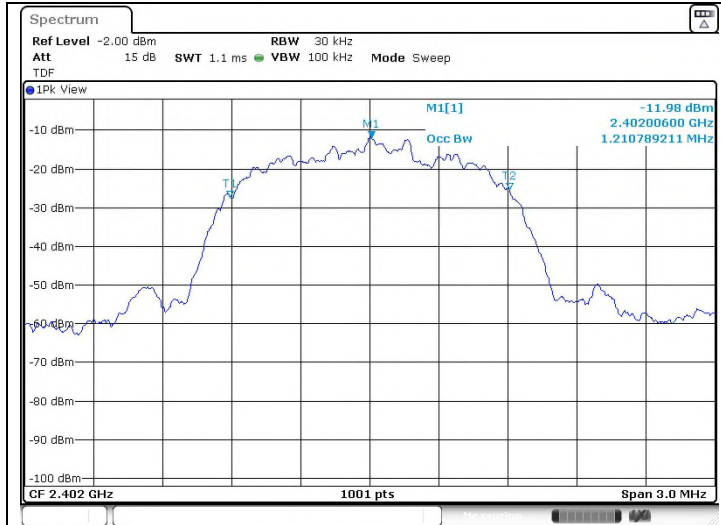

Middle Channel

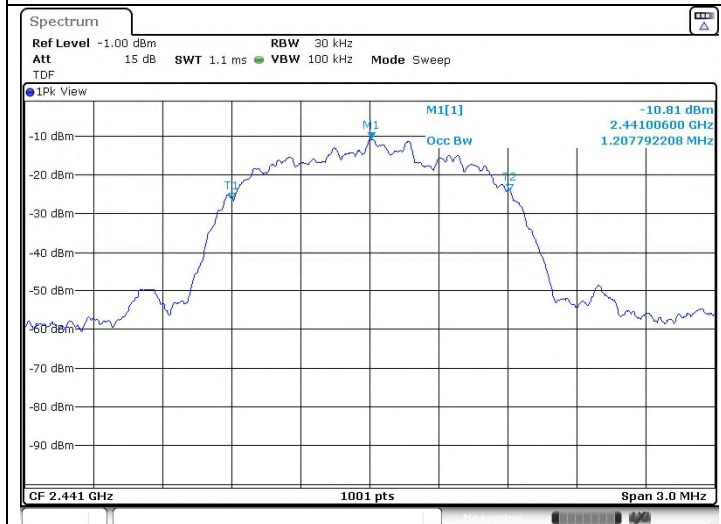

High Channel

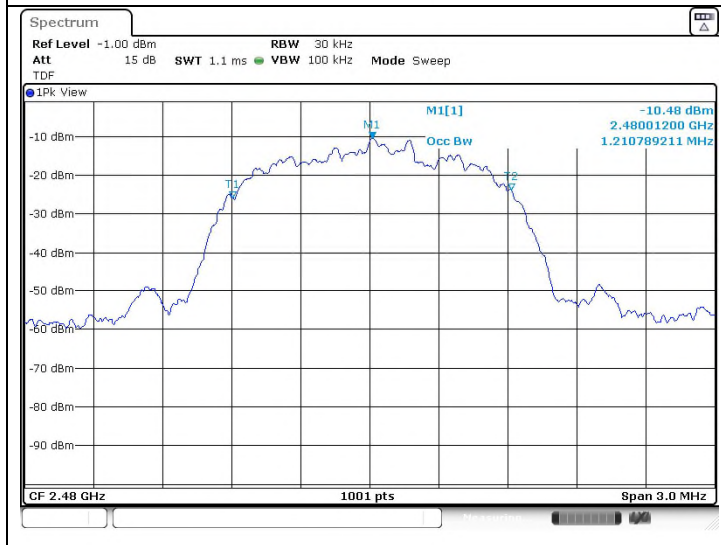

4. Maximum Peak Conducted Output Power

4.1. Test Setup

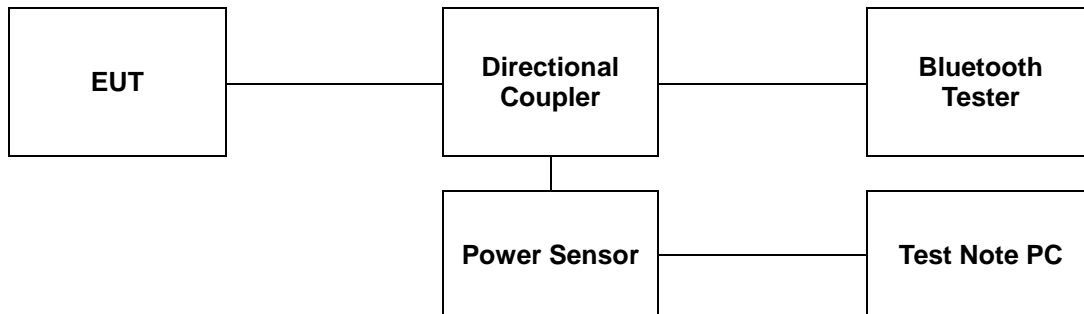

4.2. Limit

4.2.1. FCC

- §15.247(a)(1), Frequency hopping systems shall have hopping channel carrier frequencies separated by a minimum of 25 kHz or the 20 dB bandwidth of the hopping channel, whichever is greater. Alternatively, frequency hopping systems operating in the 2 400-2 483.5 MHz band may have hopping channel carrier frequencies that are separated by 25 kHz or two-thirds of the 20 dB bandwidth of the hopping channel, whichever is greater, provided the systems operate with an output power no greater than 125 mW.
- §15.247(b)(1), For frequency hopping systems operating in the 2 400-2 483.5 MHz band employing at least 75 non-overlapping hopping channels, and all frequency hopping systems in the 5 725-5 850 MHz band: 1 watt. For all other frequency hopping systems in the 2 400-2 483.5 MHz band: 0.125 watts.

4.2.2. IC

- According to RSS-247 Issue 2, 5.1(b), FHSs shall have hopping channel carrier frequencies separated by a minimum of 25 kHz or the 20 dB bandwidth of the hopping channel, whichever is greater. Alternatively, FHSs operating in the band 2 400-2 483.5 MHz may have hopping channel carrier frequencies that are separated by 25 kHz or two thirds of the 20 dB bandwidth of the hopping channel, whichever is greater, provided that the systems operate with an output power no greater than 0.125 W.
- According to RSS-247 Issue 2, 5.4(b), for FHSs operating in the band 2 400-2 483.5 MHz, the maximum peak conducted output power shall not exceed 1.0 W if the hopset uses 75 or more hopping channels; the maximum peak conducted output power shall not exceed 0.125 W if the hopset uses less than 75 hopping channels. The e.i.r.p. shall not exceed 4 W, except as provided in section 5.4(e).

4.3. Test Procedure

The test follows ANSI C63.10-2013. Using the power sensor instead of a spectrum analyzer.

- Place the EUT on the table and set it in the transmitting mode.
- Remove the antenna from the EUT and then connect a low loss RF cable from the antenna port to the Power sensor.
- Test program: (S/W name: R&S Power Viewer, Version: 3.2.0)
- Measure peak power each channel.

4.4. Test Results

Ambient temperature : (23 ± 1) °C
 Relative humidity : 47 % R.H.

Operation Mode	Data Rate (Mbps)	Channel	Frequency (MHz)	Average Power Result (dB m)	Peak Power Result (dB m)	Limit (dB m)
GFSK	1	Low	2 402	0.51	1.19	20.97
		Middle	2 441	<u>1.68</u>	2.28	
		High	2 480	1.67	<u>2.39</u>	
π/4DQPSK	2	Low	2 402	-4.40	-1.01	
		Middle	2 441	-3.29	-0.05	
		High	2 480	<u>-3.15</u>	<u>0.05</u>	
8DPSK	3	Low	2 402	-4.53	-0.88	
		Middle	2 441	<u>-3.29</u>	<u>0.24</u>	
		High	2 480	-3.29	0.17	

Remark;

In the case of AFH, the limit for peak power is 0.125 W.
 Directional coupler and cable offset compensate for test program (R&S Power Viewer) before measuring.

5. Carrier Frequency Separation

5.1. Test Setup

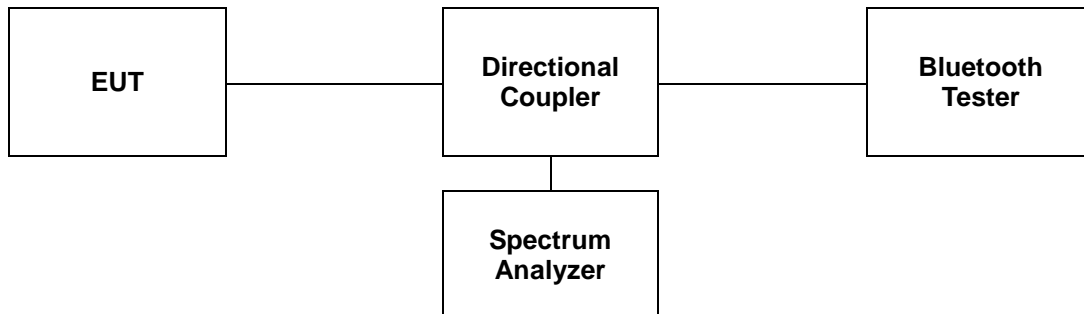

5.2. Limit

5.2.1. FCC

§15.247(a)(1), Frequency hopping systems shall have hopping channel carrier frequencies separated by a minimum of 25 kHz or the 20 dB bandwidth of the hopping channel, whichever is greater. Alternatively, frequency hopping systems operating in the 2 400-2 483.5 MHz band may have hopping channel carrier frequencies that are separated by 25 kHz or two-thirds of the 20 dB bandwidth of the hopping channel, whichever is greater, provided the systems operate with an output power no greater than 125 mW.

5.2.2. IC

According to RSS-247 Issue 2, 5.1(b), FHSs shall have hopping channel carrier frequencies separated by a minimum of 25 kHz or the 20 dB bandwidth of the hopping channel, whichever is greater. Alternatively, FHSs operating in the band 2 400-2 483.5 MHz may have hopping channel carrier frequencies that are separated by 25 kHz or two thirds of the 20 dB bandwidth of the hopping channel, whichever is greater, provided that the systems operate with an output power no greater than 0.125 W.

5.3. Test Procedure

The test follows ANSI C63.10-2013.

The device is operating in hopping mode between 79 channels and also supporting Adaptive Frequency Hopping with hopping between 20 channels. As compared with each operating mode, 79 channels are chosen as a representative for test.

Use the following spectrum analyzer settings:

1. Span: Wide enough to capture the peaks of two adjacent channels
2. RBW: Start with the RBW set to approximately 30 % of the channel spacing; adjust as necessary to best identify the center of each individual channel.
3. VBW \geq RBW
4. Sweep: Auto
5. Detector: Peak
6. Trace: Max hold
7. Allow the trace to stabilize.

Use the marker-delta function to determine the between the peaks of the adjacent channels.

5.4. Test Results

Ambient temperature : (23 ± 1) °C
 Relative humidity : 47 % R.H.

Operation Mode	Frequency (MHz)	Adjacent Hopping Channel Separation (kHz)	Two-third of 20 dB Bandwidth (kHz)
GFSK	2 441	1 000	697
8DPSK	2 441	1 000	897

Remark;

Measurement is made with EUT operating in hopping mode between 79 channels providing a worst case scenario as compared to AFH mode hopping between 20 channels.

- Test plots

Operating Mode: GFSK

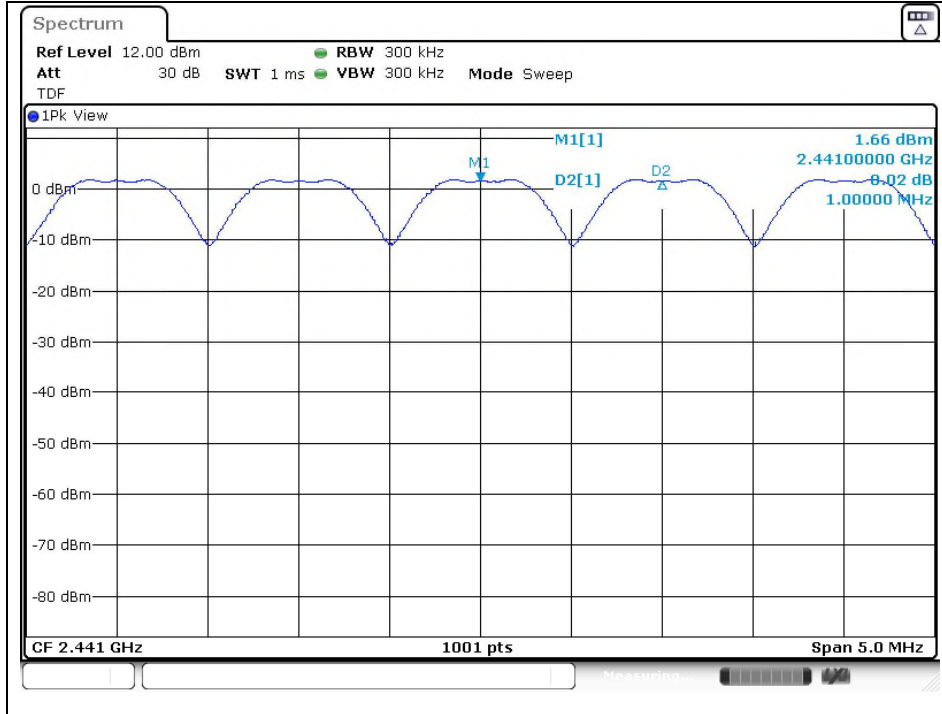

Operating Mode: 8DPSK

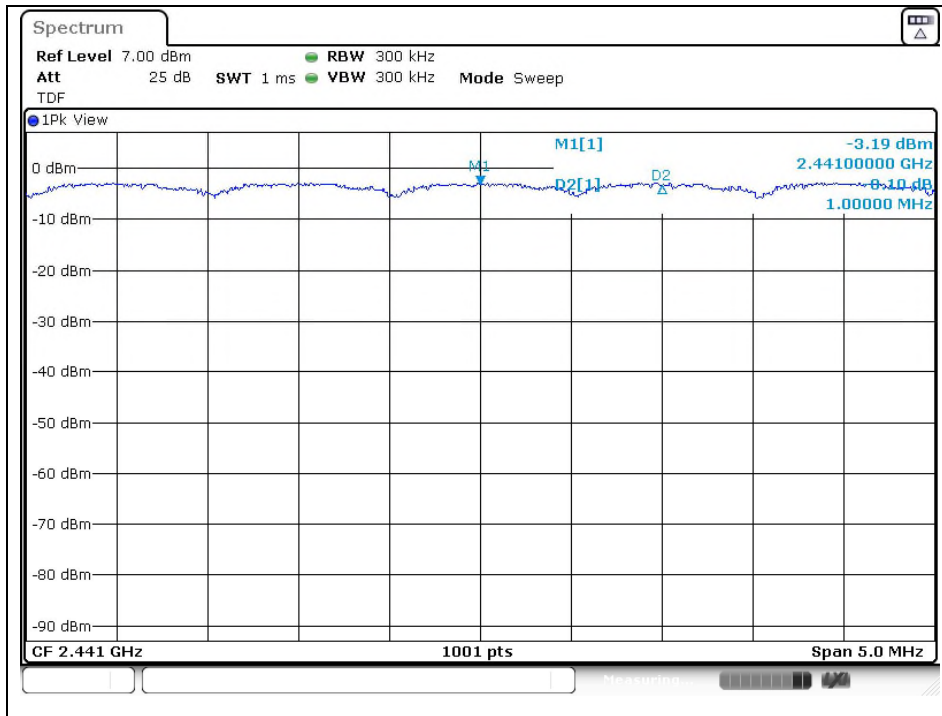

6. Number of Hopping Frequencies

6.1. Test Setup

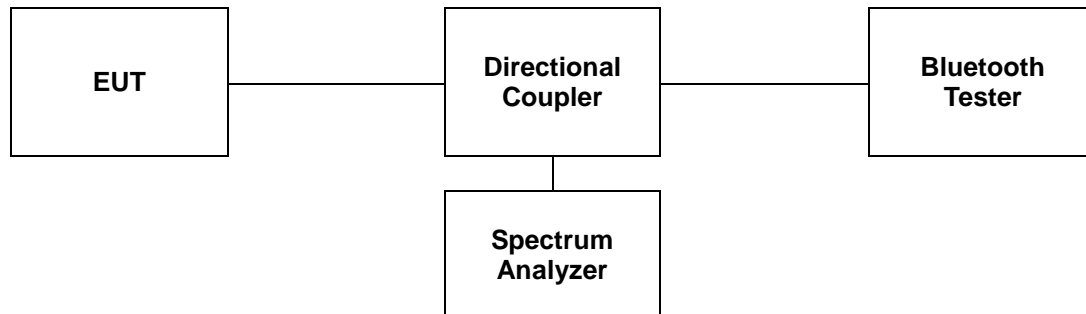

6.2. Limit

6.2.1. FCC

§15.247(a)(1)(iii), Frequency hopping systems in the 2 400-2 483.5 MHz band shall use at least 15 channels. The average time of occupancy on any channel shall not be greater than 0.4 seconds within a period of 0.4 seconds multiplied by the number of hopping channels employed. Frequency hopping systems may avoid or suppress transmissions on a particular hopping frequency provided that a minimum of 15 channels are used.

6.2.2. IC

According to RSS-247 Issue 2, 5.1(d), FHSs operating in the band 2 400-2 483.5 MHz shall use at least 15 hopping channels. The average time of occupancy on any channel shall not be greater than 0.4 seconds within a period of 0.4 seconds, multiplied by the number of hopping channels employed. Transmissions on particular hopping frequencies may be avoided or suppressed provided that at least 15 hopping channels are used.

6.3. Test Procedure

The test follows ANSI C63.10-2013.

The device supports Adaptive Frequency Hopping and will use a minimum of 20 channels of the 79 available channels.

The EUT shall have its hopping function enabled. Use the following spectrum analyzer settings:

1. Span: The frequency band of operation. Depending on the number of channels the device supports, it may be necessary to divide the frequency range of operation across multiple spans, to allow the individual channels to be clearly seen.
2. RBW: To identify clearly the individual channels, set the RBW to less than 30 % of the channel spacing or the 20 dB bandwidth, whichever is smaller.
3. VBW \geq RBW
4. Sweep: Auto
5. Detector function: Peak
6. Trace: Max hold
7. Allow the trace to stabilize.

6.4. Test Results

Ambient temperature : (23 ± 1) °C
Relative humidity : 47 % R.H.

Operation Mode	Number of Hopping Frequency	Limit
GFSK	79	≥ 15
8DPSK	79	≥ 15

Remark;

Measurement is made with EUT operating in hopping mode between 79 channels providing a worst case scenario as compared to AFH mode hopping between 20 channels.

- Test plots

Operating Mode: GFSK

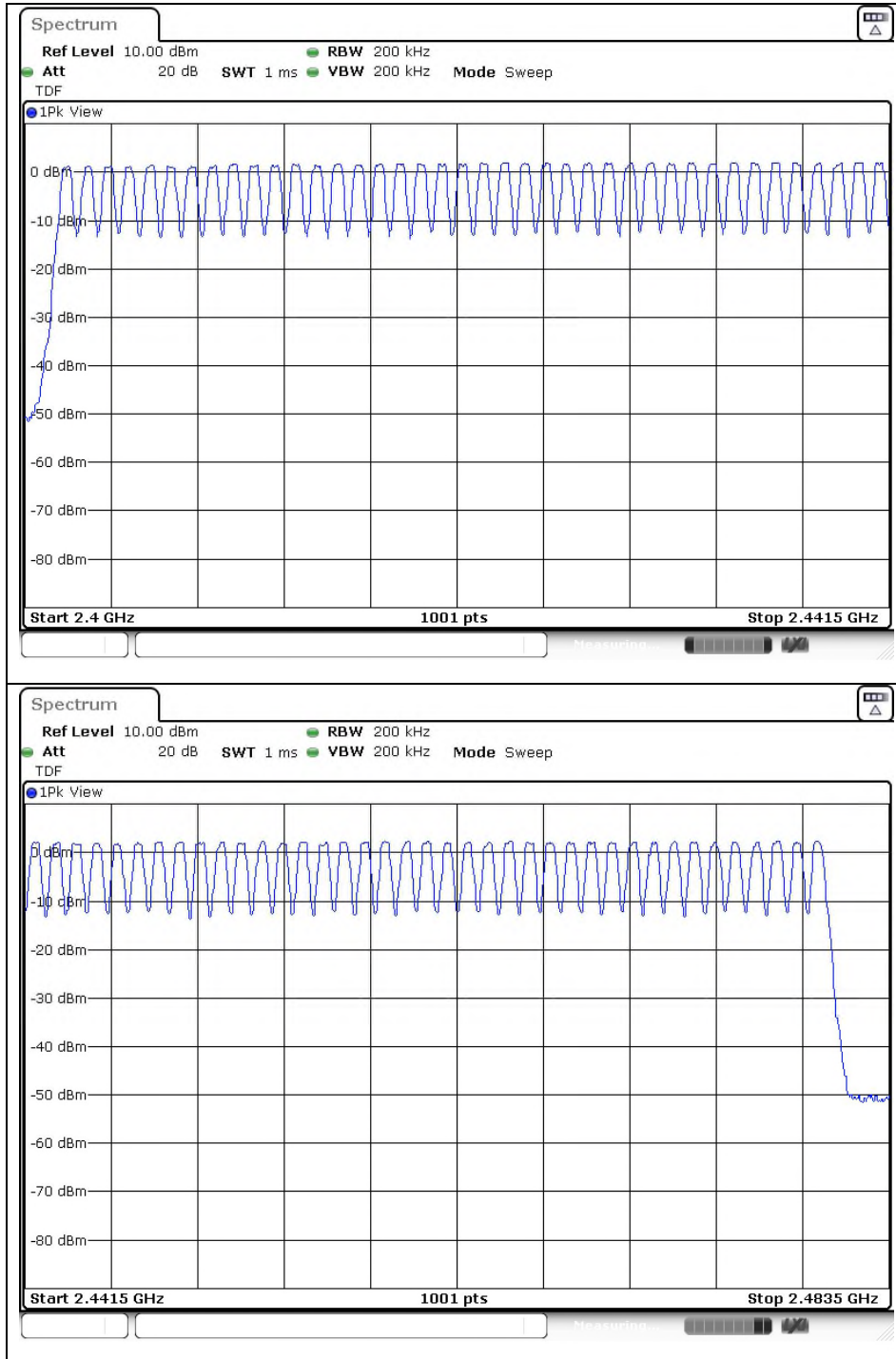

Operating Mode: 8DPSK

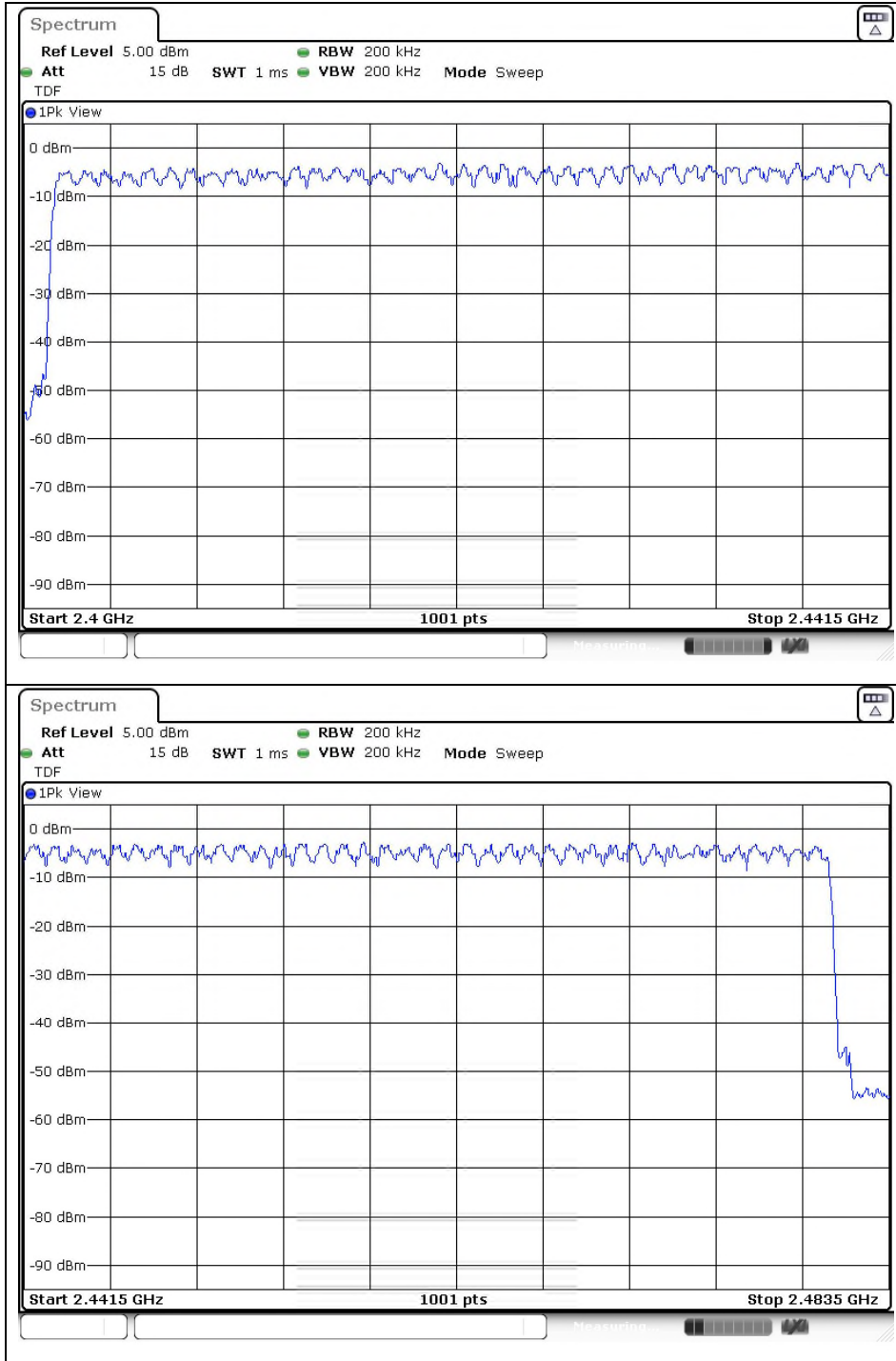

7. Time of Occupancy (Dwell Time)

7.1. Test Set up

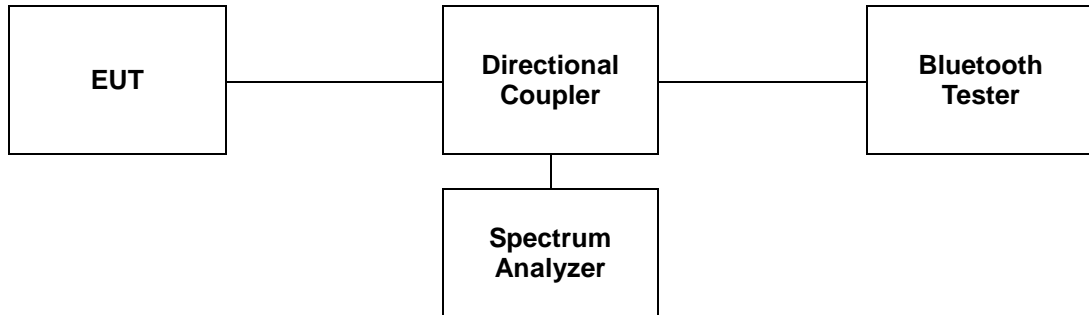

7.2. Limit

7.2.1. FCC

§15.247(a)(1)(iii), Frequency hopping systems in the 2 400-2 483.5 MHz band, the average time of occupancy on any frequency shall not be greater than 0.4 second within a 31.6 second period.

7.2.2. IC

According to RSS-247 Issue 2, 5.1(d), FHSs operating in the band 2 400-2 483.5 MHz shall use at least 15 hopping channels. The average time of occupancy on any channel shall not be greater than 0.4 seconds within a period of 0.4 seconds, multiplied by the number of hopping channels employed. Transmissions on particular hopping frequencies may be avoided or suppressed provided that at least 15 hopping channels are used.

A period time = 0.4 (s) * 79 = 31.6 (s)

*Adaptive Frequency Hopping

A period time = 0.4 (s) * 20 = 8 (s)

7.3. Test Procedure

All data rates and modes were investigated for this test. The full data for the worst case data rate are reported in this section. The test follows ANSI C63.10-2013.

1. Check the calibration of the measuring instrument using either an internal calibrator or a known signal from an external generator.
2. Position the EUT as shown in test setup without connection to measurement instrument. Turn on the EUT and connect its antenna terminal to measurement instrument via a low loss cable.
3. Measure the time duration of one transmission on the measured frequency. And then plot the result with time difference of this time duration.
4. The Bluetooth has 3 type of payload, DH1, DH3, DH5 and 3DH1, 3DH3, 3DH5. The hopping rate is insisted of 1 600 per second.

The EUT must have its hopping function enabled. Use the following spectrum analyzer setting:

1. Span = Zero span, centered on a hopping channel.
2. RBW = 1 MHz.
3. VBW \geq RBW.
4. Sweep = As necessary to capture the entire dwell time per hopping channel.
5. Detector = Peak.
6. Trace = Max hold.

Use the marker-delta function to determine the dwell time. If this value varies with different modes of operation, then repeat this test for each variation.

7.4. Test Results

Ambient temperature : (23 ± 1) °C
 Relative humidity : 47 % R.H.

7.4.1. Packet Type: DH1, 3DH1

Operation Mode	Frequency (MHz)	Dwell Time (ms)	Time of occupancy on the Tx Channel in 31.6 sec (ms)	Limit for time of occupancy on the Tx Channel in 31.6 sec (ms)
GFSK	2 441	0.39	124.80	400
8DPSK	2 441	0.39	124.80	400

Remark;

Time of occupancy on the TX channel in 31.6 sec
 In case of GFSK and 8DPSK: $0.39 \times \{(1\ 600 \div 2) / 79\} \times 31.6 = 124.80$ ms

- Test plots

Operating Mode: GFSK

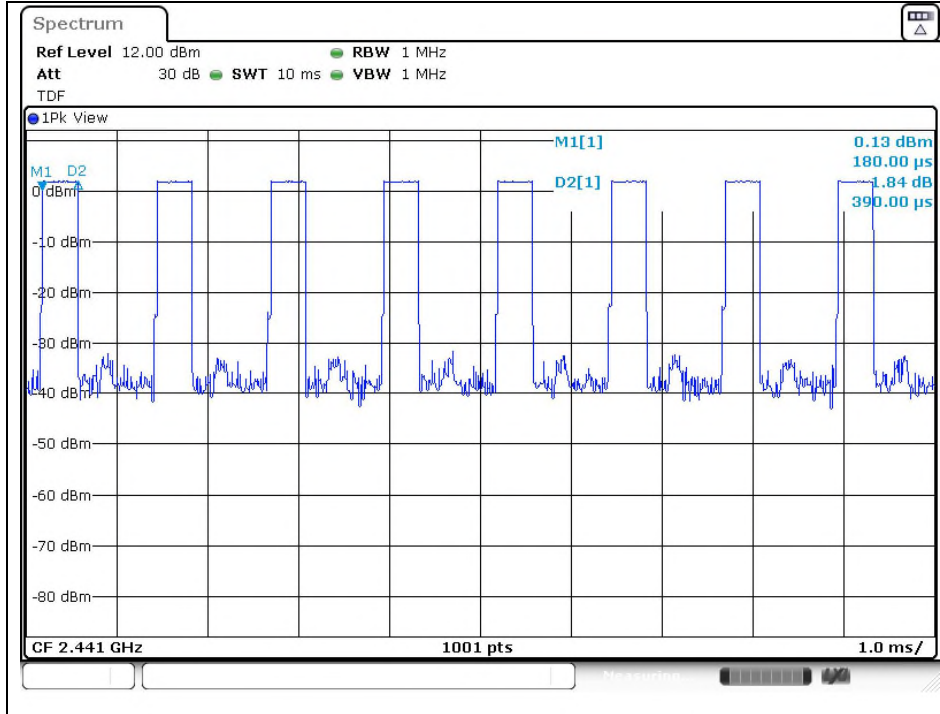

Operating Mode: 8DPSK

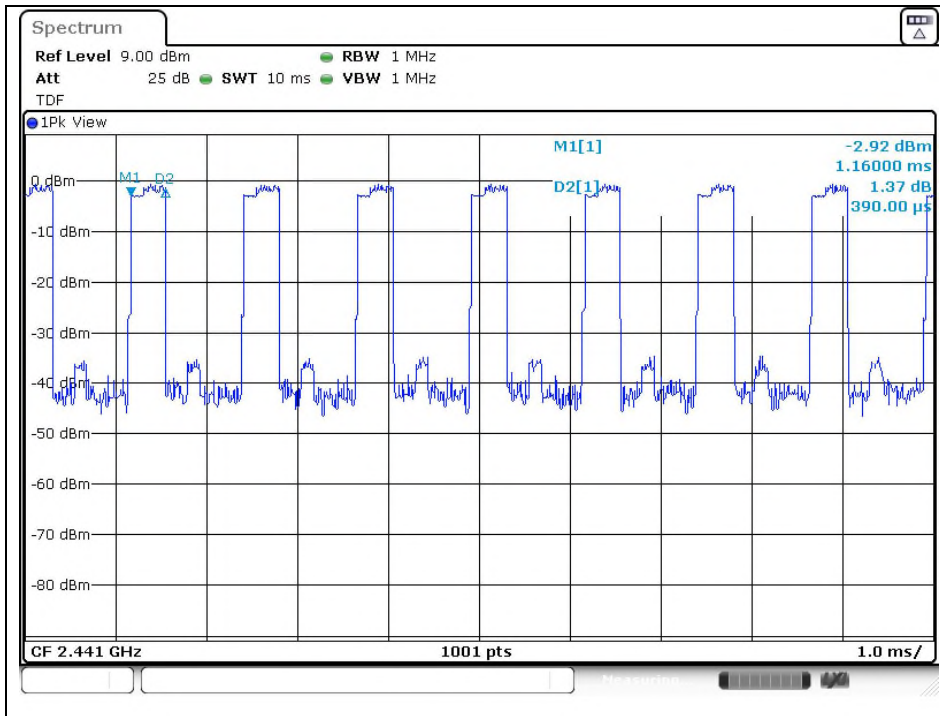

7.4.2. Packet Type: DH3, 3DH3

Operation Mode	Frequency (MHz)	Dwell Time (ms)	Time of occupancy on the Tx Channel in 31.6 sec (ms)	Limit for time of occupancy on the Tx Channel in 31.6 sec (ms)
GFSK	2 441	1.65	264	400
8DPSK	2 441	1.65	264	400

Remark;

Time of occupancy on the TX channel in 31.6 sec

In case of GFSK and 8DPSK: $1.65 \times \{(1\ 600 \div 4) / 79\} \times 31.6 = 264 \text{ ms}$

- Test plots

Operating Mode: GFSK

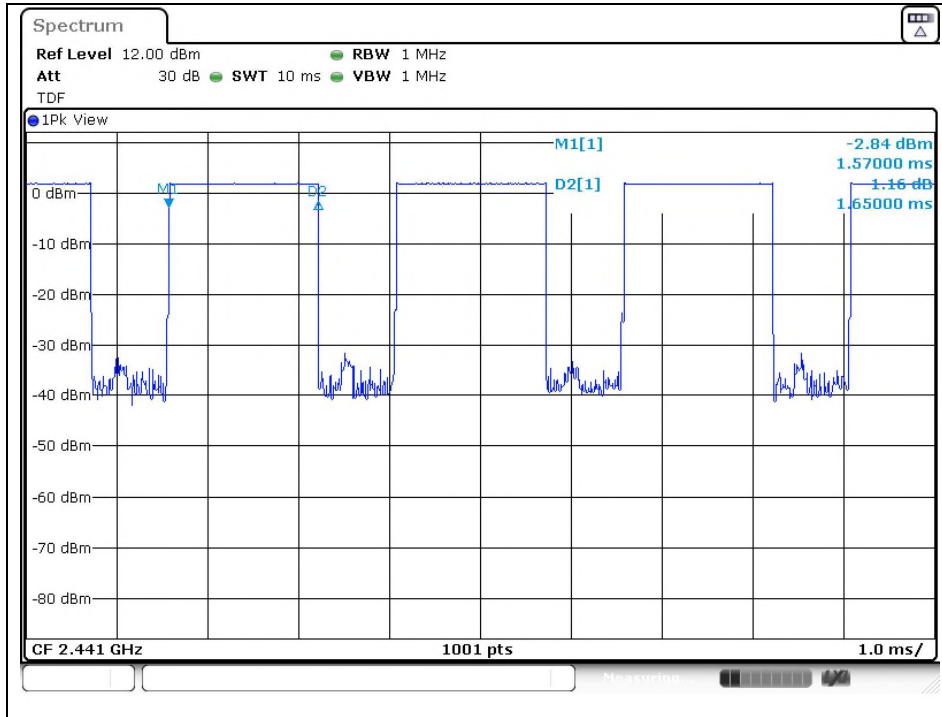

Operating Mode: 8DPSK

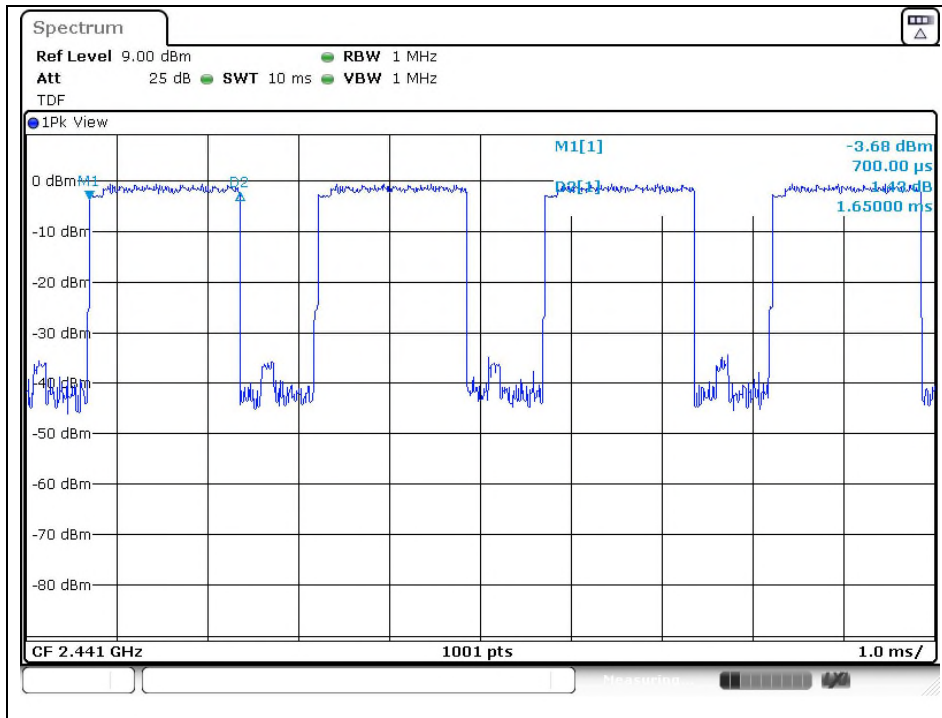

7.4.3. Packet Type: DH5, 3DH5

Operation Mode	Frequency (MHz)	Dwell Time (ms)	Time of occupancy on the Tx Channel in 31.6 sec (ms)	Limit for time of occupancy on the Tx Channel in 31.6 sec (ms)
GFSK	2 441	2.89	308.27	400
8DPSK	2 441	2.89	308.27	400

Remark;

Time of occupancy on the TX channel in 31.6 sec

In case of GFSK and 8DPSK: $2.89 \times \{(1\ 600 \div 6) / 79\} \times 31.6 = 308.27$ ms

- Test plots

Operating Mode: GFSK

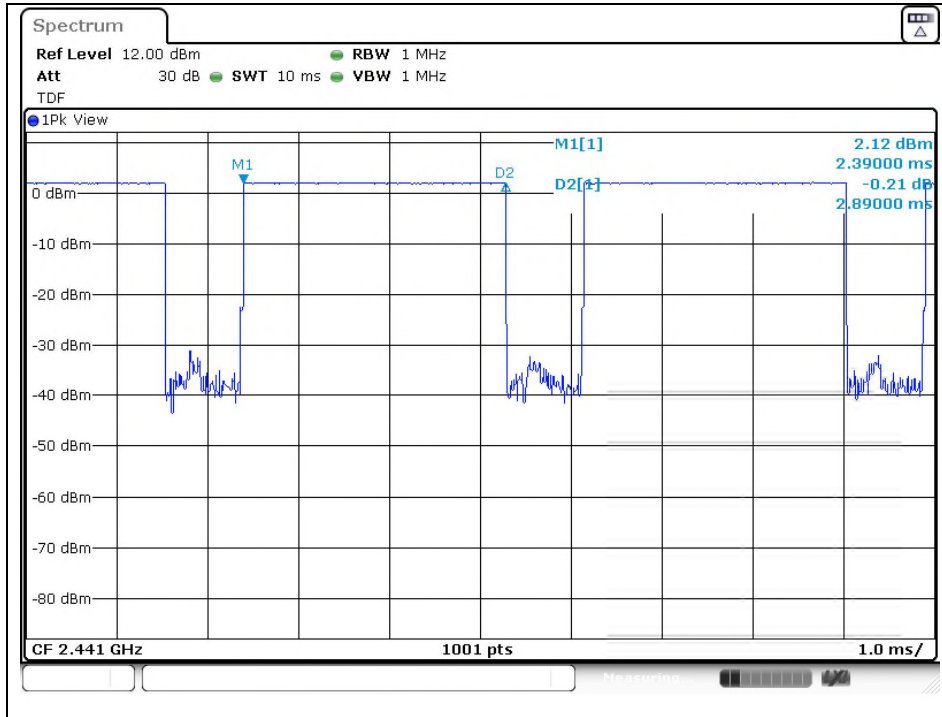

Operating Mode: 8DPSK

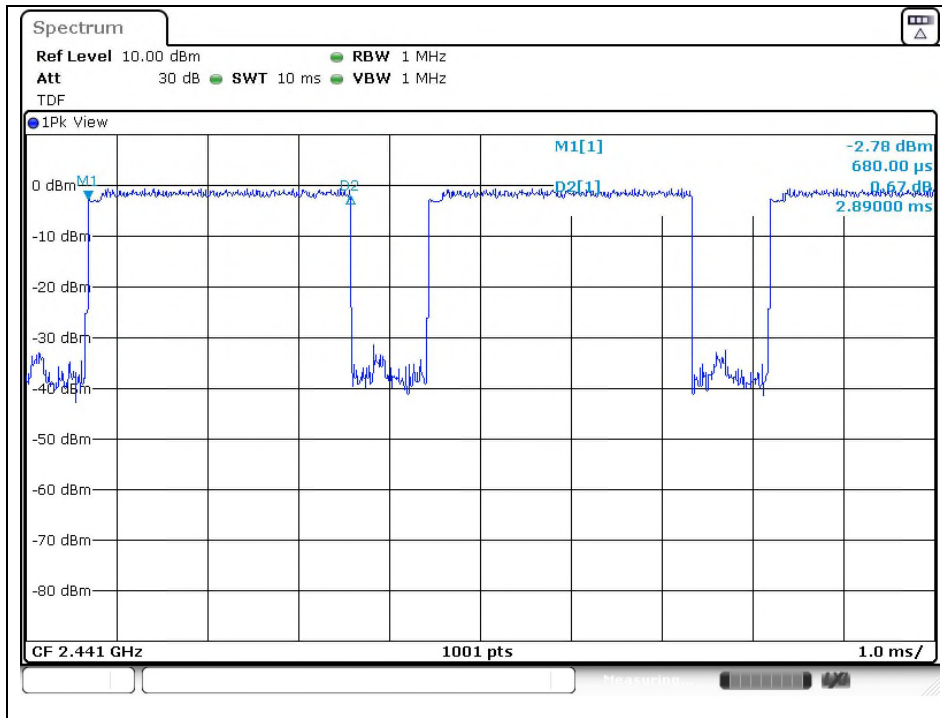

7.4.4. Packet Type: DH1, 3DH1 (Adaptive Frequency Hopping)

Operation Mode	Frequency (MHz)	Dwell Time (ms)	Time of occupancy on the Tx Channel in 8 sec (ms)	Limit for time of occupancy on the Tx Channel in 8 sec (ms)
GFSK	2 441	0.38	60.80	400
8DPSK	2 441	0.39	62.40	400

Remark;

Time of occupancy on the TX channel in 8 sec

In case of GFSK: $0.38 \times \{(800 \div 2) / 20\} \times 8 = 60.80 \text{ ms}$

In case of 8DPSK: $0.39 \times \{(800 \div 2) / 20\} \times 8 = 62.40 \text{ ms}$

- Test plots

Operating Mode: GFSK

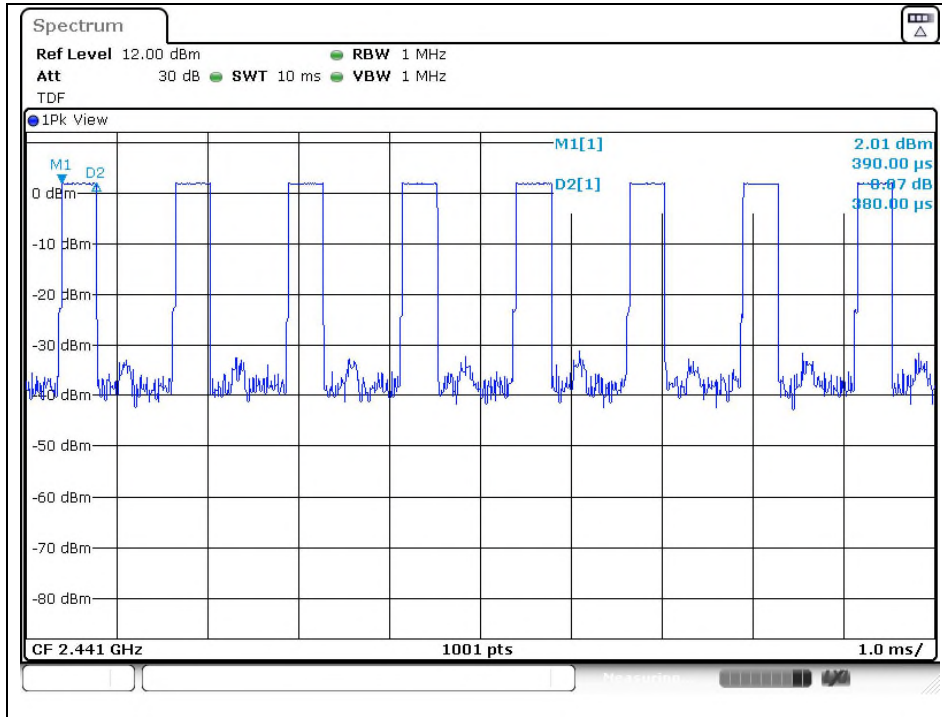

Operating Mode: 8DPSK

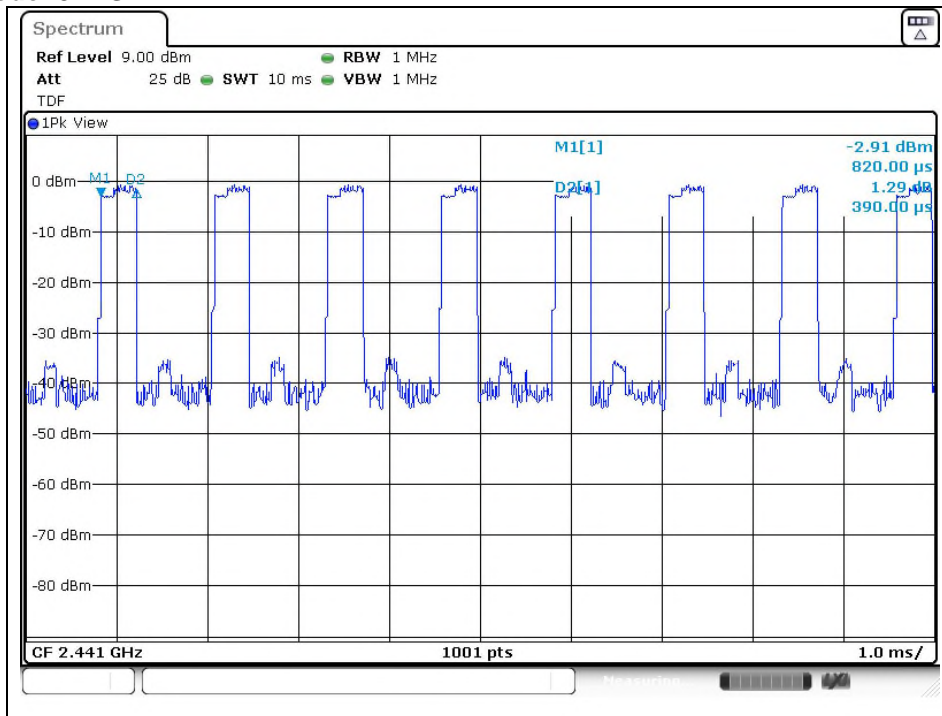

7.4.5. Packet Type: DH3, 3DH3 (Adaptive Frequency Hopping)

Operation Mode	Frequency (MHz)	Dwell Time (ms)	Time of occupancy on the Tx Channel in 8 sec (ms)	Limit for time of occupancy on the Tx Channel in 8 sec (ms)
GFSK	2 441	1.64	131.20	400
8DPSK	2 441	1.64	131.20	400

Remark;

Time of occupancy on the TX channel in 8 sec

In case of GFSK and 8DPSK: $1.64 \times \{(800 \div 4) / 20\} \times 8 = 131.20$ ms

- Test plots

Operating Mode: GFSK

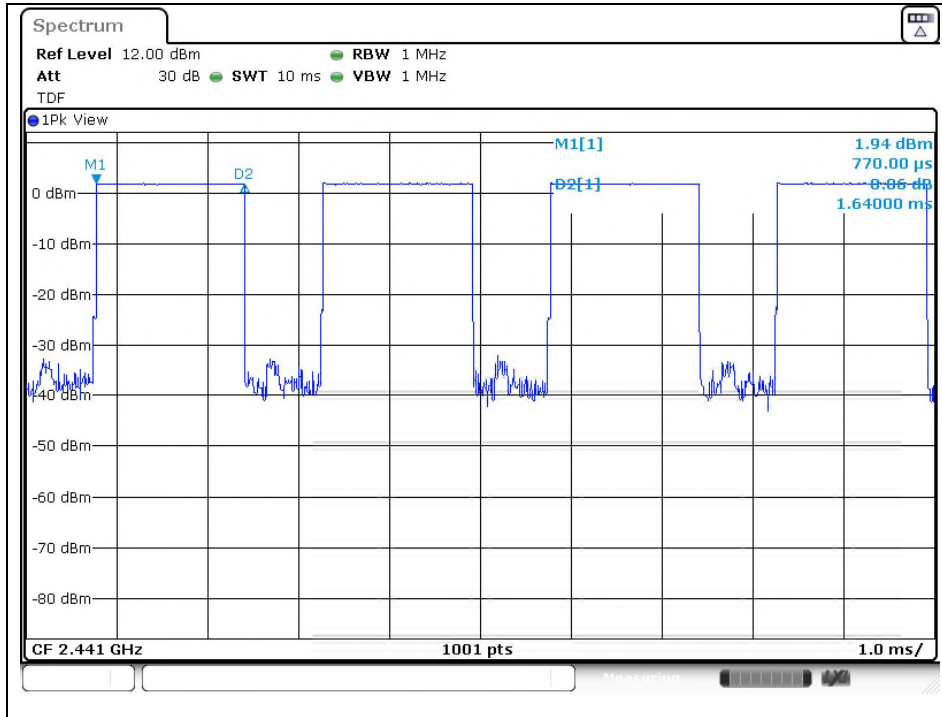

Operating Mode: 8DPSK

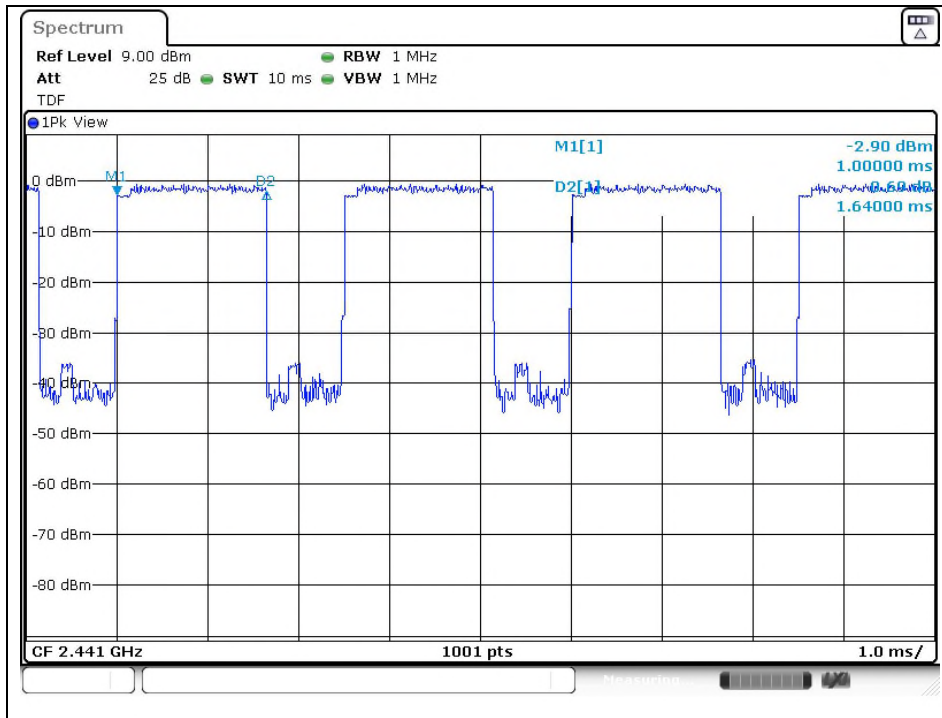

7.4.6. Packet Type: DH5, 3DH5 (Adaptive Frequency Hopping)

Operation Mode	Frequency (MHz)	Dwell Time (ms)	Time of occupancy on the Tx Channel in 8 sec (ms)	Limit for time of occupancy on the Tx Channel in 8 sec (ms)
GFSK	2 441	2.89	154.13	400
8DPSK	2 441	2.90	154.67	400

Remark;

Time of occupancy on the TX channel in 8 sec

In case of GFSK: $2.89 \times \{(800 \div 6) / 20\} \times 8 = 154.13$ ms

In case of 8DPSK: $2.90 \times \{(800 \div 6) / 20\} \times 8 = 154.67$ ms

- Test plots

Operating Mode: GFSK

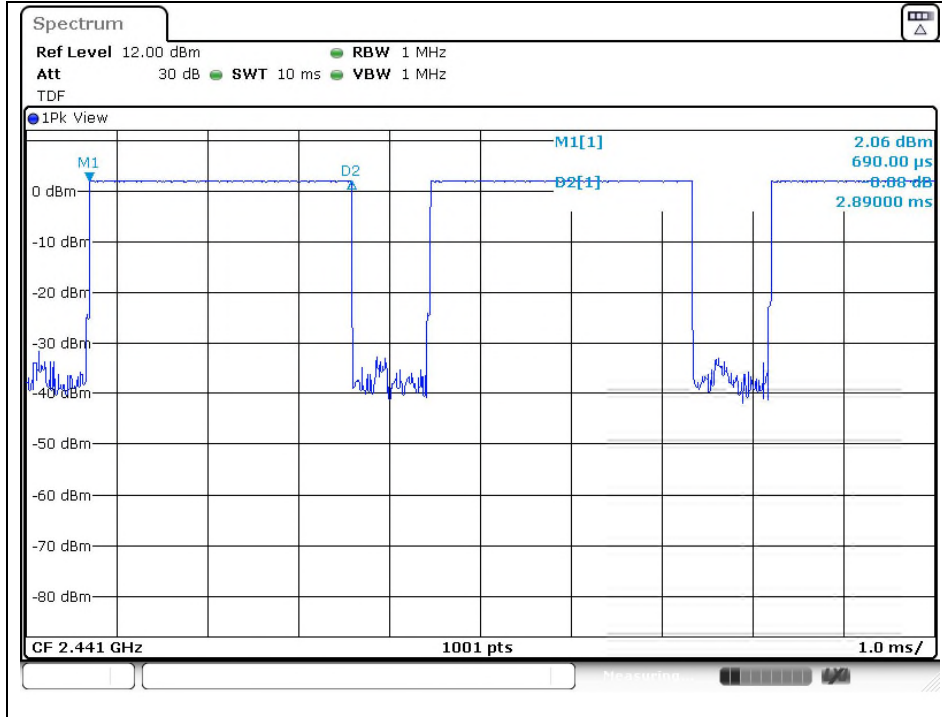

Operating Mode: 8DPSK

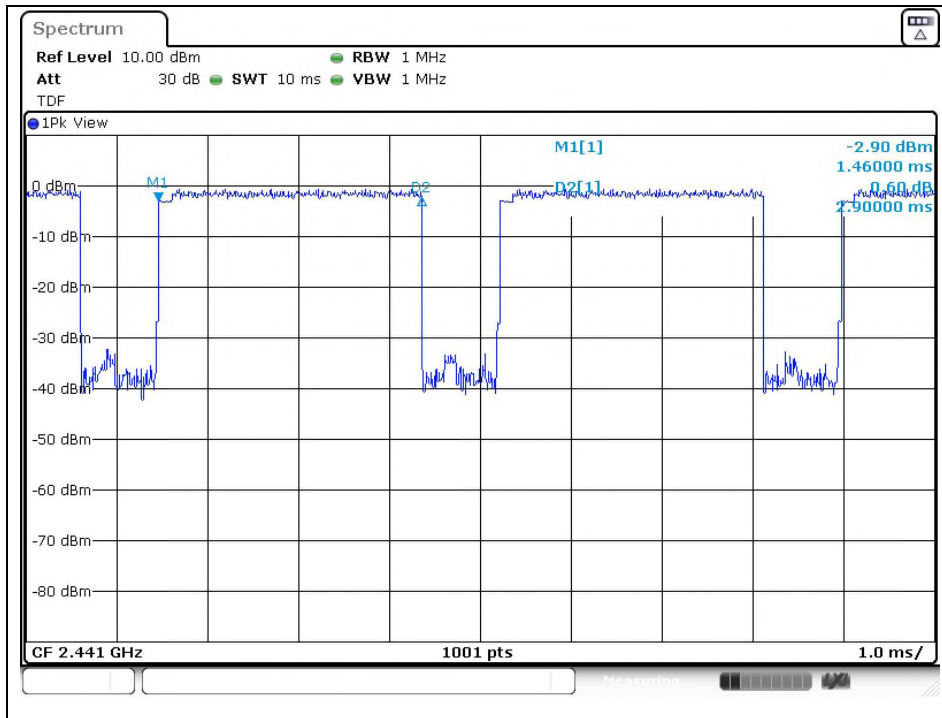

8. Antenna Requirement

8.1. Standard Applicable

For intentional device, according to FCC 47 CFR Section §15.203, an intentional radiator shall be designed to ensure that no antenna other than that furnished by the responsible party shall be used with the device. And according to FCC 47 CFR Section §15.247(b) if transmitting antennas of directional gain greater than 6 dB i are used, the power shall be reduced by the amount in dB that the gain of the antenna exceeds 6 dB i.

8.2. Antenna Connected Construction

Antenna used in this product is Pattern antenna with gain of -0.18 dB i

- End of the Test Report -