

# TEST REPORT

of

FCC Part 15 Subpart C §15.247

FCC ID: TQ8-ADB20F6AN

Equipment Under Test : DISPLAY CAR SYSTEM  
 Model Name : ADB20F6AN  
 Variant Model Name : ADB11F6GU  
 Applicant : Hyundai Mobis Co., Ltd.  
 Manufacturer : Hyundai Mobis Co., Ltd.  
 Date of Receipt : 2019.07.31  
 Date of Test(s) : 2019.08.01 ~ 2019.08.21  
 Date of Issue : 2019.08.22

In the configuration tested, the EUT complied with the standards specified above.

**Tested By:**



Nancy Park

**Date:**

2019.08.22

**Technical Manager:**



Jungmin Yang

**Date:**

2019.08.22

*The results of this test report are effective only to the items tested. The SGS Korea is not responsible for the sampling, the results of this test report apply to the sample as received. This test report cannot be reproduced, except in full, without prior written permission of the Company. This test report does not assure KOLAS accreditation.*

SGS Korea Co., Ltd. (Gunpo Laboratory) 4, LS-ro 182beon-gil, Gunpo-si, Gyeonggi-do, Korea, 15807 <http://www.sgsgroup.kr>

# INDEX

<u>Table of Contents</u>	Page
1. General Information -----	3
2. Transmitter Radiated Spurious Emissions and Conducted Spurious Emission -----	10
3. 20 dB Bandwidth -----	36
4. Maximum Peak Conducted Output Power -----	43
5. Carrier Frequency Separation -----	45
6. Number of Hopping Frequencies -----	48
7. Time of Occupancy(Dwell Time) -----	52
8. Antenna Requirement -----	66

*The results of this test report are effective only to the items tested. The SGS Korea is not responsible for the sampling, the results of this test report apply to the sample as received. This test report cannot be reproduced, except in full, without prior written permission of the Company. This test report does not assure KOLAS accreditation.*

**SGS Korea Co., Ltd. (Gunpo Laboratory)** 4, LS-ro 182beon-gil, Gunpo-si, Gyeonggi-do, Korea, 15807 <http://www.sgsgroup.kr>

## 1. General Information

### 1.1. Testing Laboratory

SGS Korea Co., Ltd. (Gunpo Laboratory)

- 10-2, LS-ro 182beon-gil, Gunpo-si, Gyeonggi-do, Korea, 15807
- 4, LS-ro 182beon-gil, Gunpo-si, Gyeonggi-do, Korea, 15807
- Designation number: KR0150

All SGS services are rendered in accordance with the applicable SGS conditions of service available on request and accessible at <http://www.sgs.com/en/Terms-and-Conditions.aspx>.

Phone No. : +82 31 688 0901

Fax No. : +82 31 688 0921

### 1.2. Details of Applicant

Applicant : Hyundai Mobis Co., Ltd.

Address : 203, Teheran-ro, Gangnam-gu, Seoul, South Korea, 135-977

Contact Person : Choe, Seung-hoon

Phone No. : +82 31 260 0098

### 1.3. Details of Manufacturer

Company : Same as applicant

Address : Same as applicant

### 1.4. Description of EUT

<b>Kind of Product</b>	DISPLAY CAR SYSTEM
<b>Model Name</b>	ADB20F6AN
<b>Variant Model Name</b>	ADB11F6GU
<b>Power Supply</b>	DC 14.4 V
<b>Frequency Range</b>	2 402 MHz ~ 2 480 MHz (Bluetooth)
<b>Modulation Technique</b>	GFSK, $\pi/4$ DQPSK, 8DPSK
<b>Number of Channels</b>	79 channels (Bluetooth)
<b>Antenna Type</b>	Pattern antenna
<b>Antenna Gain</b>	-0.18 dB i

*The results of this test report are effective only to the items tested. The SGS Korea is not responsible for the sampling, the results of this test report apply to the sample as received. This test report cannot be reproduced, except in full, without prior written permission of the Company. This test report does not assure KOLAS accreditation.*

**SGS Korea Co., Ltd. (Gunpo Laboratory)** 4, LS-ro 182beon-gil, Gunpo-si, Gyeonggi-do, Korea, 15807 <http://www.sgsgroup.kr>

## 1.5. Test Equipment List

Equipment	Manufacturer	Model	S/N	Cal. Date	Cal. Interval	Cal. Due
Signal Generator	R&S	SMR40	100272	Jun. 07, 2019	Annual	Jun. 07, 2020
Signal Generator	R&S	SMBV100A	255834	Jun. 10, 2019	Annual	Jun. 10, 2020
Spectrum Analyzer	R&S	FSV30	103210	Dec. 05, 2018	Annual	Dec. 05, 2019
Spectrum Analyzer	Agilent	N9020A	MY53421758	Sep. 21, 2018	Annual	Sep. 21, 2019
Bluetooth Tester	TESCOM	TC-3000C	3000C000296	Jun. 05, 2019	Annual	Jun. 05, 2020
Directional Coupler	KRYTAR	152613	122660	Jun. 12, 2019	Annual	Jun. 12, 2020
High Pass Filter	Wainwright Instrument GmbH	WHK3.0/18G-10SS	344	May 21, 2019	Annual	May 21, 2020
High Pass Filter	Wainwright Instrument GmbH	WHNX7.5/26.5G-6SS	15	Jun. 05, 2019	Annual	Jun. 05, 2020
Low Pass Filter	Mini-Circuits	NLP-1200+	V 8979400903-2	Feb. 19, 2019	Annual	Feb. 19, 2020
Power Sensor	R&S	NRP-Z81	100748	Jun. 05, 2019	Annual	Jun. 05, 2020
DC Power Supply	R&S	HMP2020	019258024	Nov. 06, 2018	Annual	Nov. 06, 2019
Preamplifier	H.P.	8447F	2944A03909	Aug. 07, 2019	Annual	Aug. 07, 2020
Signal Conditioning Unit	R&S	SCU-18	10117	Jun. 12, 2019	Annual	Jun. 12, 2020
Preamplifier	MITEQ Inc.	JS44-18004000-35-8P	1546891	May 13, 2019	Annual	May 13, 2020
Loop Antenna	Schwarzbeck Mess-Elektronik	FMZB 1519	1519-039	Aug. 23, 2017	Biennial	Aug. 23, 2019
Bilog Antenna	Schwarzbeck Mess-Elektronik	VULB 9163	396	Mar. 21, 2019	Biennial	Mar. 21, 2021
Horn Antenna	R&S	HF906	100326	Feb. 14, 2018	Biennial	Feb. 14, 2020
Horn Antenna	Schwarzbeck Mess-Elektronik	BBHA 9170	BBHA9170431	Sep. 10, 2018	Biennial	Sep. 10, 2020
Test Receiver	R&S	ESU26	100109	Jan. 31, 2019	Annual	Jan. 31, 2020
Turn Table	Innco systems GmbH	DS 1200 S	N/A	N.C.R.	N/A	N.C.R.
Controller	Innco systems GmbH	CONTROLLER CO3000-4P	CO3000/963/383 30516/L	N.C.R.	N/A	N.C.R.
Antenna Mast	Innco systems GmbH	MA4640-XP-ET	MA4640/536/383 30516/L	N.C.R.	N/A	N.C.R.
Anechoic Chamber	SY Corporation	L x W x H (9.6 m x 6.4 m x 6.6 m)	N/A	N.C.R.	N/A	N.C.R.
Coaxial Cable	SUCOFLEX	104 (3 m)	MY3258414	Jul. 20, 2019	Semi-annual	Jan. 20, 2020
Coaxial Cable	SUCOFLEX	104 (10 m)	MY3145814	Jul. 20, 2019	Semi-annual	Jan. 20, 2020
Coaxial Cable	Rosenberger	LA1-C006-1500	131014 01/20	Feb. 28, 2019	Semi-annual	Aug. 28, 2019
Coaxial Cable	Rosenberger	LA1-C006-1500	131014 05/20	Feb. 28, 2019	Semi-annual	Aug. 28, 2019
Coaxial Cable	Rosenberger	LA1-C006-1500	131014 10/20	Feb. 28, 2019	Semi-annual	Aug. 28, 2019

The results of this test report are effective only to the items tested. The SGS Korea is not responsible for the sampling, the results of this test report apply to the sample as received. This test report cannot be reproduced, except in full, without prior written permission of the Company. This test report does not assure KOLAS accreditation.

SGS Korea Co., Ltd. (Gunpo Laboratory) 4, LS-ro 182beon-gil, Gunpo-si, Gyeonggi-do, Korea, 15807 <http://www.sgsgroup.kr>

## 1.6. Declaration by the Manufacturer

- Adaptive Frequency Hopping is supported and use at least 20 channels.

## 1.7. Information about the FHSS characteristics:

### 1.7.1. Pseudorandom Frequency Hopping Sequence

The channel is represented by a pseudo-random hopping sequence hopping through the 79 RF channels. The hopping sequence is unique for the piconet and is determined by the Bluetooth device address of the master; the phase in the hopping sequence is determined by the Bluetooth clock of the master. The channel is divided into time slots where each slot corresponds to an RF hop frequency. Consecutive hops correspond to different RF hop frequencies. The nominal hop rate is 1 600 hops/s.

### 1.7.2. Equal Hopping Frequency Use

The channels of this system will be used equally over the long-term distribution of the hopsets.

### 1.7.3. Example of a 79 hopping sequence in data mode:

02, 05, 31, 24, 20, 10, 43, 36, 30, 23, 40, 06, 21, 50, 44, 09, 71, 78, 01, 13, 73, 07, 70, 72, 35, 62, 42, 11, 41, 08, 16, 29, 60, 15, 34, 61, 58, 04, 67, 12, 22, 53, 57, 18, 27, 76, 39, 32, 17, 77, 52, 33, 56, 46, 37, 47, 64, 49, 45, 38, 69, 14, 51, 26, 79, 19, 28, 65, 75, 54, 48, 03, 25, 66, 05, 16, 68, 74, 59, 63, 55

### 1.7.4. System Receiver Input Bandwidth

Each channel bandwidth is 1 MHz.

The system receivers have input bandwidths that match the hopping channel bandwidths of their corresponding transmitters and shift frequencies in synchronization with the transmitted signals.

### 1.7.5. Equipment Description

15.247(a)(1) that the Rx input bandwidths shift frequencies in synchronization with the transmitted signals.

15.247(g): In accordance with the Bluetooth Industry Standard, the system is designed to comply with all of the regulations in Section 15.247 when the transmitter is presented with a continuous data (or information) system.

15.247(h): In accordance with the Bluetooth Industry Standard, the system does not coordinate its channels selection/ hopping sequence with other frequency hopping systems for the express purpose of avoiding the simultaneous occupancy of individual hopping frequencies by multiple transmitters.

---

*The results of this test report are effective only to the items tested. The SGS Korea is not responsible for the sampling, the results of this test report apply to the sample as received. This test report cannot be reproduced, except in full, without prior written permission of the Company. This test report does not assure KOLAS accreditation.*

**SGS Korea Co., Ltd. (Gunpo Laboratory)** 4, LS-ro 182beon-gil, Gunpo-si, Gyeonggi-do, Korea, 15807 <http://www.sgsgroup.kr>

RTT5041-19(2019.04.24)(1)

Tel. +82 31 428 5700 / Fax. +82 31 427 2370

A4(210 mm x 297 mm)

## 1.8. Summary of Test Results

The EUT has been tested according to the following specifications:

APPLIED STANDARD: FCC Part15 Subpart C		
Section	Test Item	Result
15.205(a) 15.209 15.247(d)	Transmitter Radiated Spurious Emissions and Conducted Spurious Emission	Complied
15.247(a)(1)	20 dB Bandwidth	Complied
15.247(b)(1)	Maximum Peak Conducted Output Power	Complied
15.247(a)(1)	Carrier Frequency Separation	Complied
15.247(a)(1)(iii)	Number of Hopping Frequencies	Complied
15.247(a)(1)(iii)	Time of Occupancy (Dwell Time)	Complied

## 1.9. Information of Variant Model

Model	Model Name	BT	WIFI	HD	RDS	GPS	AA/CP	Rear Camera	AMP
Basic Model	ADB20F6AN	O	O	O	X	O	O	O	Interior
Variant Model	ADB11F6GU	O	O	X	X	O	O	O	Interior

*The results of this test report are effective only to the items tested. The SGS Korea is not responsible for the sampling, the results of this test report apply to the sample as received. This test report cannot be reproduced, except in full, without prior written permission of the Company. This test report does not assure KOLAS accreditation.*

**SGS Korea Co., Ltd. (Gunpo Laboratory)** 4, LS-ro 182beon-gil, Gunpo-si, Gyeonggi-do, Korea, 15807 <http://www.sgsgroup.kr>

### 1.10. Test Procedure(s)

The measurement procedures described in the American National Standard of Procedure for Compliance Testing of unlicensed Wireless Devices (ANSI C63.10-2013) and the guidance provided in KDB 558074 D01 15.247 Meas Guidance v05r02 were used in the measurement of the DUT.

### 1.11. Sample Calculation

Where relevant, the following sample calculation is provided:

#### 1.11.1. Conducted Test

Offset value (dB) = Directional coupler (dB) + Cable loss (dB)

#### 1.11.2. Radiation Test

Field strength level (dB $\mu$ V/m) = Measured level (dB $\mu$ V) + Antenna factor (dB) + Cable loss (dB) - Amplifier gain (dB)

### 1.12. Measurement Uncertainty

Where relevant, the following measurement uncertainty levels have been estimated for tests performed on the apparatus:

Parameter	Uncertainty
RF Output Power	± 0.40 dB
Occupied Bandwidth	± 9.66 kHz
Conducted Spurious Emission	± 0.76 dB
Radiated Emission, 9 kHz to 30 MHz	± 3.59 dB
Radiated Emission, below 1 GHz	± 5.88 dB
Radiated Emission, above 1 GHz	± 5.94 dB

Uncertainty figures are valid to a confidence level of 95 %.

### 1.13. Test Report Revision

Revision	Report Number	Date of Issue	Description
0	F690501/RF-RTL014289	2019.08.22	Initial

*The results of this test report are effective only to the items tested. The SGS Korea is not responsible for the sampling, the results of this test report apply to the sample as received. This test report cannot be reproduced, except in full, without prior written permission of the Company. This test report does not assure KOLAS accreditation.*

**SGS Korea Co., Ltd. (Gunpo Laboratory)** 4, LS-ro 182beon-gil, Gunpo-si, Gyeonggi-do, Korea, 15807 <http://www.sgsgroup.kr>

### 1.14. Descriptions of Test Mode

Preliminary tests were performed in different data rates and recorded the RF output power in the following table:

Operation Mode	Data Rate (Mbps)	Channel	Frequency (MHz)	RF Output Power (dB m)
GFSK	1	Low	2 402	2.30
		Middle	2 441	2.84
		High	2 480	<b><u>3.05</u></b>
$\pi/4$ DQPSK	2	Low	2 402	-0.86
		Middle	2 441	0.29
		High	2 480	<b><u>0.38</u></b>
8DPSK	3	Low	2 402	-0.50
		Middle	2 441	0.20
		High	2 480	<b><u>0.56</u></b>

**Note;**

1. For transmitter radiated spurious emissions, conducted spurious emission, carrier frequency separation and number of hopping frequencies, GFSK / DH5 and 8DPSK / 3DH5 are tested as worst condition.
2. For 20 dB bandwidth and maximum peak conducted output power, GFSK / DH5,  $\pi/4$ DQPSK / 2DH5 and 8DPSK / 3DH5 are tested as worst condition.
3. For Time of Occupancy, GFSK / DH1, DH3, DH5 and 8DPSK / 3DH1, 3DH3, 3DH5 are tested as worst condition.

*The results of this test report are effective only to the items tested. The SGS Korea is not responsible for the sampling, the results of this test report apply to the sample as received. This test report cannot be reproduced, except in full, without prior written permission of the Company. This test report does not assure KOLAS accreditation.*

**SGS Korea Co., Ltd. (Gunpo Laboratory)** 4, LS-ro 182beon-gil, Gunpo-si, Gyeonggi-do, Korea, 15807 <http://www.sgsgroup.kr>



## 1.15. Duty Cycle Correction Factor of EUT

According to KDB 558074 D01 15.247 Meas Guidance v05r02, 9, as a “duty cycle correction factor”, pulse averaging with 20 log (worst case dwell time / 100 ms) has to be used for average result.

DH5 on time (One Pulse) Plot on Channel 39

DH5 on time (Count Pulses) Plot on Channel 39

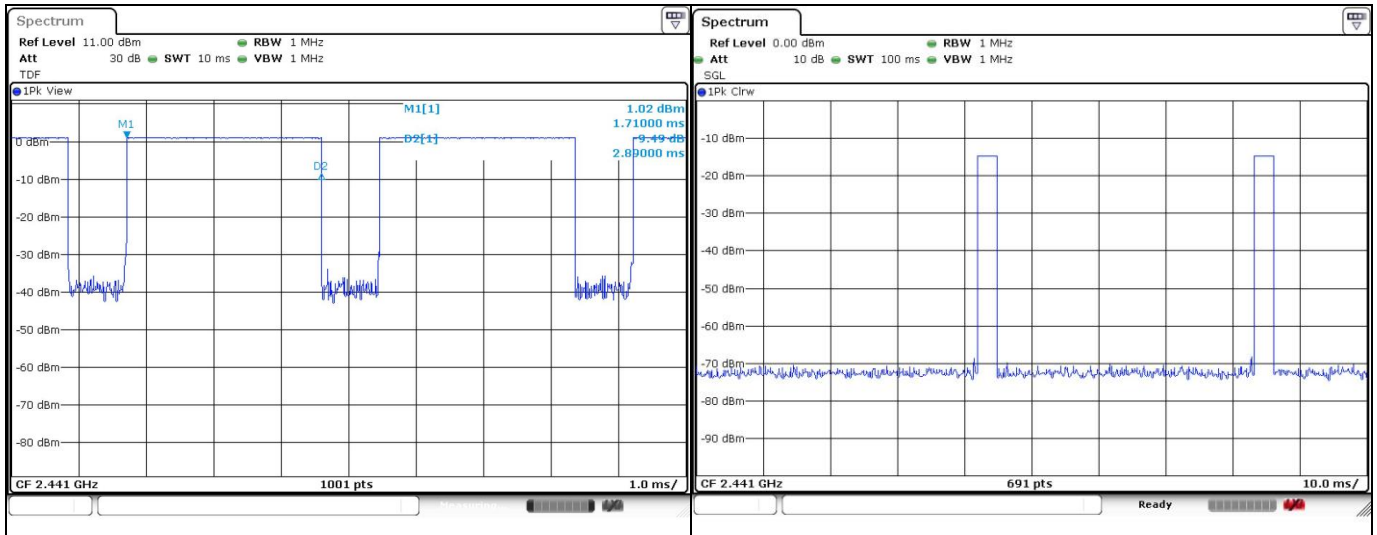

In AFH mode, the minimum hopping frequencies are 20, to get the longest dwell time DH5 packet is observed;  
 the period to have DH5 packet completing one hopping sequence is  $2.89 \text{ ms} \times 20 \text{ channels} = 57.80 \text{ ms}$

There cannot be 2 complete hopping sequences within 100 ms period, considering the random hopping behavior, maximum 2 hops can be possibly observed within the period.  $[100 \text{ ms} / 57.80 \text{ ms}] = 2 \text{ hops}$

Thus, the maximum possible ON time:

$$2.89 \text{ ms} \times 2 = 5.78 \text{ ms}$$

Worst case Duty Cycle Correction factor, which is derived from the maximum possible ON time:

$$20 \times \log (5.78 \text{ ms}/100 \text{ ms}) = -24.76 \text{ dB}$$

*The results of this test report are effective only to the items tested. The SGS Korea is not responsible for the sampling, the results of this test report apply to the sample as received. This test report cannot be reproduced, except in full, without prior written permission of the Company. This test report does not assure KOLAS accreditation.*

## 2. Transmitter Radiated Spurious Emissions and Conducted Spurious Emission

### 2.1. Test Setup

#### 2.1.1. Transmitter Radiated Spurious Emissions

The diagram below shows the test setup that is utilized to make the measurements for emission from 9 kHz to 30 MHz.

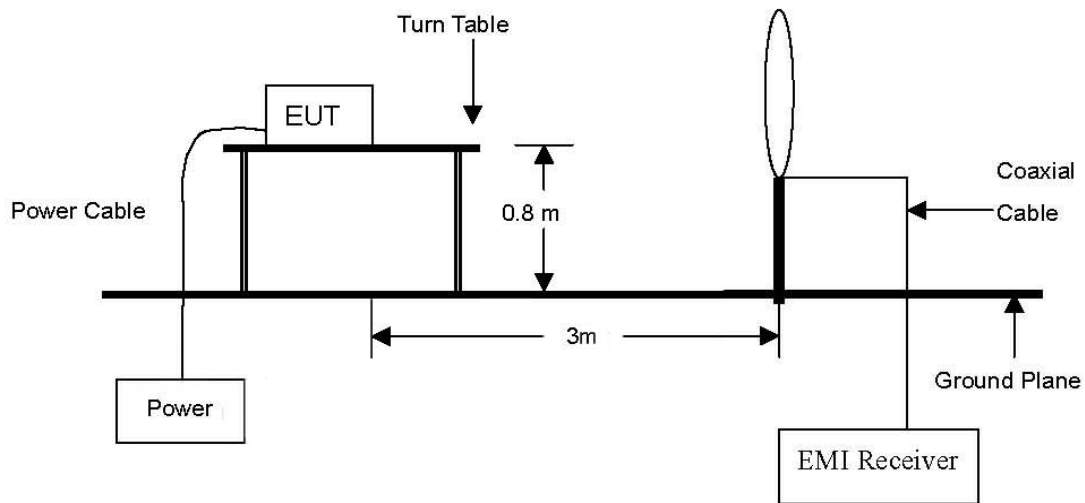

The diagram below shows the test setup that is utilized to make the measurements for emission from 30 MHz to 1 GHz.

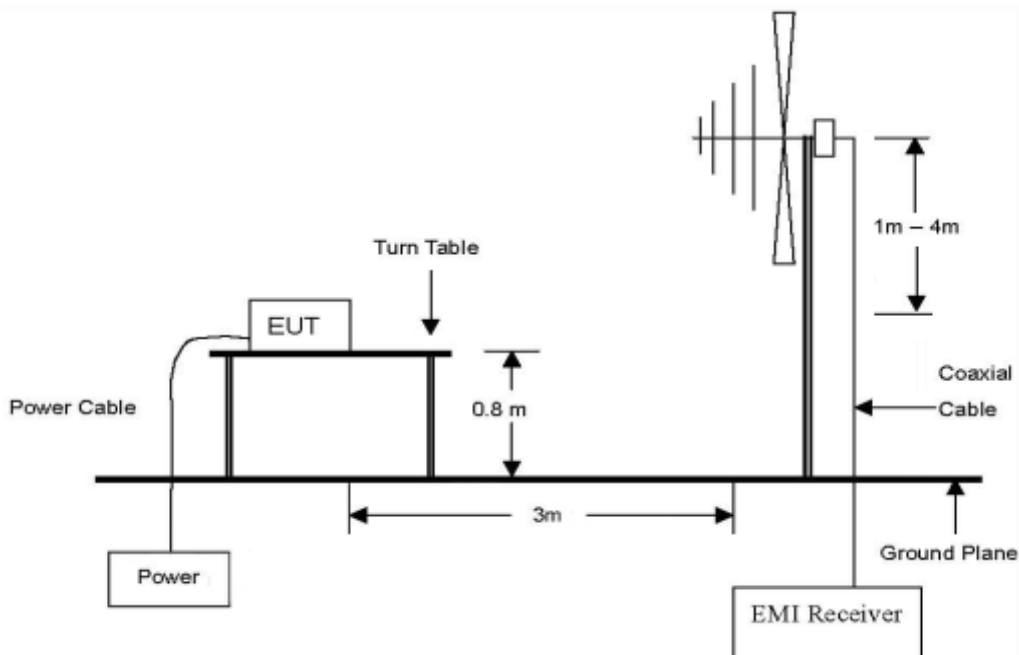

*The results of this test report are effective only to the items tested. The SGS Korea is not responsible for the sampling, the results of this test report apply to the sample as received. This test report cannot be reproduced, except in full, without prior written permission of the Company. This test report does not assure KOLAS accreditation.*

The diagram below shows the test setup that is utilized to make the measurements for emission. The spurious emissions were investigated from 1 GHz to the 10<sup>th</sup> harmonic of the highest fundamental frequency or 40 GHz, whichever is lower.

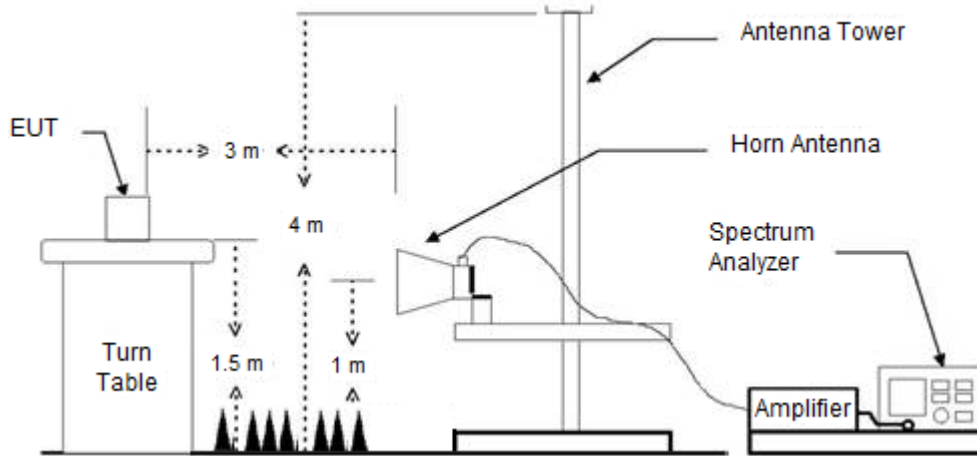

*The results of this test report are effective only to the items tested. The SGS Korea is not responsible for the sampling, the results of this test report apply to the sample as received. This test report cannot be reproduced, except in full, without prior written permission of the Company. This test report does not assure KOLAS accreditation.*

**SGS Korea Co., Ltd. (Gunpo Laboratory)** 4, LS-ro 182beon-gil, Gunpo-si, Gyeonggi-do, Korea, 15807 <http://www.sgsgroup.kr>

### 2.1.2. Conducted Spurious Emissions

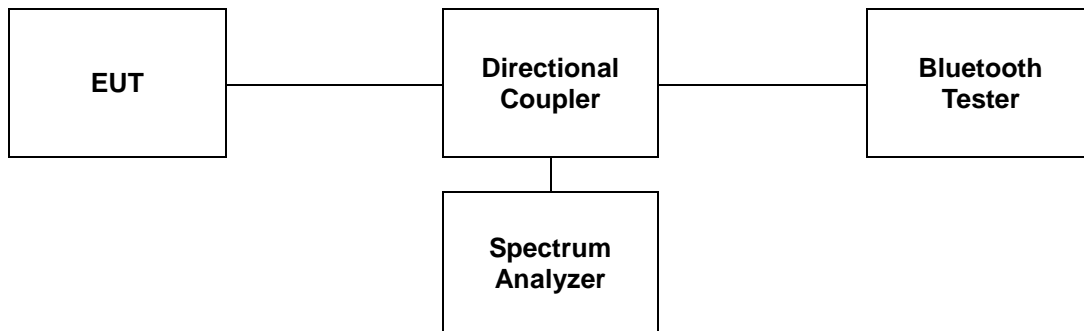

### 2.2. Limit

According to §15.247(d), in any 100 kHz bandwidth outside the frequency band in which the spread spectrum or digitally modulated intentional radiator is operating, the radio frequency power that is produced by the intentional radiator shall be at least 20 dB below that in the 100 kHz bandwidth within the band that contains the highest level of the desired power, based on either an RF conducted or a radiated measurement, provided the transmitter demonstrates compliance with the peak conducted power limits. If the transmitter complies with the conducted power limits based on the use of RMS averaging over a time interval, as permitted under paragraph (b)(3) of this section, the attenuation required under this paragraph shall be 30 dB instead of 20 dB. Attenuation below the general limits specified in section §15.209(a) is not required. In addition, radiated emission which fall in the restricted bands, as defined in section §15.205(a), must also comply with the radiated emission limits specified in section §15.209(a) (see §15.205(c)).

According to §15.209(a), except as provided elsewhere in this subpart, the emissions from an intentional radiator shall not exceed the field strength levels specified in the following table:

Frequency (MHz)	Field Strength ( $\mu\text{V}/\text{m}$ )	Measurement Distance (Meters)
0.009-0.490	2 400/F(kHz)	300
0.490-1.705	24 000/F(kHz)	30
1.705-30.0	30	30
30-88	100**	3
88-216	150**	3
216-960	200**	3
Above 960	500	3

\*\* Except as provided in paragraph (g), fundamental emissions from intentional radiators operating under this section shall not be located in the frequency bands 54-72 MHz, 76-88 MHz, 174-216 MHz or 470-806 MHz. However, operation within these frequency bands is permitted under other sections of this part, e.g., §§15.231 and 15.241.

*The results of this test report are effective only to the items tested. The SGS Korea is not responsible for the sampling, the results of this test report apply to the sample as received. This test report cannot be reproduced, except in full, without prior written permission of the Company. This test report does not assure KOLAS accreditation.*

**SGS Korea Co., Ltd. (Gunpo Laboratory)** 4, LS-ro 182beon-gil, Gunpo-si, Gyeonggi-do, Korea, 15807 <http://www.sgsgroup.kr>

## 2.3. Test Procedures

Radiated emissions from the EUT were measured according to the dictates of ANSI C63.10-2013.

### 2.3.1. Test Procedures for emission below 30 MHz

1. The EUT was placed on the top of a rotating table 0.8 meters above the ground at a 3 meter anechoic chamber test site. The table was rotated 360 degrees to determine the position of the highest radiation.
2. Then antenna is a loop antenna is fixed at one meter above the ground to determine the maximum value of the field strength. Both parallel and perpendicular of the antenna are set to make the measurement.
3. For each suspected emission, the EUT was arranged to its worst case and then the table was turned from 0 degrees to 360 degrees to find the maximum reading.
4. The test-receiver system was set to average or quasi peak detect function and Specified Bandwidth with Maximum Hold Mode.

### 2.3.2. Test Procedures for emission from above 30 MHz

1. The EUT was placed on the top of a rotating table 0.8 meters above the ground at a 3 meter anechoic chamber test site below 1 GHz and 1.5 meter above the ground at a 3 meter anechoic chamber test site above 1 GHz. The table was rotated 360 degrees to determine the position of the highest radiation.
2. During performing radiated emission below 1 GHz, the EUT was set 3 meters away from the interference receiving antenna, which was mounted on the top of a variable-height antenna tower. During performing radiated emission above 1 GHz, the EUT was set 3 meter away from the interference-receiving antenna.
3. The antenna is a bi-log antenna, a horn antenna and its height is varied from one meter to four meters above the ground to determine the maximum value of the field strength. Both horizontal and vertical polarizations of the antenna are set to make the measurement.
4. For each suspected emission, the EUT was arranged to its worst case and then the antenna was tuned to heights from 1 meter to 4 meters and the table was turned from 0 degrees to 360 degrees to find the maximum reading.
5. The test-receiver system was set to Peak Detect Function and Specified Bandwidth with Maximum Hold Mode.

#### Note;

1. The resolution bandwidth and video bandwidth of test receiver/spectrum analyzer is 120 kHz for Peak detection (PK) and Quasi-peak detection (QP) at frequency below 1 GHz.
2. For frequency above 1 GHz, set spectrum analyzer detector to peak, and resolution bandwidth is 1 MHz and video bandwidth is 3 MHz.
3. Definition of DUT Axis.  
Definition of the test orthogonal plan for EUT was described in the test setup photo.  
The test orthogonal plan of EUT is **X – axis** during radiation test.

*The results of this test report are effective only to the items tested. The SGS Korea is not responsible for the sampling, the results of this test report apply to the sample as received. This test report cannot be reproduced, except in full, without prior written permission of the Company. This test report does not assure KOLAS accreditation.*

---

### 2.3.3. Test Procedures for Conducted Spurious Emissions

#### 2.3.3.1. Band-edge Compliance of RF Conducted Emissions

The transmitter output was connected to the spectrum analyzer.

Span = wide enough to capture the peak level of the emission operating on the channel closest to the band edge, as well as any modulation products which fall outside of the authorized band of operation.

RBW = 100 kHz

VBW = 300 kHz

Sweep = auto

Detector function = peak

Trace = max hold

#### 2.3.3.2. Spurious RF Conducted Emissions

The transmitter output was connected to the spectrum analyzer.

RBW = 1 MHz

VBW = 3 MHz

Sweep = auto

Detector function = peak

Trace = max hold

#### 2.3.3.3. TDF function

- For plots showing conducted spurious emissions from 9 kHz to 25 GHz, all path loss of wide frequency range was investigated and compensated to spectrum analyzer as TDF function.

So, the reading values shown in plots were final result.

---

*The results of this test report are effective only to the items tested. The SGS Korea is not responsible for the sampling, the results of this test report apply to the sample as received. This test report cannot be reproduced, except in full, without prior written permission of the Company. This test report does not assure KOLAS accreditation.*

**SGS Korea Co., Ltd. (Gunpo Laboratory)** 4, LS-ro 182beon-gil, Gunpo-si, Gyeonggi-do, Korea, 15807 <http://www.sgsgroup.kr>

RTT5041-19(2019.04.24)(1)

Tel. +82 31 428 5700 / Fax. +82 31 427 2370

A4(210 mm x 297 mm)

## 2.4. Test Results

Ambient temperature : (23 ± 1) °C  
 Relative humidity : 47 % R.H.

### 2.4.1. Radiated Spurious Emission below 1 000 MHz

The frequency spectrum from 9 kHz to 1 000 MHz was investigated. All reading values are peak values.

Radiated Emissions			Ant.	Correction Factors		Total	Limit	
Frequency (MHz)	Reading (dBµV)	Detect Mode	Pol.	AF (dB/m)	AMP + CL (dB)	Actual (dBµV/m)	Limit (dBµV/m)	Margin (dB)
64.23	32.50	Peak	V	16.71	-26.32	22.89	40.00	17.11
114.27	36.60	Peak	H	16.17	-25.51	27.26	43.50	16.24
327.18	34.30	Peak	V	19.83	-25.25	28.88	46.00	17.12
457.12	35.70	Peak	H	21.94	-25.09	32.55	46.00	13.45
685.72	34.40	Peak	H	25.41	-23.50	36.31	46.00	9.69
932.99	31.60	Peak	V	28.14	-22.71	37.03	46.00	8.97

#### Remark;

1. Spurious emissions for all channels and modes were investigated and almost the same below 1 GHz.
2. Reported spurious emissions are in **BDR / DH5 / High channel** as worst case among other modes.
3. Radiated spurious emission measurement as below.  
(Actual = Reading + AF + AMP + CL)
4. According to §15.31(o), emission levels are not report much lower than the limits by over 20 dB.

#### - Test plot

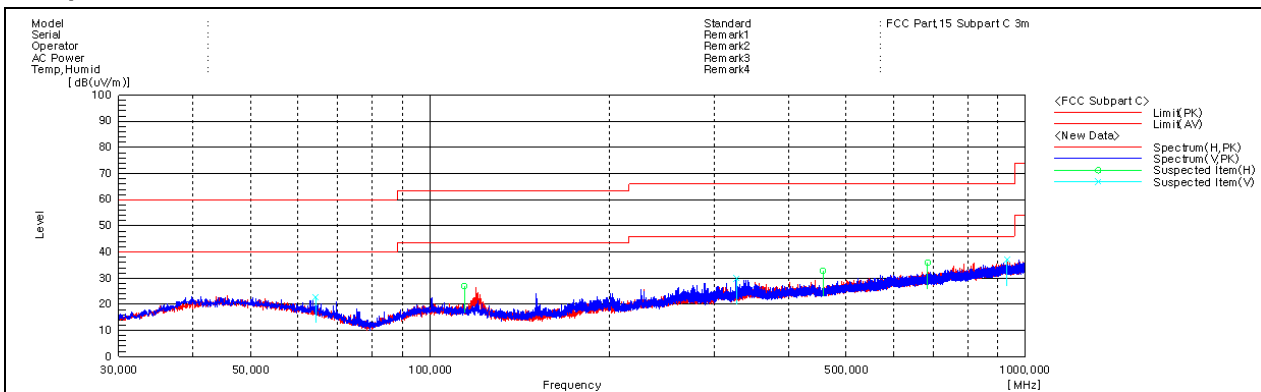

The results of this test report are effective only to the items tested. The SGS Korea is not responsible for the sampling, the results of this test report apply to the sample as received. This test report cannot be reproduced, except in full, without prior written permission of the Company. This test report does not assure KOLAS accreditation.

### 2.4.2. Radiated Spurious Emission above 1 000 MHz

The frequency spectrum above 1 000 MHz was investigated. All reading values are peak values.

#### Operating Mode: GFSK (1 Mbps)

##### A. Low Channel (2 402 MHz)

Radiated Emissions			Ant.	Correction Factors			Total	Limit	
Frequency (MHz)	Reading (dB $\mu$ V)	Detect Mode	Pol.	AF (dB/m)	CL (dB)	DF (dB)	Actual (dB $\mu$ V/m)	Limit (dB $\mu$ V/m)	Margin (dB)
*2 310.00	25.12	Peak	H	27.82	8.07	-	61.01	74.00	12.99
*2 310.00	-	-	-	-	-	-24.76	36.25	54.00	17.75
*2 381.30	27.65	Peak	H	27.96	8.22	-	63.83	74.00	10.17
*2 381.30	-	-	-	-	-	-24.76	39.07	54.00	14.93
*2 390.00	25.29	Peak	H	27.98	8.22	-	61.49	74.00	12.51
*2 390.00	-	-	-	-	-	-24.76	36.73	54.00	17.27

Radiated Emissions			Ant.	Correction Factors			Total	Limit	
Frequency (MHz)	Reading (dB $\mu$ V)	Detect Mode	Pol.	AF (dB/m)	AMP+CL (dB)	DF (dB)	Actual (dB $\mu$ V/m)	Limit (dB $\mu$ V/m)	Margin (dB)
Above 1 000.00	Not detected	-	-	-	-	-	-	-	-

##### B. Middle Channel (2 441 MHz)

Radiated Emissions			Ant.	Correction Factors			Total	Limit	
Frequency (MHz)	Reading (dB $\mu$ V)	Detect Mode	Pol.	AF (dB/m)	AMP+CL (dB)	DF (dB)	Actual (dB $\mu$ V/m)	Limit (dB $\mu$ V/m)	Margin (dB)
Above 1 000.00	Not detected	-	-	-	-	-	-	-	-

The results of this test report are effective only to the items tested. The SGS Korea is not responsible for the sampling, the results of this test report apply to the sample as received. This test report cannot be reproduced, except in full, without prior written permission of the Company. This test report does not assure KOLAS accreditation.



## C. High Channel (2 480 MHz)

Radiated Emissions			Ant.	Correction Factors			Total	Limit	
Frequency (MHz)	Reading (dB $\mu$ V)	Detect Mode	Pol.	AF (dB/m)	CL (dB)	DF (dB)	Actual (dB $\mu$ V/m)	Limit (dB $\mu$ V/m)	Margin (dB)
*2 483.50	26.56	Peak	H	28.00	8.37	-	62.93	74.00	11.07
*2 483.50	-	-	-	-	-	-24.76	38.17	54.00	15.83
*2 499.58	28.01	Peak	H	28.00	8.38	-	64.39	74.00	9.61
*2 499.58	-	-	-	-	-	-24.76	39.63	54.00	14.37
*2 500.00	26.34	Peak	H	28.00	8.38	-	62.72	74.00	11.28
*2 500.00	-	-	-	-	-	-24.76	37.96	54.00	16.04

Radiated Emissions			Ant.	Correction Factors			Total	Limit	
Frequency (MHz)	Reading (dB $\mu$ V)	Detect Mode	Pol.	AF (dB/m)	AMP+CL (dB)	DF (dB)	Actual (dB $\mu$ V/m)	Limit (dB $\mu$ V/m)	Margin (dB)
Above 1 000.00	Not detected	-	-	-	-	-	-	-	-

The results of this test report are effective only to the items tested. The SGS Korea is not responsible for the sampling, the results of this test report apply to the sample as received. This test report cannot be reproduced, except in full, without prior written permission of the Company. This test report does not assure KOLAS accreditation.

**Operating Mode: 8DPSK (3 Mbps)**

## A. Low Channel (2 402 MHz)

Radiated Emissions			Ant.	Correction Factors			Total	Limit	
Frequency (MHz)	Reading (dB $\mu$ V)	Detect Mode	Pol.	AF (dB/m)	CL (dB)	DF (dB)	Actual (dB $\mu$ V/m)	Limit (dB $\mu$ V/m)	Margin (dB)
*2 310.00	25.84	Peak	H	27.82	8.07	-	61.73	74.00	12.27
*2 310.00	-	-	-	-	-	-24.76	36.97	54.00	17.03
*2 387.70	27.74	Peak	H	27.98	8.22	-	63.94	74.00	10.06
*2 387.70	-	-	-	-	-	-24.76	39.18	54.00	14.82
*2 390.00	26.19	Peak	H	27.98	8.22	-	62.39	74.00	11.61
*2 390.00	-	-	-	-	-	-24.76	37.63	54.00	16.37

Radiated Emissions			Ant.	Correction Factors			Total	Limit	
Frequency (MHz)	Reading (dB $\mu$ V)	Detect Mode	Pol.	AF (dB/m)	AMP+CL (dB)	DF (dB)	Actual (dB $\mu$ V/m)	Limit (dB $\mu$ V/m)	Margin (dB)
Above 1 000.00	Not detected	-	-	-	-	-	-	-	-

## B. Middle Channel (2 441 MHz)

Radiated Emissions			Ant.	Correction Factors			Total	Limit	
Frequency (MHz)	Reading (dB $\mu$ V)	Detect Mode	Pol.	AF (dB/m)	AMP+CL (dB)	DF (dB)	Actual (dB $\mu$ V/m)	Limit (dB $\mu$ V/m)	Margin (dB)
Above 1 000.00	Not detected	-	-	-	-	-	-	-	-

The results of this test report are effective only to the items tested. The SGS Korea is not responsible for the sampling, the results of this test report apply to the sample as received. This test report cannot be reproduced, except in full, without prior written permission of the Company. This test report does not assure KOLAS accreditation.

## C. High Channel (2 480 MHz)

Radiated Emissions			Ant.	Correction Factors			Total	Limit	
Frequency (MHz)	Reading (dB $\mu$ V)	Detect Mode	Pol.	AF (dB/m)	CL (dB)	DF (dB)	Actual (dB $\mu$ V/m)	Limit (dB $\mu$ V/m)	Margin (dB)
*2 483.50	27.13	Peak	H	28.00	8.37	-	63.50	74.00	10.50
*2 483.50	-	-	-	-	-	-24.76	38.74	54.00	15.26
*2 496.46	28.10	Peak	H	28.00	8.38	-	64.48	74.00	9.52
*2 496.46	-	-	-	-	-	-24.76	39.72	54.00	14.28
*2 500.00	26.43	Peak	H	28.00	8.38	-	62.81	74.00	11.19
*2 500.00	-	-	-	-	-	-24.76	38.05	54.00	15.95

Radiated Emissions			Ant.	Correction Factors			Total	Limit	
Frequency (MHz)	Reading (dB $\mu$ V)	Detect Mode	Pol.	AF (dB/m)	AMP+CL (dB)	DF (dB)	Actual (dB $\mu$ V/m)	Limit (dB $\mu$ V/m)	Margin (dB)
Above 1 000.00	Not detected	-	-	-	-	-	-	-	-

**Remark;**

1. "\*" means the restricted band.
2. Measuring frequencies from 1 GHz to the 10<sup>th</sup> harmonic of highest fundamental frequency.
3. Radiated emissions measured in frequency above 1 000 MHz were made with an instrument using peak/average detector mode.
4. Actual = Reading + AF + CL + (DF) or Reading + AF + AMP + CL + (DF).
5. According to § 15.31(o), emission levels are not reported much lower than the limits by over 20 dB.
6. The maximized peak measured value complies with the average limit, to perform an average measurement is unnecessary.

The results of this test report are effective only to the items tested. The SGS Korea is not responsible for the sampling, the results of this test report apply to the sample as received. This test report cannot be reproduced, except in full, without prior written permission of the Company. This test report does not assure KOLAS accreditation.

- Test plots

Operating Mode: GFSK (1 Mbps)  
Low channel band edge

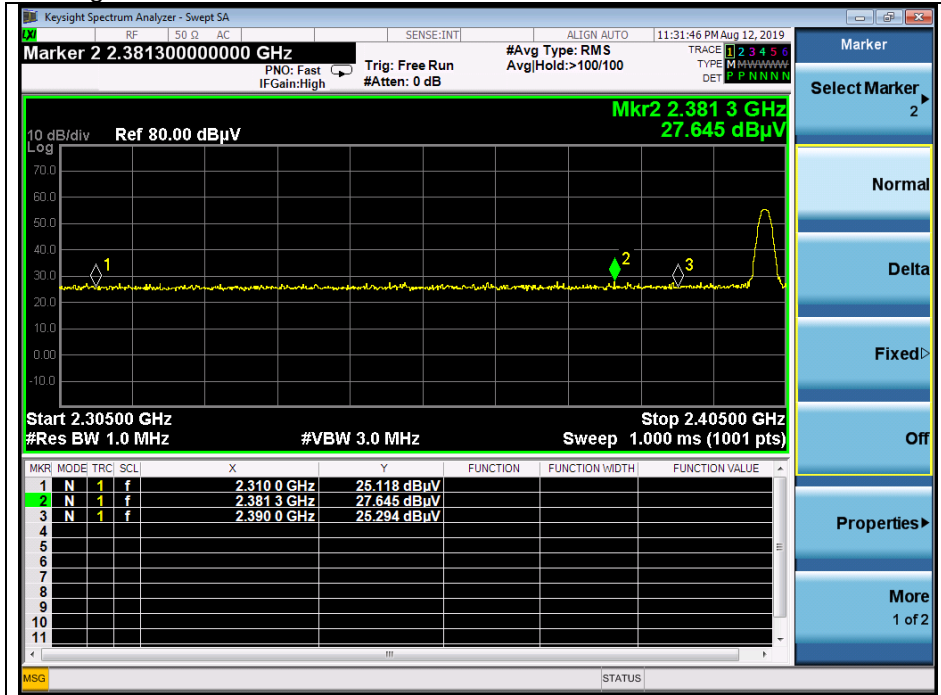

High channel band edge

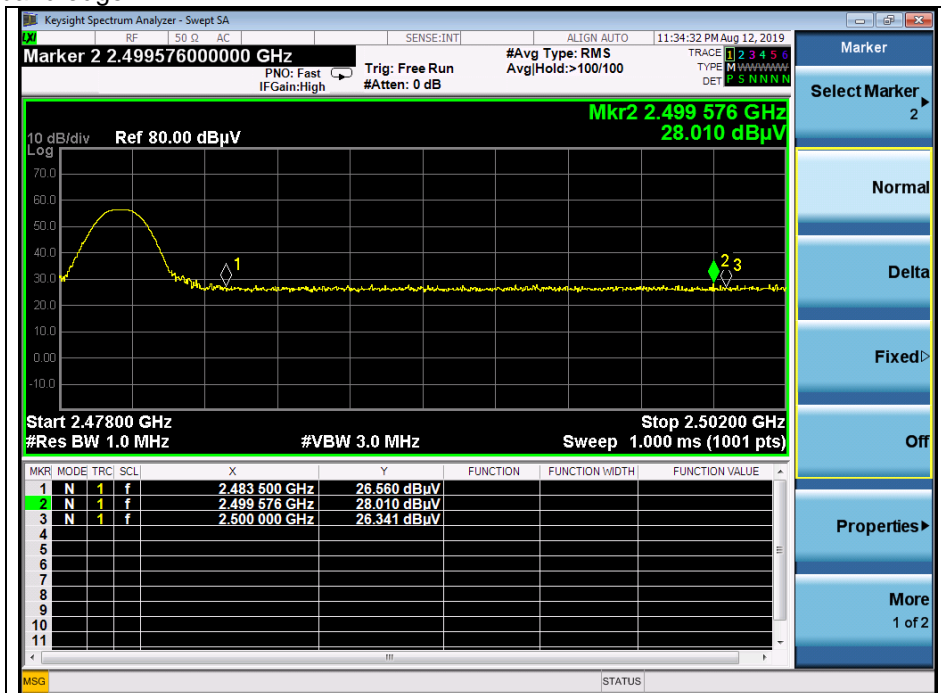

The results of this test report are effective only to the items tested. The SGS Korea is not responsible for the sampling, the results of this test report apply to the sample as received. This test report cannot be reproduced, except in full, without prior written permission of the Company. This test report does not assure KOLAS accreditation.

**Operating Mode: 8DPSK (3 Mbps)**  
**Low channel band edge**

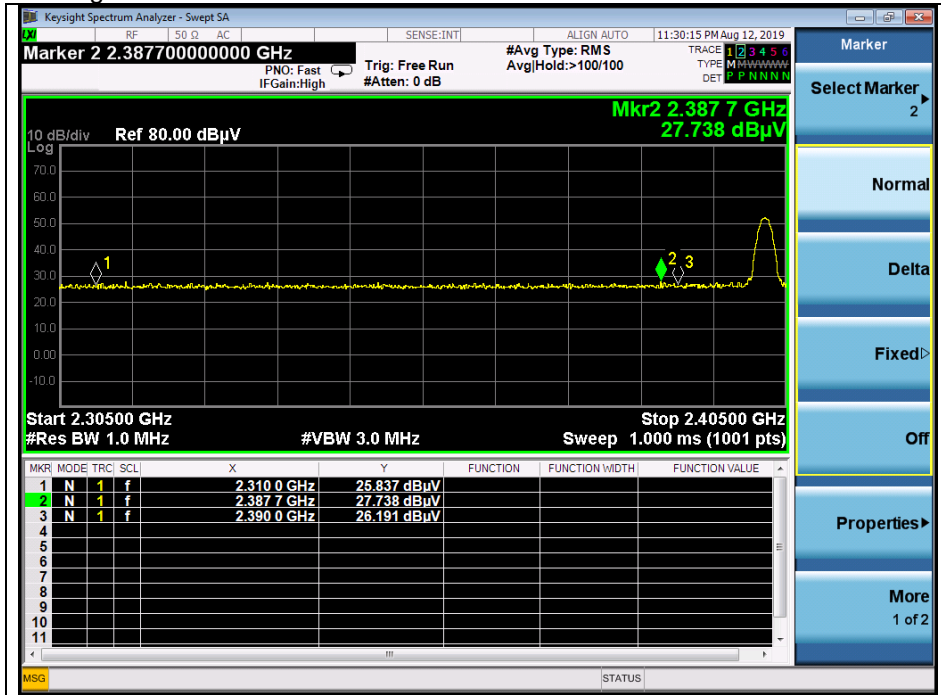

**High channel band edge**

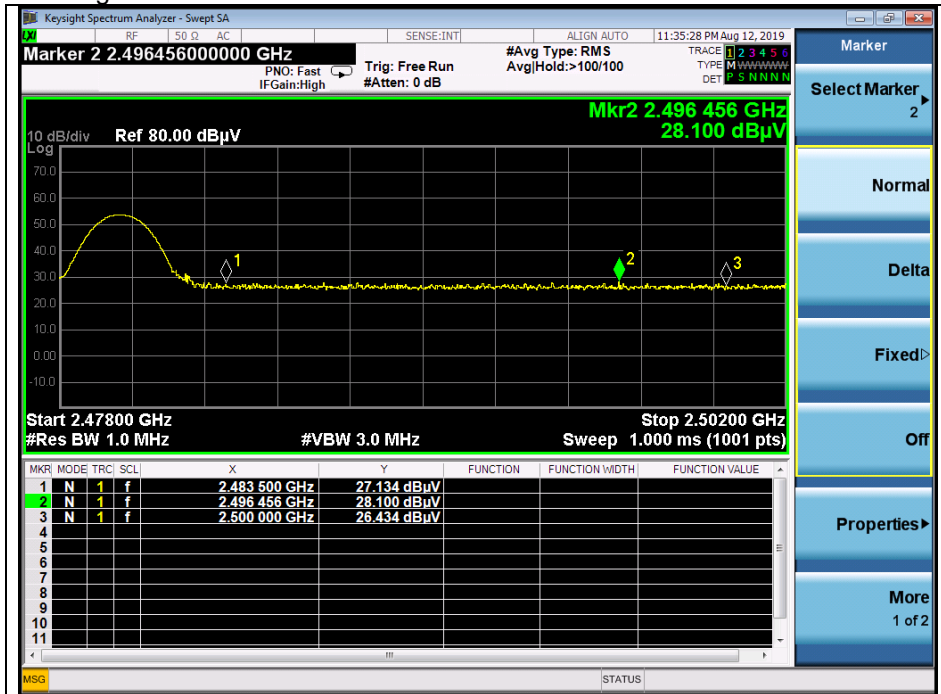

The results of this test report are effective only to the items tested. The SGS Korea is not responsible for the sampling, the results of this test report apply to the sample as received. This test report cannot be reproduced, except in full, without prior written permission of the Company. This test report does not assure KOLAS accreditation.

## 2.4.3. Spurious RF Conducted Emissions

Operating Mode: GFSK (1 Mbps)

Low channel

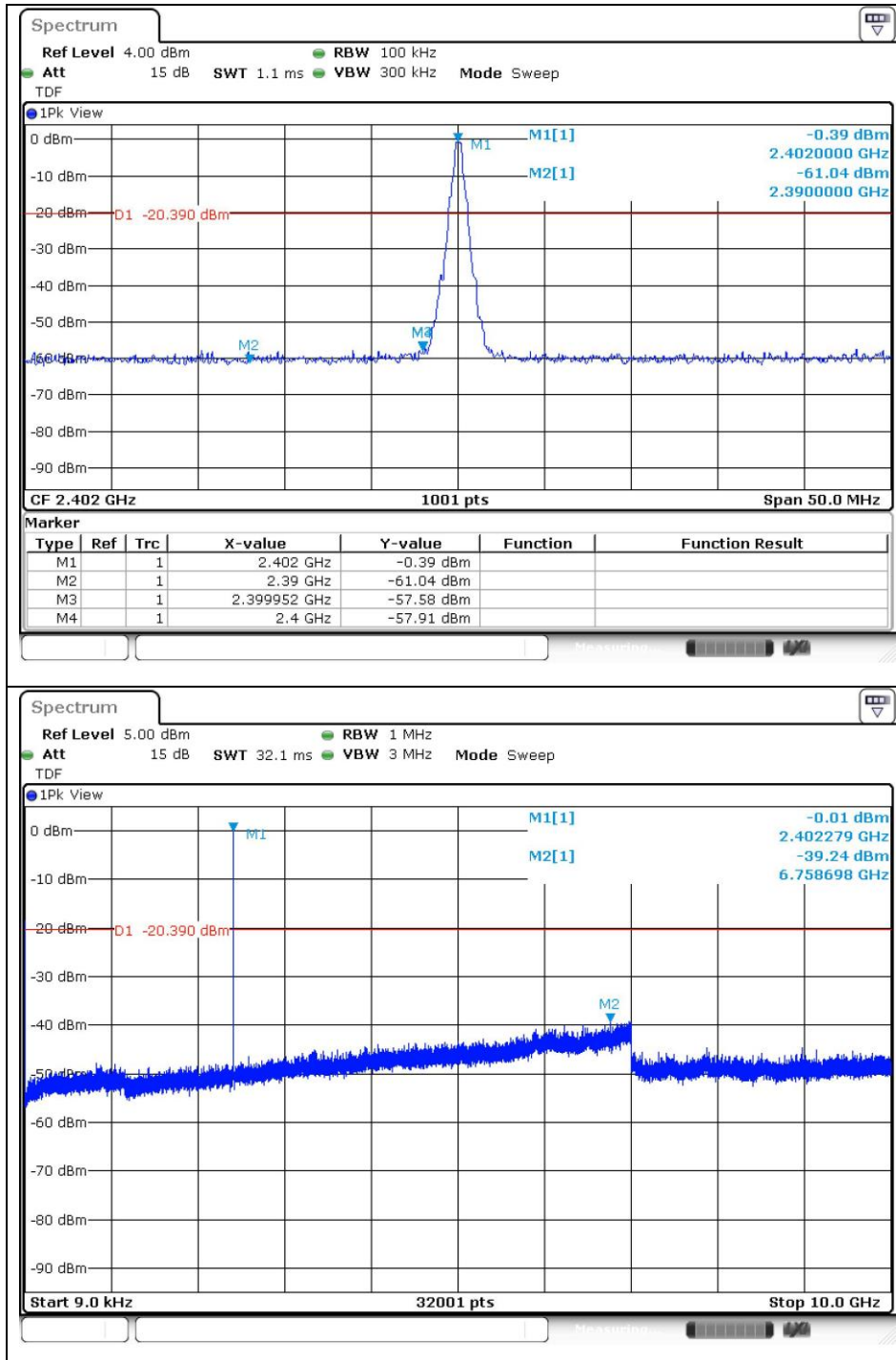

The results of this test report are effective only to the items tested. The SGS Korea is not responsible for the sampling, the results of this test report apply to the sample as received. This test report cannot be reproduced, except in full, without prior written permission of the Company. This test report does not assure KOLAS accreditation.

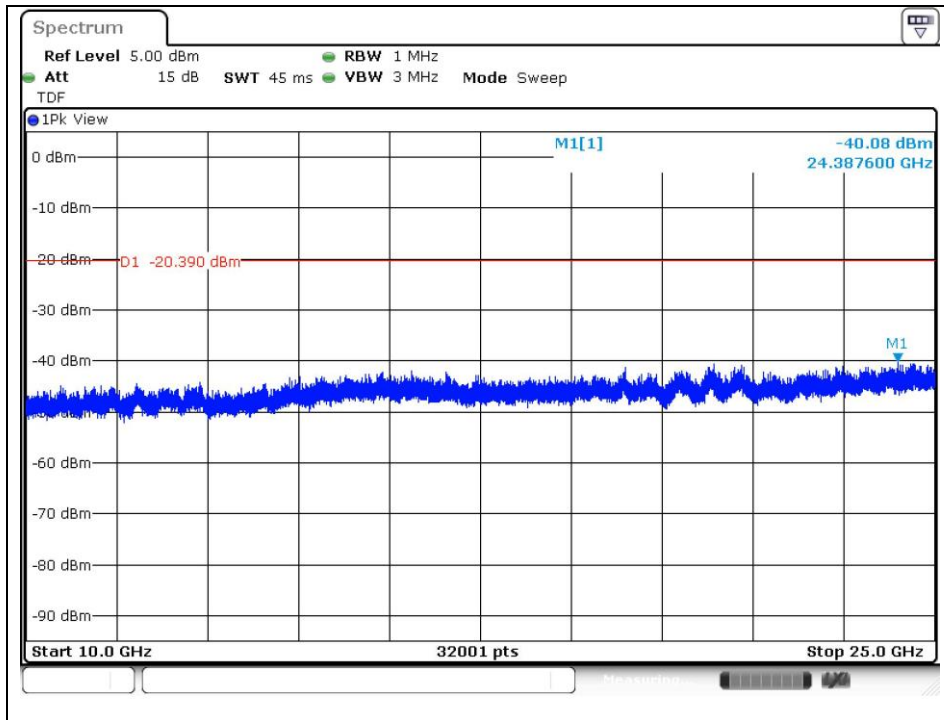

The results of this test report are effective only to the items tested. The SGS Korea is not responsible for the sampling, the results of this test report apply to the sample as received. This test report cannot be reproduced, except in full, without prior written permission of the Company. This test report does not assure KOLAS accreditation.

**SGS Korea Co., Ltd. (Gunpo Laboratory)** 4, LS-ro 182beon-gil, Gunpo-si, Gyeonggi-do, Korea, 15807 <http://www.sgsgroup.kr>

Middle channel

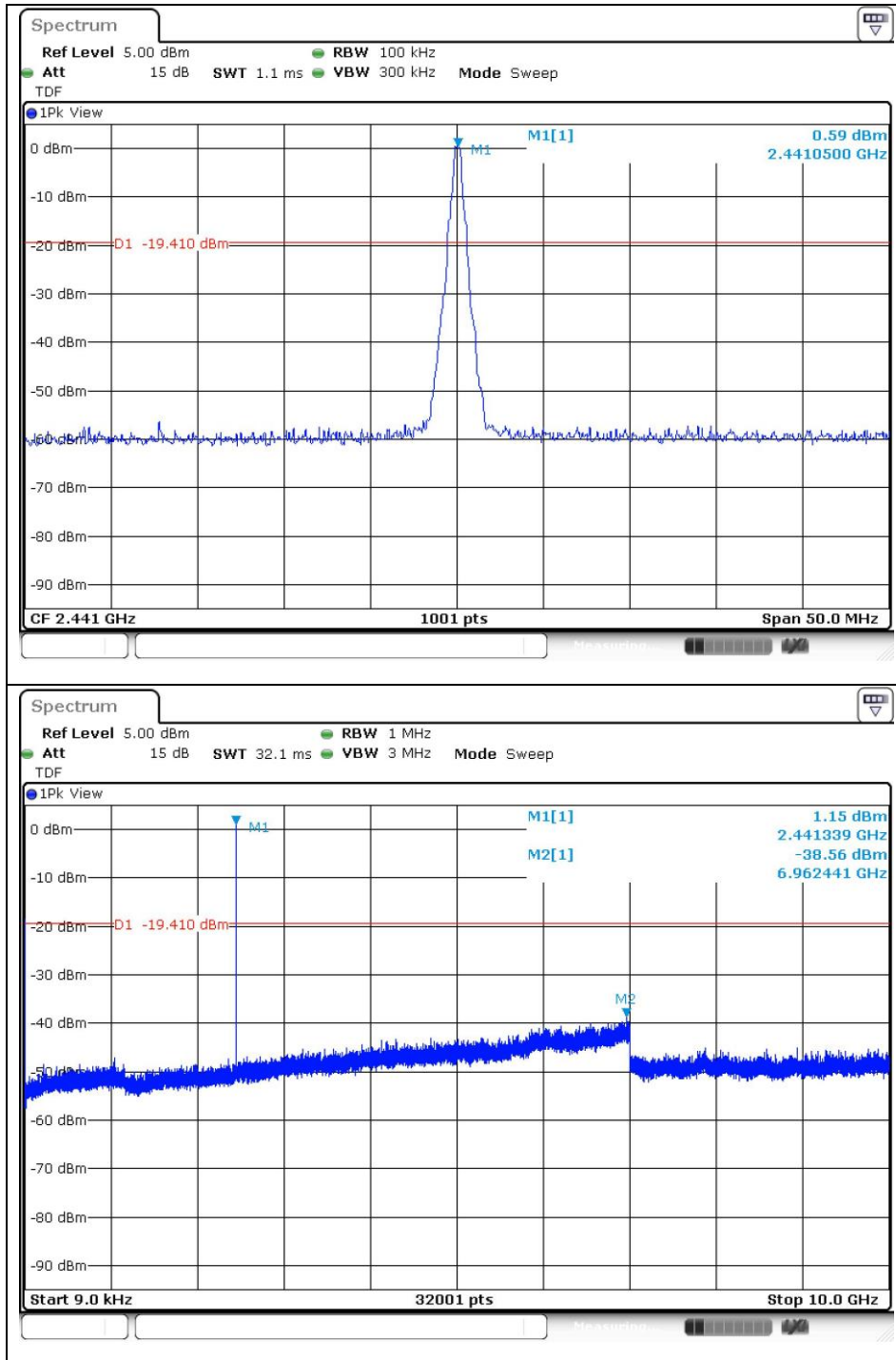

The results of this test report are effective only to the items tested. The SGS Korea is not responsible for the sampling, the results of this test report apply to the sample as received. This test report cannot be reproduced, except in full, without prior written permission of the Company. This test report does not assure KOLAS accreditation.

SGS Korea Co., Ltd. (Gunpo Laboratory) 4, LS-ro 182beon-gil, Gunpo-si, Gyeonggi-do, Korea, 15807 <http://www.sgsgroup.kr>



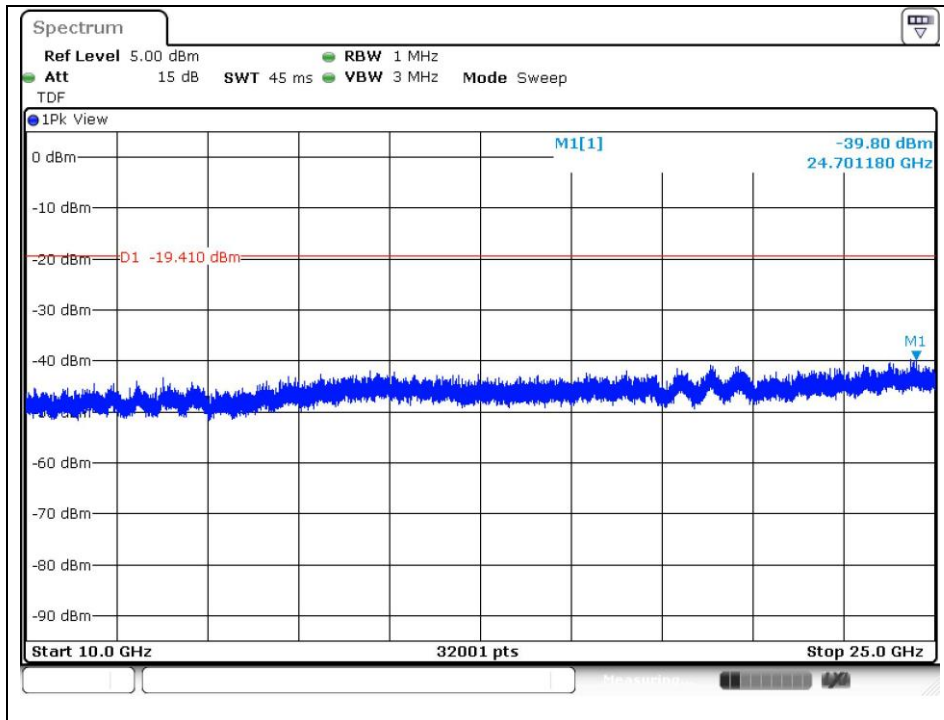

The results of this test report are effective only to the items tested. The SGS Korea is not responsible for the sampling, the results of this test report apply to the sample as received. This test report cannot be reproduced, except in full, without prior written permission of the Company. This test report does not assure KOLAS accreditation.

**SGS Korea Co., Ltd. (Gunpo Laboratory)** 4, LS-ro 182beon-gil, Gunpo-si, Gyeonggi-do, Korea, 15807 <http://www.sgsgroup.kr>

High channel

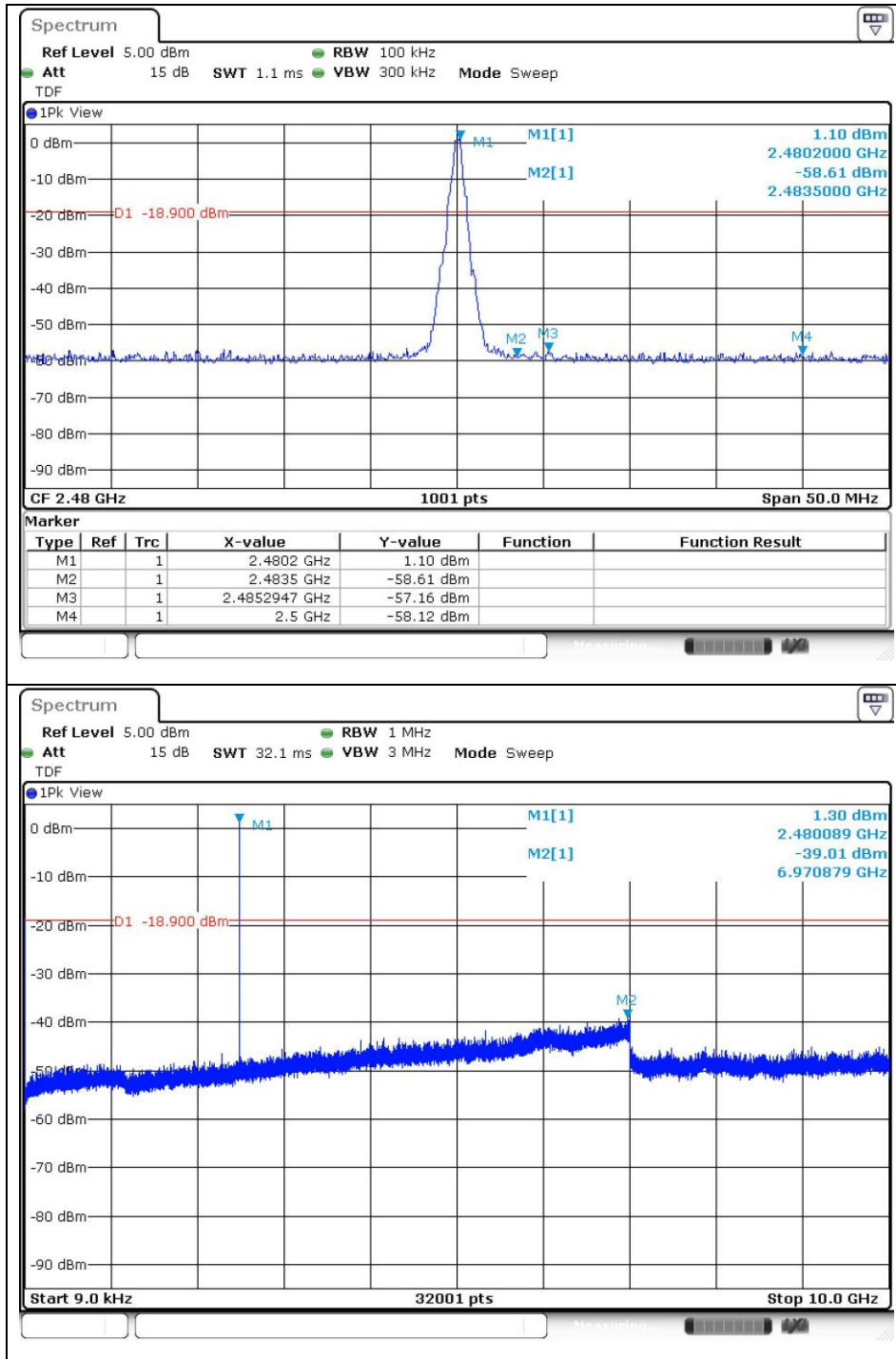

The results of this test report are effective only to the items tested. The SGS Korea is not responsible for the sampling, the results of this test report apply to the sample as received. This test report cannot be reproduced, except in full, without prior written permission of the Company. This test report does not assure KOLAS accreditation.

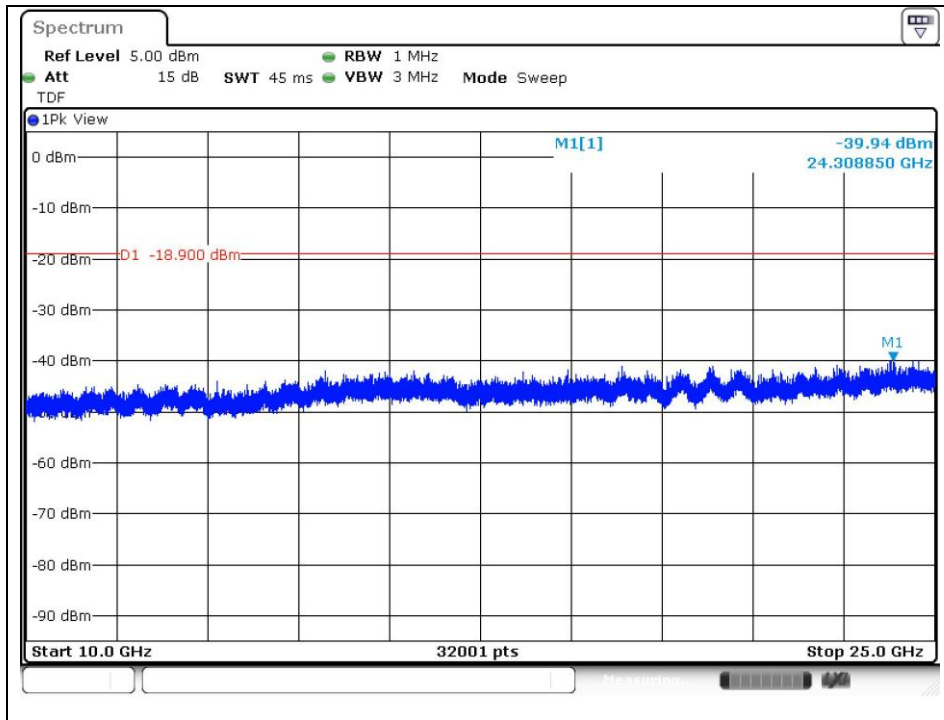

The results of this test report are effective only to the items tested. The SGS Korea is not responsible for the sampling, the results of this test report apply to the sample as received. This test report cannot be reproduced, except in full, without prior written permission of the Company. This test report does not assure KOLAS accreditation.

**SGS Korea Co., Ltd. (Gunpo Laboratory)** 4, LS-ro 182beon-gil, Gunpo-si, Gyeonggi-do, Korea, 15807 <http://www.sgsgroup.kr>

**Band edge compliance with hopping enabled**

Low channel

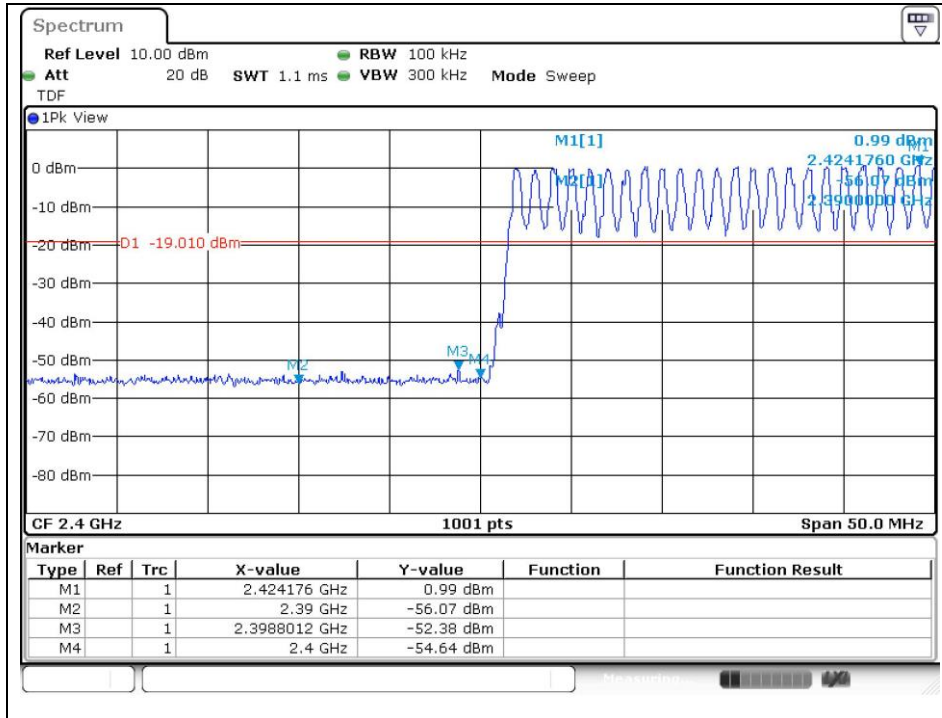

High channel

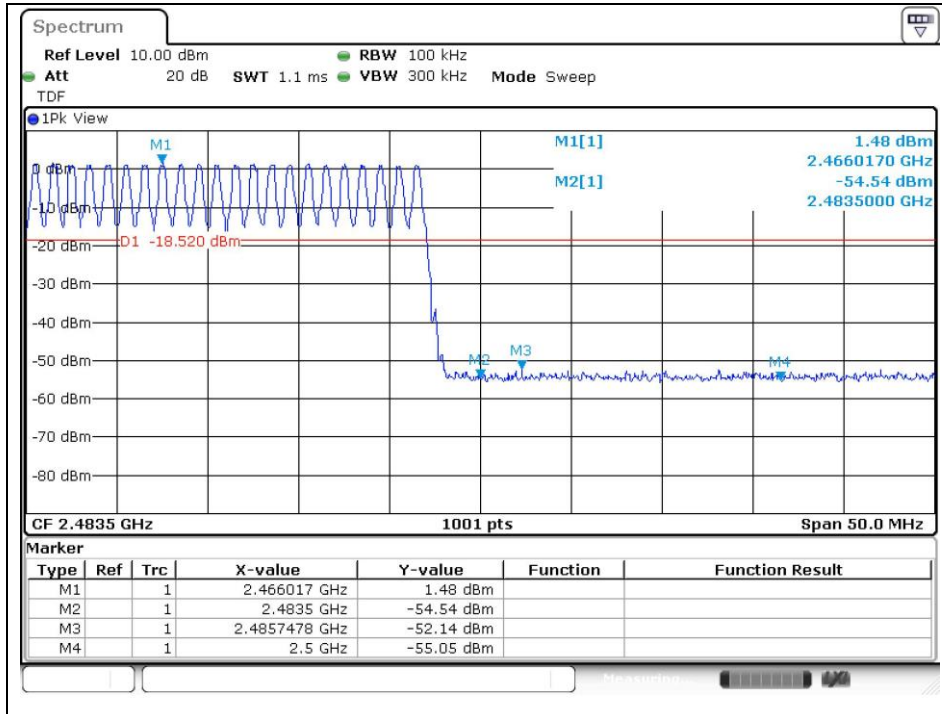

The results of this test report are effective only to the items tested. The SGS Korea is not responsible for the sampling, the results of this test report apply to the sample as received. This test report cannot be reproduced, except in full, without prior written permission of the Company. This test report does not assure KOLAS accreditation.

## Operating Mode: 8DPSK (3 Mbps)

Low channel

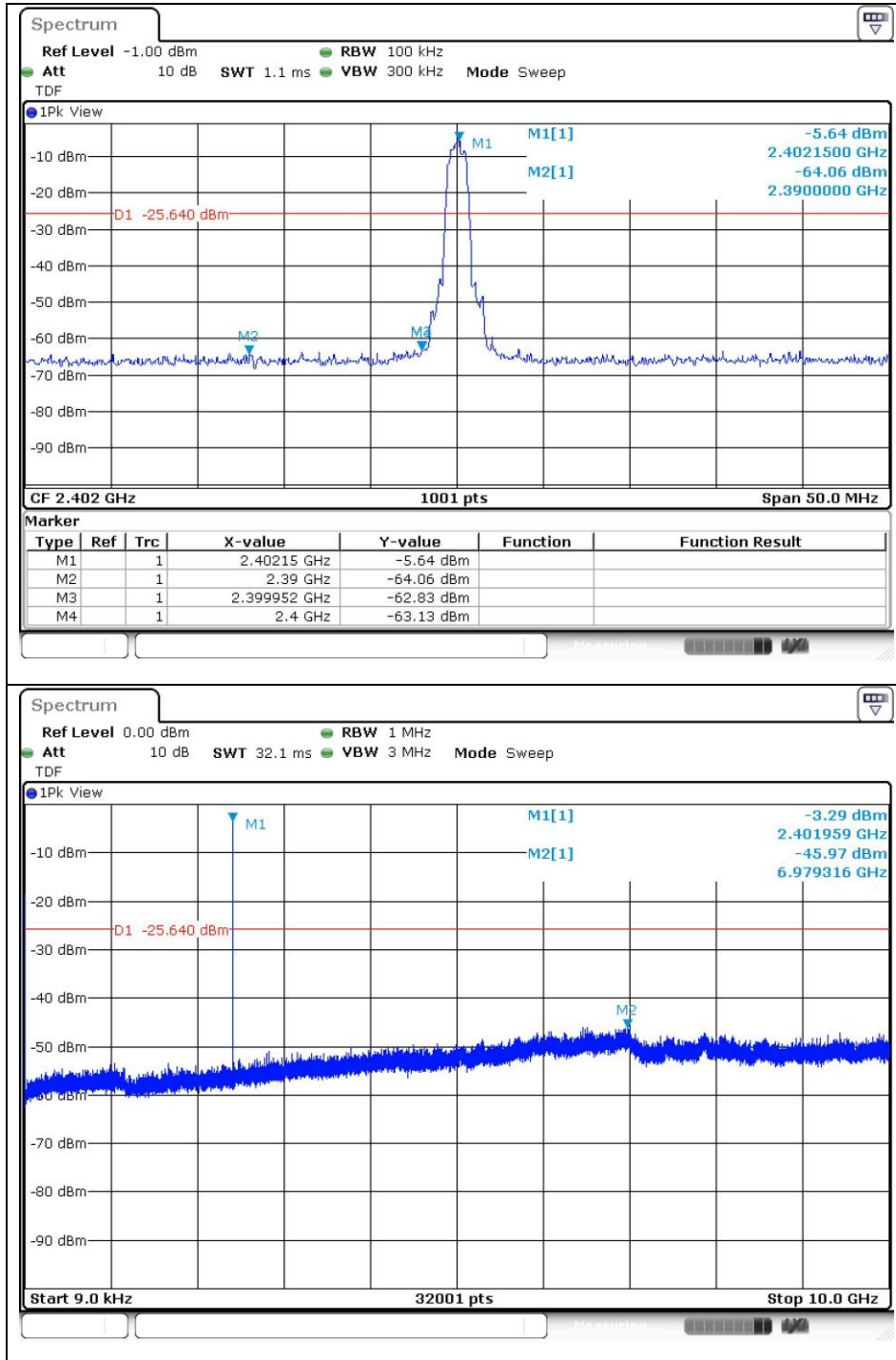

The results of this test report are effective only to the items tested. The SGS Korea is not responsible for the sampling, the results of this test report apply to the sample as received. This test report cannot be reproduced, except in full, without prior written permission of the Company. This test report does not assure KOLAS accreditation.

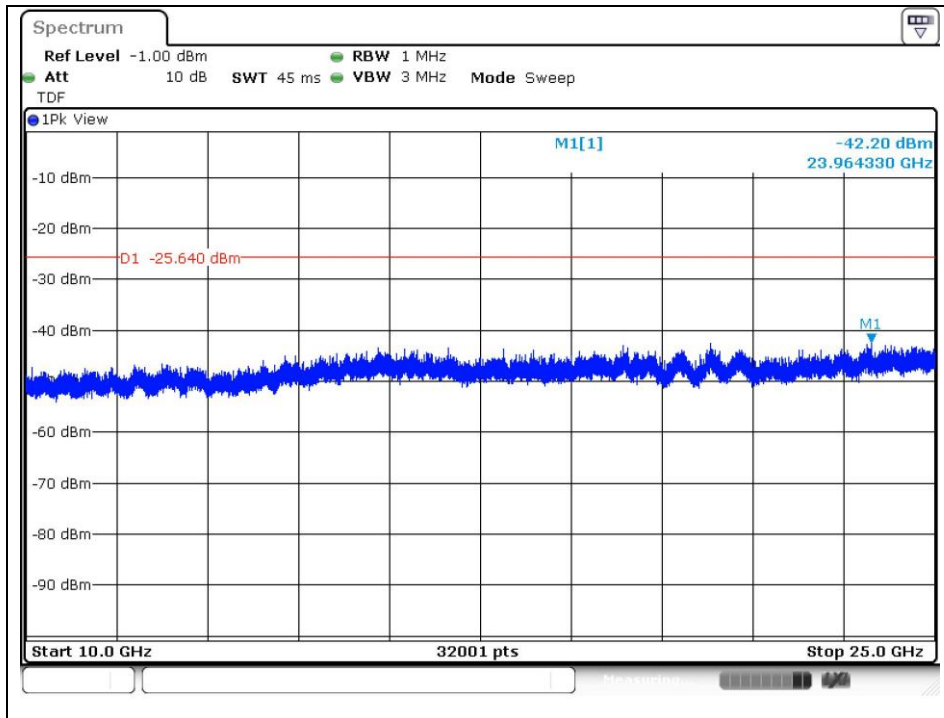

The results of this test report are effective only to the items tested. The SGS Korea is not responsible for the sampling, the results of this test report apply to the sample as received. This test report cannot be reproduced, except in full, without prior written permission of the Company. This test report does not assure KOLAS accreditation.

**SGS Korea Co., Ltd. (Gunpo Laboratory)** 4, LS-ro 182beon-gil, Gunpo-si, Gyeonggi-do, Korea, 15807 <http://www.sgsgroup.kr>

Middle channel

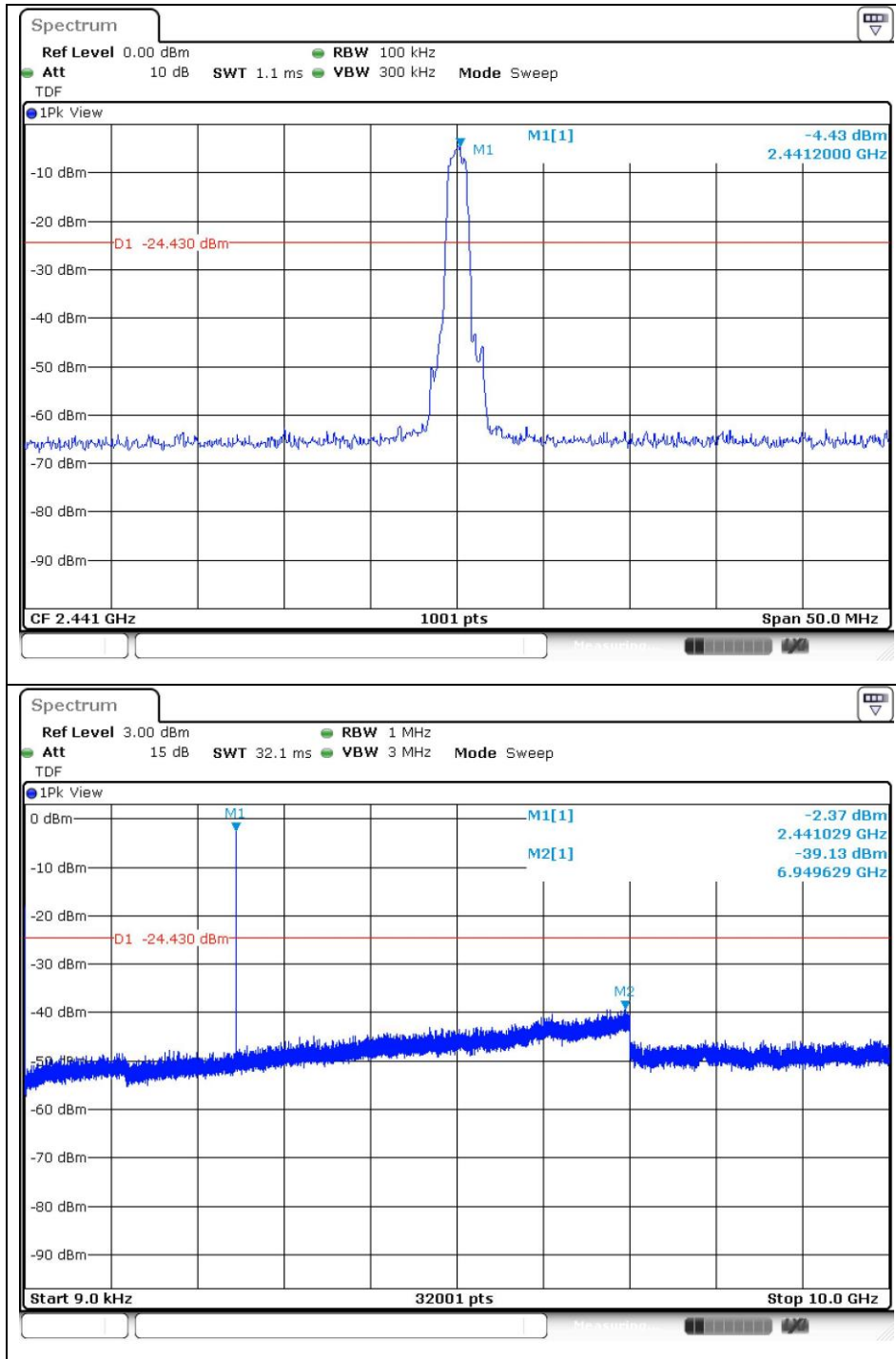

The results of this test report are effective only to the items tested. The SGS Korea is not responsible for the sampling, the results of this test report apply to the sample as received. This test report cannot be reproduced, except in full, without prior written permission of the Company. This test report does not assure KOLAS accreditation.

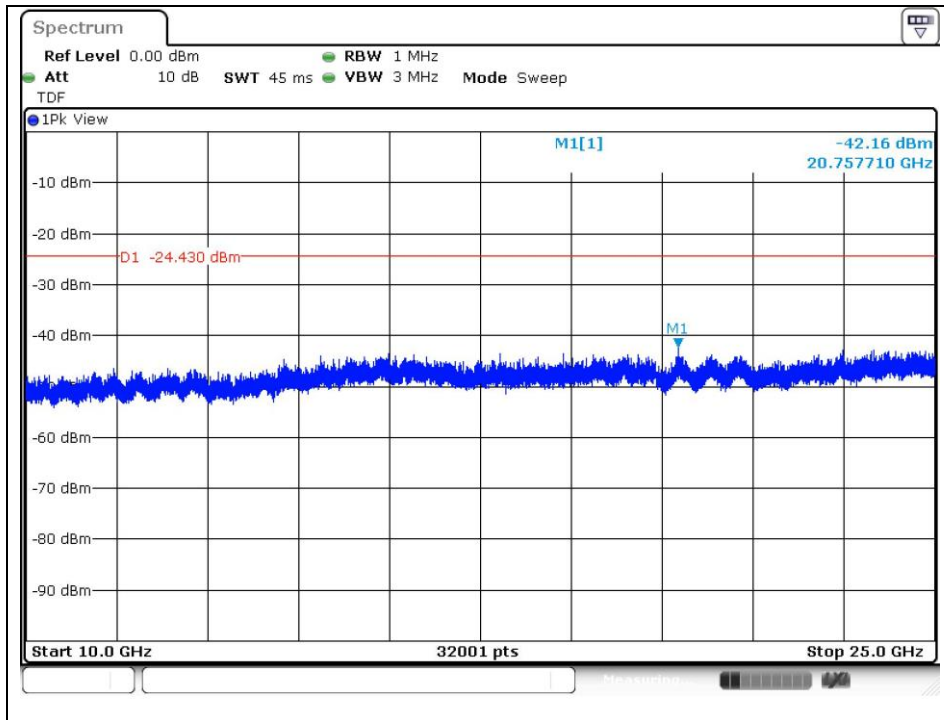

The results of this test report are effective only to the items tested. The SGS Korea is not responsible for the sampling, the results of this test report apply to the sample as received. This test report cannot be reproduced, except in full, without prior written permission of the Company. This test report does not assure KOLAS accreditation.

**SGS Korea Co., Ltd. (Gunpo Laboratory)** 4, LS-ro 182beon-gil, Gunpo-si, Gyeonggi-do, Korea, 15807 <http://www.sgsgroup.kr>



High channel

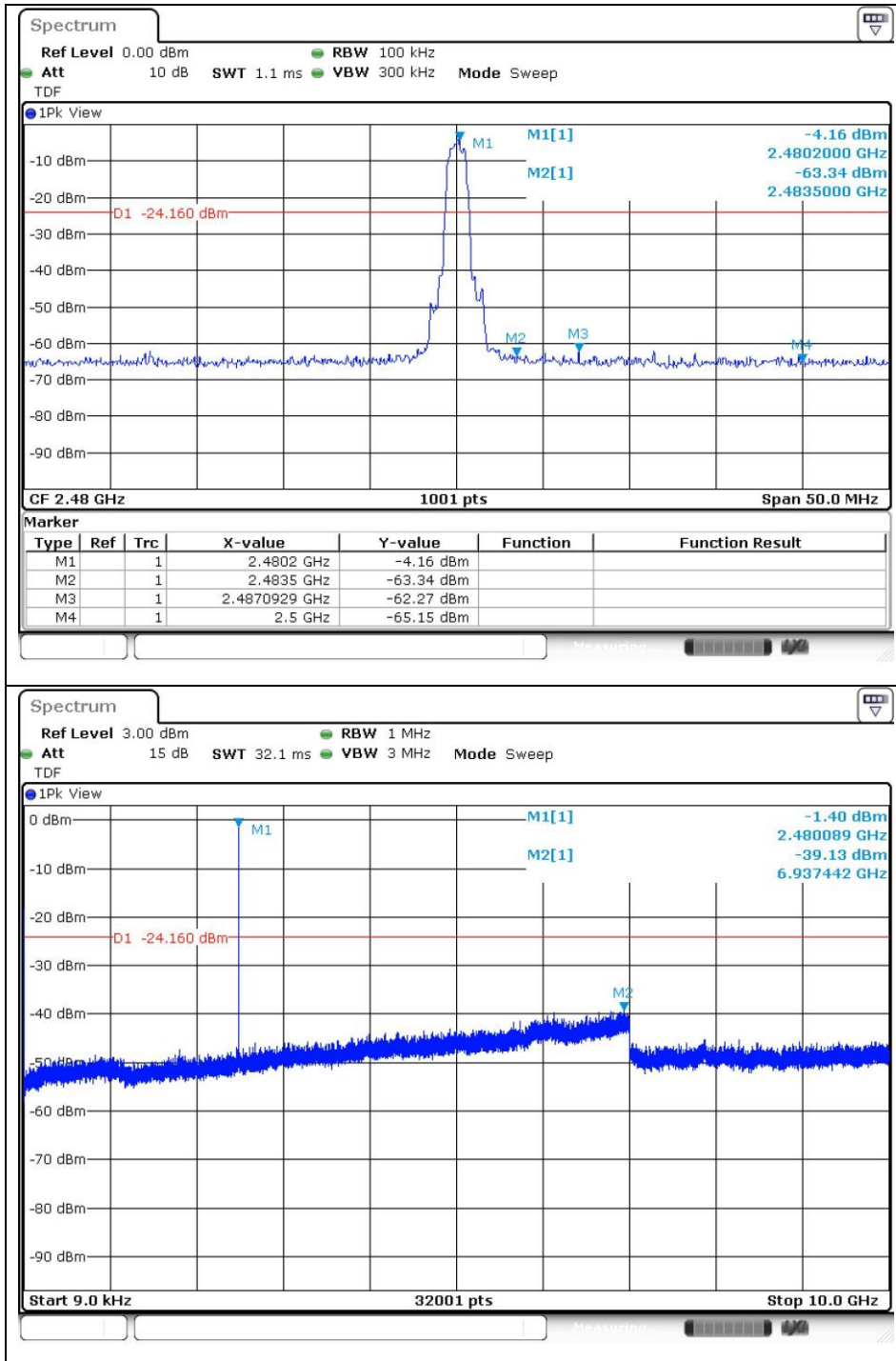

The results of this test report are effective only to the items tested. The SGS Korea is not responsible for the sampling, the results of this test report apply to the sample as received. This test report cannot be reproduced, except in full, without prior written permission of the Company. This test report does not assure KOLAS accreditation.

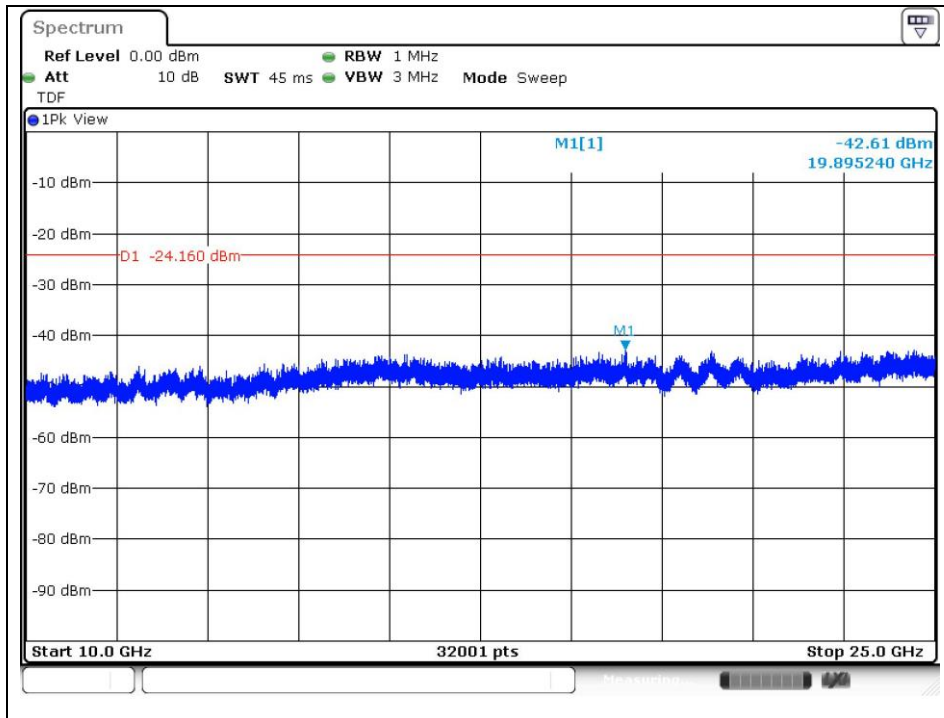

The results of this test report are effective only to the items tested. The SGS Korea is not responsible for the sampling, the results of this test report apply to the sample as received. This test report cannot be reproduced, except in full, without prior written permission of the Company. This test report does not assure KOLAS accreditation.

## Band edge compliance with hopping enabled

Low channel

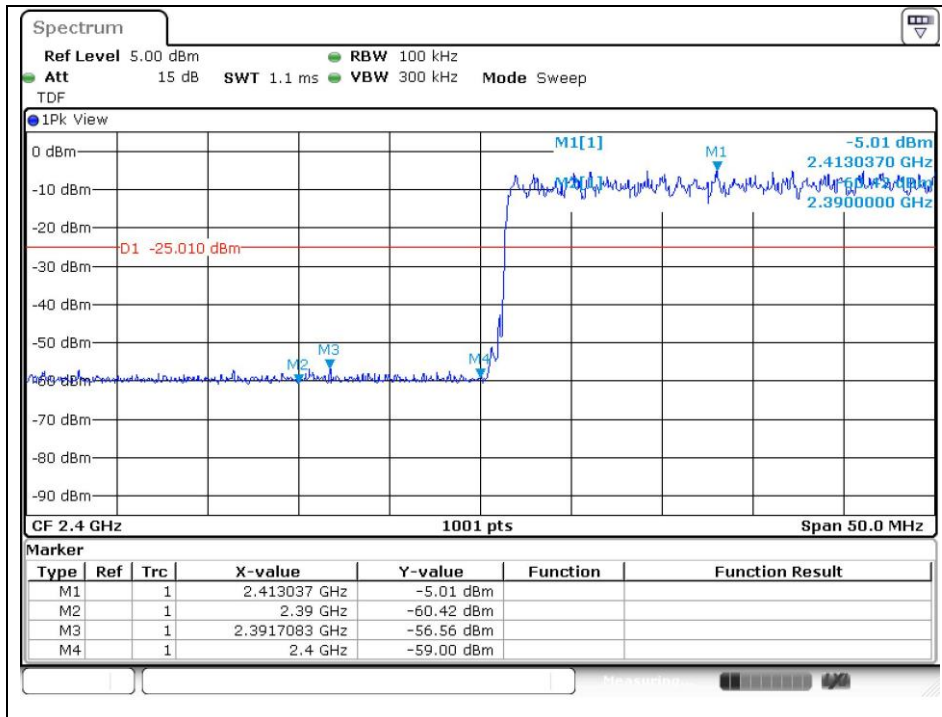

High channel

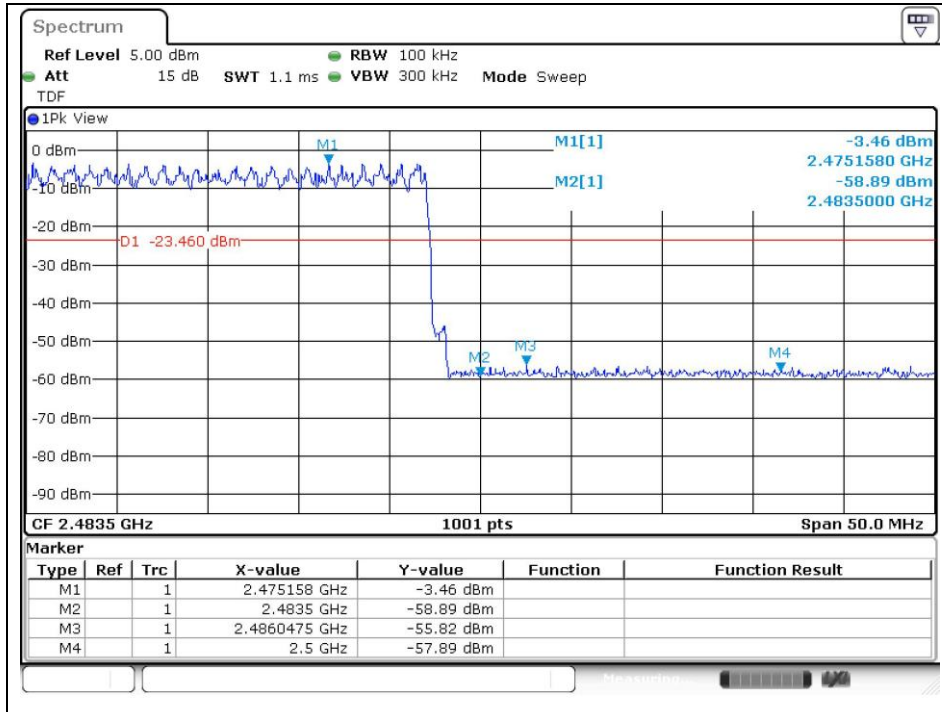

The results of this test report are effective only to the items tested. The SGS Korea is not responsible for the sampling, the results of this test report apply to the sample as received. This test report cannot be reproduced, except in full, without prior written permission of the Company. This test report does not assure KOLAS accreditation.

### 3. 20 dB Bandwidth

#### 3.1. Test Setup

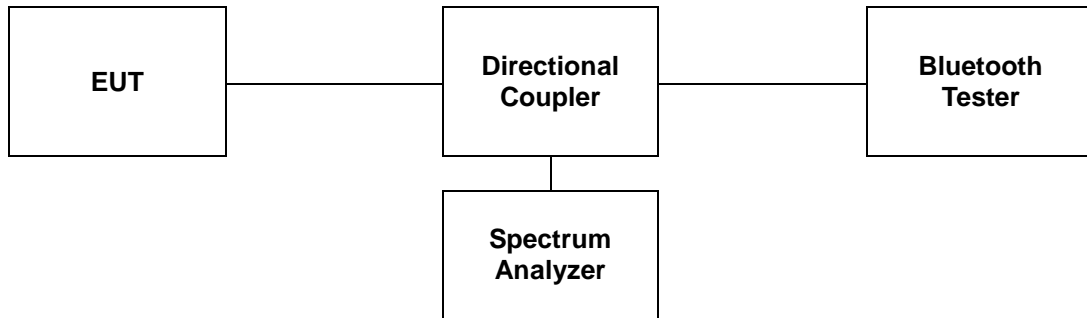

#### 3.2. Limit

Limit: Not Applicable

#### 3.3. Test Procedure

The test follows ANSI C63.10-2013.

The 20 dB bandwidth was measured with a spectrum analyzer connected to RF antenna connector (conducted measurement) while EUT was operating in transmit mode at the appropriate center frequency.

Use the following spectrum analyzer setting:

1. Span = approximately 2 to 5 times the 20 dB bandwidth.
2. RBW  $\geq$  1 % to 5 % of the 20 dB bandwidth.
3. VBW  $\geq$  3 x RBW
4. Sweep = auto
5. Detector = peak
6. Trace = max hold

The marker-to-peak function to set the mark to the peak of the emission. Use the marker-delta function to measure 20 dB down one side of the emission. Reset the function, and move the marker to the other side of the emission, until it is (as close as possible to) even with the reference marker level. The marker-delta reading at this point is 20 dB bandwidth of the emission.

*The results of this test report are effective only to the items tested. The SGS Korea is not responsible for the sampling, the results of this test report apply to the sample as received. This test report cannot be reproduced, except in full, without prior written permission of the Company. This test report does not assure KOLAS accreditation.*

**SGS Korea Co., Ltd. (Gunpo Laboratory)** 4, LS-ro 182beon-gil, Gunpo-si, Gyeonggi-do, Korea, 15807 <http://www.sgsgroup.kr>

### 3.4. Test Results

Ambient temperature : (23 ± 1) °C  
 Relative humidity : 47 % R.H.

Operation Mode	Data Rate (Mbps)	Channel	Frequency (MHz)	20 dB Bandwidth (MHz)
GFSK	1	Low	2 402	1.052
		Middle	2 441	1.052
		High	2 480	1.049
π/4DQPSK	2	Low	2 402	1.349
		Middle	2 441	1.364
		High	2 480	1.361
8DPSK	3	Low	2 402	1.328
		Middle	2 441	1.346
		High	2 480	1.346

*The results of this test report are effective only to the items tested. The SGS Korea is not responsible for the sampling, the results of this test report apply to the sample as received. This test report cannot be reproduced, except in full, without prior written permission of the Company. This test report does not assure KOLAS accreditation.*

**SGS Korea Co., Ltd. (Gunpo Laboratory)** 4, LS-ro 182beon-gil, Gunpo-si, Gyeonggi-do, Korea, 15807 <http://www.sgsgroup.kr>

- Test plots

**Operating Mode: GFSK**

Low Channel

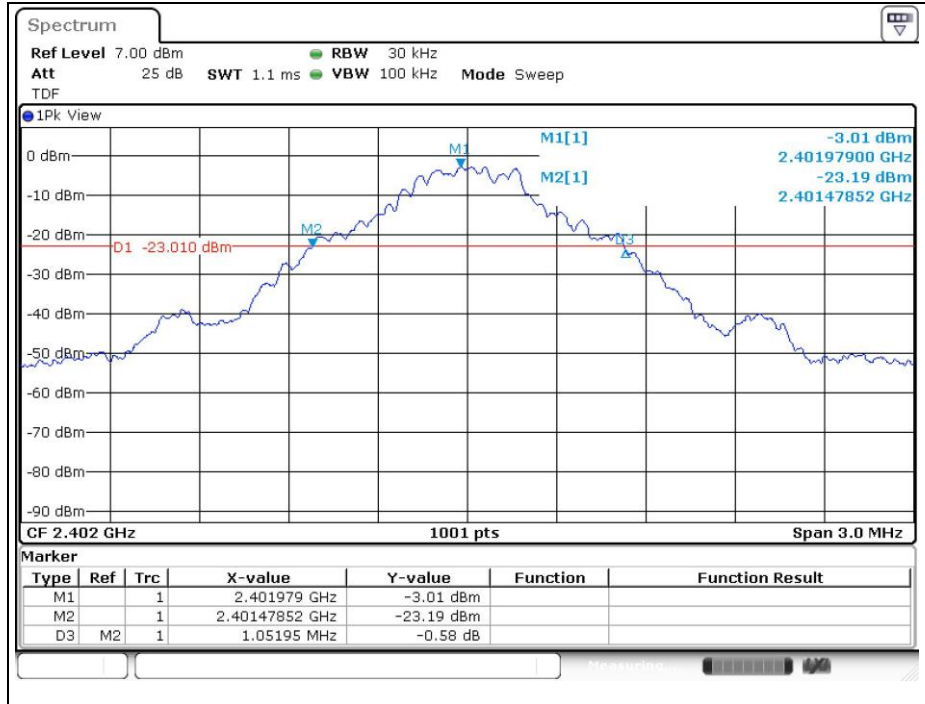

Middle Channel

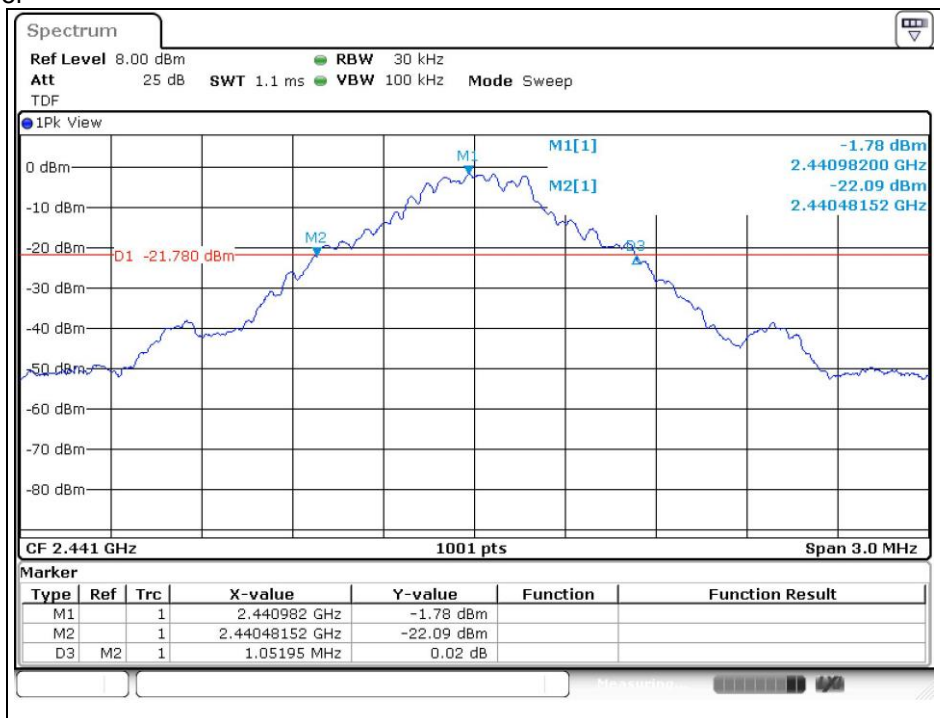

The results of this test report are effective only to the items tested. The SGS Korea is not responsible for the sampling, the results of this test report apply to the sample as received. This test report cannot be reproduced, except in full, without prior written permission of the Company. This test report does not assure KOLAS accreditation.

High Channel

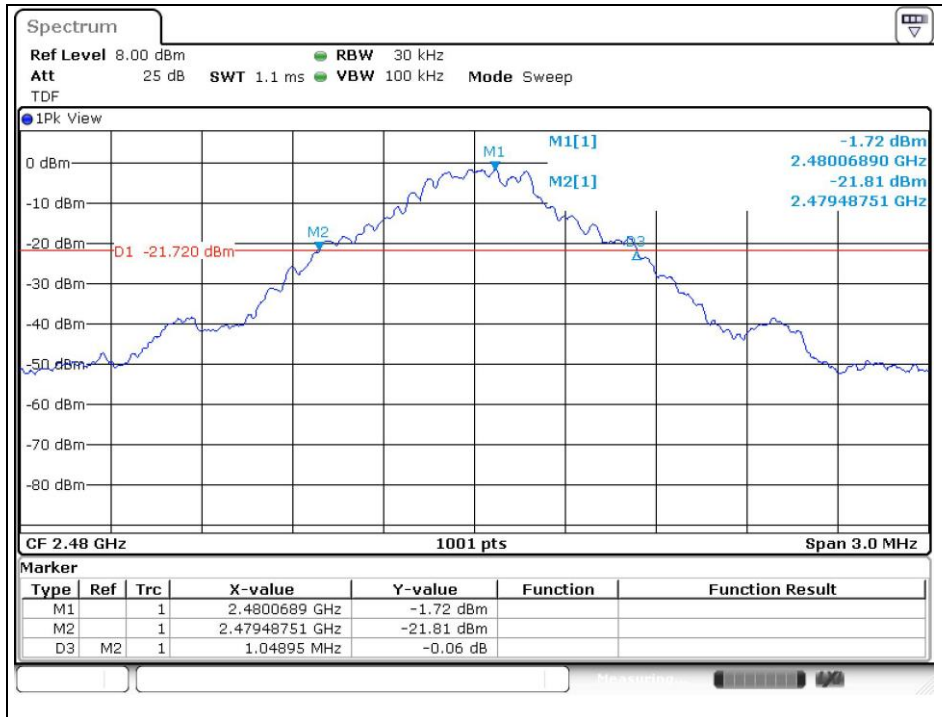

Operating Mode:  $\pi/4$ DQPSK

Low Channel

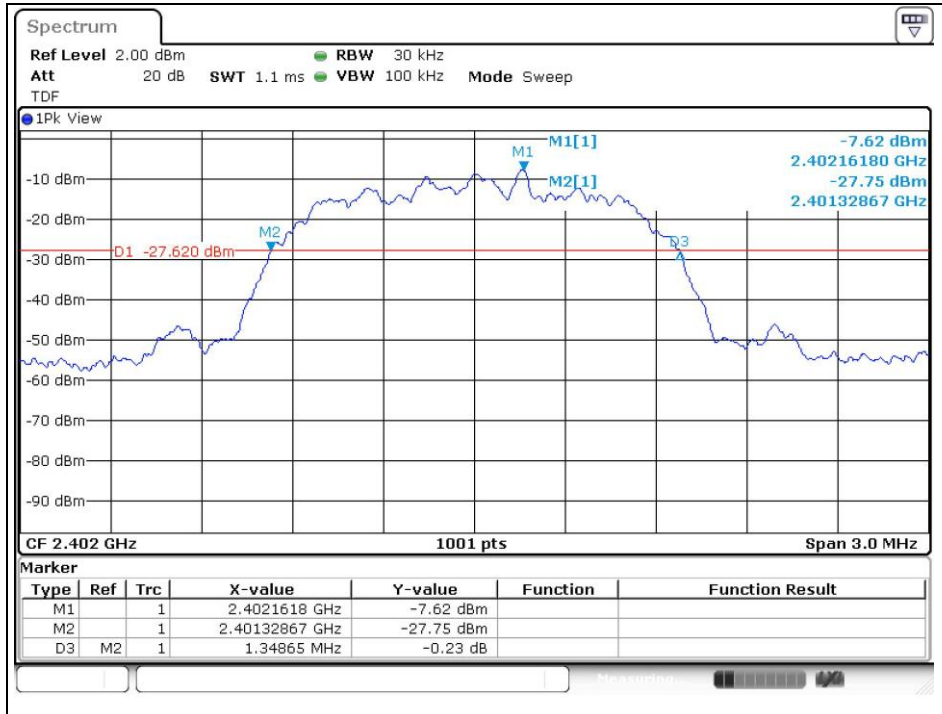

The results of this test report are effective only to the items tested. The SGS Korea is not responsible for the sampling, the results of this test report apply to the sample as received. This test report cannot be reproduced, except in full, without prior written permission of the Company. This test report does not assure KOLAS accreditation.

SGS Korea Co., Ltd. (Gunpo Laboratory) 4, LS-ro 182beon-gil, Gunpo-si, Gyeonggi-do, Korea, 15807 <http://www.sgsgroup.kr>



Middle Channel

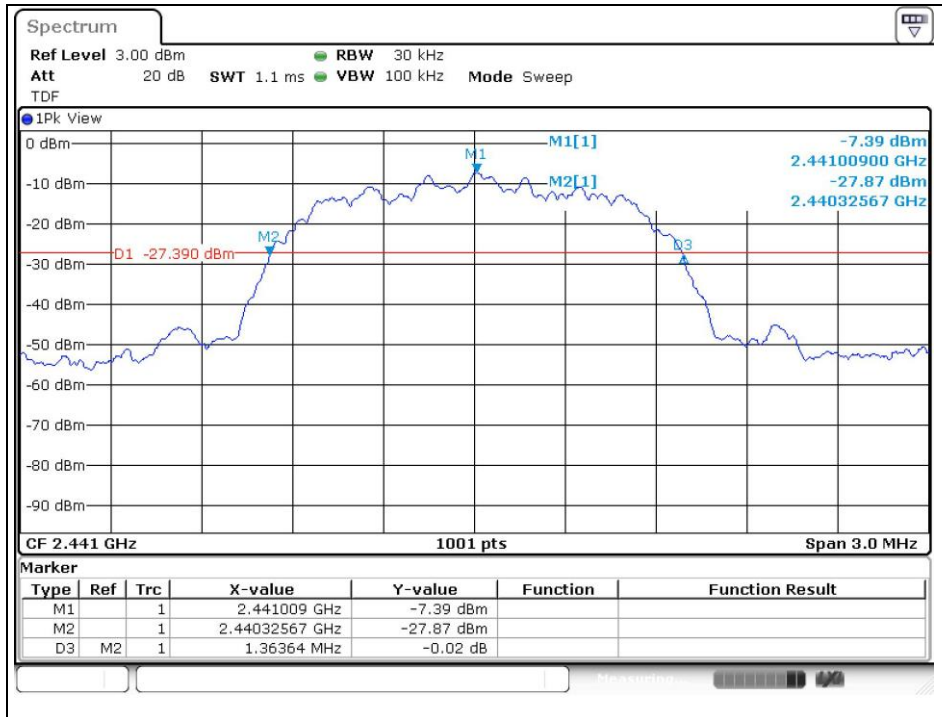

High Channel

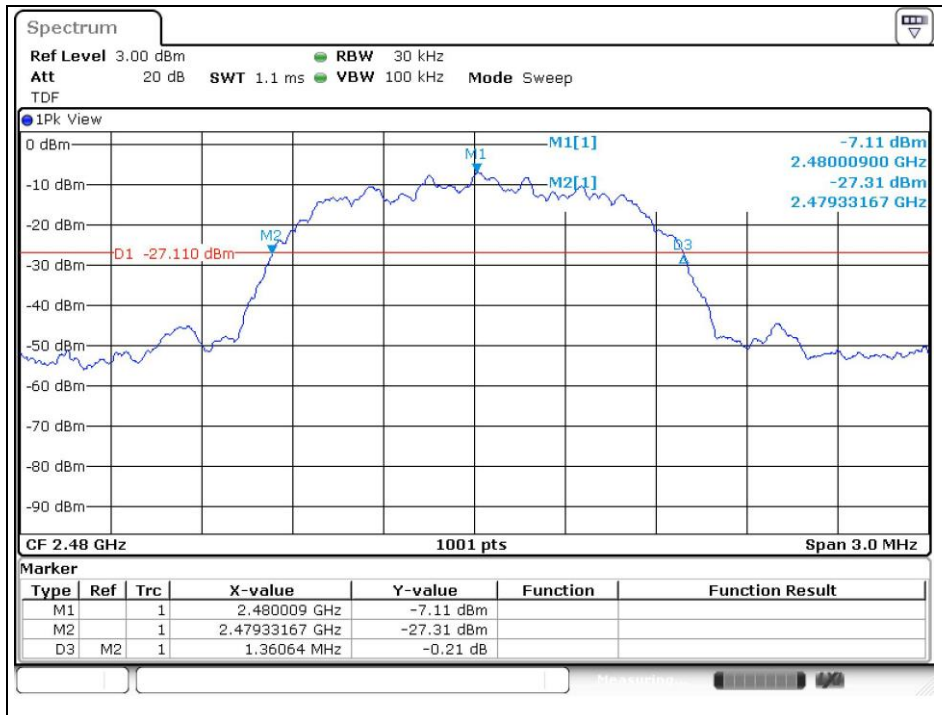

The results of this test report are effective only to the items tested. The SGS Korea is not responsible for the sampling, the results of this test report apply to the sample as received. This test report cannot be reproduced, except in full, without prior written permission of the Company. This test report does not assure KOLAS accreditation.



## Operating Mode: 8DPSK

### Low Channel

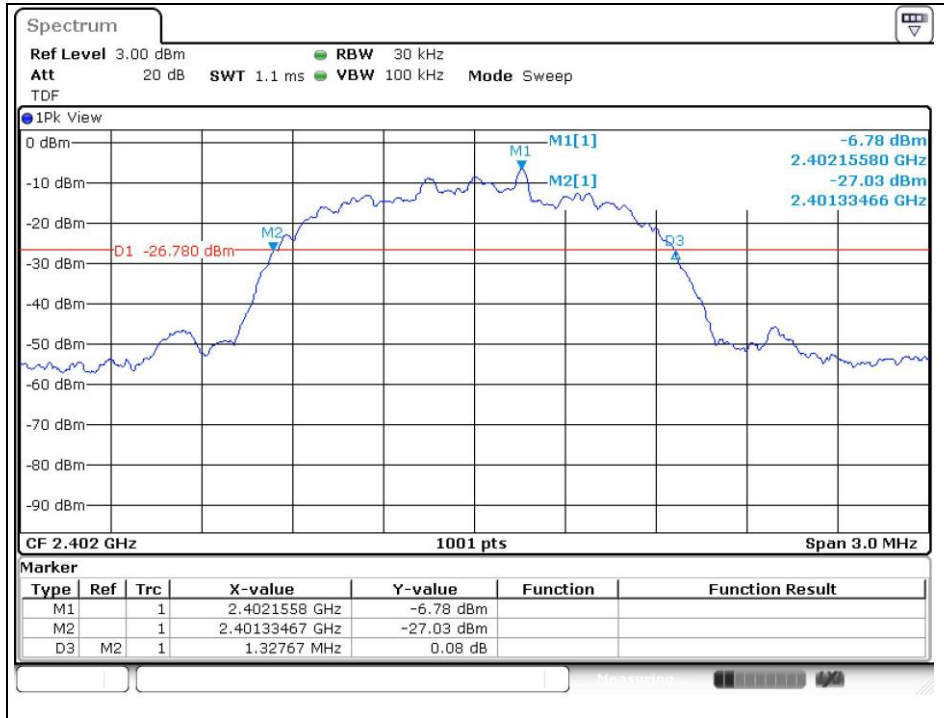

### Middle Channel

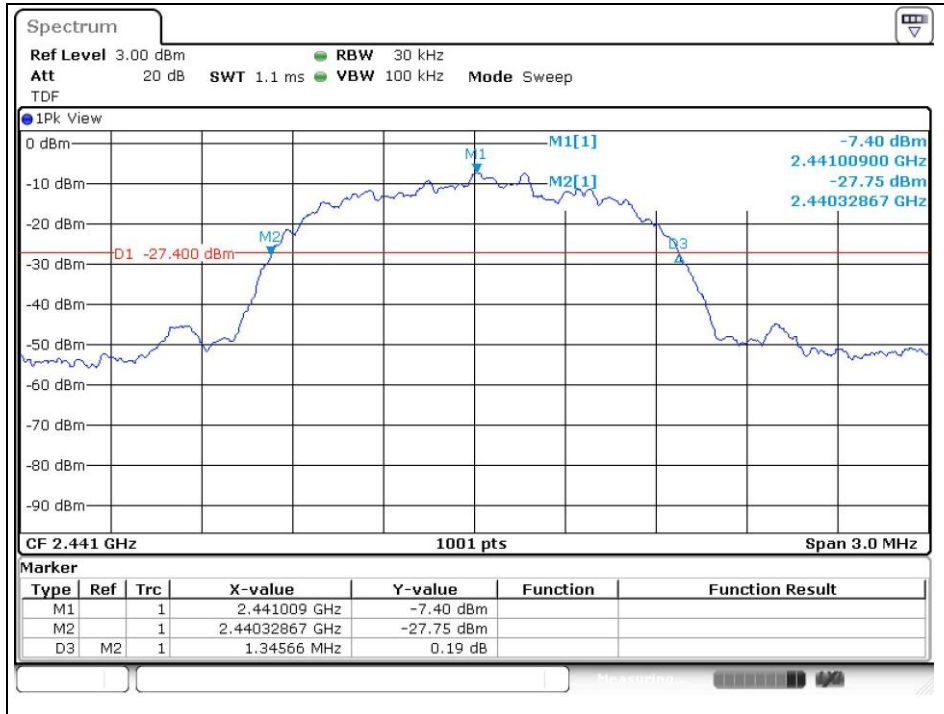

The results of this test report are effective only to the items tested. The SGS Korea is not responsible for the sampling, the results of this test report apply to the sample as received. This test report cannot be reproduced, except in full, without prior written permission of the Company. This test report does not assure KOLAS accreditation.

