

SGS

***Internal photo of EUT***

***Internal view of EUT***



**Top view of Main PCB**

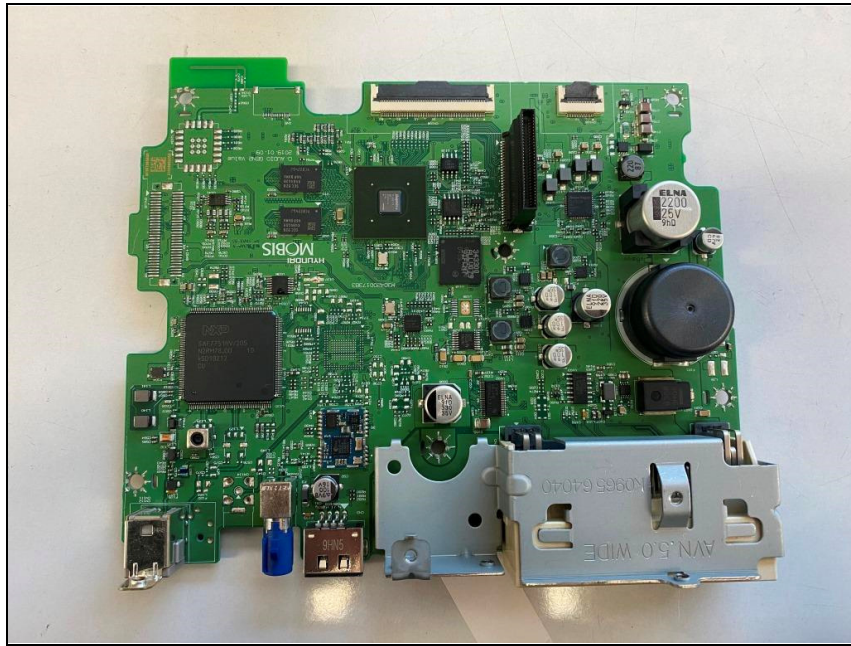

**Bottom view of Main PCB**

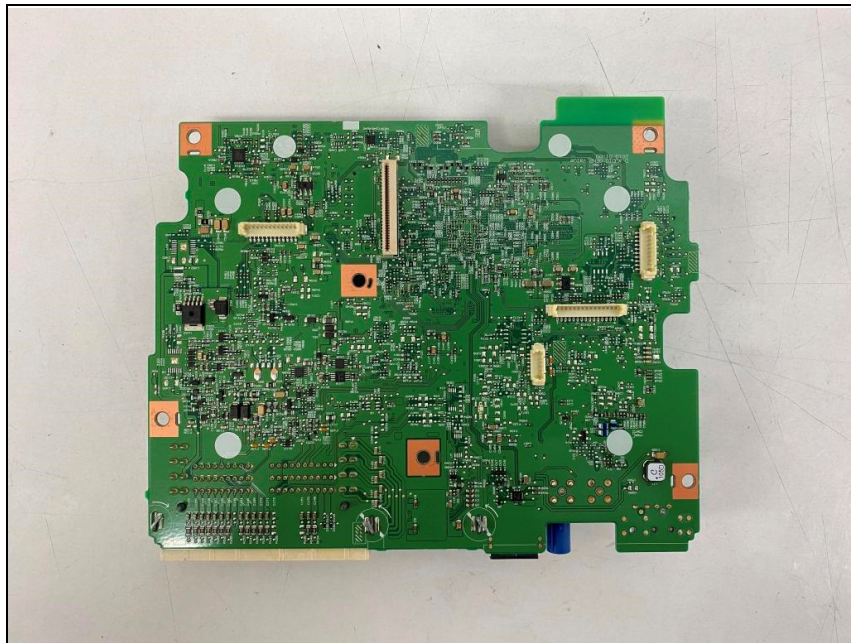

**Top view of Sub PCB1**

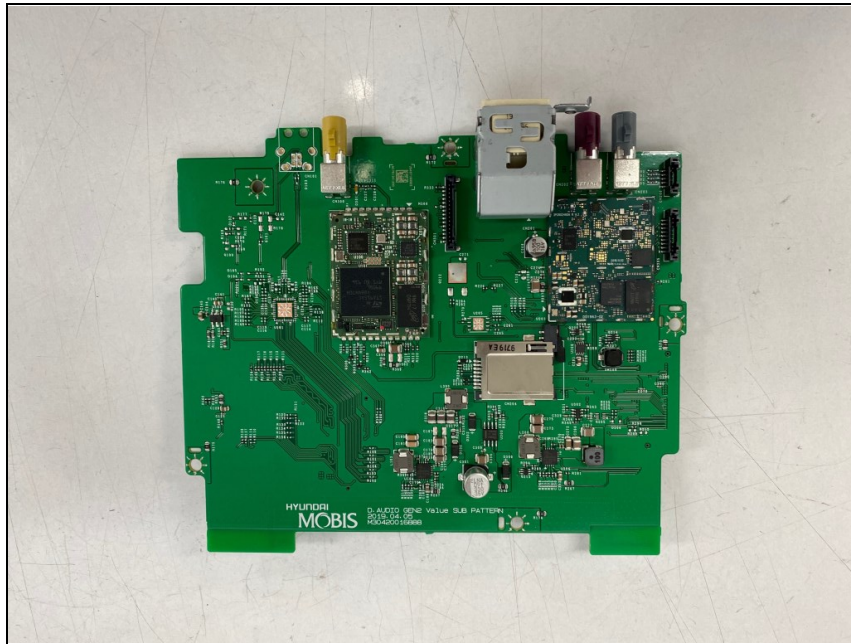

**Bottom view of Sub PCB1**

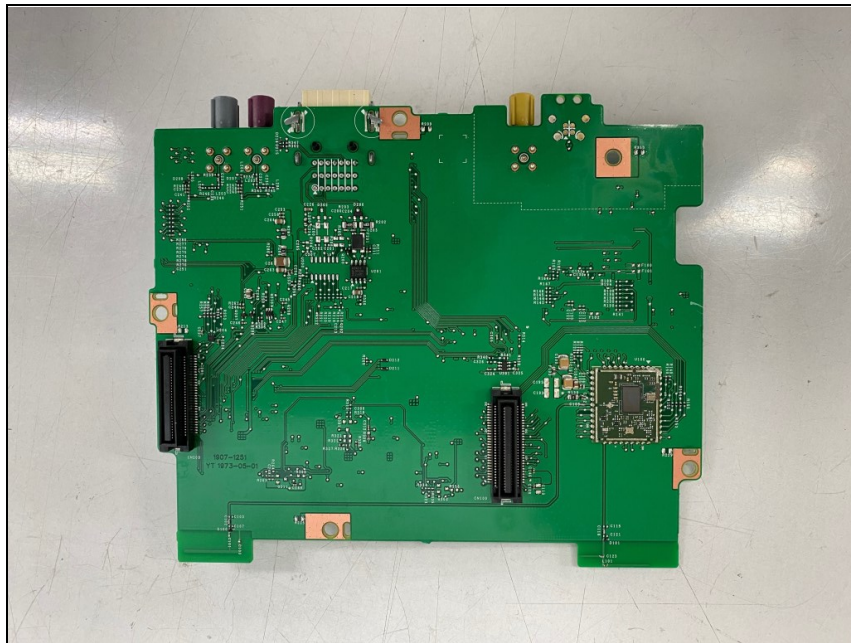

**Top view of Sub PCB2**

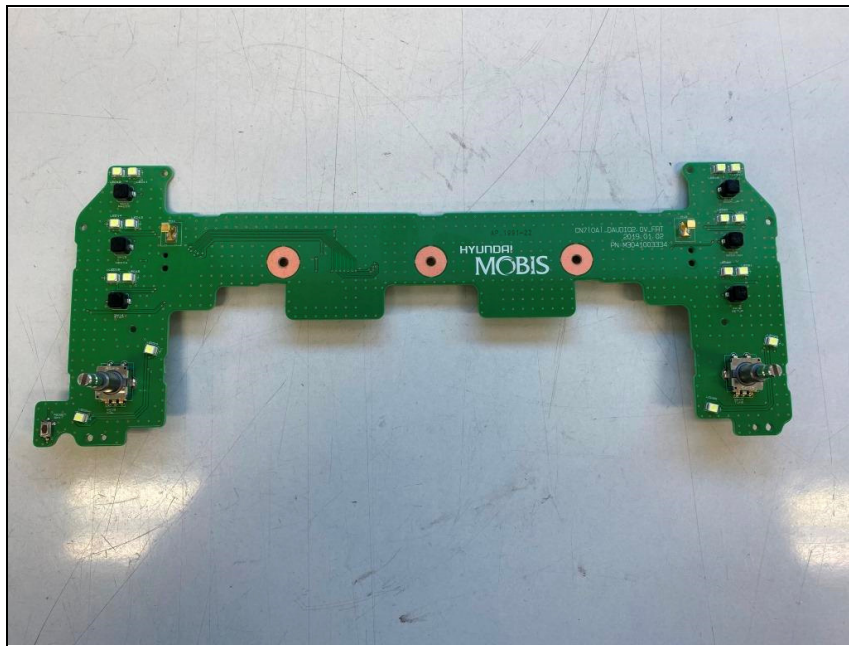

**Bottom view of Sub PCB2**

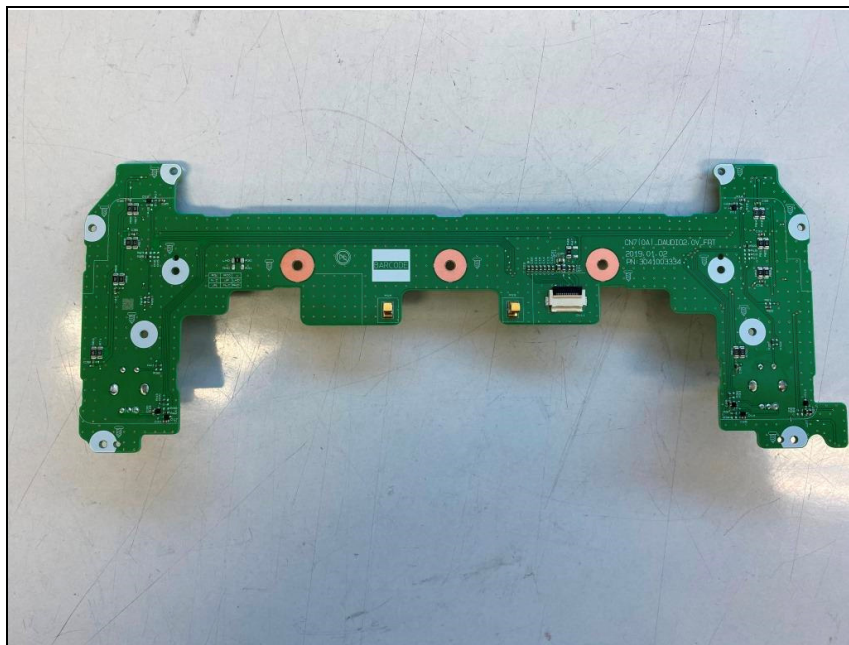

## Top view of Sub PCB3



## Bottom view of Sub PCB3

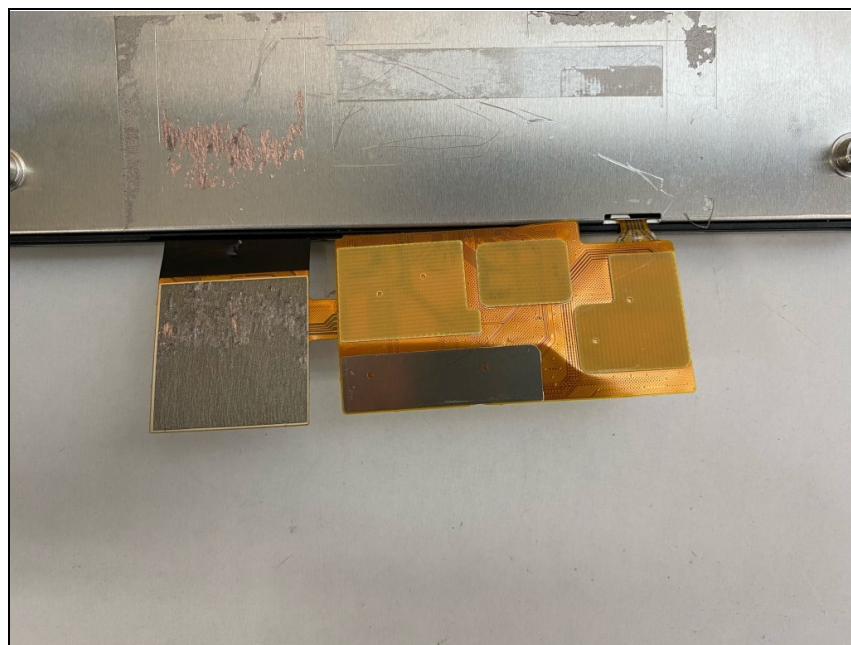

## View of Module with Metal case

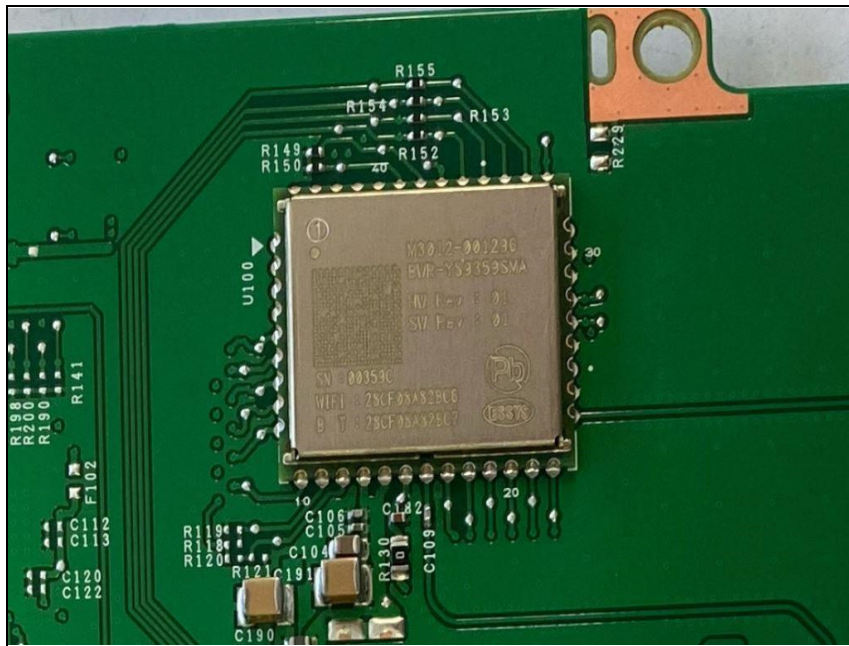

## View of Bluetooth, Wi-Fi Combo module

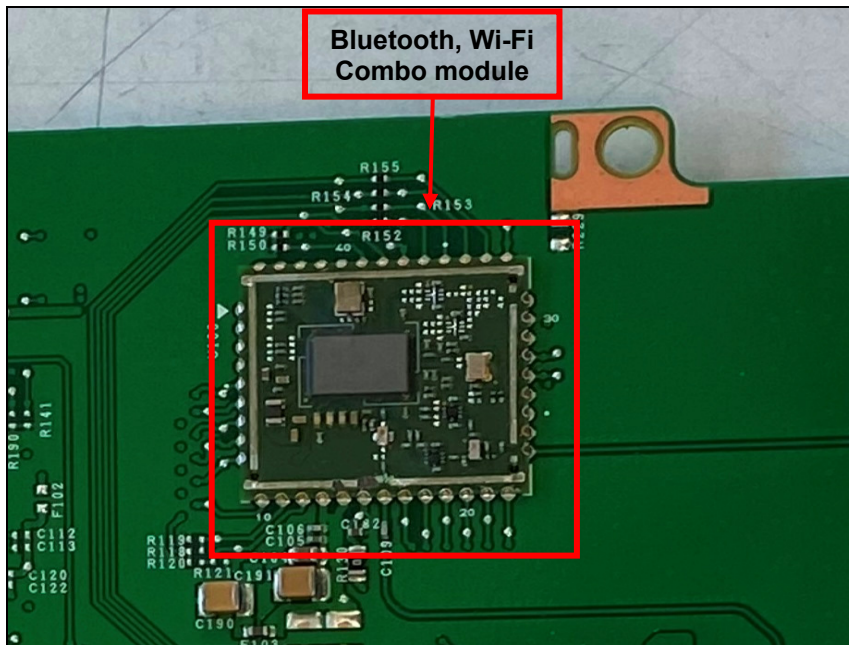

## View of Bluetooth antenna

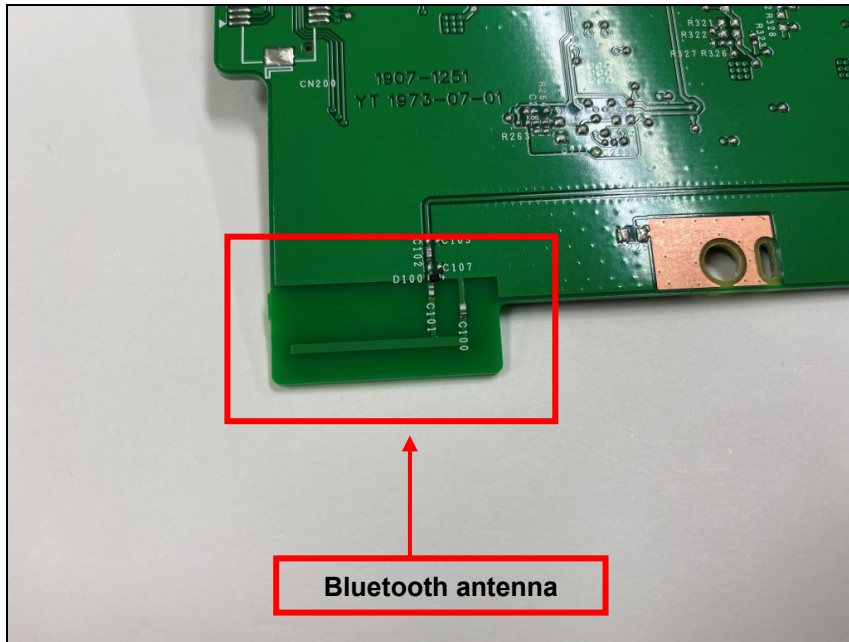

## View of Wi-Fi antenna

