

TEST REPORT

of

FCC Part 15 Subpart C §15.247

FCC ID: TQ8-ADB12D9GG

Equipment Under Test : DISPLAY CAR SYSTEM
Model Name : ADB12D9GG
Variant Model Names : ADB12D9GN, ADB12D9BN, ADB12D9GE,
ADB12D9GL, ADB12D9EG, ADB12D9EN,
ADB10F1EG, ADB10F1GG, ADB10F1MG
Applicant : Hyundai Mobis Co., Ltd.
Manufacturer : Hyundai Mobis Co., Ltd.
Date of Receipt : 2018.01.11
Date of Test(s) : 2018.01.23 ~ 2018.01.30
Date of Issue : 2018.01.30

In the configuration tested, the EUT complied with the standards specified above.

Tested By:



Jinhyoung Cho

Date:

2018.01.30

Technical
Manager:

Hyunhae You

Date:

2018.01.30

The results shown in this test report refer only to the sample(s) tested unless otherwise stated. This test report cannot be reproduced, except in full, without prior written permission of the Company. This test report does not assure KOLAS accreditation.

INDEX

<u>Table of Contents</u>	Page
1. General Information -----	3
2. Transmitter Radiated Spurious Emissions and Conducted Spurious Emission -----	11
3. 20 dB Bandwidth -----	38
4. Maximum Peak Conducted Output Power -----	44
5. Carrier Frequency Separation -----	46
6. Number of Hopping Frequencies -----	49
7. Time of Occupancy(Dwell Time) -----	53
8. Antenna Requirement -----	66

The results shown in this test report refer only to the sample(s) tested unless otherwise stated. This test report cannot be reproduced, except in full, without prior written permission of the Company. This test report does not assure KOLAS accreditation.

1. General Information

1.1. Testing Laboratory

SGS Korea Co., Ltd. (Gunpo Laboratory)

- Wireless Div. 2FL, 10-2, LS-ro 182beon-gil, Gunpo-si, Gyeonggi-do, Korea, 15807
- Designation number: KR0150

All SGS services are rendered in accordance with the applicable SGS conditions of service available on request and accessible at <http://www.sgs.com/en/Terms-and-Conditions.aspx>.

Phone No. : +82 31 688 0901

Fax No. : +82 31 688 0921

1.2. Details of applicant

Applicant : Hyundai Mobis Co., Ltd.

Address : 203, Teheran-ro, Gangnam-gu, Seoul, 06141, South Korea

Contact Person : Choe, Seung-Hoon

Phone No. : +82 31 260 0098

1.3. Details of manufacturer

Company : Same as applicant

Address : Same as applicant

1.4. Description of EUT

Kind of Product	DISPLAY CAR SYSTEM
Model Name	ADB12D9GG
Variant Model Names	ADB12D9GN, ADB12D9BN, ADB12D9GE, ADB12D9GL, ADB12D9EG, ADB12D9EN, ADB10F1EG, ADB10F1GG, ADB10F1MG
Power Supply	DC 14.4 V
Frequency Range	2 402 MHz ~ 2 480 MHz (Bluetooth)
Modulation Technique	GFSK, $\pi/4$ DQPSK, 8DPSK
Number of Channels	79 channels
Antenna Type	Pattern Antenna
Antenna Gain	-0.05 dB i

1.5. Declaration by the manufacturer

- Adaptive Frequency Hopping is supported and use at least 20 channels.

The results shown in this test report refer only to the sample(s) tested unless otherwise stated. This test report cannot be reproduced, except in full, without prior written permission of the Company. This test report does not assure KOLAS accreditation.

1.6. Information about the FHSS characteristics:

1.6.1. Pseudorandom Frequency Hopping Sequence

The channel is represented by a pseudo-random hopping sequence hopping through the 79 RF channels. The hopping sequence is unique for the piconet and is determined by the Bluetooth device address of the master; the phase in the hopping sequence is determined by the Bluetooth clock of the master. The channel is divided into time slots where each slot corresponds to an RF hop frequency. Consecutive hops correspond to different RF hop frequencies. The nominal hop rate is 1 600 hops/s.

1.6.2. Equal Hopping Frequency Use

The channels of this system will be used equally over the long-term distribution of the hopsets.

1.6.3. Example of a 79 hopping sequence in data mode:

02, 05, 31, 24, 20, 10, 43, 36, 30, 23, 40, 06, 21, 50, 44, 09, 71, 78, 01, 13, 73, 07, 70, 72, 35, 62, 42, 11, 41, 08, 16, 29, 60, 15, 34, 61, 58, 04, 67, 12, 22, 53, 57, 18, 27, 76, 39, 32, 17, 77, 52, 33, 56, 46, 37, 47, 64, 49, 45, 38, 69, 14, 51, 26, 79, 19, 28, 65, 75, 54, 48, 03, 25, 66, 05, 16, 68, 74, 59, 63, 55

1.6.4. System Receiver Input Bandwidth

Each channel bandwidth is 1 MHz.

The system receivers have input bandwidths that match the hopping channel bandwidths of their corresponding transmitters and shift frequencies in synchronization with the transmitted signals.

1.6.5. Equipment Description

15.247(a)(1) that the Rx input bandwidths shift frequencies in synchronization with the transmitted signals.

15.247(g): In accordance with the Bluetooth Industry Standard, the system is designed to comply with all of the regulations in Section 15.247 when the transmitter is presented with a continuous data (or information) system.

15.247(h): In accordance with the Bluetooth Industry Standard, the system does not coordinate its channels selection/ hopping sequence with other frequency hopping systems for the express purpose of avoiding the simultaneous occupancy of individual hopping frequencies by multiple transmitters.

The results shown in this test report refer only to the sample(s) tested unless otherwise stated. This test report cannot be reproduced, except in full, without prior written permission of the Company. This test report does not assure KOLAS accreditation.

1.7. Test Equipment List

Equipment	Manufacturer	Model	S/N	Cal. Date	Cal. Interval	Cal. Due
Signal Generator	R&S	SMBV100A	259067	Jun. 15, 2017	Annual	Jun. 15, 2018
Signal Generator	R&S	SMR40	100272	Jun. 16, 2017	Annual	Jun. 16, 2018
Spectrum Analyzer	R&S	FSV30	100955	Mar. 20, 2017	Annual	Mar. 20, 2018
Spectrum Analyzer	Agilent	N9020A	MY53421758	Sep. 25, 2017	Annual	Sep. 25, 2018
Bluetooth Tester	TESCOM	TC-3000C	3000C000296	Jun. 16, 2017	Annual	Jun. 16, 2018
Directional Coupler	KRYTAR	152613	122660	Jun. 12, 2017	Annual	Jun. 12, 2018
High Pass Filter	Wainwright Instrument GmbH	WHK3.0/18G-6SS	4	Jun. 14, 2017	Annual	Jun. 14, 2018
High Pass Filter	Wainwright Instrument GmbH	WHNX7.5/26.5G-6SS	11	May 28, 2017	Annual	May 28, 2018
Low Pass Filter	Mini-Circuits	NLP-1200+	V 8979400903-2	Feb. 21, 2017	Annual	Feb. 21, 2018
Power Sensor	R&S	NRP-Z81	100748	Jun. 13, 2017	Annual	Jun. 13, 2018
DC Power Supply	Agilent	U8002A	MY48490027	Dec. 07, 2017	Annual	Dec. 07, 2018
Preamplifier	H.P.	8447F	2944A03909	Aug. 11, 2017	Annual	Aug. 11, 2018
Signal Conditioning Unit	R&S	SCU-18	102244	Sep. 22, 2017	Annual	Sep. 22, 2018
Preamplifier	MITEQ Inc.	JS44-18004000-35-8P	1546891	May 15, 2017	Annual	May 15, 2018
Loop Antenna	Schwarzbeck Mess-Elektronik	FMZB 1519	1519-039	Aug. 23, 2017	Biennial	Aug. 23, 2019
Log-Periodic Antenna	HL223	837942/015	R & S	Dec. 01, 2017	Biennial	Dec. 01, 2019
Biconical Antenna	HK116	8374141/007	R & S	Dec. 01, 2017	Biennial	Dec. 01, 2019
Horn Antenna	R&S	HF906	100326	Feb. 01, 2016	Biennial	Feb. 01, 2018
Horn Antenna	Schwarzbeck Mess-Elektronik	BBHA 9170	BBHA9170431	Aug. 25, 2016	Biennial	Aug. 25, 2018
Antenna Master	INNCO systems GmbH	MA4640-XP-ET	MA4640/536/383 30516/L	N.C.R.	N/A	N.C.R.
Controller	INNCO systems GmbH	CONTROLLER CO3000-4P	CO3000/963/383 30516/L	N.C.R.	N/A	N.C.R.
Turn Table	INNCO systems GmbH	DS 1200 S	N/A	N.C.R.	N/A	N.C.R.
Test Receiver	R&S	ESU26	100109	Feb. 17, 2017	Annual	Feb. 17, 2018
Anechoic Chamber	SY Corporation	L x W x H (9.6 m x 6.4 m x 6.6 m)	N/A	N.C.R.	N/A	N.C.R.
Coaxial Cable	SUCOFLEX	104 (3 m)	MY3258414	Jan. 12, 2018	Semi-annual	Jul. 12, 2018
Coaxial Cable	SUCOFLEX	104 (10 m)	MY3145814	Jan. 12, 2018	Semi-annual	Jul. 12, 2018
Coaxial Cable	Rosenberger	LA1-C006-1500	131014 01/20	Sep. 06, 2017	Semi-annual	Mar. 06, 2018
Coaxial Cable	Rosenberger	LA1-C006-1500	131014 05/20	Sep. 06, 2017	Semi-annual	Mar. 06, 2018
Coaxial Cable	Rosenberger	LA1-C006-1500	131014 10/20	Sep. 06, 2017	Semi-annual	Mar. 06, 2018

The results shown in this test report refer only to the sample(s) tested unless otherwise stated. This test report cannot be reproduced, except in full, without prior written permission of the Company. This test report does not assure KOLAS accreditation.

1.8. Information of Variant Models

Model name		BT	DAB	RDS	E-CAII	E.AMP
Basic model	ADB12D9GG	O	X	X	X	Internal
Variant models	ADB12D9GN	O	X	X	X	Internal
	ADB12D9BN	O	X	X	X	Internal
	ADB12D9GE	O	X	X	X	Internal
	ADB12D9GL	O	X	X	X	Internal
	ADB12D9EG	O	X	X	X	Internal
	ADB12D9EN	O	X	X	X	Internal
	ADB10F1EG	O	X	O	X	Internal
	ADB10F1GG	O	X	O	X	Internal
	ADB10F1MG	O	X	X	X	Internal

Remark:

The variant model is added for marketing purpose.

The results shown in this test report refer only to the sample(s) tested unless otherwise stated. This test report cannot be reproduced, except in full, without prior written permission of the Company. This test report does not assure KOLAS accreditation.

1.9. Summary of Test Results

The EUT has been tested according to the following specifications:

APPLIED STANDARD: FCC Part15 subpart C		
Standard Section	Test Item	Result
15.205(a) 15.209 15.247(d)	Transmitter Radiated Spurious Emissions Conducted Spurious Emission	Complied
15.247(a)(1)	20 dB Bandwidth	Complied
15.247(b)(1)	Maximum Peak Conducted Output Power	Complied
15.247(a)(1)	Carrier Frequency Separation	Complied
15.247(a)(1)(iii)	Number of Hopping Frequencies	Complied
15.247(a)(1)(iii)	Time of Occupancy (Dwell Time)	Complied

1.10. Test Procedure(s)

The measurement procedures described in the American National Standard for Testing Unlicensed Wireless Devices (ANSI C63.10-2013) is used in the measurement of the DUT.

1.11. Sample calculation

Where relevant, the following sample calculation is provided:

1.11.1. Conducted test

Offset value (dB) = Directional coupler (dB) + Cable loss (dB)

1.11.2. Radiation test

Field strength level (dB μ V/m) = Measured level (dB μ V) + Antenna factor (dB) + Cable loss (dB) - Amplifier gain (dB)

1.12. Test report revision

Revision	Report number	Date of Issue	Description
0	F690501/RF-RTL012333	2018.01.30	Initial

The results shown in this test report refer only to the sample(s) tested unless otherwise stated. This test report cannot be reproduced, except in full, without prior written permission of the Company. This test report does not assure KOLAS accreditation.

1.13. Descriptions of Test Mode

Preliminary tests were performed in different data rates and recorded the RF output power in the following table:

Operation Mode	Data Rate	Channel	Frequency (MHz)	RF Output Power (dBm)
GFSK	1 Mbps	Low	2 402	0.57
		Middle	2 441	1.08
		High	2 480	0.13
$\pi/4$ DQPSK	2 Mbps	Low	2 402	1.11
		Middle	2 441	1.60
		High	2 480	0.80
8DPSK	3 Mbps	Low	2 402	1.41
		Middle	2 441	2.05
		High	2 480	1.05

Remark:

1. For transmitter radiated spurious emissions, conducted spurious emission, carrier frequency separation and number of hopping frequencies, GFSK / DH5 and 8DPSK / 3DH5 are tested as worst condition.
2. For 20 dB bandwidth and maximum peak conducted output power, GFSK / DH5, $\pi/4$ DQPSK / 2DH5 and 8DPSK / 3DH5 are tested as worst condition.
3. For Time of Occupancy, GFSK / DH1, DH3, DH5 and 8DPSK / 3DH1, 3DH3, 3DH5 are tested as worst condition.

The results shown in this test report refer only to the sample(s) tested unless otherwise stated. This test report cannot be reproduced, except in full, without prior written permission of the Company. This test report does not assure KOLAS accreditation.

1.14. Duty Cycle Correction Factor of EUT

According to 15.35 (c), as a “duty cycle correction factor”, pulse averaging with $20 \log(\text{worst case dwell time} / 100 \text{ ms})$ has to be used for average result.

3DH5 on time (One Pulse) Plot on Channel 39

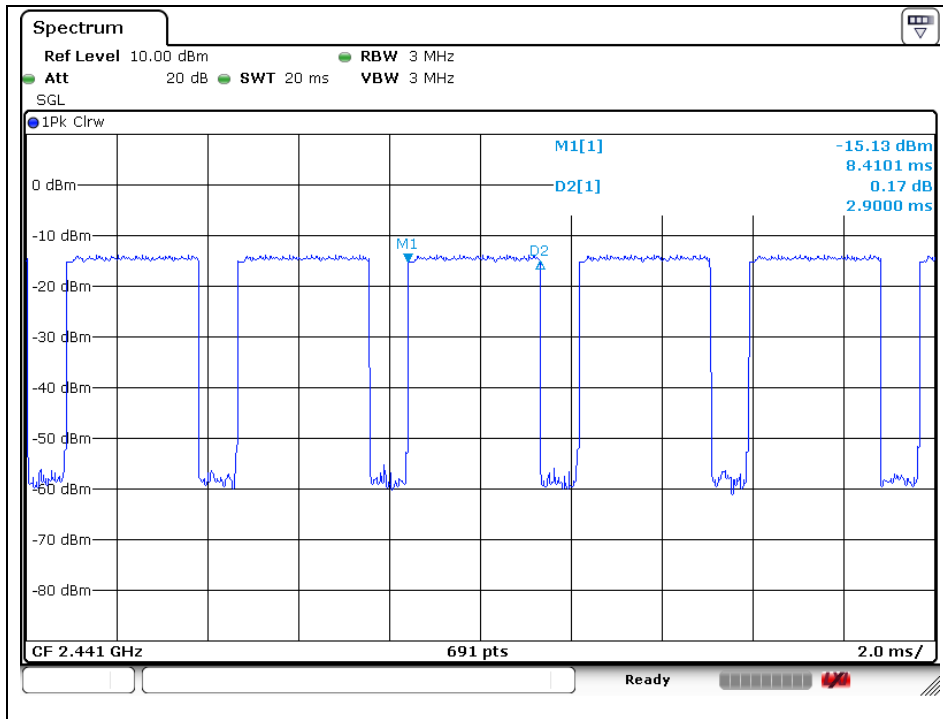

The results shown in this test report refer only to the sample(s) tested unless otherwise stated. This test report cannot be reproduced, except in full, without prior written permission of the Company. This test report does not assure KOLAS accreditation.

3DH5 on time (Count Pulses) Plot on Channel 39

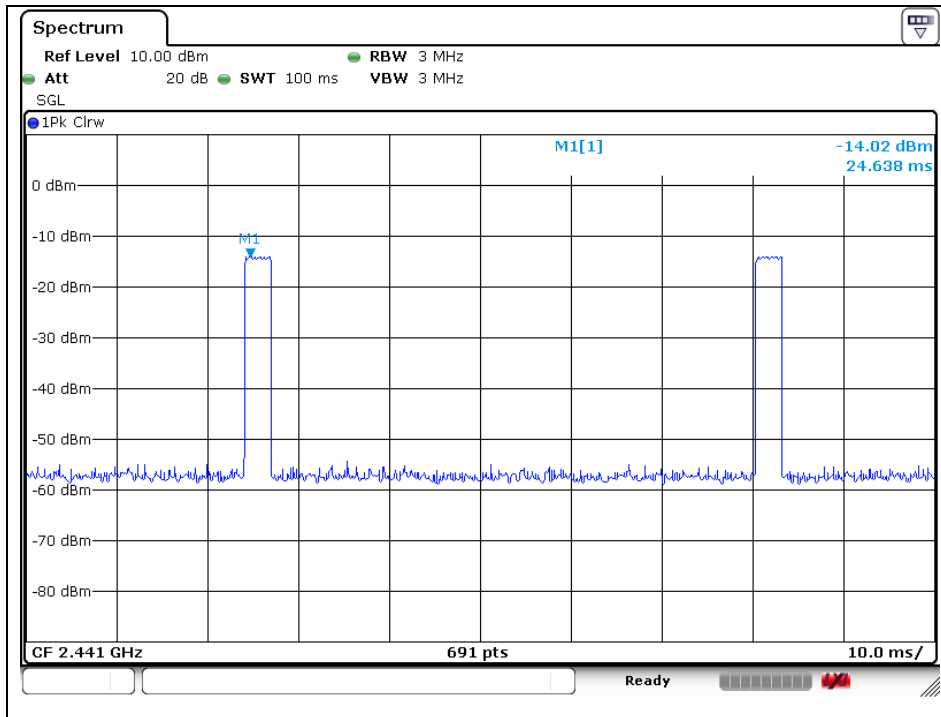

In AFH mode, the minimum hopping frequencies are 20, to get the longest dwell time 3DH5 packet is observed;
the period to have 3DH5 packet completing one hopping sequence is $2.90 \text{ ms} \times 20 \text{ channels} = 58.00 \text{ ms}$

There cannot be 2 complete hopping sequences within 100 ms period, considering the random hopping behavior, maximum 2 hops can be possibly observed within the period. $[100 \text{ ms} / 58.00 \text{ ms}] = 2 \text{ hops}$

Thus, the maximum possible ON time:

$$2.90 \text{ ms} \times 2 = 5.80 \text{ ms}$$

Worst case Duty Cycle Correction factor, which is derived from the maximum possible ON time:

$$20 \times \log(5.80 \text{ ms} / 100 \text{ ms}) = -24.73 \text{ dB}$$

The results shown in this test report refer only to the sample(s) tested unless otherwise stated. This test report cannot be reproduced, except in full, without prior written permission of the Company. This test report does not assure KOLAS accreditation.

2. Transmitter Radiated Spurious Emissions and Conducted Spurious Emission

2.1. Test Setup

2.1.1. Transmitter Radiated Spurious Emissions

The diagram below shows the test setup that is utilized to make the measurements for emission from 9 kHz to 30 MHz.

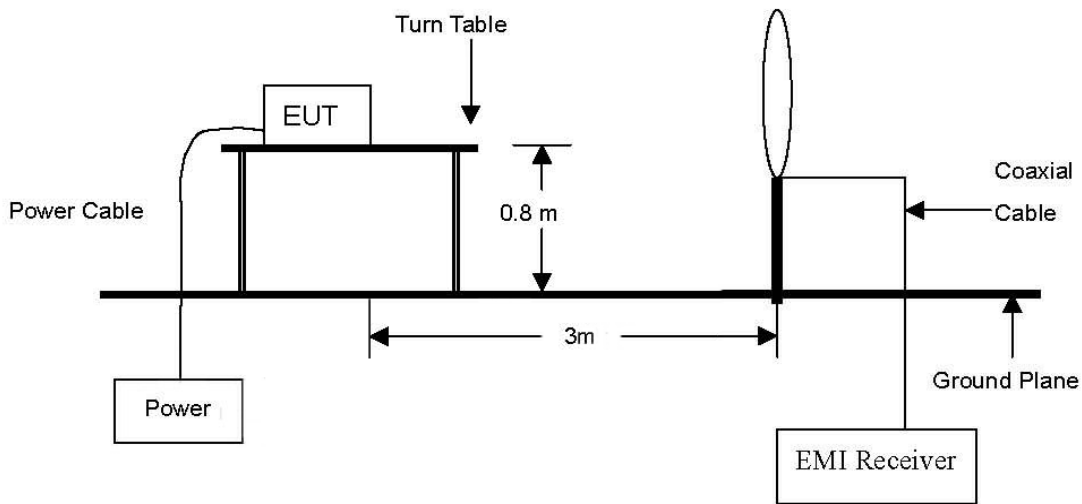

The diagram below shows the test setup that is utilized to make the measurements for emission from 30 MHz to 1 GHz.

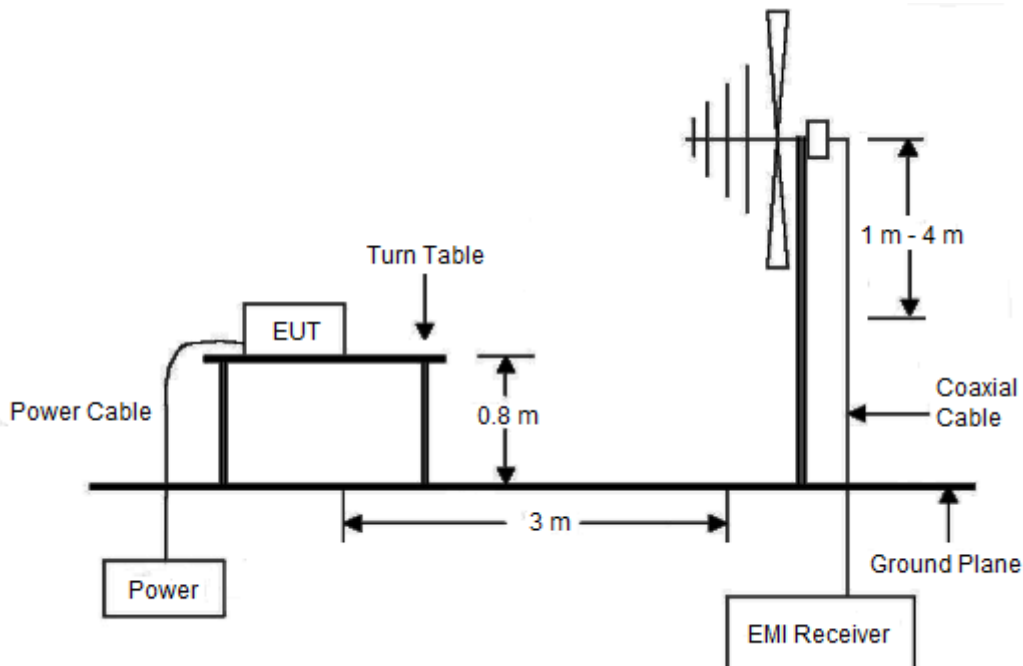

The results shown in this test report refer only to the sample(s) tested unless otherwise stated. This test report cannot be reproduced, except in full, without prior written permission of the Company. This test report does not assure KOLAS accreditation.

The diagram below shows the test setup that is utilized to make the measurements for emission. The spurious emissions were investigated from 1 GHz to the 10th harmonic of the highest fundamental frequency or 40 GHz, whichever is lower.

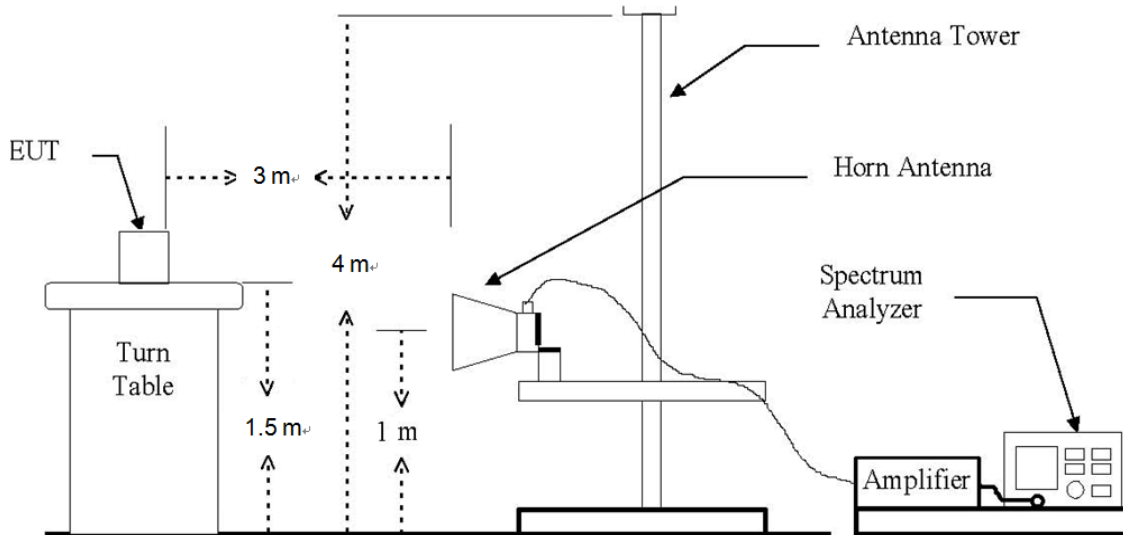

The results shown in this test report refer only to the sample(s) tested unless otherwise stated. This test report cannot be reproduced, except in full, without prior written permission of the Company. This test report does not assure KOLAS accreditation.

2.1.2. Conducted Spurious Emissions

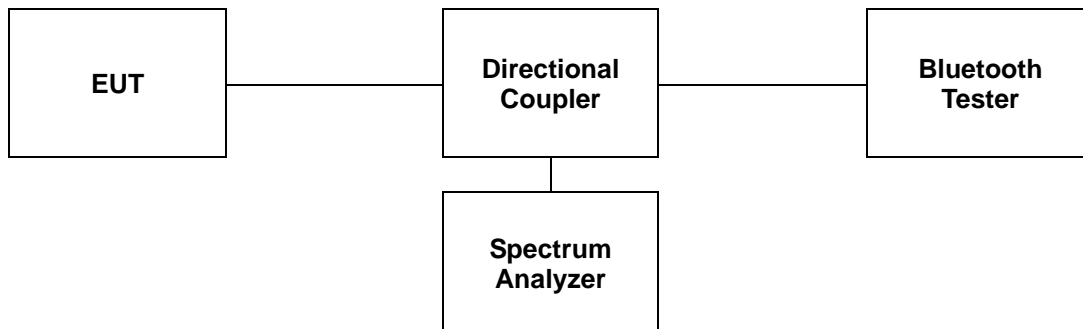

2.2. Limit

According to §15.247(d), in any 100 kHz bandwidth outside the frequency band in which the spread spectrum or digitally modulated intentional radiator is operating, the radio frequency power that is produced by the intentional radiator shall be at least 20 dB below that in the 100 kHz bandwidth within the band that contains the highest level of the desired power, based on either an RF conducted or a radiated measurement, provided the transmitter demonstrates compliance with the peak conducted power limits. If the transmitter complies with the conducted power limits based on the use of RMS averaging over a time interval, as permitted under paragraph(b)(3) of this section, the attenuation required under this paragraph shall be 30 dB instead of 20 dB. Attenuation below the general limits specified in section §15.209(a) is not required. In addition, radiated emission which fall in the restricted bands, as defined in section §15.205(a), must also comply with the radiated emission limits specified in section §15.209(a) (see §15.205(c)).

According to §15.209(a), except as provided elsewhere in this subpart, the emissions from an intentional radiator shall not exceed the field strength levels specified in the following table:

Frequency (MHz)	Field Strength (microvolts / meter)	Measurement distance (meters)
0.009-0.490	2 400/F(kHz)	300
0.490-1.705	24 000/F(kHz)	30
1.705-30.0	30	30
30-88	100**	3
88-216	150**	3
216-960	200**	3
Above 960	500	3

The results shown in this test report refer only to the sample(s) tested unless otherwise stated. This test report cannot be reproduced, except in full, without prior written permission of the Company. This test report does not assure KOLAS accreditation.

** Except as provided in paragraph (g), fundamental emissions from intentional radiators operating under this section shall not be located in the frequency bands 54-72 MHz, 76-88 MHz, 174-216 MHz or 470-806 MHz. However, operation within these frequency bands is permitted under other sections of this part, e.g., §§15.231 and 15.241.

2.3. Test Procedures

Radiated emissions from the EUT were measured according to the dictates of ANSI C63.10-2013.

2.3.1. Test Procedures for emission below 30 MHz

1. The EUT was placed on the top of a rotating table 0.8 meters above the ground at a 3 meter anechoic chamber test site. The table was rotated 360 degrees to determine the position of the highest radiation.
2. Then antenna is a loop antenna is fixed at one meter above the ground to determine the maximum value of the field strength. Both parallel and perpendicular of the antenna are set to make the measurement.
3. For each suspected emission, the EUT was arranged to its worst case and then the table was turned from 0 degrees to 360 degrees to find the maximum reading.
4. The test-receiver system was set to average or quasi peak detect function and Specified Bandwidth with Maximum Hold Mode.

Note;

Although these tests were performed other than open field test site, adequate comparison measurements were confirmed against 30 meter open field test site. Therefore sufficient tests were made to demonstrate that the alternative site produces results that correlate with the ones of tests made in an open field based on KDB 414788 D01 Radiated Test Site v01.

2.3.2. Test Procedures for emission from above 30 MHz

1. The EUT was placed on the top of a rotating table 0.8 meters above the ground at a 3 meter anechoic chamber test site below 1 GHz and 1.5 meter above the ground at a 3 meter anechoic chamber test site above 1 GHz. The table was rotated 360 degrees to determine the position of the highest radiation.
2. During performing radiated emission below 1 GHz, the EUT was set 3 meters away from the interference receiving antenna, which was mounted on the top of a variable-height antenna tower. During performing radiated emission above 1 GHz, the EUT was set 3 meter away from the interference-receiving antenna.
3. The antenna is a bi-log antenna, a horn antenna and its height is varied from one meter to four meters above the ground to determine the maximum value of the field strength. Both horizontal and vertical polarizations of the antenna are set to make the measurement.
4. For each suspected emission, the EUT was arranged to its worst case and then the antenna was tuned to heights from 1 meter to 4 meters and the table was turned from 0 degrees to 360 degrees to find the maximum reading.
5. The test-receiver system was set to Peak Detect Function and Specified Bandwidth with Maximum Hold Mode.
6. If the emission level of the EUT in peak mode was 10 dB lower than the limit specified, then testing could be stopped and the peak values of the EUT would be reported. Otherwise the emissions that did not have 10 dB margin would be re-tested one by one using peak, quasi-peak or average method as specified and then reported in a data sheet.

The results shown in this test report refer only to the sample(s) tested unless otherwise stated. This test report cannot be reproduced, except in full, without prior written permission of the Company. This test report does not assure KOLAS accreditation.

Note;

1. The resolution bandwidth and video bandwidth of test receiver/spectrum analyzer is 120 kHz for Peak detection (PK) and Quasi-peak detection (QP) at frequency below 1 GHz.
2. For frequency above 1 GHz, set spectrum analyzer detector to peak, and resolution bandwidth is 1 MHz and video bandwidth is 3 MHz.
3. According to 15.35 (c), as a “duty cycle correction factor”, pulse averaging with $20 \log(\text{worst case dwell time} / 100 \text{ ms})$ has to be used for average result.
4. Definition of DUT Axis.
Definition of the test orthogonal plan for EUT was described in the test setup photo.
The test orthogonal plan of EUT is **X – axis** during radiation test.

2.3.3. Test Procedures for Conducted Spurious Emissions**2.3.3.1. Band-edge Compliance of RF Conducted Emissions**

The transmitter output was connected to the spectrum analyzer.

Span = wide enough to capture the peak level of the emission operating on the channel closest to the band edge, as well as any modulation products which fall outside of the authorized band of operation.

RBW \geq 100 kHz

VBW = 300 kHz

Sweep = auto

Detector function = peak

Trace = max hold

2.3.3.2. Spurious RF Conducted Emissions

The transmitter output was connected to the spectrum analyzer.

RBW = 1 MHz

VBW = 3 MHz

Sweep = auto

Detector function = peak

Trace = max hold

2.3.3.3. TDF function

- For plots showing conducted spurious emissions from 9 kHz to 25 GHz, all path loss of wide frequency range was investigated and compensated to spectrum analyzer as TDF function.

So, the reading values shown in plots were final result.

The results shown in this test report refer only to the sample(s) tested unless otherwise stated. This test report cannot be reproduced, except in full, without prior written permission of the Company. This test report does not assure KOLAS accreditation.

2.4. Test Results

Ambient temperature : (23 ± 1) °C
 Relative humidity : 47 % R.H.

2.4.1. Radiated Spurious Emission below 1 000 MHz

The frequency spectrum from 9 MHz to 1 000 MHz was investigated. All reading values are peak values.

Radiated Emissions			Ant.	Correction Factors		Total	Limit	
Frequency (MHz)	Reading (dB μ V)	Detect Mode	Pol.	AF (dB/m)	AMP + CL (dB)	Actual (dB μ V/m)	Limit (dB μ V/m)	Margin (dB)
213.80	36.00	Peak	V	14.45	-25.59	24.86	43.50	18.64
279.05	34.00	Peak	H	17.49	-25.15	26.34	46.00	19.66
289.26	34.50	Peak	V	18.53	-25.02	28.01	46.00	17.99
339.64	39.80	Peak	V	14.59	-25.10	29.29	46.00	16.71
364.84	39.00	Peak	V	14.90	-25.23	28.67	46.00	17.33
542.20	35.00	Peak	H	19.07	-25.34	28.73	46.00	17.27
648.60	35.90	Peak	V	19.50	-25.30	30.10	46.00	15.90
854.55	34.30	Peak	V	22.39	-24.21	32.48	46.00	13.52
887.97	40.10	Peak	H	22.34	-23.89	38.55	46.00	7.45
Above 900.00	Not detected	-	-	-	-	-	-	-

Remark:

- Spurious emissions for all channels and modes were investigated and almost the same below 1 GHz.
- Reported spurious emissions are in **EDR / 3DH5 / Middle channel** as worst case among other modes.
- Radiated spurious emission measurement as below.
(Actual = Reading + AF + AMP + CL)
- According to §15.31(o), emission levels are not report much lower than the limits by over 20 dB.

The results shown in this test report refer only to the sample(s) tested unless otherwise stated. This test report cannot be reproduced, except in full, without prior written permission of the Company. This test report does not assure KOLAS accreditation.

Test plot

<30 MHz ~ 300 MHz>

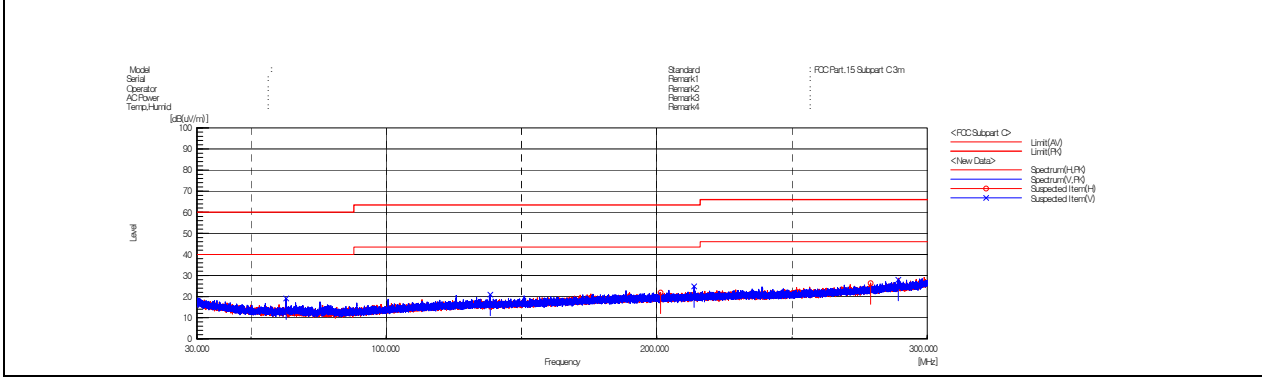

<300 MHz ~ 1 000 MHz>

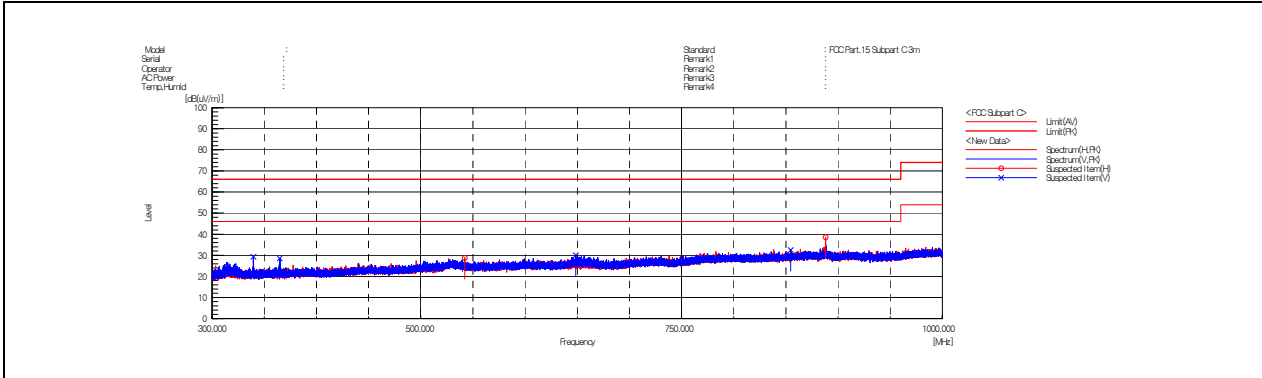

The results shown in this test report refer only to the sample(s) tested unless otherwise stated. This test report cannot be reproduced, except in full, without prior written permission of the Company. This test report does not assure KOLAS accreditation.

2.4.2. Radiated Spurious Emission above 1 000 MHz

The frequency spectrum above 1 000 MHz was investigated. All reading values are peak and average values.

Operating Mode: GFSK (1 Mbps)

A. Low Channel (2 402 MHz)

Radiated Emissions			Ant.	Correction Factors			Total	Limit	
Frequency (MHz)	Reading (dB μ V)	Detect Mode	Pol.	AF (dB/m)	CL (dB)	Duty Factor	Actual (dB μ V/m)	Limit (dB μ V/m)	Margin (dB)
*2 310.00	26.35	Peak	V	28.07	6.92	-	61.34	74.00	12.66
*2 310.00	26.35	Average	V	28.07	6.92	-24.73	36.61	54.00	17.39
*2 388.12	29.03	Peak	V	28.15	6.98	-	64.16	74.00	9.84
*2 388.12	29.03	Average	V	28.15	6.98	-24.73	39.43	54.00	14.57
*2 390.00	25.85	Peak	V	28.15	6.97	-	60.97	74.00	13.03
*2 390.00	25.85	Average	V	28.15	6.97	-24.73	36.24	54.00	17.76

Radiated Emissions			Ant.	Correction Factors			Total	Limit	
Frequency (MHz)	Reading (dB μ V)	Detect Mode	Pol.	AF (dB/m)	AMP+CL (dB)	Duty Factor	Actual (dB μ V/m)	Limit (dB μ V/m)	Margin (dB)
Above 1 000.00	Not detected	-	-	-	-	-	-	-	-

The results shown in this test report refer only to the sample(s) tested unless otherwise stated. This test report cannot be reproduced, except in full, without prior written permission of the Company. This test report does not assure KOLAS accreditation.

B. Middle Channel (2 441 MHz)

Radiated Emissions			Ant.	Correction Factors			Total	Limit	
Frequency (MHz)	Reading (dB μ V)	Detect Mode	Pol.	AF (dB/m)	AMP+CL (dB)	Duty Factor	Actual (dB μ V/m)	Limit (dB μ V/m)	Margin (dB)
Above 1 000.00	Not detected	-	-	-	-	-	-	-	-

C. High Channel (2 480 MHz)

Radiated Emissions			Ant.	Correction Factors			Total	Limit	
Frequency (MHz)	Reading (dB μ V)	Detect Mode	Pol.	AF (dB/m)	CL (dB)	Duty Factor	Actual (dB μ V/m)	Limit (dB μ V/m)	Margin (dB)
*2 483.50	27.40	Peak	V	28.24	7.27	-	62.91	74.00	11.09
*2 483.50	27.40	Average	V	28.24	7.27	-24.73	38.18	54.00	15.82
*2 491.70	28.25	Peak	V	28.25	7.23	-	63.73	74.00	10.27
*2 491.70	28.25	Average	V	28.25	7.23	-24.73	39.00	54.00	15.00
*2 500.00	26.02	Peak	V	28.26	7.19	-	61.47	74.00	12.53
*2 500.00	26.02	Average	V	28.26	7.19	-24.73	36.74	54.00	17.26

Radiated Emissions			Ant.	Correction Factors			Total	Limit	
Frequency (MHz)	Reading (dB μ V)	Detect Mode	Pol.	AF (dB/m)	AMP+CL (dB)	Duty Factor	Actual (dB μ V/m)	Limit (dB μ V/m)	Margin (dB)
Above 1 000.00	Not detected	-	-	-	-	-	-	-	-

The results shown in this test report refer only to the sample(s) tested unless otherwise stated. This test report cannot be reproduced, except in full, without prior written permission of the Company. This test report does not assure KOLAS accreditation.

Operating Mode: 8DPSK (3 Mbps)

A. Low Channel (2 402 MHz)

Radiated Emissions			Ant.	Correction Factors			Total	Limit	
Frequency (MHz)	Reading (dB μ V)	Detect Mode	Pol.	AF (dB/m)	CL (dB)	Duty Factor	Actual (dB μ V/m)	Limit (dB μ V/m)	Margin (dB)
*2 310.00	25.42	Peak	V	28.07	6.92	-	60.41	74.00	13.59
*2 310.00	25.42	Average	V	28.07	6.92	-24.73	35.68	54.00	18.32
*2 366.00	27.93	Peak	V	28.12	6.99	-	63.04	74.00	10.96
*2 366.00	27.93	Average	V	28.12	6.99	-24.73	38.31	54.00	15.69
*2 390.00	25.87	Peak	V	28.15	6.97	-	60.99	74.00	13.01
*2 390.00	25.87	Average	V	28.15	6.97	-24.73	36.26	54.00	17.74

Radiated Emissions			Ant.	Correction Factors			Total	Limit	
Frequency (MHz)	Reading (dB μ V)	Detect Mode	Pol.	AF (dB/m)	AMP+CL (dB)	Duty Factor	Actual (dB μ V/m)	Limit (dB μ V/m)	Margin (dB)
Above 1 000.00	Not detected	-	-	-	-	-	-	-	-

The results shown in this test report refer only to the sample(s) tested unless otherwise stated. This test report cannot be reproduced, except in full, without prior written permission of the Company. This test report does not assure KOLAS accreditation.

B. Middle Channel (2 441 MHz)

Radiated Emissions			Ant.	Correction Factors			Total	Limit	
Frequency (MHz)	Reading (dB μ V)	Detect Mode	Pol.	AF (dB/m)	AMP+CL (dB)	Duty Factor	Actual (dB μ V/m)	Limit (dB μ V/m)	Margin (dB)
Above 1 000.00	Not detected	-	-	-	-	-	-	-	-

C. High Channel (2 480 MHz)

Radiated Emissions			Ant.	Correction Factors			Total	Limit	
Frequency (MHz)	Reading (dB μ V)	Detect Mode	Pol.	AF (dB/m)	CL (dB)	Duty Factor	Actual (dB μ V/m)	Limit (dB μ V/m)	Margin (dB)
*2 483.50	27.15	Peak	V	28.24	7.27	-	62.66	74.00	11.34
*2 483.50	27.15	Average	V	28.24	7.27	-24.73	37.93	54.00	16.07
*2 492.45	28.43	Peak	V	28.25	7.23	-	63.91	74.00	10.09
*2 492.45	28.43	Average	V	28.25	7.23	-24.73	39.18	54.00	14.82
*2 500.00	26.02	Peak	V	28.26	7.19	-	61.47	74.00	12.53
*2 500.00	26.02	Average	V	28.26	7.19	-24.73	36.74	54.00	17.26

Radiated Emissions			Ant.	Correction Factors			Total	Limit	
Frequency (MHz)	Reading (dB μ V)	Detect Mode	Pol.	AF (dB/m)	AMP+CL (dB)	Duty Factor	Actual (dB μ V/m)	Limit (dB μ V/m)	Margin (dB)
Above 1 000.00	Not detected	-	-	-	-	-	-	-	-

Remark:

1. "*" means the restricted band.
2. Measuring frequencies from 1 GHz to the 10th harmonic of highest fundamental frequency.
3. Radiated emissions measured in frequency above 1 000 MHz were made with an instrument using peak/average detector mode.
4. Actual = Reading + AF + AMP + CL+ (Duty Factor) or Reading + AF + CL+ (Duty Factor).
5. According to §15.31(o), emission levels are not reported much lower than the limits by over 20 dB.

The results shown in this test report refer only to the sample(s) tested unless otherwise stated. This test report cannot be reproduced, except in full, without prior written permission of the Company. This test report does not assure KOLAS accreditation.

2.4.3. Plots of Transmitter Radiated Spurious Emissions

Operating Mode: GFSK (1 Mbps)

Low Channel Band edge (Peak)

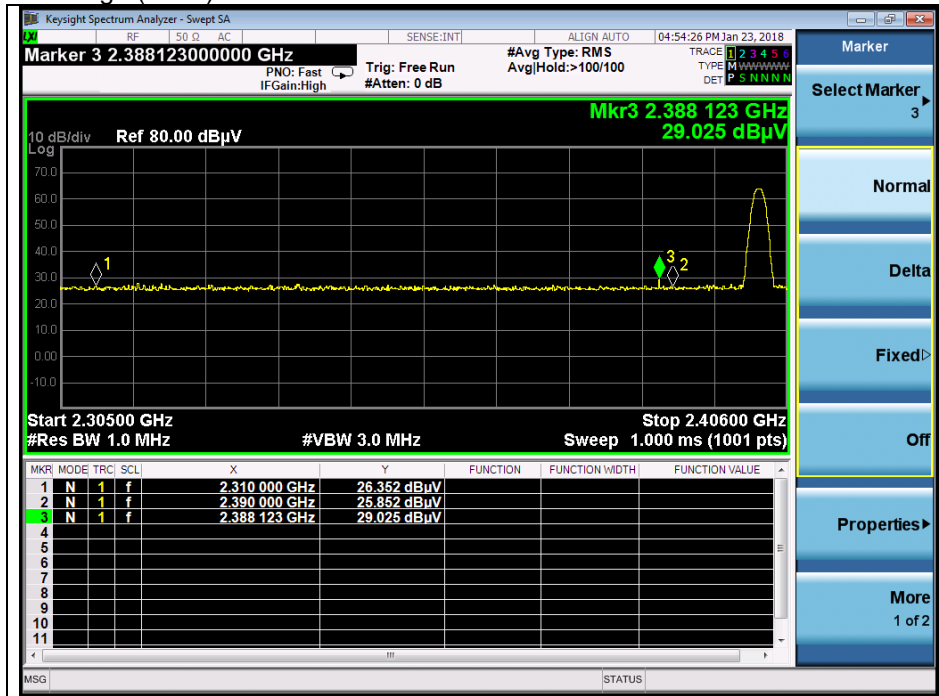

High Channel Band edge (Peak)

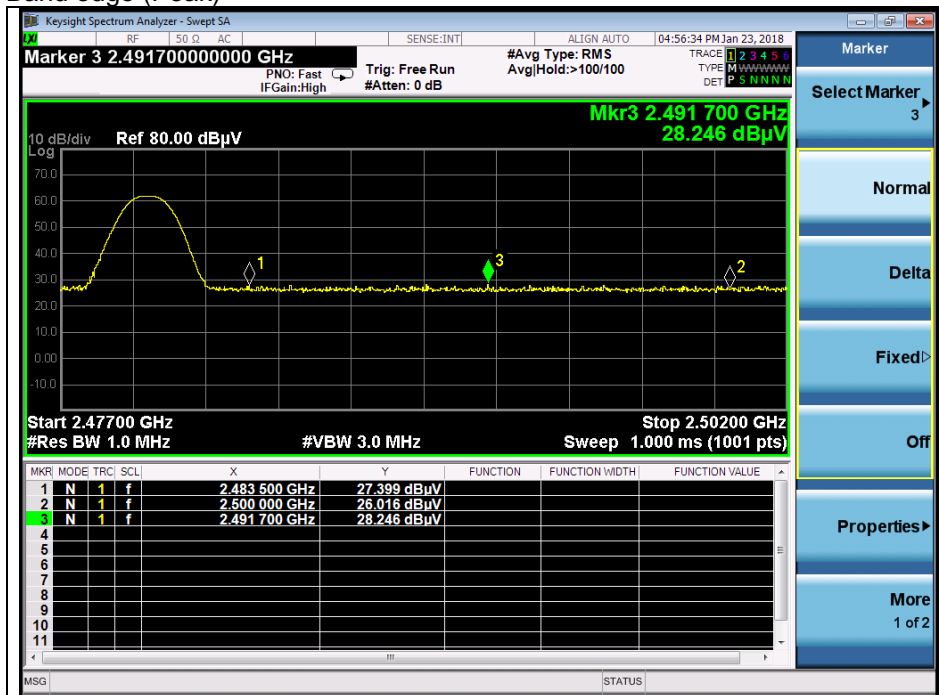

The results shown in this test report refer only to the sample(s) tested unless otherwise stated. This test report cannot be reproduced, except in full, without prior written permission of the Company. This test report does not assure KOLAS accreditation.

Operating Mode: 8DPSK (3 Mbps)

Low Channel Band edge (Peak)

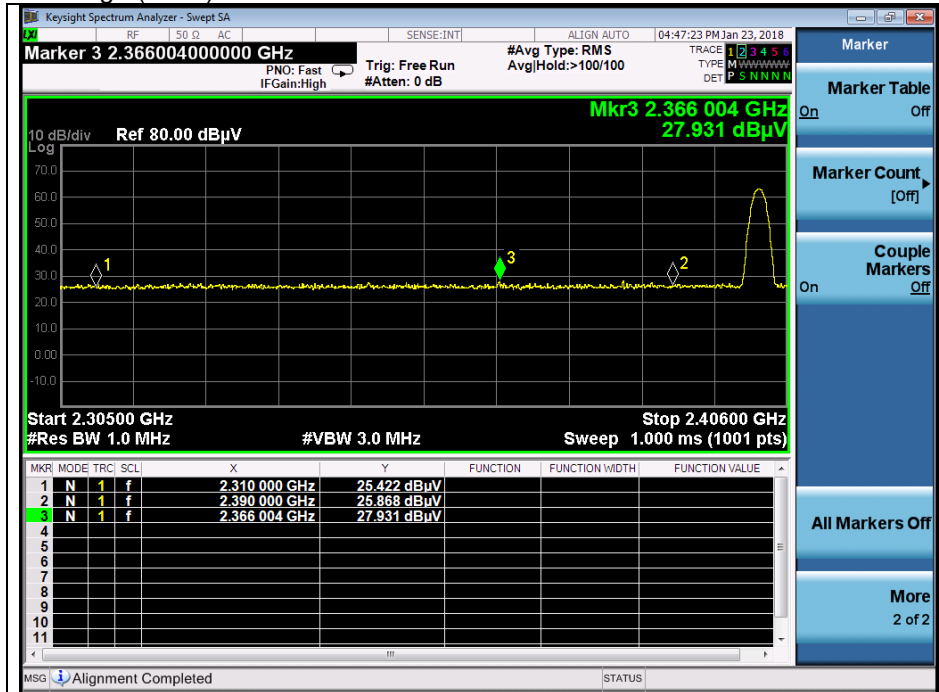

High Channel Band edge (Peak)



The results shown in this test report refer only to the sample(s) tested unless otherwise stated. This test report cannot be reproduced, except in full, without prior written permission of the Company. This test report does not assure KOLAS accreditation.

2.4.4. Spurious RF Conducted Emissions: Plot of Spurious RF Conducted Emission

Operating Mode: GFSK (1 Mbps)

Low Channel

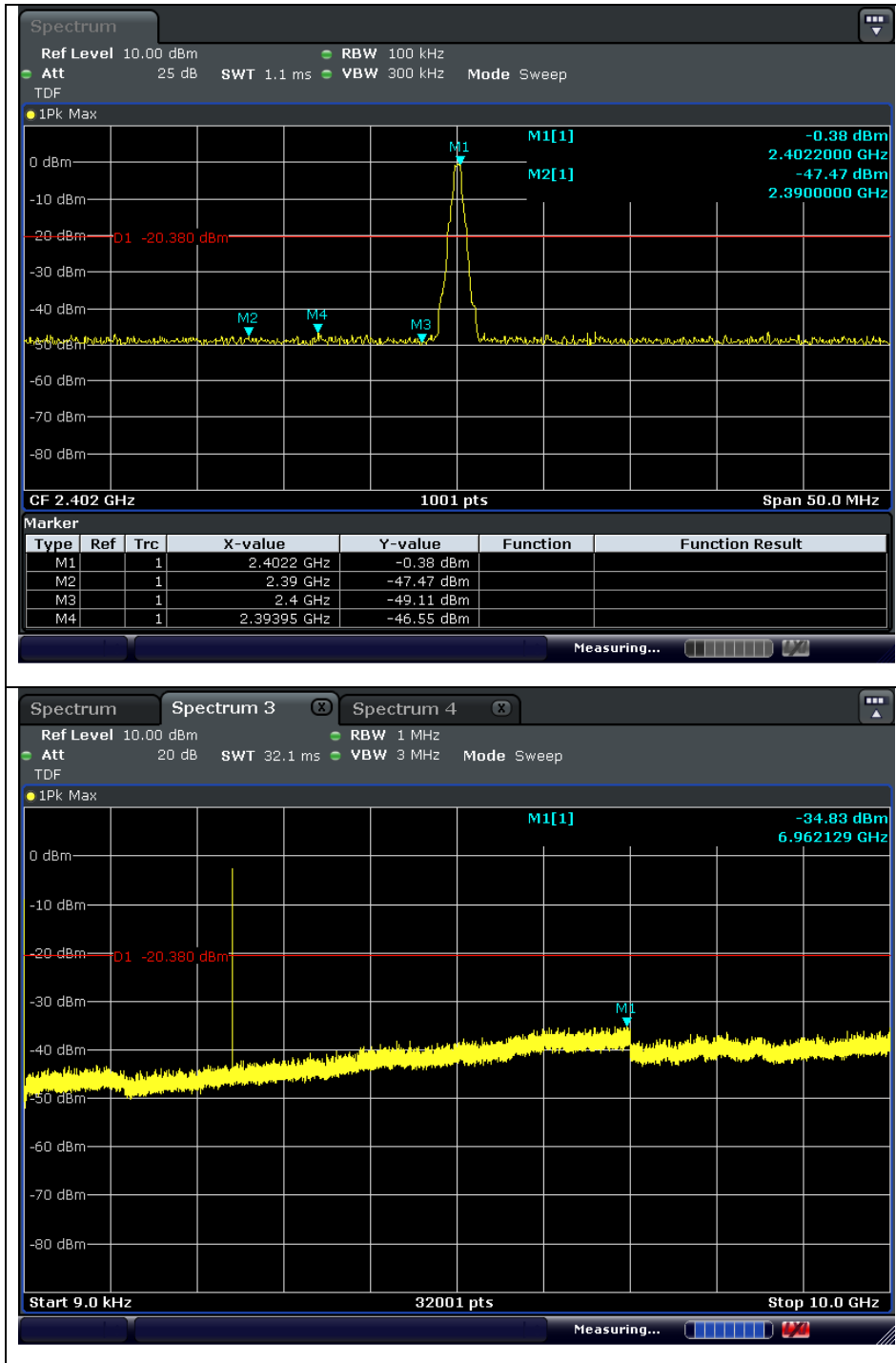

The results shown in this test report refer only to the sample(s) tested unless otherwise stated. This test report cannot be reproduced, except in full, without prior written permission of the Company. This test report does not assure KOLAS accreditation.

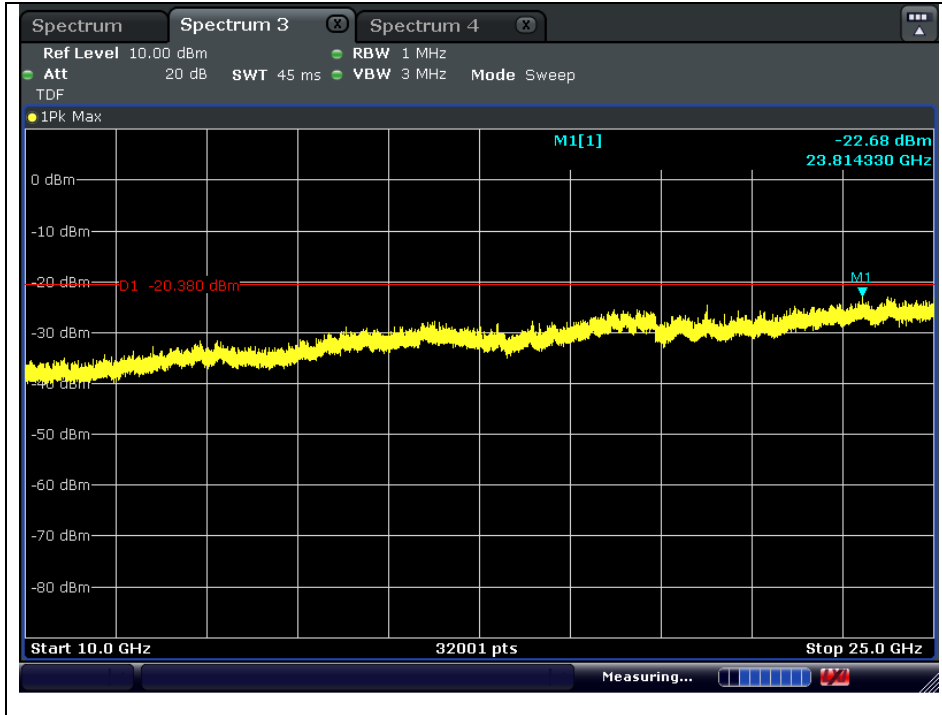

The results shown in this test report refer only to the sample(s) tested unless otherwise stated. This test report cannot be reproduced, except in full, without prior written permission of the Company. This test report does not assure KOLAS accreditation.

Middle Channel

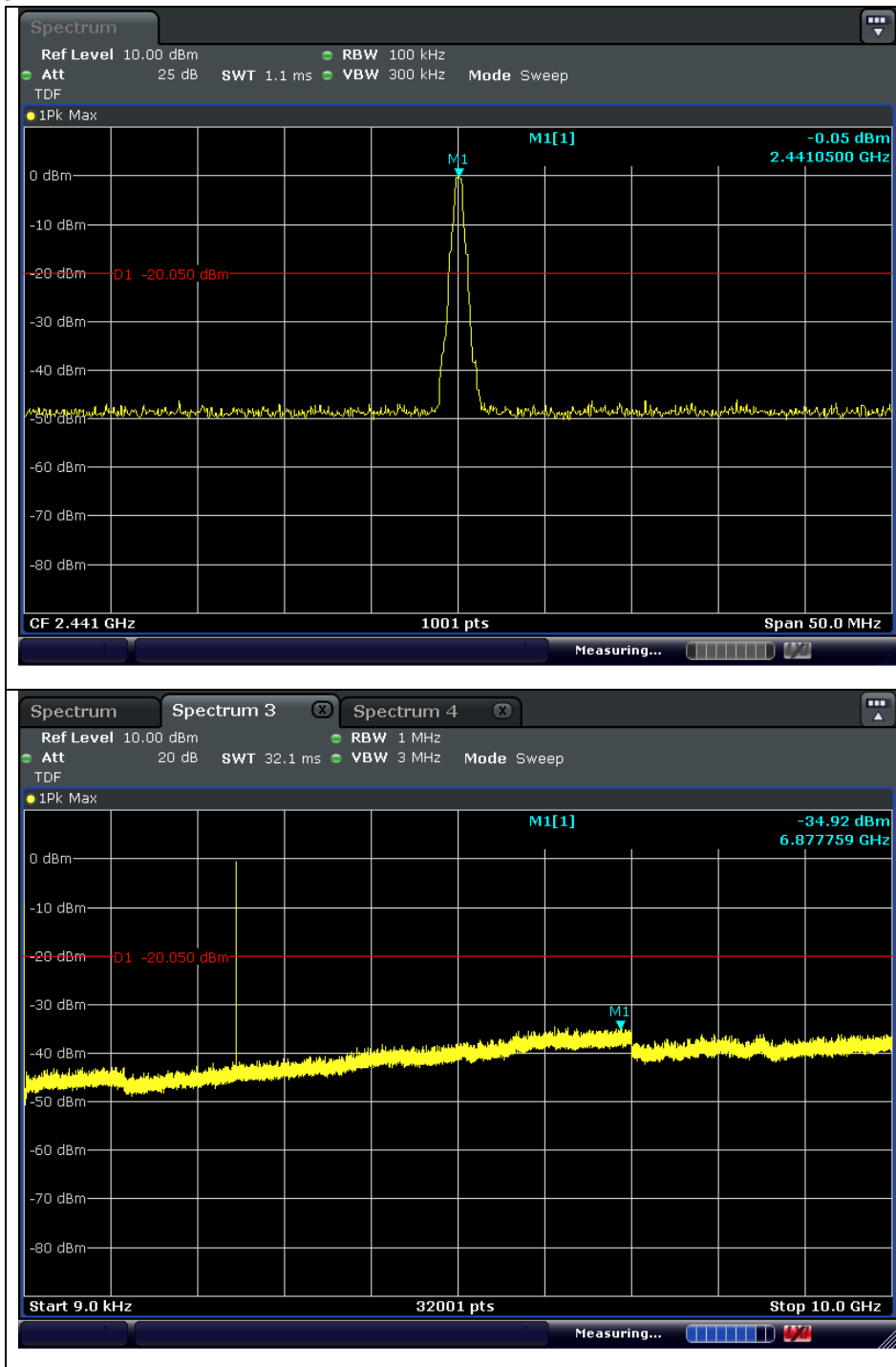

The results shown in this test report refer only to the sample(s) tested unless otherwise stated. This test report cannot be reproduced, except in full, without prior written permission of the Company. This test report does not assure KOLAS accreditation.

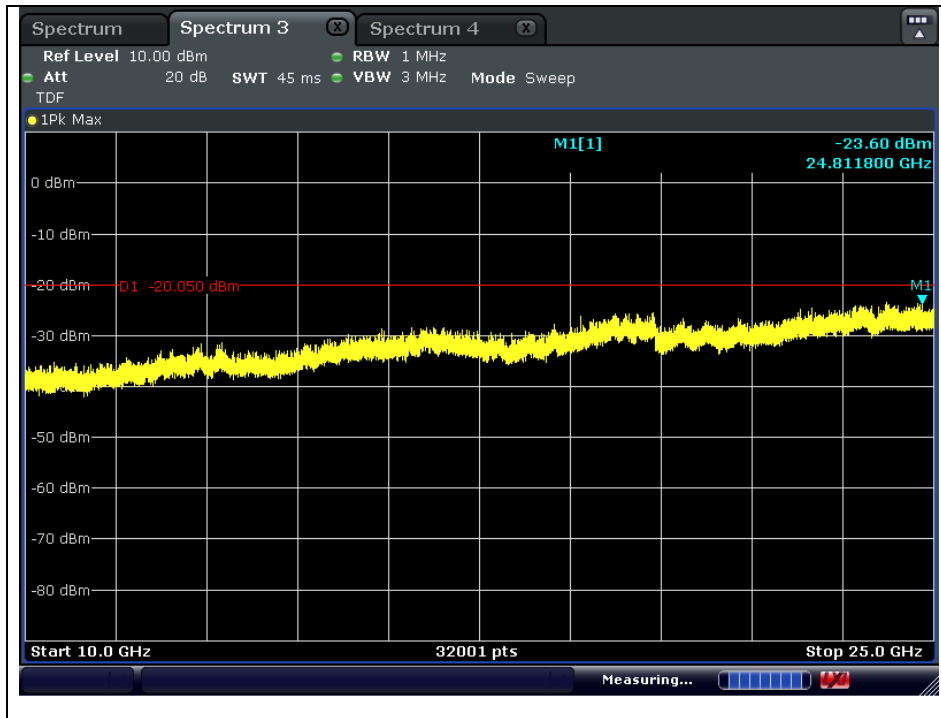

The results shown in this test report refer only to the sample(s) tested unless otherwise stated. This test report cannot be reproduced, except in full, without prior written permission of the Company. This test report does not assure KOLAS accreditation.

High Channel

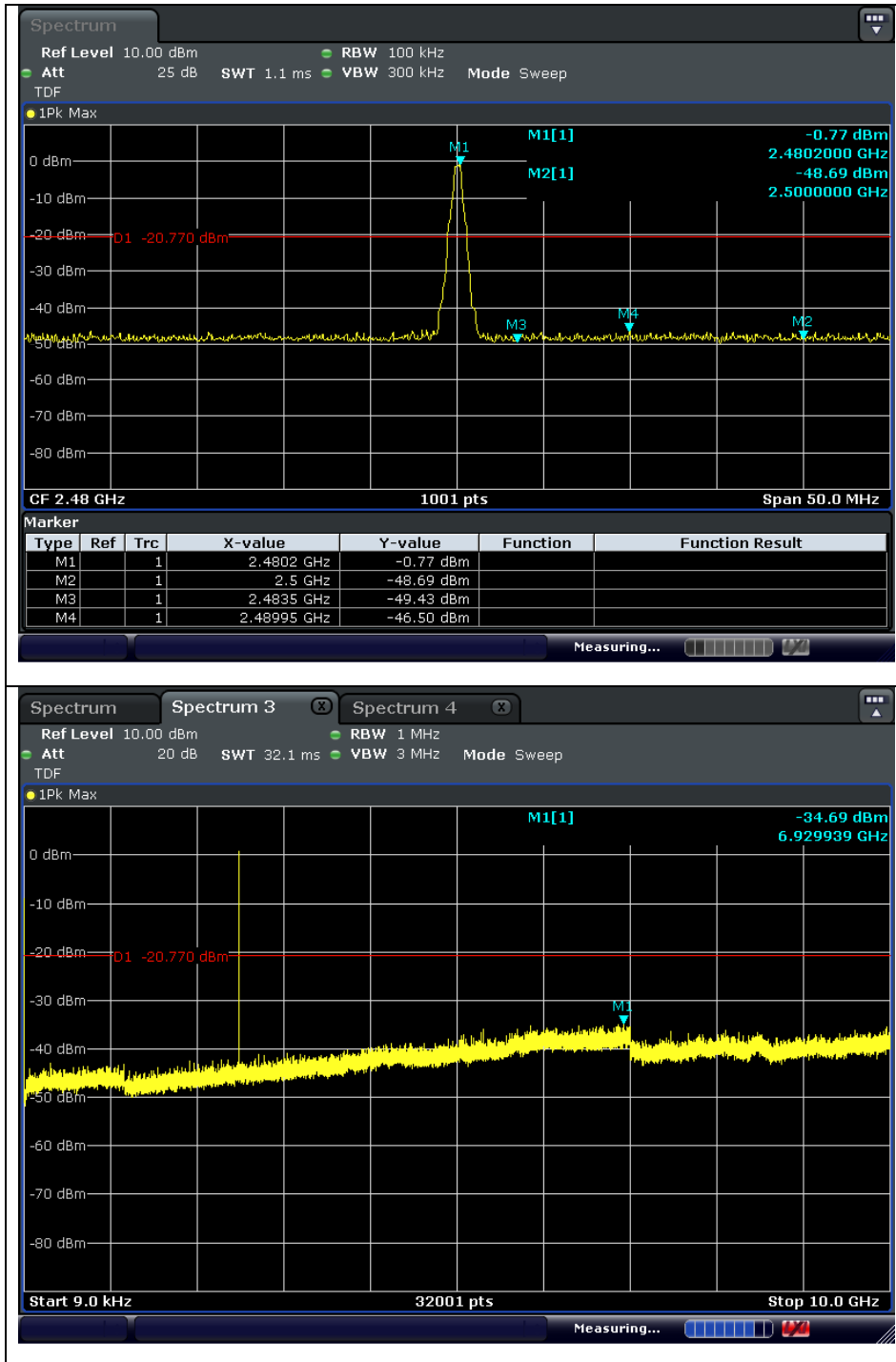

The results shown in this test report refer only to the sample(s) tested unless otherwise stated. This test report cannot be reproduced, except in full, without prior written permission of the Company. This test report does not assure KOLAS accreditation.

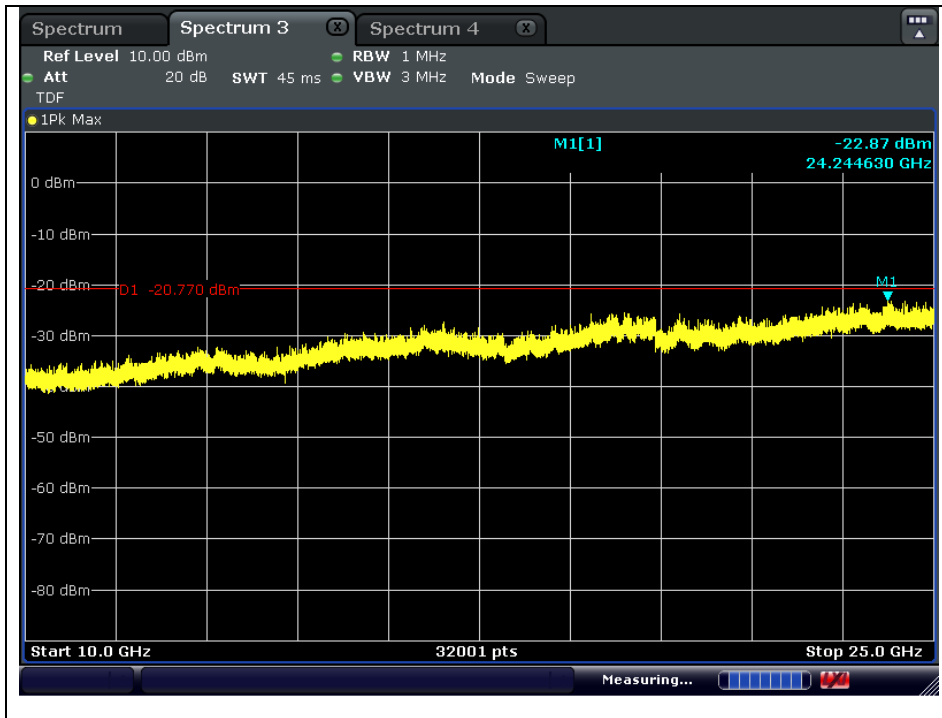

The results shown in this test report refer only to the sample(s) tested unless otherwise stated. This test report cannot be reproduced, except in full, without prior written permission of the Company. This test report does not assure KOLAS accreditation.

Band edge Compliance with Hopping Enabled

Low channel

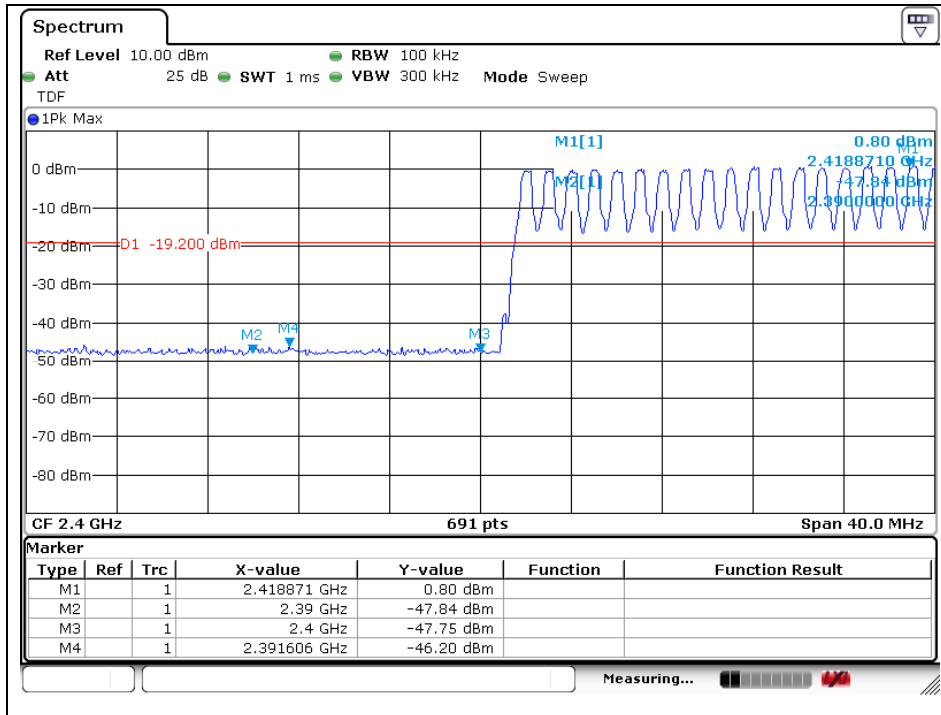

High channel

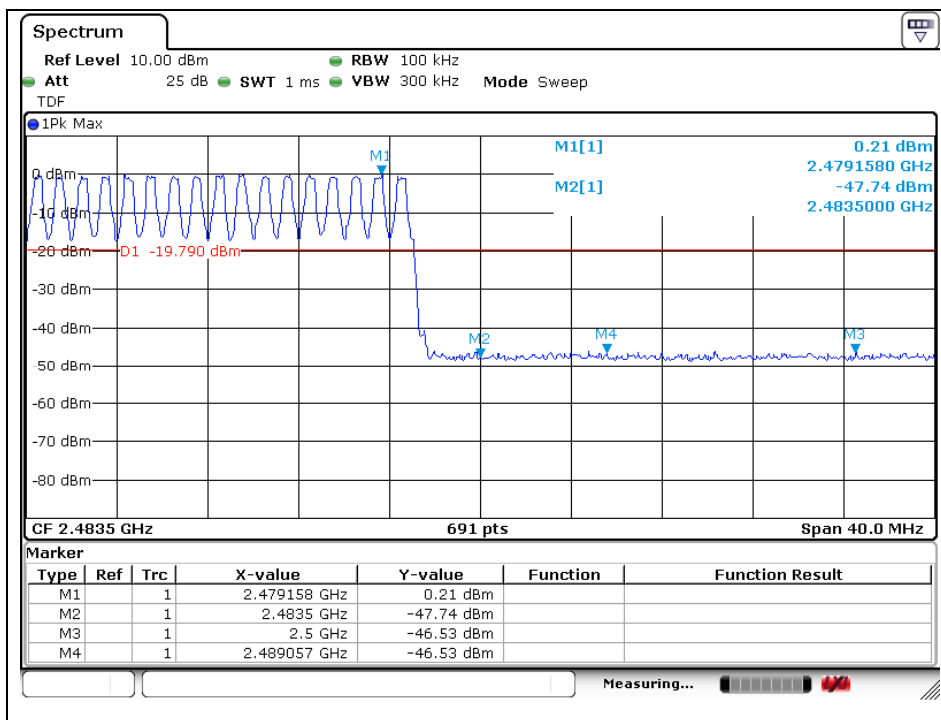

The results shown in this test report refer only to the sample(s) tested unless otherwise stated. This test report cannot be reproduced, except in full, without prior written permission of the Company. This test report does not assure KOLAS accreditation.

Operating Mode: 8DPSK (3 Mbps)

Low Channel

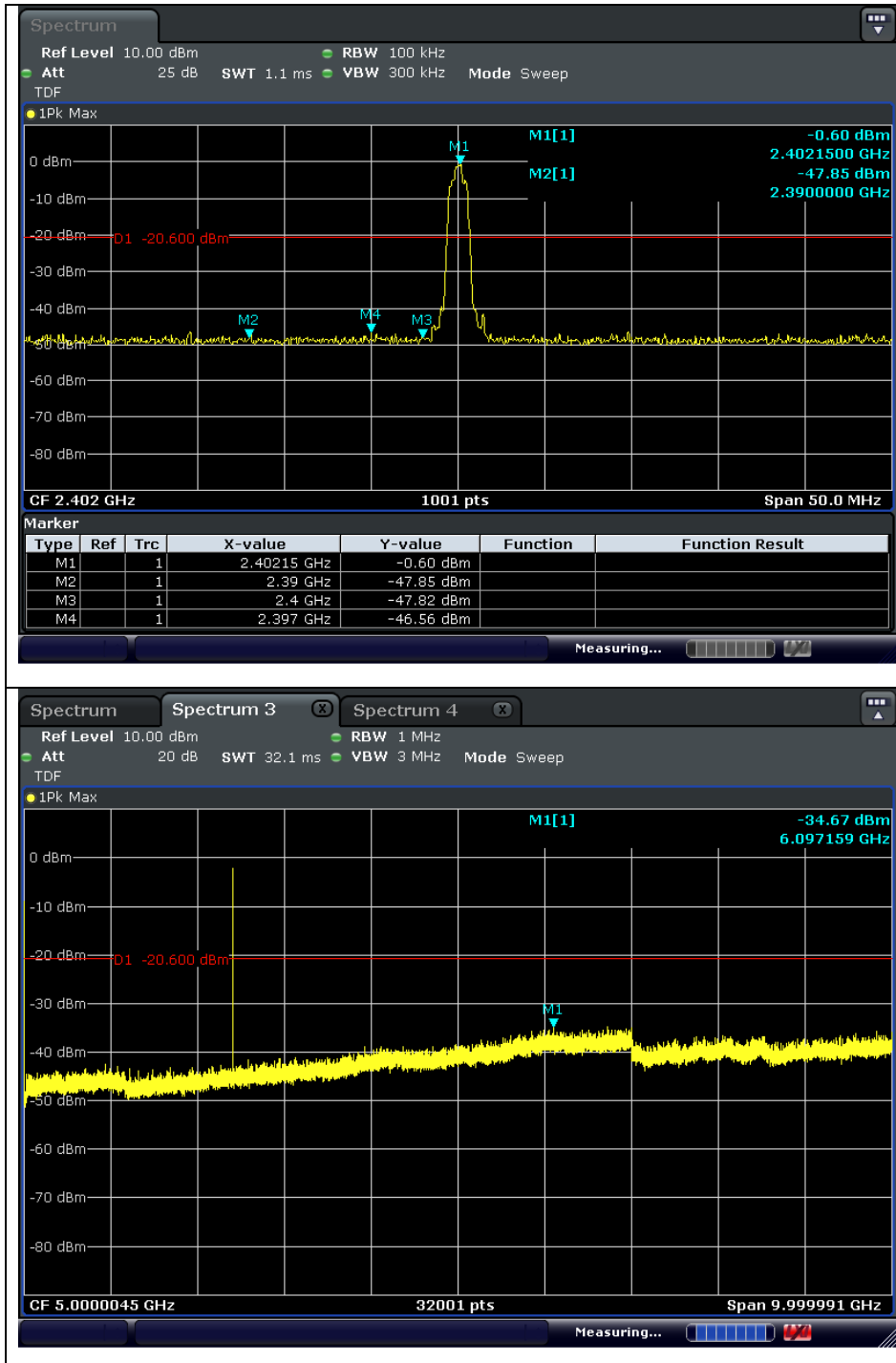

The results shown in this test report refer only to the sample(s) tested unless otherwise stated. This test report cannot be reproduced, except in full, without prior written permission of the Company. This test report does not assure KOLAS accreditation.

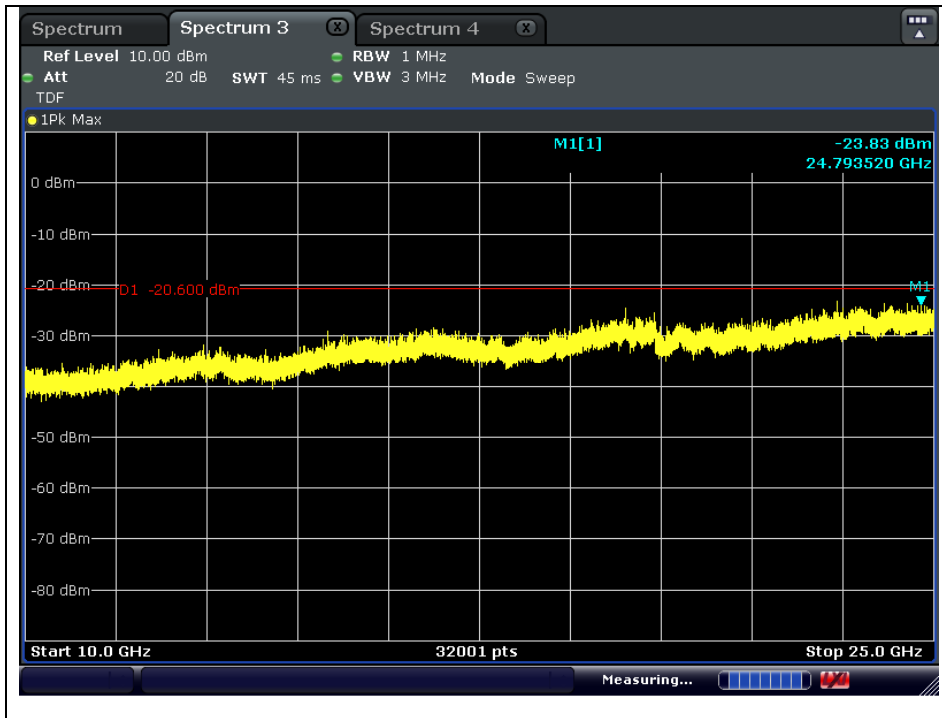

The results shown in this test report refer only to the sample(s) tested unless otherwise stated. This test report cannot be reproduced, except in full, without prior written permission of the Company. This test report does not assure KOLAS accreditation.

Middle Channel

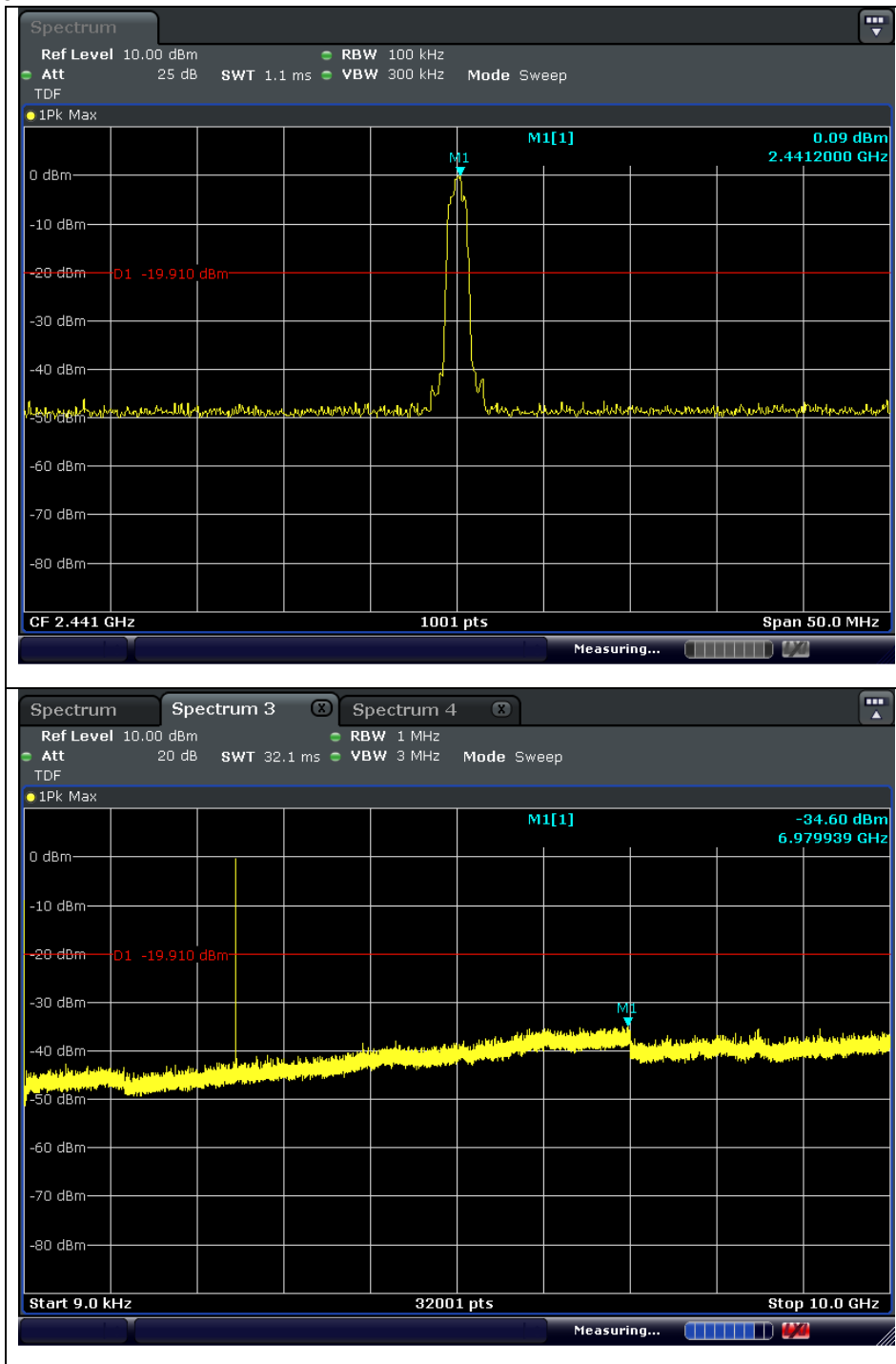

The results shown in this test report refer only to the sample(s) tested unless otherwise stated. This test report cannot be reproduced, except in full, without prior written permission of the Company. This test report does not assure KOLAS accreditation.

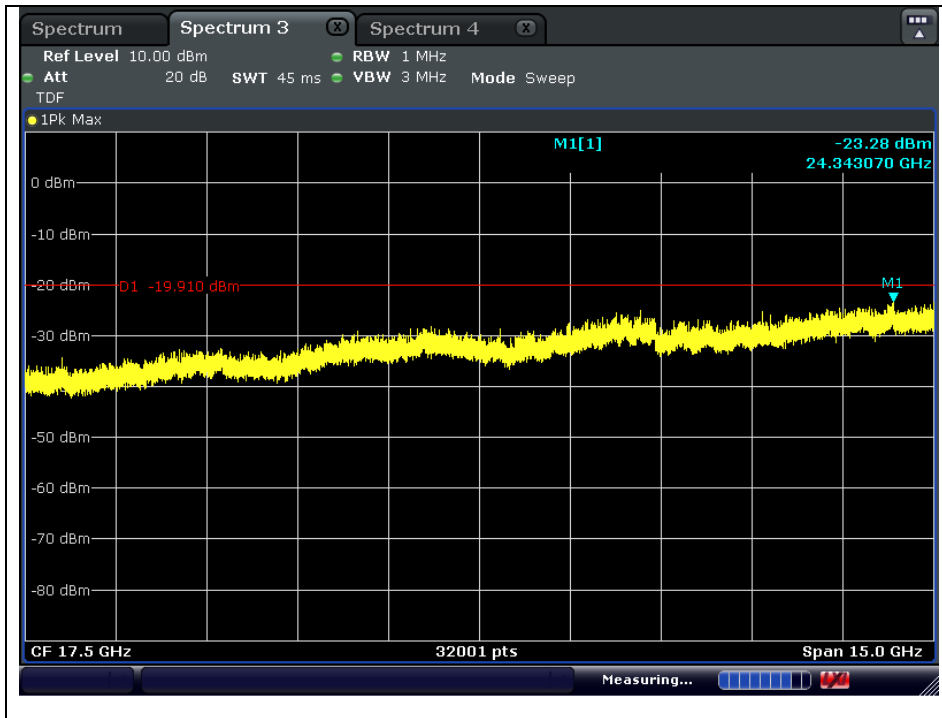

The results shown in this test report refer only to the sample(s) tested unless otherwise stated. This test report cannot be reproduced, except in full, without prior written permission of the Company. This test report does not assure KOLAS accreditation.

High Channel

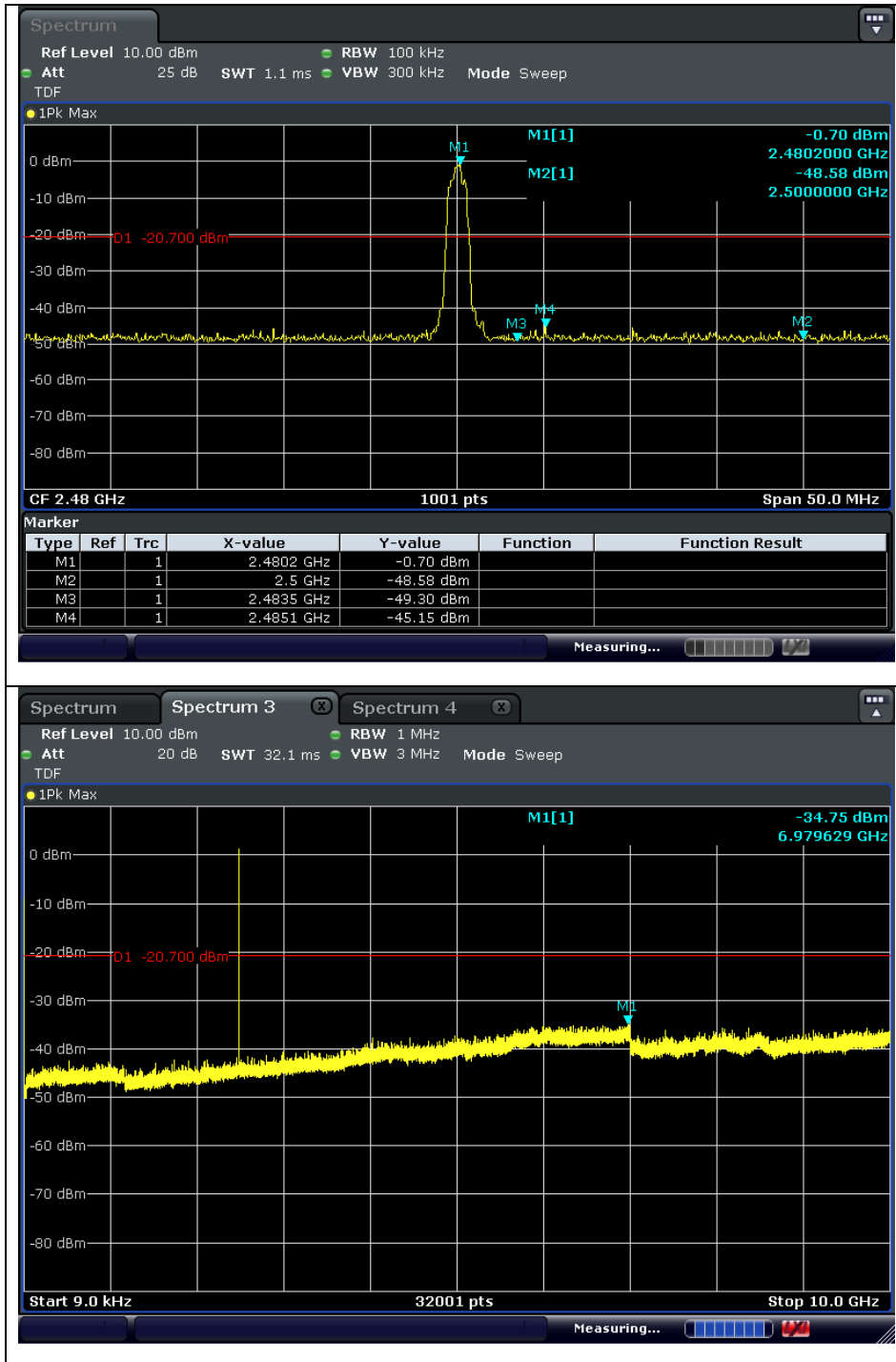

The results shown in this test report refer only to the sample(s) tested unless otherwise stated. This test report cannot be reproduced, except in full, without prior written permission of the Company. This test report does not assure KOLAS accreditation.

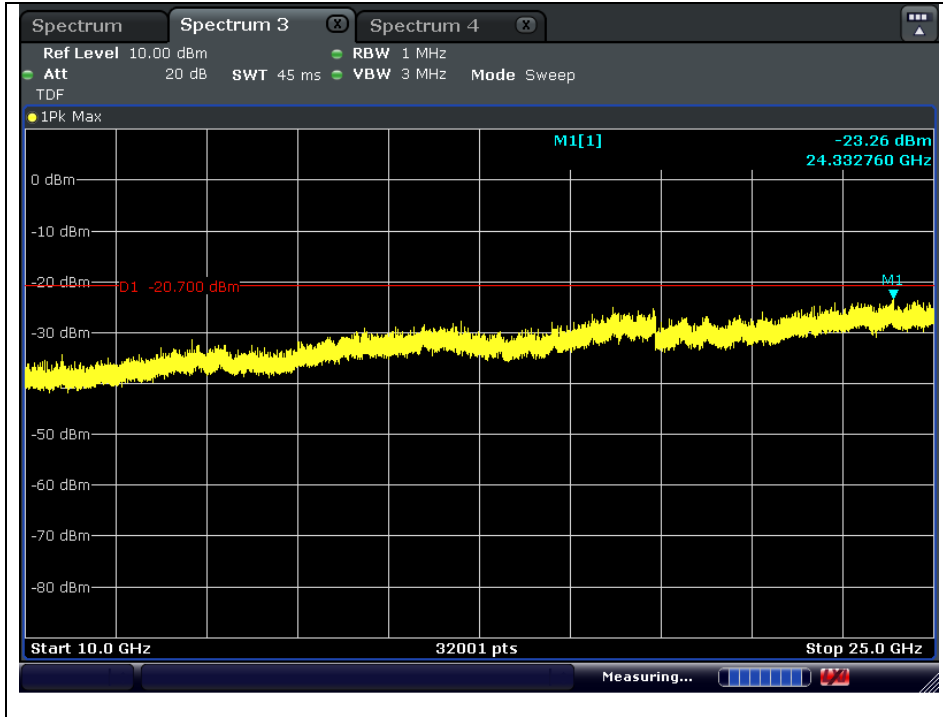

The results shown in this test report refer only to the sample(s) tested unless otherwise stated. This test report cannot be reproduced, except in full, without prior written permission of the Company. This test report does not assure KOLAS accreditation.

Band edge Compliance with Hopping Enabled

Low channel

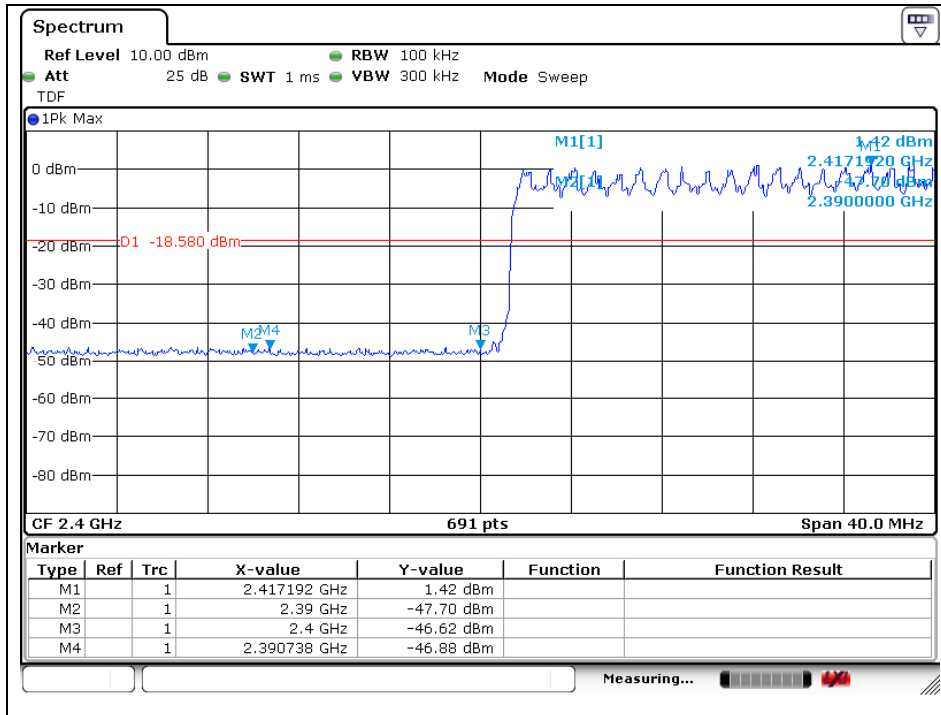

High channel

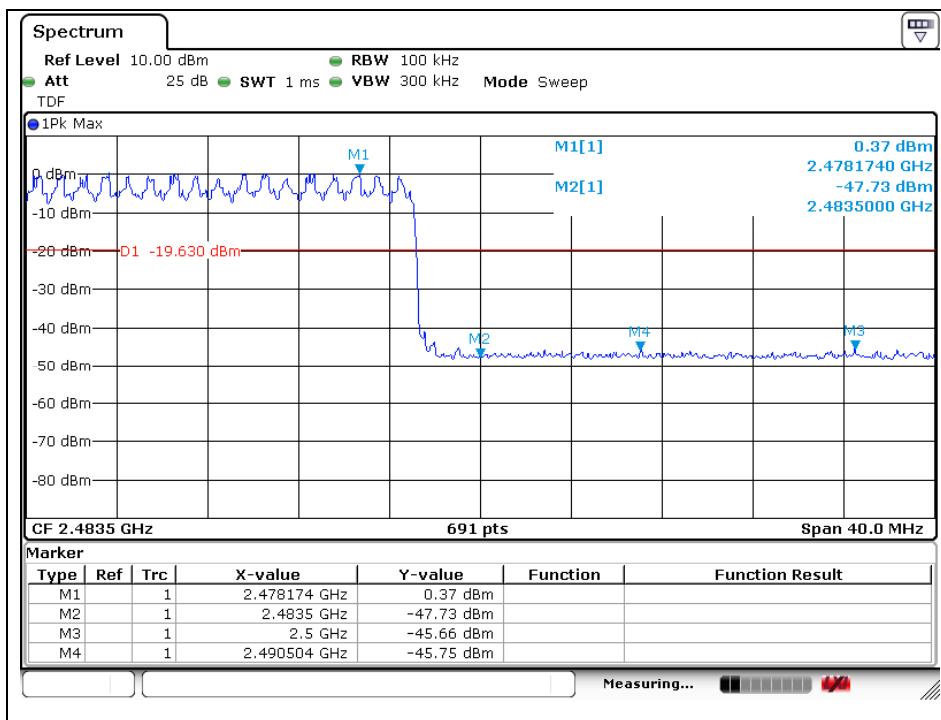

The results shown in this test report refer only to the sample(s) tested unless otherwise stated. This test report cannot be reproduced, except in full, without prior written permission of the Company. This test report does not assure KOLAS accreditation.

3. 20 dB Bandwidth

3.1. Test Setup

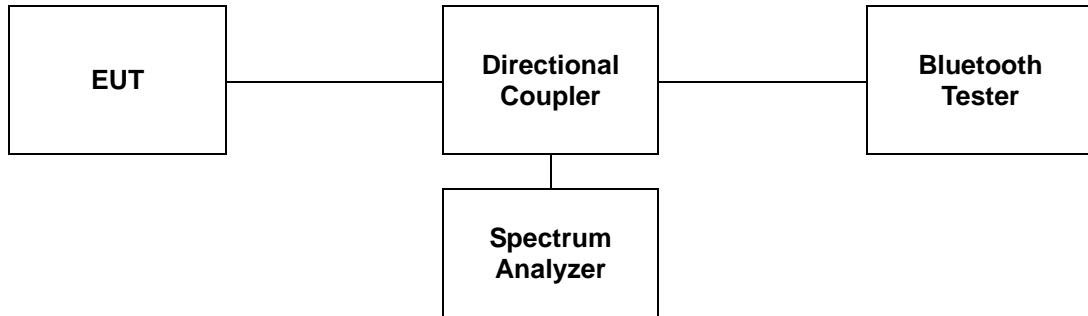

3.2. Limit

Limit: Not Applicable

3.3. Test Procedure

The test follows ANSI C63.10-2013.

The 20 dB bandwidth was measured with a spectrum analyzer connected to RF antenna connector (conducted measurement) while EUT was operating in transmit mode at the appropriate center frequency.

Use the following spectrum analyzer setting:

Span = approximately 2 to 3 times the 20 dB bandwidth, centered on a hopping channel

RBW \geq 1 % of the 20 dB bandwidth

VBW \geq RBW

Sweep = auto

Detector function = peak

Trace = max hold

Use the marker-to-peak function to set the mark to the peak of the emission. Use the marker-delta function to measure 20 dB down one side of the emission. Reset the marker-delta function, and move the marker to the other side of the emission, until it is (as close as possible to) even with the reference marker level. The marker-delta reading at this point is the 20 dB bandwidth of the emission.

The results shown in this test report refer only to the sample(s) tested unless otherwise stated. This test report cannot be reproduced, except in full, without prior written permission of the Company. This test report does not assure KOLAS accreditation.

3.4. Test Results

Ambient temperature : (23 ± 1) °C
 Relative humidity : 47 % R.H.

Operation Mode	Data Rate	Channel	Frequency (MHz)	20 dB Bandwidth (MHz)
GFSK	1 Mbps	Low	2 402	1.047
		Middle	2 441	1.047
		High	2 480	1.038
π/4DQPSK	2 Mbps	Low	2 402	1.290
		Middle	2 441	1.290
		High	2 480	1.290
8DPSK	3 Mbps	Low	2 402	1.293
		Middle	2 441	1.287
		High	2 480	1.290

Operating Mode: GFSK

Low Channel

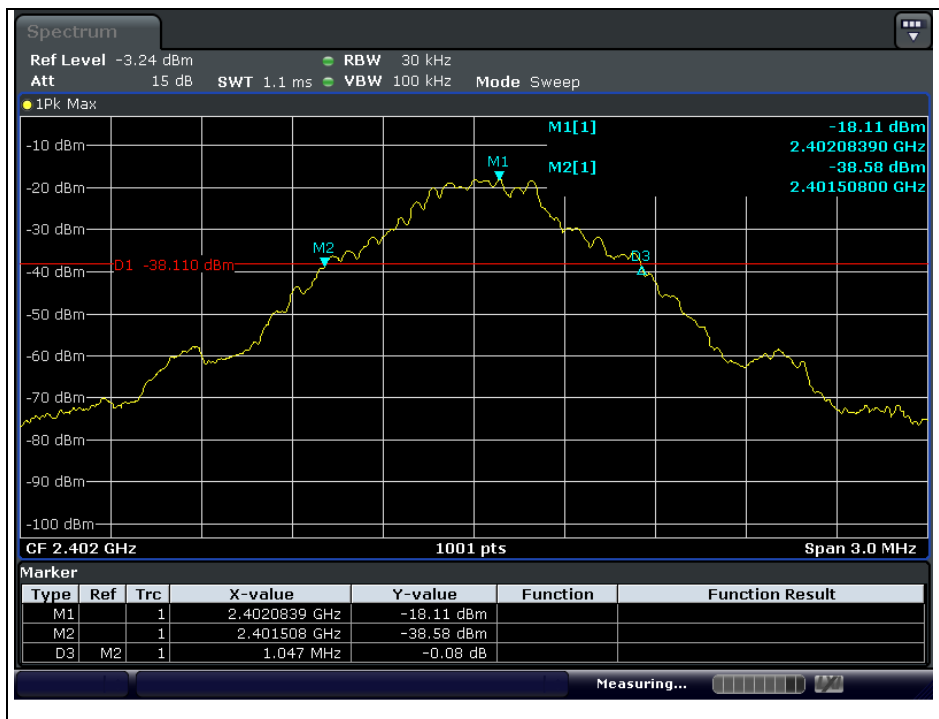

The results shown in this test report refer only to the sample(s) tested unless otherwise stated. This test report cannot be reproduced, except in full, without prior written permission of the Company. This test report does not assure KOLAS accreditation.

Middle Channel

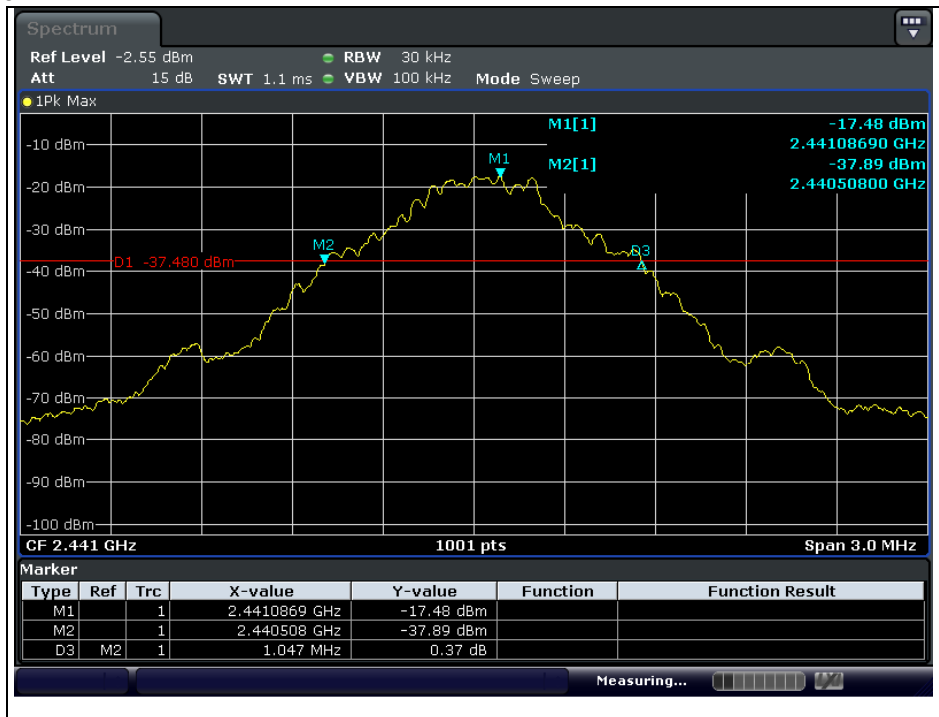

High Channel

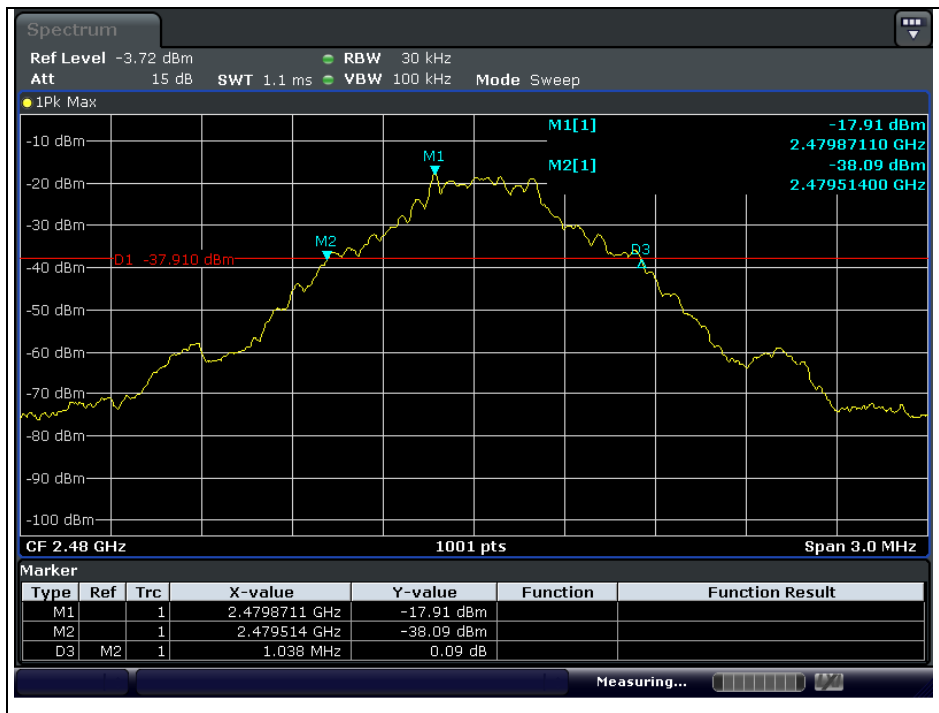

The results shown in this test report refer only to the sample(s) tested unless otherwise stated. This test report cannot be reproduced, except in full, without prior written permission of the Company. This test report does not assure KOLAS accreditation.

Operating Mode: $\pi/4$ DQPSK

Low Channel

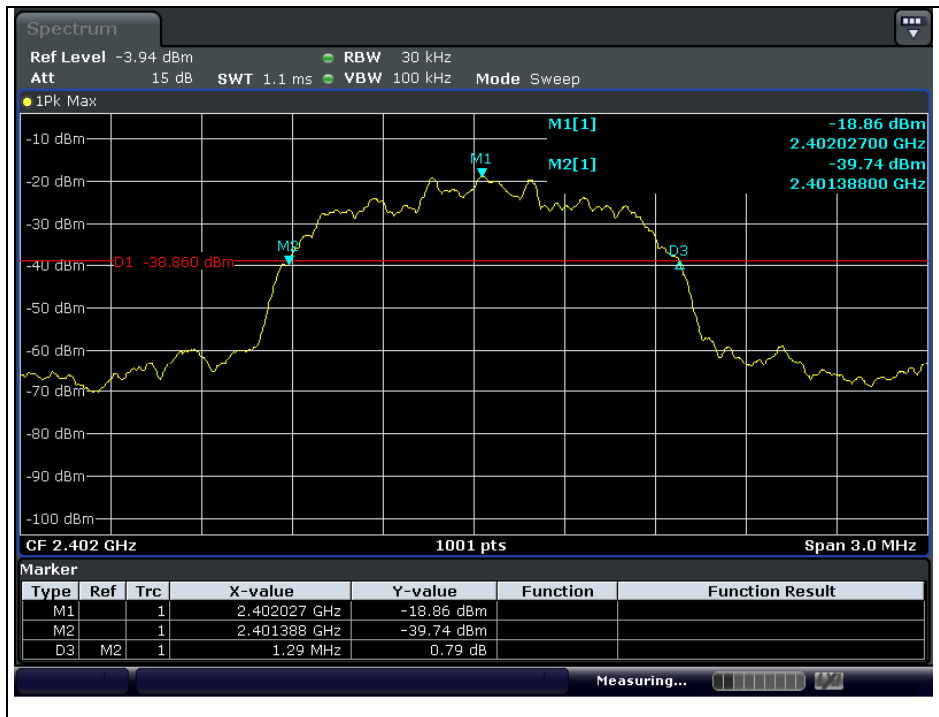

Middle Channel

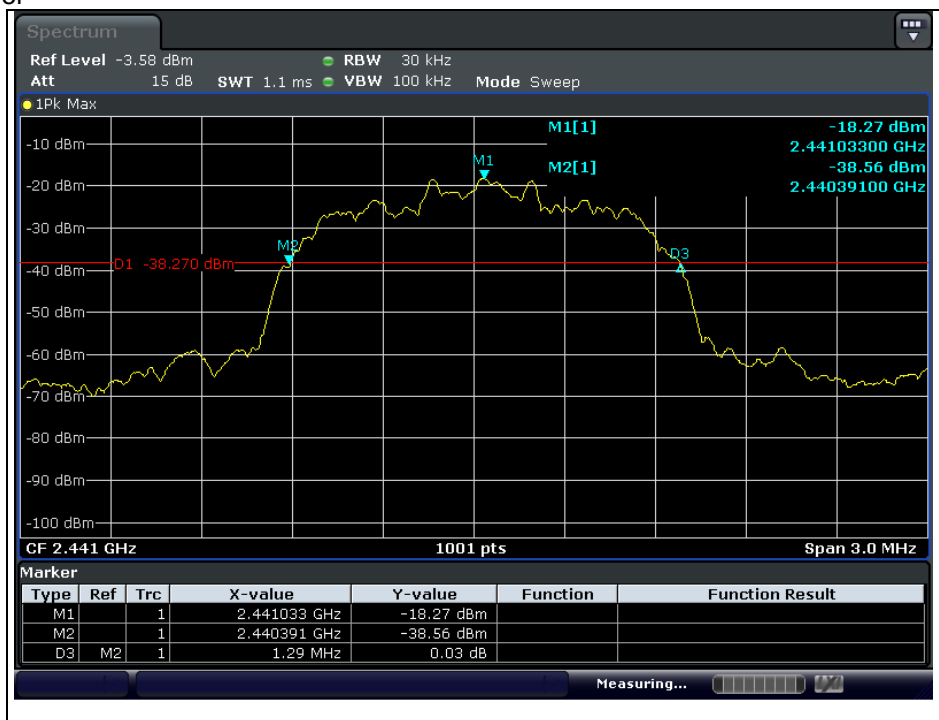

The results shown in this test report refer only to the sample(s) tested unless otherwise stated. This test report cannot be reproduced, except in full, without prior written permission of the Company. This test report does not assure KOLAS accreditation.

High Channel

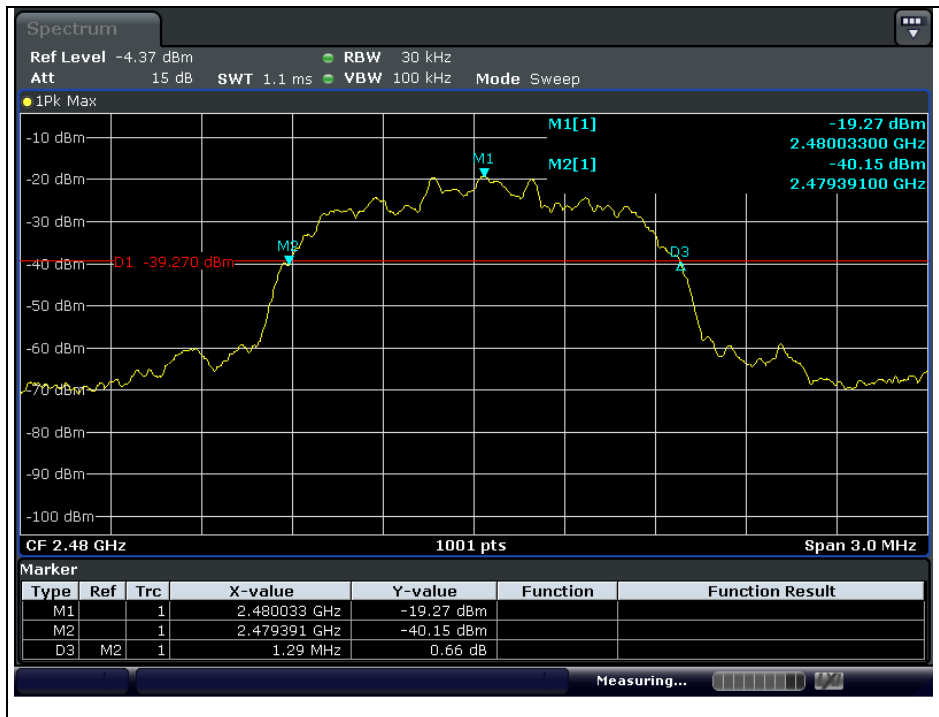

Operating Mode: 8DPSK

Low Channel

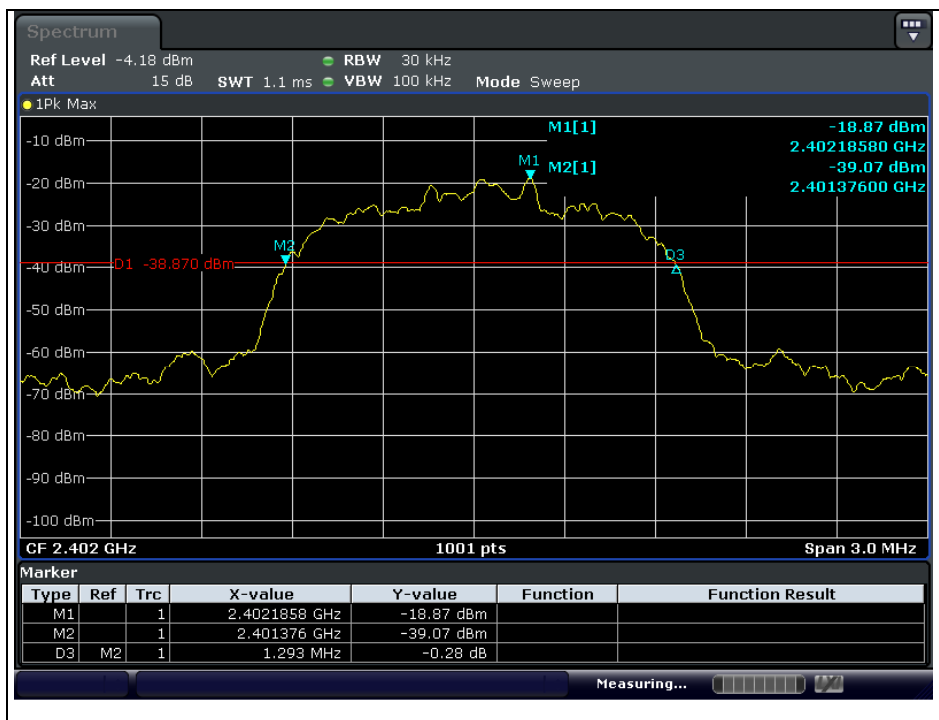

The results shown in this test report refer only to the sample(s) tested unless otherwise stated. This test report cannot be reproduced, except in full, without prior written permission of the Company. This test report does not assure KOLAS accreditation.

Middle Channel

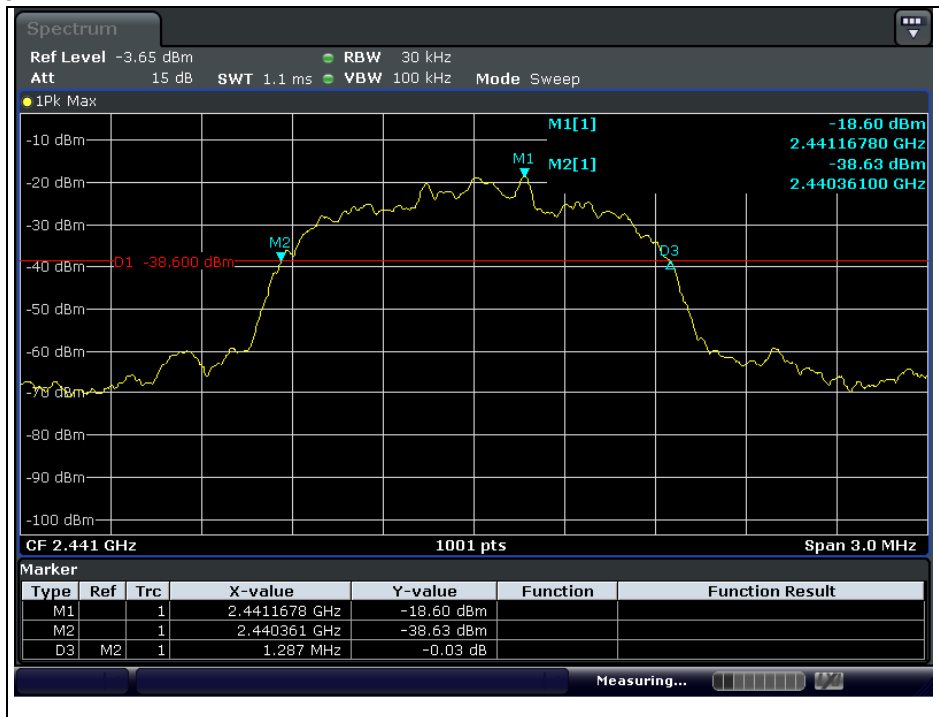

High Channel

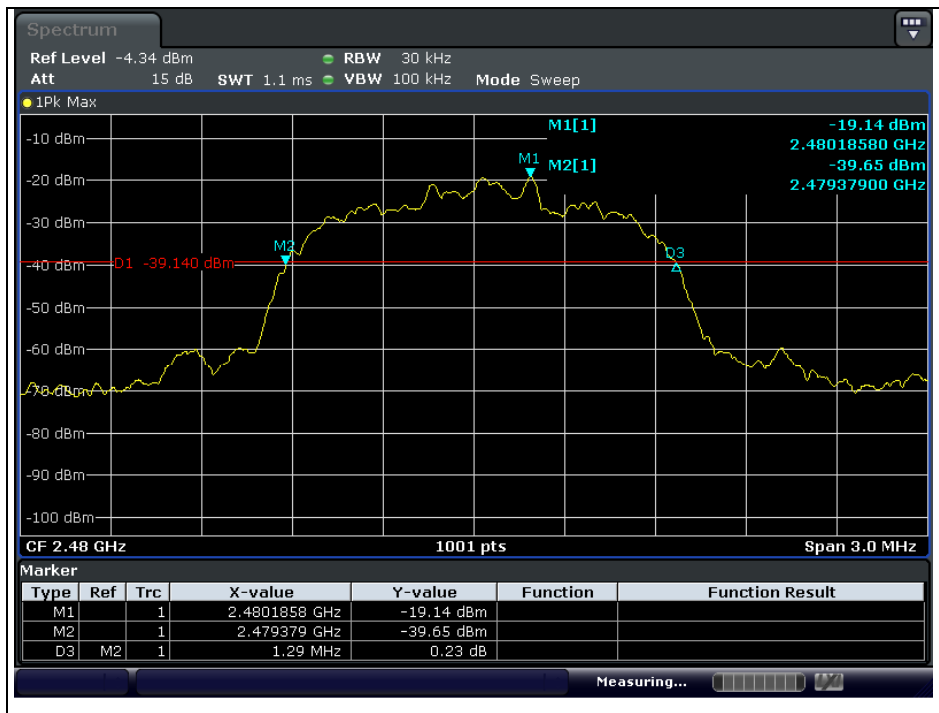

The results shown in this test report refer only to the sample(s) tested unless otherwise stated. This test report cannot be reproduced, except in full, without prior written permission of the Company. This test report does not assure KOLAS accreditation.

4. Maximum Peak Conducted Output Power

4.1. Test Setup

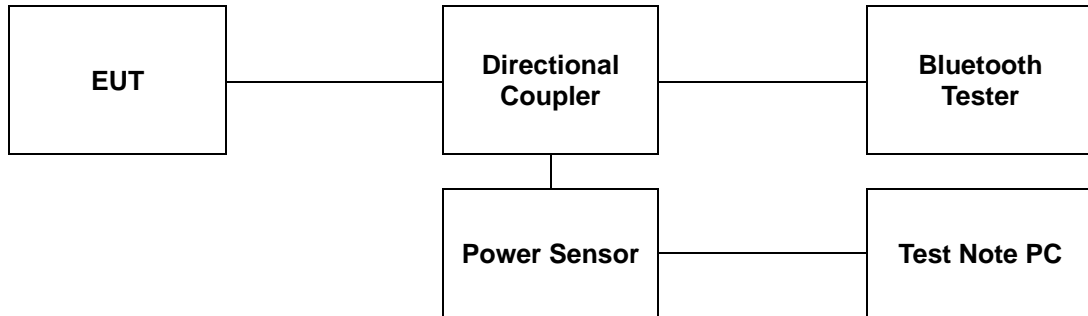

4.2. Limit

The maximum peak output power of the intentional radiator shall not exceed the following:

1. §15.247(a)(1), Frequency hopping systems shall have hopping channel carrier frequencies separated by a minimum of 25 kHz or the 20 dB bandwidth of the hopping channel, whichever is greater, provided the systems operate with an output power no greater than 125 mW.
2. §15.247(b)(1), For frequency hopping systems operating in the 2 400-2 483.5 MHz band employing at least 75 non-overlapping hopping channels, and all frequency hopping systems in the 5 725-5 850 MHz band: 1 watt. For all other frequency hopping systems in the 2 400-2 483.5 MHz band: 0.125 watts.

4.3. Test Procedure

The test follows ANSI C63.10-2013. Using the power sensor instead of a spectrum analyzer.

1. Place the EUT on the table and set it in the transmitting mode.
2. Remove the antenna from the EUT and then connect a low loss RF cable from the antenna port to the Power sensor.
3. Test program: (S/W name: R&S Power Viewer, Version: 3.2.0)
4. Measure peak power each channel.

The results shown in this test report refer only to the sample(s) tested unless otherwise stated. This test report cannot be reproduced, except in full, without prior written permission of the Company. This test report does not assure KOLAS accreditation.

4.4. Test Results

Ambient temperature : (23 ± 1) °C
 Relative humidity : 47 % R.H.

Operation Mode	Data Rate	Channel	Frequency (MHz)	Average Power Result (dB m)	Peak Power Result (dB m)	Limit (dB m)
GFSK	1 Mbps	Low	2 402	-0.18	0.57	20.97
		Middle	2 441	<u>0.30</u>	<u>1.08</u>	
		High	2 480	-0.86	0.13	
π/4DQPSK	2 Mbps	Low	2 402	-2.05	1.11	
		Middle	2 441	<u>-1.39</u>	<u>1.60</u>	
		High	2 480	-2.54	0.80	
8DPSK	3 Mbps	Low	2 402	-2.03	1.41	
		Middle	2 441	<u>-1.40</u>	<u>2.05</u>	
		High	2 480	-2.51	1.05	

Remark:

In the case of AFH, the limit for peak power is 0.125 W.
 Directional coupler and cable offset compensate for test program (R&S Power Viewer) before measuring.

The results shown in this test report refer only to the sample(s) tested unless otherwise stated. This test report cannot be reproduced, except in full, without prior written permission of the Company. This test report does not assure KOLAS accreditation.

5. Carrier Frequency Separation

5.1. Test Setup

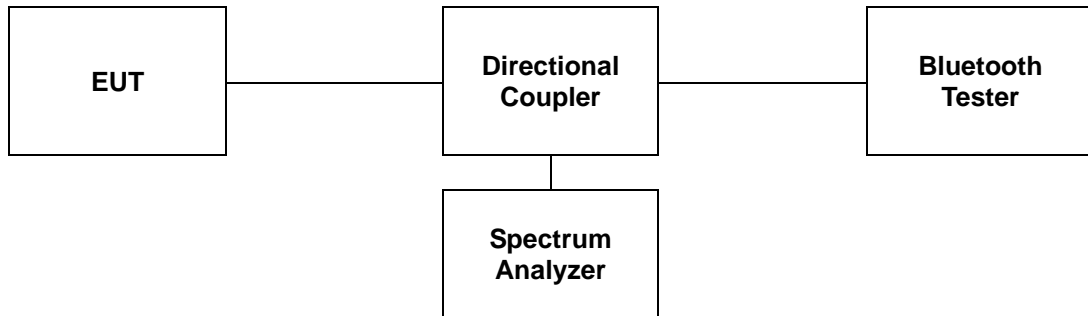

5.2. Limit

§15.247(a)(1), Frequency hopping systems operating in the 2 400–2 483.5 MHz band may have hopping channel carrier frequencies that are separated by 25 kHz or two-thirds of 20 dB bandwidth of the hopping channel, whichever is greater, provided the systems operate with an output power no greater than 125 mW.

5.3. Test Procedure

The test follows ANSI C63.10-2013.

The device is operating in hopping mode between 79 channels and also supporting Adaptive Frequency Hopping with hopping between 20 channels. As compared with each operating mode, 79 channels are chosen as a representative for test.

Use the following spectrum analyzer settings:

Span = wide enough to capture the peaks of two adjacent channels

RBW = Start with the RBW set to approximately 30% of the channel spacing; adjust as necessary to best identify the center of each individual channel.

VBW ≥ RBW

Sweep = auto

Detector = peak

Trace = max hold

Allow the trace to stabilize.

Use the marker-delta function to determine the between the peaks of the adjacent channels.

The results shown in this test report refer only to the sample(s) tested unless otherwise stated. This test report cannot be reproduced, except in full, without prior written permission of the Company. This test report does not assure KOLAS accreditation.

5.4. Test Results

Ambient temperature : (23 ± 1) °C
 Relative humidity : 47 % R.H.

Operation Mode	Frequency (MHz)	Adjacent Hopping Channel Separation (kHz)	Two-third of 20 dB Bandwidth (kHz)	Minimum Bandwidth (kHz)
GFSK	2 441	1 000	698	25
8DPSK	2 441	1 000	858	25

Remark:

Measurement is made with EUT operating in hopping mode between 79 channels providing a worse case scenario as compared to AFH mode hopping between 20 channels.

The results shown in this test report refer only to the sample(s) tested unless otherwise stated. This test report cannot be reproduced, except in full, without prior written permission of the Company. This test report does not assure KOLAS accreditation.

SGS Korea Co., Ltd. (Gunpo Laboratory) 4, LS-ro 182beon-gil, Gunpo-si, Gyeonggi-do, Korea, 15807 <http://www.sgsgroup.kr>

Operating Mode: GFSK

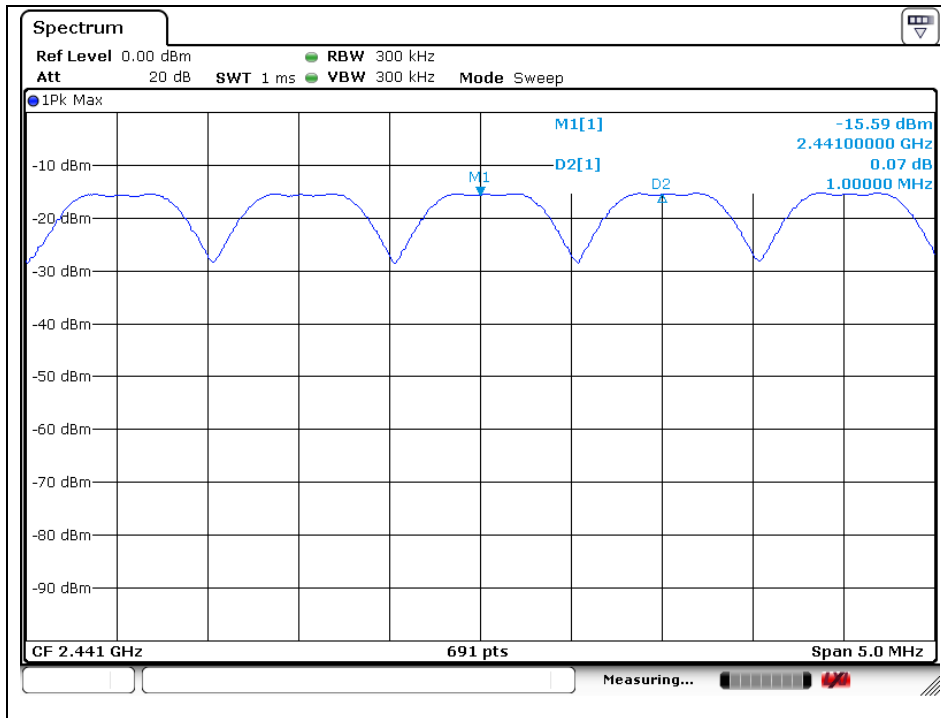

Operating Mode: 8DPSK

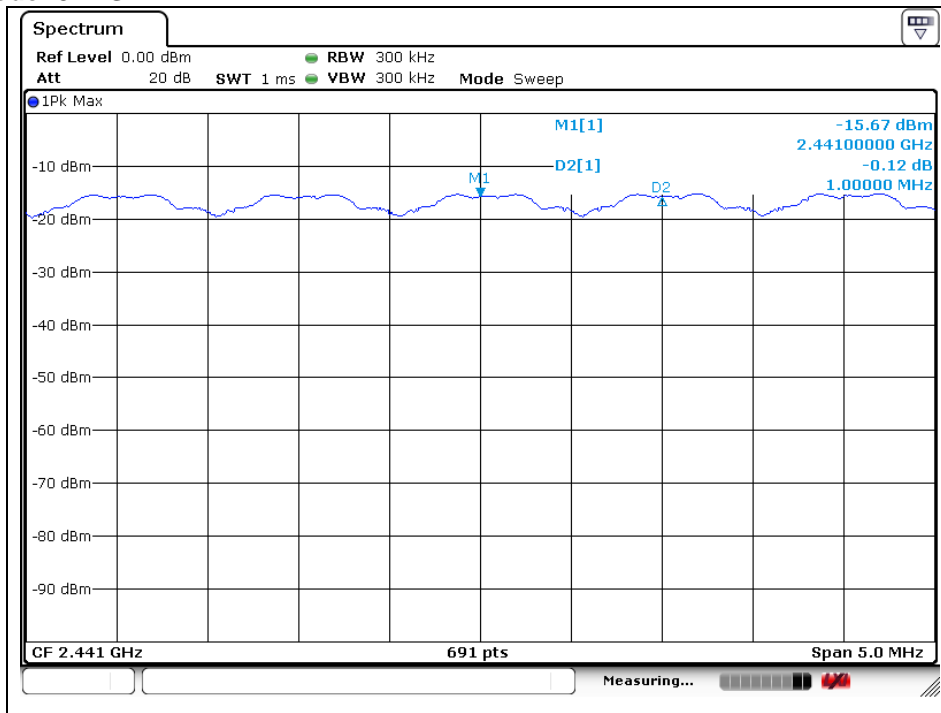

The results shown in this test report refer only to the sample(s) tested unless otherwise stated. This test report cannot be reproduced, except in full, without prior written permission of the Company. This test report does not assure KOLAS accreditation.

6. Number of Hopping Frequencies

6.1. Test Setup

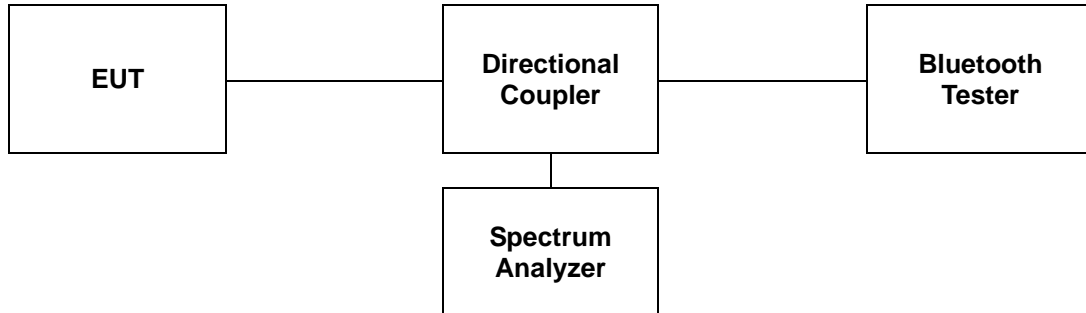

6.2. Limit

§15.247(a)(1)(iii), Frequency hopping systems in the 2 400–2 483.5 MHz band shall use at least 15 channels. The average time of occupancy on any channel shall not be greater than 0.4 seconds within a period of 0.4 seconds multiplied by the number of hopping channels employed. Frequency hopping systems may avoid or suppress transmissions on a particular hopping frequency provided that a minimum of 15 channels are used.

6.3. Test Procedure

The test follows ANSI C63.10-2013.

The device supports Adaptive Frequency Hopping and will use a minimum of 20 channels of the 79 available channels.

The EUT must have its hopping function enabled. Use the following spectrum analyzer settings:

1. Remove the antenna from the EUT and then connect a low loss RF cable from the antenna the port to the Spectrum analyzer.
2. Set spectrum analyzer Start = 2 400 MHz, Stop = 2 441.5 MHz, Sweep = auto and Start = 2 441.5 MHz, Stop = 2 483.5 MHz, Sweep = auto. Detector = peak.
3. Set the spectrum analyzer as RBW, VBW = 200 kHz.
4. Max hold, allow the trace to stabilize and count how many channel in the band.

The results shown in this test report refer only to the sample(s) tested unless otherwise stated. This test report cannot be reproduced, except in full, without prior written permission of the Company. This test report does not assure KOLAS accreditation.

6.4. Test Results

Ambient temperature : (23 ± 1) °C
 Relative humidity : 47 % R.H.

Operation Mode	Number of Hopping Frequency	Limit
GFSK	79	≥ 15
8DPSK	79	≥ 15

Remark:

Measurement is made with EUT operating in hopping mode between 79 channels providing a worse case scenario as compared to AFH mode hopping between 20 channels.

The results shown in this test report refer only to the sample(s) tested unless otherwise stated. This test report cannot be reproduced, except in full, without prior written permission of the Company. This test report does not assure KOLAS accreditation.

Operating Mode: GFSK

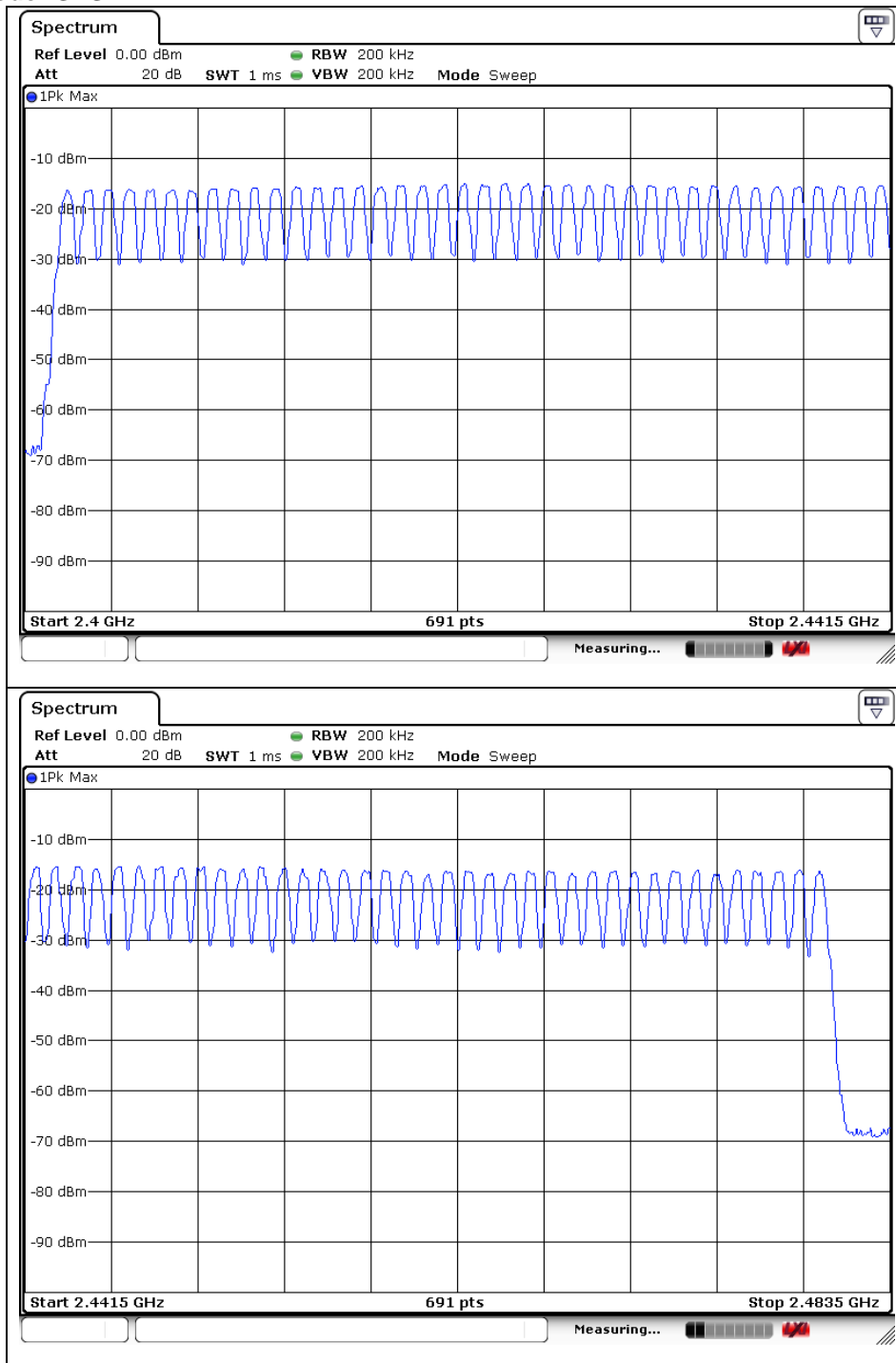

The results shown in this test report refer only to the sample(s) tested unless otherwise stated. This test report cannot be reproduced, except in full, without prior written permission of the Company. This test report does not assure KOLAS accreditation.

Operating Mode: 8DPSK

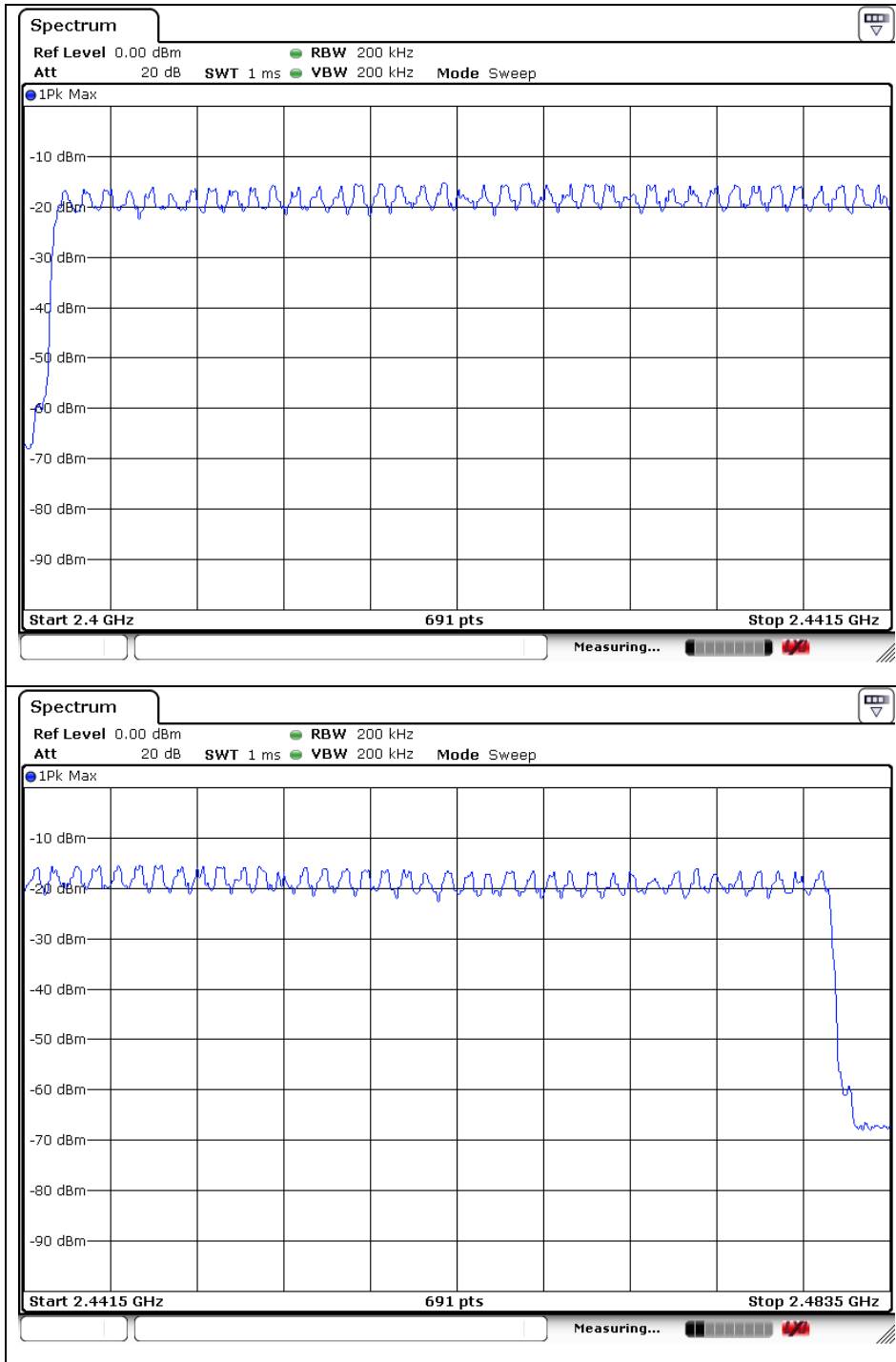

The results shown in this test report refer only to the sample(s) tested unless otherwise stated. This test report cannot be reproduced, except in full, without prior written permission of the Company. This test report does not assure KOLAS accreditation.

7. Time of Occupancy (Dwell Time)

7.1. Test Set up

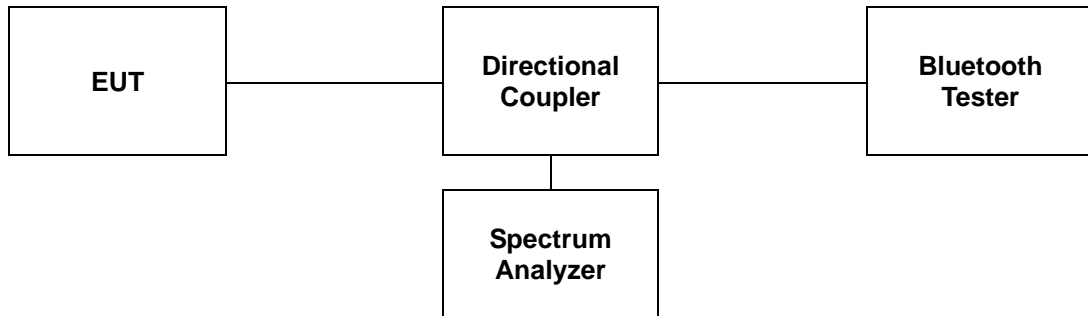

7.2. Limit

§15.247(a)(1)(iii), Frequency hopping systems in the 2 400–2 483.5 MHz band, the average time of occupancy on any frequency shall not be greater than 0.4 second within a 31.6 second period.

A period time = 0.4 (s) * 79 = 31.6 (s)

*Adaptive Frequency Hopping

A period time = 0.4 (s) * 20 = 8 (s)

7.3. Test Procedure

The test follows ANSI C63.10-2013.

1. Check the calibration of the measuring instrument using either an internal calibrator or a known signal from an external generator.
2. Position the EUT as shown in test setup without connection to measurement instrument. Turn on the EUT and connect its antenna terminal to measurement instrument via a low loss cable.
3. Measure the time duration of one transmission on the measured frequency. And then plot the result with time difference of this time duration.
4. The Bluetooth has 3 type of payload, DH1, DH3, DH5 and 3DH1, 3DH3, 3DH5. The hopping rate is insisted of 1 600 per second.

The EUT must have its hopping function enabled. Use the following spectrum analyzer setting:

Span = zero span, centered on a hopping channel

RBW = 1 MHz

VBW ≥ RBW

Sweep = as necessary to capture the entire dwell time per hopping channel

Detector = peak

Trace = max hold

Use the marker-delta function to determine the dwell time. If this value varies with different modes of operation, repeat this test for each variation.

The results shown in this test report refer only to the sample(s) tested unless otherwise stated. This test report cannot be reproduced, except in full, without prior written permission of the Company. This test report does not assure KOLAS accreditation.

7.4. Test Results

Ambient temperature : (23 ± 1) °C
 Relative humidity : 47 % R.H.

7.4.1. Packet Type: DH1, 3DH1

Operation Mode	Frequency (MHz)	Dwell Time (ms)	Time of occupancy on the Tx Channel in 31.6 sec (ms)	Limit for time of occupancy on the Tx Channel in 31.6 sec (ms)
GFSK	2 441	0.39	124.80	400
8DPSK	2 441	0.39	124.80	400

Remark:

Time of occupancy on the Tx channel in 31.6 sec

In case of GFSK and 8DPSK, $0.39 \times \{(1\ 600 \div 2) / 79\} \times 31.6 = 124.80$ ms

The results shown in this test report refer only to the sample(s) tested unless otherwise stated. This test report cannot be reproduced, except in full, without prior written permission of the Company. This test report does not assure KOLAS accreditation.

SGS Korea Co., Ltd. (Gunpo Laboratory) 4, LS-ro 182beon-gil, Gunpo-si, Gyeonggi-do, Korea, 15807 <http://www.sgsgroup.kr>

Operating Mode: GFSK

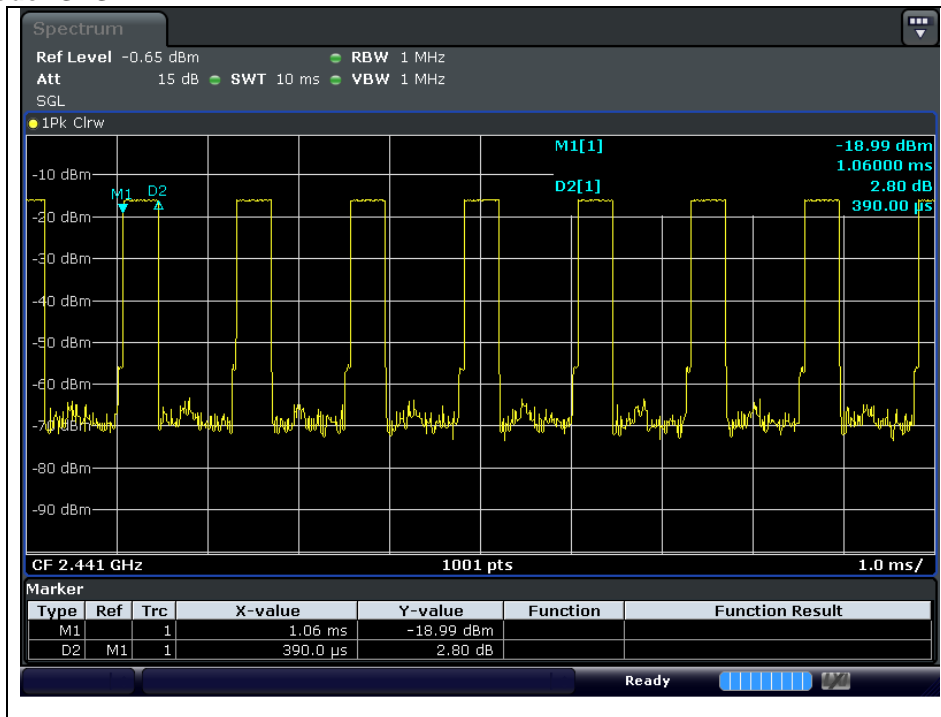

Operating Mode: 8DPSK

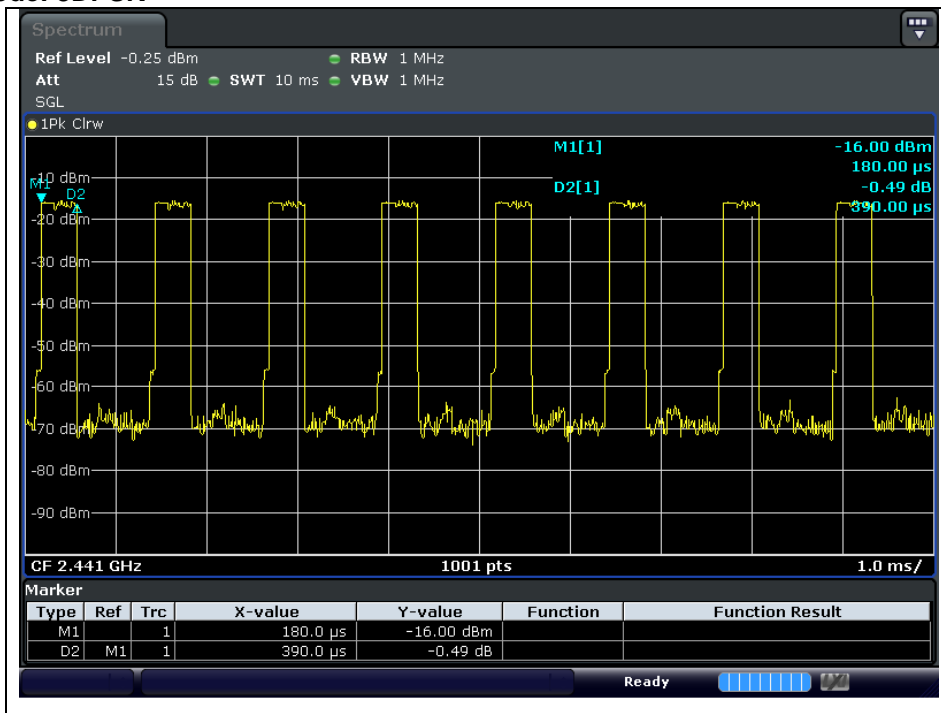

The results shown in this test report refer only to the sample(s) tested unless otherwise stated. This test report cannot be reproduced, except in full, without prior written permission of the Company. This test report does not assure KOLAS accreditation.

7.4.2. Packet Type: DH3, 3DH3

Operation Mode	Frequency (MHz)	Dwell Time (ms)	Time of occupancy on the Tx Channel in 31.6 sec (ms)	Limit for time of occupancy on the Tx Channel in 31.6 sec (ms)
GFSK	2 441	1.64	262.40	400
8DPSK	2 441	1.64	262.40	400

Remark:

Time of occupancy on the Tx channel in 31.6 sec

 In case of GFSK and 8DPSK, $1.64 \times \{(1\ 600 \div 4) / 79\} \times 31.6 = 262.40$ ms

The results shown in this test report refer only to the sample(s) tested unless otherwise stated. This test report cannot be reproduced, except in full, without prior written permission of the Company. This test report does not assure KOLAS accreditation.

Operating Mode: GFSK

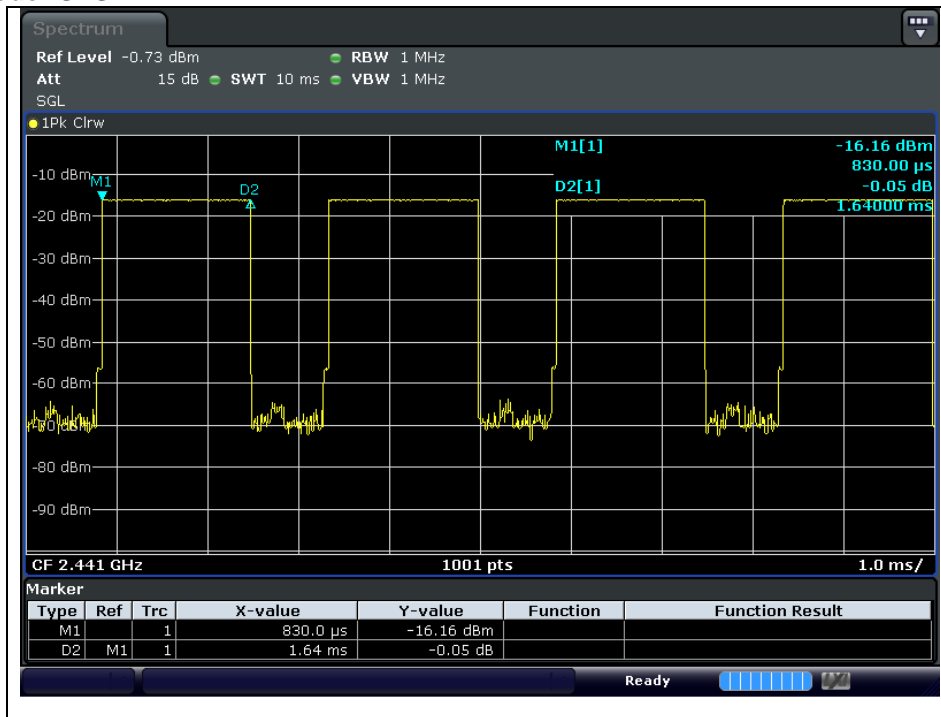

Operating Mode: 8DPSK

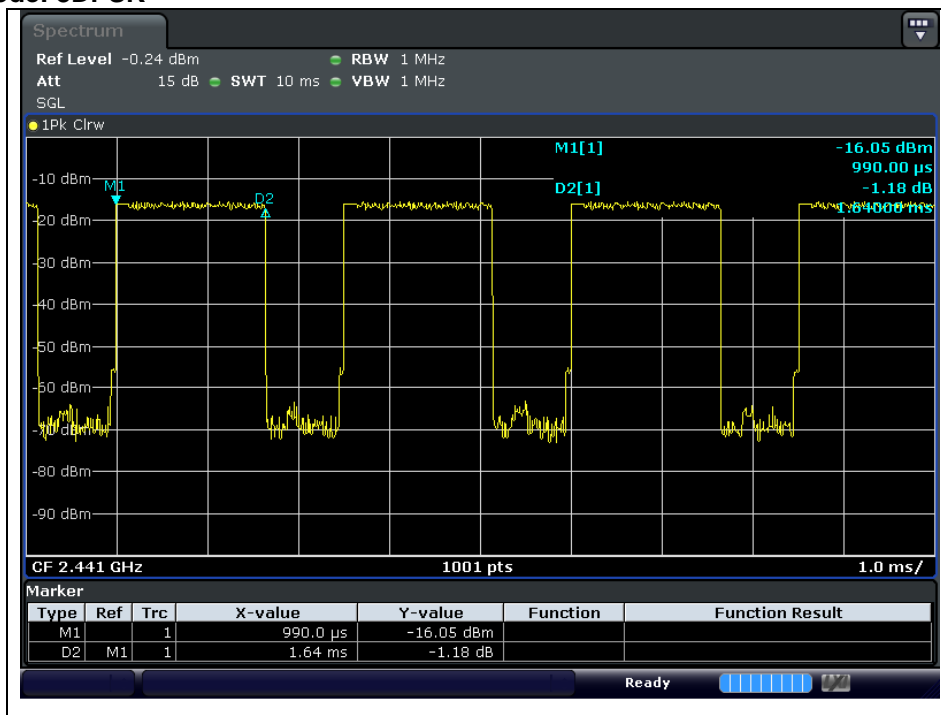

The results shown in this test report refer only to the sample(s) tested unless otherwise stated. This test report cannot be reproduced, except in full, without prior written permission of the Company. This test report does not assure KOLAS accreditation.

7.4.3. Packet Type: DH5, 3DH5

Operation Mode	Frequency (MHz)	Dwell Time (ms)	Time of occupancy on the Tx Channel in 31.6 sec (ms)	Limit for time of occupancy on the Tx Channel in 31.6 sec (ms)
GFSK	2 441	2.89	308.27	400
8DPSK	2 441	2.88	307.20	400

Remark:

Time of occupancy on the Tx channel in 31.6 sec

In case of GFSK, $2.89 \times \{(1\ 600 \div 6) / 79\} \times 31.6 = 308.27$ ms

In case of 8DPSK, $2.88 \times \{(1\ 600 \div 6) / 79\} \times 31.6 = 307.20$ ms

The results shown in this test report refer only to the sample(s) tested unless otherwise stated. This test report cannot be reproduced, except in full, without prior written permission of the Company. This test report does not assure KOLAS accreditation.

Operating Mode: GFSK

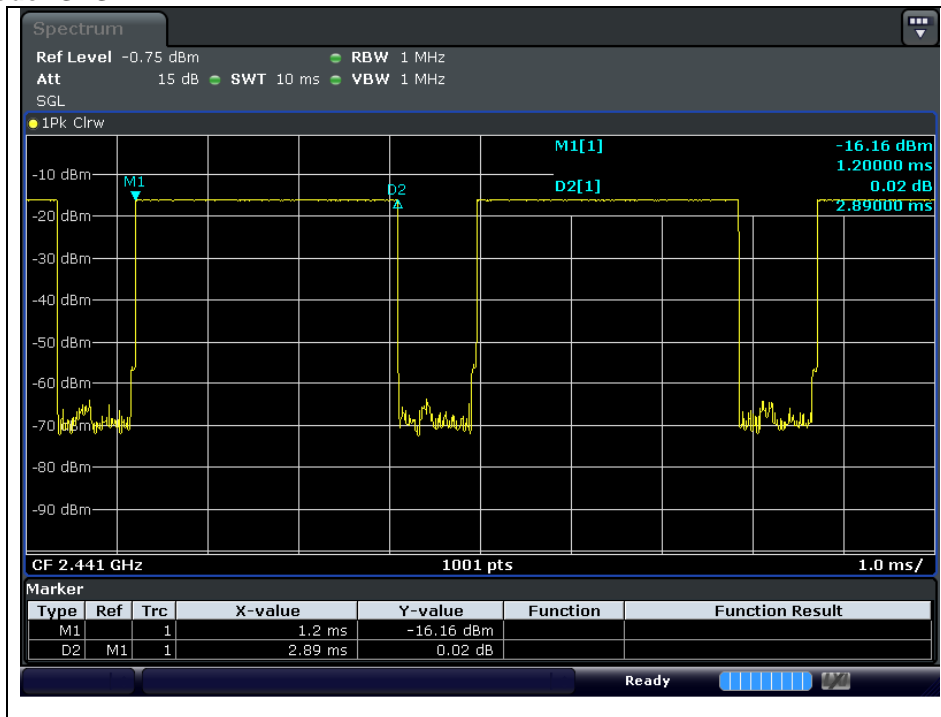

Operating Mode: 8DPSK

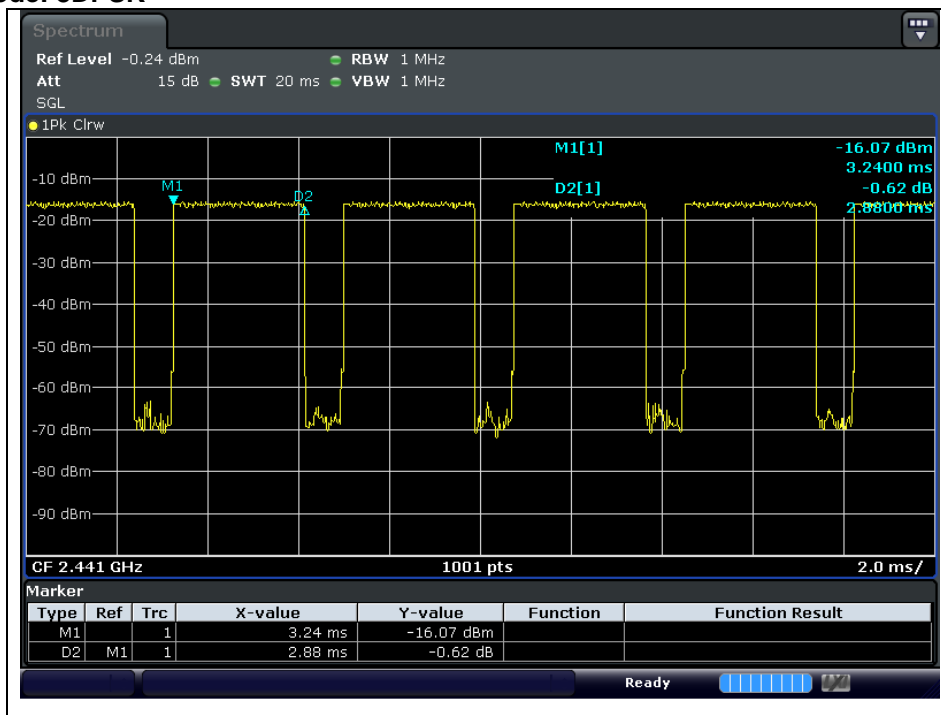

The results shown in this test report refer only to the sample(s) tested unless otherwise stated. This test report cannot be reproduced, except in full, without prior written permission of the Company. This test report does not assure KOLAS accreditation.

7.4.4. Packet Type: DH1, 3DH1 (Adaptive Frequency Hopping)

Operation Mode	Frequency (MHz)	Dwell Time (ms)	Time of occupancy on the Tx Channel in 8 sec (ms)	Limit for time of occupancy on the Tx Channel in 8 sec (ms)
GFSK	2 441	0.38	60.80	400
8DPSK	2 441	0.39	62.40	400

Remark:

Time of occupancy on the Tx channel in 8 sec

In case of GFSK, $0.38 \times \{(800 \div 2) / 20\} \times 8 = 60.80 \text{ ms}$

In case of 8DPSK, $0.39 \times \{(800 \div 2) / 20\} \times 8 = 62.40 \text{ ms}$

The results shown in this test report refer only to the sample(s) tested unless otherwise stated. This test report cannot be reproduced, except in full, without prior written permission of the Company. This test report does not assure KOLAS accreditation.

Operating Mode: GFSK

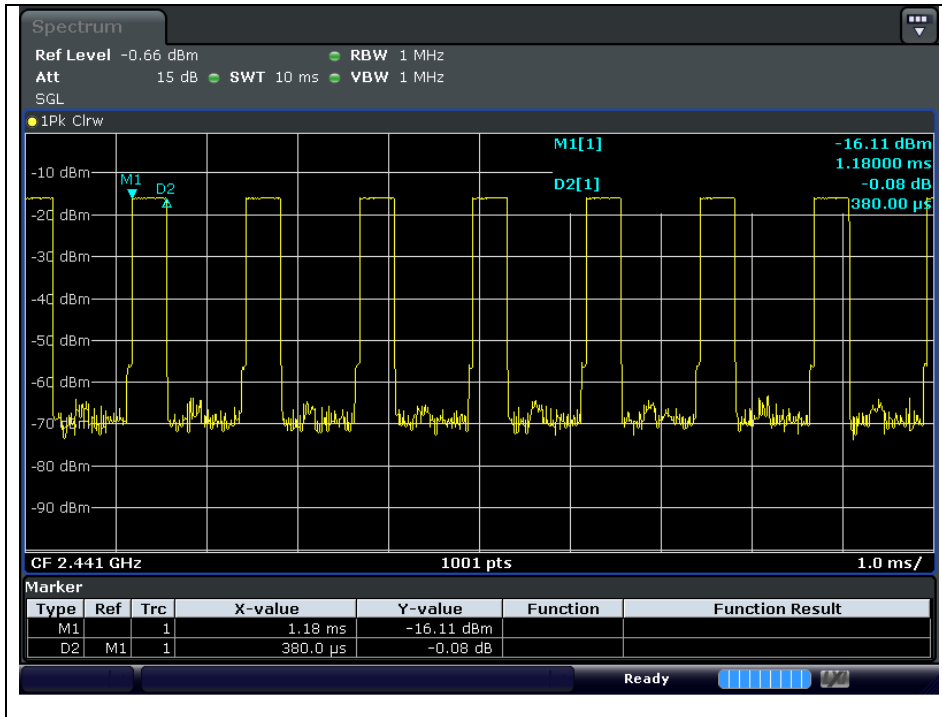

Operating Mode: 8DPSK

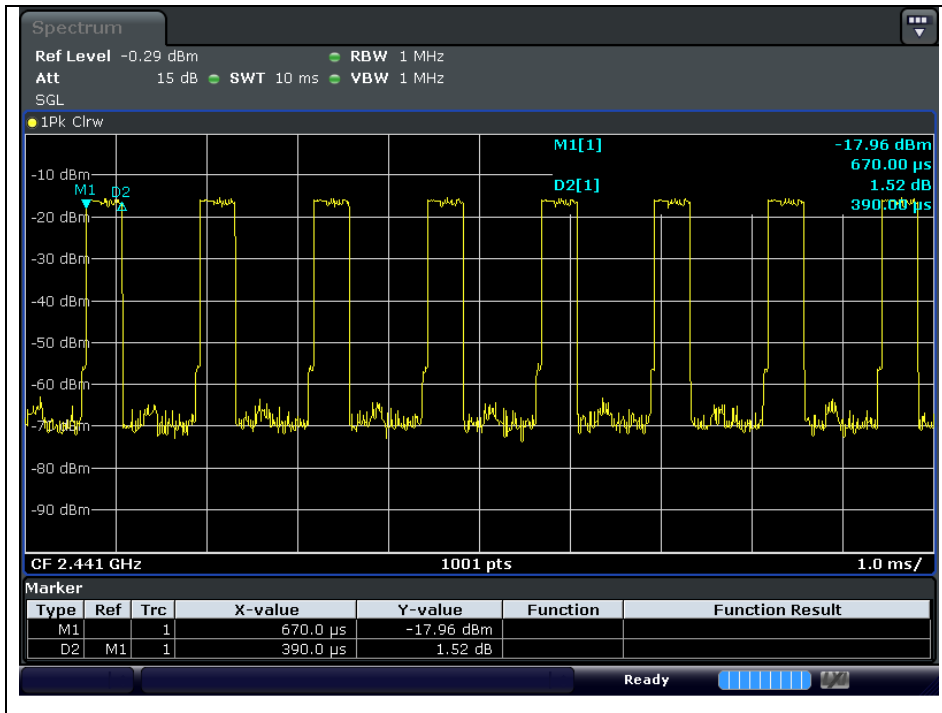

The results shown in this test report refer only to the sample(s) tested unless otherwise stated. This test report cannot be reproduced, except in full, without prior written permission of the Company. This test report does not assure KOLAS accreditation.

7.4.5. Packet Type: DH3, 3DH3 (Adaptive Frequency Hopping)

Operation Mode	Frequency (MHz)	Dwell Time (ms)	Time of occupancy on the Tx Channel in 8 sec (ms)	Limit for time of occupancy on the Tx Channel in 8 sec (ms)
GFSK	2 441	1.64	131.20	400
8DPSK	2 441	1.64	131.20	400

Remark:

Time of occupancy on the Tx channel in 8 sec

In case of GFSK and 8DPSK, $1.64 \times \{(800 \div 4) / 20\} \times 8 = 131.20$ ms

The results shown in this test report refer only to the sample(s) tested unless otherwise stated. This test report cannot be reproduced, except in full, without prior written permission of the Company. This test report does not assure KOLAS accreditation.

Operating Mode: GFSK

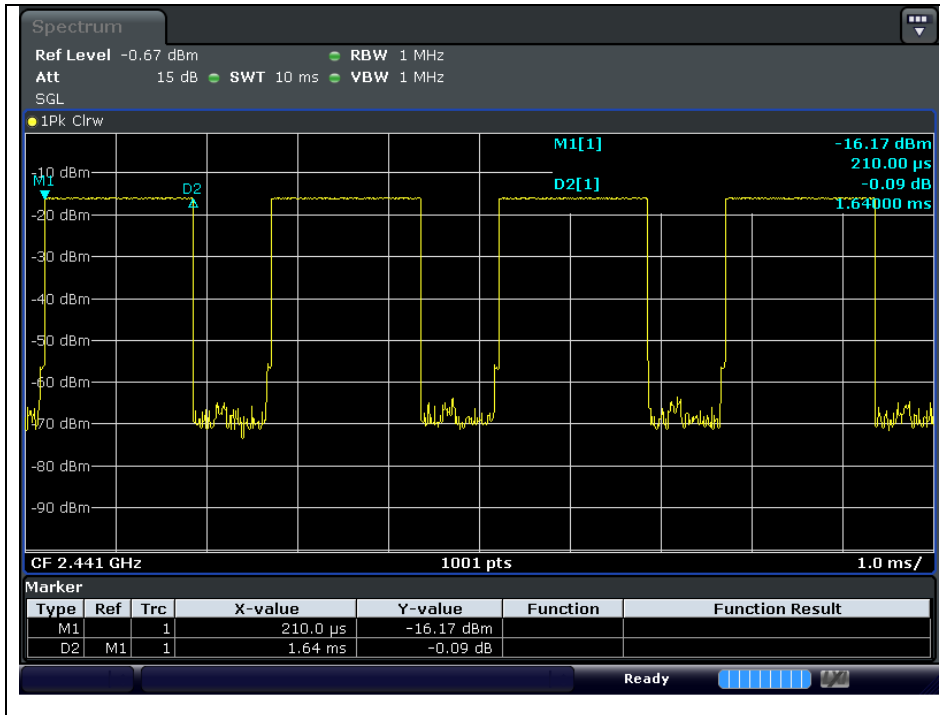

Operating Mode: 8DPSK

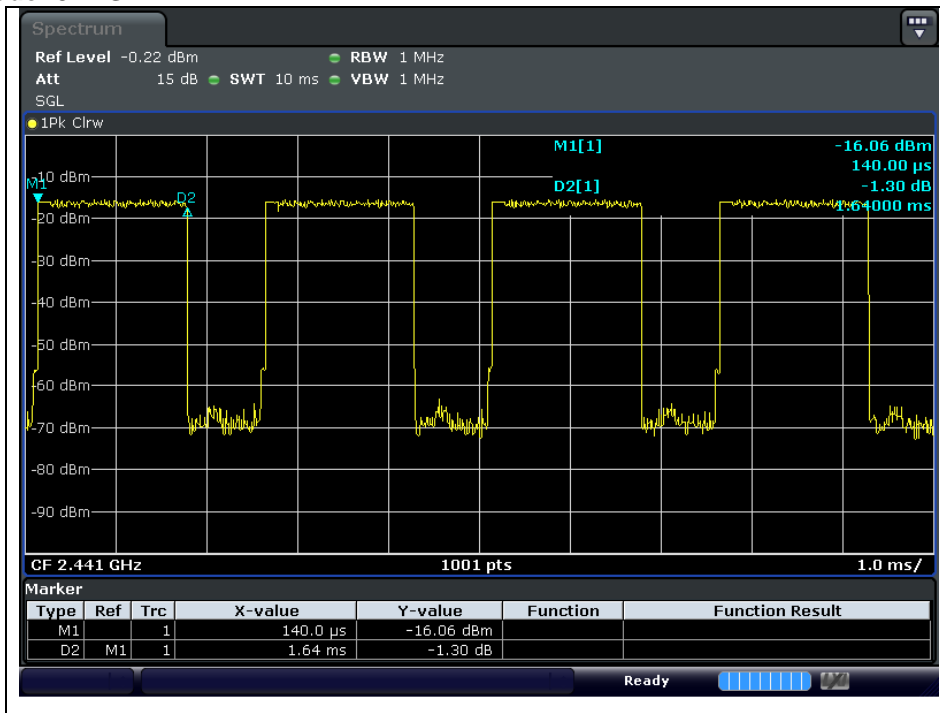

The results shown in this test report refer only to the sample(s) tested unless otherwise stated. This test report cannot be reproduced, except in full, without prior written permission of the Company. This test report does not assure KOLAS accreditation.

7.4.6. Packet Type: DH5, 3DH5 (Adaptive Frequency Hopping)

Operation Mode	Frequency (MHz)	Dwell Time (ms)	Time of occupancy on the Tx Channel in 8 sec (ms)	Limit for time of occupancy on the Tx Channel in 8 sec (ms)
GFSK	2 441	2.89	154.13	400
8DPSK	2 441	2.90	154.67	400

Remark:

Time of occupancy on the Tx channel in 8 sec

In case of GFSK, $2.89 \times \{(800 \div 6) / 20\} \times 8 = 154.13 \text{ ms}$

In case of 8DPSK, $2.90 \times \{(800 \div 6) / 20\} \times 8 = 154.67 \text{ ms}$

The results shown in this test report refer only to the sample(s) tested unless otherwise stated. This test report cannot be reproduced, except in full, without prior written permission of the Company. This test report does not assure KOLAS accreditation.

Operating Mode: GFSK

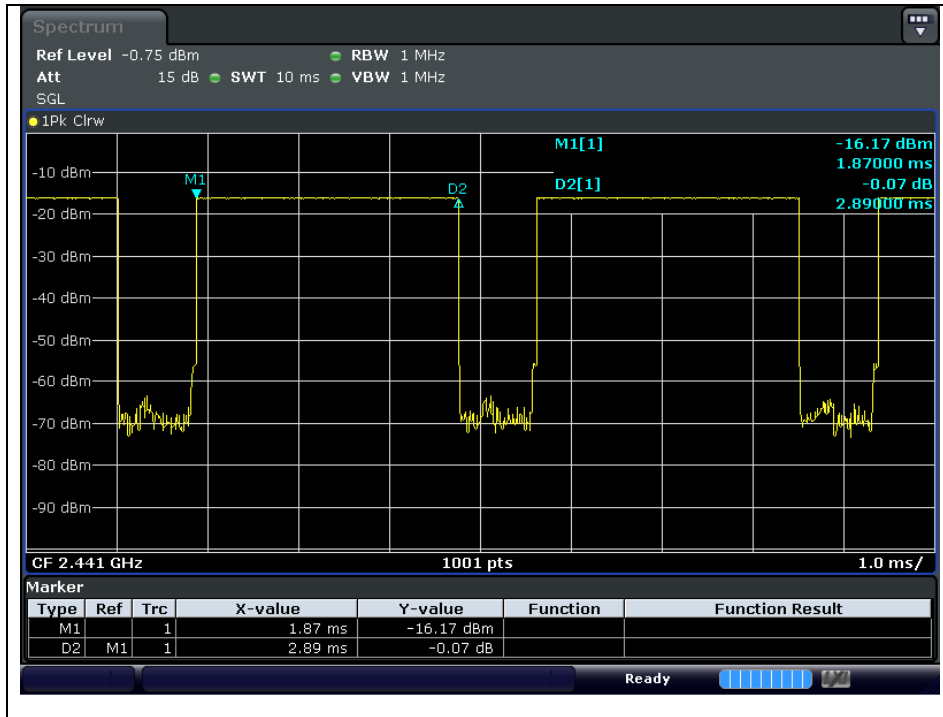

Operating Mode: 8DPSK

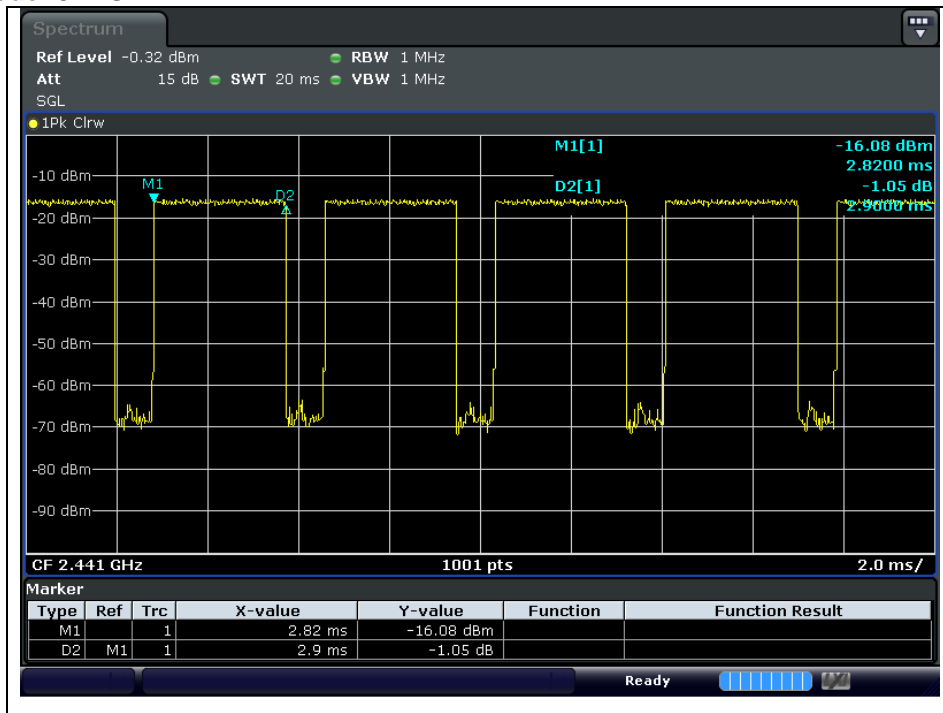

The results shown in this test report refer only to the sample(s) tested unless otherwise stated. This test report cannot be reproduced, except in full, without prior written permission of the Company. This test report does not assure KOLAS accreditation.

8. Antenna Requirement

8.1. Standard Applicable

For intentional device, according to FCC 47 CFR Section §15.203, an intentional radiator shall be designed to ensure that no antenna other than that furnished by the responsible party shall be used with the device. And according to FCC 47 CFR Section §15.247 (b) if transmitting antennas of directional gain greater than 6 dB i are used, the power shall be reduced by the amount in dB that the gain of the antenna exceeds 6 dB i.

8.2. Antenna Connected Construction

Antenna used in this product is Pattern Antenna with gain of -0.05 dB i.

- End of the Test Report -

The results shown in this test report refer only to the sample(s) tested unless otherwise stated. This test report cannot be reproduced, except in full, without prior written permission of the Company. This test report does not assure KOLAS accreditation.

SGS Korea Co., Ltd. (Gunpo Laboratory) 4, LS-ro 182beon-gil, Gunpo-si, Gyeonggi-do, Korea, 15807 <http://www.sgsgroup.kr>

RTT5041-19(2017.07.10)(0)

Tel. +82 31 428 5700 / Fax. +82 31 427 2370

A4(210 mm x 297 mm)