

**ELECTROMAGNETIC EMISSIONS COMPLIANCE REPORT
INTENTIONAL RADIATOR CERTIFICATION TO
FCC PART 15 SUBPART C REQUIREMENT**

OF

UHF RFID Reader

MODEL No.: XC2903

Brand Name:  远望谷

FCC ID: TQ4XC2903

REPORT NO.: ES140124192E2

ISSUE DATE: May 19, 2014

Prepared for

INVENGO INFORMATION TECHNOLOGY CO., LTD.

3/F, No.T2-B, High-tech industrial Park South, Shenzhen 518057, China.

Prepared by

SHENZHEN EMTEK CO., LTD.

**Bldg 69, Majialong Industry Zone, Nanshan District, Shenzhen,
Guangdong, China**

TEL : 86-755-26954280

FAX: 86-755-26954282

VERIFICATION OF COMPLIANCE

Applicant	:	INVENGO INFORMATION TECHNOLOGY CO., LTD. 3/F, No.T2-B,High-tech industrial Park South, Shenzhen 518057,china
Manufacturer	:	INVENGO INFORMATION TECHNOLOGY CO., LTD. 3/F, No.T2-B,High-tech industrial Park South, Shenzhen 518057,china
Product Description	:	UHF RFID Reader
Model Number	:	XC2903
Serial Number	:	N/A
File Number	:	ES140124192E2
Date of Test	:	February 27, 2014 to May 19, 2014

We hereby certify that:

The above equipment was tested by SHENZHEN EMTEK CO., LTD. The test data, data evaluation, test procedures, and equipment configurations shown in this report were made in accordance with the procedures given in ANSI C63.4 (2009) and the energy emitted by the sample EUT tested as described in this report is in compliance with conducted and radiated emission limits of FCC Rules Part 15.247.

The test results of this report relate only to the tested sample identified in this report.

Date of Test : February 27, 2014 to May 19, 2014

Prepared by : Jack . Li
Jack.Li/Editor

Reviewer : June Xie
June xie/Supervisor

Approve & Authorized Signer : 
Lisa Wang/Manager

Table of Contents

1.	GENERAL INFORMATION	6
1.1	PRODUCT DESCRIPTION	6
1.2	RELATED SUBMITTAL(S) / GRANT (S).....	7
1.3	TEST METHODOLOGY.....	7
1.4	SPECIAL ACCESSORIES	7
1.5	EQUIPMENT MODIFICATIONS.....	7
1.6	TEST FACILITY.....	7
2.	SYSTEM TEST CONFIGURATION.....	8
2.1	EUT CONFIGURATION.....	8
2.2	EUT EXERCISE	8
2.3	TEST PROCEDURE.....	8
2.4	LIMITATION.....	9
2.5	CONFIGURATION OF TESTED SYSTEM	11
2.6	DESCRIPTION OF TEST MODES	12
3.	SUMMARY OF TEST RESULTS	13
4.	CONDUCTED EMISSIONS TEST.....	14
4.1	MEASUREMENT PROCEDURE:.....	14
4.2	TEST SET-UP (BLOCK DIAGRAM OF CONFIGURATION).....	14
4.3	MEASUREMENT EQUIPMENT USED:	14
4.4	CONDUCTED EMISSION LIMIT	14
4.5	MEASUREMENT RESULT:.....	15
5.	RADIATED EMISSION TEST	16
5.1	MEASUREMENT PROCEDURE.....	16
5.2	TEST SET-UP (BLOCK DIAGRAM OF CONFIGURATION).....	16
5.3	MEASUREMENT EQUIPMENT USED:	17
5.4	RADIATED EMISSION LIMIT	17
5.4	MEASUREMENT RESULT	19
6.	CHANNEL SEPARATION TEST.....	25
6.1	MEASUREMENT PROCEDURE.....	25
6.2	TEST SET-UP (BLOCK DIAGRAM OF CONFIGURATION).....	25
6.3	MEASUREMENT EQUIPMENT USED:	25
6.4	MEASUREMENT RESULTS:.....	25
7.	BANDWIDTH TEST.....	28
7.1	MEASUREMENT PROCEDURE.....	28
7.2	TEST SET-UP (BLOCK DIAGRAM OF CONFIGURATION).....	28
7.3	MEASUREMENT EQUIPMENT USED:	28
7.4	MEASUREMENT RESULTS:.....	28

8.	QUANTITY OF HOPPING CHANNEL TEST	31
8.1	MEASUREMENT PROCEDURE.....	31
8.2	TEST SET-UP (BLOCK DIAGRAM OF CONFIGURATION).....	31
8.3	MEASUREMENT EQUIPMENT USED:	31
8.4	MEASUREMENT RESULTS:.....	31
9.	TIME OF OCCUPANCY (DWELL TIME) TEST.....	32
9.2	TEST SET-UP (BLOCK DIAGRAM OF CONFIGURATION).....	32
9.3	MEASUREMENT EQUIPMENT USED:	32
9.4	MEASUREMENT RESULTS:.....	32
10.	MAXIMUM PEAK OUTPUT POWER TEST.....	34
10.1	MEASUREMENT PROCEDURE.....	34
10.2	TEST SET-UP (BLOCK DIAGRAM OF CONFIGURATION).....	34
10.3	MEASUREMENT EQUIPMENT USED:	34
10.4	MEASUREMENT RESULTS:.....	34
11.	BAND EDGE TEST	35
11.1	MEASUREMENT PROCEDURE.....	35
11.2	TEST SET-UP (BLOCK DIAGRAM OF CONFIGURATION).....	35
11.3	MEASUREMENT EQUIPMENT USED:	35
11.4	MEASUREMENT RESULTS:.....	35
12.	ANTENNA PORT EMISSION	37
12.1	TEST EQUIPMENT	37
12.2	MEASURING INSTRUMENTS AND SETTING	37
12.3	TEST PROCEDURES	37
12.4	BLOCK DIAGRAM OF TEST SETUP	37
12.5	TEST RESULT	37
13.	ANTENNA APPLICATION	41
13.1	ANTENNA REQUIREMENT.....	41
13.2	RESULT	41

Modified Information

Version	Report No.	Revision Data	Summary
Ver.1.0	ES140124192E2	/	Original Version

1. GENERAL INFORMATION

1.1 Product Description

Device Type:	Portable Device
Exposure Category:	Uncontrolled Environment/General Population
Product Name:	UHF RFID Reader
Model Number:	XC2903
Power supply:	3.7V internal rechargeable lithium battery or DC 5V from AC adapter
Adapter:	Model: FSP020-DGAA1 Input: 100-240V~, 50/60Hz, 1.0A Output: DC 5.0V, 4.0A MAX
MEID:	N/A
Hardware Version:	N/A
Software Version:	Windows CE 6.0
Operating Mode(s) & Operating Frequency Range(s):	802.11b/g/n(HT20): 2412 MHz ~ 2462 MHz; RFID: 902.75 MHz ~ 927.25 MHz; GPRS850:TX824.2 MHz ~ 848.8 MHz /RX869.2 MHz ~ 893.8 MHz; GPRS1900:TX1850.2 MHz~1909.8MHz/RX1930.2 MHz ~ 1989.8 MHz;
Modulation:	OFDM with BPSK/QPSK/16QAM/64QAM for 802.11g/n; DSSS with DBPSK/DQPSK/CCK for 802.11b; GMSK for GPRS; ASK for RFID;
Number of Channels:	11 Channels for 802.11b/g/n; 50 Channels for RFID; 124 Channels for GPRS850; 299 Channels for GPRS1900;
Type of Antenna:	External Antenna
Antenna Gain:	1.6dBi for GPRS, 2dBi for Wifi, 1dBi for RFID;
RF Output	GPRS850:32.83dBm MAX; GPRS1900:29.62dBm MAX;

Power:	802.11b: 21.27dBm MAX; RFID:26.52dBm MAX
---------------	--

1.2 Related Submittal(s) / Grant (s)

This submittal(s) (test report) is intended for FCC ID: TQ4XC2903 filing to comply with Section 15.247 of the FCC Part 15 Subpart C Rules.

1.3 Test Methodology

Both conducted and radiated testing were performed according to the procedures in ANSI C63.4 (2009) and FCC Public Notice DA 00-705. Radiated testing was performed at an antenna to EUT distance 3 meters.

1.4 Special Accessories

Not available for this EUT intended for grant.

1.5 Equipment Modifications

Not available for this EUT intended for grant.

1.6 Test Facility

Site Description
EMC Lab.

: Accredited by CNAS, 2013.10.29
The certificate is valid until 2016.10.28
The Laboratory has been assessed and proved to be in compliance with CNAS/CL01:2006(identical to ISO/IEC17025:2005)
The Certificate Registration Number is L2291

Accredited by TUV Rheinland Shenzhen 2010.5.25
The Laboratory has been assessed according to the requirements ISO/IEC 17025

Accredited by FCC, October 28, 2010
The Certificate Registration Number is 406365.

Accredited by Industry Canada, March 5, 2010
The Certificate Registration Number is 46405-4480.

Name of Firm : SHENZHEN EMTEK CO., LTD
Site Location : Bldg 69, Majialong Industry Zone,
Nanshan District, Shenzhen, Guangdong, China

2. System Test Configuration

2.1 EUT Configuration

The EUT configuration for testing is installed on RF field strength measurement to meet the Commissions requirement and operating in a manner which intends to maximize its emission characteristics in a continuous normal application.

2.2 EUT Exercise

The Transmitter was operated in the normal operating mode. The Tx frequency was fixed which was for the purpose of the measurements.

2.3 Test Procedure

2.3.1 Conducted Emissions

The EUT is a placed on as turn table which is 0.8 m above ground plane. According to the requirements in Section 13.1.4.1 of ANSI C63.4-2009 Conducted emissions from the EUT measured in the **frequency range between 0.15 MHz and 30MHz** using **CISPR Quasi-Peak and average detector mode**.

2.3.2 Radiated Emissions

The EUT is a placed on as turn table which is 0.8 m above ground plane. The turn table shall rotate 360 degrees to determine the position of maximum emission level. EUT is set 3m away from the receiving antenna which varied from 1m to 4m to find out the highest emission. And also, each emission was to be maximized by changing the polarization of receiving antenna both horizontal and vertical. In order to find out the max. emission, the relative positions of this hand-held transmitter(EUT) was rotated through three orthogonal axes according to the requirements in Section 13.1.4.1 of ANSI C63.4-2009.

2.4 Limitation

(1) Channel Separation test

FCC Part 15, Subpart C Section 15.247(a)(1) Frequency hopping systems shall have hopping channel carrier frequencies separated by a minimum of 25kHz or the 20 Bandwidth of the hopping channel, whichever is greater.

Frequency Range (MHz)	Limit(kHz)
902-928	>25kHz
2400-2483.5	>25kHz
5725-5850	>25kHz

(2)

Frequency Range(MHz)	Quantity of Hopping Channel	20dB Bandwidth Limit(kHz)			
		50	25	15	75
902-928		<250	>250	NA	NA
2400-2483.5		NA	NA	>1000	<1000

(3) Quantity of Hopping Channel

FCC Part 15, Subpart C Section 15.247

Frequency Range (MHz)	Limit(Quantity of Hopping Channel)			
	20dB bandwidth <250kHz	20dB bandwidth >25 0kHz	20dB bandwidth <1MHz	20dB bandwidth >1 MHz
902-928	50	25	NA	NA
2400-2483.5	NA	NA	75	15
5725-5850	NA	NA	75	NA

(4) Time of Occupancy(Dwell Time)

FCC Part 15, Subpart C Section 15.247

Frequency Range (MHz)	20dB bandwidth <250kHz(50Channel)	LIMIT(rms)	
		20dB bandwidth >250kHz (25Channel)	20dB bandwidth <1MHz(75Channel)
902-928	400(20S)	400(10S)	NA
2400-2483.5	NA	NA	400(30S)
5725-5850	NA	NA	400(30S)

Note: The “()”is all channel’s average time of occupancy.

(5) Maximum Peak Output Power

FCC Part 15, Subpart C Section 15.247

Frequency Range (MHz)	Quantity of Hopping Channel	LIMIT(W)			
		50	25	15	75

902-928	1(30dBm)	0.125(21dBm)	NA	NA
2400-2483.5	NA	NA	0.125(21dBm)	1(30dBm)
5725-5850	NA	NA	NA	1(30dBm)

(6) Band edge

FCC Part15, Subpart C Section 15.247, In any 100kHz bandwidth outside the frequency band in with the spread spectrum intentional radiator is operating, the radio frequency power that is produced by the intentional radiator shall be at least 20dB below that in the 100kHz bandwidth within the band that contains the highest level of the desired power, based on either an RF conducted or a radiated measurement, attenuation below the general limits specified in section 15.209(a) is not required. In addition, radiated emissions which fall in the restricted bands, as defined in section 15.205(a), must also comply with the radiated emission limits specified in section 15.209(a).

Operating Frequency Range(MHz)	Spurious emission frequency	Limit Peak power ration to emission(dBc)	Emission level(dBuV/m)
902-928	<902	>20	NA
	>928	>20	NA
	960-1240	NA	54
2400-2483.5	<2400	>20	NA
	>2483.5-2500	NA	54
5725-5850	<5350-5460	NA	54
	<5725	>20	NA
	>5850	>20	NA

(7) Conducted Emission

Frequency(MHz)	Quasi-peak	Average
0.15-0.5	66-56	56-46
0.5-5.0	56	46
5.0-30.0	60	50

Note:

1. The lower limit shall apply at the transition frequencies
2. The limit decreases in line with the logarithm of the frequency in the range of 0.15 to 0.50MHz.

(8) Radiated Emission

FCC Part 15, Subpart C Section 15.209 limit of radiated emission for frequency below 1000GHz. The emissions from an intentional radiator shall not exceed the field strength level specified in the following table:

Frequency (MHz)	Field strength $\mu\text{V/m}$	Distance(m)	Field strength at 3m $\text{dB}\mu\text{V/m}$
0.009~0.490	2400/F(KHz)	300	See the remark
0.490~1.705	2400/F(KHz)	30	

1.705~30.0	30	30	
30-88	100	3	40
88-216	150	3	43.5
216-960	200	3	46
Above 960	500	3	54

Remark 1. Emission level in dBuV/m=20 log (uV/m)
 : 2. Measurement was performed at an antenna to the closed point of EUT distance of meters.
 3. Distance extrapolation factor =40log(Specific distance/ test distance)(dB);
 Limit line=Specific limits(dBuV) + distance extrapolation factor.

2.5 Configuration of Tested System

Fig. 2-1 Configuration of Tested System

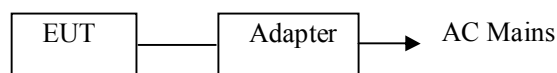



Table 2-1 Equipment Used in Tested System

Item	Equipment	Mfr/Brand	Model/Type No.	FCC ID	Series No.	Note
1.	UHF RFID Reader	 远望谷	XC2903	TQ4XC2903	N/A	EUT
2.	Adapter	N/A	FSP020-DGAA1	N/A	N/A	

Note:

(1) Unless otherwise denoted as EUT in 『Remark』 column, device(s) used in tested system is a support equipment.

2.6 Description of test modes

The EUT (UHF RFID Reader) has been tested under normal operating condition. EUT is a composite System, this Report Records RFID function test data. We use INVENGO to control the EUT, Let EUT hopping on and transmit with highest power. 50 Channels are provided by EUT. The 3 channels of lower, medium and higher were Chosen for test.

Channel	Frequency(MHz)
The Low Channel	902.75
The Middle Channel	915.25
The high Channel	927.25

3. Summary of Test Results

FCC Rule	Description Of Test	Result
15.247(a)(1)	Channel Separation test	PASS
15.247(a)(1)	20dB Bandwidth	PASS
15.247(a)(1)	Quantity of Hopping Channel	PASS
15.247(a)(1)	Time of Occupancy (Dwell Time)	PASS
15.247(b)(1)	Max Peak output Power test	PASS
15.247(d)	Band edge test	PASS
15.207	AC Power Conducted Emission	PASS
15.247(d)	Radiated Emission	PASS
§15.247(d)	Antenna Port Emission	PASS
15.203&15.247(b)	Antenna Application	PASS

4. Conducted Emissions Test

4.1 Measurement Procedure:

1. The EUT was placed on a table which is 0.8m above ground plane.
2. Maximum procedure was performed on the six highest emissions to ensure EUT compliance.
3. Repeat above procedures until all frequency measured were complete.

4.2 Test SET-UP (Block Diagram of Configuration)

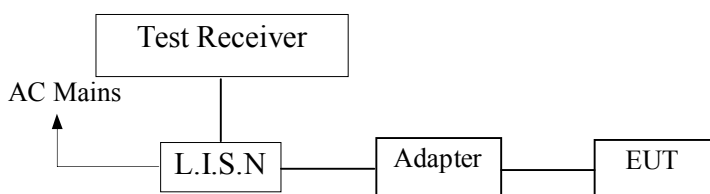

4.3 Measurement Equipment Used:

Conducted Emission Test Site # 4					
EQUIPMENT TYPE	MFR	MODEL NUMBER	SERIAL NUMBER	LAST CAL.	CAL DUE.
Test Receiver	Rohde & Schwarz	ESCS30	828985/018	05/29/2013	05/28/2014
L.I.S.N	Rohde & Schwarz	ESH2-Z5	834549/005	05/29/2013	05/28/2014
50Ω Coaxial Switch	Anritsu	MP59B	M20531	05/29/2013	05/28/2014

4.4 Conducted Emission Limit

(7) Conducted Emission

Frequency(MHz)	Quasi-peak	Average
0.15-0.5	66-56	56-46
0.5-5.0	56	46
5.0-30.0	60	50

Note:

1. The lower limit shall apply at the transition frequencies
2. The limit decreases in line with the logarithm of the frequency in the range of 0.15 to 0.50MHz.

4.5 Measurement Result:

Date of Test: March 17, 2014 Temperature: 24°C
 Frequency Detector: 0.15~30MHz Humidity: 53%
 Test Result: PASS Test Mode: RFID Mode

Test Line	Frequency MHz	Emission Level QP dB(μV)	Emission Level AV dB(μV)	Limits QP dB(μV)	Limits AV dB(μV)	Margin QP dB(μV)	Margin AV dB(μV)
Line	0.15	62.50	36.74	66.00	56.00	-3.50	-19.26
	0.16	60.00	36.06	65.52	55.52	-5.52	-19.46
	0.18	55.90	33.54	64.49	54.49	-8.59	-20.95
	0.46	39.22	21.38	56.69	46.69	-17.47	-25.31
	3.85	30.57	11.95	56.00	46.00	-25.43	-34.05
	23.23	29.22	19.60	60.00	50.00	-30.78	-30.40
Neutral	0.15	62.70	39.02	66.00	56.00	-3.30	-16.98
	0.17	53.60	32.92	64.96	54.96	-11.36	-22.04
	0.22	53.61	31.67	63.01	53.01	-9.40	-21.34
	0.46	35.99	18.55	56.69	46.69	-20.70	-28.14
	3.86	29.93	9.85	56.00	46.00	-26.07	-36.15
	23.75	27.28	15.96	60.00	50.00	-32.72	-34.04

5. Radiated Emission Test

5.1 Measurement Procedure

1. The EUT was placed on a turn table which is 0.8m above ground plane.
2. Maximum procedure was performed on the six highest emissions to ensure EUT compliance.
3. And also, each emission was to be maximized by changing the polarization of receiving antenna both horizontal and vertical.
4. Repeat above procedures until all frequency measured was complete.

When spectrum scanned from 30 MHz to 1GHz setting resolution bandwidth 100 kHz and video bandwidth 300kHz. And spectrum scanned above 1GHz setting resolution bandwidth 1MHz, video bandwidth 10Hz.

5.2 Test SET-UP (Block Diagram of Configuration)

(A) Radiated Emission Test Set-Up, Frequency Below 30MHz

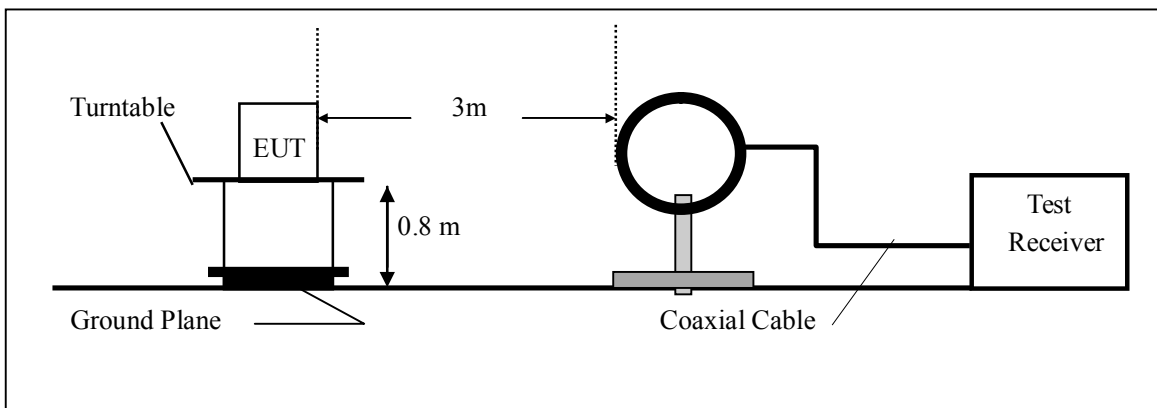

(B) Radiated Emission Test Set-Up, Frequency Below 1000MHz

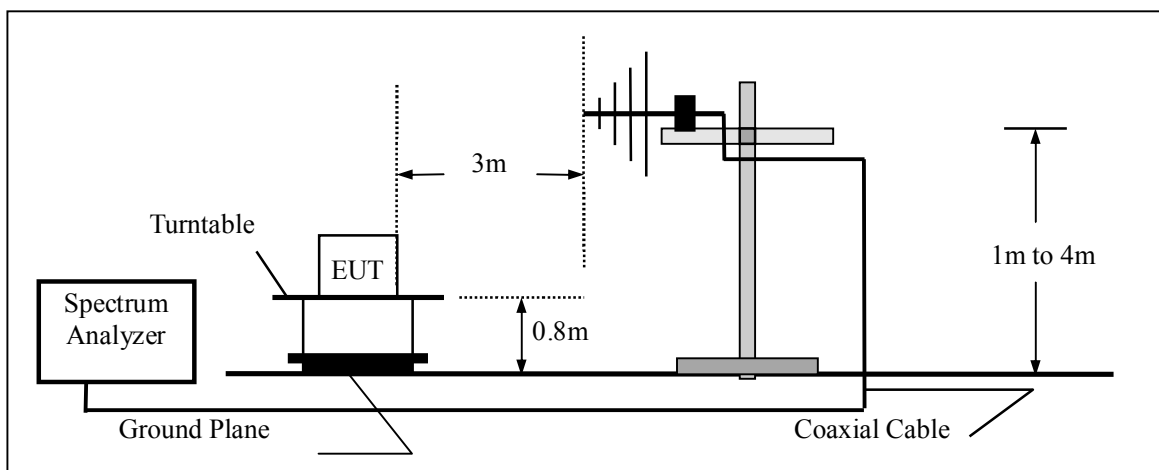

(C) Radiated Emission Test Set-Up, Frequency above 1000MHz

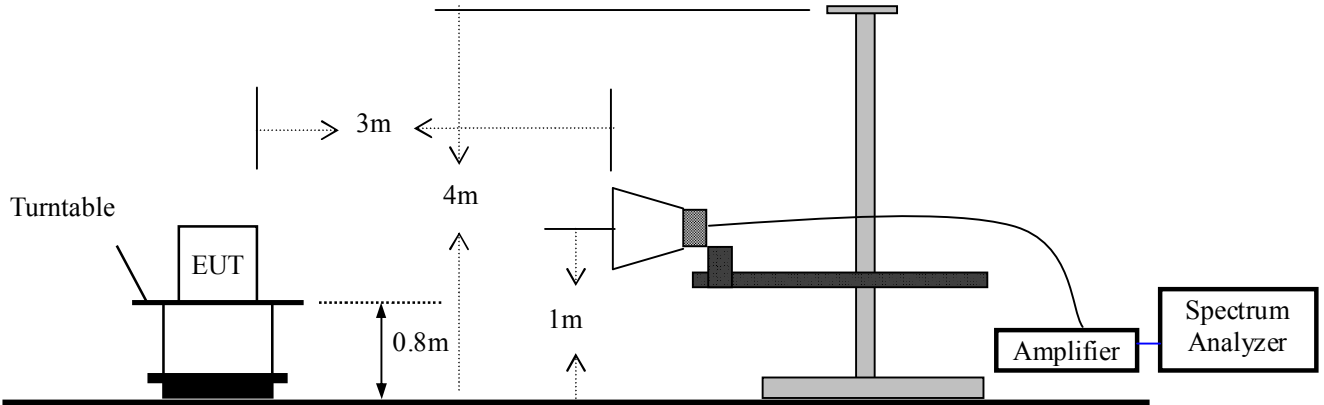

5.3 Measurement Equipment Used:

EQUIPMENT TYPE	MFR	MODEL NUMBER	SERIAL NUMBER	LAST CAL.	CAL DUE.
Spectrum Analyzer	Rohde & Schwarz	FSP7	839511/010	05/29/2013	05/28/2014
Spectrum Analyzer	HP	E4407B	839840481	05/29/2013	05/28/2014
EMI Test Receiver	Rohde & Schwarz	ESCS30	828985/018	05/29/2013	05/28/2014
Pre-Amplifier	HP	8447D	2944A07999	05/29/2013	05/28/2014
Bilog Antenna	Schwarzbeck	VULB9163	142	05/15/2013	05/14/2014
Loop Antenna	ARA	PLA-1030/B	1029	05/15/2013	05/14/2014
Horn Antenna	Schwarzbeck	BBHA 9170	BBHA9170399	05/15/2013	05/14/2014
Horn Antenna	Schwarzbeck	BBHA 9120	D143	05/15/2013	05/14/2014

5.4 Radiated Emission Limit

The emissions from an intentional radiator shall not exceed the field strength levels specified in the following table 15.209(a):

Frequencies (MHz)	Field Strength (micровolts/meter)	Measurement Distance (meters)
0.009~0.490	2400/F(KHz)	300
0.490~1.705	24000/F(KHz)	30
1.705~30.0	30	30
30~88	100	3
88~216	150	3
216~960	200	3
Above 960	500	3

15.205 Restricted bands of operation

MHz	MHz	MHz	GHz
0.090 - 0.110	16.42 - 16.423	399.9 - 410	4.5 - 5.15
¹ 0.495 - 0.505	16.69475 - 16.69525	608 - 614	5.35 - 5.46
2.1735 - 2.1905	16.80425 - 16.80475	960 - 1240	7.25 - 7.75
4.125 - 4.128	25.5 - 25.67	1300 - 1427	8.025 - 8.5
4.17725 - 4.17775	37.5 - 38.25	1435 - 1626.5	9.0 - 9.2
4.20725 - 4.20775	73 - 74.6	1645.5 - 1646.5	9.3 - 9.5
6.215 - 6.218	74.8 - 75.2	1660 - 1710	10.6 - 12.7
6.26775 - 6.26825	108 - 121.94	1718.8 - 1722.2	13.25 - 13.4
6.31175 - 6.31225	123 - 138	2200 - 2300	14.47 - 14.5
8.291 - 8.294	149.9 - 150.05	2310 - 2390	15.35 - 16.2
8.362 - 8.366	156.52475 - 156.52525	2483.5 - 2500	17.7 - 21.4
8.37625 - 8.38675	156.7 - 156.9	2690 - 2900	22.01 - 23.12
8.41425 - 8.41475	162.0125 - 167.17	3260 - 3267	23.6 - 24.0
12.29 - 12.293	167.72 - 173.2	3332 - 3339	31.2 - 31.8
12.51975 - 12.52025	240 - 285	3345.8 - 3358	36.43 - 36.5
12.57675 - 12.57725	322 - 335.4	3600 - 4400	(²)

- Remark 1. Emission level in dBuV/m=20 log (uV/m)
 : 2. Measurement was performed at an antenna to the closed point of EUT distance of meters.
 3. Only spurious frequency is permitted to locate within the Restricted Bands specified in provision of § 15.205, and the emissions located in restricted bands also comply with 15.209 limit.

5.4 Measurement Result

All the modes were tested and the data of the worst mode are recorded in the following pages.

Operation Mode: TX Mode Test Date : March 17, 2014
 Frequency Range: 0.009~30MHz Temperature : 24℃
 Test Result: PASS Humidity : 53 %
 Measured Distance: 3m Test By: KK

Freq. (MHz)	Ant.Pol. H/V	Emission Level (dBuV/m)	Limit 3m (dBuV/m)	Over (dB)
--	--	--	--	--

Note: the amplitude of spurious emission that is attenuated by more than 20dB below the permissible limit has no need to be reported.

Distance extrapolation factor =40log(Specific distance/ test distance)(dB);

Limit line=Specific limits(dBuV) + distance extrapolation factor.

Operation Mode: Low CH(902.75MHz) Test Date : March 17, 2014
 Frequency Range: 30~1000MHz Temperature : 24℃
 Test Result: PASS Humidity : 53 %
 Measured Distance: 3m Test By: KK

Freq. (MHz)	Ant.Pol. H/V	Emission Level (dBuV/m)	Limit 3m (dBuV/m)	Margin (dB)	Note
176.12	V	26.48	43.50	-17.02	QP
219.65	V	27.57	46.00	-18.43	QP
253.85	V	34.16	46.00	-11.84	QP
297.37	V	32.48	46.00	-13.52	QP
429.50	V	27.25	46.00	-18.75	QP
605.16	V	34.02	46.00	-11.98	QP
213.43	H	32.59	43.50	-10.91	QP
253.85	H	41.87	46.00	-4.13	QP
292.71	H	33.18	46.00	-12.82	QP
409.30	H	30.09	46.00	-15.91	QP
658.01	H	40.65	46.00	-5.35	QP
667.34	H	38.77	46.00	-7.23	QP

- Note:**
- (1) All Readings are Peak Value.
 - (2) Emission Level= Reading Level+Probe Factor +Cable Loss.
 - (3) The average measurement was not performed when the peak measured data under the limit of average detection.
 - (4) EUT stood on the table position is the worst case result in the report.

Operation Mode: Mid CH(915.25MHz) Test Date : March 17, 2014
 Frequency Range: 30~1000MHz Temperature : 24°C
 Test Result: PASS Humidity : 53 %
 Measured Distance: 3m Test By: KK

Freq. (MHz)	Ant.Pol. H/V	Emission Level (dBuV/m)	Limit 3m (dBuV/m)	Margin (dB)	Note
177.24	V	27.20	43.50	-16.30	QP
220.77	V	28.29	46.00	-17.71	QP
254.97	V	34.88	46.00	-11.12	QP
298.49	V	33.20	46.00	-12.80	QP
430.62	V	27.97	46.00	-18.03	QP
606.28	V	34.74	46.00	-11.26	QP
214.55	H	33.31	43.50	-10.19	QP
254.97	H	42.59	46.00	-3.41	QP
293.83	H	33.90	46.00	-12.10	QP
410.42	H	30.81	46.00	-15.19	QP
659.13	H	41.37	46.00	-4.63	QP
668.46	H	39.49	46.00	-6.51	QP

- Note:**
- (1) All Readings are Peak Value.
 - (2) Emission Level= Reading Level+Probe Factor +Cable Loss.
 - (3) The average measurement was not performed when the peak measured data under the limit of average detection.
 - (4) EUT stood on the table position is the worst case result in the report.

Operation Mode: High CH(927.25MHz) Test Date : March 17, 2014
 Frequency Range: 30~1000MHz Temperature : 24°C
 Test Result: PASS Humidity : 53 %
 Measured Distance: 3m Test By: KK

Freq. (MHz)	Ant.Pol. H/V	Emission Level (dBuV/m)	Limit 3m (dBuV/m)	Margin (dB)	Note
171.46	V	35.92	43.50	-7.58	QP
213.43	V	33.22	43.50	-10.28	QP
292.71	V	33.06	46.00	-12.94	QP
385.98	V	34.28	46.00	-11.72	QP
528.99	V	37.19	46.00	-8.81	QP
552.31	V	37.76	46.00	-8.24	QP
166.80	H	32.30	43.50	-11.20	QP
213.43	H	39.31	43.50	-4.19	QP
253.85	H	42.57	46.00	-3.43	QP
292.71	H	37.58	46.00	-8.42	QP
370.43	H	32.45	46.00	-13.55	QP
650.24	H	34.87	46.00	-11.13	QP

- Note:**
- (1) All Readings are Peak Value.
 - (2) Emission Level= Reading Level+Probe Factor +Cable Loss
 - (3) The average measurement was not performed when the peak measured data under the limit of average detection.
 - (4) All the x/y/z orientation has been investigated, and only worst case is presented in this report.

Operation Mode: Low CH(915.75MHz) Test Date : March 17, 2014
 Frequency Range: 1GHz~10GHz Temperature : 24℃
 Test Result: PASS Humidity : 53 %
 Measured Distance: 3m Test By: KK

Freq. (MHz)	Ant.Pol. H/V	Emission Level(dBuV/m)		Limit 3m(dBuV/m)		Margin(dB)	
		PK	AV	PK	AV	PK	AV
1805.50	V	45.03	26.41	74.00	54.00	-28.97	-27.59
2708.25	V	45.37	27.40	74.00	54.00	-28.63	-26.60
3611.00	V	50.32	32.25	74.00	54.00	-23.68	-21.75
4513.75	V	51.35	33.64	74.00	54.00	-22.65	-20.36
5416.50	V	51.80	34.08	74.00	54.00	-22.20	-19.92
6319.25	V	51.62	34.60	74.00	54.00	-22.38	-19.40
1805.50	H	50.19	32.17	74.00	54.00	-23.81	-21.83
2708.25	H	47.02	29.62	74.00	54.00	-26.98	-24.38
3611.00	H	49.91	31.00	74.00	54.00	-24.09	-23.00
4513.75	H	51.93	34.00	74.00	54.00	-22.07	-20.00
5416.50	H	51.28	32.61	74.00	54.00	-22.72	-21.39
6319.25	H	53.03	35.63	74.00	54.00	-20.97	-18.37

All emissions not reported were more than 20dB below the specified limit or in the noise floor.

- Note:**
- (1) All Readings are Peak Value and AV.
 - (2) Emission Level= Reading Level+Probe Factor +Cable Loss.
 - (3) Data of measurement within this frequency range shown “ -- ” in the table above means the reading of emissions are attenuated more than 20dB below the permissible limits or the field strength is too small to be measured.

Operation Mode: Mid CH(915.25MHz) Test Date : March 17, 2014
 Frequency Range: 1GHz~10GHz Temperature : 24℃
 Test Result: PASS Humidity : 53 %
 Measured Distance: 3m Test By: KK

Freq. (MHz)	Ant.Pol. H/V	Emission Level(dBuV/m)		Limit 3m(dBuV/m)		Margin(dB)	
		PK	AV	PK	AV	PK	AV
1830.50	V	48.05	31.08	74.00	54.00	-25.95	-22.92
2745.75	V	48.80	31.61	74.00	54.00	-25.20	-22.39
3661.00	V	48.79	30.32	74.00	54.00	-25.21	-23.68
4576.25	V	47.44	30.55	74.00	54.00	-26.56	-23.45
5491.50	V	48.23	30.00	74.00	54.00	-25.77	-24.00
6406.75	V	53.04	36.11	74.00	54.00	-20.96	-17.89
1830.50	H	44.58	26.36	74.00	54.00	-29.42	-27.64
2745.75	H	51.32	32.93	74.00	54.00	-22.68	-21.07
3661.00	H	52.44	34.03	74.00	54.00	-21.56	-19.97
4576.25	H	49.06	30.13	74.00	54.00	-24.94	-23.87
5491.50	H	46.60	28.92	74.00	54.00	-27.40	-25.08
6406.75	H	52.62	35.19	74.00	54.00	-21.38	-18.81

All emissions not reported were more than 20dB below the specified limit or in the noise floor.

- Note:**
- (1) All Readings are Peak Value and AV.
 - (2) Emission Level= Reading Level+Probe Factor +Cable Loss.
 - (3) Data of measurement within this frequency range shown " -- " in the table above means the reading of emissions are attenuated more than 20dB below the permissible limits or the field strength is too small to be measured.

Operation Mode: High CH(927.25MHz) Test Date : March 17, 2014
 Frequency Range: 1GHz~10GHz Temperature : 24℃
 Test Result: PASS Humidity : 53 %
 Measured Distance: 3m Test By: KK

Freq. (MHz)	Ant.Pol. H/V	Emission Level(dBuV/m)		Limit 3m(dBuV/m)		Margin(dB)	
		PK	AV	PK	AV	PK	AV
1854.50	V	52.34	33.82	74.00	54.00	-21.66	-20.18
2781.75	V	49.85	32.87	74.00	54.00	-24.15	-21.13
3709.00	V	49.86	32.46	74.00	54.00	-24.14	-21.54
4636.25	V	49.31	32.25	74.00	54.00	-24.69	-21.75
5563.50	V	49.49	30.89	74.00	54.00	-24.51	-23.11
6490.75	V	53.34	36.15	74.00	54.00	-20.66	-17.85
1854.50	H	42.79	25.14	74.00	54.00	-31.21	-28.86
2781.75	H	44.46	25.84	74.00	54.00	-29.54	-28.16
3709.00	H	52.06	33.83	74.00	54.00	-21.94	-20.17
4636.25	H	48.67	31.32	74.00	54.00	-25.33	-22.68
5563.50	H	53.33	34.79	74.00	54.00	-20.67	-19.21
6490.75	H	51.95	35.02	74.00	54.00	-22.05	-18.98

- Note:**
- (1) All Readings are Peak Value and AV.
 - (2) Emission Level= Reading Level+Probe Factor +Cable Loss
 - (3) Data of measurement within this frequency range shown " -- " in the table above means the reading of emissions are attenuated more than 20dB below the permissible limits or the field strength is too small to be measured.
 - (4) All the x/y/z orientation has been investigated, and only worst case is presented in this report.

6. Channel Separation test

6.1 Measurement Procedure

The EUT was operating in hopping mode or could be controlled its channel. Printed out the test result from the spectrum by hard copy function.

6.2 Test SET-UP (Block Diagram of Configuration)

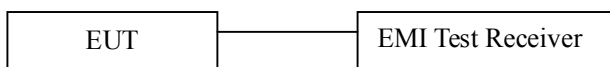

6.3 Measurement Equipment Used:

EQUIPMENT TYPE	MFR	MODEL NUMBER	SERIAL NUMBER	LAST CAL.	CAL DUE.
Spectrum Analyzer	Agilent	E4407B	88156318	05/29/2013	05/28/2014

6.4 Measurement Results:

The following table is the setting of spectrum analyzer.

EMI Test Receiver	Setting
Attenuation	Auto
RB	100kHz
VB	300kHz
Detector	Peak
Trace	Max hold

Refer to attached data chart.

Spectrum Detector: PK Test Date : February 27, 2014
 Test By: DK Temperature : 24°C
 Test Result: PASS Humidity : 53 %

Channel number	Channel frequency (MHz)	Separation Read Value (kHz)	Separation Limit 20dB Down BW(kHz)
1	902.75	500	>360.978
26	915.25	500	>359.806
50	927.25	500	>358.283

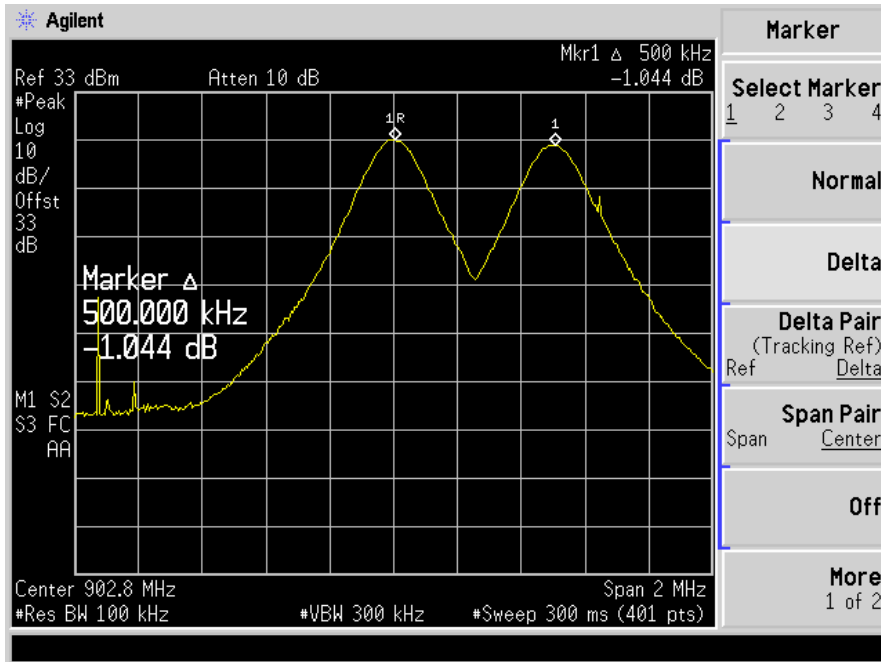

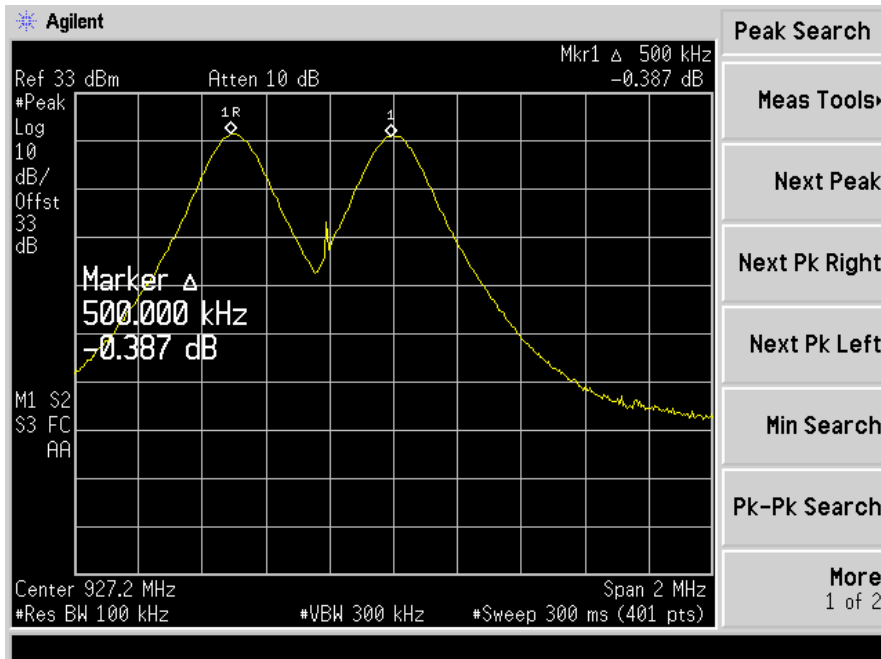
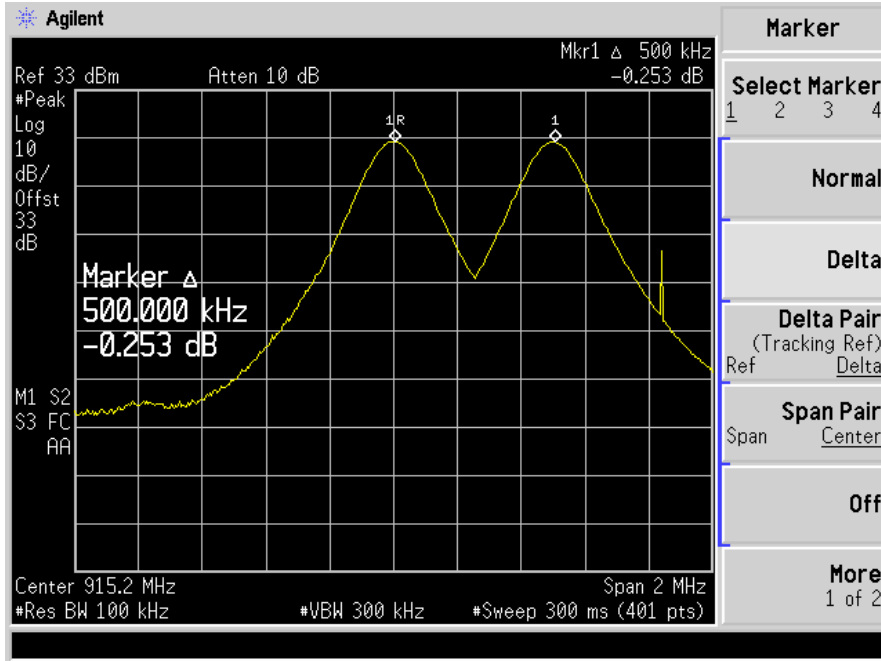

7. Bandwidth test

7.1 Measurement Procedure

The EUT was operating in hopping mode or could be controlled its channel. Printed out the test result from the spectrum by hard copy function.

7.2 Test SET-UP (Block Diagram of Configuration)

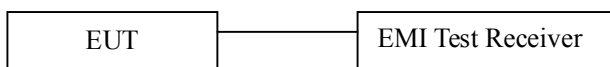

7.3 Measurement Equipment Used:

EQUIPMENT TYPE	MFR	MODEL NUMBER	SERIAL NUMBER	LAST CAL.	CAL DUE.
Spectrum Analyzer	Agilent	E4407B	88156318	05/29/2013	05/28/2014

7.4 Measurement Results:

EMI Test Receiver	Setting
Attenuation	Auto
Span	2MHz
RB	100KHz
VB	300KHz
Detector	Peak
Trace	Max hold

7.4.1. 20dB Bandwidth test data Chart:

Refer to attached data chart.

Spectrum Detector: PK Test Date: February 27, 2014
 Test By: DK Temperature: 24°C
 Test Result: PASS Humidity: 53 %

Channel number	Channel frequency (MHz)	20dB Down BW(kHz)
1	902.75	360.978
26	915.25	359.806
50	927.25	358.283

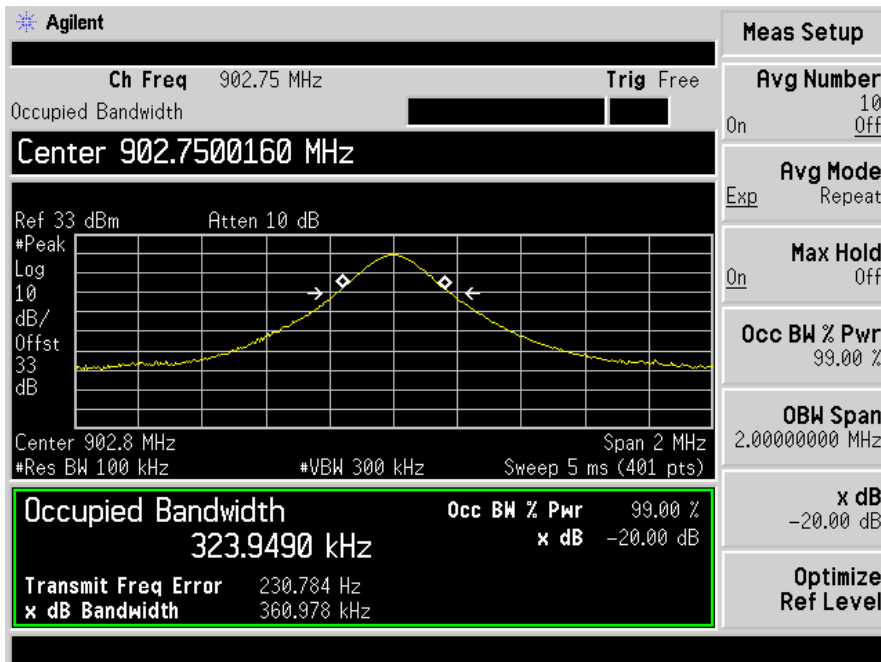

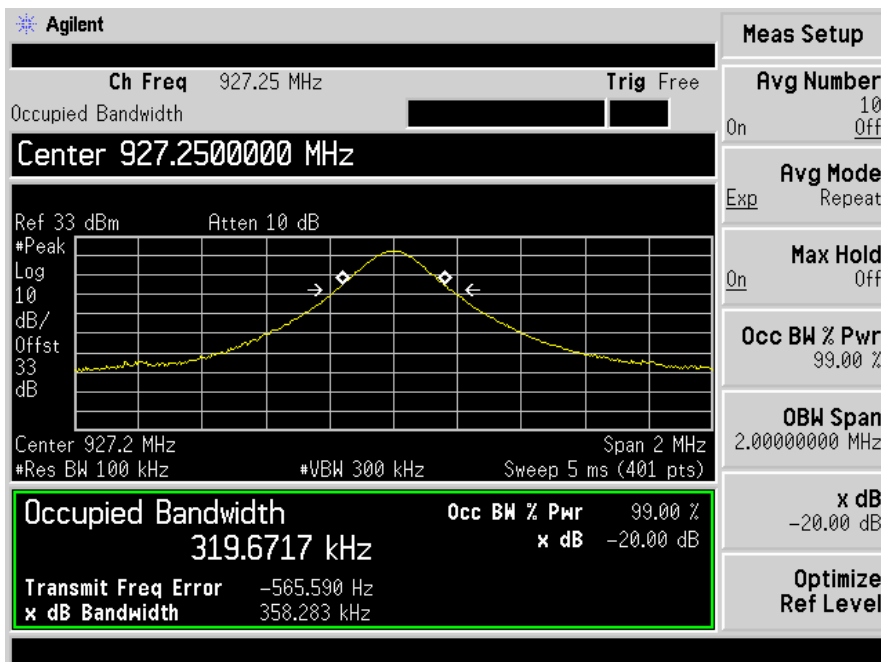
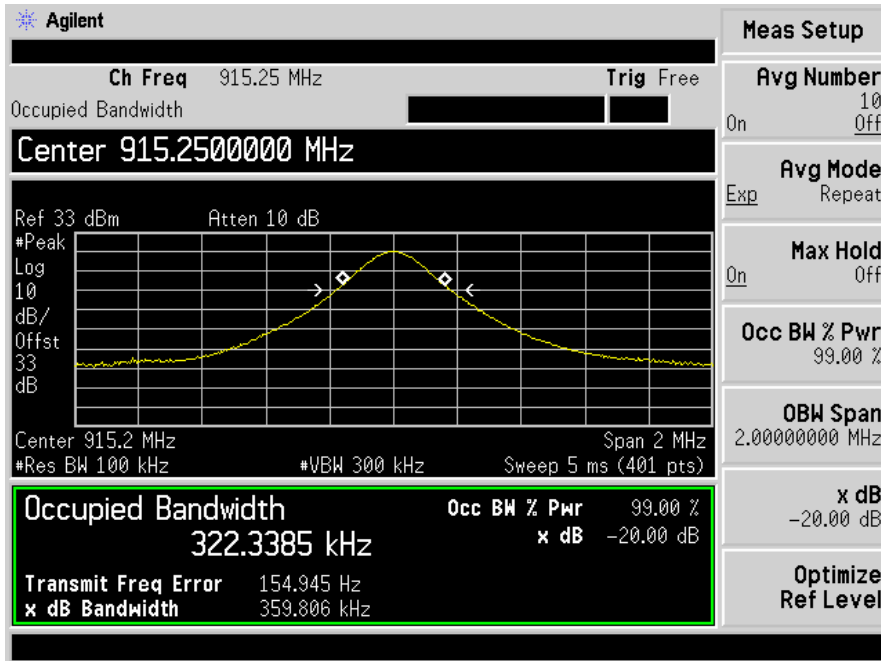

8. Quantity of Hopping Channel Test

8.1 Measurement Procedure

The EUT was operating in hopping mode or could be controlled its channel. Printed out the test result from the spectrum by hard copy function.

8.2 Test SET-UP (Block Diagram of Configuration)

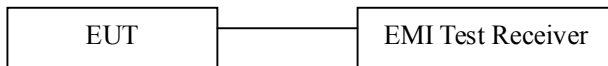

8.3 Measurement Equipment Used:

EQUIPMENT TYPE	MFR	MODEL NUMBER	SERIAL NUMBER	LAST CAL.	CAL DUE.
Spectrum Analyzer	Agilent	E4407B	88156318	05/29/2013	05/28/2014

8.4 Measurement Results:

Spectrum Detector: PK Test Date : February 27, 2014
 Test By: DK Temperature : 24 °C
 Test Result: PASS Humidity : 53 %

Hopping Channel Frequency Range	Quantity of Hopping Channel	Quantity of Hopping Channel limit
902.75-927.25	50	> 15

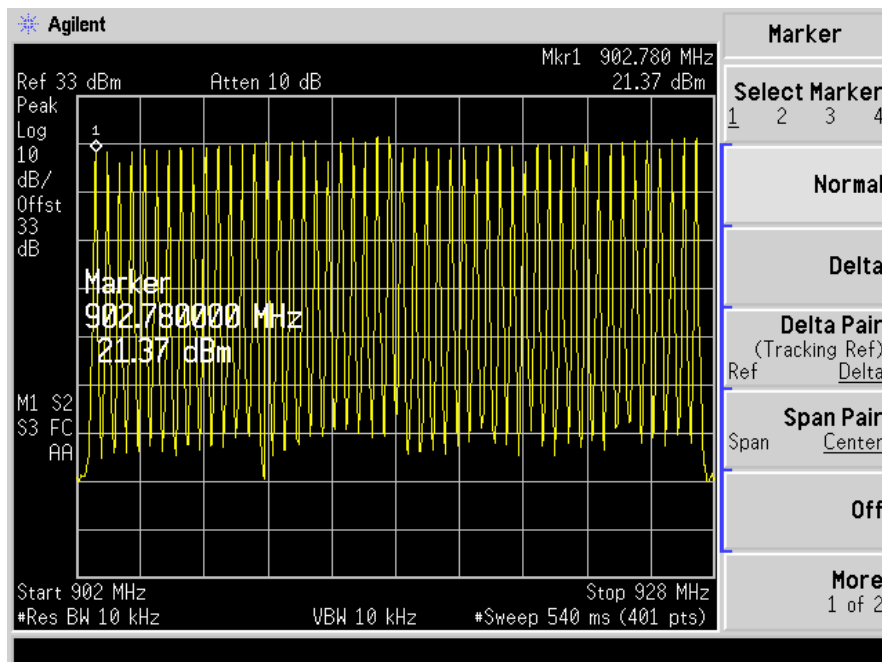

9. Time of Occupancy (Dwell Time) test

Test Method

1. Connect EUT antenna terminal to the spectrum analyzer with a low loss cable.
 Equipment mode: Spectrum analyzer
 RBW: 100kHz; VBW: 300kHz; SPAN: Zero Span
2. Adjust the center frequency of spectrum analyzer on any frequency be measured.
3. Measure the Dwell Time by spectrum analyzer Marker function.
4. Repeat above procedures until all frequencies measured were complete.

Limit

According to 15.247(a)(1)(i), if the 20 dB bandwidth of the hopping channel is 250 kHz or greater, the system shall use at least 25 hopping frequencies and the average time of occupancy on any frequency shall not be greater than 0.4 seconds within a 10 second period.

9.2 Test SET-UP (Block Diagram of Configuration)

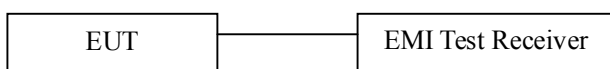

9.3 Measurement Equipment Used:

EQUIPMENT TYPE	MFR	MODEL NUMBER	SERIAL NUMBER	LAST CAL.	CAL DUE.
EMI Test Receiver	Rohde & Schwarz	ESU	1302.6005.26	05/29/2013	05/28/2014

9.4 Measurement Results:

Spectrum Detector: PK	Test Date :	February 27, 2014
Test By: DK	Temperature :	24°C
Test Result: PASS	Humidity :	53 %

In 10 S total 3 times to be found, per transmitting time are

Dwell Time: $3 \times 17.2\text{ms} = 51.60\text{ms} < 0.4\text{S}$ (Limit)

Test result: Pass

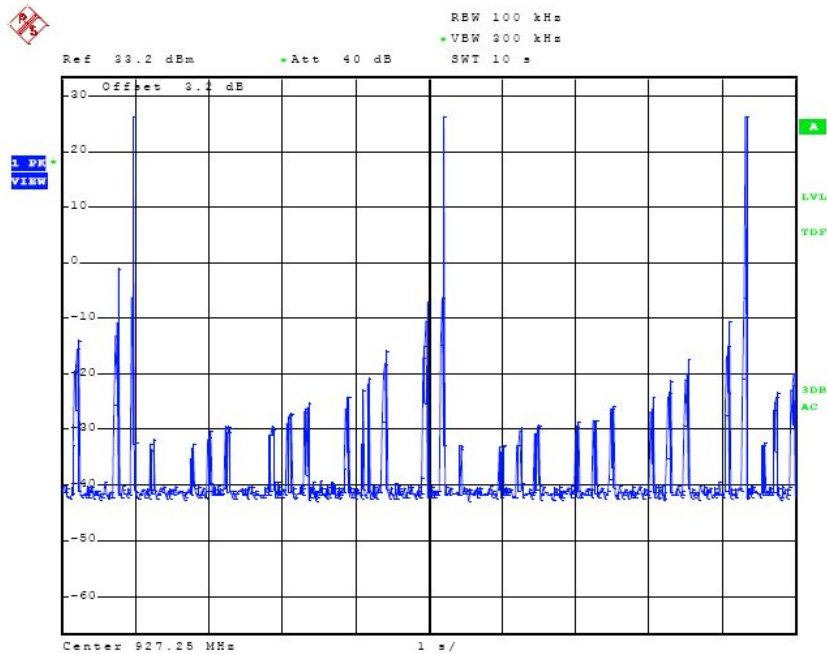
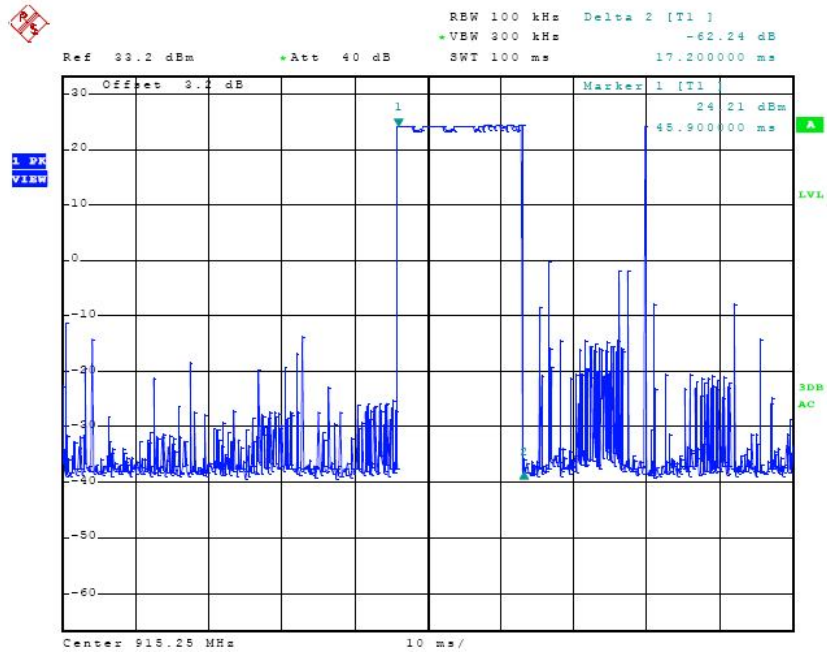

10. MAXIMUM PEAK OUTPUT POWER TEST

10.1 Measurement Procedure

- Check the calibration of the measuring instrument(RF Power Meter) using either an internal calibrator or a known signal from an external generator.
- Turn on the EUT and connect it to measurement instrument. Then set it to any one convenient frequency within its operating range. Set a reference level on the measuring instrument equal to the highest peak value.
- The center frequency of the spectrum analyzer is set to the fundamental frequency and using proper RBW and VBW setting.
- Measure the captured power within the band and recording the plot.
- Repeat above procedures until all frequencies required were complete.

10.2 Test SET-UP (Block Diagram of Configuration)

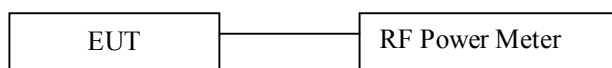

10.3 Measurement Equipment Used:

EQUIPMENT TYPE	MFR	MODEL NUMBER	SERIAL NUMBER	LAST CAL.	CAL DUE.
Power meter	Boonton	4232A	29001	05/29/2013	05/28/2014
Power sensor	Boonton	51011-EMC	31184	05/29/2013	05/28/2014

10.4 Measurement Results:

Spectrum Detector: PK Test Date : February 27, 2014
 Test By: DK Temperature : 24°C
 Test Result: PASS Humidity : 53 %
 Modulation: ASK

Channel number	Channel Frequency (MHz)	Peak Power output(dBm)	Peak Power output(W)	Peak Power Limit(W)	Pass/Fail
1	902.75	26.48	0.4446	1.00	PASS
26	915.25	26.31	0.4276	1.00	PASS
50	927.25	26.52	0.4487	1.00	PASS

11. Band EDGE test

11.1 Measurement Procedure

1. The EUT was Operating in hopping mode or could be controlled its channel. Printed out test result from the spectrum by hard copy function.
2. The EUT was placed on a turn table which is 0.8m above ground plane.
3. Maximum procedure was performed on the six highest emissions to ensure EUT compliance.
4. And also, each emission was to be maximized by changing the polarization of receiving antenna both horizontal and vertical.
5. Repeat above procedures until all frequency measured were complete.

11.2 Test SET-UP (Block Diagram of Configuration)

As 5.2 Test set up (B) and (C)

11.3 Measurement Equipment Used:

Same as 5.3 Radiated Emission Measurement.

11.4 Measurement Results:

All the modes were tested

Spectrum Detector:	PK/AV	Test Date :	February 27, 2014
Test By:	DK	Temperature :	24°C
Test channel:	01	Humidity :	53 %
Channel Number	902.75MHz		

Frequency (MHz)	Polarity	Level (dBuV/m)		Limited (dBuV/m)	
		PK	AV	PK	AV
902.00	H	48.83	35.34	74	54
902.00	V	49.37	36.42	74	54

Spectrum Detector:	PK/AV	Test Date :	February 27, 2014
Test By:	DK	Temperature :	24°C
Test channel:	50	Humidity :	53 %
Channel Number	927.25 MHz		

Frequency (MHz)	Polarity	Level (dBuV/m)		Limited (dBuV/m)	
		PK	AV	PK	AV
928.00	H	51.28	38.41	74	54
928.00	V	50.39	37.29	74	54

Spectrum Detector: PK/AV Test Date : February 27, 2014
 Test By: Joe Temperature : 24 °C
 Mode: Hopping mode Humidity : 53 %

Frequency (MHz)	Polarity	Level (dBuV/m)		Limited (dBuV/m)	
		PK	AV	PK	AV
902	H	48.31	37.91	74	54
902	V	46.52	36.37	74	54
928	H	49.45	38.45	74	54
928	V	46.92	35.51	74	54

12. Antenna Port Emission

12.1 Test Equipment

EQUIPMENT TYPE	MFR	MODEL NUMBER	SERIAL NUMBER	LAST CAL.	CAL DUE.
Spectrum Analyzer	Agilent	E4407B	88156318	05/29/2013	05/28/2014

12.2 Measuring Instruments and setting

The following table is the setting of spectrum analyzer.

EMI Test Receiver	Setting
Attenuation	Auto
RB	100kHz
VB	300kHz
Detector	Peak
Trace	Max hold

12.3 Test Procedures

The conducted spurious emissions were measured conducted using a spectrum analyzer at low, mid, and hi channels, The limit was determined by attenuation 20dB of the RF peak power output.

12.4 Block Diagram of Test setup

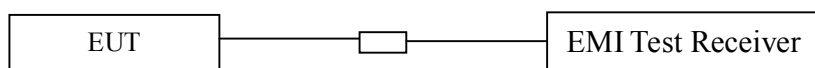

12.5 Test Result

PASS.

TX 902.75MHz

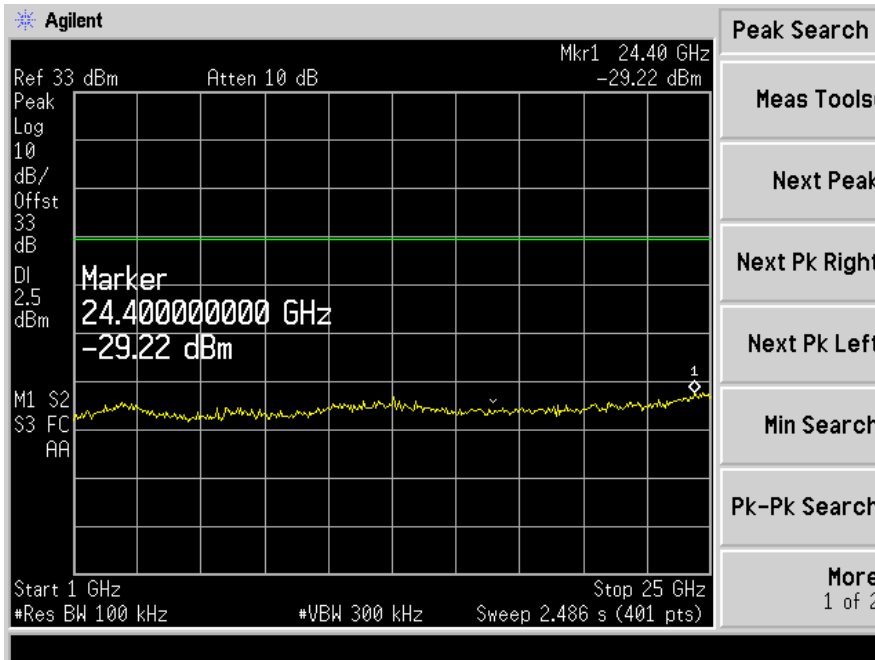
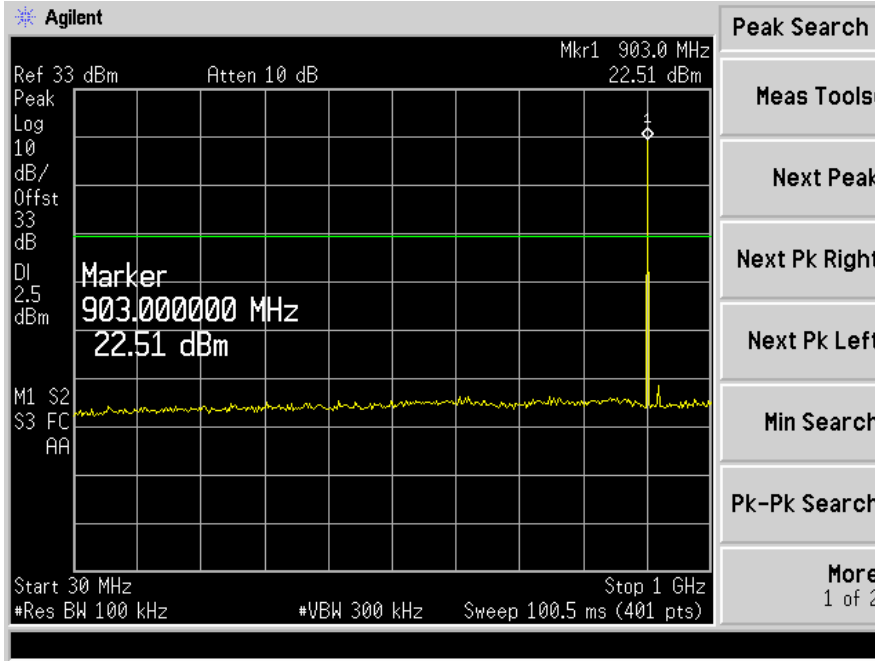

TX 912.25MHz

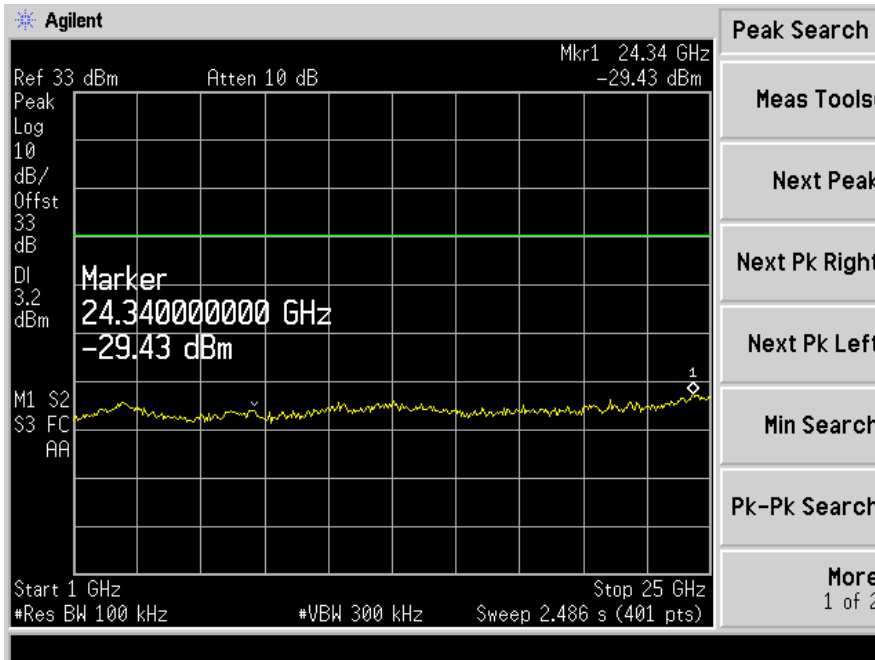
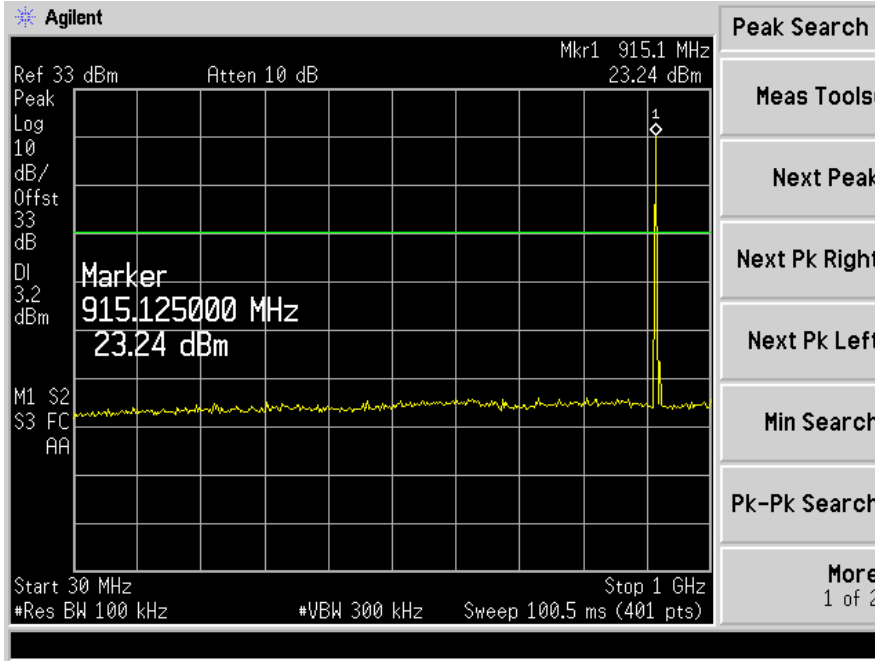

TX 927.25MHz

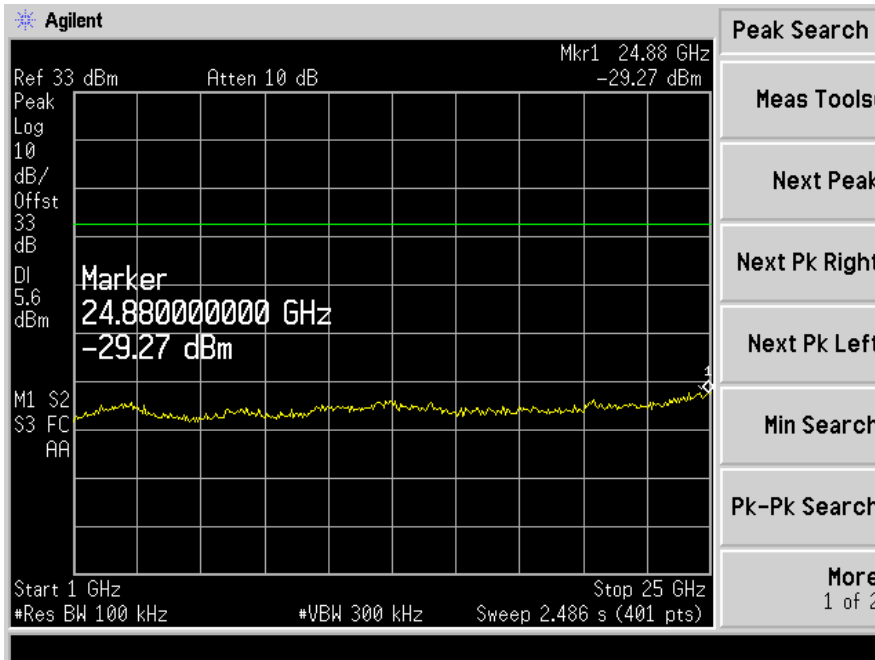
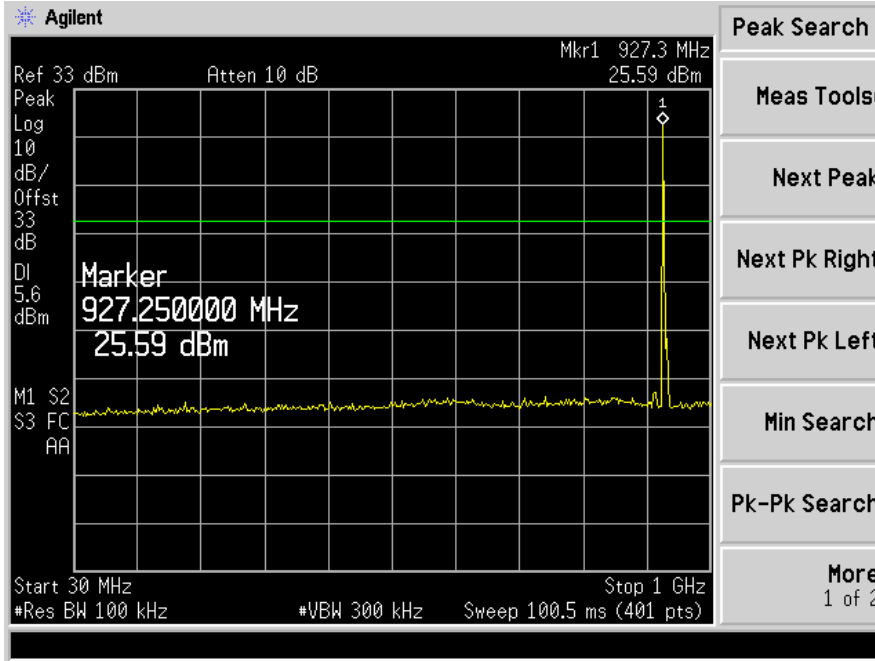

13. Antenna Application

13.1 Antenna Requirement

For intentional device, according to FCC 47 CFR Section 15.203, an intentional radiator shall be designed to ensure that no antenna other than that furnished by the responsible party shall be used with the device. And according to FCC 47 CFR Section 15.247 (b)(4), if transmitting antennas of directional gain greater than 6dBi are used, the power shall be reduced by the amount in dB that the directional gain of the antenna exceeds 6dBi. (4) The conducted output power limit specified in paragraph (b) of this section is based on the use of antennas with directional gains that do not exceed 6 dBi. Except as shown in paragraph (c) of this section, if transmitting antennas of directional gain greater than 6 dBi are used, the conducted output power from the intentional radiator shall be reduced below the stated values in paragraphs (b)(1), (b)(2), and (b)(3) of this section, as appropriate, by the amount in dB that the directional gain of the antenna exceeds 6 dBi.

13.2 Result

The EUT'S antenna is Specific External Antenna. The antenna's gain for RFID is 1dBi and meets the requirement.