

FCC 47 CFR PART 15 SUBPART C

CERTIFICATION TEST REPORT

For

Handheld Reader

MODEL No.: XC2600

FCC ID: TQ4XC2600

Trademark  Invengo

REPORT NO.: ES180207008W01

ISSUE DATE: March 13, 2018

Prepared for

Invengo Information Technology co.,Ltd.

3/F, No.T2-B,High-tech industrial Park South, Shenzhen 518057,china

Prepared by

EMTEK(SHENZHEN) CO., LTD.

Bldg 69, Majialong Industry Zone, Nanshan District, Shenzhen, Guangdong,
China

TEL: 86-755-26954280

FAX: 86-755-26954282

Table of Contents

1	TEST RESULT CERTIFICATION	3
2	EUT TECHNICAL DESCRIPTION	4
3	SUMMARY OF TEST RESULT.....	5
4	TEST METHODOLOGY	6
4.1	GENERAL DESCRIPTION OF APPLIED STANDARDS.....	6
4.2	MEASUREMENT EQUIPMENT USED.....	6
4.3	DESCRIPTION OF TEST MODES	7
5	FACILITIES AND ACCREDITATIONS	8
5.1	FACILITIES	8
5.2	LABORATORY ACCREDITATIONS AND LISTINGS.....	8
6	TEST SYSTEM UNCERTAINTY	9
7	SETUP OF EQUIPMENT UNDER TEST.....	10
7.1	RADIO FREQUENCY TEST SETUP 1	10
7.2	RADIO FREQUENCY TEST SETUP 2.....	10
7.3	CONDUCTED EMISSION TEST SETUP.....	12
7.4	BLOCK DIAGRAM CONFIGURATION OF TEST SYSTEM.....	13
7.5	SUPPORT EQUIPMENT	13
8	TEST REQUIREMENTS.....	14
8.1	20DB BANDWIDTH.....	14
8.2	CARRIER FREQUENCY SEPARATION	17
8.3	NUMBER OF HOPPING FREQUENCIES	20
8.4	AVERAGE TIME OF OCCUPANCY (DWELL TIME).....	22
8.5	MAXIMUM PEAK CONDUCTED OUTPUT POWER.....	24
8.6	CONDUCTED SUPRIIOUS EMISSION.....	27
8.7	RADIATED SPURIOUS EMISSION	34
8.8	OUT OF BNAD EMISSIONS	44
8.9	CONDUCTED EMISSION TEST	50
8.10	ANTENNA APPLICATION.....	53

1 TEST RESULT CERTIFICATION

Applicant:	Invengo Information Technology co.,Ltd.
Address:	3/F, No.T2-B,High-tech industrial Park South, Shenzhen 518057,china
Manufacturer:	Invengo Information Technology co.,Ltd.
Address:	3/F, No.T2-B,High-tech industrial Park South, Shenzhen 518057,china
Product Description:	Handheld Reader
Model Number:	XC2600
Trademark:	 Invengo

Measurement Procedure Used:

APPLICABLE STANDARDS	
STANDARD	TEST RESULT
FCC 47 CFR Part 2, Subpart J FCC 47 CFR Part 15, Subpart C	PASS

The above equipment was tested by EMTEK(SHENZHEN) CO., LTD. The test data, data evaluation, test procedures, and equipment configurations shown in this report were made in accordance with the procedures given in ANSI C63.10 (2013) and the energy emitted by the sample EUT tested as described in this report is in compliance with the requirements of FCC Rules Part 2 and Part 15.247

The test results of this report relate only to the tested sample identified in this report

Date of Test : February 26, 2018 to March 09, 2018

Prepared by : Joanna Jiao
Joanna Jiao/Editor

Reviewer : Jack Li
Jack Li /Supervisor

Approve & Authorized Signer : 
Lisa Wang/Manager



2 EUT TECHNICAL DESCRIPTION

Characteristics	Description
Product :	Handheld Reader
Model Number :	XC2600
Modulation:	ASK
Operating Frequency :	902.75-927.25MHz
Number of Channels:	50
Transmit Power Max:	26.56dBm
Antenna Type :	Internal Antenna
Antenna Gain:	3 dBi
Power supply:	DC 5V for Adapter
Adapter :	Model : JHD-AP013U-050200BB-B Input : 100-240V,50/60Hz,0.35A Output : 5V,2.0A ,
Battery:	3.7V, 5200mAh
Temperature Range	-10°C ~ +60°C

Note: for more details, please refer to the User's manual of the EUT.

3 SUMMARY OF TEST RESULT

FCC Part Clause	Test Parameter	Verdict	Remark
15.247(a)(1)	20 dB Bandwidth	PASS	
15.247(a)(1)	Carrier Frequency Separation	PASS	
15.247(a)(1)	Number of Hopping Frequencies	PASS	
15.247(a)(1)	Average Time of Occupancy (Dwell Time)	PASS	
15.247(b)(1)	Maximum Peak Conducted Output Power	PASS	
15.247(c)	Conducted Spurious Emissions	PASS	
15.247(d) 15.209	Radiated Spurious Emissions	PASS	
15.207	Conducted Emission	PASS	
15.203	Antenna Application	PASS	
NOTE1: N/A (Not Applicable)			

RELATED SUBMITTAL(S) / GRANT(S):

This submittal(s) (test report) is intended for FCC ID:TQ4XC2600 filing to comply with Section 15.247 of the FCC Part 15, Subpart C Rules.

4 TEST METHODOLOGY

4.1 GENERAL DESCRIPTION OF APPLIED STANDARDS

According to its specifications, the EUT must comply with the requirements of the following standards:
 FCC 47 CFR Part 2, Subpart J
 FCC 47 CFR Part 15, Subpart C
 DA 00-705

4.2 MEASUREMENT EQUIPMENT USED

4.2.1 Conducted Emission Test Equipment

EQUIPMENT TYPE	MFR	MODEL NUMBER	SERIAL NUMBER	LAST CAL.
Test Receiver	Rohde & Schwarz	ESCS30	828985/018	May 20, 2017
L.I.S.N.	Schwarzbeck	NNLK8129	8129203	May 20, 2017
50Ω Coaxial Switch	Anritsu	MP59B	M20531	N/A
Pulse Limiter	Rohde & Schwarz	ESH3-Z2	100006	May 20, 2017
Voltage Probe	Rohde & Schwarz	TK9416	N/A	May 20, 2017
I.S.N	Rohde & Schwarz	ENY22	1109.9508.02	May 20, 2017

4.2.2 Radiated Emission Test Equipment

EQUIPMENT TYPE	MFR	MODEL NUMBER	SERIAL NUMBER	LAST CAL.
EMI Test Receiver	Rohde & Schwarz	ESU	1302.6005.26	May 20, 2017
Pre-Amplifier	HP	8447D	2944A07999	May 20, 2017
Bilog Antenna	Schwarzbeck	VULB9163	142	May 20, 2017
Loop Antenna	ARA	PLA-1030/B	1029	May 20, 2017
Horn Antenna	Schwarzbeck	BBHA 9170	BBHA9170399	May 20, 2017
Horn Antenna	Schwarzbeck	BBHA 9120	D143	May 20, 2017
Cable	Schwarzbeck	AK9513	ACRX1	May 21, 2017
Cable	Rosenberger	N/A	FP2RX2	May 21, 2017
Cable	Schwarzbeck	AK9513	CRPX1	May 21, 2017
Cable	Schwarzbeck	AK9513	CRRX2	May 21, 2017

4.2.3 Radio Frequency Test Equipment

EQUIPMENT TYPE	MFR	MODEL NUMBER	SERIAL NUMBER	LAST CAL.
Spectrum Analyzer	Agilent	E4407B	88156318	May 20, 2017
Power meter	Anritsu	ML2495A	0824006	May 20, 2017
Power sensor	Anritsu	MA2411B	0738172	May 20, 2017
Spectrum Analyzer	Agilent	N9010A	My53470879	May 20, 2017

Remark: Each piece of equipment is scheduled for calibration once a year.

4.3 DESCRIPTION OF TEST MODES

The EUT has been tested under its typical operating condition.

The EUT configuration for testing is installed on RF field strength measurement to meet the Commissions requirement and operating in a manner which intends to maximize its emission characteristics in a continuous normal application.

The Transmitter was operated in the normal operating mode. The TX frequency was fixed which was for the purpose of the measurements.

Test of channel included the lowest and middle and highest frequency to perform the test, then record on this report.

Those channels (902.75MHz, 914.75MHz, 927.25MHz) were used for all test.

Pre-defined engineering program for regulatory testing used to control the EUT for staying in continuous transmitting and receiving mode is programmed.

Frequency and Channel list for the EUT:

Channel	Frequency (MHz)	Channel	Frequency (MHz)	Channel	Frequency (MHz)
1	902.75	24	914.25	47	925.75
2	903.25	25	914.75	48	926.25
3	903.75	26	915.25	49	926.75
...	50	927.25
Note: $f_c = 902.75\text{MHz} + k * 0.5\text{MHz}$ $k(\text{Channel Number}) = 1$ to 50					

Test Frequency and channel for the EUT:

Lowest Frequency		Middle Frequency		Highest Frequency	
Channel	Frequency (MHz)	Channel	Frequency (MHz)	Channel	Frequency (MHz)
01	902.75	25	914.75	50	927.25

5 FACILITIES AND ACCREDITATIONS

5.1 FACILITIES

All measurement facilities used to collect the measurement data are located at

Bldg 69, Majialong Industry Zone District, Nanshan District, Shenzhen, China

The sites are constructed in conformance with the requirements of ANSI C63.7, ANSI C63.10 and CISPR Publication 22.

5.2 LABORATORY ACCREDITATIONS AND LISTINGS

Site Description

EMC Lab.

: Accredited by CNAS, 2016.10.24

The certificate is valid until 2022.10.28

The Laboratory has been assessed and proved to be in compliance with CNAS-CL01:2006 (identical to ISO/IEC 17025:2005)

The Certificate Registration Number is L2291.

Accredited by TUV Rheinland Shenzhen 2016.5

The Laboratory has been assessed according to the requirements ISO/IEC 17025.

Accredited by FCC, April 17, 2013

The Certificate Registration Number is 709623.

Accredited by FCC, July 13, 2017

The Certificate Registration Number is 406365.

Accredited by Industry Canada, November 24, 2015

The Certificate Registration Number is 4480A.

Name of Firm

: EMTEK(SHENZHEN) CO., LTD.

Site Location

: Bldg 69, Majialong Industry Zone,
Nanshan District, Shenzhen, Guangdong, China

6 TEST SYSTEM UNCERTAINTY

The following measurement uncertainty levels have been estimated for tests performed on the apparatus:

Parameter	Uncertainty
Radio Frequency	$\pm 1 \times 10^{-5}$
Maximum Peak Output Power Test	$\pm 1.0\text{dB}$
Conducted Emissions Test	$\pm 2.0\text{dB}$
Radiated Emission Test	$\pm 2.0\text{dB}$
Occupied Bandwidth Test	$\pm 1.0\text{dB}$
Band Edge Test	$\pm 3\text{dB}$
All emission, radiated	$\pm 3\text{dB}$
Antenna Port Emission	$\pm 3\text{dB}$
Temperature	$\pm 0.5^{\circ}\text{C}$
Humidity	$\pm 3\%$

Measurement Uncertainty for a level of Confidence of 95%

7 SETUP OF EQUIPMENT UNDER TEST

7.1 RADIO FREQUENCY TEST SETUP 1

The RFID component's antenna ports(s) of the EUT are connected to the measurement instrument per an appropriate attenuator. The EUT is controlled by PC/software to emit the specified signals for the purpose of measurements.

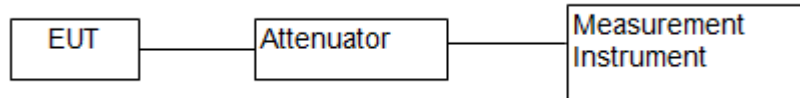

7.2 RADIO FREQUENCY TEST SETUP 2

The test site semi-anechoic chamber has met the requirement of NSA tolerance 4 dB according to the standards: ANSI C63.10. The test distance is 3m. The setup is according to the requirements in Section 13.1.4.1 of ANSI C63.10-2013 and CAN/CSA-CEI/IEC CISPR 22.

Below 30MHz:

The EUT is placed on a turntable 0.8 meters above the ground in the chamber, 3 meter away from the antenna (loop antenna). The Antenna should be positioned with its plane vertical at the specified distance from the EUT and rotated about its vertical axis for maximum response at each azimuth about the EUT. The center of the loop shall be 1 m above the ground. For certain applications, the loop antenna plane may also need to be positioned horizontally at the specified distance from the EUT.

Above 30MHz:

The EUT is placed on a turntable 0.8 meters above the ground in the chamber, 3 meter away from the antenna. The maximal emission value is acquired by adjusting the antenna height, polarisation and turntable azimuth. Normally, the height range of antenna is 1 m to 4 m, the azimuth range of turntable is 0° to 360°, and the receive antenna has two polarizations Vertical (V) and Horizontal (H).

Above 1GHz:

The EUT is placed on a turntable 1.5 meters above the ground in the chamber, 3 meter away from the antenna. The maximal emission value is acquired by adjusting the antenna height, polarisation and turntable azimuth. Normally, the height range of antenna is 1 m to 4 m, the azimuth range of turntable is 0° to 360°, and the receive antenna has two polarizations Vertical (V) and Horizontal (H).

(a) Radiated Emission Test Set-Up, Frequency Below 30MHz

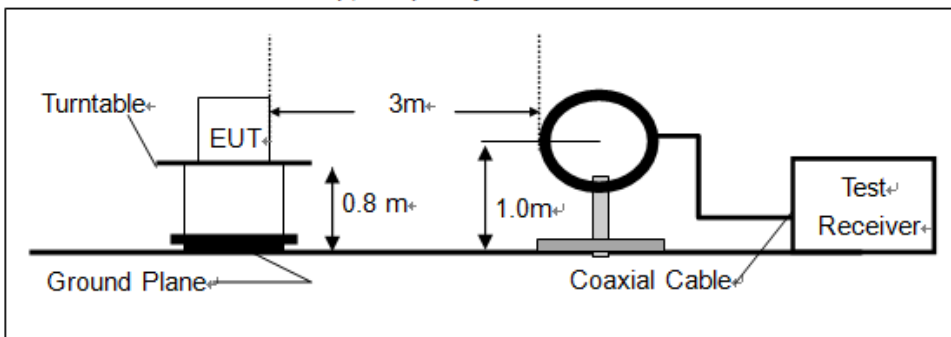

(b) Radiated Emission Test Set-Up, Frequency Below 1000MHz

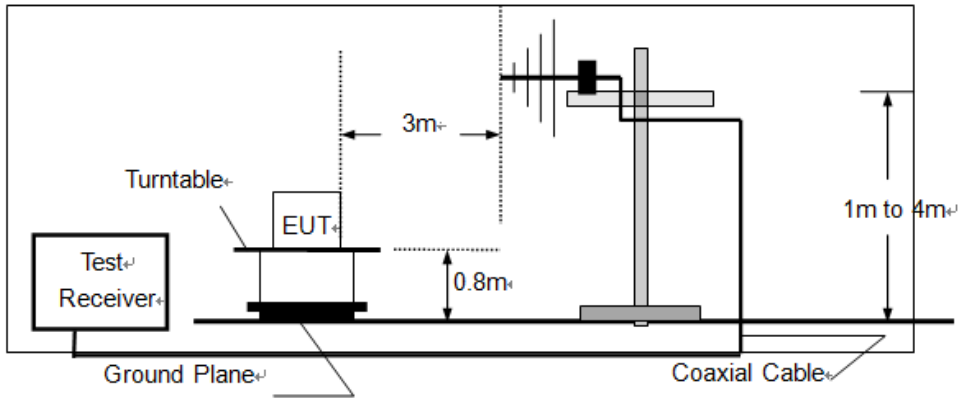

(c) Radiated Emission Test Set-Up, Frequency above 1000MHz

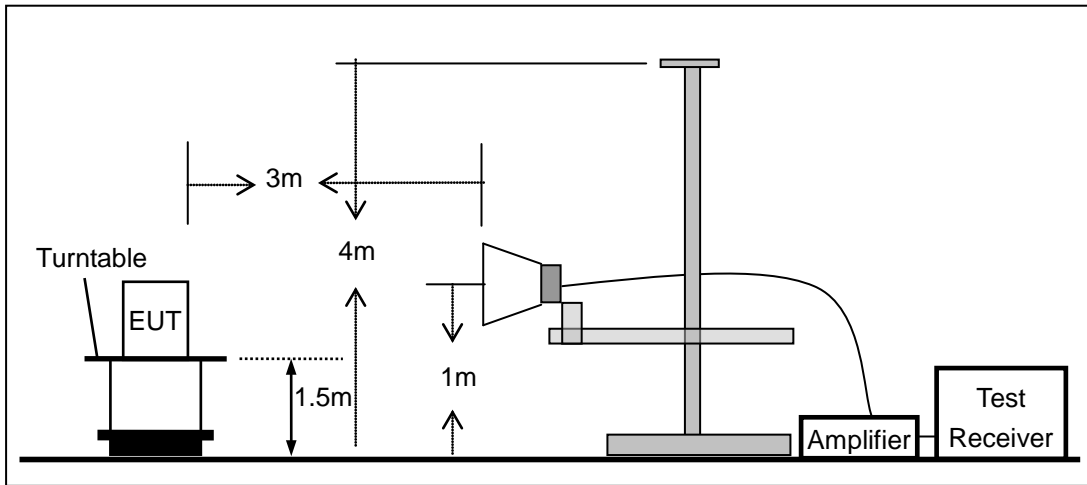

7.3 CONDUCTED EMISSION TEST SETUP

The mains cable of the EUT (UHF RFID Reader Module) must be connected to LISN. The LISN shall be placed 0.8 m from the boundary of EUT and bonded to a ground reference plane for LISN mounted on top of the ground reference plane. This distance is between the closest points of the LISN and the EUT. All other units of the EUT and associated equipment shall be at least 0.8m from the LISN.

Ground connections, where required for safety purposes, shall be connected to the reference ground point of the LISN and, where not otherwise provided or specified by the manufacturer, shall be of same length as the mains cable and run parallel to the mains connection at a separation distance of not more than 0.8 m.

According to the requirements in Section 13.1.4.1 of ANSI C63.10-2013 Conducted emissions from the EUT measured in the frequency range between 0.15 MHz and 30 MHz using CISPR Quasi-Peak and average detector mode.

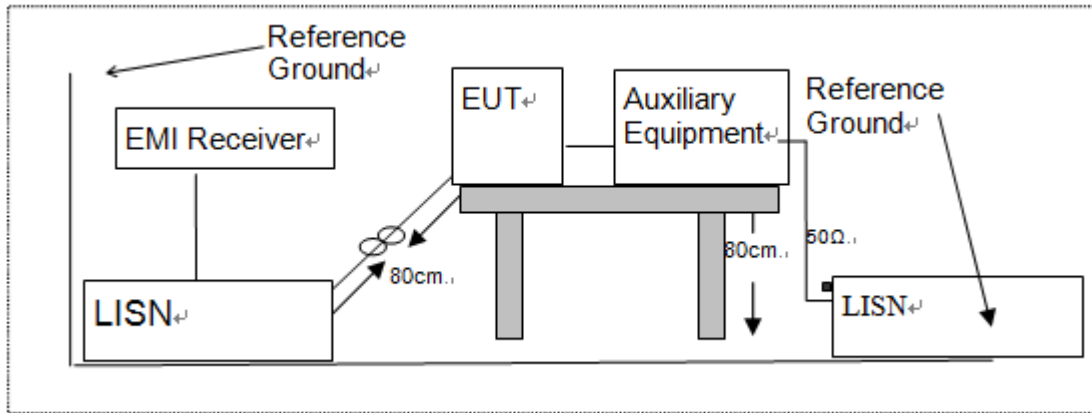

7.4 BLOCK DIAGRAM CONFIGURATION OF TEST SYSTEM

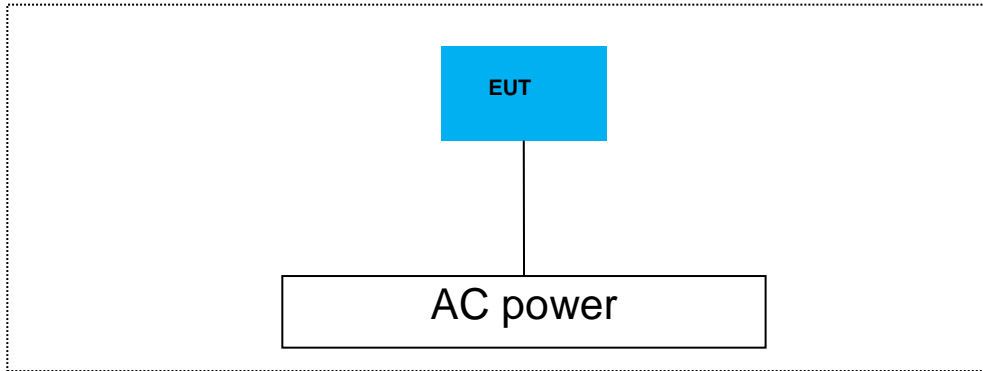

7.5 SUPPORT EQUIPMENT

EUT Cable List and Details			
Cable Description	Length (m)	Shielded/Unshielded	With / Without Ferrite
USB cable	1.0	Unshielded	Without Ferrite

Auxiliary Cable List and Details			
Cable Description	Length (m)	Shielded/Unshielded	With / Without Ferrite
/	/	/	/

Auxiliary Equipment List and Details			
Description	Manufacturer	Model	Serial Number
/	/	/	/

Notes:

1. All the equipment/cables were placed in the worst-case configuration to maximize the emission during the test.
2. Grounding was established in accordance with the manufacturer’s requirements and conditions for the intended use.

8 TEST REQUIREMENTS

8.1 20DB BANDWIDTH

8.1.1 Applicable Standard

According to FCC Part 15.247(a)(1) and DA 00-705

8.1.2 Conformance Limit

No limit requirement.

8.1.3 Test Configuration

Test according to clause 7.1 radio frequency test setup 1

8.1.4 Test Procedure

The EUT was operating in RFID mode and controlled its channel. Printed out the test result from the spectrum by hard copy function.

The RF output of EUT was connected to the spectrum analyzer by RF cable and attenuator. The path loss was compensated to the results for each measurement.

Set to the maximum power setting and enable the EUT transmit continuously

Set RBW \geq 1% of the 20 dB bandwidth(3KHz)

Set the video bandwidth (VBW) \geq RBW(10KHz).

Set Span= approximately 2 to 3 times the 20 dB bandwidth

Set Detector = Peak.

Set Trace mode = max hold.

Set Sweep = auto couple.

The EUT should be transmitting at its maximum data rate. Allow the trace to stabilize. Use the marker-to-peak function to set the marker to the peak of the emission. Use the marker-delta function to measure 20 dB down one side of the emission. Reset the markerdelta function, and move the marker to the other side of the emission, until it is (as close as possible to) even with the reference marker level. The marker-delta reading at this point is the 20 dB bandwidth of the emission.

If this value varies with different modes of operation (e.g., data rate, modulation format, etc.), repeat this test for each variation.

Measure and record the results in the test report.

Test Results

Temperature:	26° C
Relative Humidity:	54%
ATM Pressure:	1011 mbar

Modulation Mode	Channel Number	Channel Frequency (MHz)	Measurement Bandwidth (kHz)	Limit (kHz)	Verdict
ASK	01	902.75	116.88	N/A	PASS
	25	914.75	118.68	N/A	PASS
	50	927.25	113.29	N/A	PASS
Note: N/A (Not Applicable)					

Test Model 20dB Bandwidth
RFID
Channel 1: 902.75MHz ASK Modulation

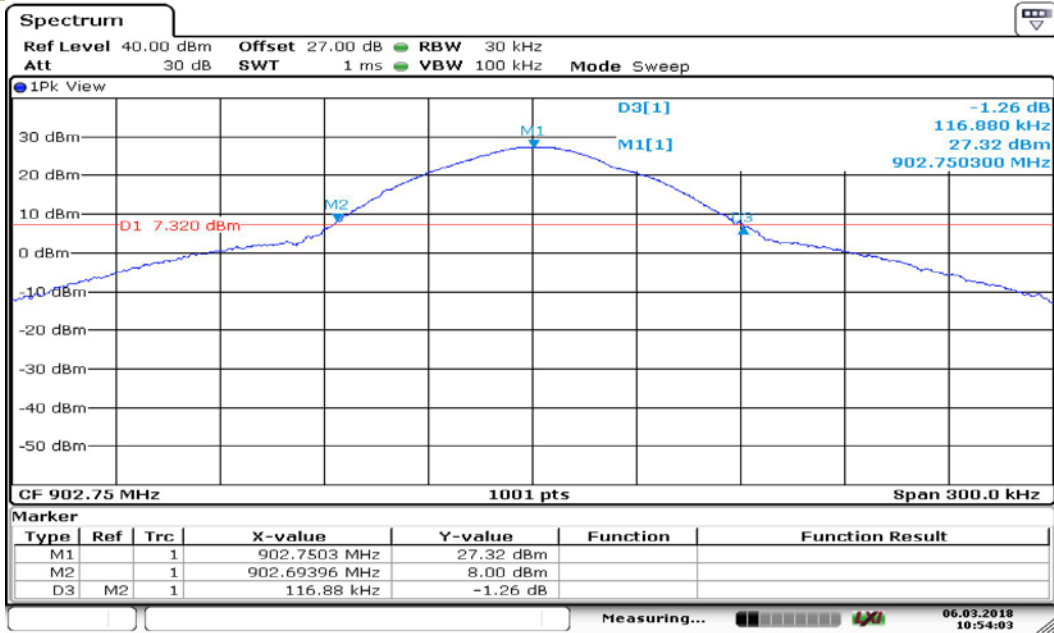

Date: 6.MAR.2018 10:54:03

Test Model 20dB Bandwidth
RFID
Channel 25: 914.75MHz ASK Modulation

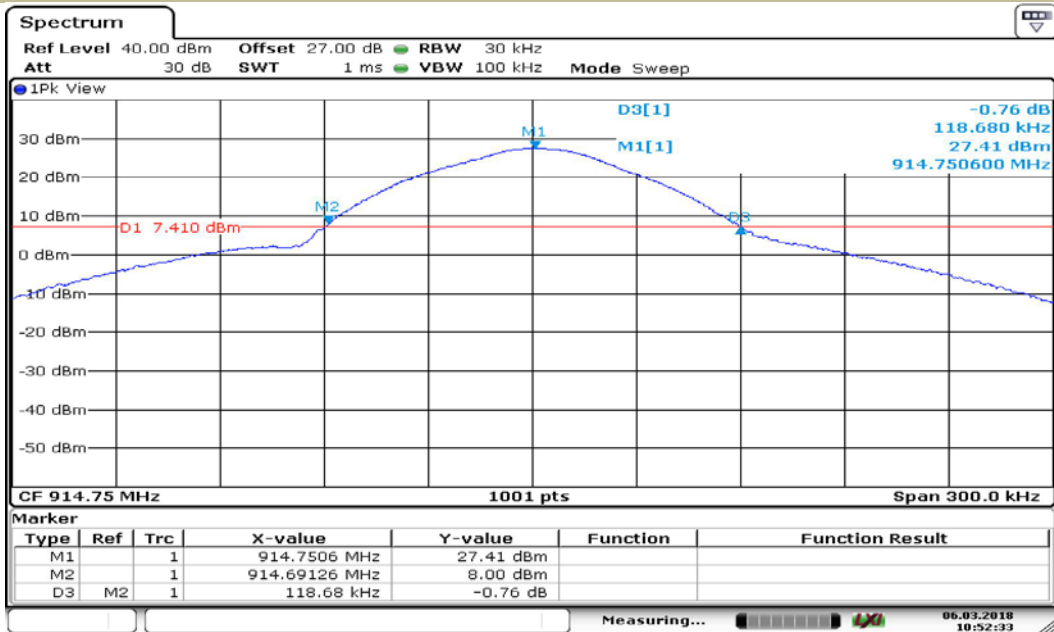

Date: 6.MAR.2018 10:52:33

Test Model 20dB Bandwidth
RFID
Channel 50: 927.25MHz ASK Modulation

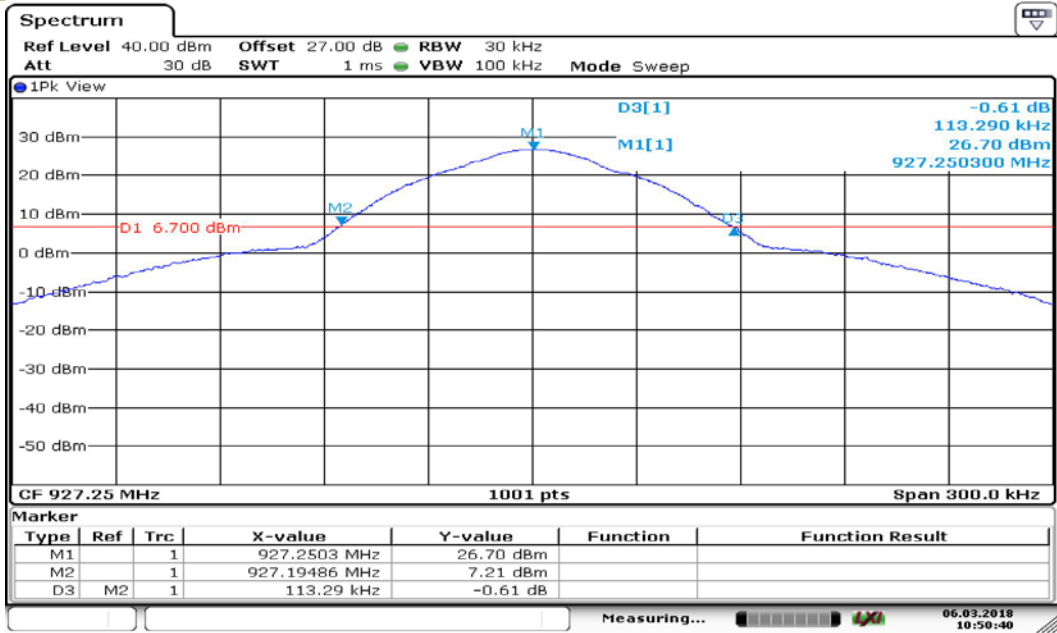

Date: 6.MAR.2018 10:50:40

8.2 CARRIER FREQUENCY SEPARATION

8.2.1 Applicable Standard

According to FCC Part 15.247(a)(1) and DA 00-705

8.2.2 Conformance Limit

Frequency hopping systems operating in the 902-928MHz band shall have hopping channel carrier frequencies separated by a minimum of 25kHz or the 20dB bandwidth of the hopping channel, whichever is greater.

In case of an output power less than 125mW, the frequency hopping system may have channels separated by a minimum of 25kHz or two-thirds of the 20dB bandwidth of the hopping channel, whichever is greater.

8.2.3 Test Configuration

Test according to clause 7.1 radio frequency test setup 1

8.2.4 Test Procedure

- According to FCC Part15.247(a)(1)
The EUT must have its hopping function enabled. Use the following spectrum analyzer settings:
Set the RBW \geq 1% of the span(100KHz).
Set the VBW \geq RBW(300KHz).
Set the span = wide enough to capture the peaks of two adjacent channels
Set Sweep time = auto couple.
Set Detector = peak.
Set Trace mode = max hold.
Allow the trace to stabilize. Use the marker-delta function to determine the separation between the peaks of the adjacent channels. The limit is specified in one of the subparagraphs of this Section. Submit this plot.

Test Results

Temperature:	26° C
Relative Humidity:	54%
ATM Pressure:	1011 mbar

Modulation Mode	Channel Number	Channel Frequency (MHz)	Measurement Bandwidth (kHz)	Limit (kHz)	Verdict
ASK	01	902.75	500.70	\geq 116.88	PASS
	25	914.75	500.70	\geq 118.68	PASS
	50	927.25	500.70	\geq 113.29	PASS

Note: Limit = 20dB bandwidth

Test Model Carrier Frequency Separation
RFID
Channel 1: 902.75MHz ASK Modulation

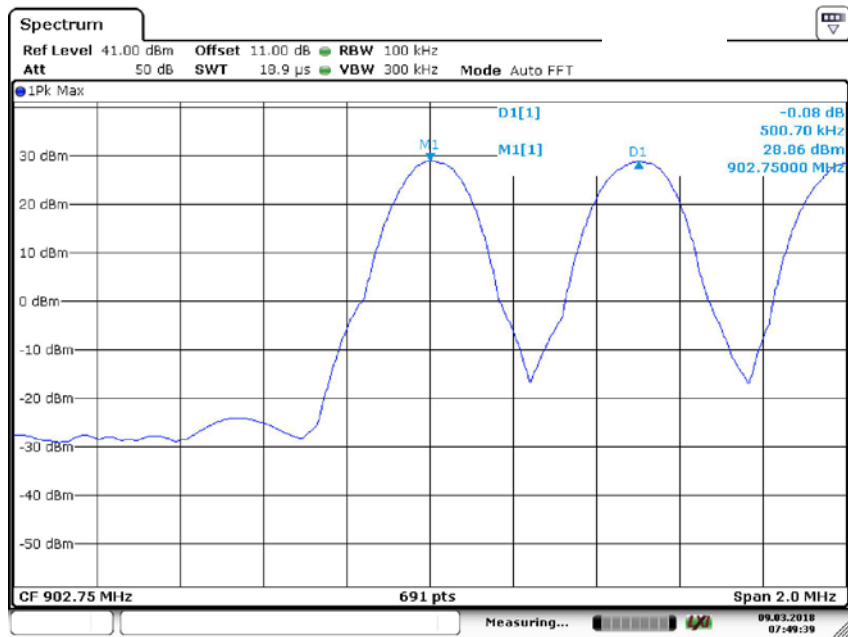

Date: 9.MAR.2018 07:49:39

Test Model Carrier Frequency Separation
RFID
Channel 25: 914.75MHz ASK Modulation

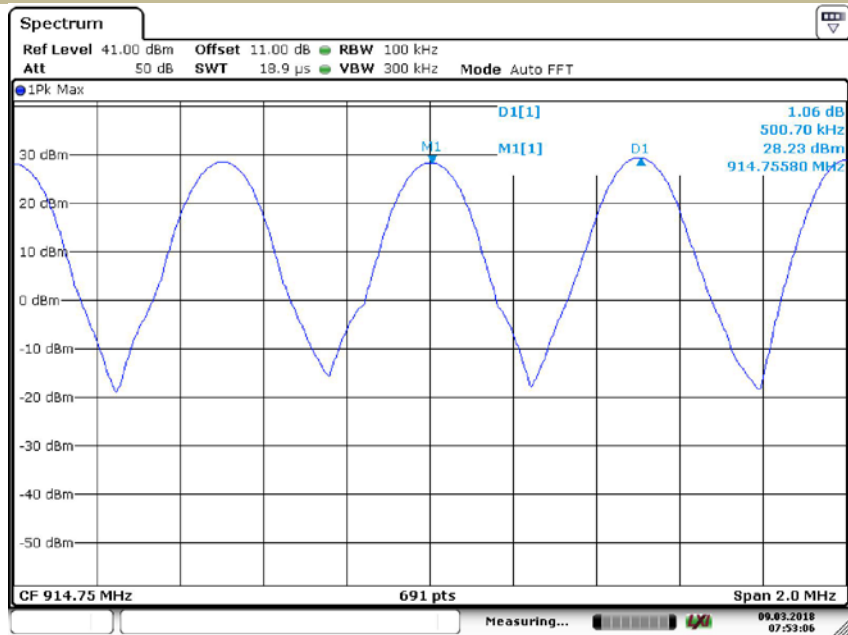

Date: 9.MAR.2018 07:53:06

Test Model

Carrier Frequency Separation

RFID

Channel 50: 927.25MHz

ASK Modulation

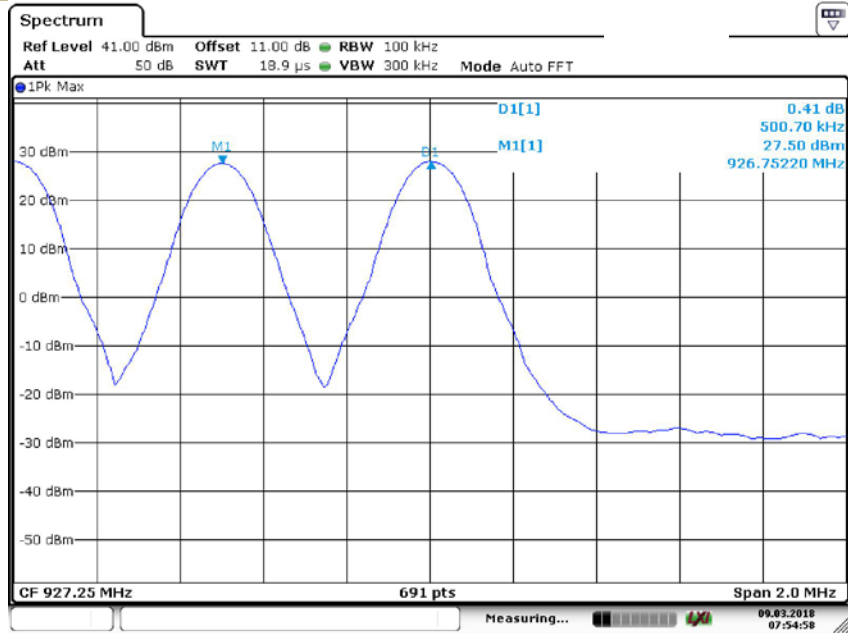

Date: 9.MAR.2018 07:54:58

8.3 NUMBER OF HOPPING FREQUENCIES

8.3.1 Applicable Standard

According to FCC Part 15.247(a)(1) (i) and DA 00-705

8.3.2 Conformance Limit

Frequency hopping systems operating in the 902-928MHz band shall use at least 50 channels.

8.3.3 Test Configuration

Test according to clause 7.1 radio frequency test setup 1

8.3.4 Test Procedure

- According to FCC Part 15.247(a)(1)(iii)

The EUT must have its hopping function enabled. Use the following spectrum analyzer settings:

Span = the frequency band of operation

RBW \geq 1% of the span (100KHz).

VBW \geq RBW (300KHz).

Sweep = auto

Detector function = peak

Trace = max hold

Allow the trace to stabilize. It may prove necessary to break the span up to sections, in order to clearly show all of the hopping frequencies.

Test Results

Temperature:	26° C
Relative Humidity:	54%
ATM Pressure:	1011 mbar

Hopping Channel Frequency Range	Quantity of Hopping Channel	Quantity of Hopping Channel limit
902-928	50	≥ 50

Test Model Number Of Hopping Frequencies
RFID
ASK Modulation

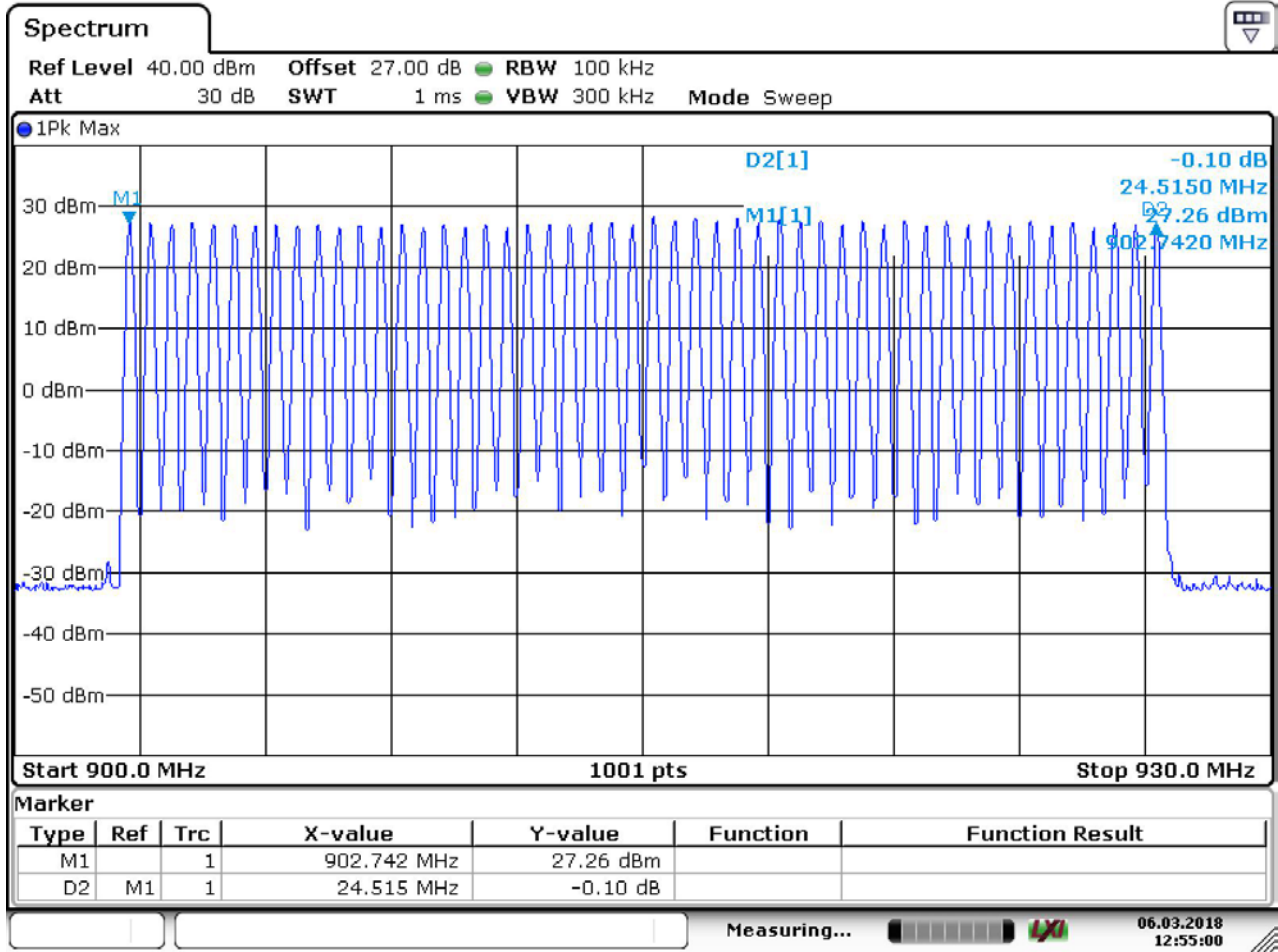

Date: 6.MAR.2018 12:55:00

8.4 AVERAGE TIME OF OCCUPANCY (DWELL TIME)

8.4.1 Applicable Standard

According to FCC Part 15.247(a)(1)(i) and DA 00-705

8.4.2 Conformance Limit

For frequency hopping systems operating in the 902-928 MHz band: if the 20 dB bandwidth of the hopping channel is less than 250 kHz, the system shall use at least 50 hopping frequencies and the average time of occupancy on any frequency shall not be greater than 0.4 seconds within a 20 second period; if the 20 dB bandwidth of the hopping channel is 250 kHz or greater, the system shall use at least 25 hopping frequencies and the average time of occupancy on any frequency shall not be greater than 0.4 seconds within a 10 second period. The maximum allowed 20 dB bandwidth of the hopping channel is 500 kHz..

8.4.3 Test Configuration

Test according to clause 7.1 radio frequency test setup 1

8.4.4 Test Procedure

- According to FCC Part15.247(a)(1)(iii)
The EUT must have its hopping function enabled. Use the following spectrum analyzer settings:
Span = zero span, centered on a hopping channel
RBW = 100 KHz
VBW ≥ RBW
Sweep = as necessary to capture the entire dwell time per hopping channel
Detector function = peak
Trace = max hold
If possible, use the marker-delta function to determine the dwell time. If this value varies with different modes of operation (e.g., data rate, modulation format, etc.), repeat this test for each variation. The limit is specified in one of the subparagraphs of this Section.

8.4.5 Test Results

Temperature:	26° C
Relative Humidity:	54%
ATM Pressure:	1011 mbar

Modulation Mode	Frequency (MHz)	occupied time for each channel	dwell time (ms)	Limit(ms)	Verdict
ASK	902.75	26ms	182ms	<400	PASS

Note:
 The number of occupied channels per second $21/60=0.35(\text{number}/\text{sec})$
 The total number of occupied channels per second $50*21/60=17.5(\text{number}/\text{sec})$
 occupied time for each channel 26ms
 Dwell time per second $50*21/60*26=455\text{ms}$
 Dwell time for 0.4second $50*21/60*26*0.4=182\text{ms}$

Test Model Average Time Of Occupancy (Dwell Time)
RFID
CH 01: 902.75MHz The number of occupied channels per minute

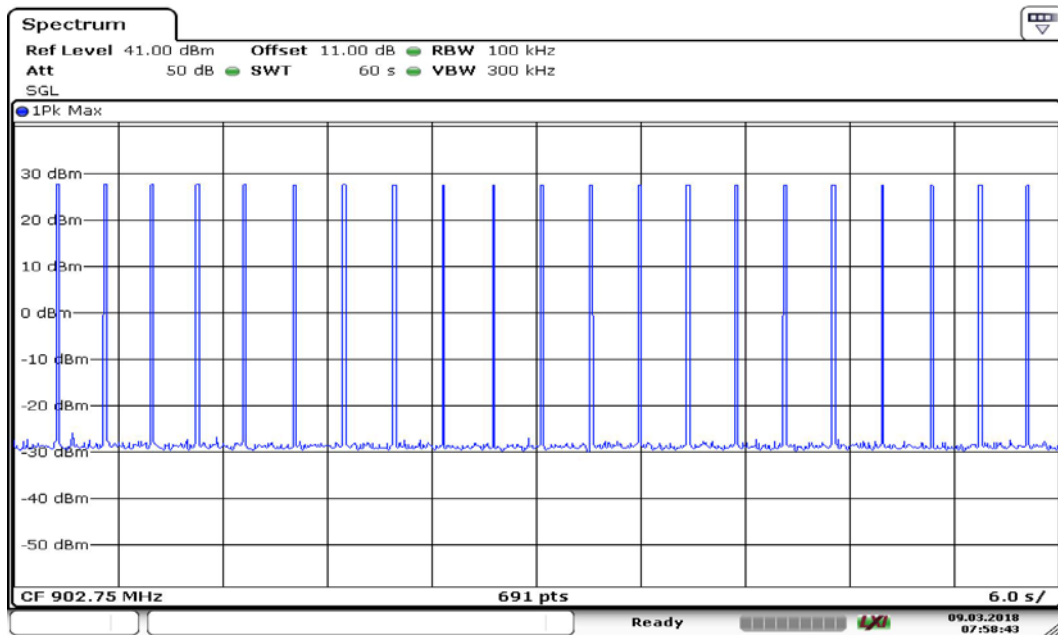

Date: 9.MAR.2018 07:58:44

Test Model Average Time Of Occupancy (Dwell Time)
RFID
CH 01: 902.75MHz occupied time for each channel

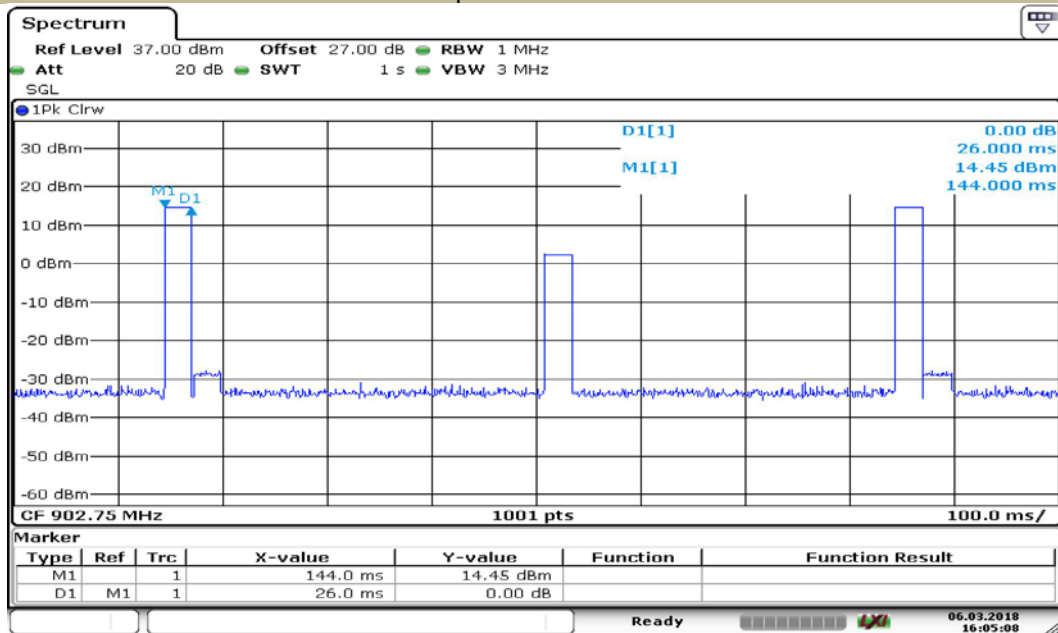

Date: 6.MAR.2018 16:05:09

8.5 MAXIMUM PEAK CONDUCTED OUTPUT POWER

8.5.1 Applicable Standard

According to FCC Part 15.247(b)(1) and DA 00-705

8.5.2 Conformance Limit

For frequency hopping systems operating in the 902-928 MHz band: 1 watt for systems employing at least 50 hopping channels; and, 0.25 watts for systems employing less than 50 hopping channels, but at least 25 hopping channels, as permitted under paragraph (a)(1)(i) of this section.

8.5.3 Test Configuration

Test according to clause 7.1 radio frequency test setup 1

8.5.4 Test Procedure

■ According to FCC Part 15.247(b)(1)

As an alternative to a peak power measurement, compliance with the limit can be based on a measurement of the maximum conducted output power.

Use the following spectrum analyzer settings:

Set Span = approximately 5 times the 20 dB bandwidth, centered on a hopping channel (about 10MHz)

Set RBW > the 20 dB bandwidth of the emission being measured (about 1MHz)

Set VBW ≥ RBW

Set Sweep = auto

Set Detector function = peak

Set Trace = max hold

Allow the trace to stabilize. Use the marker-to-peak function to set the marker to the peak of the emission to determine the peak amplitude level.

Test Results

Temperature:	26° C
Relative Humidity:	54%
ATM Pressure:	1011 mbar

Operation Mode	Channel Number	Channel Frequency (MHz)	Measurement Level (dBm)	Limit (dBm)	Verdict
ASK	01	902.75	26.35	30	PASS
	25	914.75	26.00	30	PASS
	50	927.25	26.56	30	PASS
Note: N/A					

Test Model Maximum Peak Conducted Output Power
RFID
Channel 01: 902.75MHz ASK

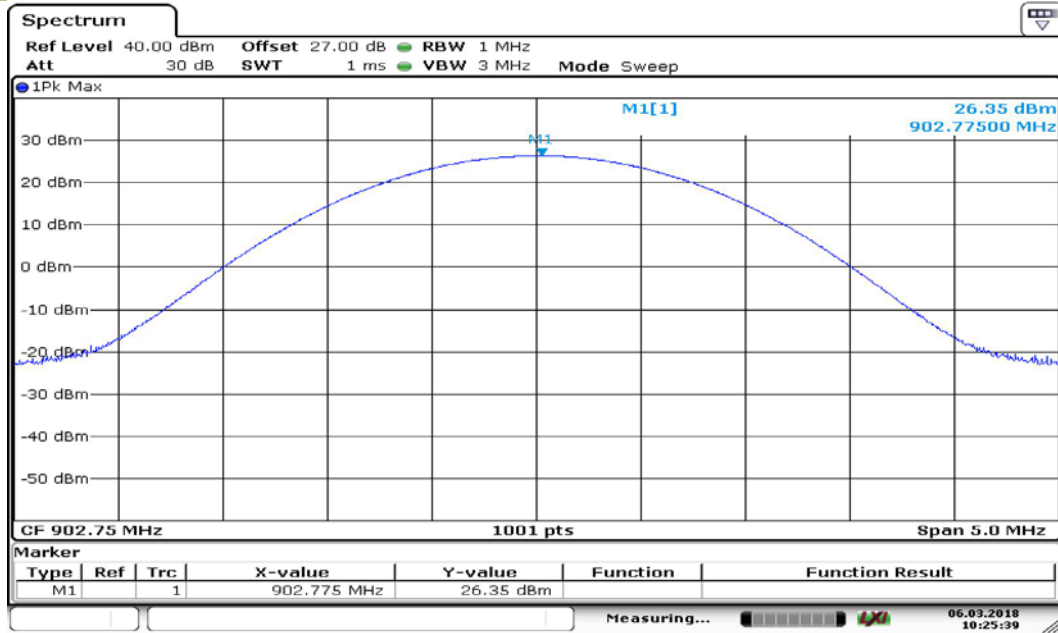

Date: 6.MAR.2018 10:25:39

Test Model Maximum Peak Conducted Output Power
RFID
Channel 25: 914.75MHz ASK

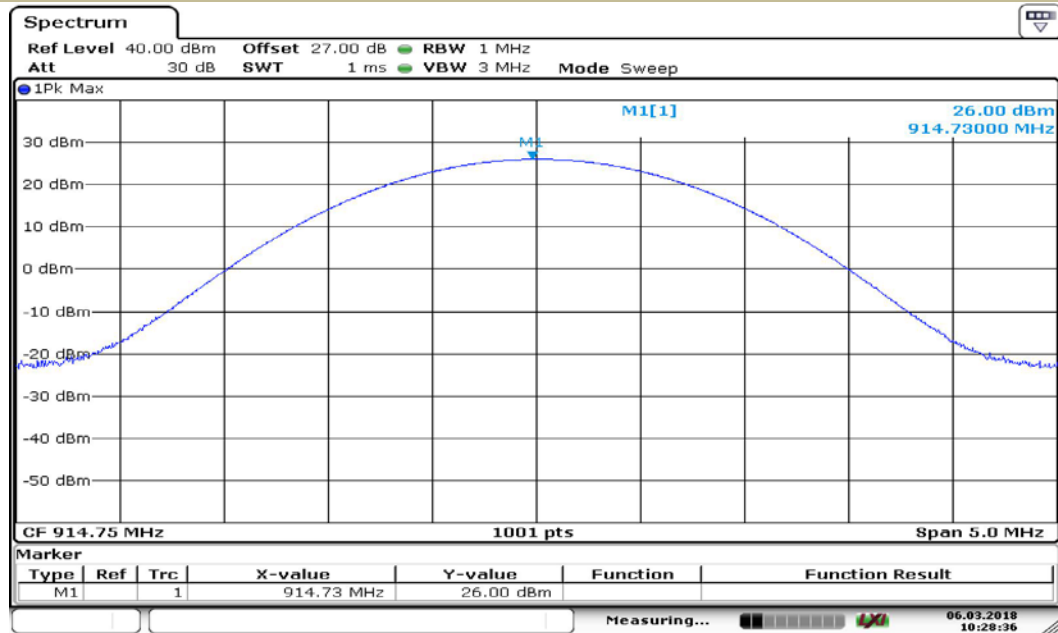

Date: 6.MAR.2018 10:28:36

Test Model Maximum Peak Conducted Output Power
 RFID
 Channel 50: 927.25MHz ASK

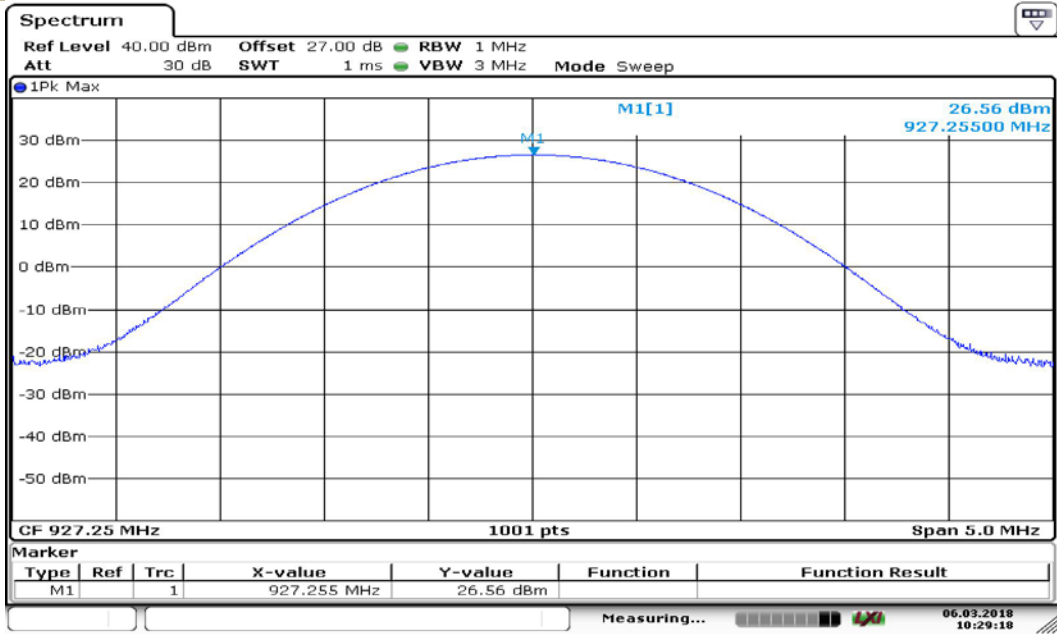

Date: 6.MAR.2018 10:29:18

8.6 CONDUCTED SUPRIIOUS EMISSION

8.6.1 Applicable Standard

According to FCC Part 15.247(d) and DA 00-705

8.6.2 Conformance Limit

According to FCC Part 15.247(d):

In any 100 kHz bandwidth outside the frequency band in which the spread spectrum intentional radiator is operating, the radio frequency power that is produced by the intentional radiator shall be at least 20 dB below that in the 100 kHz bandwidth within the band that contains the highest level of the desired power, based on either an RF conducted, provided the transmitter demonstrates compliance with the peak conducted power limits.

8.6.3 Test Configuration

Test according to clause 7.1 radio frequency test setup 1

8.6.4 Test Procedure

The transmitter output (antenna port) was connected to the spectrum analyzer

■ Reference level measurement

Establish a reference level by using the following procedure:

Set instrument center frequency to DSS channel center frequency.

Set Span = approximately 5 times the 20 dB bandwidth, centered on a hopping channel.

Set the RBW = 100 kHz. Set the VBW $\geq 3 \times$ RBW.

Set Detector = peak. Set Sweep time = auto couple.

Set Trace mode = max hold. Allow trace to fully stabilize.

Use the peak marker function to determine the maximum Maximum conduceted level.

Note that the channel found to contain the maximum conduceted level can be used to establish the reference level.

■ Band-edge Compliance of RF Conducted Emissions

Use the following spectrum analyzer settings:

Span = wide enough to capture the peak level of the emission operating on the channel closest to the band-edge, as well as any modulation products which fall outside of the authorized band of operation

Set RBW $\geq 1\%$ of the span=100kHz Set VBW \geq RBW

Set Sweep = auto Set Detector function = peak Set Trace = max hold

Allow the trace to stabilize. Set the marker on the emission at the bandedge, or on the highest modulation product outside of the band, if this level is greater than that at the bandedge. Enable the marker-delta function, then use the marker-to-peak function to move the marker to the peak of the in-band emission.

The marker-delta value now displayed must comply with the limit specified in this Section.

Now, using the same instrument settings, enable the hopping function of the EUT. Allow the trace to stabilize. Follow the same procedure listed above to determine if any spurious emissions caused by the hopping function also comply with the specified limit.

■ Conduceted Spurious RF Conducted Emission

Use the following spectrum analyzer settings:

Span = wide enough to capture the peak level of the in-band emission and all spurious emissions (e.g., harmonics) from the lowest frequency generated in the EUT up through the 10th harmonic.(30MHz to 25GHz). Set RBW = 100 kHz Set VBW \geq RBW

Set Sweep = auto Set Detector function = peak Set Trace = max hold

Allow the trace to stabilize. Set the marker on the peak of any spurious emission recorded. The level displayed must comply with the limit specified in this Section.

8.6.5 Test Results

Test Model

Maximum Conducted Level RBW=100kHz
RFID
Channel 01: 902.75MHz ASK

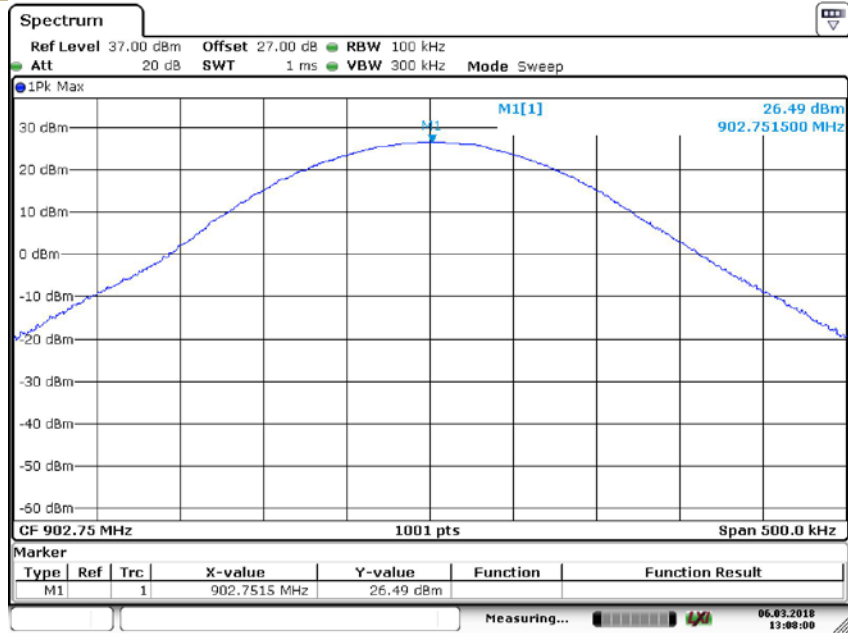

Date: 6.MAR.2018 13:08:00

Test Model

Conducted Spurious RF Conducted Emission
RFID
Channel 01: 902.75MHz ASK

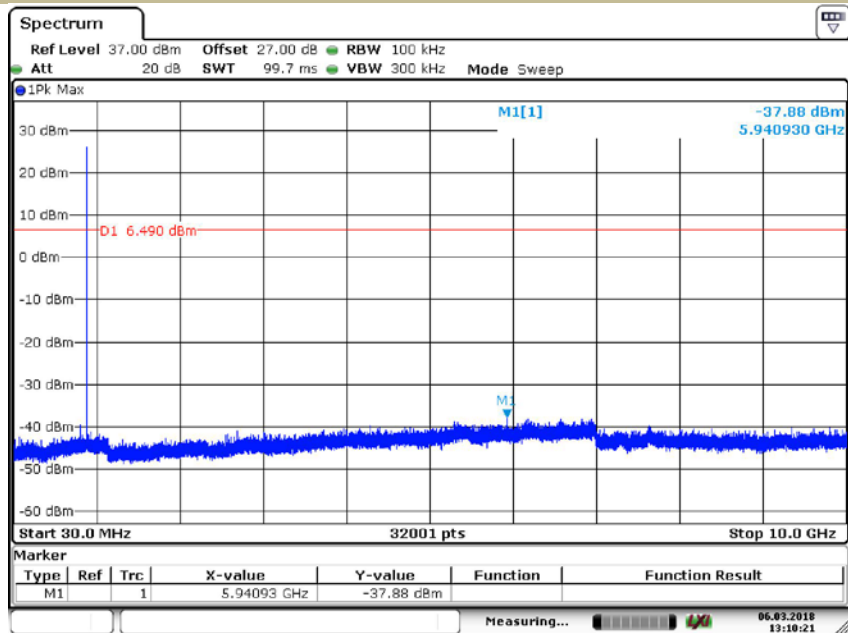

Date: 6.MAR.2018 13:10:22

Test Model

Band-edge Conducted Emissions
RFID
Channel 01: 902.75MHz ASK

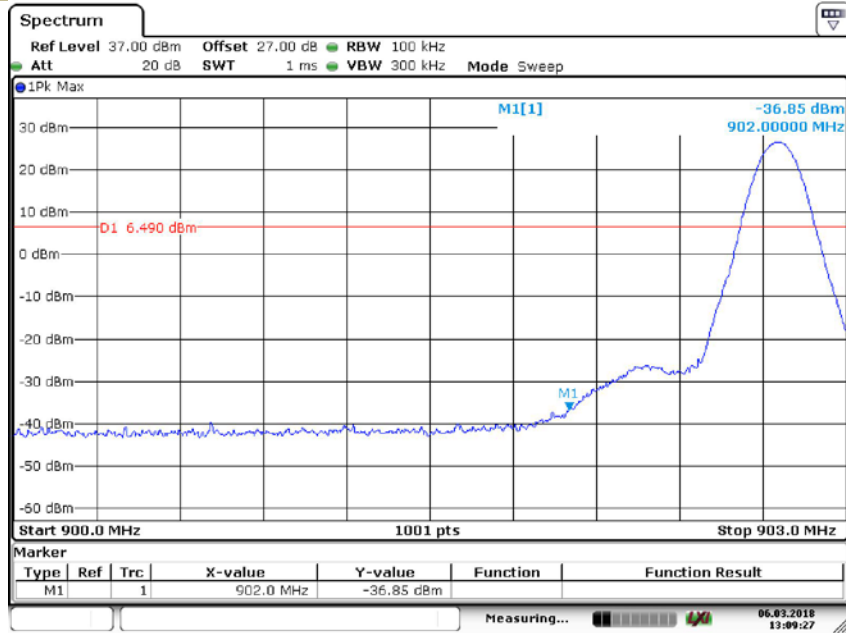

Date: 6.MAR.2018 13:09:27

Test Model

Maximum Conducted Level RBW=100kHz
RFID
Channel 25: 914.75MHz ASK

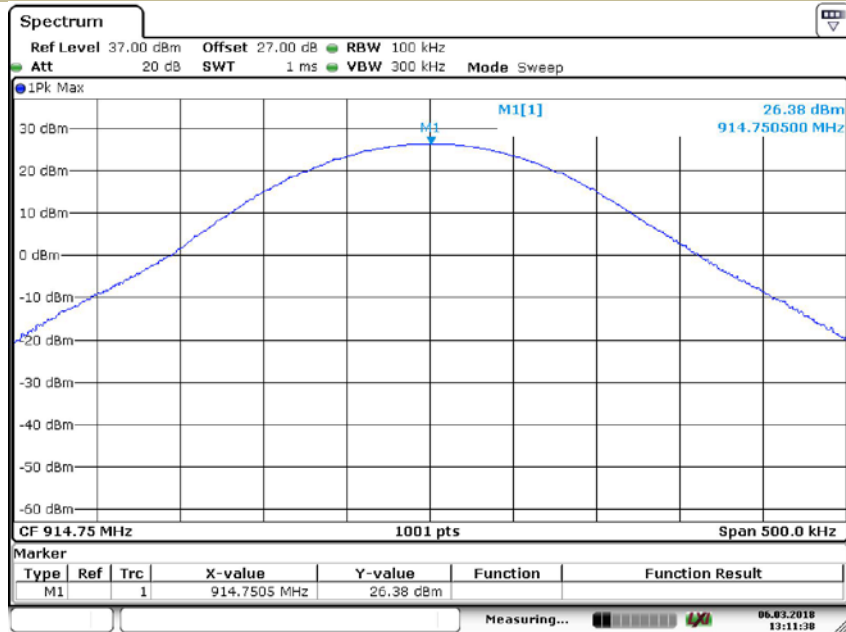

Date: 6.MAR.2018 13:11:39

Test Model **Conduceted Spurious RF Conducted Emission**
RFID
Channel 25: 914.75MHz **ASK**

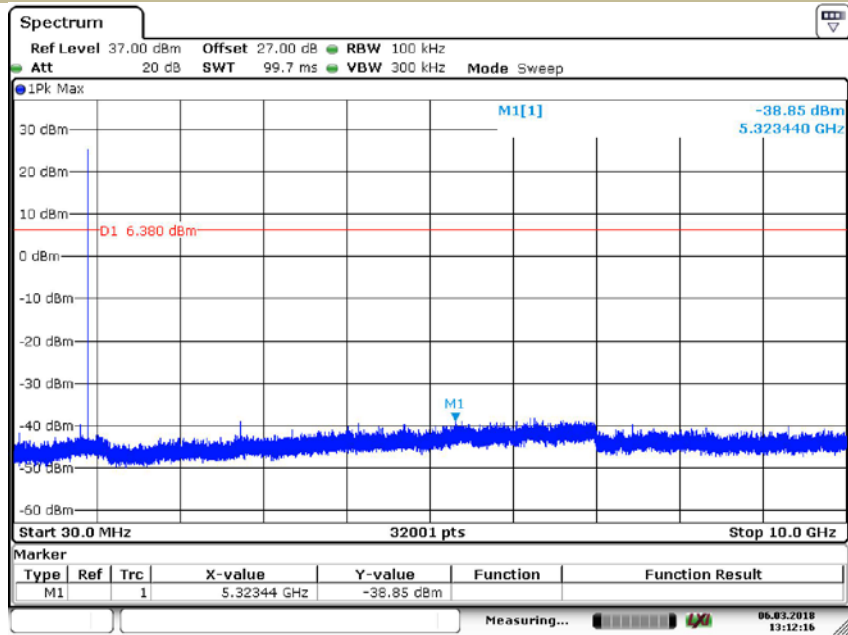

Date: 6.MAR.2018 13:12:16

Test Model **Maximum Conduceted Level RBW=100kHz**
RFID
Channel 50: 927.25MHz **ASK**

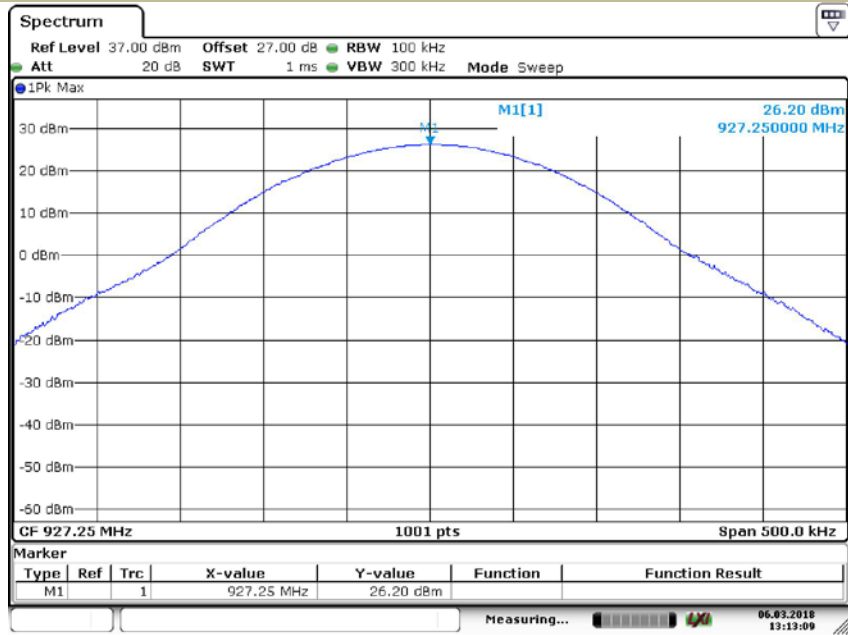

Date: 6.MAR.2018 13:13:09

Test Model Conducted Spurious RF Conducted Emission
RFID
Channel 50: 927.25MHz ASK

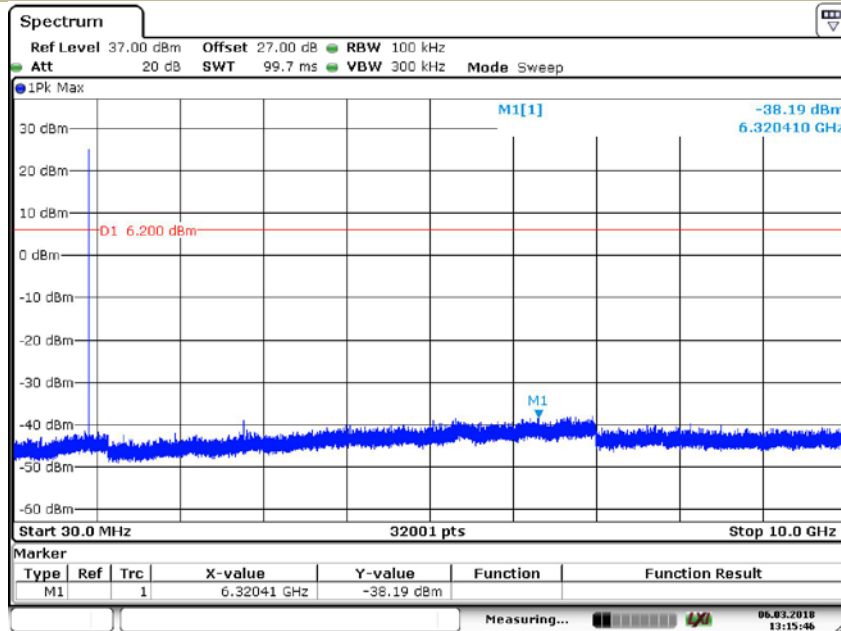

Date: 6.MAR.2018 13:15:46

Test Model Band-edge Conducted Emissions
RFID
Channel 50: 927.25MHz ASK

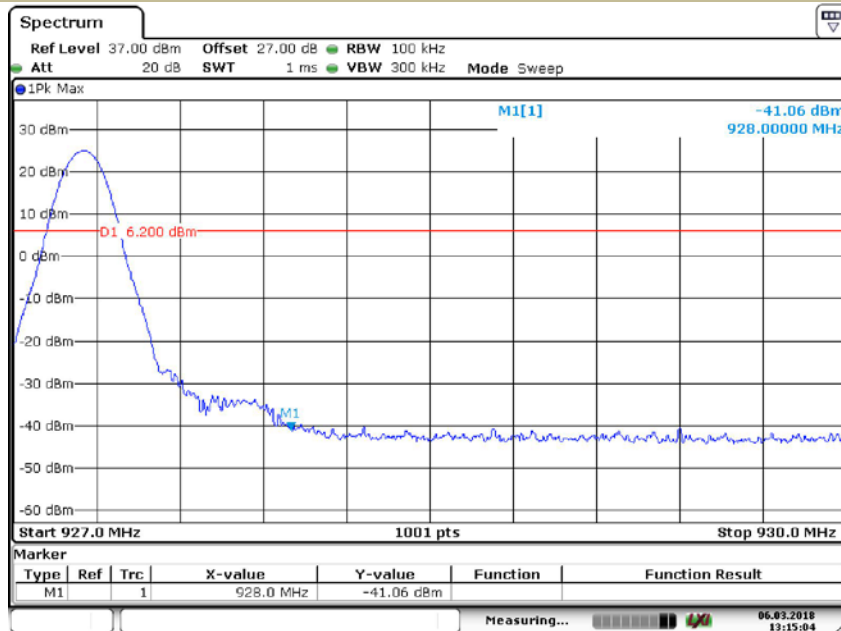

Date: 6.MAR.2018 13:15:04

Test Model Maximum Conduceted Level RBW=100kHz
RFID
Hopping ASK

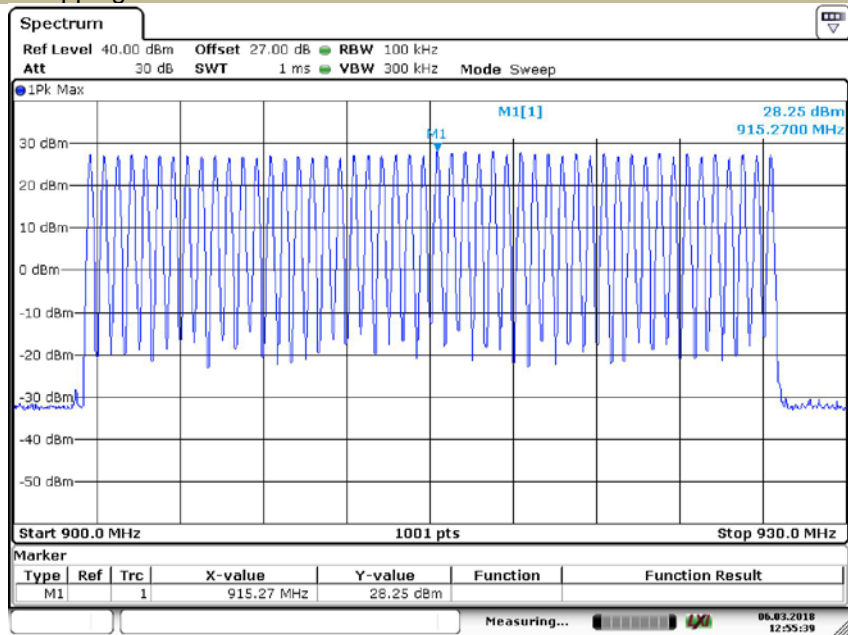

Date: 6.MAR.2018 12:55:40

Test Model Conduceted Spurious RF Conducted Emission
RFID
Hopping ASK

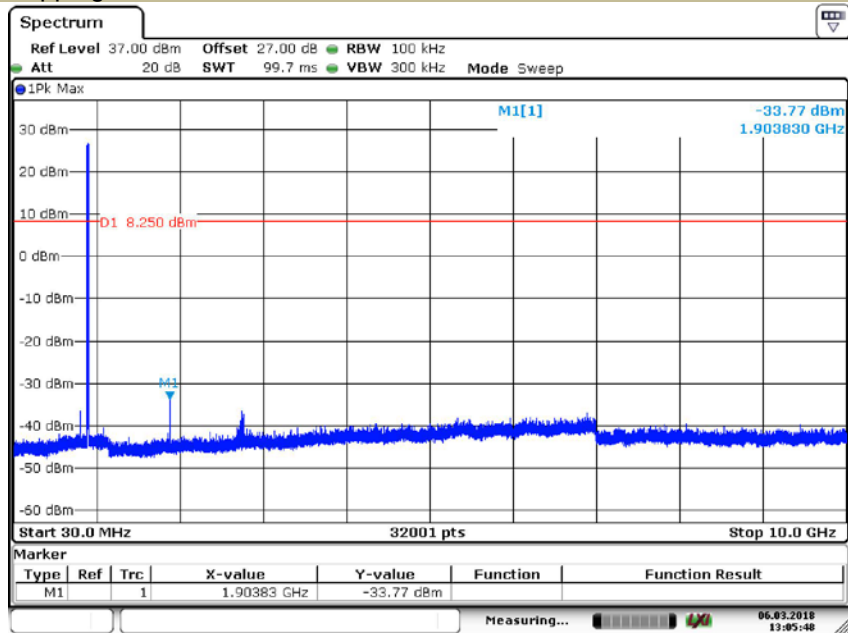

Date: 6.MAR.2018 13:05:48

Test Model

Band-edge Conducted Emissions
RFID
Hopping

ASK

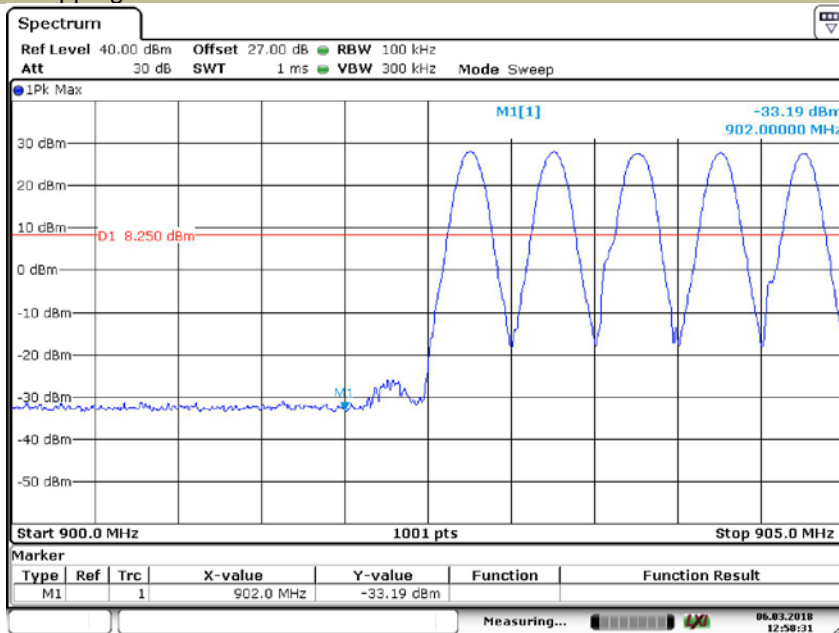

Date: 6.MAR.2018 12:58:31

Test Model

Band-edge Conducted Emissions
RFID
Hopping

ASK

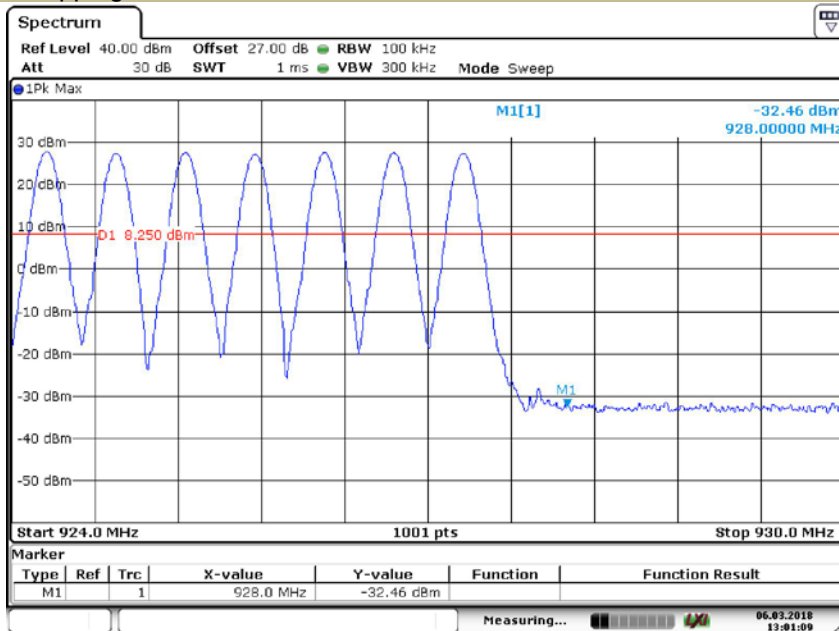

Date: 6.MAR.2018 13:01:09

8.7 RADIATED SPURIOUS EMISSION

8.7.1 Applicable Standard

According to FCC Part 15.247(d) and 15.209 and DA 00-705

8.7.2 Conformance Limit

According to FCC Part 15.247(d): radiated emissions which fall in the restricted bands, as defined in §15.205(a), must also comply with the radiated emission limits specified in §15.209(a) (see §15.205(c)).

According to FCC Part 15.205, Restricted bands

MHz	MHz	MHz	GHz
0.090-0.110	16.42-16.423	399.9-410	4.5-5.15
10.495-0.505	16.69475-16.69525	608-614	5.35-5.46
2.1735-2.1905	16.80425-16.80475	960-1240	7.25-7.75
4.125-4.128	25.5-25.67	1300-1427	8.025-8.5
4.17725-4.17775	37.5-38.25	1435-1626.5	9.0-9.2
4.20725-4.20775	73-74.6	1645.5-1646.5	9.3-9.5
6.215-6.218	74.8-75.2	1660-1710	10.6-12.7
6.26775-6.26825	123-138	2200-2300	14.47-14.5
8.291-8.294	149.9-150.05	2310-2390	15.35-16.2
8.362-8.366	156.52475-156.52525	2483.5-2500	17.7-21.4
8.37625-8.38675	156.7-156.9	2690-2900	22.01-23.12
8.41425-8.41475	162.0125-167.17	3260-3267	23.6-24.0
12.29-12.293	167.72-173.2	3332-3339	31.2-31.8
12.51975-12.52025	240-285	3345.8-3358	36.43-36.5
12.57675-12.57725	322-335.4	3600-4400	(2)
13.36-13.41			

According to FCC Part 15.205, the level of any transmitter spurious emission in Restricted bands shall not exceed the level of the emission specified in the following table

Restricted Frequency(MHz)	Field Strength (µV/m)	Field Strength (dBµV/m)	Measurement Distance
0.009-0.490	2400/F(KHz)	20 log (uV/m)	300
0.490-1.705	24000/F(KHz)	20 log (uV/m)	30
1.705-30	30	29.5	30
30-88	100	40	3
88-216	150	43.5	3
216-960	200	46	3
Above 960	500	54	3

Remark : 1. Emission level in dBuV/m=20 log (uV/m)

2. Measurement was performed at an antenna to the closed point of EUT distance of meters.

3. Distance extrapolation factor =40log(Specific distance/ test distance)(dB);

Limit line=Specific limits(dBuV) + distance extrapolation factor.

for the frequency ranges below 30 MHz, a narrower RBW is used for these ranges but the measured value should add a RBW correction factor (RBWCF) where RBWCF [dB] =10*lg(100 [kHz]/narrower RBW [kHz]). , the narrower RBW is 1 kHz and RBWCF is 20 dB for the frequency 9 kHz to 150 kHz, and the narrower RBW is 10 kHz and RBWCF is 10 dB for the frequency 150 kHz to 30 MHz.

8.7.3 Test Configuration

Test according to clause 7.2 radio frequency test setup 2

8.7.4 Test Procedure

This test is required for any spurious emission that falls in a Restricted Band, as defined in Section 15.205. It must be performed with the highest gain of each type of antenna proposed for use with the EUT. Use the following spectrum analyzer settings:

For Above 1GHz:

The EUT was placed on a turn table which is 0.1m above ground plane.

Maximum procedure was performed on the highest emissions to ensure EUT compliance.

Span = wide enough to fully capture the emission being measured

RBW = 1 MHz

VBW \geq RBW

Sweep = auto

Detector function = peak

Trace = max hold

For Below 1GHz:

The EUT was placed on a turn table which is 0.1m above ground plane.

Maximum procedure was performed on the highest emissions to ensure EUT compliance.

Span = wide enough to fully capture the emission being measured

RBW = 100 kHz for

VBW \geq RBW

Sweep = auto

Detector function = peak

Trace = max hold

For Below 30MHz:

The EUT was placed on a turn table which is 0.1m above ground plane.

Maximum procedure was performed on the highest emissions to ensure EUT compliance.

Span = wide enough to fully capture the emission being measured

RBW = 9kHz

VBW \geq RBW

Sweep = auto

Detector function = peak

Trace = max hold

For Below 150KHz:

The EUT was placed on a turn table which is 0.1m above ground plane.

Maximum procedure was performed on the highest emissions to ensure EUT compliance.

Span = wide enough to fully capture the emission being measured

RBW = 200Hz

VBW \geq RBW

Sweep = auto

Detector function = peak

Trace = max hold

Follow the guidelines in ANSI C63.10-2013 with respect to maximizing the emission by rotating the EUT, measuring the emission while the EUT is situated in three orthogonal planes (if appropriate), adjusting the measurement antenna height and polarization, etc. A pre-amp and a high pass filter are required for this test, in order to provide the measuring system with sufficient sensitivity. Allow the trace to stabilize. The peak reading of the emission, after being corrected by the antenna factor, cable loss, pre-amp gain, etc., is the peak field strength, which must comply with the limit specified in Section 15.35(b). Submit this data.

Now set the VBW to 10 Hz, while maintaining all of the other instrument settings. This peak level, once corrected, must comply with the limit specified in Section 15.209. If the dwell time per channel of the hopping signal is less than 100 ms, then the reading obtained with the 10 Hz VBW may be further adjusted by a "duty cycle correction factor", derived from $20\log(\text{dwell time}/100 \text{ ms})$, in an effort to demonstrate compliance with the 15.209 limit. Submit this data.

Repeat above procedures until all frequency measured was complete.

8.7.5 Test Results

■ Spurious Emission below 30MHz (9KHz to 30MHz)

Temperature:	26° C
Relative Humidity:	54%
ATM Pressure:	1011 mbar

Freq. (MHz)	Ant.Pol. H/V	Emission Level(dBuV/m)		Limit 3m(dBuV/m)		Over(dB)	
		PK	AV	PK	AV	PK	AV
--	--	--	--	--	--	--	--

Note: the amplitude of spurious emission that is attenuated by more than 20dB below the permissible limit has no need to be reported.

Distance extrapolation factor = $40\log(\text{Specific distance}/ \text{test distance})$ (dB);

Limit line=Specific limits(dBuV) + distance extrapolation factor

■ Spurious Emission Above 1GHz (1GHz to 10GHz)

Test mode: ASK Frequency: Channel 01: 902.75MHz

Freq. (MHz)	Ant. Pol. H/V	Emission Level(dBuV/m)		Limit 3m(dBuV/m)		Over(dB)	
		PK	AV	PK	AV	PK	AV
1805.50	V	66.35	52.29	74	54	-7.65	-1.71
2708.25	V	60.56	49.16	74	54	-13.44	-4.84
3611.00	V	55.48	47.77	74	54	-18.52	-6.23
4513.75	V	50.98	43.27	74	54	-23.02	-10.73
1805.50	H	63.03	51.06	74	54	-10.97	-2.94
2708.25	H	58.85	50.51	74	54	-15.15	-3.49
3611.00	H	55.39	45.04	74	54	-18.61	-8.96
4513.75	H	48.83	43.28	74	54	-25.17	-10.72

Test mode: ASK Frequency: Channel 25: 914.75MHz

Freq. (MHz)	Ant. Pol. H/V	Emission Level(dBuV/m)		Limit 3m(dBuV/m)		Over(dB)	
		PK	AV	PK	AV	PK	AV
1829.50	V	64.63	51.35	74	54	-9.37	-2.65
2744.25	V	59.14	49.01	74	54	-14.86	-4.99
3659.00	V	53.28	47.97	74	54	-20.72	-6.03
4573.75	V	48.97	42.54	74	54	-25.03	-11.46
1829.50	H	65.48	51.09	74	54	-8.52	-2.91
2744.25	H	59.59	50.79	74	54	-14.41	-3.21
3659.00	H	52.14	46.39	74	54	-21.86	-7.61
4573.75	H	49.45	43.21	74	54	-24.55	-10.79

Test mode: ASK Frequency: Channel 50: 927.25MHz

Freq. (MHz)	Ant. Pol. H/V	Emission Level(dBuV/m)		Limit 3m(dBuV/m)		Over(dB)	
		PK	AV	PK	AV	PK	AV
1854.50	V	66.18	52.88	74	54	-7.82	-1.12
2781.75	V	61.35	49.77	74	54	-12.65	-4.23
3709.00	V	53.16	45.2	74	54	-20.84	-8.80
4636.25	V	51.43	41.66	74	54	-22.57	-12.34
1854.50	H	66.27	51.9	74	54	-7.73	-2.10
2781.75	H	59.99	50.9	74	54	-14.01	-3.10
3709.00	H	54.94	46.5	74	54	-19.06	-7.50
4636.25	H	49.87	43.06	74	54	-24.13	-10.94

- Note:**
- (1) All Readings are Peak Value (VBW=3MHz) and Peak Value (VBW=10Hz).
 - (2) Emission Level= Reading Level+Probe Factor +Cable Loss.
 - (3) Data of measurement within this frequency range shown "--" in the table above means the reading of emissions are attenuated more than 20dB below the permissible limits or the field strength is too small to be measured.

■ Spurious Emission below 1GHz (30MHz to 1GHz)

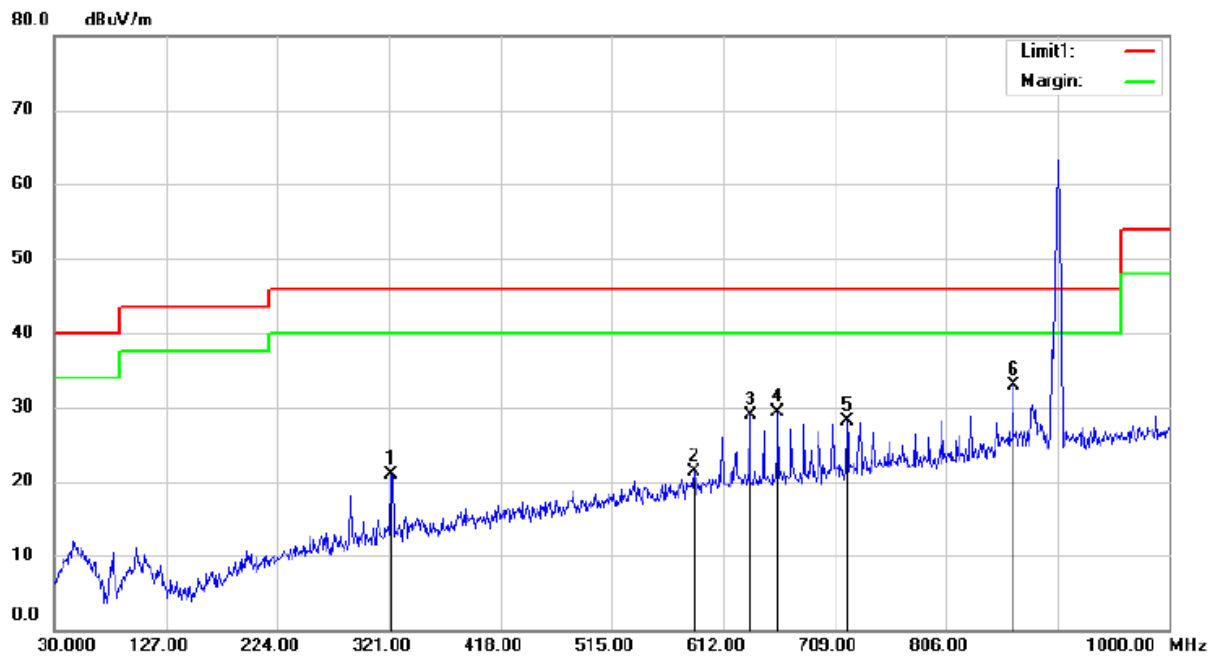

Site: 3m Chamber #1 Polarization: **Horizontal** Temperature: 24 C
 Limit: (RE)FCC PART 15C Power: AC 120V/60Hz Humidity: 53 %

M/N: XC2800
 Mode: TX902.75MHz
 Note:

No.	Mk.	Freq. MHz	Reading Level dBuV	Correct Factor dB	Measure- ment dBuV/m	Limit dBuV/m	Over dB	Detector	Antenna Height cm	Table Degree	Comment
1		322.9400	32.65	-11.81	20.84	46.00	-25.16	QP			
2		586.7800	26.76	-5.44	21.32	46.00	-24.68	QP			
3		635.2800	33.54	-4.72	28.82	46.00	-17.18	QP			
4		659.5300	33.79	-4.42	29.37	46.00	-16.63	QP			
5		719.6700	31.41	-3.39	28.02	46.00	-17.98	QP			
6	*	864.2000	33.91	-0.94	32.97	46.00	-13.03	QP			

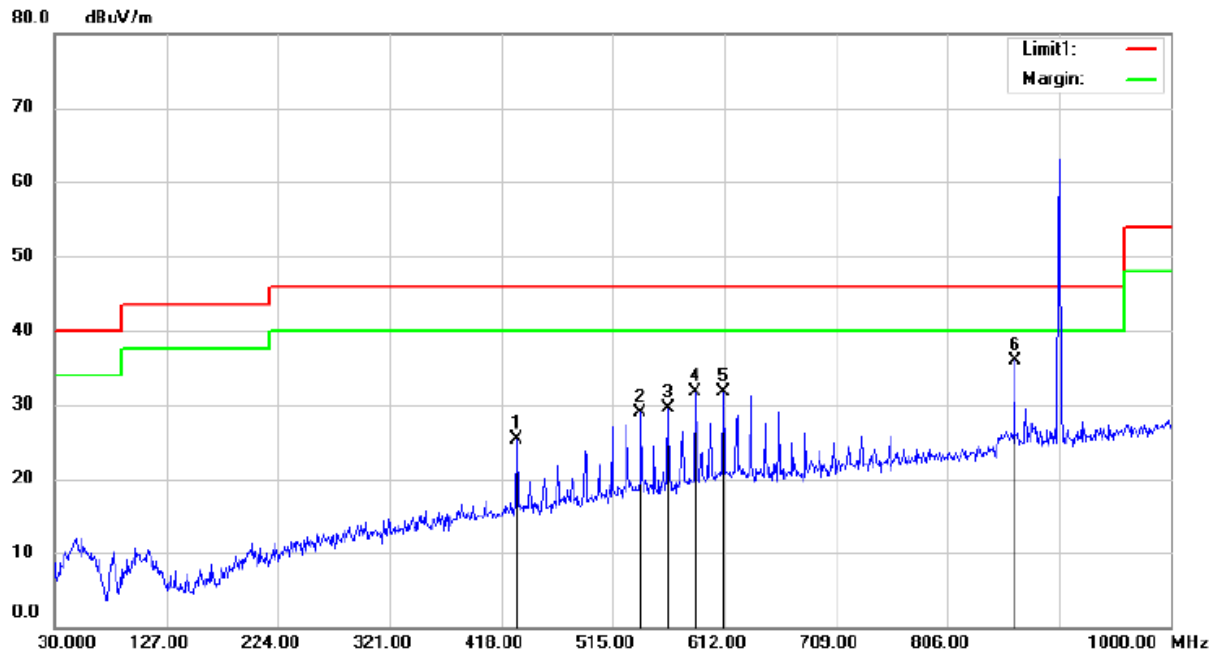

Site: 3m Chamber #1 Polarization: **Vertical** Temperature: 24 C
 Limit: (RE)FCC PART 15C Power: AC 120V/60Hz Humidity: 53 %

M/N: XC2600
 Mode: TX902.75MHz
 Note:

No.	Mk.	Freq. MHz	Reading Level dBuV	Correct Factor dB	Measure- ment dBuV/m	Limit dBuV/m	Over dB	Detector	Antenna Height cm	Table Degree	Comment
1		431.5800	34.18	-8.89	25.29	46.00	-20.71	QP			
2		539.2500	35.72	-6.80	28.92	46.00	-17.08	QP			
3		563.5000	35.79	-6.29	29.50	46.00	-16.50	QP			
4		586.7800	37.11	-5.44	31.67	46.00	-14.33	QP			
5		611.0300	36.45	-4.80	31.65	46.00	-14.35	QP			
6	*	864.2000	36.84	-0.94	35.90	46.00	-10.10	QP			

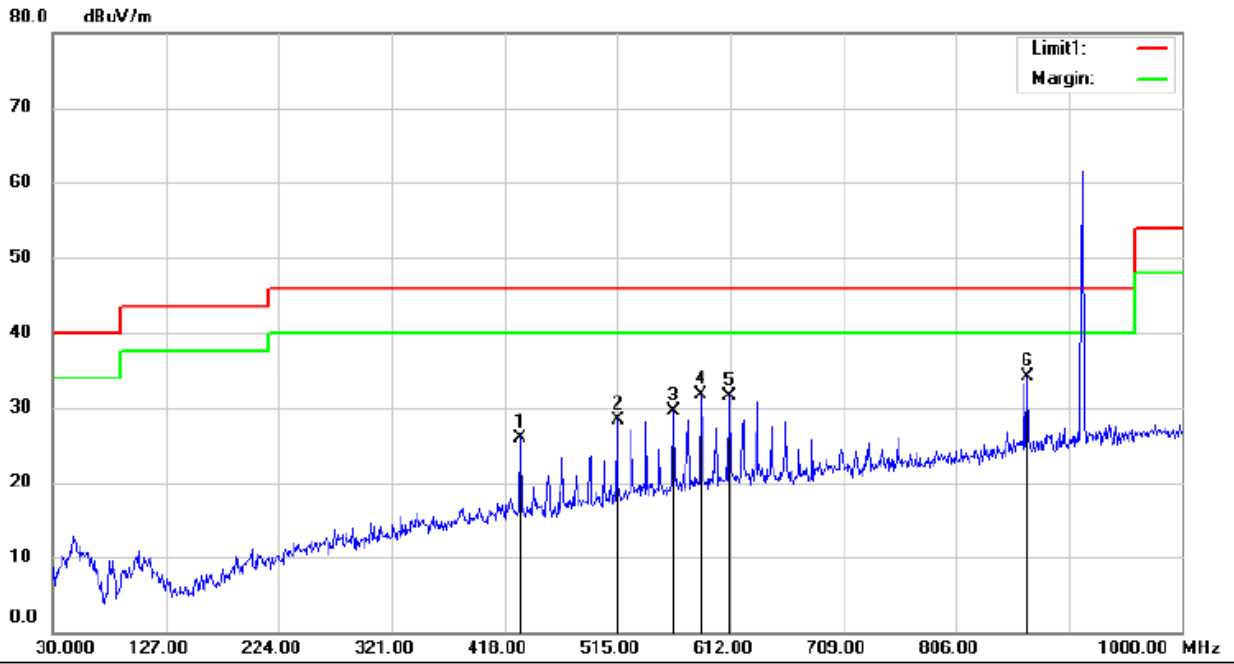

Site 3m Chamber #1 Polarization: **Vertical** Temperature: 24 C
 Limit: (RE)FCC PART 15C Power: AC 120V/60Hz Humidity: 53 %

M/N: XC2600
 Mode:TX914.75MHz
 Note:

No.	Mk.	Freq.	Reading Level	Correct Factor	Measurement	Limit	Over	Antenna Height	Table Degree	
		MHz	dBuV	dB	dBuV/m	dBuV/m	dB	cm	degree	Comment
1		431.5800	34.70	-8.89	25.81	46.00	-20.19	QP		
2		515.0000	35.63	-7.28	28.35	46.00	-17.65	QP		
3		563.5000	35.79	-6.29	29.50	46.00	-16.50	QP		
4		586.7800	37.22	-5.44	31.78	46.00	-14.22	QP		
5		611.0300	36.38	-4.80	31.58	46.00	-14.42	QP		
6	*	867.1100	34.92	-0.81	34.11	46.00	-11.89	QP		

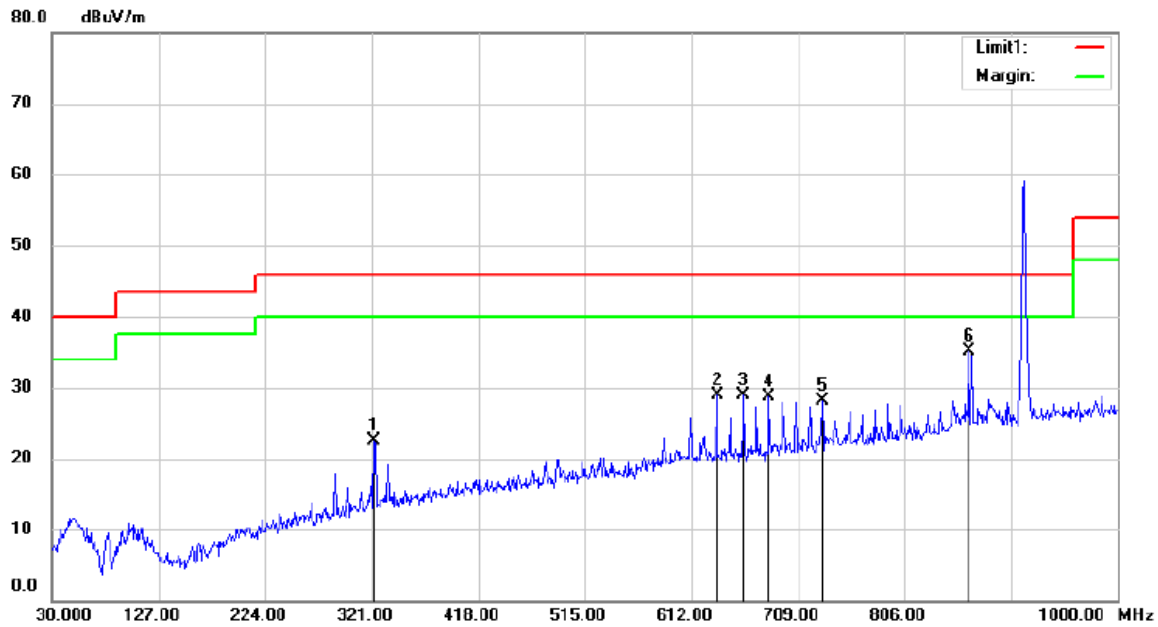

Site: 3m Chamber #1 Polarization: **Horizontal** Temperature: 24 C
 Limit: (RE)FCC PART 15C Power: AC 120V/60Hz Humidity: 53 %

M/N: XC2600
 Mode: TX914.75MHz
 Note:

No.	Mk.	Freq. MHz	Reading Level dBuV	Correct Factor dB	Measure- ment dBuV/m	Limit dBuV/m	Over dB	Detector	Antenna Height cm	Table Degree	Comment
1		322.9400	34.23	-11.81	22.42	46.00	-23.58	QP			
2		635.2800	33.63	-4.72	28.91	46.00	-17.09	QP			
3		659.5300	33.24	-4.42	28.82	46.00	-17.18	QP			
4		682.8100	32.68	-4.03	28.65	46.00	-17.35	QP			
5		731.3100	31.00	-2.98	28.02	46.00	-17.98	QP			
6	*	864.2000	36.02	-0.94	35.08	46.00	-10.92	QP			

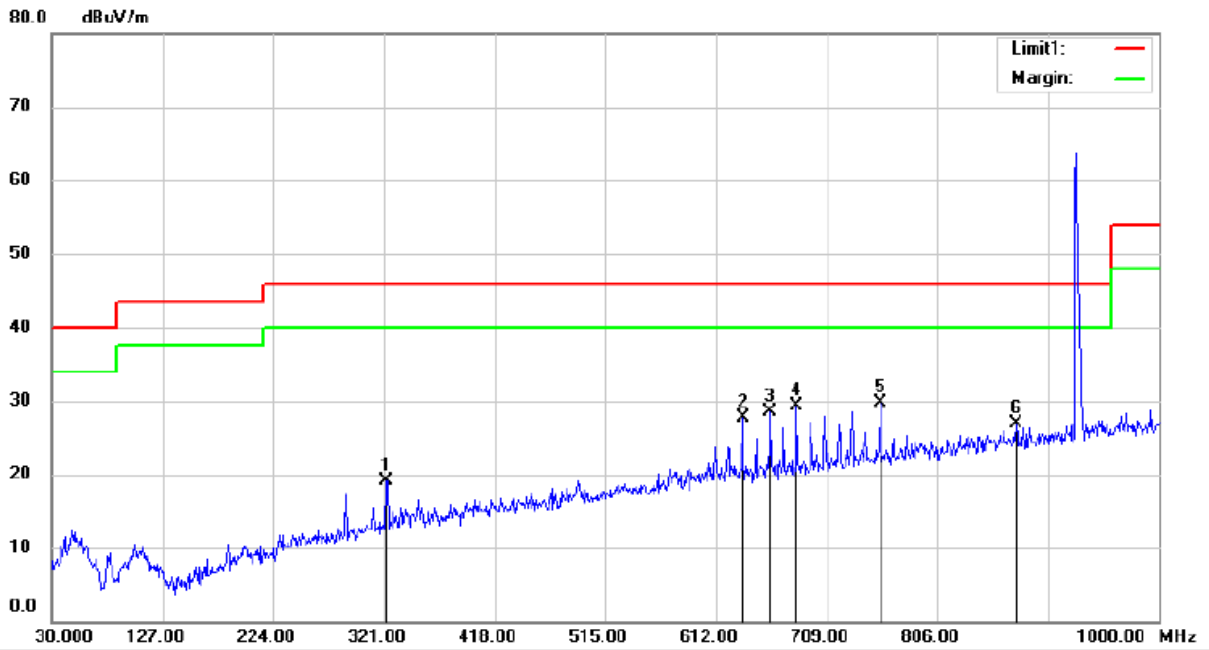

Site 3m Chamber 3# Polarization: **Horizontal** Temperature: 24 C
 Limit: (RE)FCC PART 15C Power: AC 120V/60Hz Humidity: 53 %

M/N: XC2600
 Mode:TX927.25MHz
 Note:

No.	Mk.	Freq. MHz	Reading Level dBuV	Correct Factor dB	Measure- ment dBuV/m	Limit dBuV/m	Over dB	Detector	Antenna Height cm	Table Degree degree	Comment
1		322.9400	30.91	-11.81	19.10	46.00	-26.90	QP			
2		635.2800	32.49	-4.72	27.77	46.00	-18.23	QP			
3		659.5300	32.96	-4.42	28.54	46.00	-17.46	QP			
4		682.8100	33.27	-4.03	29.24	46.00	-16.76	QP			
5	*	755.5600	32.26	-2.60	29.66	46.00	-16.34	QP			
6		874.8700	27.70	-0.76	26.94	46.00	-19.06	QP			

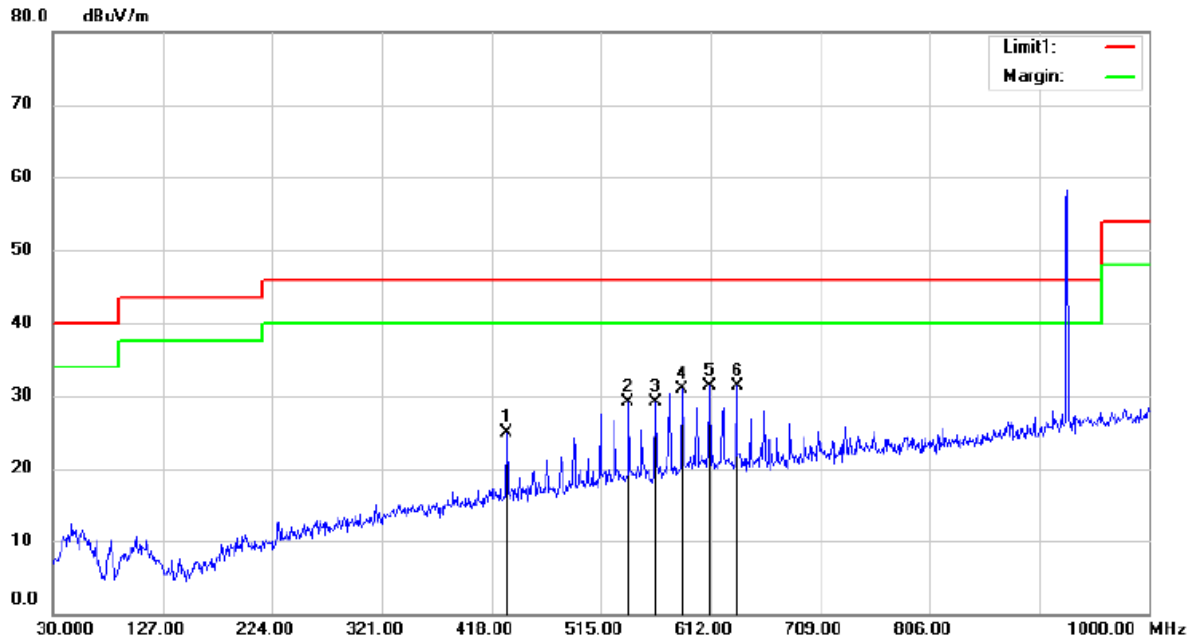

Site: 3m Chamber 3# Polarization: **Vertical** Temperature: 24 C
 Limit: (RE)FCC PART 15C Power: AC 120V/60Hz Humidity: 53 %

M/N: XC2600
 Mode: TX927.25MHz
 Note:

No.	Mk.	Freq. MHz	Reading Level dBuV	Correct Factor dB	Measure- ment dBuV/m	Limit dBuV/m	Over dB	Antenna Height cm	Table Degree	Detector	Comment
1		431.5800	33.71	-8.89	24.82	46.00	-21.18			QP	
2		539.2500	35.86	-6.80	29.06	46.00	-16.94			QP	
3		563.5000	35.36	-6.29	29.07	46.00	-16.93			QP	
4		586.7800	36.36	-5.44	30.92	46.00	-15.08			QP	
5		611.0300	36.05	-4.80	31.25	46.00	-14.75			QP	
6	*	635.2800	36.09	-4.72	31.37	46.00	-14.63			QP	

8.8 OUT OF BAND EMISSIONS

8.8.1 Applicable Standard

According to §15.247 (d)

8.8.2 Conformance Limit

In any 100 kHz bandwidth outside the frequency band in which the spread spectrum or digitally modulated intentional radiator is operating, the radio frequency power that is produced by the intentional radiator shall be at least 20 dB below that in the 100 kHz bandwidth within the band that contains the highest level of the desired power, based on either an RF conducted or a radiated measurement, provided the transmitter demonstrates compliance with the peak conducted power limits. If the transmitter complies with the conducted power limits based on the use of RMS averaging over a time interval, as permitted under paragraph (b)(3) of this section, the attenuation required under this paragraph shall be 30 dB instead of 20 dB. Attenuation below the general limits specified in §15.209(a) is not required. In addition, radiated emissions which fall in the restricted bands, as defined in §15.205(a), must also comply with the radiated emission limits specified in §15.209(a).

8.8.3 Test Configuration

Test according to clause 7.2 radio frequency test setup 2

8.8.4 Test Procedure

According to ANSI C63.10-2013 section 7.8.6, the Band-edge measurements for RF conducted emissions test method as follows.

- a) Connect the EMI receiver or spectrum analyzer to the EUT using an appropriate RF cable connected to the EUT output. Configure the spectrum analyzer settings as described in step e) (be sure to enter all losses between the unlicensed wireless device output and the spectrum analyzer).
- b) Set the EUT to the lowest frequency channel (for the hopping on test, the hopping sequence shall include the lowest frequency channel).
- c) Set the EUT to operate at maximum output power and 100% duty cycle, or equivalent “normal mode of operation” as specified in 6.10.3.
- d) If using the radiated method, then use the applicable procedure(s) of 6.4, 6.5, or 6.6, and orient the EUT and measurement antenna positions to produce the highest emission level.
- e) Perform the test as follows:
 - 1) Span: Wide enough to capture the peak level of the emission operating on the channel closest to the band edge, as well as any modulation products that fall outside of the authorized band of operation.
 - 2) Reference level: As required to keep the signal from exceeding the maximum instrument input mixer level for linear operation. In general, the peak of the spectral envelope shall be more than [10 log (OBW/RBW)] below the reference level. Specific guidance is given in 4.1.5.2.
 - 3) Attenuation: Auto (at least 10 dB preferred).
 - 4) Sweep time: Coupled.
 - 5) Resolution bandwidth: 100 kHz.
 - 6) Video bandwidth: 300 kHz.
 - 7) Detector: Peak.
 - 8) Trace: Max hold.
- f) Allow the trace to stabilize. For the test with the hopping function turned ON, this can take several minutes to achieve a reasonable probability of intercepting any emissions due to oscillator overshoot.
- g) Set the marker on the emission at the band edge, or on the highest modulation product outside of the band, if this level is greater than that at the band edge. Enable the marker-delta function, and then use the marker-to-peak function to move the marker to the peak of the in-band emission.
- h) Repeat step c) through step e) for every applicable modulation.
- i) Set the EUT to the highest frequency channel (for the hopping on test, the hopping sequence shall include the highest frequency channel) and repeat step c) through step d).
- j) The band-edge measurement shall be reported by providing plot(s) of the measuring instrument display;

the plot axes and the scale units per division shall be clearly labeled. Tabular data may be reported in addition to the plot(s).

Restricted-band band-edge test method please refers to ANSI C63.10-2013 section 6.10.5. The emission must comply with the 15.209 limit for fall in the restricted bands listed in section 15.205. Note that the method of measurement KDB publication number: 913591 may be used for the radiated band-edge measurements.

According to ANSI C63.10-2013 section 7.8.8, Conducted spurious emissions shall be measured for the transmit frequency, per 5.5 and 5.6, and at the maximum transmit powers.

Connect the primary antenna port through an attenuator to the spectrum analyzer input; in the results, account for all losses between the unlicensed wireless device output and the spectrum analyzer. The instrument shall span 30 MHz to 10 times the operating frequency in GHz, with a resolution bandwidth of 100 kHz, video bandwidth of 300 kHz, and a coupled sweep time with a peak detector. The band 30 MHz to the highest frequency may be split into smaller spans, as long as the entire spectrum is covered.

8.8.5 Test Results

Temperature:	26° C
Relative Humidity:	54%
ATM Pressure:	1011 mbar

Lowest Bandedge

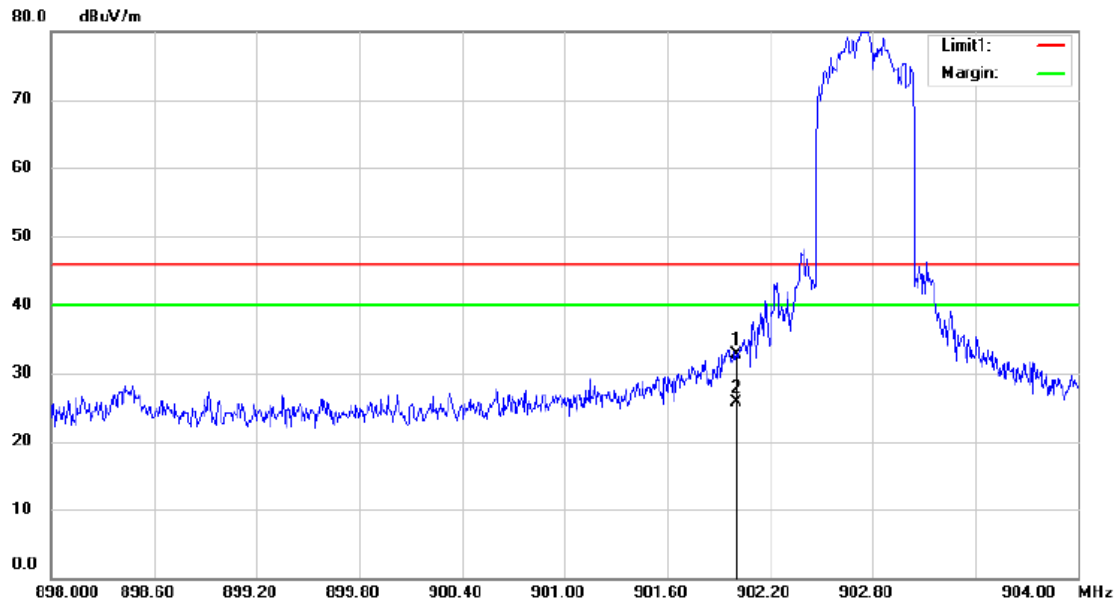

Site: 3m Chamber #1 Polarization: *Horizontal* Temperature: 24 C
 Limit: (RE)FCC PART 15C Power: AC 120V/60Hz Humidity: 53 %

M/N: XC2600
 Mode: 902.75MHz
 Note:

No.	Mk.	Freq.	Reading Level	Correct Factor	Measurement	Limit	Over	Antenna Height	Table Degree	
		MHz	dBuV	dB	dBuV/m	dBuV/m	dB	cm	degree	Comment
1	*	902.0000	33.00	-0.28	32.72	46.00	-13.28			peak
2		902.0000	25.96	-0.28	25.68	46.00	-20.32			AVG

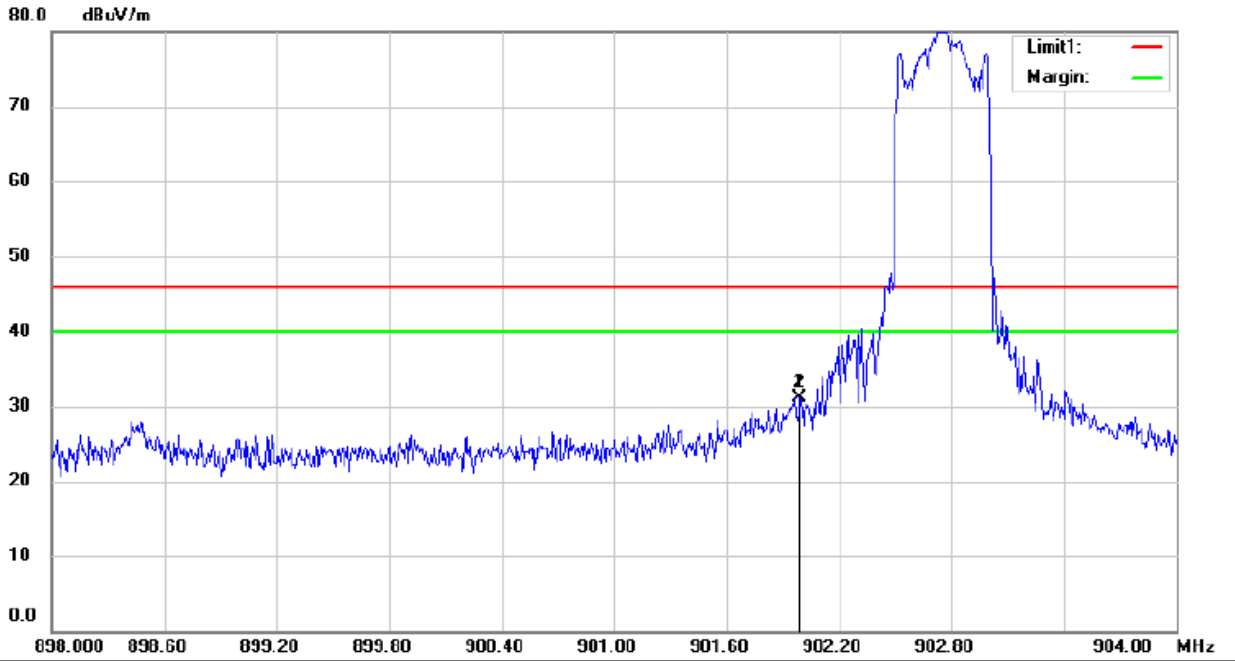

Site: 3m Chamber #1

Polarization: **Vertical**

Temperature: 24 C

Limit: (RE)FCC PART 15C

Power: AC 120V/60Hz

Humidity: 53 %

M/N: XC2600

Mode: 902.75MHz

Note:

No.	Mk.	Freq.	Reading Level	Correct Factor	Measurement	Limit	Over	Antenna Height	Table Degree	
		MHz	dBuV	dB	dBuV/m	dBuV/m	dB	cm	degree	Comment
1	*	901.9900	31.45	-0.28	31.17	46.00	-14.83	peak		
2	*	901.9900	31.45	-0.28	31.17	46.00	-14.83	peak		

Highest Bandedge

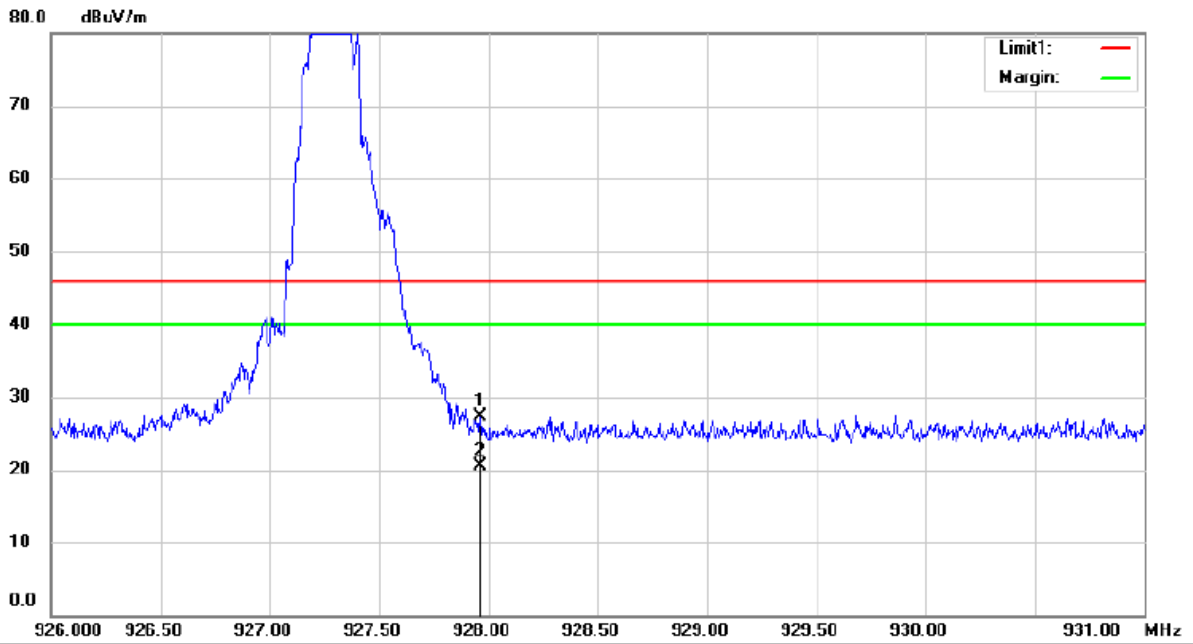

Site 3m Chamber #1 Polarization: *Horizontal* Temperature: 24 C
 Limit: (RE)FCC PART 15C Power: AC 120V/60Hz Humidity: 53 %

M/N: XC2600
 Mode: 927.25MHz
 Note:

No.	Mk.	Freq.	Reading Level	Correct Factor	Measurement	Limit	Over	Antenna Height	Table Degree	
		MHz	dBuV	dB	dBuV/m	dBuV/m	dB	cm	degree	Comment
1	*	927.9600	26.98	0.23	27.21	46.00	-18.79	peak		
2		927.9600	20.25	0.23	20.48	46.00	-25.52	AVG		

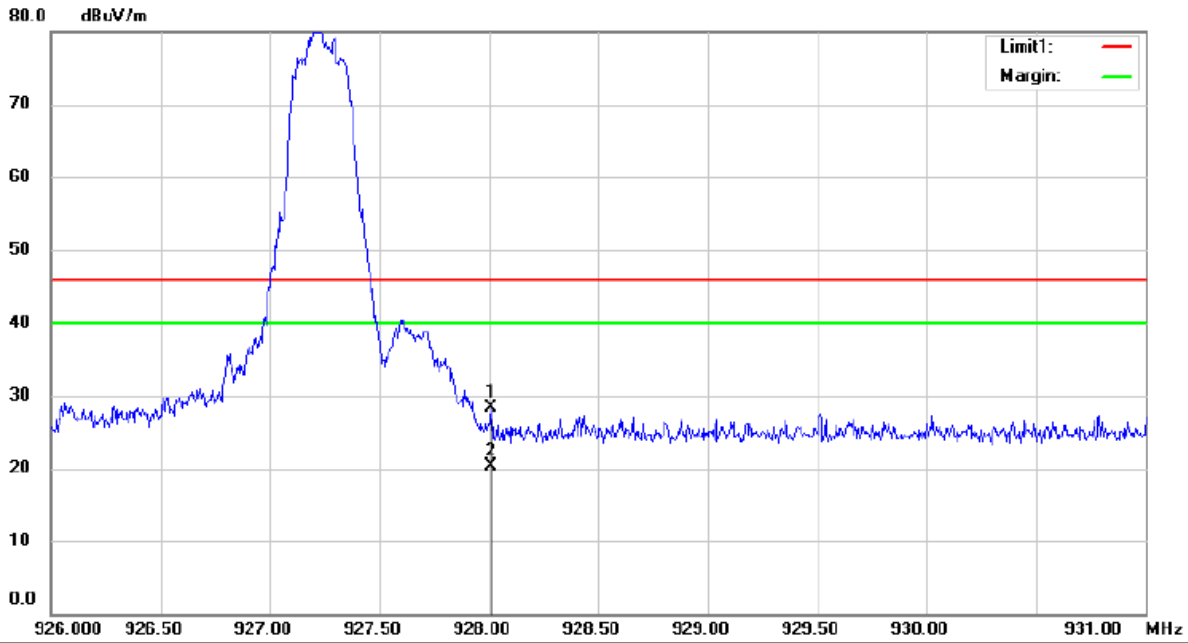

Site: 3m Chamber #1 Polarization: **Vertical** Temperature: 24 C
 Limit: (RE)FCC PART 15C Power: AC 120V/60Hz Humidity: 53 %

M/N: XC2800
 Mode: 927.25MHz
 Note:

No.	Mk.	Freq. MHz	Reading Level dBuV	Correct Factor dB	Measure- ment dBuV/m	Limit dBuV/m	Over dB	Detector	Antenna Height cm	Table Degree degree	Comment
1	*	928.0100	28.14	0.23	28.37	46.00	-17.63	peak			
2		928.0100	20.12	0.23	20.35	46.00	-25.65	AVG			

8.9 CONDUCTED EMISSION TEST

8.9.1 Applicable Standard

According to FCC Part 15.207(a)

8.9.2 Conformance Limit

Conducted Emission Limit		
Frequency(MHz)	Quasi-peak	Average
0.15-0.5	66-56	56-46
0.5-5.0	56	46
5.0-30.0	60	50

Note: 1. The lower limit shall apply at the transition frequencies
 2. The limit decreases in line with the logarithm of the frequency in the range of 0.15 to 0.50MHz.

8.9.3 Test Configuration

Test according to clause 7.3 conducted emission test setup

8.9.4 Test Procedure

The EUT was placed on a table which is 0.1m above ground plane.
 Maximum procedure was performed on the highest emissions to ensure EUT compliance.
 Repeat above procedures until all frequency measured were complete.

8.9.5 Test Results

Pass

The 120V &240V voltage have been tested, and the worst result recorded was report as below:

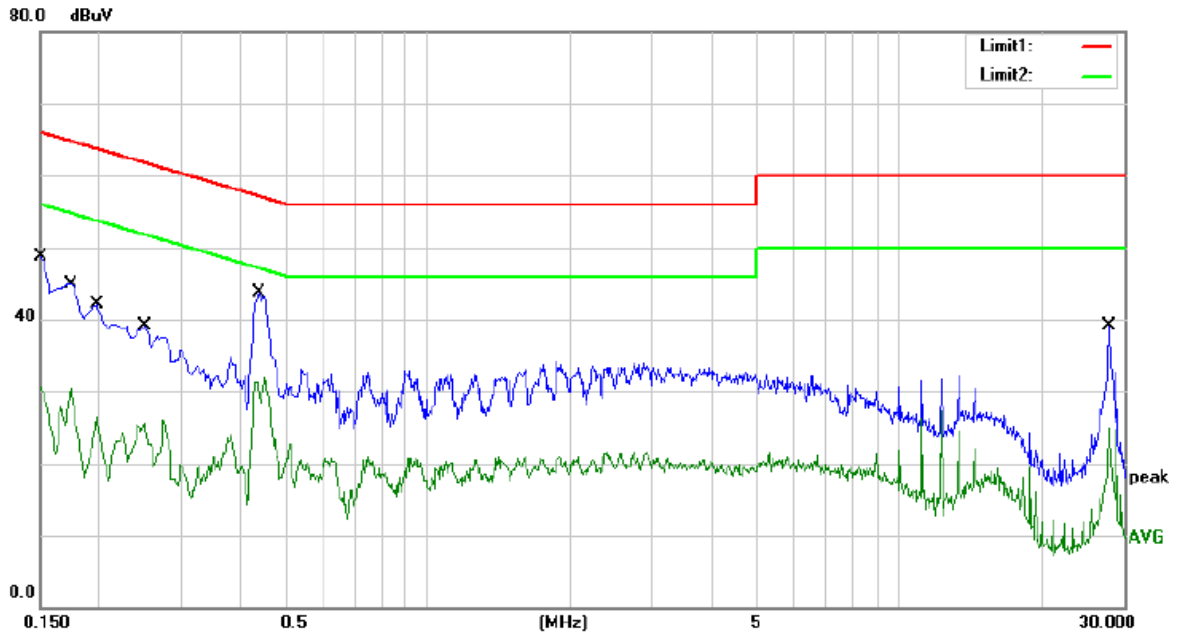

Site Conduction #2

Phase: **L1**

Temperature: 24.9

Limit: (CE)FCC PART 15 class B_QP

Power: AC 120V/60Hz

Humidity: 54 %

M/N: XC2600

Mode: ON

Note:

No.	Mk.	Freq.	Reading Level	Correct Factor	Measurement	Limit	Over	Detector	Comment
		MHz	dBuV	dB	dBuV	dBuV	dB		
1		0.1500	38.83	9.89	48.72	66.00	-17.28	QP	
2		0.1500	20.71	9.89	30.60	56.00	-25.40	AVG	
3		0.1740	35.11	9.89	45.00	64.77	-19.77	QP	
4		0.1740	20.69	9.89	30.58	54.77	-24.19	AVG	
5		0.1980	32.28	9.89	42.15	63.69	-21.54	QP	
6		0.1980	16.63	9.89	26.52	53.69	-27.17	AVG	
7		0.2500	29.23	9.90	39.13	61.76	-22.63	QP	
8		0.2500	15.60	9.90	25.50	51.76	-26.26	AVG	
9	*	0.4380	33.87	9.91	43.78	57.10	-13.32	QP	
10		0.4380	21.99	9.91	31.90	47.10	-15.20	AVG	
11		27.8860	28.73	10.28	39.01	60.00	-20.99	QP	
12		27.8860	14.58	10.28	24.86	50.00	-25.14	AVG	

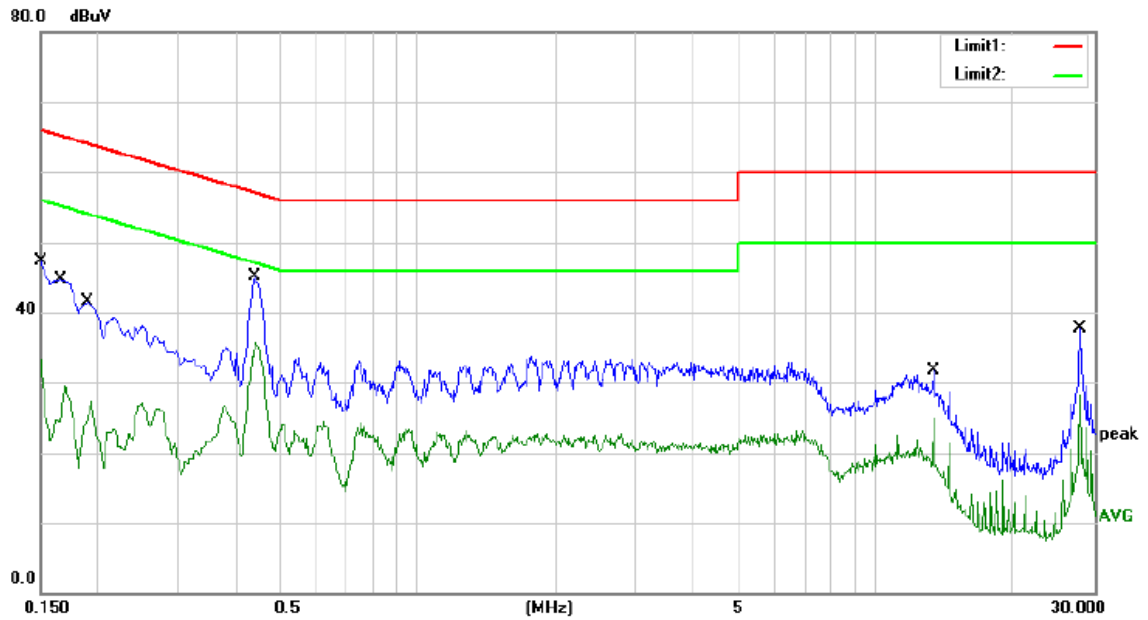

Site Conduction #2 Phase: **N** Temperature: 24.9
 Limit: (CE)FCC PART 15 class B_QP Power: AC 120V/60Hz Humidity: 54 %

M/N: XC2800
 Mode: ON
 Note:

No.	Mk.	Freq.	Reading Level	Correct Factor	Measurement	Limit	Over	Detector	Comment
		MHz	dBuV	dB	dBuV	dBuV	dB		
1		0.1500	37.50	9.89	47.39	66.00	-18.61	QP	
2		0.1500	23.33	9.89	33.22	56.00	-22.78	AVG	
3		0.1660	34.71	9.89	44.60	65.16	-20.56	QP	
4		0.1660	19.53	9.89	29.42	55.16	-25.74	AVG	
5		0.1900	31.63	9.89	41.52	64.04	-22.52	QP	
6		0.1900	17.45	9.89	27.34	54.04	-26.70	AVG	
7		0.4420	35.10	9.91	45.01	57.02	-12.01	QP	
8	*	0.4420	25.74	9.91	35.65	47.02	-11.37	AVG	
9		13.3860	21.50	10.10	31.60	60.00	-28.40	QP	
10		13.3860	14.88	10.10	24.98	50.00	-25.02	AVG	
11		27.8860	27.37	10.28	37.65	60.00	-22.35	QP	
12		27.8860	18.10	10.28	28.38	50.00	-21.62	AVG	

8.10 ANTENNA APPLICATION

8.10.1 Antenna Requirement

Standard	Requirement
FCC CRF Part 15.203	An intentional radiator shall be designed to ensure that no antenna other than that furnished by the responsible party shall be used with the device. The use of a permanently attached antenna or of an antenna that uses a unique coupling to the intentional radiator shall be considered sufficient to comply with the provisions of this section. The manufacturer may design the unit so that a broken antenna can be replaced by the user, but the use of a standard antenna jack or electrical connector is prohibited. This requirement does not apply to carrier current devices or to devices operated under the provisions of §15.211, §15.213, §15.217, §15.219, or §15.221. Further, this requirement does not apply to intentional radiators that must be professionally installed, such as perimeter protection systems and some field disturbance sensors, or to other intentional radiators which, in accordance with §15.31(d), must be measured at the installation site. However, the installer shall be responsible for ensuring that the proper antenna is employed so that the limits in this part are not exceeded.

For intentional device, according to FCC 47 CFR Section 15.203, an intentional radiator shall be designed to ensure that no antenna other than that furnished by the responsible party shall be used with the device. And according to FCC 47 CFR Section 15.247 (b), if transmitting antennas of directional gain greater than 6dBi are used, the power shall be reduced by the amount in dB that the directional gain of the antenna exceeds 6dBi.

8.10.2 Result

PASS.

The EUT has 1 antenna: a Internal Antenna, the gain is 3.0 dBi;

- Note:
- Antenna use a permanently attached antenna which is not replaceable.
 - Not using a standard antenna jack or electrical connector for antenna replacement
 - The antenna has to be professionally installed (please provide method of installation)

which in accordance to section 15.203, please refer to the internal photos.

Detail of factor for radiated emission

Frequency(MHz)	Ant_F(dB)	Cab_L(dB)	Preamp(dB)	Correct Factor(dB)
0.009	20.6	0.03	\	20.63
0.15	20.7	0.1	\	20.8
1	20.9	0.15	\	21.05
10	20.1	0.28	\	20.38
30	18.8	0.45	\	19.25
30	11.7	0.62	27.9	-15.58
100	12.5	1.02	27.8	-14.28
300	12.9	1.91	27.5	-12.69
600	19.2	2.92	27	-4.88
800	21.1	3.54	26.6	-1.96
1000	22.3	4.17	26.2	0.27
1000	25.6	1.76	41.4	-14.04
3000	28.9	3.27	43.2	-11.03
5000	31.1	4.2	44.6	-9.3
8000	36.2	5.95	44.7	-2.55
10000	38.4	6.3	43.9	0.8
12000	38.5	7.14	42.3	3.34
15000	40.2	8.15	41.4	6.95
18000	45.4	9.02	41.3	13.12
18000	37.9	1.81	47.9	-8.19
21000	37.9	1.95	48.7	-8.85
25000	39.3	2.01	42.8	-1.49
28000	39.6	2.16	46.0	-4.24
31000	41.2	2.24	44.5	-1.06
34000	41.5	2.29	46.6	-2.81
37000	43.8	2.30	46.4	-0.3
40000	43.2	2.50	42.2	3.5